

**International
Progress Report**

IPR-05-13

Äspö Hard Rock Laboratory

Prototype Repository

**Sensors data report
(Period 010917-041201)
Report No:12**

Compiled by

Reza Goudarzi

Lars-Erik Johannesson

Clay Technology AB

December 2004

Svensk Kärnbränslehantering AB

Swedish Nuclear Fuel
and Waste Management Co
Box 5864

SE-102 40 Stockholm Sweden

Tel 08-459 84 00

+46 8 459 84 00

Fax 08-661 57 19

+46 8 661 57 19



**Äspö Hard Rock
Laboratory**

Report no.	No.
IPR-05-13	F63K
Author	Date
Reza Goudarzi	Dec. 2004
Lars-Erik Johannesson	
Checked by	Date
Lars-Erik Johannesson	2005-03-31
Approved	Date
Anders Sjöland	2005-04-14

Äspö Hard Rock Laboratory

Prototype Repository

Sensors data report (Period 010917-041201) Report No:12

Compiled by

Reza Goudarzi
Lars-Erik Johannesson

Clay Technology AB

December 2004

Keywords: Fields test, Data, Prototype, Bentonite, Rock, Canister measurements, Water, Pressure, Total pressure, Relative humidity, Temperature, Displacements, Geoelectric

This report concerns a study which was conducted for SKB. The conclusions and viewpoints presented in the report are those of the author(s) and do not necessarily coincide with those of the client.

Abstract

The Prototype Repository Test consists of two sections. The installation of the first Section of Prototype Repository was made during summer and autumn 2001 and Section 2 was installed in spring and summer 2003.

This report presents data from measurements in the Prototype Repository during the period 010917-041201. The report is organized so that the actual measured results are shown in Appendix 1-10, where Appendix 8 deals with measurements of canister displacements (by AITEMIN), Appendix 9 deals with geo-electric measurements in the backfill (by GRS), Appendix 10 deals with stress and strain measurement in the rock (by BBK) and Appendix 11 deals with measurement of water pressure in the rock (by VBB/VIAK). The main report and Appendix 1-7 deal with the rest of the measurements.

Section 1

The following measurements are made in the bentonite in each of the two instrumented deposition holes in Section 1 (1 and 3): Temperature is measured in 32 points, total pressure in 27 points, pore water pressure in 14 points and relative humidity in 37 points. Temperature is also measured by all relative humidity gauges. Every measuring point is related to a local coordinate system in the deposition hole.

The following measurements are made in the backfill in Section 1. Temperature is measured in 20 points, total pressure in 18 points, pore water pressure in 23 points and relative humidity in 45 points. Temperature is also measured by all relative humidity gauges. Furthermore, water content is measured by an electric chain in one section. Every measuring point is related to a local coordinate system in the tunnel.

The following measurements are made on the surface of the canisters in Section 1: Temperature is measured every meter along two fiber optic cables. Furthermore, displacements of the canister in hole 3 are measured with 6 gauges.

The following measurements are made in the rock in Section 1: Temperature is measured in 37 points in boreholes in the floor. Water pressure is measured in altogether 64 points in 17 boreholes all around the tunnel.

Section 2

The following measurements are made in the bentonite in each of the two instrumented deposition holes in Section 2 (5 and 6): Temperature is measured in 29 points, total pressure in 27 points, pore water pressure in 14 points and relative humidity in 47 points deposition hole 5 and in 65 points in deposition hole 6. Temperature is also measured by all relative humidity gauges.

The following measurements are made in the backfill in Section 2. Temperature is measured in 16 points, total pressure in 16 points, pore water pressure in 18 points and relative humidity in 32 points. Temperature is also measured by all relative humidity gauges. Furthermore, water content is measured by an electric chain in one section. Every measuring point is related to a local coordinate system in the tunnel.

The following measurements are made on the surface of the canisters in Section 2: Temperature is measured every meter along two fiber optic cables. Additional to this temperature measurement three conventional thermocouples are placed on each canister. Furthermore, displacements of the canister in hole 6 are measured with 6 gauges.

The following measurements are made in the rock in Section 2: Temperature is measured in 24 points in boreholes close to the deposition holes. Relative humidity is also measured in 6 points in the rock close to deposition hole 6.

Conclusions

A general conclusion is that the measuring systems and transducers work well, but the number of sensors that has failed is increasing. 153 out of 363 sensors in Section 1 (excluding water pressure sensors in the rock, geo-electric measurements) are out of order, the majority (64) being RH-sensors that fail at water saturation. 62 out of 394 sensors in Section 2 (excluding water pressure sensors in the rock, geo-electric measurements, stress and strain in the rock and displacement of canister) are out of order, some of them due to problems with the data collection system. Furthermore are some suction sensors (20) placed in the backfill not giving reliable values due to high degree of saturation (RH 100%). A new calibration of the fiber optic cables for temperature measurement on the surface of the canisters has been made but it is still preliminary, which means that adjustments of the results may be done afterwards.

The drainages of the inner section together with the drainage of the outer plug were closed at the beginning of November. The pressure (pore pressure and total pressure) both in the backfill and in some parts of the buffer in the six deposition hole increased after this date. This process accelerated at the end of this measuring period. The increase in pore pressure affected also the saturation rate of the backfill. Following maximum temperatures have been measured on the 6 canisters; No 1 ca 75°C, No 2 ca 91°C, No 3 ca 97°C, No 4 ca 88°C, No 5 ca 84°C and No 6 ca 88°C.

Sammanfattning

Prototypförvaret består av två sektioner. Den första sektionen installerades under sommaren och hösten 2001 och Sektion 2 installerades under våren och sommaren 2003.

I denna rapport presenteras data från mätningar i Prototypförvaret för perioden 010917-041201. Rapporten är uppdelad så att själva mätresultaten redovisas i Appendix 1-10, varvid Appendix 8 behandlar mätning av kapselförskjutningar (görs av AITEMIN), Appendix 9 behandlar geoelektriska mätningar i återfyllningen (görs av GRS), Appendix 10 behandlar mätningar av spänning och töjning i berget (handhas av BBK) och Appendix 11 behandlar vattentrycksmätningar i berget (handhas av VBB/VIK). I själva huvudrapporten och Appendix 1-7 behandlas alla övriga mätningar.

Sektion 1

Följande mätningar görs i bentoniten i vardera av de två instrumenterade deponeringshålen i Sektion 1 (1 och 3): Temperatur mäts i 32 punkter, totaltryck i 27 punkter, porvattentryck i 14 punkter och relativa fuktigheten i 37 punkter. Temperaturen mäts även med relativa fuktighetsmätare. Varje mätpunkt relateras till ett lokalt koordinatsystem i deponeringshålet.

Följande mätningar görs i återfyllningen i Sektion 1: Temperaturen mäts i 20 punkter, totaltryck i 18 punkter, porvattentryck i 23 punkter och relativa fuktigheten i 45 punkter. Temperaturen mäts även med alla relativa fuktighetsmätare. Varje mätpunkt relateras till ett lokalt koordinatsystem i tunneln. Dessutom mäts vatteninnehållet i en sektion med en geoelektrisk mätkedja.

Följande mätningar görs på ytan i kapselns kopparhölje i samtliga 4 kapslar i Sektion 1: Temperaturen mäts varje meter längs två fiberoptiska kablar från två håll. Dessutom mäts förskjutningar av kapseln i hål 3 med 6 givare.

Följande mätningar görs i berget i Sektion 1: Temperatur mäts i borrhål i 37 punkter i golvet. Vattentryck mäts i sammanlagt 64 punkter i 17 borrhål runt hela tunneln.

Sektion 2

Följande mätningar görs i bentoniten i vardera av de två instrumenterade deponeringshålen i Sektion 2 (5 och 6): Temperatur mäts i 29 punkter, totaltryck i 27 punkter, porvattentryck i 14 punkter och relativa fuktigheten i 47 punkter i deponeringshål 5 och 65 punkter i deponeringshål 6. Temperaturen mäts även i alla relativa fuktighetsmätare.

Följande mätningar görs i återfyllningen i Sektion 2: Temperaturen mäts i 16 punkter, totaltryck i 16 punkter, porvattentryck i 18 punkter och relativa fuktigheten i 32 punkter. Temperaturen mäts även med alla relativa fuktighetsmätare. Varje mätpunkt relateras till ett lokalt koordinatsystem i tunneln. Dessutom mäts vatteninnehållet i en sektion med en geoelektrisk mätkedja.

Följande mätningar görs på ytan i kapselns kopparhölje i de två kapslarna i Sektion 2: Temperaturen mäts varje meter längs två fiberoptiska kablar från två håll. Vidare mäts temperaturen i tre punkter på varje kapsel med konventionella termoelement. Även förskjutningen av kapseln i deponeringshål 6 mäts med 6 givare.

Temperatur mäts i berget kring varje kapsel i 24 punkter. Vidare mäts RH i berget kring deponeringshål 6 i 6 punkter.

Slutsatser

En generell slutsats är att mätsystemen och givarna tycks fungera bra .153 av 363 givare i Sektion 1 (med undantag av vattentrycksmätare i berget) fungerar inte. Merparten av dessa (64 stycken) är RH-mätare som slutar fungera vid vattenmättnad. 62 av 394 givare i Sektion 2 (med undantag av vattentrycksmätare i berget) fungerar inte, en del av dessa p.g.a. datascan problem. Dessutom har en del psychrometrar (21) placerade i återfyllningen slutat att ge relevanta värden på grund av att fyllningen närmar sig vattenmättnad. Kalibrering av de fiberoptiska kablarna för temperaturmätning på kapselytorna har gjorts men den är fortfarande preliminär varför nya efterjustering av resultaten kan bli aktuell.

Dräneringen av den inre sektionen och den yttre pluggen stängdes i början av november. Portrycket och totaltrycket både i återfyllnaden och i bufferten ökade markant efter stängningen av dränaget. Ökningen av portrycket påverkade också vattenmättnaden i vissa delar av buffert och återfyllnade. Maximal temperaturen hos kapslarna skiljer sig avsevärt åt. Följande maximala temperaturer har uppmätts på de sex kapslarna; Nr 1 ca 75°C, Nr 2 ca 91°C, Nr 3 ca 97°C, Nr 4 ca 88°C, Nr 5 ca 84°C och Nr 6 ca 88°C.

Contents

1	Introduction	11
2	Geometry and coordinate systems	13
3	Brief description of the instruments	15
	Measurements of temperature	15
	Measurement of total pressure in the buffer and backfill	15
	Measurement of pore water pressure in the buffer and backfill	15
	Measurement of the water saturation process in the buffer and backfill	15
4	Location of instruments in Section 1	17
4.1	Strategy for describing the position of each device in the bentonite and rock in and around the deposition holes	17
4.2	Position of each instrument in the bentonite in hole 1 (DA3587G01)	19
4.3	Position of each instrument in the bentonite in hole 3 (DA3575G01)	23
4.4	Instruments on the canister surface in holes 1-4	27
4.5	Position of temperature sensors in the rock	29
4.6	Strategy for describing the position of each device in the backfill in section 1	31
4.7	Position of each instrument in the backfill	33
5	Results and comments for Section 1	37
5.1	General	37
5.2	Deposition hole 1	38
5.2.1	Total pressure	38
	Geokon (App. 1\pages 75-77)	38
	Kulite (App. 1\page 78)	38
5.2.2	Relative humidity	38
	Vaisala (App. 1\pages 79-82)	38
	Rotronic (App. 1\pages 83-87)	39
5.2.3	Pore water pressure	39
	Geokon (App. 1\page 88)	39
	Kulite (App. 1\page 89)	39
5.2.4	Temperature in the buffer (App. 1\pages 90-94)	39
5.2.5	Canister power in dep. hole 1 (App. 1\page 98)	39
5.2.6	Temperature on the canister surface (App. 1\pages 99-100)	40
5.3	Deposition hole 3	40
5.3.1	Total pressure	40
	Geokon (App. 2\pages 103-105)	40
	Kulite (App. 2\pages 106-107)	40
5.3.2	Relative humidity	40
	Vaisala (App. 2\pages 108-111)	40
	Rotronic (App. 2\pages 112-116)	41
5.3.3	Pore water pressure.	41
	Geokon (App. 2\page 117)	41
	Kulite (App. 2\page 118)	41
5.3.4	Temperature in the buffer (App. 2\pages 119-123 and 126)	41
5.3.5	Canister power (App. 2\page 127)	41
5.3.6	Temperature on the canister surface (App. 2\pages 128-129)	41

5.4	Deposition hole 2	42
5.4.1	Canister power (App. 3\page 134)	42
5.4.2	Temperature on the canister surface (App. 3\pages 135-137)	42
5.5	Deposition hole 4	42
5.5.1	Canister power (App. 3\page 139)	42
5.5.2	Temperature on the canister surface (App. 3\pages 140-141)	42
5.6	Backfill in Section1	43
5.6.1	Total pressure in the backfill	43
	Geokon (App. 4\pages 145-146)	43
	Kulite (App.4 \pages 147-148)	43
5.6.2	Suction in the backfill (App. 4\pages 149-155)	43
5.6.3	Pore water pressure in the backfill	43
	Geokon (App. 4\pages 156-157)	43
	Kulite (App. 4\pages 158-159)	43
5.6.4	Temperature in the backfill (App. 4\pages 160-164)	43
5.7	Temperature in the rock	44
5.7.1	Near hole 1 (App. 1\pages 95-97)	44
5.7.2	Near hole 2 (App. 3\page 133)	44
5.7.3	Near hole 3 (App. 2\pages 124-125)	44
5.7.4	Near hole 4 (App. 3\page 138)	44
6	Location of instruments in Section 2	45
6.1	Strategy for describing the position of each device in the bentonite and rock in and around the deposition holes	45
6.2	Position of each instrument in the bentonite in hole 5 (DA3551G01)	47
6.3	Position of each instrument in the bentonite in hole 6 (DA3545G01)	52
6.4	Instruments on the canister surface in holes 5-6	57
6.5	Position of temperature sensors in the rock	57
6.6	Strategy for describing the position of each device in the backfill in section 2	59
6.7	Position of each instrument in the backfill in Section 2	59
7	Results and comments for Section 2	63
7.1	General	63
7.2	Deposition hole 5	63
7.2.1	Total pressure	63
	Geokon (App. 5\pages 167-170)	63
	Kulite (App. 5\page 171)	64
7.2.2	Relative humidity/suction in dep. hole 5.	64
	Vaisala (App. 5\pages 172-175)	64
	Rotronic (App. 5\pages 176-180)	64
	Wescore Psychrometers (App.5\page 181)	64
7.2.3	Pore water pressure	65
	Geokon (App. 5\page 182)	65
	Kulite (App. 5\page 183)	65
7.2.4	Temperature in the buffer (App. 5\pages 184-193)	65
7.2.5	Canister power (App. 5\page 197)	65
7.2.6	Temperature on the canister surface (App. 5\pages 198-200)	65

7.3	Deposition hole 6	66
7.3.1	Total pressure	66
	Geokon and Kulite (App. 6\pages 203-206)	66
7.3.2	Relative humidity/Suction	66
	Vaisala and Rotronic (App. 6\pages 207-213)	66
	Wescore Psychrometers (App. 6\page 214-215)	66
7.3.3	Pore water pressure	66
	Geokon and Kulite (App. 6\pages 216-218)	66
7.3.4	Temperature in the buffer (App. 6\pages 219-227)	67
7.3.5	Canister power (App. 6\page 231)	67
7.3.6	Temperature on the canister surface (App. 6\pages 232-234)	67
7.4	Backfill in Section 2	68
7.4.1	Total pressure	68
	Geokon (App. 7\page 237)	68
	Kulite (App.7 \page 238)	68
7.4.2	Suction (App. 7 \pages 239-245)	68
7.4.3	Pore water pressure	68
	Geokon (App. 7\pages 246-248)	68
	Kulite (App. 7\page 249)	68
7.4.4	Temperature (App. 7\pages 250-252)	69
7.5	Temperature in the rock	69
7.5.1	Near hole 5 (App. 5\pages 194-196)	69
7.5.2	Near hole 6 (App. 7\pages 228-230)	69
8	References	71
	Appendix 1. Deposition hole 1	73
	Appendix 2. Deposition hole 3	101
	Appendix 3. Deposition holes 2 and 4	131
	Appendix 4. Backfill in Section 1	143
	Appendix 5. Deposition hole 5	165
	Appendix 6. Deposition hole 6	201
	Appendix 7. Backfill in Section 2	235
	Appendix 8. Canister displacements	253
	Appendix 9. Geo-electric monitoring	273
	Appendix 10 Stress and strain in the rock	309
	Appendix 11. Water pressure in the rock	343
	Quick guide	403

1 Introduction

The Prototype Repository Test consists of two sections. The installation of the first Section of Prototype Repository was made during summer and autumn 2001 and Section 2 was installed in spring and summer 2003.

Section 1 consists of four full-scale deposition holes, copper canisters equipped with electrical heaters, bentonite blocks and a deposition tunnel backfilled with a mixture of bentonite and crushed rock and ends with a concrete plug as shown in Figure 1-1.

Section 2 consists of two full-scale deposition holes with a backfilled tunnel section and ends also with a concrete plug.

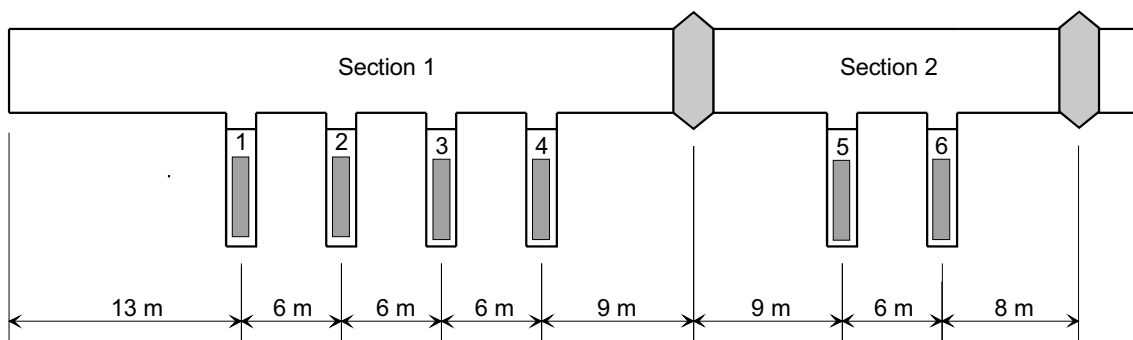

Figure 1-1. Schematic view of the Prototype Repository.

The bentonite buffer in deposition holes 1, 3, 5 and 6, the backfill and the surrounding rock are instrumented with gauges for measuring temperature, water pressure, total pressure, relative humidity, resistivity and canister displacement. The instruments are connected to data collection systems by cables protected by tubes, which are led through the rock in watertight lead throughs.

In general the data for Section 1 in this report are presented in diagrams covering the time period 2001-09-17 to 2004-12-01. The time axis in the diagrams represent number of days from start 2001-09-17, which is the day the heating of the canister in hole 1 was started. For Section 2 the date are presented in diagrams covering the time period 2003-05-08 to 2004-12-01, where 2003-05-08 is the day when the heating of the canister in hole 5 was started.

This report consists of several parts. In chapters 2, 3, 4 and 6 a test overview with the positions of those measuring points and a brief description of the instruments are shown. In chapter 5 the measured results from all measurements in Section 1, except canister displacement, stress and strain and water pressure in the rock and resistivity in the backfill and buffer, are presented and commented. Corresponding presentations and comments for Section 2 are made in chapter 7. The diagrams of those measured results are attached in Appendix 1-7. The results and comments of the measurements of canister displacement, resistivity in the backfill, stress and strain in the rock and water pressure in the rock are presented separately in Appendix 8-11.

A quick guide to the positions of the instruments in the buffer and backfill is enclosed as the last page.

2 Geometry and coordinate systems

The Prototype Repository consists of two sections as shown in Figure 1-1. The geometry and the coordinate system for the sensors are different for the deposition holes and the tunnel. The temperature sensors in the rock are defined with the same coordinate system as the deposition holes.

Deposition holes

In Section 1 the deposition holes are termed 1-4 according to Figure 1-1 and in Section 2 the deposition holes are termed 5 and 6. The coordinate system for these holes is shown in Figure 2-1. With the z -axis starting from the cement casting and the angle α counted anti-clockwise from direction A. Measurements are mainly made in four vertical sections A, B, C and D according to Figure 2-1. Direction A and C are placed in the tunnels axial direction with A headed against the end of the tunnel i.e. almost towards West.

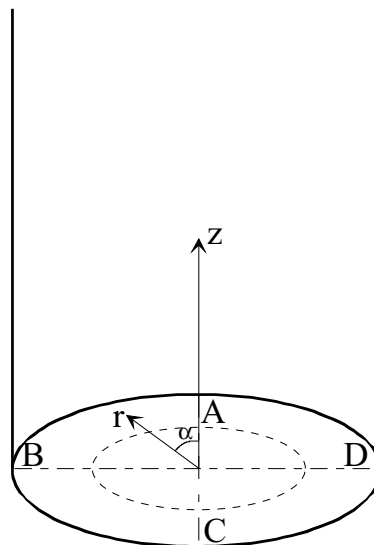

Figure 2-1. Figure describing the instrument planes (A-D) and the coordinate system used when describing the instrument positions.

Tunnel

The coordinate system of the backfill in the tunnel is shown in Figure 3-2. The coordinate y starts at the entrance on ground, which means that the tunnel ends at $y = 3599, 8$. The y -axis runs in the center of the tunnel, which means that the tunnel walls intersect the z and x -axes at ± 2.5 m. The z -coordinate is determined positive upwards and the x -coordinate is determined positive to the right when facing the end of the tunnel.

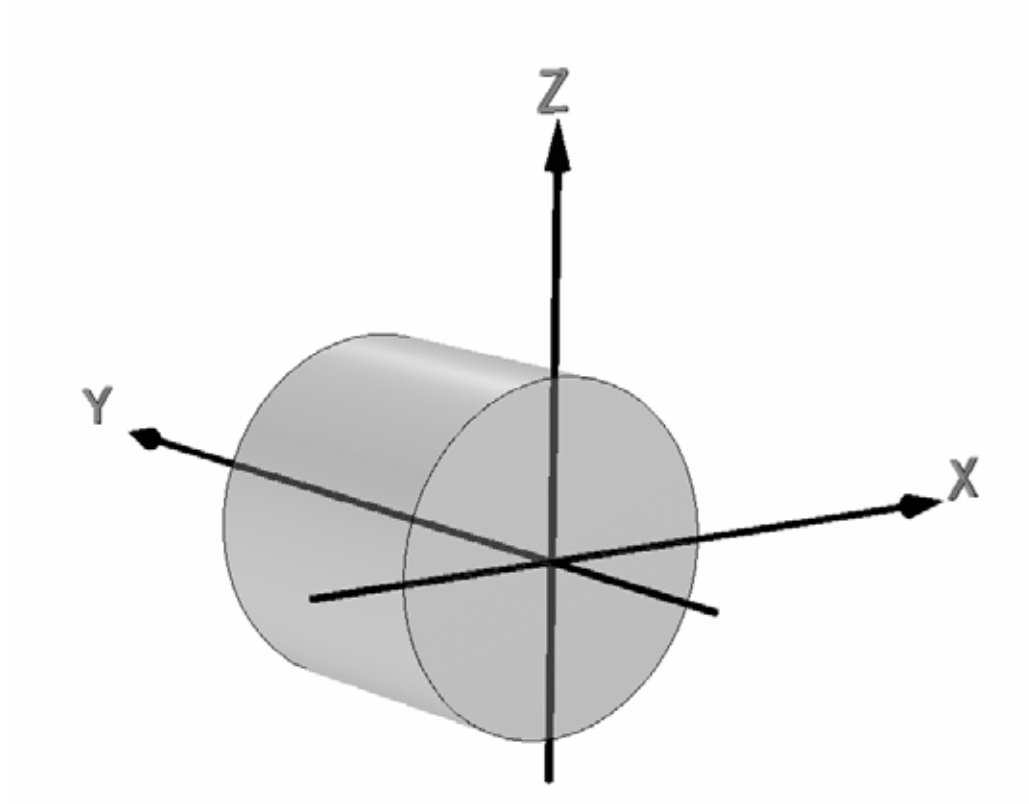

Figure 2-2. Coordinate system of the tunnel.

3 Brief description of the instruments

The different standard instruments that are used in the buffer, backfill and rock (temperature) are briefly described in this chapter.

Measurements of temperature

Buffer, backfill and rock

Thermocouples from Pentronic have been used to measure temperature. Measurements are done in 32 points in each instrumented hole (hole1 and hole 3). In addition, temperature gauges are built into the capacitive relative humidity sensors and some of the other sensor types as well.

Canister

Temperature is measured on the surface of the canister with optical fiber cables. An optical measuring system called FTR (Fiber Temperature Laser Radar) is used. In Section 2 are also three thermocouples of type Pentonic installed on each canister.

Measurement of total pressure in the buffer and backfill

Total pressure is the sum of the swelling pressure and the pore water pressure. It is measured with the following instrument types:

- Geokon total pressure cells with vibrating wire transducers.
- Kulite total pressure cells with piezo resistive transducers.

Measurement of pore water pressure in the buffer and backfill

Pore water pressure is measured with the following instrument types:

- Geokon pore pressure cells with vibrating wire transducer.
- Kulite pore pressure cells with piezo resistive transducer.

Measurement of the water saturation process in the buffer and backfill

The water saturation process is recorded by measuring the relative humidity in the pore system, which can be converted to total suction (negative water pressure). The following techniques and devices are used:

- Vaisala relative humidity sensor of capacitive type. The measuring range is 0-100 % RH.
- Rotronic relative humidity sensors of capacitive type. The measuring range is 0-100 % RH.
- Wescor soil psychrometer. The sensor is measuring the dry and the wet temperature in the pore volume of the material. The measuring range is 95.5-99.6 % RH corresponding to the pore water pressure -0.5 to -6 MPa. Psychrometers are placed in the backfill in both sections and in the buffer in the two deposition holes in Section 2.

4 Location of instruments in Section 1

4.1 Strategy for describing the position of each device in the bentonite and rock in and around the deposition holes

The same principles are used for describing the position of all sensors in the bentonite inside the deposition holes as well as the thermocouples in the rock around the deposition holes. The principles are described in the quick guide inserted as a folded A3 page at the end of the report.

Every instrument is named with a unique name consisting of 1 letter describing the type of measurement, 2 letters describing where the measurement takes place (buffer, backfill, rock or canister), 1 figure denoting the deposition hole (1-4) and 4 figures specifying the instrument according to a separate list (see Table 2-1 to 2-10). Every instrument position is then described with three coordinates according to Figure 3-1.

The r -coordinate is the horizontal distance from the center of the hole and the z -coordinate is the height from the surface of the bottom casting of the hole (the block height is set to 500mm). The α -coordinate is the angle from the vertical direction A (almost West).

Figure 4-1 shows an overview of the instruments in the buffer. The bentonite blocks are called cylinders and rings. The cylinders are numbered C1-C4 and the rings R1-R10 respectively.

- pore water pressure + temp.
- total pressure + temp.
- × temp.
- △ relative humidity (+ temp.)

1m

A

B+C

D

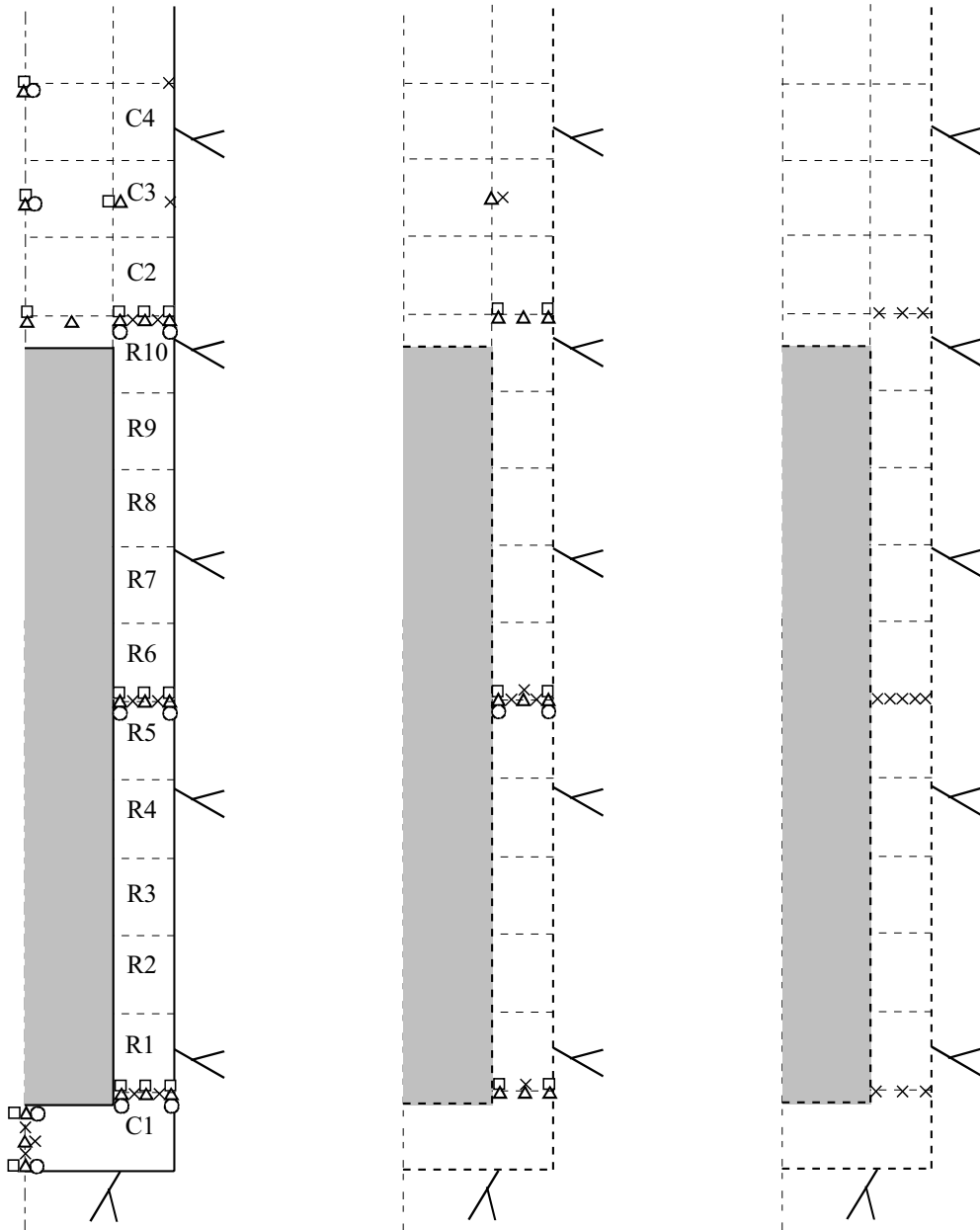

Figure 4-1 Schematic view over the instruments in four vertical sections and the block designation.

4.2 Position of each instrument in the bentonite in hole 1 (DA3587G01)

The instruments are located in three main levels in the blocks, 50 mm, 160 mm and 250 mm, from the upper surface. The thermocouples are mostly placed in the 50 mm level and the other gauges in the 160 mm level except for the Geokon type 1 pressure sensors and the Rotronic humidity sensors, which are placed in the 250 mm level depending on the size of the sensor house.

Exact positions of the sensors are described in Tables 4-1 to 4-4.

Table 4-1 Numbering and position of instruments for measuring temperature (T) in the buffer in hole 1.

Type and number	Block	Instrument position				Fabricate	Remark
		Direction	α degree	r m	Z m		
TBU10001	Cyl. 1	Center	270	0,050	0,054	Pentronic	
TBU10002	Cyl. 1	Center	270	0,050	0,254	Pentronic	
TBU10003	Cyl. 1	Center	270	0,050	0,454	Pentronic	
TBU10004	Cyl. 1	A	355	0,635	0,454	Pentronic	
TBU10005	Cyl. 1	A	355	0,735	0,454	Pentronic	
TBU10006	On top of the canister in hole 2					Pentronic	
TBU10007	Cyl. 1	C	175	0,685	0,454	Pentronic	
TBU10008	Cyl. 1	D	270	0,585	0,454	Pentronic	
TBU10009	Cyl. 1	D	270	0,685	0,454	Pentronic	
TBU10010	Cyl. 1	D	270	0,785	0,454	Pentronic	
TBU10011	Ring 5	A	0	0,635	2,980	Pentronic	
TBU10012	Ring 5	A	0	0,735	2,980	Pentronic	
TBU10013	Ring 5	B	90	0,585	2,980	Pentronic	
TBU10014	Ring 5	B	90	0,685	2,980	Pentronic	
TBU10015	Ring 5	B	90	0,785	2,980	Pentronic	
TBU10016	Ring 5	C	175	0,585	2,980	Pentronic	
TBU10017	Ring 5	C	175	0,685	2,980	Pentronic	
TBU10018	Ring 5	C	175	0,735	2,980	Pentronic	
TBU10019	Ring 5	D	270	0,585	2,980	Pentronic	
TBU10020	Ring 5	D	270	0,635	2,980	Pentronic	
TBU10021	Ring 5	D	270	0,685	2,980	Pentronic	
TBU10022	Ring 5	D	270	0,735	2,980	Pentronic	
TBU10023	Ring 5	D	270	0,785	2,980	Pentronic	
TBU10024	Ring 10	A	0	0,635	5,508	Pentronic	
TBU10025	Ring 10	A	0	0,735	5,508	Pentronic	
TBU10026	Ring 10	D	270	0,585	5,508	Pentronic	
TBU10027	Ring 10	D	270	0,685	5,508	Pentronic	
TBU10028	Ring 10	D	270	0,785	5,508	Pentronic	
TBU10029	Cyl. 3	A	0	0,785	6,317	Pentronic	
TBU10030	Cyl. 3	B	95	0,585	6,317	Pentronic	
TBU10031	Cyl. 3	C	185	0,585	6,317	Pentronic	
TBU10032	Cyl. 4	A	0	0,785	7,026	Pentronic	

Table 4-2 Numbering and position of instruments for measuring total pressure (P) in the buffer in hole 1.

Type and number	Block	Instrument position				Fabricate	Remark
		Direction	α degree	r m	Z m		
PBU10001	Cyl. 1	Center	0	0,000	0,000	Geokon	In cement
PBU10002	Cyl. 1	Center	0	0,100	0,504	Geokon	
PBU10003	Cyl. 1	A	5	0,585	0,504	Kulite	Vertical
PBU10004	Cyl. 1	A	5	0,685	0,504	Kulite	Vertical
PBU10005	Cyl. 1	A	5	0,785	0,504	Kulite	Vertical
PBU10006	Cyl. 1	B	95	0,635	0,504	Geokon	
PBU10007	Cyl. 1	B	105	0,735	0,504	Geokon	
PBU10008	Cyl. 1	C	185	0,635	0,504	Geokon	
PBU10009	Cyl. 1	C	195	0,735	0,504	Geokon	
PBU10011	Ring 5	A	5	0,685	2,780	Geokon I	
PBU10012	Ring 5	A	5	0,785	3,030	Kulite	In the slot
PBU10013	Ring 5	B	95	0,585	2,780	Geokon I	
PBU10014	Ring 5	B	95	0,785	2,780	Geokon I	
PBU10015	Ring 5	C	185	0,535	3,030	Geokon I	In the slot
PBU10016	Ring 5	C	185	0,825	2,870	Kulite	In the slot
PBU10017	Ring 10	Center	0	0,050	5,558	Geokon	
PBU10019	Ring 10	A	5	0,685	5,558	Kulite	Vertical
PBU10020	Ring 10	A	5	0,785	5,558	Kulite	Vertical
PBU10021	Ring 10	B	90	0,635	5,558	Geokon	
PBU10022	Ring 10	B	100	0,735	5,558	Geokon	
PBU10023	Ring 10	C	190	0,735	5,558	Geokon	
PBU10024	Ring 10	C	180	0,635	5,558	Geokon	
PBU10025	Cyl. 3	Center	0	0,050	6,317	Kulite	Vertical
PBU10026	Cyl. 3	A	5	0,585	6,567	Geokon	
PBU10027	Cyl. 4	Center	0	0,050	7,076	Kulite	Vertical

Table 4-3 Numbering and position of instruments for measuring pore water pressure (U) in the buffer in hole 1.

Type and number	Block	Instrument position				Fabricate	Remark
		Direction	α degree	r m	Z m		
UBU10001	Cyl. 1	Center	90	0,050	0,054	Kulite	
UBU10002	Cyl. 1	Center	90	0,050	0,254	Geokon	Horizontal
UBU10003	Cyl. 1	A	355	0,585	0,344	Geokon	
UBU10004	Cyl. 1	A	355	0,785	0,344	Kulite	
UBU10005	Ring 5	A	355	0,585	2,780	Geokon	
UBU10006	Ring 5	A	355	0,785	2,870	Kulite	
UBU10007	Ring 5	B	85	0,535	2,870	Kulite	In the slot
UBU10008	Ring 5	B	85	0,825	2,870	Kulite	In the slot
UBU10009	Ring 5	C	175	0,535	2,780	Geokon	In the slot
UBU10010	Ring 5	C	175	0,825	2,780	Geokon	In the slot
UBU10011	Ring 10	A	355	0,585	5,398	Kulite	
UBU10012	Ring 10	A	355	0,785	5,308	Geokon	
UBU10013	Cyl. 3	Center	90	0,050	6,317	Geokon	
UBU10014	Cyl. 4	Center	90	0,050	6,916	Geokon	

Table 4-4 Numbering and position of instruments for measuring water content (W) in the buffer in hole 1.

Type and number	Block	Instrument position				Fabricate	Remark
		Direction	α degree	r m	Z m		
WBU10001	Cyl. 1	Center	180	0,050	0,054	Rotronic	
WBU10002	Cyl. 1	Center	0	0,400	0,254	Rotronic	
WBU10003	Cyl. 1	Center	180	0,100	0,254	Rotronic	Horizontal
WBU10004	Cyl. 1	A	350	0,785	0,344	Vaisala	
WBU10005	Cyl. 1	A	350	0,685	0,344	Vaisala	
WBU10006	Cyl. 1	A	350	0,585	0,344	Vaisala	
WBU10007	Cyl. 1	B	80	0,585	0,344	Vaisala	
WBU10008	Cyl. 1	B	80	0,685	0,254	Rotronic	
WBU10009	Cyl. 1	B	80	0,785	0,254	Rotronic	
WBU10010	Cyl. 1	C	170	0,585	0,254	Rotronic	
WBU10011	Cyl. 1	C	170	0,685	0,254	Rotronic	
WBU10012	Cyl. 1	C	170	0,785	0,254	Rotronic	
WBU10013	Ring 5	A	350	0,585	2,870	Vaisala	
WBU10014	Ring 5	A	350	0,685	2,870	Vaisala	
WBU10015	Ring 5	A	350	0,785	2,870	Vaisala	
WBU10016	Ring 5	B	80	0,535	2,780	Rotronic	In the slot
WBU10017	Ring 5	B	80	0,685	2,780	Rotronic	
WBU10018	Ring 5	B	80	0,785	2,780	Rotronic	
WBU10019	Ring 5	C	180	0,535	2,870	Vaisala	In the slot
WBU10020	Ring 5	C	180	0,685	2,870	Vaisala	
WBU10021	Ring 5	C	180	0,785	2,780	Rotronic	
WBU10022	Ring 10	Center	0	0,050	5,418	Vaisala	
WBU10023	Ring 10	A	180	0,362	5,428	Vaisala	
WBU10024	Ring 10	A	350	0,585	5,398	Vaisala	
WBU10025	Ring 10	A	350	0,685	5,398	Vaisala	
WBU10026	Ring 10	A	350	0,785	5,398	Vaisala	
WBU10027	Ring 10	B	80	0,585	5,308	Rotronic	
WBU10028	Ring 10	B	80	0,685	5,308	Rotronic	
WBU10029	Ring 10	B	80	0,785	5,308	Rotronic	
WBU10030	Ring 10	C	170	0,585	5,398	Vaisala	
WBU10031	Ring 10	C	170	0,785	5,308	Rotronic	
WBU10032	Cyl. 3	Center	270	0,050	6,317	Vaisala	
WBU10033	Cyl. 3	A	350	0,585	6,317	Vaisala	
WBU10034	Cyl. 3	B	90	0,585	6,317	Vaisala	
WBU10035	Cyl. 3	C	180	0,585	6,317	Rotronic	
WBU10036	Cyl. 4	Center	180	0,050	6,916	Vaisala	
WBU10037	Cyl. 4	Center	270	0,050	6,756	Vaisala	

4.3 Position of each instrument in the bentonite in hole 3 (DA3575G01)

The instruments are located according to the same system as those in hole 1.

The positions of each instrument are described in Tables 4-6 to 4-10.

Table 4-6 Numbering and position of instruments for measuring temperature (T) in the buffer in hole 3.

Type and number	Block	Instrument position				Fabricate	Remark
		Direction	α degree	r m	Z m		
TBU30001	Cyl. 1	Center	270	0,050	0,095	Pentronic	
TBU30002	Cyl. 1	Center	270	0,050	0,295	Pentronic	
TBU30003	Cyl. 1	Center	270	0,050	0,445	Pentronic	
TBU30004	Cyl. 1	A	355	0,635	0,445	Pentronic	
TBU30005	Cyl. 1	A	355	0,735	0,445	Pentronic	
TBU30006	Cyl. 1	B	85	0,685	0,445	Pentronic	
TBU30007	Cyl. 1	C	175	0,685	0,445	Pentronic	
TBU30008	Cyl. 1	D	270	0,585	0,445	Pentronic	
TBU30009	Cyl. 1	D	270	0,685	0,445	Pentronic	
TBU30010	Cyl. 1	D	270	0,785	0,445	Pentronic	
TBU30011	Ring 5	A	0	0,635	2,971	Pentronic	
TBU30012	Ring 5	A	0	0,735	2,971	Pentronic	
TBU30013	Ring 5	B	90	0,585	2,971	Pentronic	
TBU30014	Ring 5	B	90	0,685	2,971	Pentronic	
TBU30015	Ring 5	B	90	0,785	2,971	Pentronic	
TBU30016	Ring 10	A	329	0,410	5,394	Pentronic	Just above canister lid
TBU30017	Ring 5	C	175	0,685	2,971	Pentronic	
TBU30018	Ring 5	C	175	0,735	2,971	Pentronic	
TBU30019	Ring 5	D	270	0,585	2,971	Pentronic	
TBU30020	Ring 5	D	270	0,635	2,971	Pentronic	
TBU30021	Ring 5	D	270	0,685	2,971	Pentronic	
TBU30022	Ring 5	D	270	0,735	2,971	Pentronic	
TBU30023	Ring 5	D	270	0,785	2,971	Pentronic	
TBU30024	Ring 10	A	0	0,635	5,504	Pentronic	
TBU30025	Ring 10	A	0	0,735	5,504	Pentronic	
TBU30026	Ring 10	D	270	0,585	5,504	Pentronic	
TBU30027	Ring 10	D	270	0,685	5,504	Pentronic	
TBU30028	Ring 10	D	270	0,785	5,504	Pentronic	
TBU30029	Cyl. 3	A	0	0,785	6,314	Pentronic	
TBU30030	Cyl. 3	B	95	0,585	6,314	Pentronic	
TBU30031	Cyl. 3	C	185	0,585	6,314	Pentronic	
TBU30032	Cyl. 4	A	0	0,785	7,015	Pentronic	

Table 4-7 Numbering and position of instruments for measuring total pressure (P) in the buffer in hole 3.

Type and number	Block	Instrument position in block				Fabricate	Remark
		Direction	α degree	r mm	Z mm		
PBU30001	Cyl. 1	Center	0	0	0	Geokon	In cement
PBU30002	Cyl. 1	Center	0	100	495	Geokon	
PBU30003	Cyl. 1	A	5	585	495	Kulite	Vertical
PBU30004	Cyl. 1	A	5	685	495	Kulite	Vertical
PBU30005	Cyl. 1	A	5	785	495	Kulite	Vertical
PBU30006	Cyl. 1	B	95	635	495	Geokon	
PBU30007	Cyl. 1	B	105	735	495	Geokon	
PBU30008	Cyl. 1	C	185	635	495	Geokon	
PBU30009	Cyl. 1	C	195	735	495	Geokon	
PBU30010	Ring 5	A	5	535	3021	Kulite	In the slot
PBU30011	Ring 5	A	5	685	2771	Geokon I	
PBU30012	Ring 5	A	5	825	3021	Kulite	In the slot
PBU30013	Ring 5	B	95	585	2771	Geokon I	
PBU30014	Ring 5	B	95	785	2771	Geokon I	
PBU30015	Ring 5	C	185	535	3021	Geokon I	In the slot
PBU30016	Ring 5	C	185	825	2971	Kulite	In the slot
PBU30017	Ring 10	Center	0	50	5556	Geokon	
PBU30018	Ring 10	A	5	585	5556	Kulite	Vertical
PBU30019	Ring 10	A	5	685	5556	Kulite	Vertical
PBU30020	Ring 10	A	5	785	5556	Kulite	Vertical
PBU30021	Ring 10	B	90	635	5556	Geokon	
PBU30022	Ring 10	B	100	735	5556	Geokon	
PBU30023	Ring 10	C	180	735	5556	Geokon	
PBU30024	Ring 10	C	190	635	5556	Geokon	
PBU30025	Cyl. 3	Center	0	50	6314	Kulite	Vertical
PBU30026	Cyl. 3	A	5	585	6564	Geokon	
PBU30027	Cyl. 4	Center	0	50	7065	Kulite	Vertical

Table 4-8 Numbering and position of instruments for measuring pore water pressure (U) in the buffer in hole 3.

Type and number	Block	Instrument position in block				Fabricate	Remark
		Direction	α degree	r mm	Z mm		
UBU30001	Cyl. 1	Center	90	50	45	Kulite	
UBU30002	Cyl. 1	Center	90	100	245	Geokon	Horizontal
UBU30003	Cyl. 1	A	355	585	335	Geokon	
UBU30004	Cyl. 1	A	355	785	335	Kulite	
UBU30005	Ring 5	A	355	585	2771	Geokon	
UBU30006	Ring 5	A	355	785	2861	Kulite	
UBU30007	Ring 5	B	85	535	2861	Kulite	In the slot
UBU30008	Ring 5	B	85	825	2861	Kulite	In the slot
UBU30009	Ring 5	C	175	535	2771	Geokon	In the slot
UBU30010	Ring 5	C	175	825	2771	Geokon	In the slot
UBU30011	Ring 10	A	355	585	5396	Kulite	
UBU30012	Ring 10	A	355	785	5306	Geokon	
UBU30013	Cyl. 3	Center	90	50	6314	Geokon	
UBU30014	Cyl. 4	Center	90	50	6910	Geokon	

Table 4-9 Numbering and position of instruments for measuring water content (W) in the buffer in hole 3

Type and number	Block	Instrument position				Fabricate	Remark
		Direction	α degree	r m	Z m		
WBU30001	Cyl. 1	Center	180	0,050	0,045	Rotronic	
WBU30002	Cyl. 1	Center	0	0,400	0,215	Rotronic	
WBU30003	Cyl. 1	Center	180	0,100	0,245	Rotronic	Horizontal
WBU30004	Cyl. 1	A	350	0,785	0,335	Vaisala	
WBU30005	Cyl. 1	A	350	0,685	0,335	Vaisala	
WBU30006	Cyl. 1	A	350	0,585	0,335	Vaisala	
WBU30007	Cyl. 1	B	80	0,585	0,335	Vaisala	
WBU30008	Cyl. 1	B	80	0,685	0,245	Rotronic	
WBU30009	Cyl. 1	B	80	0,785	0,245	Rotronic	
WBU30010	Cyl. 1	C	170	0,585	0,245	Rotronic	
WBU30011	Cyl. 1	C	170	0,685	0,245	Rotronic	
WBU30012	Cyl. 1	C	170	0,785	0,245	Rotronic	
WBU30013	Ring 5	A	350	0,585	2,861	Vaisala	
WBU30014	Ring 5	A	350	0,685	2,861	Vaisala	
WBU30015	Ring 5	A	350	0,785	2,861	Vaisala	
WBU30016	Ring 5	B	80	0,535	2,771	Rotronic	In the slot
WBU30017	Ring 5	B	80	0,685	2,771	Rotronic	
WBU30018	Ring 5	B	80	0,785	2,771	Rotronic	
WBU30019	Ring 5	C	180	0,535	2,861	Vaisala	In the slot
WBU30020	Ring 5	C	180	0,685	2,861	Vaisala	
WBU30021	Ring 5	C	180	0,785	2,771	Rotronic	
WBU30022	Ring 10	Center	180	0,050	5,416	Vaisala	
WBU30023	Ring 10	A	352	0,262	5,396	Vaisala	
WBU30024	Ring 10	A	350	0,585	5,396	Vaisala	
WBU30025	Ring 10	A	350	0,785	5,396	Vaisala	
WBU30026	Ring 10	A	350	0,685	5,396	Vaisala	
WBU30027	Ring 10	B	80	0,585	5,306	Rotronic	
WBU30028	Ring 10	B	80	0,685	5,306	Rotronic	
WBU30029	Ring 10	B	80	0,785	5,306	Rotronic	
WBU30030	Ring 10	C	170	0,585	5,396	Vaisala	
WBU30031	Ring 10	C	170	0,785	5,306	Rotronic	
WBU30032	Cyl. 3	Center	180	0,050	6,314	Vaisala	
WBU30033	Cyl. 3	A	350	0,585	6,314	Vaisala	
WBU30034	Cyl. 3	B	90	0,585	6,314	Vaisala	
WBU30035	Cyl. 3	C	180	0,585	6,314	Rotronic	
WBU30036	Cyl. 4	Center	180	0,050	6,910	Vaisala	
WBU30037	Cyl. 4	Center	270	0,050	6,750	Vaisala	

4.4 Instruments on the canister surface in holes 1-4

The canisters are instrumented with optical fiber cables on the copper surface.

Figure 4-2 shows how two optical fiber cables are placed on the canister surface. Both ends of a cable are used for measurements. This means that the two cables are used for four measurements.

With this laying the cables will enter and exit the surface at almost the same position. Curvatures are shaped as a quarter circle with a radius of 20 cm. The cables are placed in a milled out channels on the surface. The channels have a width and a depth of just above 2 mm

In addition to the optical cables one thermocouple (TBU 10006) is fixed to the lid of the canister in deposition hole 2 (see Table 4-1).

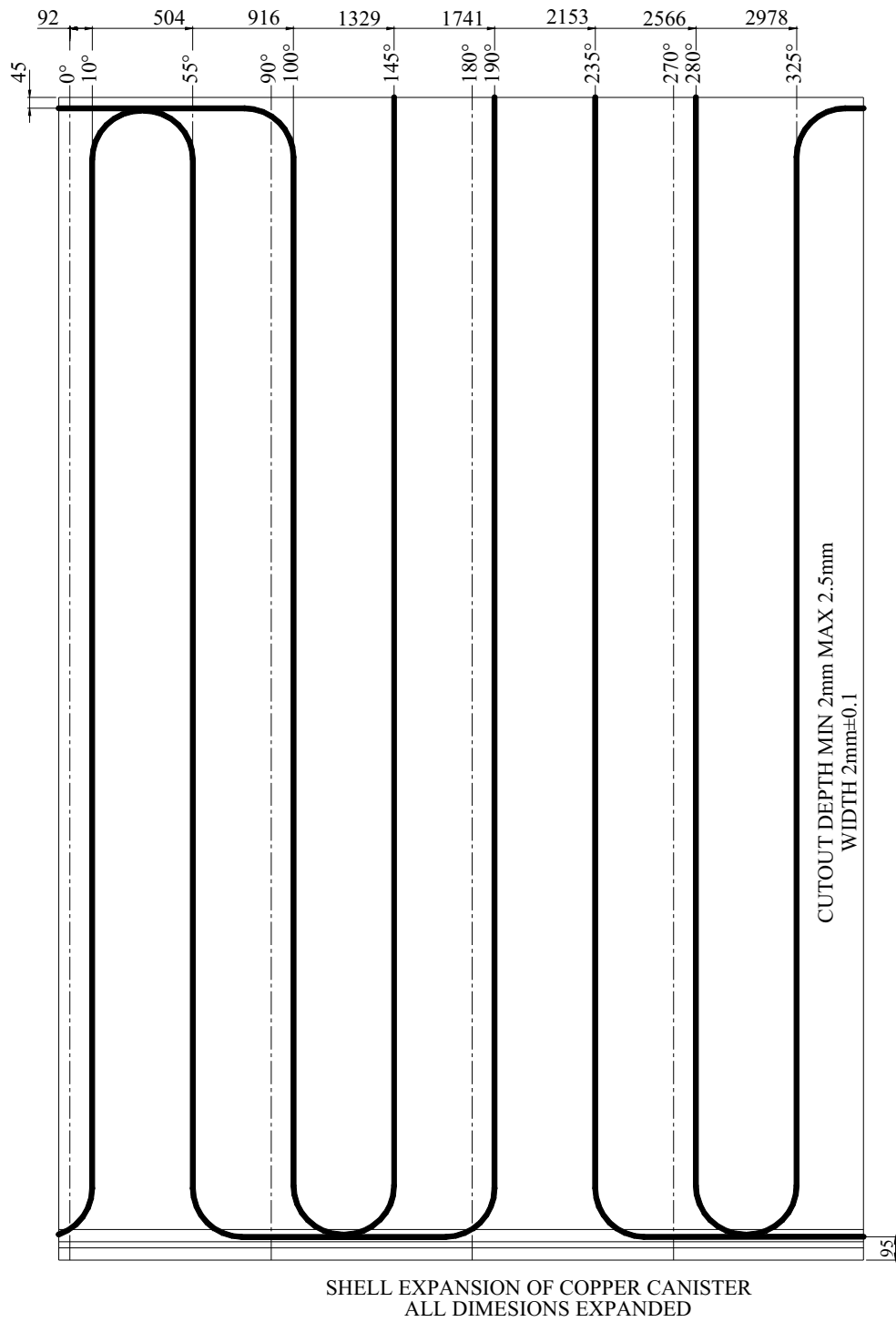

Figure 4-2. Laying of the optical fiber cables with protection tube of Inconel 625 (outer diameter 2 mm) for measurement of the canister surface temperature (surface unfolded)

4.5 Position of temperature sensors in the rock

The positions of the temperature sensors in the rock are termed in the same way as the sensors in the buffer in the deposition holes. Figure 4-3 shows an overview of the temperature sensors placed in the rock. The sensors are assigned to the closest deposition hole. The positions are described in Table 4-10.

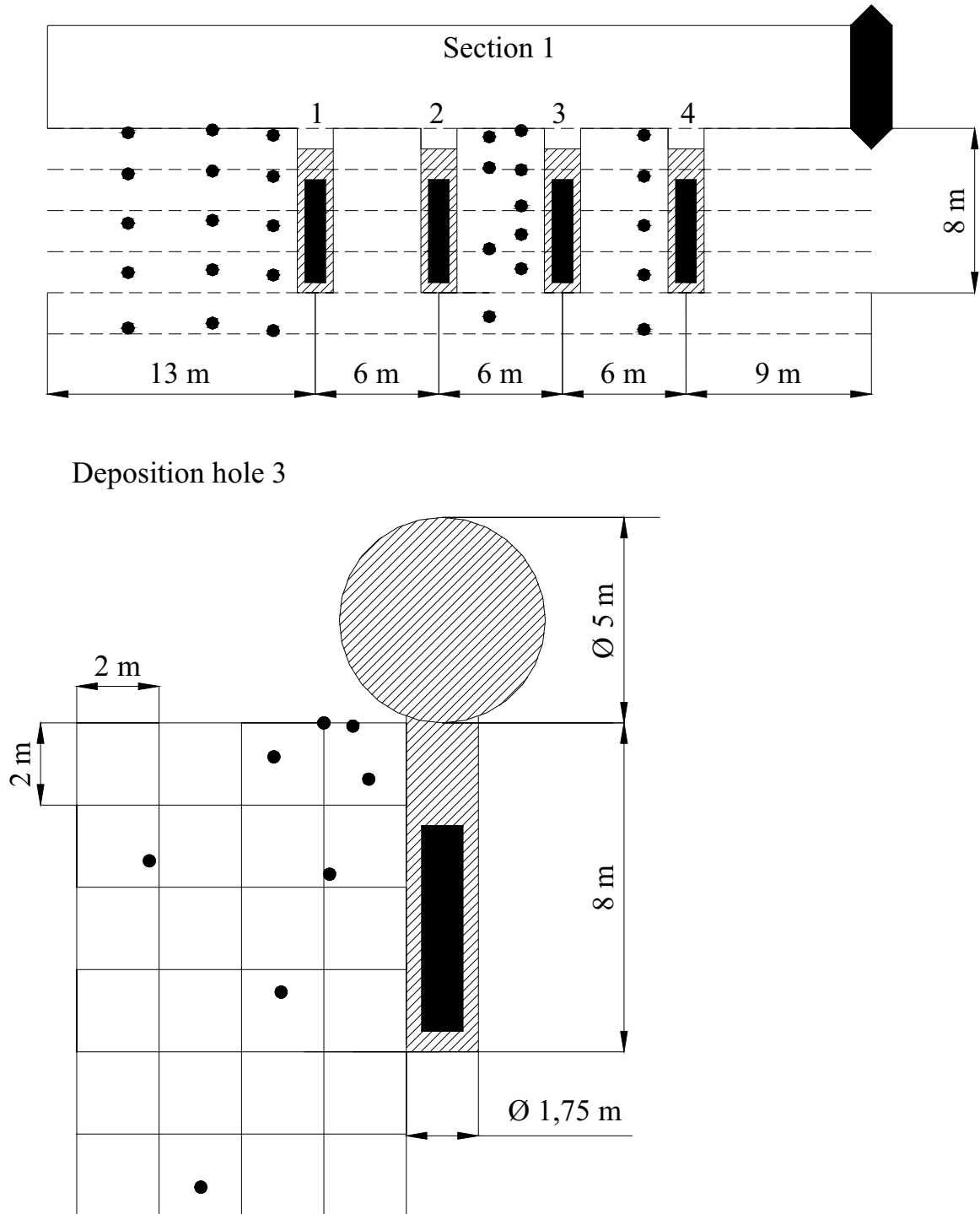

Figure 4-3. Overview of the temperature sensors in the rock. Length section (upper) and cross section (towards the end of the tunnel)

Table 4-10. Numbering and position of temperature sensors in the rock

Instrument position in rock				
Type and number	α	r	Z	Fabricate
	degree	m	m	
Measured from DA3587G01 (Hole 1)				
TROA0350	360°	9,086	7,784	
TROA0340	360°	9,086	5,784	
TROA0330	0°	9,086	3,384	
TROA0320	0°	9,087	0,985	
TROA0310	0°	9,086	-1,715	
TROA0650	360°	4,996	7,921	
TROA0640	360°	4,988	5,921	
TROA0630	360°	4,978	3,521	
TROA0620	360°	4,968	1,121	
TROA0610	360°	4,956	-1,479	
TROA1050	359°	2,02	7,662	
TROA1040	359°	2,028	5,662	
TROA1030	359°	2,038	3,262	
TROA1020	359°	2,048	0,862	
TROA1010	359°	2,059	-1,838	
Measured from DA3581G01(Hole 2)				
TROA1840	180°	2,404	7,5868	
TROA1830	180°	2,427	6,0868	
TROA1820	179°	2,49	2,1378	
TROA1810	179°	2,542	-1,1622	
Measured from DA3575G01(Hole 3)				
TROA2150	134°	3,284	7,958	
TROA2140	1°	1,999	5,979	
TROA2130	2°	1,981	4,23	
TROA2120	2°	1,967	2,84	
TROA2110	3°	1,95	1,17	
TROA1850	0°	2,019	7,889	
TROA2330	90°	2,169	7,924	
TROA2320	90°	1,787	6,632	
TROA2310	109°	7,111	4,64	
TROA2440	124°	4,088	7,174	
TROA2430	90°	2,737	4,319	
TROA2420	89°	3,914	1,451	
TROA2410	89°	5,861	-3,295	
Measured from DA3569G01 (Hole 4)				
TROA3050	360°	2,017	7,671	
TROA3040	359°	2,025	5,671	
TROA3030	358°	2,034	3,271	
TROA3020	358°	2,045	0,871	
TROA3010	357°	2,056	-1,778	

4.6 Strategy for describing the position of each device in the backfill in section 1

The principles of terming the instruments are described in the quick guide inserted as a folded A3 page at the end of the report.

Every instrument is named with a unique name consisting of 1 letter describing the type of measurement, 2 letters describing where the measurement takes place (buffer, backfill, rock or canister) and 5 figures specifying the instrument according to separate lists (see Tables 4-11 to 4-14). Every instrument position is then described with three coordinates according to Figure 2-2. The x -coordinate is the horizontal distance from the center of the tunnel and the z -coordinate is the vertical distance from the center of the tunnel. The y -coordinate is the same as in the tunnel coordinate system, i.e. $y=3599$ corresponds to the end of the tunnel.

The backfill is mainly instrumented in vertical sections straight above and between the deposition holes (Figures 4-4 and 4-5).

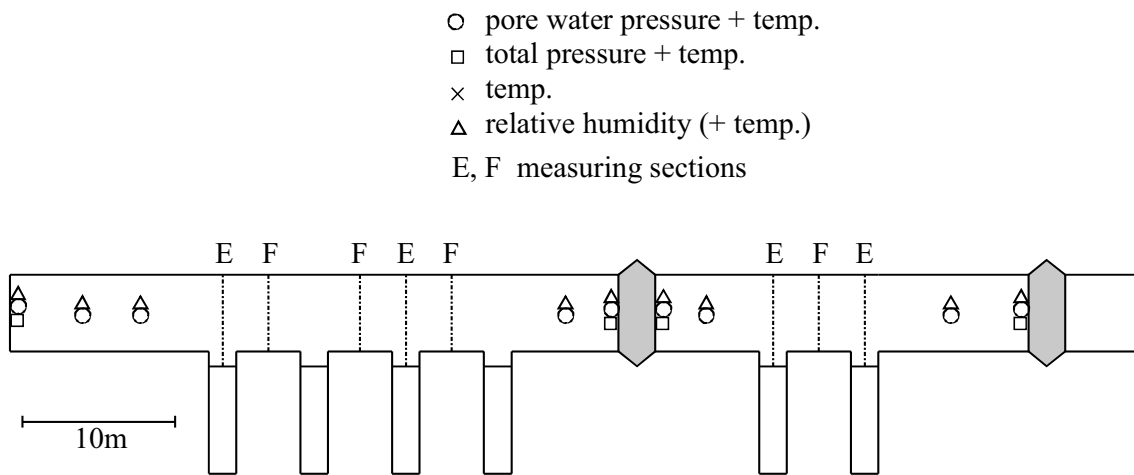

Figure 4-4 Schematic view over the instrumentation of the backfill

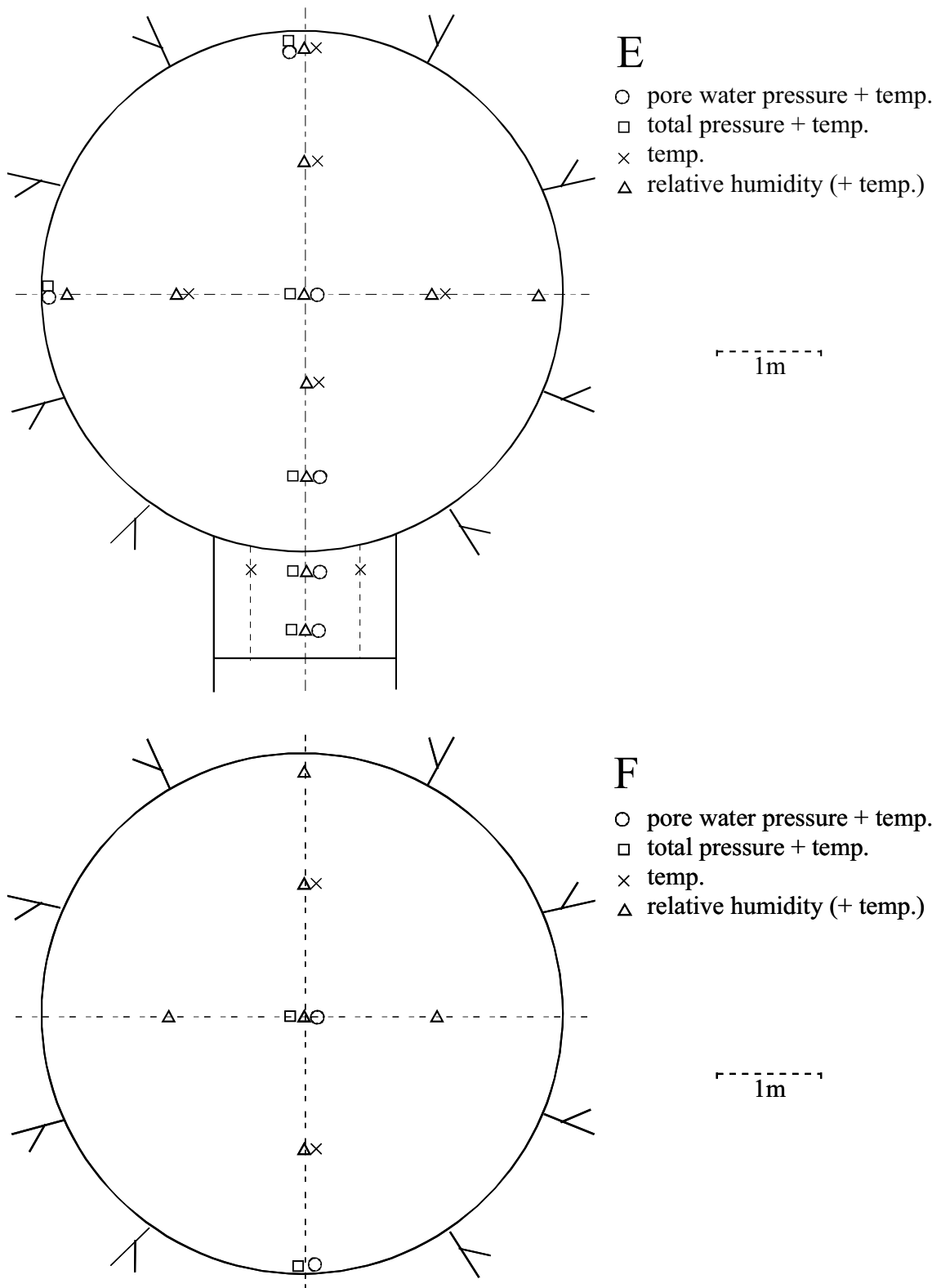

Figure 4-5 Schematic view over the sensors positions in the different sections.

4.7 Position of each instrument in the backfill

The positions of each instrument are described in Tables 4-11 to 4-14.

Table 4-11 Numbering and position of instruments for measuring temperature (T) in the backfill.

Type and number	Instrument position				Fabricate	Remark
	Section	x	z	y		
		m	m	m		
TBA10001	E, over dep.hole 1	-1,3	-0,1	3 587	Pentronic	
TBA10002	E, over dep.hole 1	0,1	1,3	3 587	Pentronic	
TBA10003	E, over dep.hole 1	0,0	-0,8	3 587	Pentronic	
TBA10004	E, over dep.hole 1	-0,5	-2,6	3 587	Pentronic	
TBA10005	E, over dep.hole 1	0,5	-2,6	3 587	Pentronic	
TBA10006	E, over dep.hole 1	-0,1	2,3	3 587	Pentronic	
TBA10007	E, over dep.hole 1	1,3	-0,1	3 587	Pentronic	
TBA10008	F, between dep.hole 1 and 2	0,0	1,3	3 584	Pentronic	
TBA10009	F, between dep.hole 1 and 2	-0,1	-1,3	3 584	Pentronic	
TBA10010	F, between dep.hole 2 and 3	0,0	1,2	3 578	Pentronic	
TBA10011	F, between dep.hole 2 and 3	0,0	-1,2	3 578	Pentronic	
TBA10012	E, over dep.hole 3	-0,1	2,3	3 575	Pentronic	
TBA10013	E, over dep.hole 3	0,0	1,3	3 575	Pentronic	
TBA10014	E, over dep.hole 3	0,0	-0,9	3 575	Pentronic	
TBA10015	E, over dep.hole 3	-0,5	-2,6	3 575	Pentronic	
TBA10016	E, over dep.hole 3	0,5	-2,6	3 575	Pentronic	
TBA10017	E, over dep.hole 3	-1,3	0,0	3 575	Pentronic	
TBA10018	E, over dep.hole 3	1,3	0,0	3 575	Pentronic	
TBA10019	F, between dep.hole 3 and 4	0,0	1,2	3 572	Pentronic	
TBA10020	F, between dep.hole 3 and 4	0,0	-1,3	3 572	Pentronic	

Table 4-12 Numbering and position of instruments for measuring total pressure (P) in the backfill.

Type and number	Instrument position			Fabricate	Remark
	Section	x	z		
		m	m	m	
PBA10001	Inner part	0,2	0,1	3589	Kulite
PBA10002	E, over dep.hole 1	0,0	0,0	3587	Geokon
PBA10003	E, over dep.hole 1	0,0	-1,8	3587	Geokon
PBA10004	E, over dep.hole 1	0,0	-2,6	3587	Geokon
PBA10005	E, over dep.hole 1	0,0	-3,1	3587	Kulite
PBA10006	E, over dep.hole 1	-2,3	0,1	3587	Kulite
PBA10007	E, over dep.hole 1	0,2	2,3	3587	Kulite
PBA10008	F, between dep.hole 1 and 2	0,0	0,0	3584	Geokon
PBA10009	F, between dep.hole 1 and 2	-0,1	-1,8	3584	Geokon
PBA10010	F, between dep.hole 2 and 3	0,0	-0,2	3578	Kulite
PBA10011	F, between dep.hole 2 and 3	0,0	-2,3	3578	Kulite
PBA10013	E, over dep.hole 3	0,0	-1,8	3575	Kulite
PBA10015	E, over dep.hole 3	0,0	-3,1	3575	Geokon
PBA10016	E, over dep.hole 3	-2,3	0,0	3575	Geokon
PBA10017	E, over dep.hole 3	0,0	0,0	3575	Geokon
PBA10018	F, between dep.hole 3 and 4	0,0	0,0	3572	Geokon
PBA10019	F, between dep.hole 3 and 4	0,0	-2,3	3572	Geokon
PBA10020	In front of plug	0,0	0,0	3561	Kulite

Table 4-13 Numbering and position of instruments for measuring pore water pressure (U) in the backfill.

Type and number	Instrument position			Fabricate	Remark	
	Section	x	z			y
		m	m			m
UBA10001	Inner part	-0,2	-0,1	3589	Kulite	
UBA10002	Inner part	0,0	0,0	3592	Geokon	
UBA10003	Inner part	-0,2	-0,1	3590	Geokon	
UBA10004	E, over dep.hole 1	0,0	-0,1	3587	Geokon	
UBA10005	E, over dep.hole 1	-0,2	-1,8	3587	Kulite	
UBA10006	E, over dep.hole 1	0,1	-2,6	3587	Kulite	
UBA10007	E, over dep.hole 1	0,4	-3,2	3587	Kulite	
UBA10008	E, over dep.hole 1	-2,3	0,0	3587	Geokon	
UBA10009	E, over dep.hole 1	0,0	2,3	3587	Geokon	
UBA10010	F, between dep.hole 1 and 2	0,0	0,0	3584	Kulite	
UBA10011	F, between dep.hole 1 and 2	0,1	-1,8	3584	Kulite	
UBA10012	F, between dep.hole 2 and 3	0,0	-0,2	3578	Kulite	
UBA10013	F, between dep.hole 2 and 3	0,0	-2,3	3578	Kulite	
UBA10014	E, over dep.hole 3	0,0	0,0	3575	Kulite	
UBA10015	E, over dep.hole 3	0,0	-1,8	3575	Geokon	
UBA10016	E, over dep.hole 3	0,3	-2,6	3575	Geokon	
UBA10017	E, over dep.hole 3	-0,1	-3,1	3575	Geokon	
UBA10018	E, over dep.hole 3	-2,3	0,0	3575	Geokon	
UBA10019	E, over dep.hole 3	0,0	0,0	3575	Geokon	
UBA10020	F, between dep.hole 3 and 4	0,0	0,0	3572	Kulite	
UBA10021	F, between dep.hole 3 and 4	0,0	-2,3	3572	Kulite	
UBA10022	In front of plug	0,0	0,0	3565	Kulite	
UBA10023	In front of plug	0,1	0,0	3562	Kulite	

Table 4-14 Numbering and position of instruments for measuring relative humidity (W) in the backfill.

Type and number	Instrument position			Fabricate	Remark
	Section	x	z		
		m	m	m	
WBA10001	Inner part	0,0	0,0	3589	Wescor
WBA10002	Inner part	0,0	0,0	3592	Wescor
WBA10003	Inner part	0,1	-0,1	3590	Wescor
WBA10004	E, over dep.hole 1	0,3	2,3	3587	Wescor
WBA10005	E, over dep.hole 1	0,0	1,3	3587	Wescor
WBA10006	E, over dep.hole 1	0,0	0,1	3587	Wescor
WBA10007	E, over dep.hole 1	0,1	-0,8	3587	Wescor
WBA10008	E, over dep.hole 1	0,0	-1,7	3587	Wescor
WBA10009	E, over dep.hole 1	-0,1	-2,6	3587	Wescor
WBA10010	E, over dep.hole 1	-0,5	-3,1	3587	Wescor
WBA10011	E, over dep.hole 1	-2,3	-0,1	3587	Wescor
WBA10012	E, over dep.hole 1	-1,3	0,0	3587	Wescor
WBA10013	E, over dep.hole 1	1,3	0,0	3587	Wescor
WBA10014	E, over dep.hole 1	2,3	0,0	3587	Wescor
WBA10015	F, between dep.hole 1 and 2	0,0	1,3	3584	Wescor
WBA10016	F, between dep.hole 1 and 2	0,0	2,3	3584	Wescor
WBA10017	F, between dep.hole 1 and 2	0,0	0,0	3584	Wescor
WBA10018	F, between dep.hole 1 and 2	0,0	-1,3	3584	Wescor
WBA10019	F, between dep.hole 1 and 2	-1,3	0,0	3584	Wescor
WBA10020	F, between dep.hole 1 and 2	1,3	0,0	3584	Wescor
WBA10021	F, between dep.hole 2 and 3	0,0	2,3	3578	Wescor
WBA10022	F, between dep.hole 2 and 3	0,0	1,2	3578	Wescor
WBA10023	F, between dep.hole 2 and 3	0,0	-0,2	3578	Wescor
WBA10024	F, between dep.hole 2 and 3	0,0	-1,2	3578	Wescor
WBA10025	F, between dep.hole 2 and 3	-1,3	0,0	3578	Wescor
WBA10026	F, between dep.hole 2 and 3	1,3	0,0	3578	Wescor
WBA10027	E, over dep.hole 3	0,0	2,5	3575	Wescor
WBA10028	E, over dep.hole 3	0,0	1,3	3575	Wescor
WBA10029	E, over dep.hole 3	0,0	0,0	3575	Wescor
WBA10030	E, over dep.hole 3	0,0	-0,9	3575	Wescor
WBA10031	E, over dep.hole 3	0,0	-1,6	3575	Wescor
WBA10032	E, over dep.hole 3	-0,3	-2,6	3575	Wescor
WBA10033	E, over dep.hole 3	0,1	-3,1	3575	Wescor
WBA10034	E, over dep.hole 3	-2,3	0,0	3575	Wescor
WBA10035	E, over dep.hole 3	-1,3	0,0	3575	Wescor
WBA10036	E, over dep.hole 3	1,3	0,0	3575	Wescor
WBA10037	E, over dep.hole 3	2,3	0,0	3575	Wescor
WBA10038	F, between dep.hole 3 and 4	0,0	2,3	3572	Wescor
WBA10039	F, between dep.hole 3 and 4	0,0	1,2	3572	Wescor
WBA10040	F, between dep.hole 3 and 4	0,0	0,0	3572	Wescor
WBA10041	F, between dep.hole 3 and 4	0,0	-1,3	3572	Wescor
WBA10042	F, between dep.hole 3 and 4	-1,3	0,0	3572	Wescor
WBA10043	F, between dep.hole 3 and 4	1,3	0,0	3572	Wescor
WBA10044	In front of plug	0,0	0,0	3565	Wescor
WBA10045	In front of plug	-0,1	0,0	3562	Wescor

5 Results and comments for Section 1

5.1 General

In this chapter short comments on general trends in the measurements are given. Sensors that are not delivering reliable data or no data at all are noted and comments on the data collection in general are given.

The heating of the canister in hole1 started with an applied constant power of 1800 W at 010917. This date is also marked as start date. The backfilling started 010903 and was finished 011120 and the plug was cast at 011214. In order to simulate the radioactive decay, the power was decreased 20 W one year after start of the first heater. In the beginning of September year 2004 the power was decreased with about 30 W to 1710 W in deposition holes 1-4. Table 5-1 shows some important dates for section 1. At the beginning of November the drainage of the inner part of Section 1 and the drainage trough the outer plug were closed.

Table 5-1. Key dates for section 1

Activity	Date
Start backfilling	3/9 2001
Start heating canister 1	17/9 2001
Start heating canister 2	24/9 2001
Start heating canister 3	11/10 2001
Start heating canister 4	22/10 2001
Finish backfilling	20/11 2001
Plug casting	14/12 2001
Decreased power (-20 W)	17/9 2002
Decreased power (-40 W)	5/9 2003
Decreased power (-30 W)	8/9 2004
The drainage of inner section was closed	1/10 2004
The drainage of the outer plug was closed	1/10 2004

Beside the above reported power reductions a change in power was made June 23 2003 due to additional calculations of the power from measurement of the energy. The power of the canisters was adjusted to 1800 W. The most significant change was made for canister 2 (See section 5.4.1 and Appendix 3 page 138).

About 153 out of 363 sensors (excluding water pressure sensors in the rock and the displacement sensors for the canister) are out of order, the majority being RH-sensors that fail at water saturation and thermocouples in deposition hole 3.

The processes have been slow up to about 20 days after the drainage of the tunnel was closed. Very small changes of the measured parameters have occurred up to that date. After that the readings from some of the total and pore pressure transducers placed in the buffer have reacted strongly (quick increase in pressure). Also the total and pore pressure transducers placed in the backfill have recorded high pressures caused by the closing of the drainage.

So far hole 1 has been strongly wetted but very little wetting is observed in hole 3. A slow but obvious wetting of the backfill is noted until about 20 days after the closing of the drainage. After that a strongly increase of the wetting rate was monitored by several psychrometers. The maximum temperature of the canisters differ substantially (C1: 75°C, C2: 91°C, C3: 97°C, C4: 88°C).

5.2 Deposition hole 1

5.2.1 Total pressure

Geokon (App. 1\pages 75-77)

The measured pressure range is from 1.3 to 8.5 MPa. The highest pressure is indicated from the peripheral transducers in the bottom block (C1). Four sensors in block R5 and block R10 yield a high increase in total pressure at the end of this measuring period caused by the closing of the drainage.

Eleven transducers are out of order.

Kulite (App. 1\page 78)

The highest pressure 7 MPa is indicated from the peripheral transducer (PBU 10012) in block R5. Three of the installed transducers are also showing a rapid increase in pressure at the end of this measuring period.

Two transducers were not installed and five of the installed transducers are out of order.

5.2.2 Relative humidity

Vaisala (App. 1\pages 79-82)

Since temperature is also measured with all relative humidity sensors, the diagrams include those measured temperatures. The temperature measurements start at about 16 degrees while the RH measurements start at about 70 %RH.

The relative humidity has not changed very much during the last 3 months.

Thirteen transducers are out of order, most of them due to water saturation.

Rotronic (App. 1\pages 83-87)

All Rotronic transducers placed between the canister and the rock show RH higher than 90%.

Two of the transducers placed in block C1 are indicating a drying of the bentonite (decreasing in RH from about 75%)

Fifteen transducers are out of order, most of them due to water saturation.

5.2.3 Pore water pressure

Geokon (App. 1\page 88)

The highest pressures 500-1450 kPa are measured near the canister surface in block R5 (UBU10005) and in the periphery of block R5 (UBU10010).

Two sensors are out of order.

Kulite (App. 1\page 89)

A rather high water pressure is noted from three sensors located in block R5 (1200 – 2700 kPa).

Two sensors are out of order.

5.2.4 Temperature in the buffer (App. 1\pages 90-94)

The latest measured temperature ranges from 30.0 °C (in the periphery of the upper bentonite cylinder C4) to 72.0 °C in the center close to the canister. The highest temperature gradient is 0.64 °C /cm (block R5).

Sixteen sensors are out of order.

5.2.5 Canister power in dep. hole 1 (App. 1\page 98)

The power of the canister in hole 1 has been kept constant during one year at 1800 W since the start 010917. After one year the power was decreased with about 20 W. After another year the power was decreased with about 40 W. The latest reduction of power was made at the beginning of September year 2004 (about 30 W). After this reduction the power of the canister in hole 1 is about 1710 W.

The power of the canister is determined in two ways. The first determination is made by direct measuring of the power, while the second one is determined from measurement of the energy used for heating the canister. For this canister yield the two ways of determine the power similar results.

5.2.6 Temperature on the canister surface (App. 1\pages 99-100)

The first diagram shows the maximum temperature, measured with the optical cables placed on the surface of the canister, plotted as function of time. The present maximum measured temperature on the canister surface is about 75 °C. The second diagram shows the distribution of the temperature along the optical cables at the end of this measuring period. With no damages on the optical cables this plot should have four curves. Only one curve with relevant values is presented here which indicates that the optical cables are damaged. The length of the cables on the canister surface is about 20 m. The variation of a few degrees is caused by the difference in temperature in the center and ends of the canister. The curves may thus be further corrected after completed calibration.

5.3 Deposition hole 3

5.3.1 Total pressure

Geokon (App. 2\pages 103-105)

Most of the sensors placed in block C1 and block R10 yield an increase in total pressure at the end of this measuring period due to the closing of the drainage.

Much lower pressure is registered from hole 3 (compare to hole 1) with maximum pressure 4.1 MPa registered by two transducers. Eight out of 16 transducers show a pressure higher than 500 kPa. Except for the rapid increase of the pressure caused by the closing of the drainage only small changes of the pressure have been recorded during this measuring period.

Kulite (App. 2\pages 106-107)

The highest pressure, 1.5 MPa, is indicated from the peripheral placed transducers in block R10. The sudden change in pressure that occurs after about 180 days was probably caused by early data logger problems.

Six sensors are out of order since earlier and three sensors are showing negative pressures.

5.3.2 Relative humidity

Vaisala (App. 2\pages 108-111)

A significant drying of the bentonite close to the top of the canister is observed by the two transducers WBU30022 and WBU30023. An increased wetting of the bentonite can be observed by transducers placed in block R10 between the canister and the rock. The changes in the relative humidity in the buffer measured by the rest of the transducers are very small.

Eight transducers are out of order.

Rotronic (App. 2\pages 112-116)

Many Rotronic transducers in hole 3 have failed or increased the measured RH to 100%. The reason for this is unclear. Since there are no other signs of strong wetting, malfunction are more probable than strong wetting. Investigation is going on. One transducer (WBU30016) placed close to the canister in block R5 was indicating a drying of the bentonite until it failed.

Fifteen transducers are at present out of order.

5.3.3 Pore water pressure.

Geokon (App. 2\page 117)

All sensors yield very low pressure except for one sensor below the heater that yields a sudden increase to 220 kPa (questionable).

Kulite (App. 2\page 118)

UBU30004 yields a pressure of 440 kPa and this sensor is placed near the rock surface at the bottom of the deposition hole. The other sensors yield very low pressures.

5.3.4 Temperature in the buffer (App. 2\pages 119-123 and 126)

The latest measured temperature ranges from 38 °C (in the periphery of the upper bentonite cylinder C4) to a temperature of 83.2 °C in the center close to the canister. The highest temperature gradient is 0.59 °C/cm (block R5). There have appeared some problems with some data scan units, which explains the noise in some curves.

28 sensors are out of order.

5.3.5 Canister power (App. 2\page 127)

The power of the canister in hole 3 has been kept constant at 1800 W from the start 011011 until 020917, when the power was decreased with about 20 W. Some initial problems have been overcome. After two years (September 2003) the power was decreased with about 40 W to 1740 W. At the beginning of September year 2004 the power was decreased with about 30 W to 1710 W.

For this canister yield the two ways of determine the power similar results, see also section 2.1.15.

5.3.6 Temperature on the canister surface (App. 2\pages 128-129)

The first diagram shows the maximum temperature plotted as a function of time. The maximum measured temperature on the canister surface is about 100 °C. The second diagram shows the distribution of the temperature along the cables. See also chapter 5.2.6.

5.4 Deposition hole 2

5.4.1 Canister power (App. 3\page 134)

The power of the canister in hole 2 has been kept constant at 1800 W from the start 010924 until 020917, when the power was decreased with about 20 W. After two years (September 2003) the power was decreased with about 40 W to 1740 W. The interruption in the curve between days 409 and 456 is caused by data collection problems. At the beginning of September year 2004 the power was decreased with about 40 W to 1710 W.

For this canister the two ways of determine the power did not yield similar results from day 440 to day 650. The power determined from energy measurements indicated about 150 W higher than the direct measurement. When this was found out the power was adjusted. After this adjustment the two ways of determine the power gave similar results.

5.4.2 Temperature on the canister surface (App. 3\pages 135-137)

See chapter 5.2.6. The maximum measured temperature on the canister surface is at present 91 °C. The reason for the unexpected increase in temperature after 450 days is the difficulties with the measurement of the power (see chapter 5.2.5). The actual power at that time was probably higher than 1800 W.

The thermocouple TBU10006 placed on top of the canister is measuring a temperature of about 87 °C.

5.5 Deposition hole 4

5.5.1 Canister power (App. 3\page 139)

The power of the canister in hole 4 has been kept constant at 1800 W from the start 011022 until 020917, when the power was decreased with about 20 W. After two years (September 2003) the power was decreased with about 40 W to 1740 W.

In the beginning of September year 2004 the power was decreased with about 40 W to 1710 W.

For this canister the two ways of determine the power did not yield similar results from day 140 to day 440. The power determined from energy measurement indicates about 100 W higher than the direct measurement. After day 440 the two measurements give similar results.

5.5.2 Temperature on the canister surface (App. 3\pages 140-141)

See chapter 5.2.6. The maximum measured temperature on the canister surface is 88 °C. The plot is indicating that the optical cables might be broken. A further investigation will be made to find out if this is the case.

5.6 Backfill in Section1

5.6.1 Total pressure in the backfill

Geokon (App. 4\pages 145-146)

All these sensors yield high increase in total pressure at the end of this measuring period due to the closing of the drainage. The measuring range is between 1.6 MPa to 2.4 MPa.

PBA10015 has stopped to work at the end of this measuring period.

Kulite (App.4 \pages 147-148)

These measurements yield rather small increase in total pressure until the drainage of the tunnel was closed. The maximum pressure recorded with PBA10013 was about 500 kPa. The transducer stopped functioning after the rapid increase in pressure. Transducer PBA10013 is placed 1.7 m above the bentonite surface in hole 3.

Eight transducers are out of order.

5.6.2 Suction in the backfill (App. 4\pages 149-155)

The suction in the backfill is measured with Wescor psychrometers. The steady but slow wetting (decrease in suction) observed in about 50% of the sensors continues. 7 sensors close to the roof and walls of the tunnel and one sensor just above the buffer in hole 1 indicate fast wetting that has gone close to water saturation (less than 1000 kPa suction). Also the transducer placed just inside the plug has reached a suction value that indicates saturation. In connection with the closing of the drainage, a very rapid decrease in suction was recorded by many of the installed psychrometers.

Thirteen transducers are out of order, most of them due to water saturation.

5.6.3 Pore water pressure in the backfill

Geokon (App. 4\pages 156-157)

All these sensors also yield high increase in pore pressure at the end of this measuring period due to the closing of the drainage. Many of the transducers are recording pressures up to 2,3 MPa.

Kulite (App. 4\pages 158-159)

Also some of these transducers are recording very high water pressure after the closing of the drainage. Eight transducers are out of order.

5.6.4 Temperature in the backfill (App. 4\pages 160-164)

The temperature in the backfill ranges from 18 to 35 degrees. The highest temperature is as expected measured above the buffer in hole 3.

5.7 Temperature in the rock

5.7.1 Near hole 1 (App. 1\pages 95-97)

The maximum temperature measured in the rock is 38.6 degrees (TROA1030). The sensor is located 2.038 m from the center of the canister in deposition hole 1. Note that this temperature is about 8 degrees lower than in the rock around the other holes.

5.7.2 Near hole 2 (App. 3\page 133)

The maximum temperature in the rock (46.8 degrees) is measured by TROA1820 located 2.490 m from the center of the canister in deposition hole 2.

5.7.3 Near hole 3 (App. 2\pages 124-125)

The maximum temperature in the rock (48.8 degrees) is measured by TROA2120 located 1.967 m from the center of the canister in deposition hole 3.

5.7.4 Near hole 4 (App. 3\page 138)

The maximum temperature in the rock (46.6 degrees) is measured by TROA3030 located 2.034 m from the center of the canister in deposition hole 4.

6 Location of instruments in Section 2

6.1 Strategy for describing the position of each device in the bentonite and rock in and around the deposition holes

The deposition holes in Section 2 are termed DA3551G01 and DA3545G01, hole number 5 and 6 respectively according to Figure 1-1.

Deposition hole 5 has been instrumented in the same way as the two inner deposition holes, 1 and 3 i.e. measurements have been done in four vertical sections A, B, C and D according to Figure 4-1. (See chapter 4-1)

Deposition hole 6 has, however, been instrumented according to another strategy. The instruments have been placed in eight directions, where four directions are represented in each instrumented block, see Figure 6-1.

Direction A and C are placed in the tunnels axial direction with A headed against the end of the tunnel i.e. almost to the West, see Figure 2-1.

Every instrument placed in the buffer is named with a unique name consisting of 1 letter describing the type of measurement, 1 letter describing where the measurement takes place (buffer, rock), 1 figure denoting the deposition hole (5-6) and 2 figures specifying the instrument according to separate lists (see Table 6-1 to 6-11). Every instrument position is then described with three coordinates according to Figure 2-1.

The bentonite blocks are called cylinders and rings. The cylinders are numbered C1-C4 and the rings R1-R10 respectively, see Figure 4-1.

Thermocouples in the rock are placed on 3 levels in each deposition hole (bottom, 3 m and 6 m level). Thermocouples are placed in the bottom of the deposition holes in a vertical hole at the center of the deposition hole. On level 3 m and 6 m the thermocouples are placed in two vertical directions perpendicular to each other.

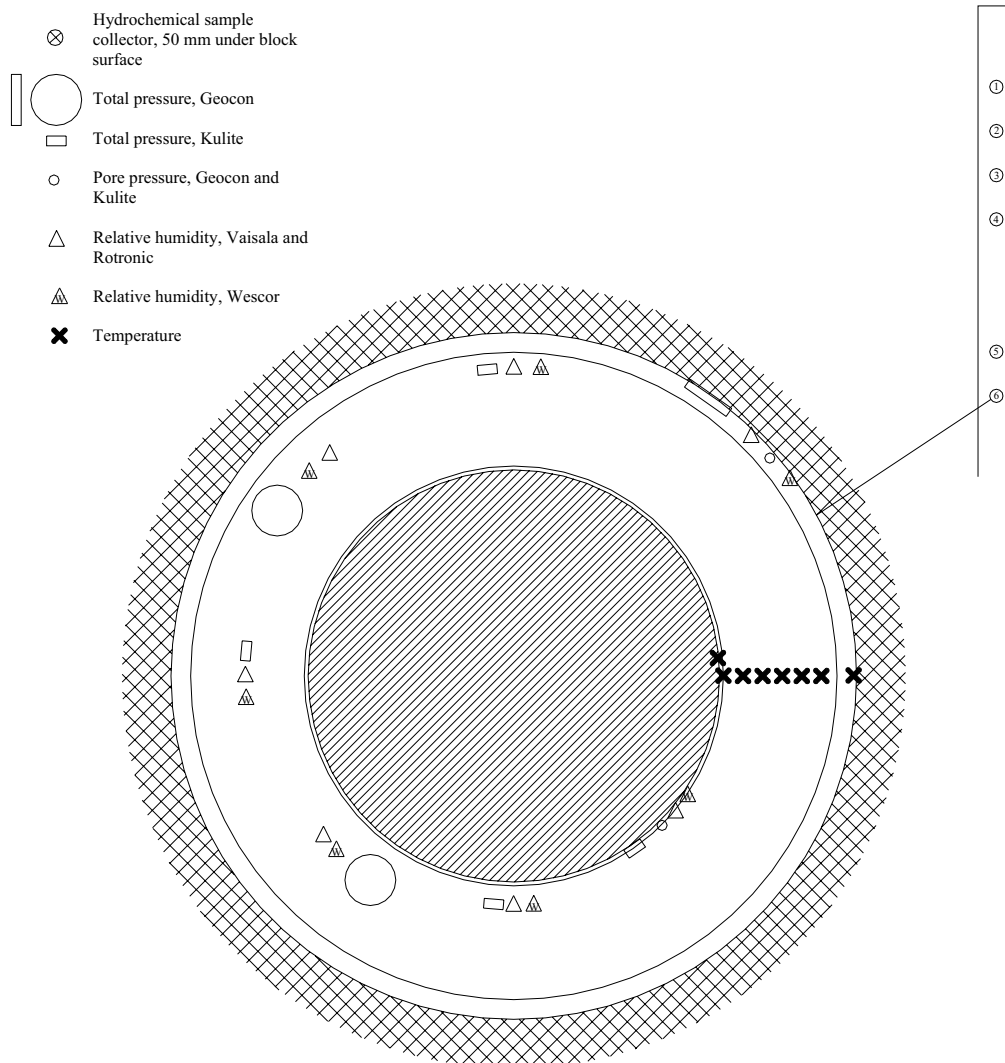

Figure 6-1 Schematic view over the instruments positions in deposition hole 6. The instruments are placed in eight vertical sections, where four sections are represented in each instrumented block.

6.2 Position of each instrument in the bentonite in hole 5 (DA3551G01)

The instruments are located according to the same system as those in hole 1 and hole 3.

The positions of each instrument are described in Tables 6-1 to 6-4. These tables have been updated since the last data report (Sensors data report No 7).

The positions of 10 Wescor psychrometer sensors were determined after inflow measurement on the wall of the deposition hole. The position of these sensors are described in Table 6-5

Table 6-1 Numbering and position of instruments for measuring temperature (T) in the buffer in hole 5.

Typ and number	Block	Instrument position in block				Fabricate	Remark
		Direction	α degree	r m	Z m		
TB501	Cyl. 1	Center	270	0,050	0,080	Pentronic	
TB502	Cyl. 1	Center	270	0,060	0,250	Pentronic	
TB503	Cyl. 1	Center	270	0,070	0,450	Pentronic	
TB504	Cyl. 1	A	355	0,525	0,450	Pentronic	On canister
TB505	Cyl. 1	A	355	0,685	0,450	Pentronic	
TB506	Cyl. 1	B	85	0,685	0,450	Pentronic	
TB507	Cyl. 1	C	175	0,685	0,450	Pentronic	
TB508	Cyl. 1	D	270	0,585	0,450	Pentronic	
TB509	Cyl. 1	D	270	0,685	0,450	Pentronic	
TB510	Cyl. 1	D	270	0,785	0,450	Pentronic	
TB511	Ring 5	A	0	0,525	2,950	Pentronic	On canister
TB512	Ring 5	A	0	0,685	2,986	Pentronic	
TB513	Ring 5	B	85	0,585	2,986	Pentronic	
TB514	Ring 5	B	85	0,685	2,986	Pentronic	
TB515	Ring 5	B	85	0,785	2,986	Pentronic	
TB516	Ring 5	C	175	0,585	2,986	Pentronic	
TB517	Ring 5	C	175	0,685	2,986	Pentronic	
TB518	Ring 5	C	175	0,735	2,986	Pentronic	
TB519	Ring 5	D	270	0,585	2,986	Pentronic	
TB520	Ring 5	D	270	0,635	2,986	Pentronic	
TB521	Ring 5	D	270	0,685	2,986	Pentronic	
TB522	Ring 5	D	270	0,735	2,986	Pentronic	
TB523	Ring 5	D	270	0,785	2,986	Pentronic	
TB524	Ring 10	A	0	0,525	5,150	Pentronic	On canister
TB525	Ring 10	A	0	0,685	5,543	Pentronic	
TB526	Ring 10	D	270	0,585	5,543	Pentronic	
TB527	Ring 10	D	270	0,685	5,543	Pentronic	
TB528	Ring 10	D	270	0,785	5,543	Pentronic	
TB529	Cyl. 3	A	0	0,785	6,353	Pentronic	
TB530	Cyl. 3	B	95	0,585	6,353	Pentronic	
TB531	Cyl. 3	C	185	0,585	6,353	Pentronic	
TB532	Cyl. 4	A	0	0,785	7,060	Pentronic	

Table 6-2 Numbering and position of instruments for measuring total pressure (P) in the buffer in hole 5.

Typ and number	Block	Instrument position in block				Fabricate	Remark
		Direction	α degree	r m	Z m		
PB501	Cyl. 1	Center	0	0,000	0,000	Geokon	Bottom
PB502	Cyl. 1	Center	0	0,100	0,500	Geokon	
PB503	Cyl. 1	A	5	0,585	0,340	Kulite	Vertical
PB504	Cyl. 1	A	5	0,685	0,340	Kulite	Vertical
PB505	Cyl. 1	A	5	0,785	0,340	Kulite	Vertical
PB506	Cyl. 1	B	95	0,635	0,500	Geokon	
PB507	Cyl. 1	B	105	0,735	0,500	Geokon	
PB508	Cyl. 1	C	185	0,635	0,500	Geokon	
PB509	Cyl. 1	C	195	0,735	0,500	Geokon	
PB510	Ring 5	A	10	0,535	2,876	Kulite	In the slot
PB511	Ring 5	A	10	0,685	3,036	Geokon	
PB512	Ring 5	A	5	0,825	2,876	Kulite	In the slot
PB513	Ring 5	B	95	0,635	3,036	Geokon	
PB514	Ring 5	B	105	0,785	3,036	Geokon	
PB515	Ring 5	C	190	0,635	3,036	Geokon	
PB516	Ring 5	C	190	0,825	2,876	Kulite	In the slot
PB517	Ring 10	Center	0	0,050	5,593	Geokon	
PB518	Ring 10	A	10	0,585	5,433	Kulite	Vertical
PB519	Ring 10	A	10	0,685	5,433	Kulite	Vertical
PB520	Ring 10	A	10	0,785	5,433	Kulite	Vertical
PB521	Ring 10	B	95	0,635	5,593	Geokon	
PB522	Ring 10	B	105	0,735	5,593	Geokon	
PB523	Ring 10	C	180	0,635	5,593	Geokon	
PB524	Ring 10	C	190	0,735	5,593	Geokon	
PB525	Cyl. 3	Center	0	0,100	6,603	Geokon	
PB526	Cyl. 3	A	5	0,585	6,603	Geokon	
PB527	Cyl. 4	Center	0	0,100	7,110	Geokon	

Table 6-3 Numbering and position of instruments for measuring pore water pressure (U) in the buffer in hole 5.

Typ and number	Block	Instrument position in block				Fabricate	Remark
		Direction	α degree	r m	Z m		
UB501	Cyl. 1	Center	90	0,050	0,250	Kulite	
UB502	Cyl. 1	Center	90	0,100	0,050	Geokon	
UB503	Cyl. 1	A	355	0,585	0,250	Geokon	
UB504	Cyl. 1	A	355	0,785	0,340	Kulite	
UB505	Ring 5	A	355	0,585	2,786	Geokon	
UB506	Ring 5	A	355	0,785	2,876	Kulite	
UB507	Ring 5	B	85	0,535	2,876	Kulite	In the slot
UB508	Ring 5	B					Not installed
UB509	Ring 5	C	175	0,535	2,786	Geokon	In the slot
UB510	Ring 5	C	175	0,825	2,786	Geokon	In the slot
UB511	Ring 10	A	355	0,585	5,433	Kulite	
UB512	Ring 10	A	355	0,785	5,433	Kulite	
UB513	Cyl. 3	Center					Not installed
UB514	Cyl. 4	Center	90	0,100	6,860	Geokon	

Table 6-4 Numbering and position of instruments for measuring water content (W) in the buffer in hole 5.

Mark	Block	Instrument position in block			Z	Fabricate	Remark
		Direction	α	r			
			degree	m	m		
WB501	Cyl. 1	Center	180	0,050	0,250	Rotronic	
WB502	Cyl. 1	Center	180	0,100	0,050	Rotronic	
WB503	Cyl. 1	Center	0	0,400	0,250	Rotronic	
WB504	Cyl. 1	A	350	0,585	0,340	Vaisala	
WB505	Cyl. 1	A	350	0,685	0,340	Vaisala	
WB506	Cyl. 1	A	350	0,785	0,340	Vaisala	
WB507	Cyl. 1	B	80	0,585	0,340	Vaisala	
WB508	Cyl. 1	B	80	0,685	0,250	Rotronic	
WB509	Cyl. 1	B	80	0,785	0,250	Rotronic	
WB510	Cyl. 1	C	170	0,585	0,250	Rotronic	
WB511	Cyl. 1	C	170	0,685	0,250	Rotronic	
WB512	Cyl. 1	C	170	0,785	0,250	Rotronic	
WB513	Ring 5	A	350	0,585	2,876	Vaisala	
WB514	Ring 5	A	350	0,685	2,876	Vaisala	
WB515	Ring 5	A	350	0,785	2,876	Vaisala	
WB516	Ring 5	B	80	0,535	2,786	Rotronic	In the slot
WB517	Ring 5	B	80	0,685	2,786	Rotronic	
WB518	Ring 5	B	80	0,785	2,786	Rotronic	
WB519	Ring 5	C	180	0,535	2,876	Vaisala	In the slot
WB520	Ring 5	C	180	0,685	2,876	Vaisala	
WB521	Ring 5	C	180	0,785	2,786	Rotronic	
WB522	Ring 10	Center	180	0,050	5,433	Vaisala	
WB523	Ring 10	A	0	0,262	5,433	Vaisala	
WB524	Ring 10	A	350	0,585	5,433	Vaisala	
WB525	Ring 10	A	350	0,685	5,433	Vaisala	
WB526	Ring 10	A	350	0,785	5,433	Vaisala	
WB527	Ring 10	B	80	0,585	5,343	Rotronic	
WB528	Ring 10	B	80	0,685	5,343	Rotronic	
WB529	Ring 10	B	80	0,785	5,343	Rotronic	
WB530	Ring 10	C	170	0,585	5,433	Vaisala	
WB531	Ring 10	C	170	0,785	5,343	Rotronic	
WB532	Cyl. 3	Center	270	0,100	6,353	Vaisala	
WB533	Cyl. 3	A	350	0,585	6,353	Vaisala	
WB534	Cyl. 3	B	90	0,585	6,353	Vaisala	
WB535	Cyl. 3	C	180	0,585	6,353	Rotronic	
WB536	Cyl. 4	Center	180	0,100	6,790	Vaisala	
WB537	Cyl. 4	Center	270	0,100	6,950	Vaisala	

Table 6-5 Numbering and position of instruments for measuring water content (W) in the buffer in hole 5. The positions were determined after inflow measurements.

Mark	Block	Instrument position in block			Z	Fabricate	Remark
		Direction	α	r			
			degree	m	m		
WB538	Ring 3	C-D	225	0,775	1,624	Wescor	
WB539	Ring 3	C-D	235	0,68	1,624	Wescor	
WB540	Ring 3	C-D	245	0,585	1,624	Wescor	
WB541	Ring 3	C-D	255	0,68	1,624	Wescor	
WB542	Ring 3	C-D	265	0,775	1,624	Wescor	
WB543	Ring 8	C-D	225	0,775	4,173	Wescor	
WB544	Ring 8	C-D	235	0,68	4,173	Wescor	
WB545	Ring 8	C-D	245	0,585	4,173	Wescor	
WB546	Ring 8	C-D	255	0,68	4,173	Wescor	
WB547	Ring 8	C-D	265	0,775	4,173	Wescor	

6.3 Position of each instrument in the bentonite in hole 6 (DA3545G01)

The instruments are located in one main level in the blocks, 250 mm, from the upper surface. The upper blocks, C2, C3 and C4 are instrumented in the same way as those in deposition hole 5. The positions of each instrument are described in Tables 6-6 to 6-9. These tables have been updated since the last data report (Sensors data report No 7).

The position of 10 Wescor psychrometers and 5 Vaisala relative humidity sensors were determined after inflow measurement. The positions of these transducers are described in Table 6-10.

Table 6-6 Numbering and position of instruments for measuring temperature (T) in the buffer in hole 6.

Typ and number	Block	Instrument position in block				Fabricate	Remark
		Direction	α degree	r m	Z m		
TB601	Cyl. 1	Center	45	0,050	0,385	Pentronic	
TB602	Cyl. 1	Center	315	0,050	0,260	Pentronic	
TB603	Cyl. 1	Center	0	0,050	0,135	Pentronic	
TB604	Ring 1	D	270	0,535	0,770	Pentronic	
TB605	Ring 1	D	270	0,585	0,770	Pentronic	
TB606	Ring 1	D	270	0,635	0,770	Pentronic	
TB607	Ring 1	D	270	0,685	0,770	Pentronic	
TB608	Ring 1	D	270	0,735	0,770	Pentronic	
TB609	Ring 1	D	270	0,785	0,770	Pentronic	
TB610	Ring 1	D	270	0,825	0,753	Pentronic	On rock
TB611	Ring 1	D	0	0,525	0,753	Pentronic	On canister
TB612	Ring 5	D	270	0,535	2,795	Pentronic	
TB613	Ring 5	D	270	0,585	2,795	Pentronic	
TB614	Ring 5	D	270	0,635	2,795	Pentronic	
TB615	Ring 5	D	270	0,685	2,795	Pentronic	
TB616	Ring 5	D	270	0,735	2,795	Pentronic	
TB617	Ring 5	D	270	0,785	2,795	Pentronic	
TB618	Ring 5	D	270	0,825	2,753	Pentronic	On rock
TB619	Ring 5	D	0	0,525	2,753	Pentronic	On canister
TB620	Ring 8	D	270	0,535	4,324	Pentronic	
TB621	Ring 8	D	270	0,585	4,324	Pentronic	
TB622	Ring 8	D	270	0,635	4,324	Pentronic	
TB623	Ring 8	D	270	0,685	4,324	Pentronic	
TB624	Ring 8	D	270	0,735	4,324	Pentronic	
TB625	Ring 8	D	270	0,785	4,324	Pentronic	
TB626	Ring 8	D	270	0,825	4,253	Pentronic	On rock
TB627	Ring 8	D	0	0,525	4,253	Pentronic	On canister
TB628	Cyl. 3	A	0	0,785	6,366	Pentronic	
TB629	Cyl. 3	B	95	0,585	6,366	Pentronic	
TB630	Cyl. 3	C	185	0,585	6,366	Pentronic	
TB631	Cyl. 4	Center	225	0,100	7,071	Pentronic	
TB632	Cyl. 4	A	0	0,785	7,071	Pentronic	

Table 6-7 Numbering and position of instruments for measuring total pressure (P) in the buffer in hole 6.

Typ and number	Block	Instrument position in block				Fabricate	Remark
		Direction	α degree	r m	Z m		
PB601	Cyl. 1	Center	315	0,210	0,510	Geokon	
PB602	Cyl. 1	B	80	0,685	0,260	Kulite	Vertical
PB603	Ring 1	A	10	0,785	0,770	Kulite	Vertical
PB604	Ring 1	B	80	0,685	0,770	Kulite	Vertical
PB605	Ring 1	C	170	0,585	0,770	Kulite	Vertical
PB606	Ring 2	AB	55	0,735	1,534	Geokon	
PB607	Ring 2	BC	145	0,635	1,534	Geokon	
PB608	Ring 2	CD	215	0,535	1,284	Kulite	In the slot
PB609	Ring 2	DA	325	0,875	1,253	Geokon	At rock
PB610	Ring 5	A	10	0,785	2,795	Kulite	Vertical
PB611	Ring 5	B	80	0,685	2,795	Kulite	Vertical
PB612	Ring 5	C	170	0,585	2,795	Kulite	Vertical
PB613	Ring 6	AB	55	0,785	3,550	Geokon	
PB614	Ring 6	BC	145	0,635	3,550	Geokon	
PB615	Ring 6	CD	215	0,535	3,300	Kulite	In the slot
PB616	Ring 6	DA	325	0,875	3,253	Geokon	At rock
PB617	Ring 8	A	10	0,785	4,324	Kulite	Vertical
PB618	Ring 8	B	80	0,685	4,324	Kulite	Vertical
PB619	Ring 8	C	170	0,585	4,324	Kulite	Vertical
PB620	Ring 9	AB	55	0,735	5,084	Geokon	
PB621	Ring 9	BC	145	0,635	5,084	Geokon	
PB622	Ring 9	CD	215	0,535	4,834	Kulite	In the slot
PB623	Ring 9	DA	325	0,875	4,753	Geokon	At rock
PB624	Cyl. 4	Center	135	0,585	7,121	Kulite	
PB625	Cyl. 3	Center	0	0,100	6,616	Geokon	
PB626	Cyl. 3	A	5	0,585	6,616	Geokon	
PB627	Cyl. 4	Center	0	0,100	7,121	Geokon	

Table 6-8 Numbering and position of instruments for measuring pore water pressure (U) in the buffer in hole 6.

Typ and number	Block	Instrument position in block				Fabricate	Remark
		Direction	α degree	r m	Z m		
UB601	Cyl. 1	Center	280	0,210	0,260	Kulite	
UB602	Cyl. 1	B	95	0,685	0,260	Geokon	
UB603	Ring 2	CD	225	0,535	1,284	Geokon	In the slot
UB604	Ring 2	DA	310	0,875	1,253	Kulite	At the rock
UB605	Ring 5	C	190	0,585	2,795	Geokon	
UB606	Ring 5	A	350	0,785	2,795	Kulite	
UB607	Ring 6	AB	35	0,735	3,300	Kulite	
UB608	Ring 6	BC	125	0,635	3,300	Kulite	
UB609	Ring 6	CD	225	0,535	3,300	Geokon	In the slot
UB610	Ring 6	DA	310	0,875	3,253	Geokon	At the rock
UB611	Ring 9	CD	225	0,535	4,834	Geokon	In the slot
UB612	Ring 9	DA	310	0,875	4,753	Kulite	At the rock
UB613	Cyl. 3	Center	135	0,100	6,366	Kulite	
UB614	Cyl. 4	Center	90	0,100	6,961	Kulite	

Table 6-9 Numbering and position of instruments for measuring water content (W) in the buffer in hole 6.

Typ and number	Block	Instrument position in block				Fabricate	Remark
		Direction	α	r	Z		
			degree	m	m		
WB601	Cyl. 1	Center	135	0,050	0,260	Rotronic	
WB602	Cyl. 1	Center	225	0,050	0,260	Wescor	
WB603	Cyl. 1	Center	260	0,210	0,260	Wescor	
WB604	Cyl. 1	Center	270	0,210	0,260	Rotronic	
WB605	Cyl. 1	B	90	0,685	0,260	Wescor	
WB606	Cyl. 1	B	100	0,685	0,260	Rotronic	
WB607	Ring 1	B	90	0,685	0,770	Vaisala	
WB608	Ring 1	B	95	0,685	0,770	Wescor	
WB609	Ring 1	C	180	0,585	0,770	Vaisala	
WB610	Ring 1	C	185	0,585	0,770	Wescor	
WB611	Ring 1	A	355	0,785	0,770	Wescor	
WB612	Ring 1	A	360	0,785	0,770	Vaisala	
WB613	Ring 2	AB	40	0,735	1,284	Rotronic	
WB614	Ring 2	AB	45	0,735	1,284	Wescor	
WB615	Ring 2	BC	130	0,635	1,284	Rotronic	
WB616	Ring 2	BC	135	0,635	1,284	Wescor	
WB617	Ring 2	CD	230	0,535	1,284	Rotronic	In the slot
WB618	Ring 2	CD	235	0,535	1,284	Wescor	In the slot
WB619	Ring 2	DA	305	0,875	1,253	Wescor	At rock
WB620	Ring 2	DA	315	0,875	1,253	Rotronic	At rock
WB621	Ring 5	B	90	0,685	2,795	Rotronic	
WB622	Ring 5	B	95	0,685	2,795	Wescor	
WB623	Ring 5	C	180	0,585	2,795	Rotronic	
WB624	Ring 5	C	185	0,585	2,795	Wescor	
WB625	Ring 5	A	355	0,785	2,795	Wescor	
WB626	Ring 5	A	360	0,785	2,795	Rotronic	
WB627	Ring 6	AB	40	0,735	3,300	Vaisala	
WB628	Ring 6	AB	45	0,735	3,300	Wescor	
WB629	Ring 6	BC	130	0,635	3,300	Vaisala	
WB630	Ring 6	BC	135	0,635	3,300	Wescor	
WB631	Ring 6	CD	230	0,535	3,300	Vaisala	In the slot
WB632	Ring 6	CD	235	0,535	3,300	Wescor	In the slot
WB633	Ring 6	DA	305	0,875	3,253	Wescor	At rock
WB634	Ring 6	DA	315	0,875	3,253	Vaisala	At rock
WB635	Ring 8	B	90	0,685	4,324	Rotronic	
WB636	Ring 8	B	95	0,685	4,324	Wescor	
WB637	Ring 8	C	180	0,585	4,324	Rotronic	
WB638	Ring 8	C	185	0,585	4,324	Wescor	
WB639	Ring 8	A	355	0,785	4,324	Wescor	
WB640	Ring 8	A	360	0,785	4,324	Rotronic	
WB641	Ring 9	AB	40	0,735	4,834	Rotronic	
WB642	Ring 9	AB	45	0,735	4,834	Wescor	
WB643	Ring 9	BC	130	0,635	4,834	Vaisala	
WB644	Ring 9	BC	135	0,635	4,834	Wescor	
WB645	Ring 9	CD	230	0,535	4,834	Vaisala	In the slot
WB646	Ring 9	CD	235	0,535	4,834	Wescor	In the slot
WB647	Ring 9	DA	305	0,875	4,753	Wescor	At rock
WB648	Ring 9	DA	315	0,875	4,753	Vaisala	At rock
WB649	Ring 10	Center	90	0,050	5,439	Vaisala	
WB650	Ring 10	Center	270	0,210	5,439	Vaisala	
WB651	Cyl. 3	Center	225	0,100	6,366	Rotronic	
WB652	Cyl. 3	B	90	0,585	6,366	Vaisala	
WB653	Cyl. 3	C	180	0,585	6,366	Rotronic	
WB654	Cyl. 3	A	350	0,585	6,366	Vaisala	
WB655	Cyl. 4	Center	180	0,100	6,801	Rotronic	
WB656	Cyl. 4	Center	270	0,100	6,961	Vaisala	

Table 6-10 Numbering and position of instruments for measuring water content (W) in the buffer in hole 6. The positions were determined after inflow measurements.

Typ and number	Block	Instrument position in block					Remark
		Direction	α degree	r m	Z m	Fabricate	
WB657	Ring 6	C	190	0,625	3,300	Wescor	
WB658	Ring 6	C	190	0,725	3,300	Wescor	
WB659	Rock	C	190	0,900	3,100	Wescor	
WB660	Rock	C	190	0,925	3,250	Wescor	
WB661	Rock	C	190	0,975	3,400	Wescor	
WB662	Ring 8	D	280	0,625	4,324	Wescor	
WB663	Ring 8	D	280	0,725	4,324	Wescor	
WB664	Rock	D	280	0,900	4,100	Wescor	
WB665	Rock	D	280	0,925	4,250	Wescor	
WB666	Rock	D	280	0,975	4,400	Wescor	
WB667	Cyl.1	D	280	0,685	0,260	Vaisala	
WB668	Ring 6	C	200	0,625	3,300	Vaisala	
WB669	Ring 6	C	200	0,725	3,300	Vaisala	
WB670	Ring 8	D	290	0,625	4,324	Vaisala	
WB671	Ring 8	D	290	0,725	4,324	Vaisala	

6.4 Instruments on the canister surface in holes 5-6

A system for measuring the temperature with optical cables on the surface of the canisters is used in the same way as for the canisters in Section 1. The system is described in chapter 4.4.

In addition to the optical cables three thermocouples (TB504, TB511 and TB524) in deposition hole 5 and three thermocouples (TB611, TB619 and TB627) in deposition hole 6 are fixed to the surface of the canister (see Table 6-1 and 6-6).

6.5 Position of temperature sensors in the rock

Thermocouples are placed on 3 levels in each deposition hole (bottom, 3 m and 6 m level). On level 3 m and 6 m the thermocouples are placed in two directions perpendicular to each other.

The positions are described in Table 6-11.

Table 6-11. Numbering and position of temperature sensors in the rock.

Type and number	Depth from rock surface(m)	α degree	r m	Z m	Remark
Measured from DA3551G01(Hole 5)					
TR5011	1,000	0°	0,000	-1,000	Bottom
TR5012	0,500	0°	0,000	-0,500	Bottom
TR5013	0,200	0°	0,000	-0,200	Bottom
TR5014	0,000	0°	0,000	0,000	Bottom
TR5021	2,200	180°	3,950	6,000	East
TR5022	1,100	180°	2,850	6,000	East
TR5023	0,600	180°	2,350	6,000	East
TR5024	0,200	180°	1,950	6,000	East
TR5025	0,000	180°	1,750	6,000	East
TR5031	2,200	90°	3,950	6,000	South
TR5032	1,100	90°	2,850	6,000	South
TR5033	0,600	90°	2,350	6,000	South
TR5034	0,200	90°	1,950	6,000	South
TR5035	0,000	90°	1,750	6,000	South
TR5041	2,200	180°	3,950	3,000	East
TR5042	1,100	180°	2,850	3,000	East
TR5043	0,600	180°	2,350	3,000	East
TR5044	0,200	180°	1,950	3,000	East
TR5045	0,000	180°	1,750	3,000	East
TR5051	2,200	90°	3,950	3,000	South
TR5052	1,100	90°	2,850	3,000	South
TR5053	0,600	90°	2,350	3,000	South
TR5054	0,200	90°	1,950	3,000	South
TR5055	0,000	90°	1,750	3,000	South
Measured from DA3545G01(Hole 6)					
TR6011	1,000	0	0,000	-1,000	Bottom
TR6012	0,500	0	0,000	-0,500	Bottom
TR6013	0,200	0	0,000	-0,200	Bottom
TR6014	0,000	0	0,000	0,000	Bottom
TR6021	2,200	90°	3,950	6,000	South
TR6022	1,100	90°	2,850	6,000	South
TR6023	0,600	90°	2,350	6,000	South
TR6024	0,200	90°	1,950	6,000	South
TR6025	0,000	90°	1,750	6,000	South
TR6031	2,200	360°	3,950	6,000	West
TR6032	1,100	360°	2,850	6,000	West
TR6033	0,600	360°	2,350	6,000	West
TR6034	0,200	360°	1,950	6,000	West
TR6035	0,000	360°	1,750	6,000	West
TR6041	2,200	90°	3,950	3,000	South
TR6042	1,100	90°	2,850	3,000	South
TR6043	0,600	90°	2,350	3,000	South
TR6044	0,200	90°	1,950	3,000	South
TR6045	0,000	90°	1,750	3,000	South
TR6051	2,200	360°	3,950	3,000	West
TR6052	1,100	360°	2,850	3,000	West
TR6053	0,600	360°	2,350	3,000	West
TR6054	0,200	360°	1,950	3,000	West
TR6055	0,000	360°	1,750	3,000	West

6.6 Strategy for describing the position of each device in the backfill in section 2

The strategy for instrumentation of the backfill in Section 2 is the same as in Section 1 and is described in chapter 4.6.

6.7 Position of each instrument in the backfill in Section 2

The positions of each instrument are described in Tables 6-12 to 6-15.

Table 6-12 Numbering and position of instruments for measuring temperature (T) in the backfill in section 2.

Type and number	Instrument position			Fabricate	Remark
	Section	x	z		
		m	m	m	
TFA01	E, over dep.hole 5	0,0	2,3	3551,0	Pentronic
TFA02	E, over dep.hole 5	0,0	1,25	3551,0	Pentronic
TFA03	E, over dep.hole 5	0,0	-0,8	3551,0	Pentronic
TFA04	E, over dep.hole 5	-0,5	-2,6	3551,0	Pentronic
TFA05	E, over dep.hole 5	0,5	-2,6	3551,0	Pentronic
TFA06	E, over dep.hole 5	-1,25	0,0	3551,0	Pentronic
TFA07	E, over dep.hole 5	1,25	0,0	3551,0	Pentronic
TFA08	F, between dep.hole 5 and 6	0,0	1,0	3548,0	Pentronic
TFA09	F, between dep.hole 5 and 6	0,0	-1,25	3548,0	Pentronic
TFA10	E, over dep.hole 6	0,0	2,3	3545,0	Pentronic
TFA11	E, over dep.hole 6	0,0	1,25	3545,0	Pentronic
TFA12	E, over dep.hole 6	0,0	-0,8	3545,0	Pentronic
TFA13	E, over dep.hole 6	-0,5	-2,6	3545,0	Pentronic
TFA14	E, over dep.hole 6	0,5	-2,6	3545,0	Pentronic
TFA15	E, over dep.hole 6	-1,25	0,0	3545,0	Pentronic
TFA16	E, over dep.hole 6	1,25	0,0	3545,0	Pentronic

Table 6-13 Numbering and position of instruments for measuring total pressure (P) in the backfill in section 2.

Type and number	Instrument position			Fabricate	Remark
	Section	x	z		
		m	m	m	
PFA01	Inner part	0,0	0,0	3555,8	Kulite
PFA02	E, over dep.hole 5	0,0	0,0	3551,0	Geokon
PFA03	E, over dep.hole 5	0,0	-1,75	3551,0	Geokon
PFA04	E, over dep.hole 5	0,0	-2,6	3551,0	Geokon
PFA05	E, over dep.hole 5	0,0	-3,15	3551,0	Kulite
PFA06	E, over dep.hole 5	-2,3	0,0	3551,0	Kulite
PFA07	E, over dep.hole 5	0,0	2,3	3551,0	Kulite
PFA08	F, between dep.hole 5 and 6	0,0	0,0	3548,0	Geokon
PFA09	F, between dep.hole 5 and 6	0,0	-2	3548,0	Geokon
PFA10	E, over dep.hole 6	0,0	0,0	3545,0	Kulite
PFA11	E, over dep.hole 6	0,0	-1,75	3545,0	Kulite
PFA12	E, over dep.hole 6	0,0	-2,6	3545,0	Kulite
PFA13	E, over dep.hole 6	0,0	-3,15	3545,0	Geokon
PFA14	E, over dep.hole 6	-2,3	0,0	3545,0	Geokon
PFA15	E, over dep.hole 6	0,0	2,3	3545,0	Geokon
PFA16	In front of plug	0,0	0,0	3539,0	Kulite

Table 6-14 Numbering and position of instruments for measuring pore water pressure (U) in the backfill in section 2.

Type and number	Instrument position			Fabricate	Remark
	Section	x	z		
		m	m	m	
UFA01	Inner part	0,0	0,0	3555,8	Kulite
UFA02	Inner part	0,0	0,0	3554,1	Geokon
UFA03	E, over dep.hole 5	0,0	0,0	3551,0	Geokon
UFA04	E, over dep.hole 5	0,0	-1,75	3551,0	Kulite
UFA05	E, over dep.hole 5	0,0	-2,6	3551,1	Kulite
UFA06	E, over dep.hole 5	0,0	-3,15	3551,0	Kulite
UFA07	E, over dep.hole 5	0,0	-1,75	3551,0	Geokon
UFA08	E, over dep.hole 5	0,0	2,3	3551,0	Geokon
UFA09	F, between dep.hole 5 and 6	0,0	0,0	3548,0	Geokon
UFA10	F, between dep.hole 5 and 6	0,0	-2,0	3548,0	Geokon
UFA11	E, over dep.hole 6	0,0	0,0	3545,0	Geokon
UFA12	E, over dep.hole 6	0,0	-1,75	3545,0	Geokon
UFA13	E, over dep.hole 6	0,0	-2,6	3545,0	Geokon
UFA14	E, over dep.hole 6	0,0	-3,15	3545,0	Geokon
UFA15	E, over dep.hole 6	-2,3	0,0	3545,0	Geokon
UFA16	E, over dep.hole 6	0,0	2,3	3545,0	Geokon
UFA17	In front of plug	-2,3	0,0	3551,0	Geokon
UFA18	In front of plug	0,0	0,0	3539,0	Geokon

Table 6-15 Numbering and position of instruments for measuring relative humidity (W) in the backfill in section 2.

Type and number	Instrument position			Fabricate	Remark	
	Section	x	z			y
		m	m	m		
WFA01	Inner part	0,0	0,0	3555,8	Wescor	
WFA02	Inner part	0,0	0,0	3554,1	Wescor	
WFA03	E, over dep.hole 5	0,0	2,3	3551,0	Wescor	
WFA04	E, over dep.hole 5	0,0	1,25	3551,0	Wescor	
WFA05	E, over dep.hole 5	0,0	0,0	3551,0	Wescor	
WFA06	E, over dep.hole 5	0,0	-0,8	3551,0	Wescor	
WFA07	E, over dep.hole 5	2,3	0,0	3545,0	Wescor	
WFA08	E, over dep.hole 5	0,0	-2,6	3550,9	Wescor	
WFA09	E, over dep.hole 5	0,0	-3,15	3551,0	Wescor	
WFA10	E, over dep.hole 5	-2,3	0,0	3551,0	Wescor	
WFA11	E, over dep.hole 5	-1,25	0,0	3551,0	Wescor	
WFA12	E, over dep.hole 5	1,25	0,0	3551,0	Wescor	
WFA13	E, over dep.hole 5	2,3	0,0	3551,0	Wescor	
WFA14	F, between dep.hole 5 and 6				Wescor	Not clear
WFA15	F, between dep.hole 5 and 6	0,0	1,0	3548,0	Wescor	
WFA16	F, between dep.hole 5 and 6	0,0	0,0	3548,0	Wescor	
WFA17	F, between dep.hole 5 and 6	0,0	-0,55	3548,0	Wescor	
WFA18	F, between dep.hole 5 and 6	-1,25	0,0	3548,0	Wescor	
WFA19	F, between dep.hole 5 and 6	1,25	0,0	3548,0	Wescor	
WFA20	E, over dep.hole 6	0,0	2,3	3545,0	Wescor	
WFA21	E, over dep.hole 6	0,0	1,25	3545,0	Wescor	
WFA22	E, over dep.hole 6	0,0	0,0	3545,0	Wescor	
WFA23	E, over dep.hole 6	0,0	-0,8	3545,0	Wescor	
WFA24	E, over dep.hole 6	0,0	-1,75	3545,0	Wescor	
WFA25	E, over dep.hole 6	0,0	-2,6	3545,0	Wescor	
WFA26	E, over dep.hole 6	0,0	-3,15	3545,0	Wescor	
WFA27	E, over dep.hole 6	-2,3	0,0	3545,0	Wescor	
WFA28	E, over dep.hole 6	-1,25	0,0	3545,0	Wescor	
WFA29	E, over dep.hole 6	1,25	0,0	3545,0	Wescor	
WFA30	E, over dep.hole 6	0,0	2,3	3548,0	Wescor	
WFA31	In front of plug	0,0	0,0	3540,0	Wescor	
WFA32	In front of plug	0,0	0,0	3539,0	Wescor	

7 Results and comments for Section 2

7.1 General

In this chapter short comments on general trends in the measurements are given. Sensors that are not delivering reliable data or no data at all are noted and comments on the data collection in general are given.

The heating of the canister in hole 5 started with an applied constant power of 1800 W at 030508. This date is also marked as start date. The backfilling started 030429 and was finished 030625 and the plug was cast at 030911. Table 7-1 shows some important dates for section 2.

Table 7-1. Key dates for section 2

Activity	Date
Start backfilling	29/4 2003
Start heating canister 5	8/5 2003
Start heating canister 6	23/5 2003
Finished backfilling	25/6 2003
Plug casting	11/9 2003
Decreased power (-30 W)	8/9 2004

62 out of 394 sensors (excluding water pressure sensors in the rock, geo-electric measurements, stress and strain in the rock and displacement of canister) are out of order.

The maximum measured temperature on the canister in deposition hole 5 is about 84 °C. For the canister in deposition hole 6 the maximum temperature is about 88 °C.

7.2 Deposition hole 5

7.2.1 Total pressure

Geokon (App. 5\pages 167-170)

The measured pressure range is from 0 to 7.5 MPa. PB506 placed in block C1 shows strong increasing of the total pressure since day 200. High pressures are also indicated by transducers in block R5 and R10. PB511 in block R5 is showing a very quick increase in pressure around day 520. Two transducers placed in block R10 (PB521 and PB522) are showing a drop in total pressure at around day 300 and then they are stabilized on a pressure of about 2 MPa. These two transducers are showing an increase in pressure at the end of this measuring period caused by the closing of the drainage.

Two transducers are out of order.

Kulite (App. 5\page 171)

The highest pressure 0.7 MPa is indicated from one peripheral transducer in block R10. The transducer PB510 also placed in block R10 but close to the canister shows a pressure of 0.30 MPa. A transducer (PB516) placed in the peripheral of block R5 shows a total pressure close to 0.30 MPa. The rest of the transducers are showing low pressures.

Two transducers are out of order.

7.2.2 Relative humidity/suction in dep. hole 5.

Vaisala (App. 5\pages 172-175)

Since temperature is also measured with all relative humidity sensors, the diagrams include those measured temperatures. The temperature measurements start at about 16 degrees while the RH measurements start at about 70 % RH.

The sensors placed in the bottom block C1 show very small changes in RH with the time.

One sensor placed in block R5 close to the canister (WB519) is indicating a very strong drying of the bentonite until day 170 when it stopped to give reliable values. Sensor WB520 placed in the middle of block R5 is also indicating a drying of the bentonite. The rest of the transducers in block R5 are indication a slowly wetting of the buffer (increase in RH).

Two sensors in block R10 placed close to the top of the canister (WB522, WB523) are indicating a drying of the bentonite up to day 350 and after that a slowly wetting. The rest of the transducers in block R10 are indicating a wetting of the buffer.

Three sensors placed in block C3 and C4 are indicating a slowly wetting of the buffer.

Eight sensors are out of order.

Rotronic (App. 5\pages 176-180)

Five of the sensors placed in the bottom block C1 show very small changes in RH with the time, while three transducers (WB508, WB509 and WB511) indicates a slow wetting of the bentonite.

One sensor placed in block R5 close to the canister (WB516) is indicating a very strong drying of the bentonite for the first 60 days. The sensor indicates then a wetting for the next 60 days and after that another period of drying until day 230. After that is the transducer indicating a slowly increase in Relative Humidity (wetting).

One sensor placed in block C3 is indicating a slowly wetting of the bentonite.

Six sensors are out of order.

Wescor Psychrometers (App.5\page 181)

The Wescor sensors can measure suction between 6000 and 200 kPa.

One of totally five sensors is beginning to measure a decreasing in suction of the buffer. This sensor (WB358) is placed near the periphery of block R3.

7.2.3 Pore water pressure

Geokon (App. 5\page 182)

All sensors yield very low pressures.

Kulite (App. 5\page 183)

Sensors UB508 was out of order from start and it is not plotted in this report.

All the installed sensors yield very low pressure.

One transducer is out of order.

7.2.4 Temperature in the buffer (App. 5\pages 184-193)

Three thermocouples (TB504, TB511 and TB524) are placed on the surface of the canister. TB504 placed close to the bottom of the canister is showing a maximum temperature of about 72 °C, TB511 placed at the middle of canister about 82 °C and TB524 placed close to the top of the canister is showing a maximum temperature of about 75 °C.

High temperatures are measured with thermocouples placed in the center of block C1 and just below the canister (TB503, 72 °C) and in block R5 (TB513, 76 °C). The temperature gradient over block R5 is 0.53 °C/cm.

The temperature in the buffer is also measured with the installed Geokon transducers. The maximum temperature recorded with these transducers is about 75 °C (PBU502 placed in the center of block C1 close to the canister). Two transducers are out of order.

7.2.5 Canister power (App. 5\page 197)

The power of the canister in hole 5 has been kept constant at 1800 W from the start 2003-05-08. In the beginning of September year 2004 the power was decreased with about 30 W to 1770 W.

Due to problems with the data collection system, data is missing for the first 45 days of the heating.

7.2.6 Temperature on the canister surface (App. 5\pages 198-200)

The first diagram shows the maximum temperature, measured with the optical cables placed on the surface of the canister, plotted as function of time. The present maximum measured temperature on the canister surface is about 84 °C. The second diagram shows the distribution of the temperature along the optical cables at the end of this measuring period. With no damages on the optical cables this plot should have four curves. Only two curves with relevant values are presented here which indicates that the optical cables are damaged. The length of the cables on the canister surface is about 20 m. The variation of a few degrees is caused by the difference in temperature at the center and ends of the canister. The curves may thus be further corrected after completed calibration. Compared to the measurements of the canister temperature with conventional thermo couples (see chapter 7.2.4) the optical cables yield a higher maximum temperature.

7.3 Deposition hole 6

7.3.1 Total pressure

Geokon and Kulite (App. 6\pages 203-206)

The results from two types of transducers are presented in the same plot.

The measured pressure range is from 0 to 4.3 MPa. Two transducers, PB624 and PB627 placed in the top block (C4) show an increase in pressure with about 1,5 MPa at the end of this measuring period due to the closing of the drainage of the tunnel. Two sensors, PB606 and PB607, show a strong increase in pressure during the whole measuring period.

Nine sensors (eight Kulite and one Geokon) are out of order.

7.3.2 Relative humidity/Suction

Vaisala and Rotronic (App. 6\pages 207-213)

The results from two types of transducers are presented in the same plot.

The sensors placed in the bottom block C1 show very small changes in RH with the time.

One sensor placed in block R2 (WB613) is indicating a wetting of the buffer. The rest of the sensors in block R1, R2, R5 and R6 are measuring very small changes in RH with the time.

One sensor placed close to the canister in block R9 (WB645) is indicating a drying of the buffer. The rest of the transducers in block R8 and R9 are indication a slowly wetting of the buffer

Two sensors (WB649, WB650) placed in block R10 and at the top of the canister are indicating an initial wetting of the bentonite and then a continuing drying.

The sensors placed in block C3 and C4 show very small changes in RH with the time.

Sensors WB606, WB634 and WB648 were out of order at the start of the heating phase and are not plotted in this report.

22 of the initial 37 installed sensors are out of order at the time, some of them due to data logger problems.

Wescor Psychrometers (App. 6\page 214-215)

Eight of totally nine sensors installed in the rock wall and one of totally 26 sensors installed in the buffer are beginning to measure a decreasing in suction of the rock mass and buffer.

7.3.3 Pore water pressure

Geokon and Kulite (App. 6\pages 216-218)

All sensors yield very low pressures.

Four sensors (Kulite) are out of order.

7.3.4 Temperature in the buffer (App. 6\pages 219-227)

Three thermocouples (TB611, TB619 and TB627) are placed on the surface of the canister. TB611 placed close to the bottom of the canister shows a temperature at the end of this measuring period of about 73 °C while TB619 placed at the middle of canister shows a temperature of 79 °C. TB627 placed close to the top of the canister is also showing a temperature of 79 °C.

The maximum temperature in the buffer recorded so far is 81 °C. It is measured in block R5, close to the canister (TB612). The temperature plot for this transducer indicates that it is in contact with the canister. During this measuring period this sensor is indicating a slow decrease in temperature. When this transducer is excluded the maximum temperature gradient over block R5 is about 0.55 °C/cm.

Two thermocouples are out of order.

The temperature in the buffer is also measured by the installed Geokon transducers. The maximum temperature recorded with these transducers is about 75 °C (UB603 placed in block R2 close to the canister). Two transducers are out of order.

7.3.5 Canister power (App. 6\page 231)

The power of the canister in hole 6 has been kept constant at 1800 W from the start 2003-05-23. At the beginning of September year 2004 the power was decreased with about 30 W to 1770 W.

Due to problems with the data collection system, data is missing for the first 30 days of the heating.

7.3.6 Temperature on the canister surface (App. 6\pages 232-234)

The first diagram shows the maximum temperature plotted as a function of time. The average maximum measured temperature on the canister surface is about 88 °C. The second diagram shows the distribution of the temperature along the optical cables at the end of this measuring period. With no damages on the optical cables this plot should have four curves. Only two curves with relevant values are presented here which indicates that the optical cables are damaged. The length of the cables on the canister surface is about 20 m. The variation of a few degrees is caused by the difference in temperature at the center and ends of the canister. The curves may thus be further corrected after completed calibration. Compared to the measurements of the canister temperature with conventional thermo couples (see chapter 7.3.4) the optical cables yield a higher maximum temperature. The temperature curves from the optical cables may be corrected after final calibration.

7.4 Backfill in Section 2

7.4.1 Total pressure

Geokon (App. 7\page 237)

All the total pressure transducers are measuring an increase in pore pressure, of about 1 MPa, at the end of this measuring period due the closing of the drainage of the tunnel. The highest total pressures before the closing of the drainage, 400 kPa, is measured by the transducer PFA13. This transducer is placed just above the bentonite surface in the deposition hole 6. The rest of the total pressure transducers were measuring very small pressures before the closing of the drainage.

Kulite (App.7 \page 238)

These transducers are also measuring an increase in total pressure of about 1 MPa due to the closing of the drainage. The highest pressure before the closing of the drainage is measured by the transducer PFA12, about 400 kPa. This transducer is placed just above the bentonite surface in deposition hole 6. The rest of the total pressure transducers were measuring very small pressures before the closing of the drainage.

7.4.2 Suction (App. 7 \pages 239-245)

The suction in the backfill is measured with Wescor psychrometers. Most of the psychrometers yield suction values between 2500 and 3500 kPa at the start of the test, which correspond to the initial suction at a water ratio in the backfill of 12%. Some sensors have clearly being wetted to almost fully saturation (suction below 1500 kPa) very short after the start of the test. These sensors (WFA12, WFA20, and WFA27) are placed close the rock surface. A decrease in suction and thus a wetting of the backfill is indicating by the rest of the sensors until the closing of drainage of the tunnel. All of the still working transducers were after this event showing a quicker decrease in suction. Many of the installed transducers are not giving reliable values anymore probably cause by water coming in to the sensor.

The position of WFA14 is not clear and the sensor is not plotted in this report.

7.4.3 Pore water pressure

Geokon (App. 7\pages 246-248)

All the sensors, except one (UFA11), are showing an increase in pore pressure, about 1 MPa, after the closing of the tunnel drainage. Before this event the sensors were recording very low pressures.

Kulite (App. 7\page 249)

Three of the sensors are showing an increase in pore pressure, about 1 MPa, after the closing of the tunnel drainage. Before this event the sensors were recording very low pressures.

One sensor is out of order.

7.4.4 Temperature (App. 7\pages 250-252)

The temperature in the backfill ranges from 18 to 29 °C. The highest temperatures are as expected measured above the buffer in hole 5 and hole 6.

7.5 Temperature in the rock

7.5.1 Near hole 5 (App. 5\pages 194-196)

The maximum temperature in the rock (53 °C) is measured by TROA5055 located at rock surface near the center of the canister in deposition hole 5.

Six transducers show suddenly increase in temperature with (2 degree) probably due to data logger problems during a period of about 100 days.

7.5.2 Near hole 6 (App. 7\pages 228-230)

The maximum temperature in the rock (51 °C) is measured by TROA6045 located at rock surface near the center of the canister in deposition hole 6.

References

/1-1/ **Börgesson L, Sanden T.** Report on instrument positions and preparation of bentonite blocks for instruments and cables in section 1, February 2001. SKB IPR-01-20

/2-1/ **Börgesson L, Sanden T.** Instrumentation of buffer and backfill in Section 2 ,January 2003. SKB IPR-03-21

Appendix 1

Dep. hole 1

Prototype\Hole 1\Cyl.1 (010917-041201)
Total pressure - Geokon

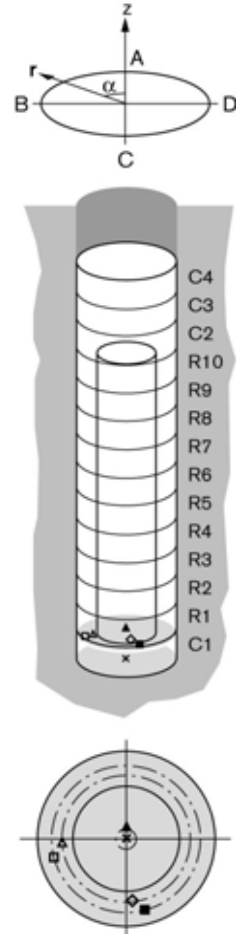
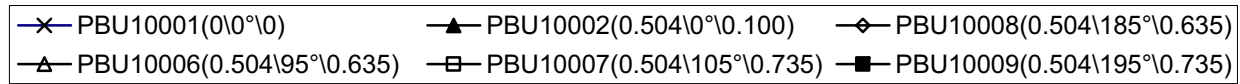
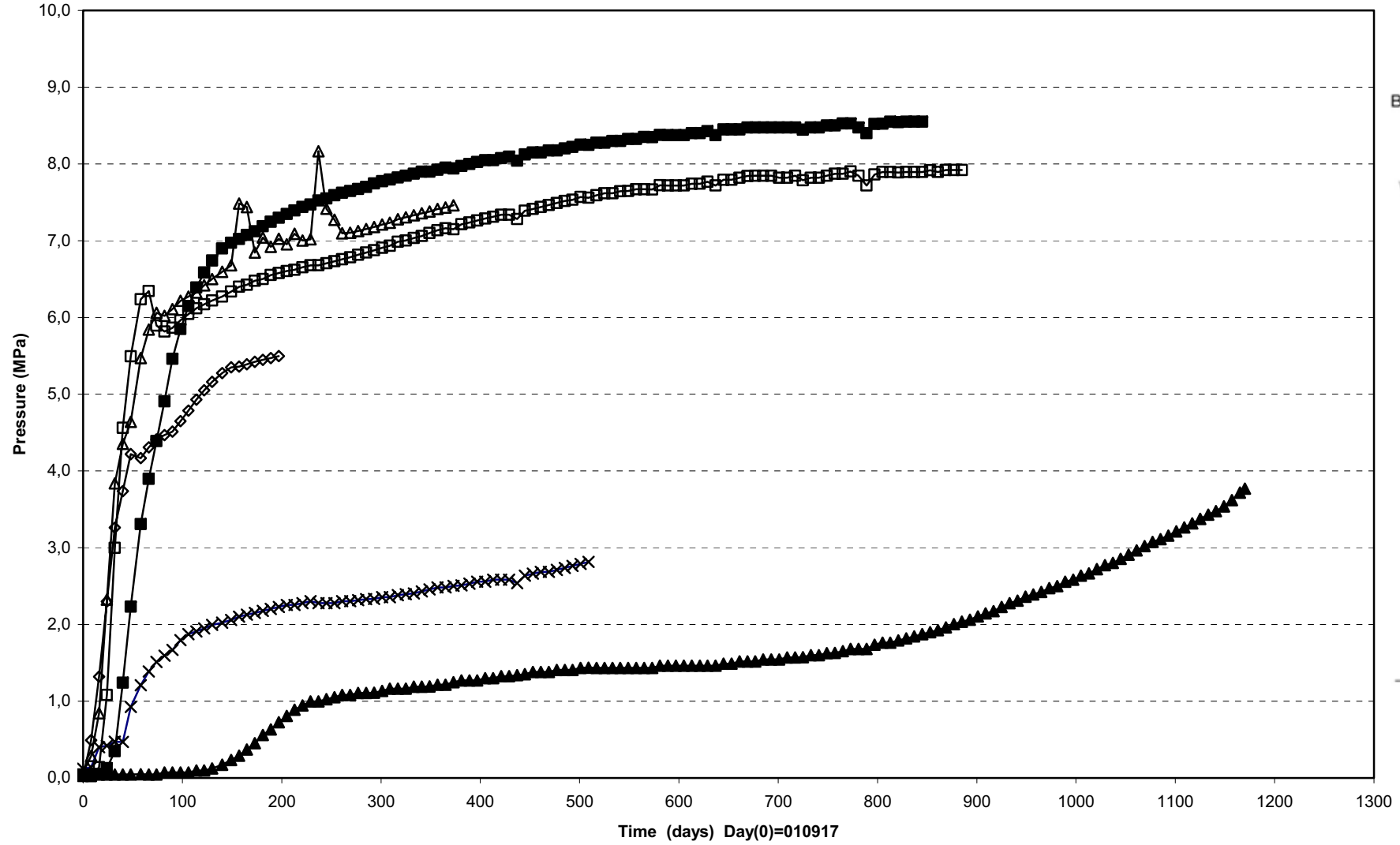

Prototype\Hole 1\Ring5 (010917-041201)
 Total pressure - Geokon

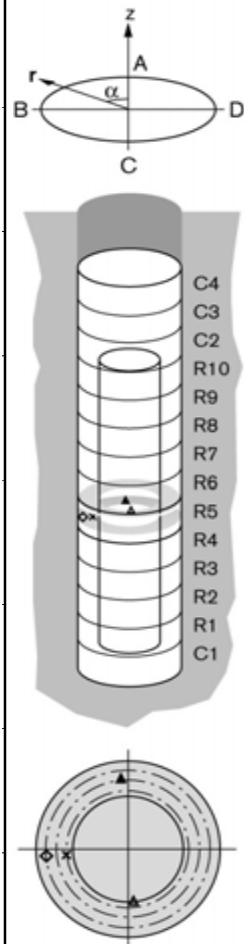
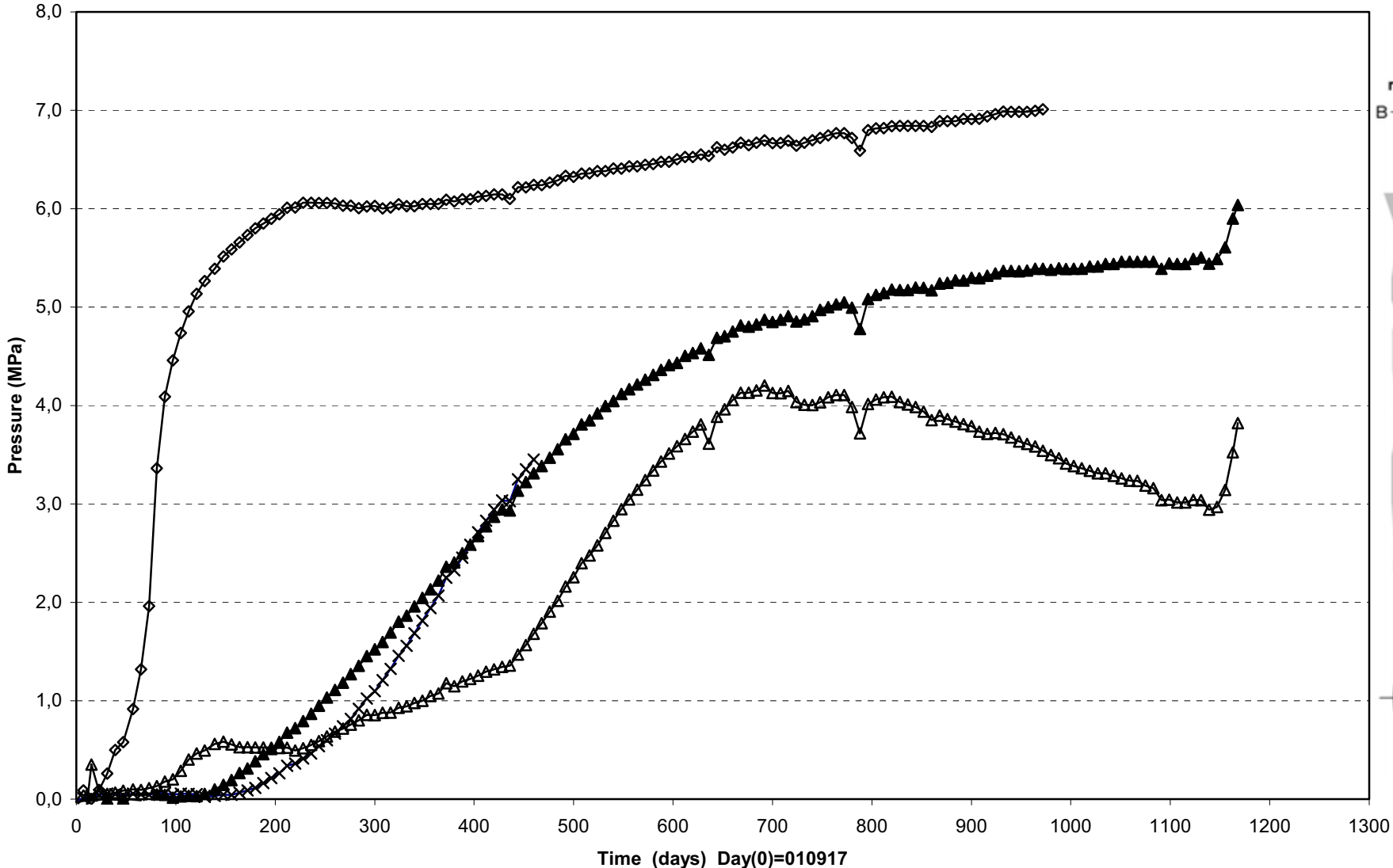

Prototype\Hole 1\ Ring10 and Cyl.3 (010917-041201)
 Total pressure - Geokon

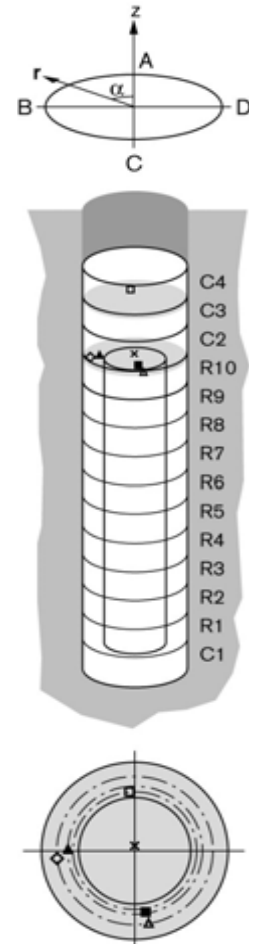
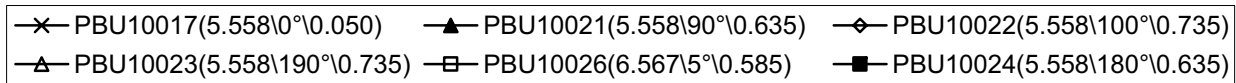
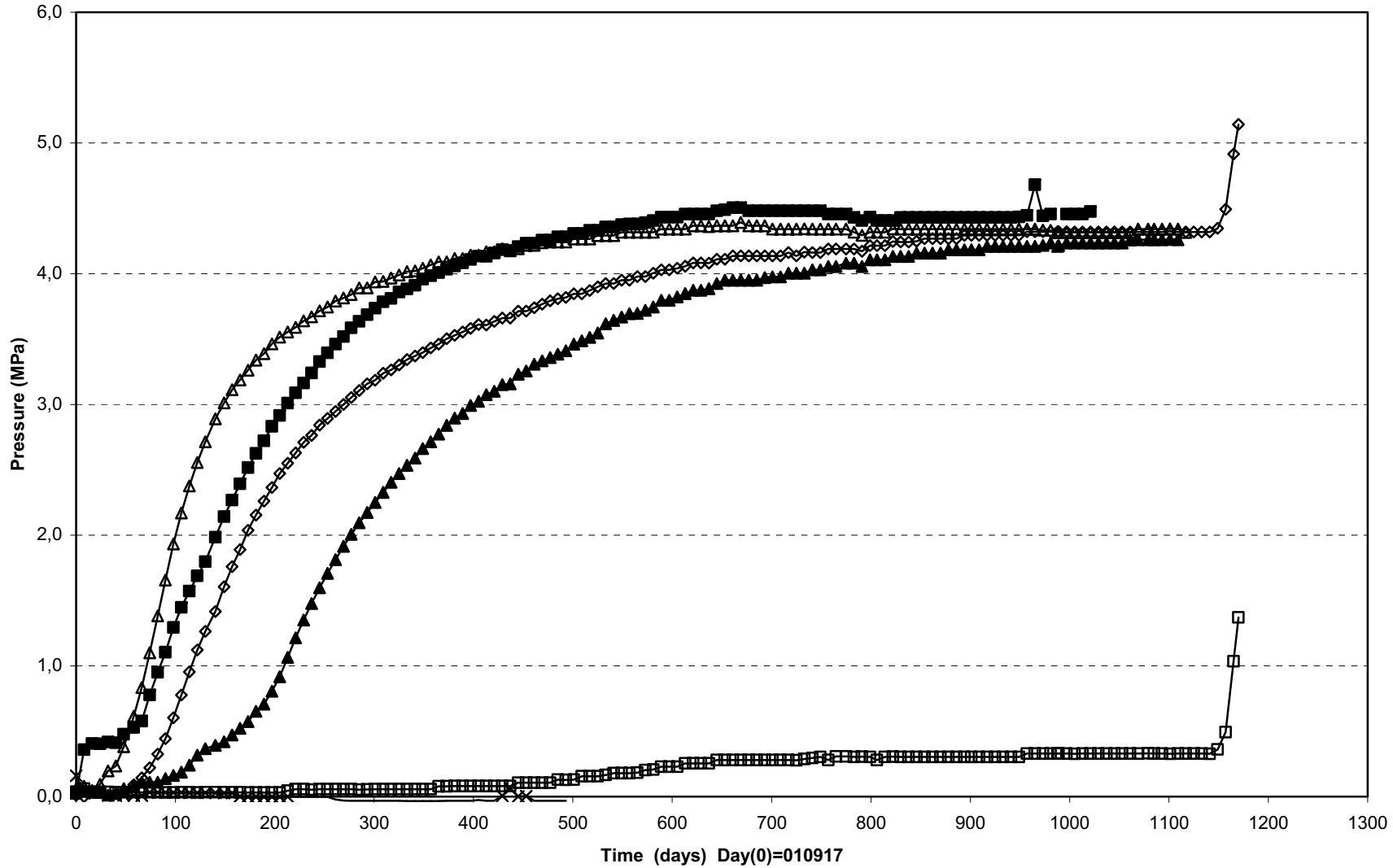

Prototype\ Hole 1 (010917-041201)
 Total pressure - Kulite

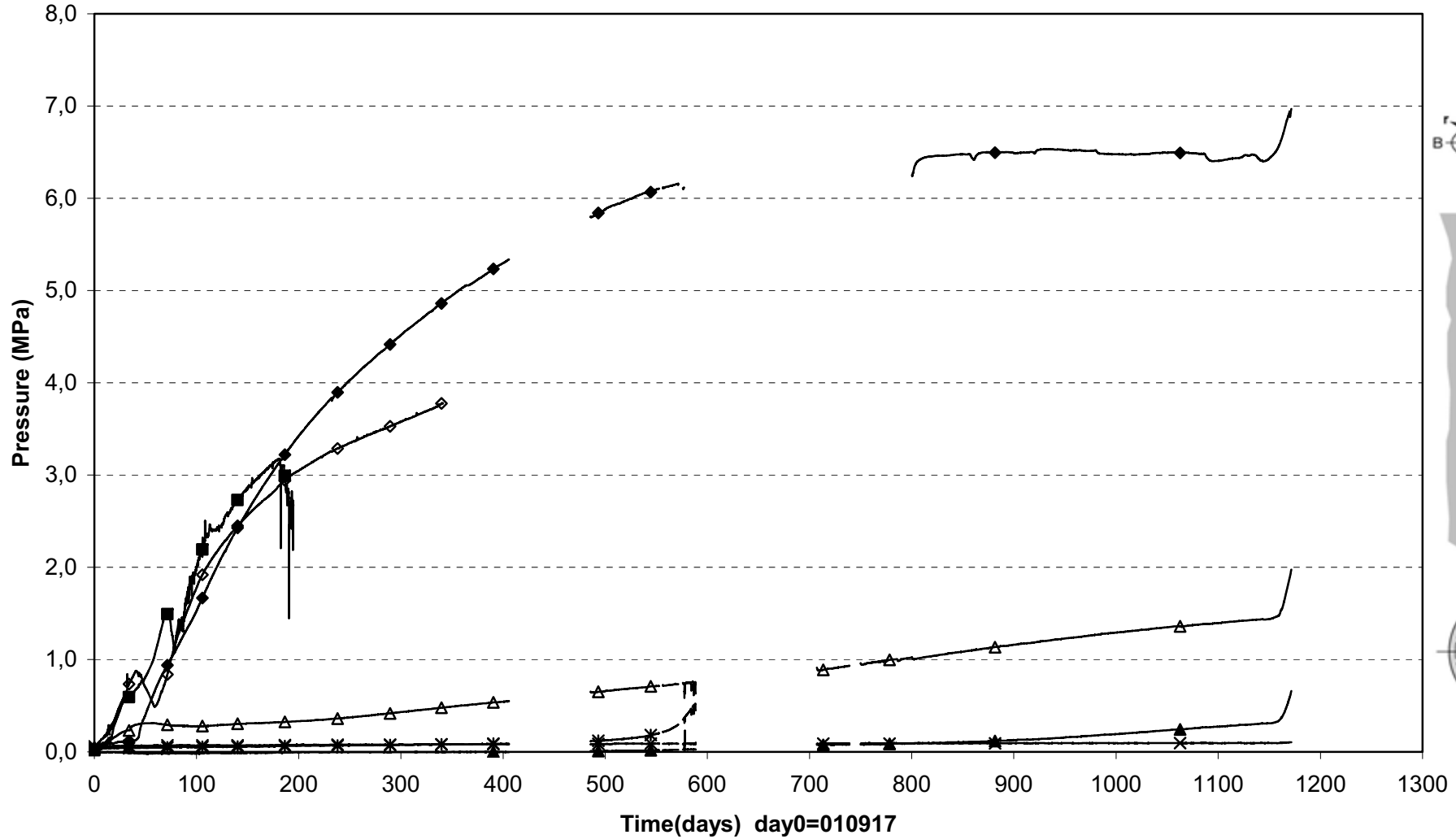

■ PBU10004(0.504\5°\0.685) ◇ PBU10005(0.504\5°\0.785) ◆ PBU10012(3.030\5°\0.785) ▲ PBU10019(5.558\5°\0.685)
 △ PBU10020(5.558\5°\0.785) × PBU10025(6.317\0°\0.050) * PBU10027(7.076\0°\0.050)

Prototype\Hole 1\Cyl.1 (010917-041201)
Relative humidity - Vaisala

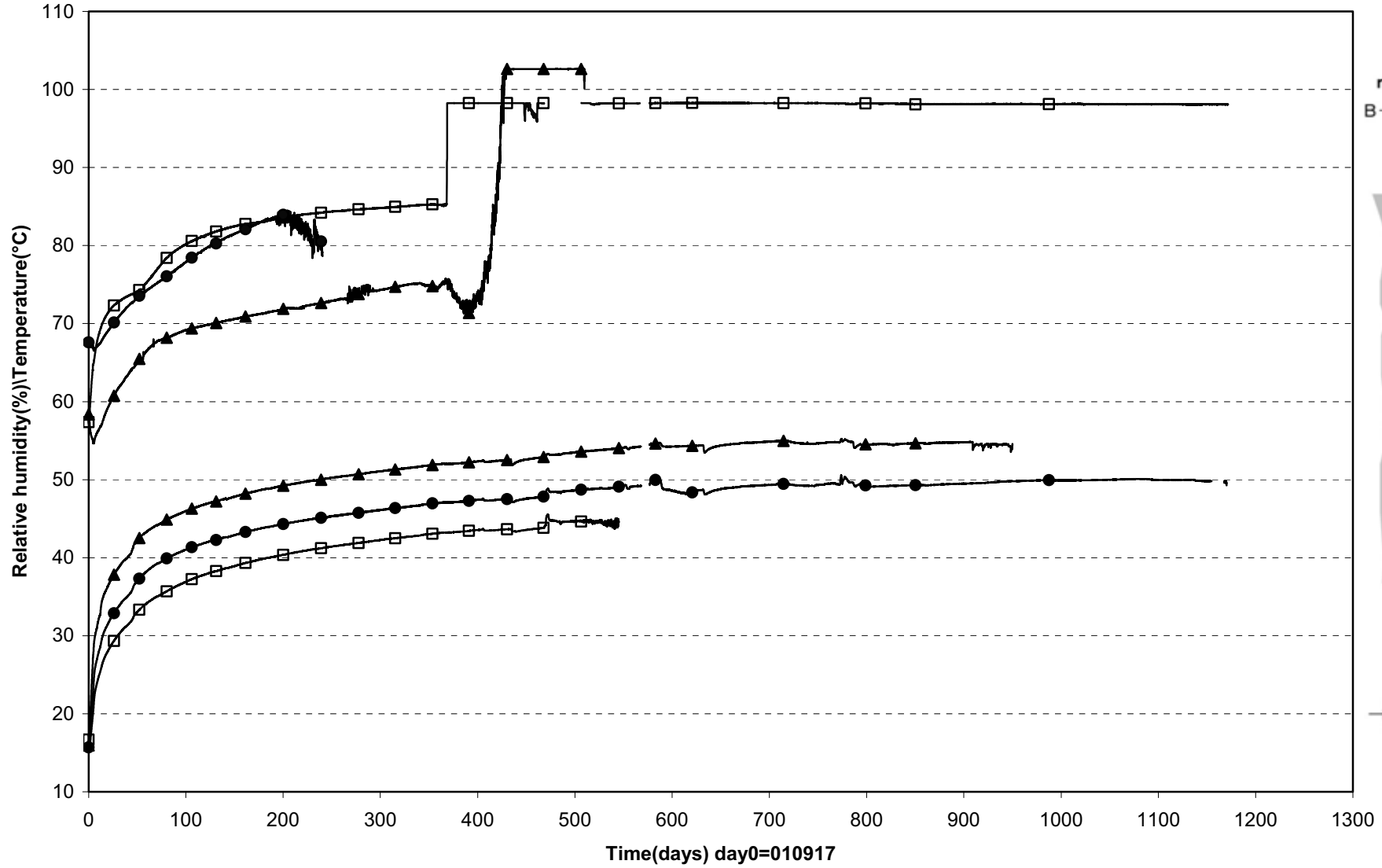

□ WBU10004(0.344\350°\0.785) ● WBU10005(0.344\350°\0.685) ▲ WBU10006(0.344\350°\0.585)

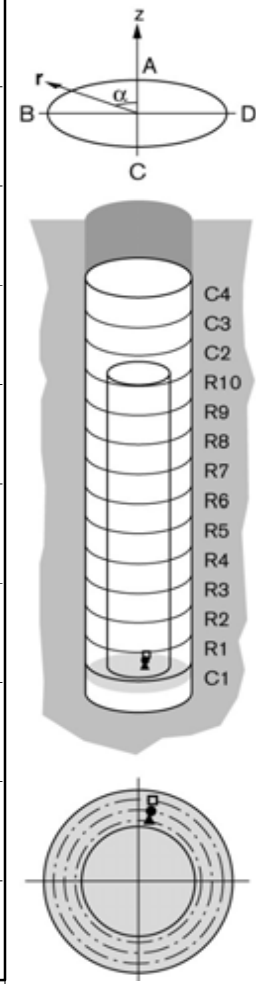

Prototype\Hole 1\Ring.5 (010917-041201)
Relative humidity - Vaisala

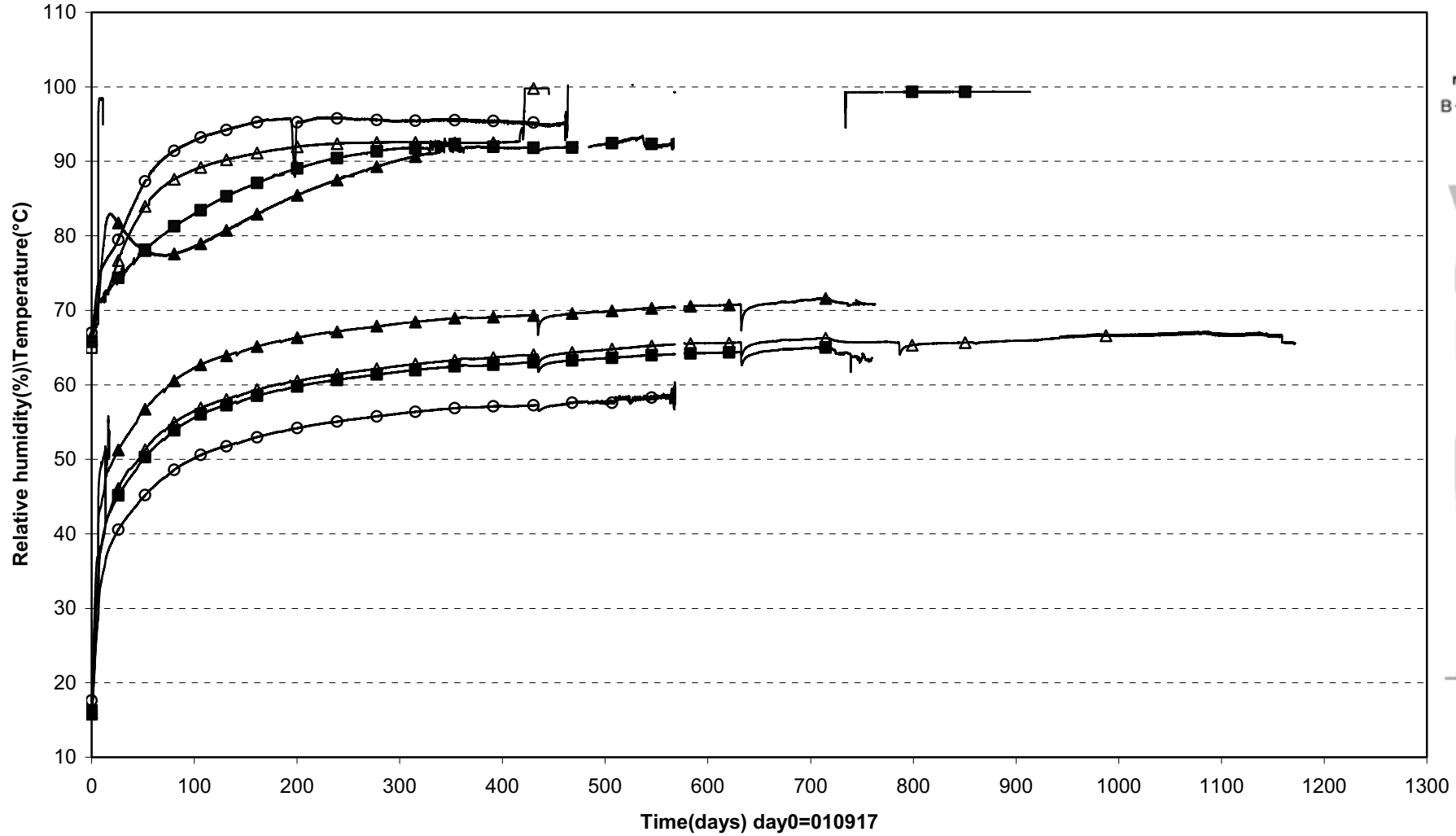

▲ WBU10013(2.870\350°\0.585)	■ WBU10014(2.870\350°\0.685)	○ WBU10015(2.870\350°\0.785)
□ WBU10019(2.870\180°\0.535\In the slot)	△ WBU10020(2.870\180°\0.685)	

Prototype\Hole 1\Ring10 (010917-041201)
Relative humidity - Vaisala

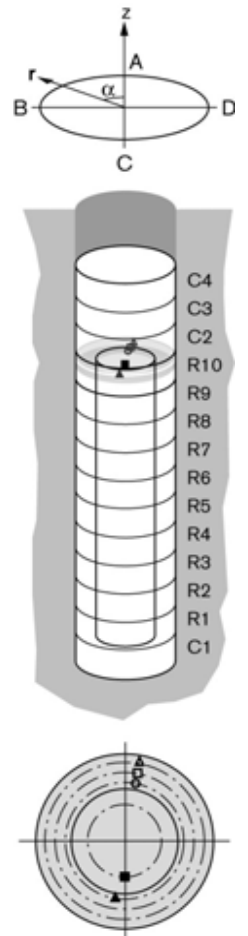
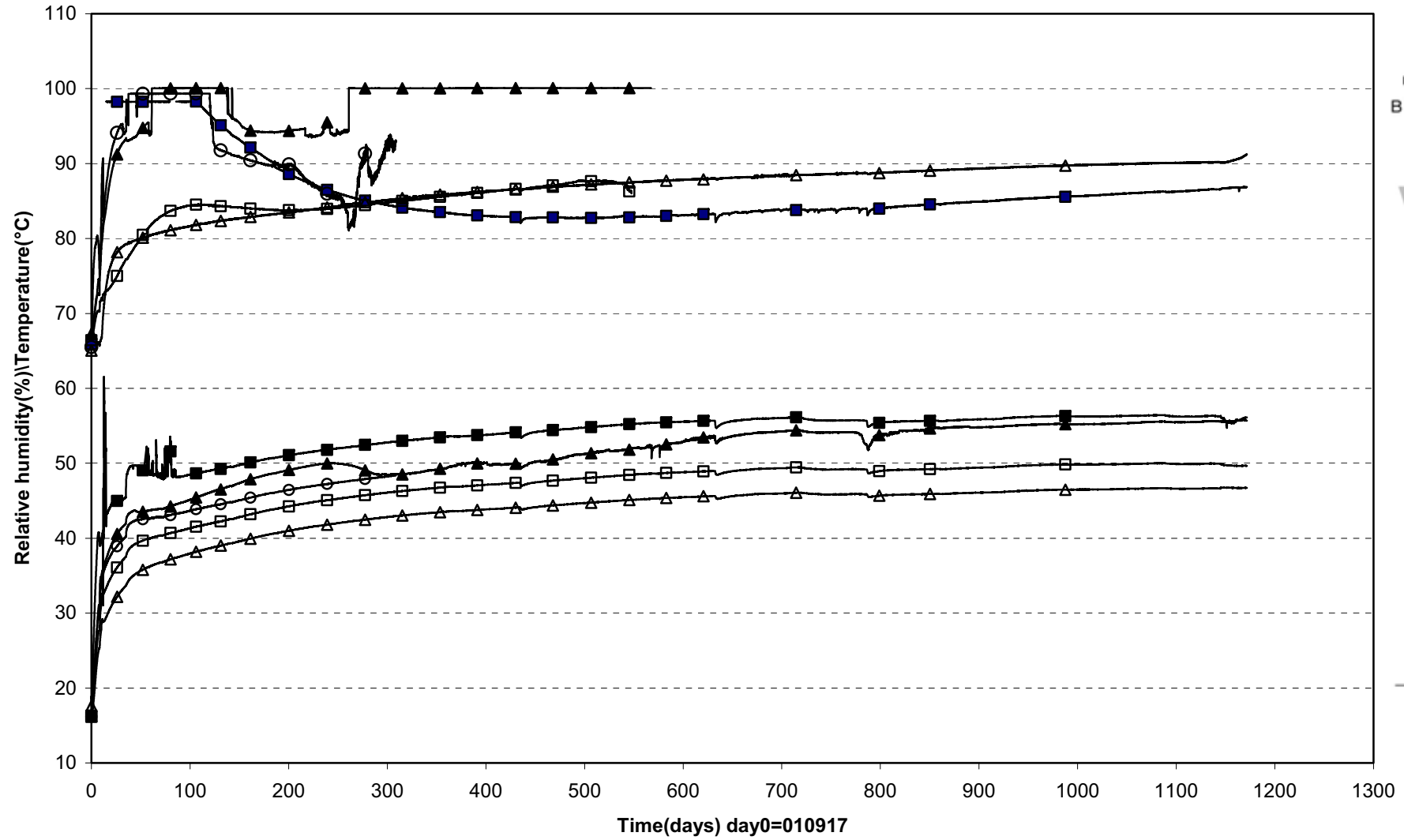

■ WBU10023(5.428\180°\0.362) ○ WBU10024(5.398\350°\0.585) □ WBU10025(5.398\350°\0.685) △ WBU10026(5.398\350°\0.785) ▲ WBU10030(5.398\170°\0.585)

Prototype\Hole 1\Cyl.3 and Cyl.4 (010917-041201)
Relative humidity - Vaisala

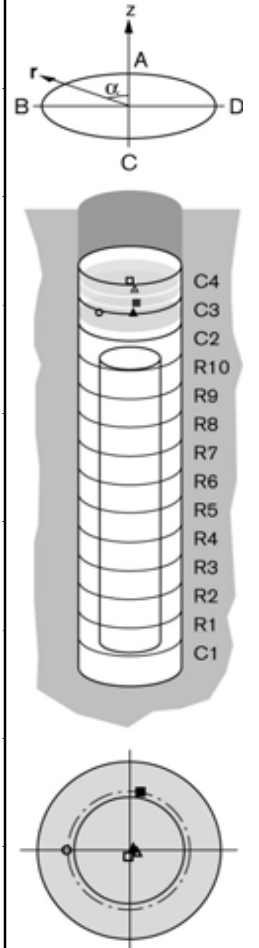
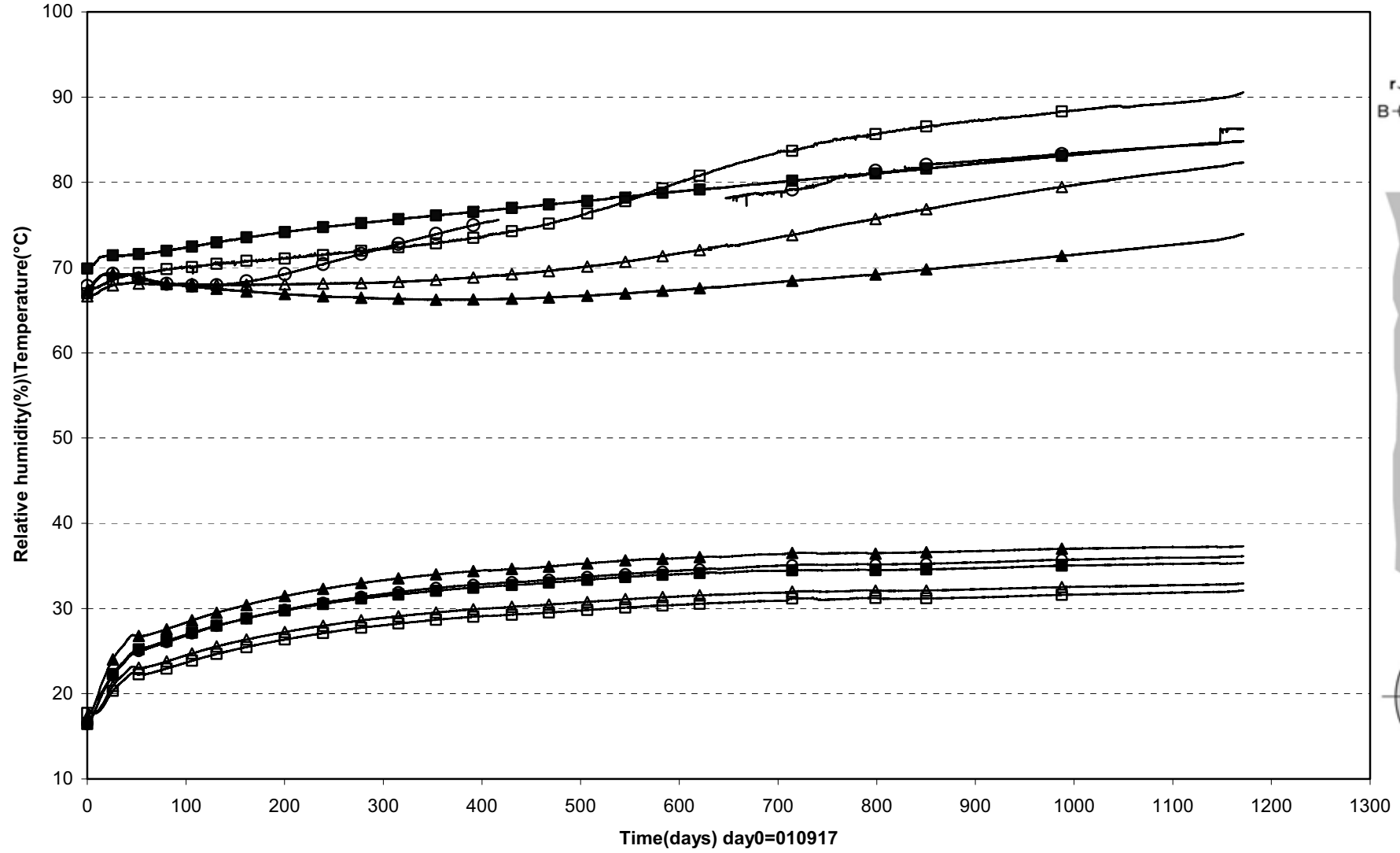

▲ WBU10032(6.317\270°\0.050) ■ WBU10033(6.317\350°\0.585) ○ WBU10034(6.317\90°\0.585) □ WBU10036(6.916\180°\0.050) △ WBU10037(6.756\270°\0.050)

Prototyp\Hole 1\Cyl.1 (010917-041201)
Relative humidity - Rotronic

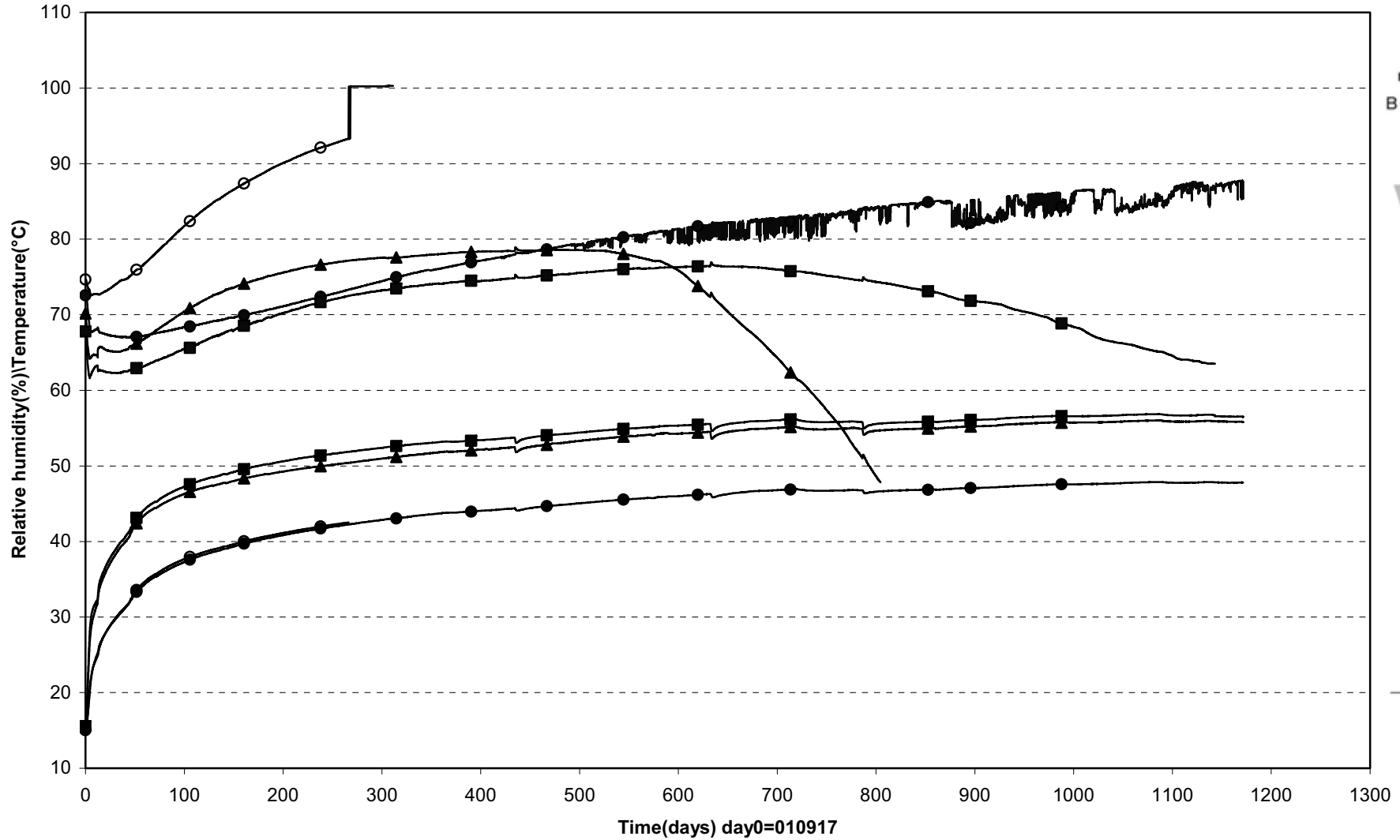

● WBU10001 (0.054\180°\0.050) ▲ WBU10002 (0.254\0°\0.400) ■ WBU10003 (0.254\180°\0.100) ○ WBU10008(0.254\80°\0.685)

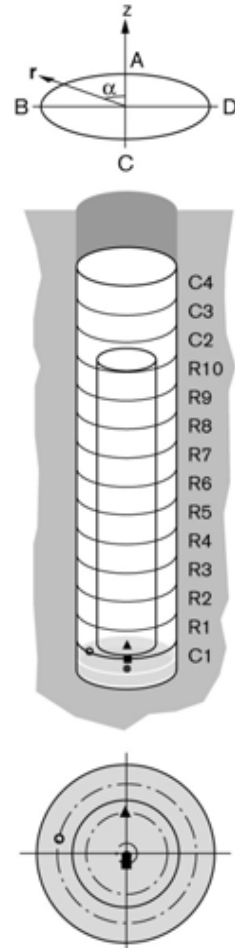

Prototyp\Hole 1\Cyl.1 (010917-041201)
Relative humidity - Rotronic

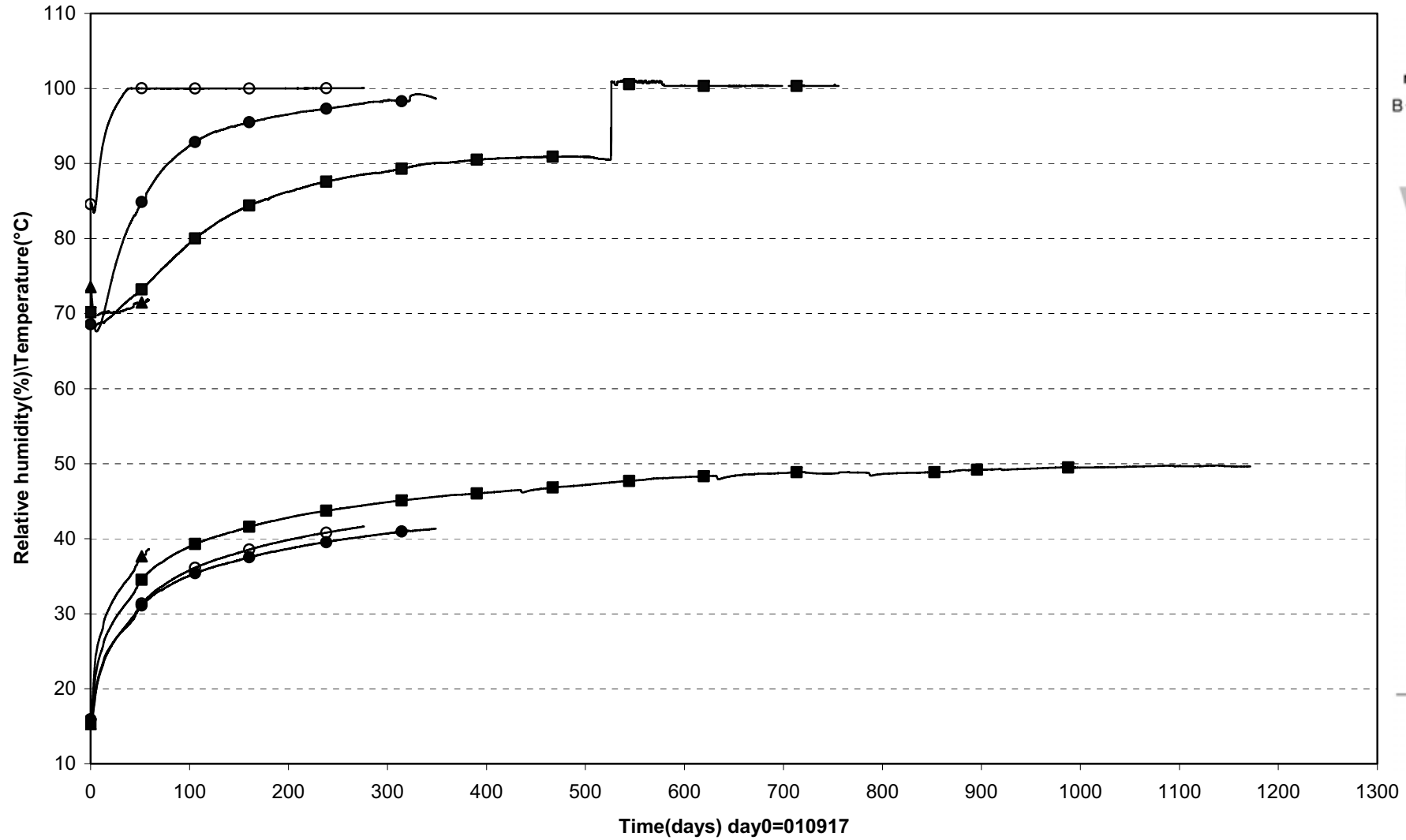

● WBU10009(0.254\80°\0.785) ▲ WBU10010(0.254\170°\0.585) ■ WBU10011(0.254\170°\0.685) ○ WBU10012(0.254\170°\0.785)

Prototyp\Hole 1\Ring.5 (010917-041201)
 Relative humidity - Rotronic

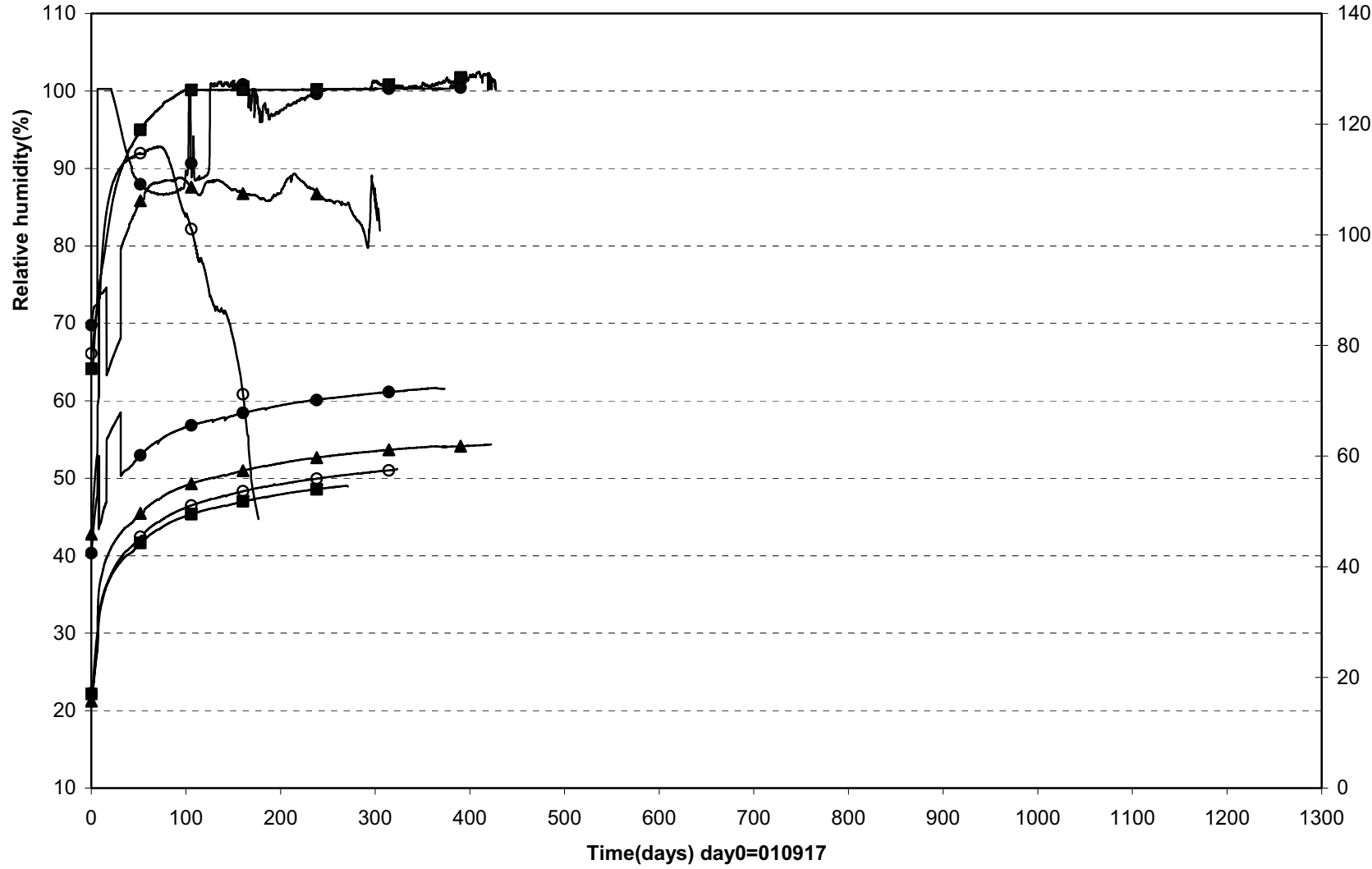

● WBU10016(2.780\80°\0.535) ▲ WBU10017(2.780\80°\0.685) ■ WBU10018(2.780\80°\0.785) ○ WBU10021(2.780\180°\0.785)

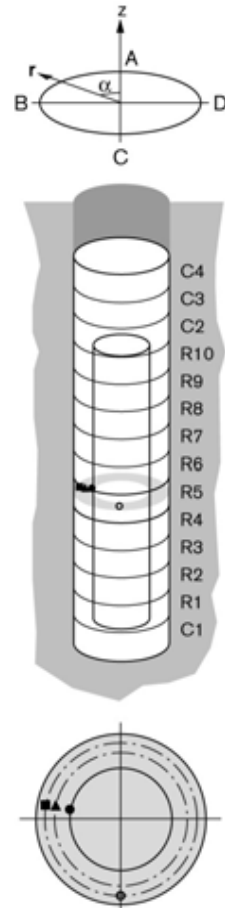

Prototyp\Hole 1\Ring10 (010917-041201)
 Relative humidity - Rotronic

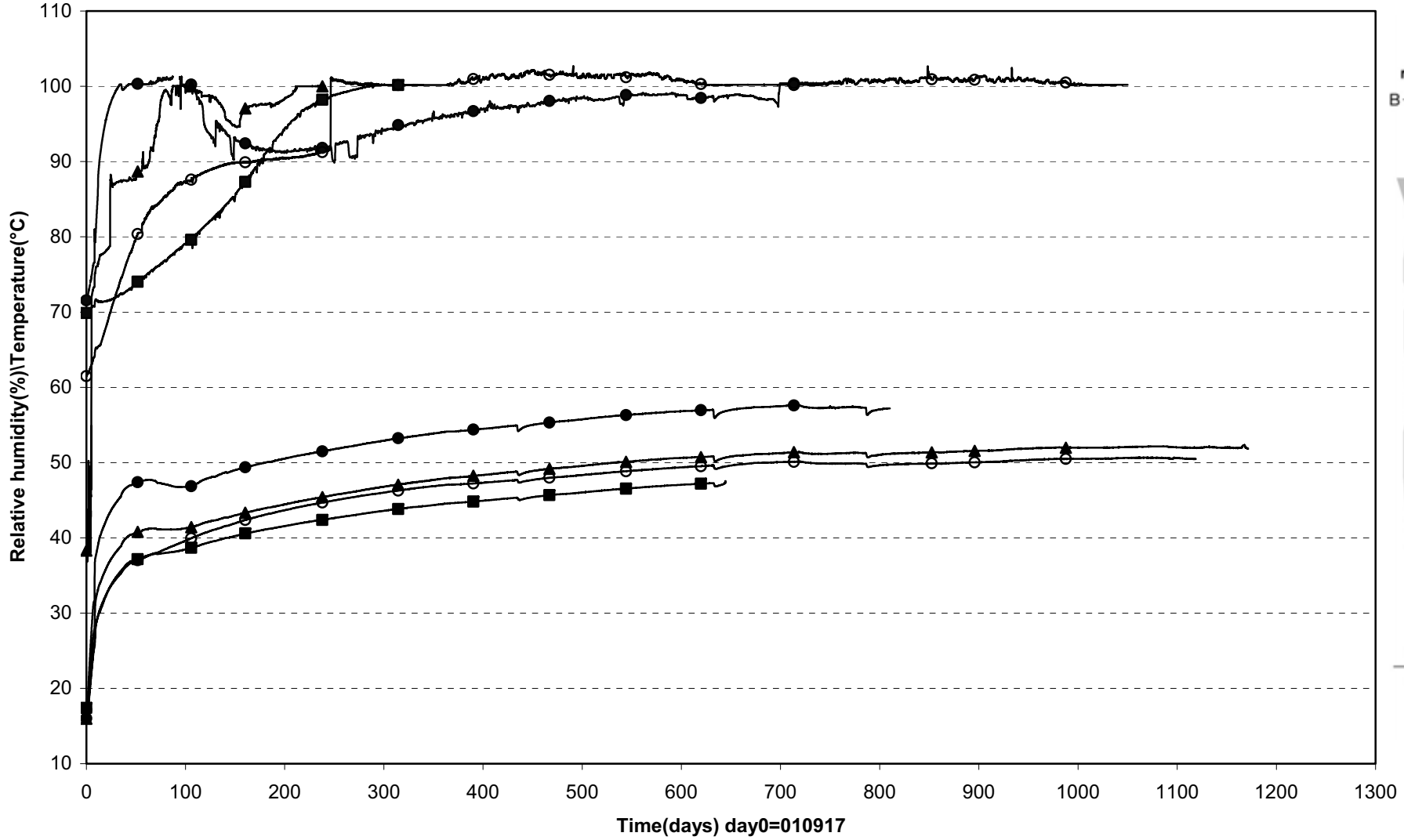

● WBU10027(5.308\80°\0.585) ▲ WBU10028(5.308\80°\0.685) ■ WBU10029(5.308\80°\0.785) ○ WBU10031(5.308\170°\0.785)

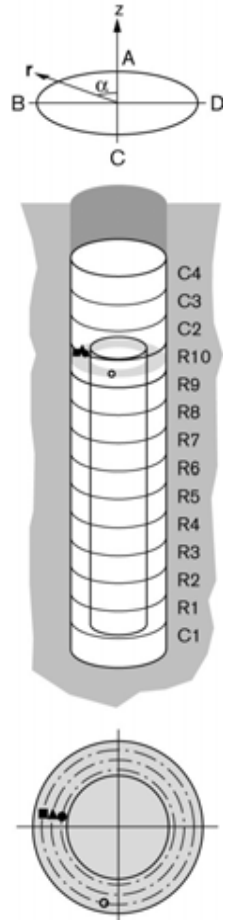

Prototyp\Hole 1\Cyl.3 (010917-041201)
 Relative humidity - Rotronic

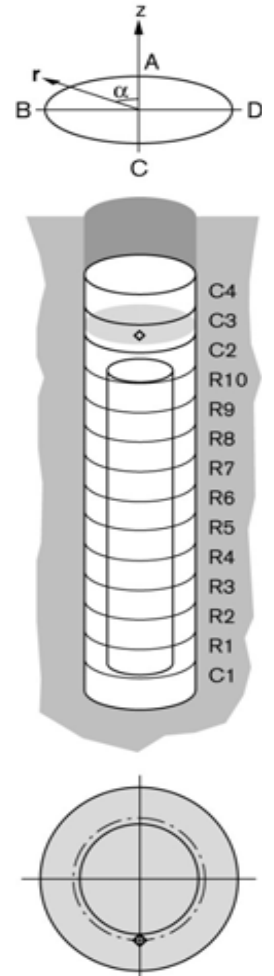
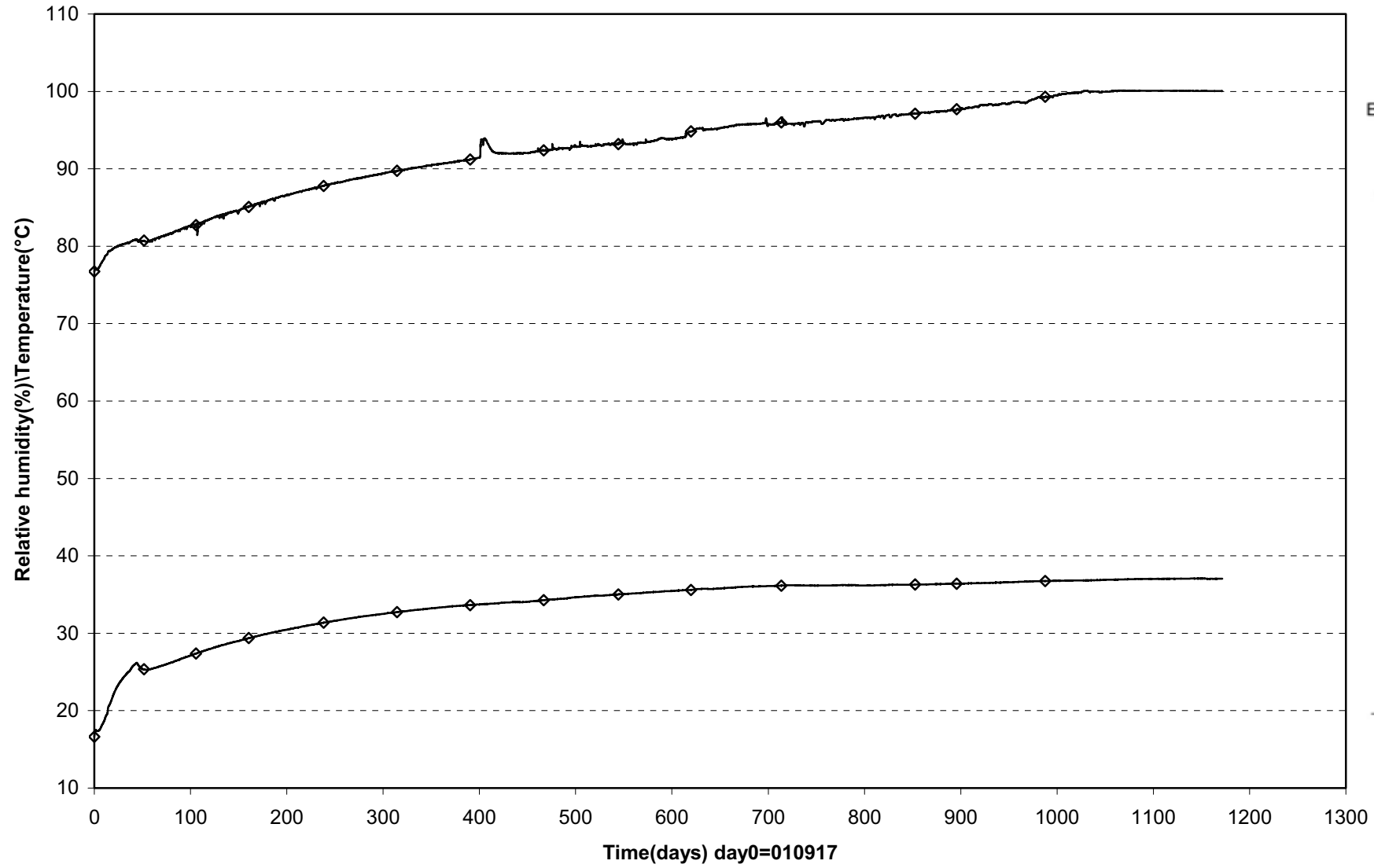

PrototypeHole 1 (010917-041201)
Pore pressure - Geokon

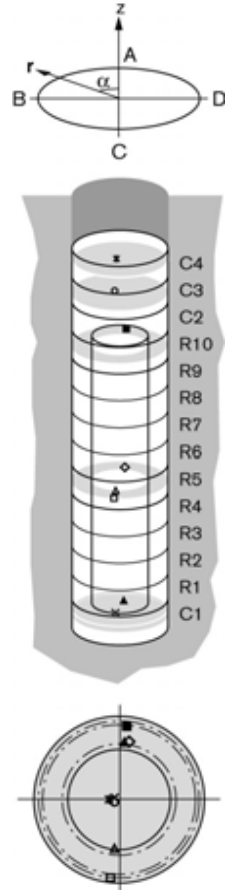
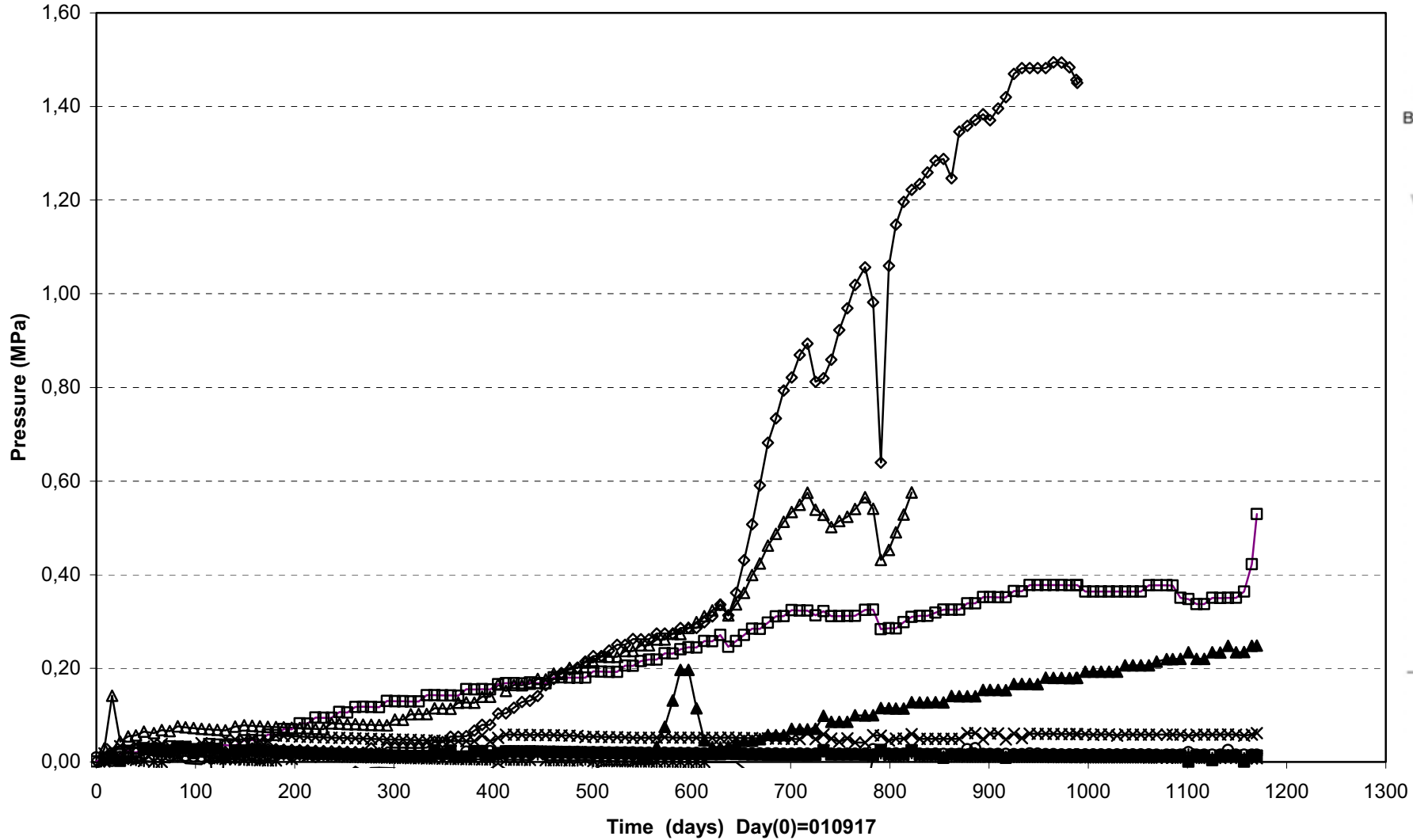

—x— UBU10002(0.254\90°\0.100)	—▲— UBU10003(0.344\355°\0.585)	—◇— UBU10005(2.780\355°\0.585)	—△— UBU10009(2.780\175°\0.535\)
—□— UBU10010(2.780\175°\0.825)	—■— UBU10012(5.308\355°\0.785)	—○— UBU10013(6.317\90°\0.050)	—*— UBU10014(6.916\90°\0.050)

Prototype\ Hole 1 (010917-041201)
Pore pressure - Kulite

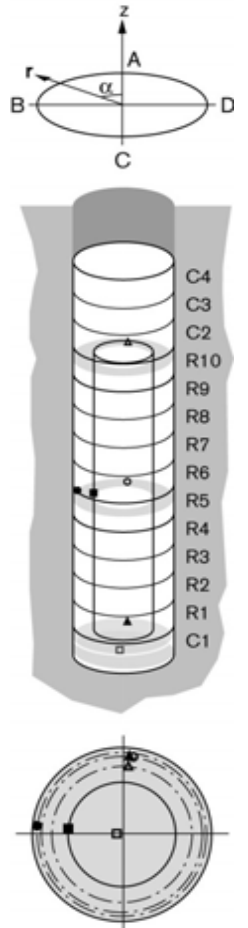
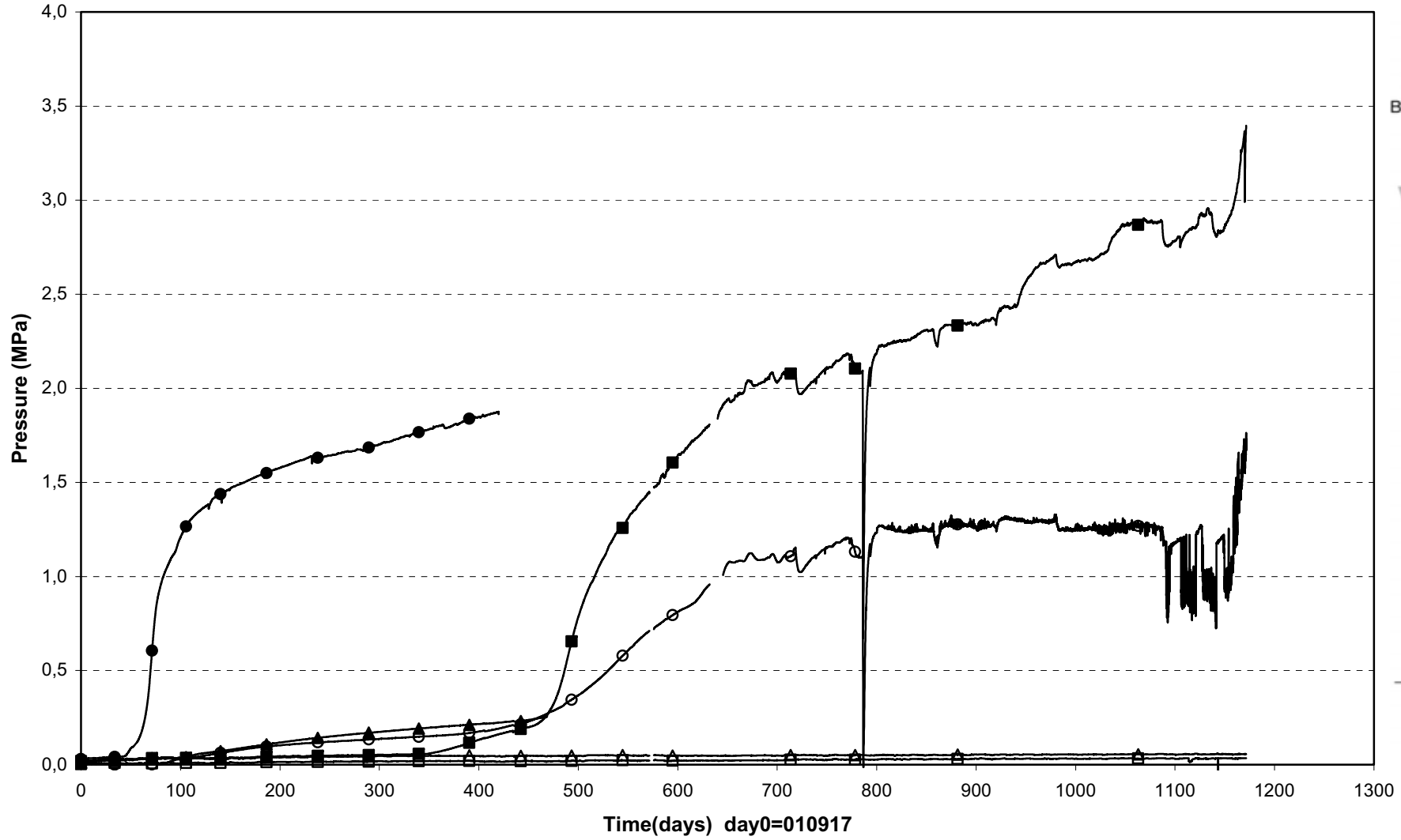

Prototype\Hole 1\Cyl.1 (010917-041201)
 Temperature - Pentronic

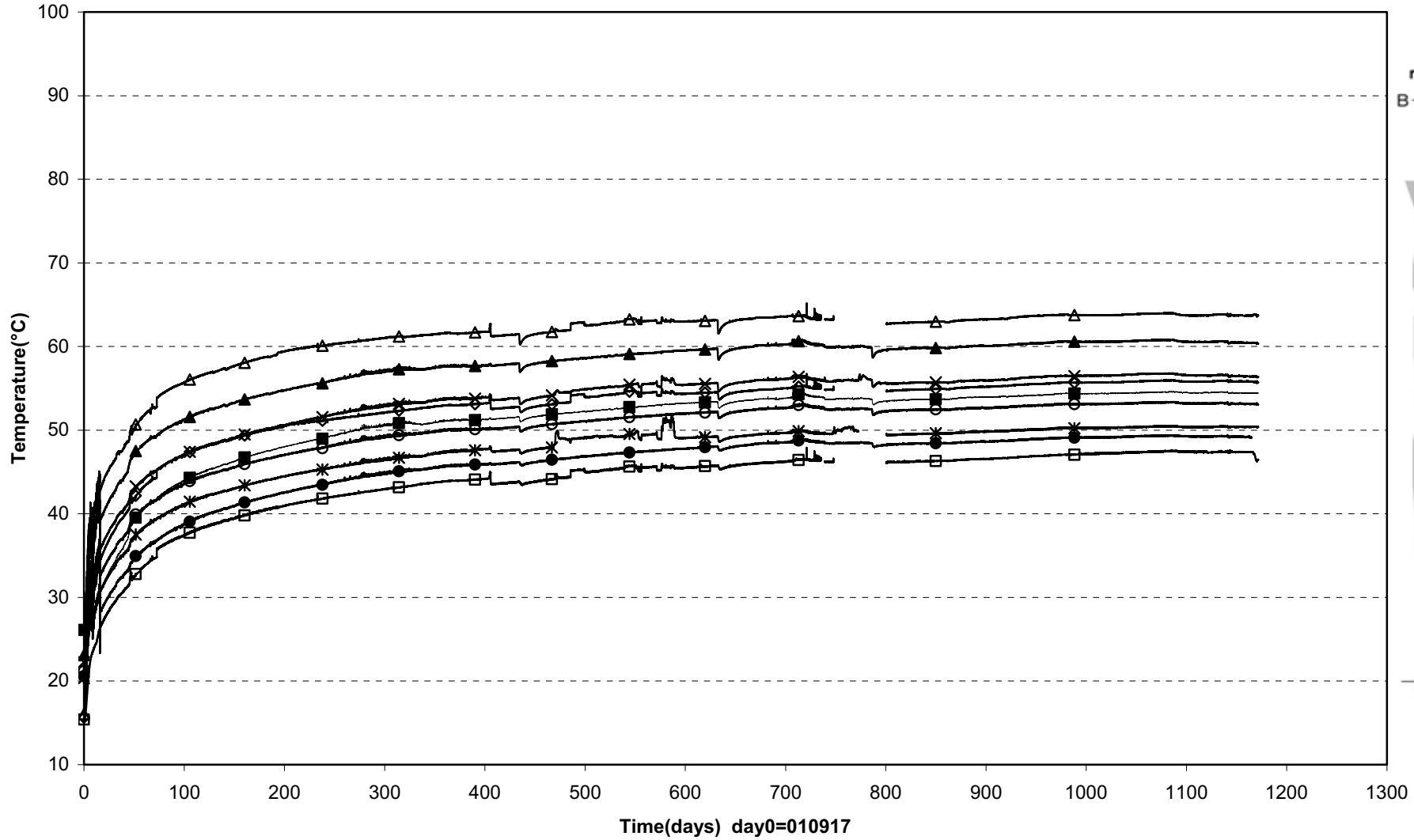

- TBU10001(0.054\270°\50) ◇ TBU10002(0.254\270°\0.050) △ TBU10003(0.454\270°\0.050) × TBU10004(0.454\355°\0.635) ✱ TBU10005(0.454\355°\0.735)
- TBU10007(0.454\175°\0.685) ▲ TBU10008(0.454\270°\0.585) ○ TBU10009(0.454\270°\0.685) ● TBU10010(0.454\270°\0.785)

Prototype\Hole 1 \Ring5 (010917-041201)
 Temperature - Pentronic

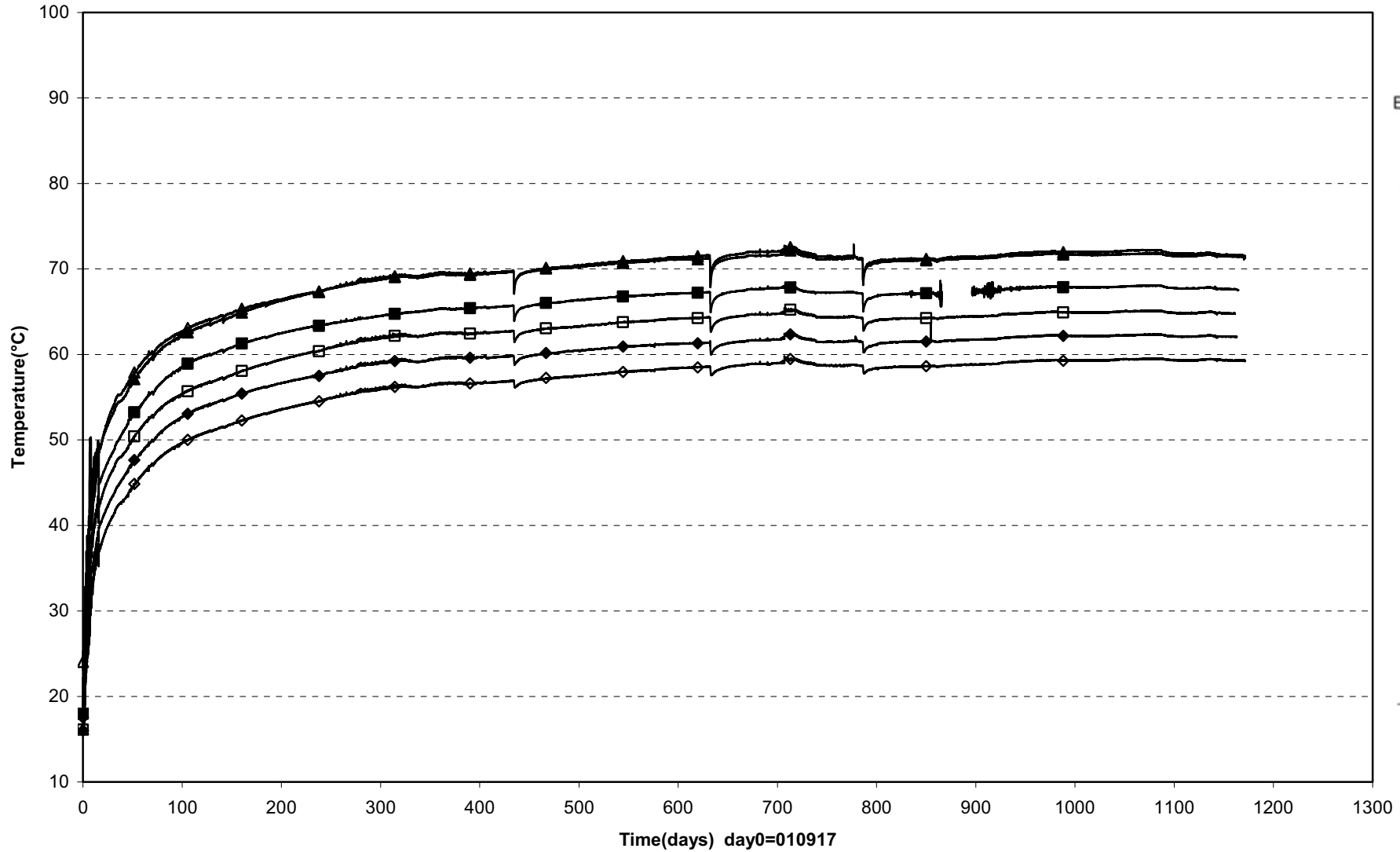

■ TBU10011(2.980\0°\0.635)	◆ TBU10012(2.980\0°\0.735)	▲ TBU10013(2.980\90°\0.585)
□ TBU10014(2.980\90°\0.685)	◇ TBU10015(2.980\90°\0.785)	△ TBU10016(2.980\175°\0.585)

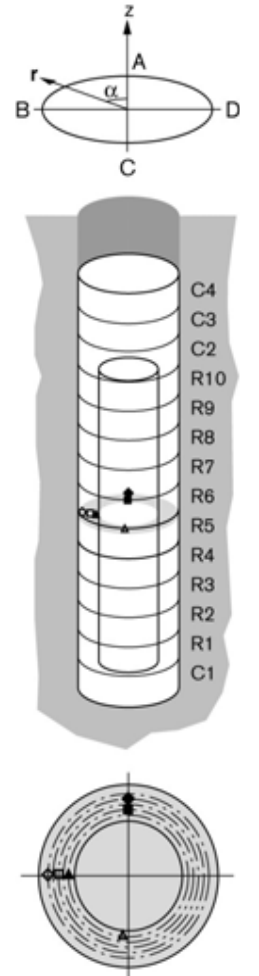

Prototype\Hole 1 \Ring5 (010917-041201)
 Temperature - Pentronic

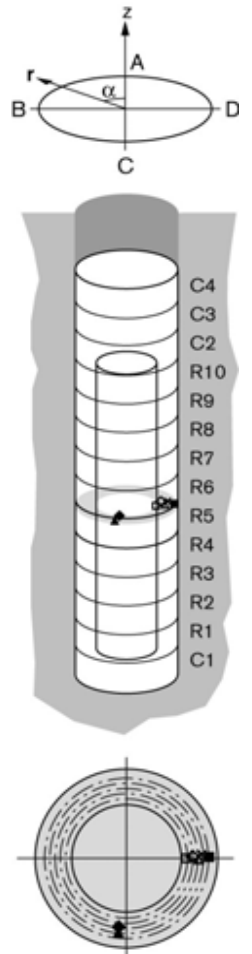
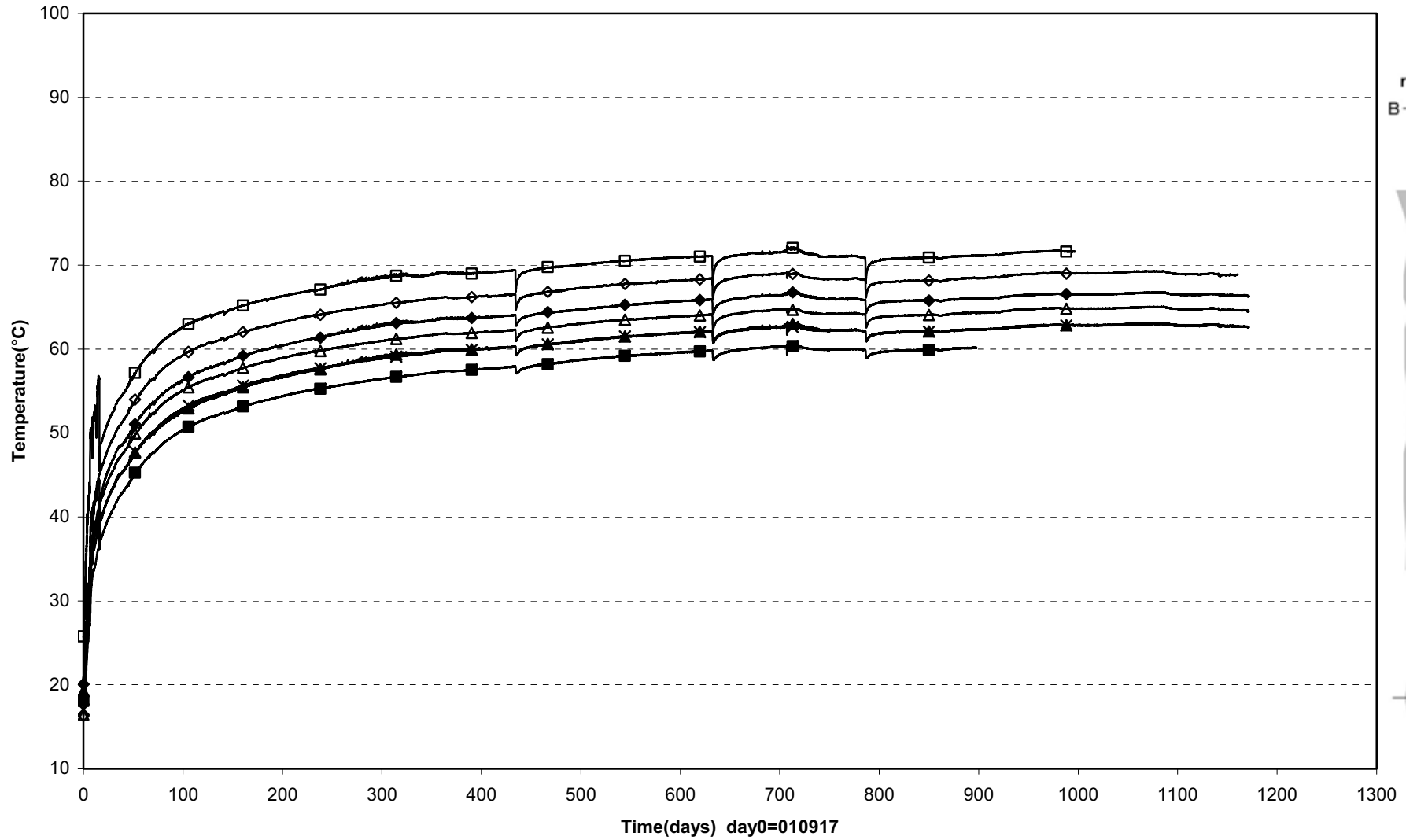

Prototype\Hole 1 \Ring10 (010917-041201)
 Temperature - Pentronic

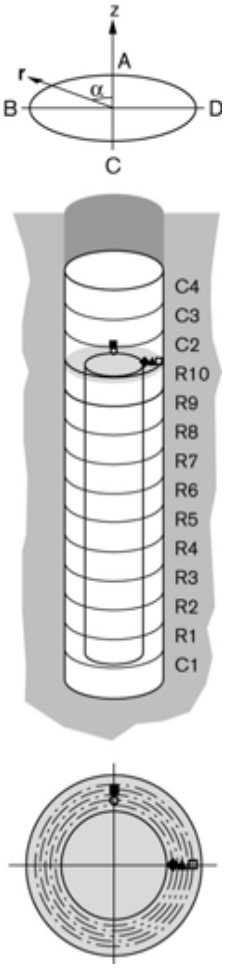
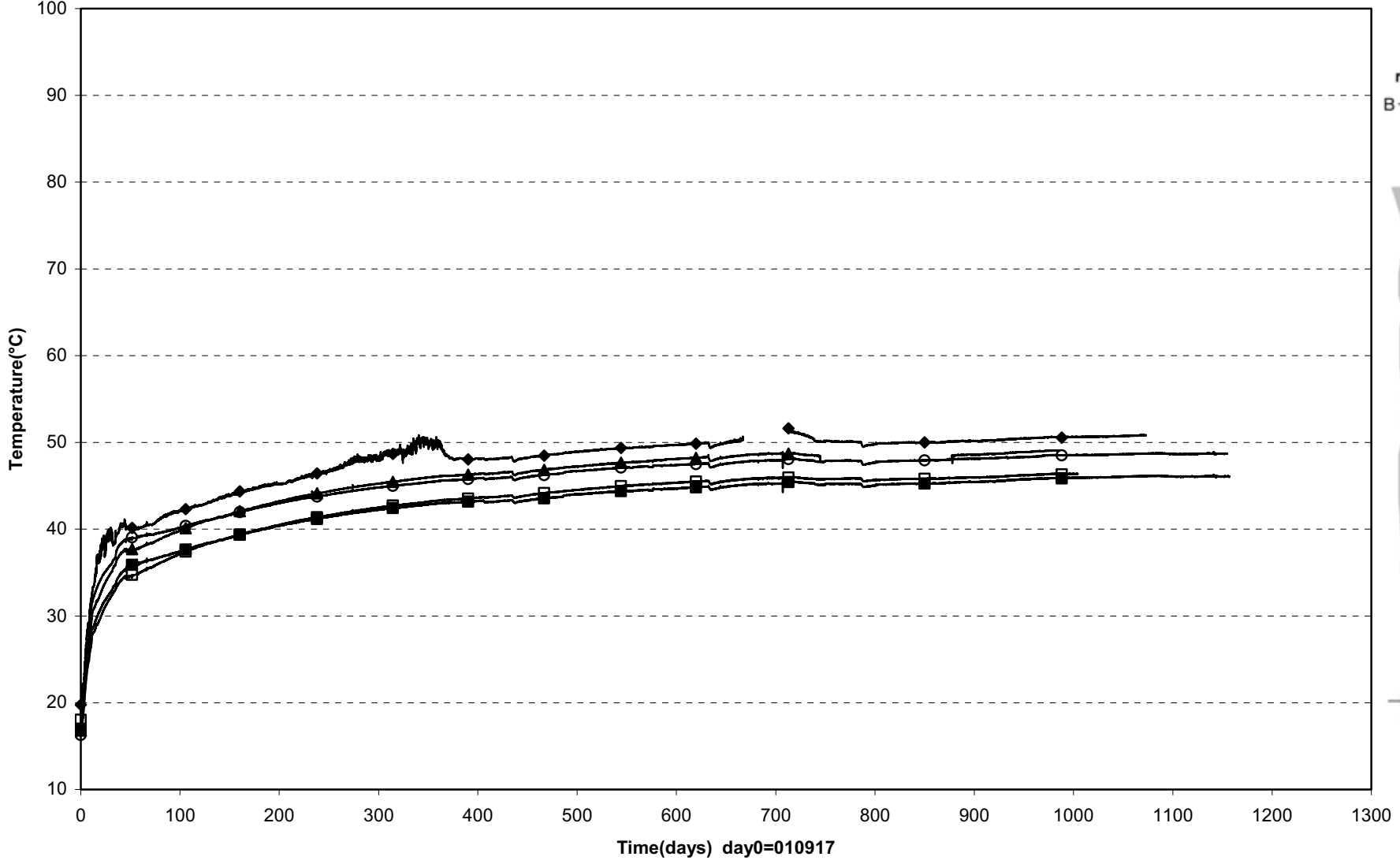

○ TBU10024(5.508\0°\0.635) ■ TBU10025(5508\0°\735) ◆ TBU10026(5508\270°\585) ▲ TBU10027(5.508\270°\0.685) □ TBU10028(5.508\270°\0.785)

Prototype\Hole 1 \Cyl.3 and Cyl.4 (010917-041201)
 Temperature - Pentronic

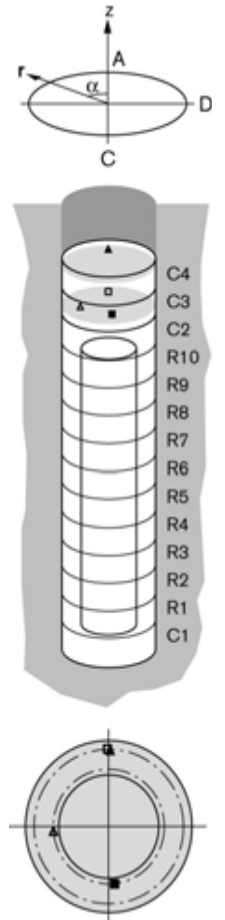
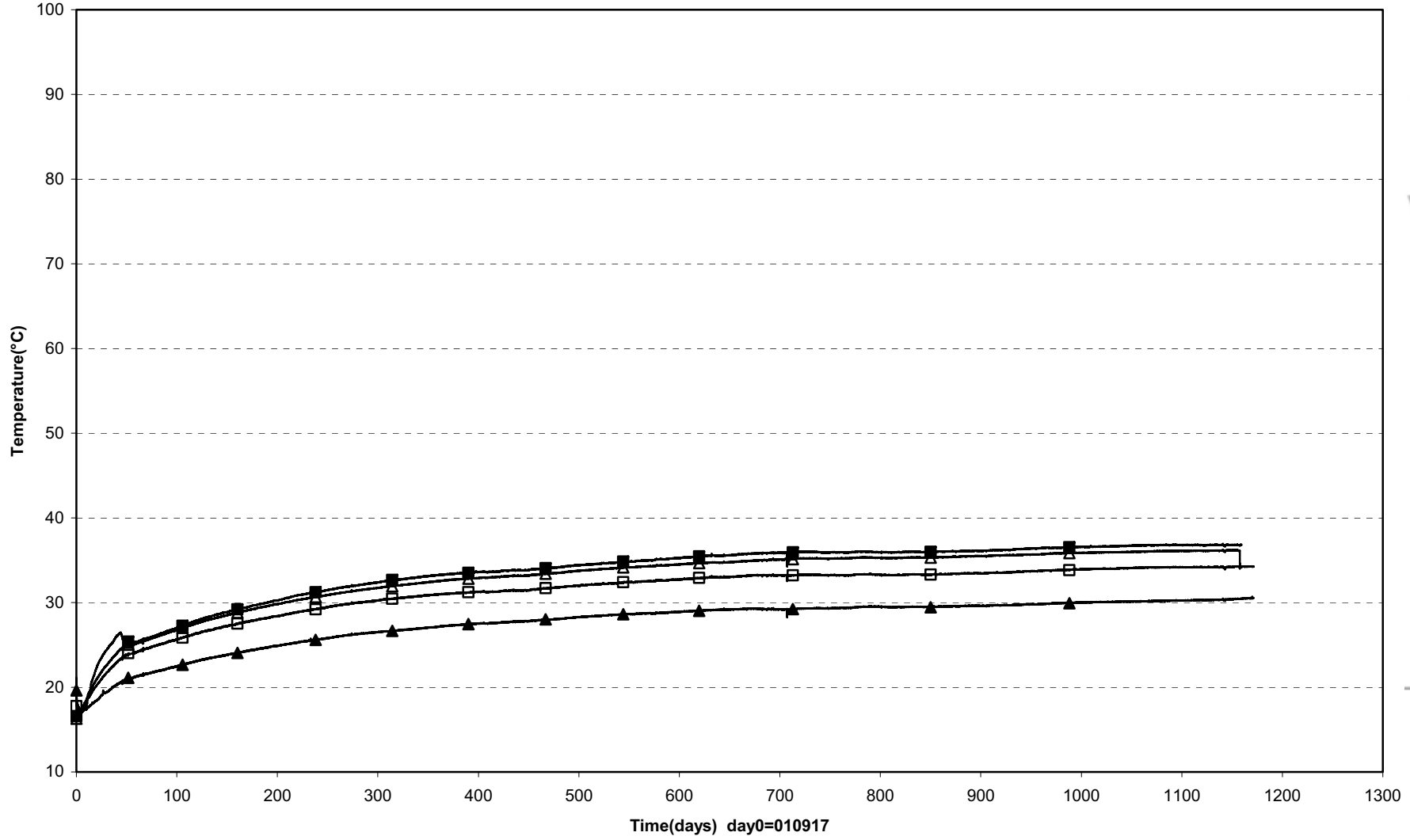

□ TBU10029(6.317\0°\0.785) △ TBU10030(6.317\95°\0.585) ■ TBU10031(6.317\185°\0.585) ▲ TBU10032(7.026\0°\0.785)

Prototype\Rock\Hole 1 (010917-041201)
 Temperature - Pentronic

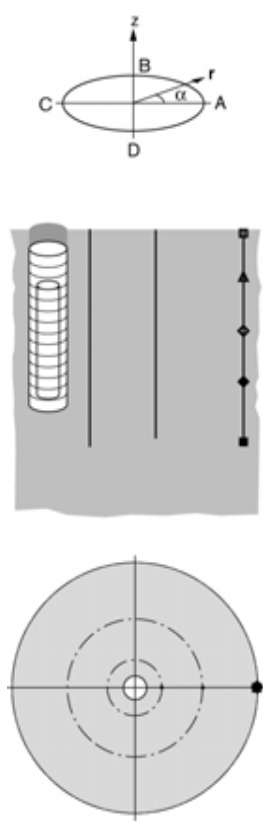
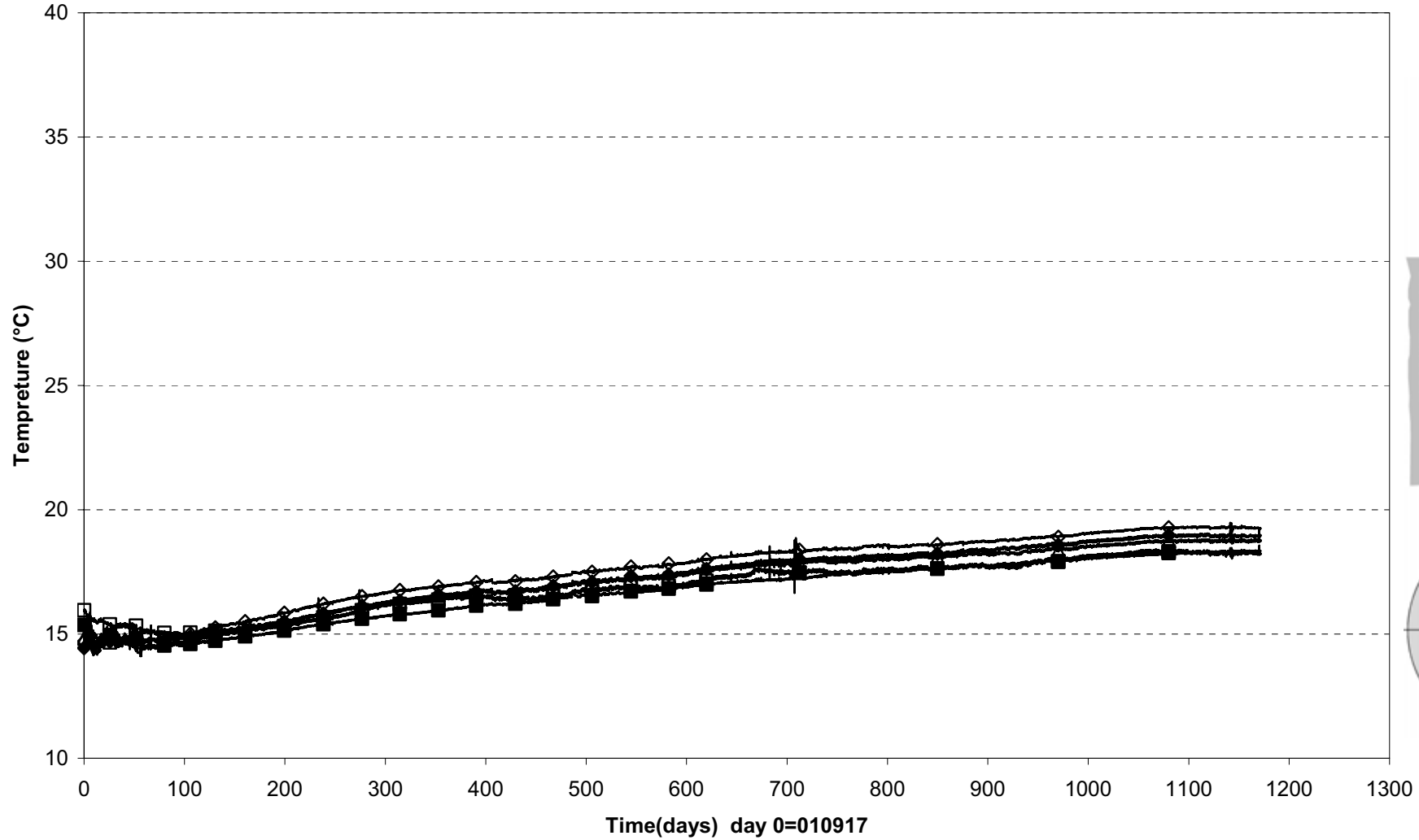

□ TROA350 (7.784\360°\9.086) Δ TROA340 (5.784\360°\9.086) ◇ TROA330(3.384\0°\9.086) ◆ TROA320(9.85\0°\9.087) ■ TROA310(-1.715\0°\9.086)

Prototype\Rock\Hole 1 (010917-041201)
 Temperature - Pentronic

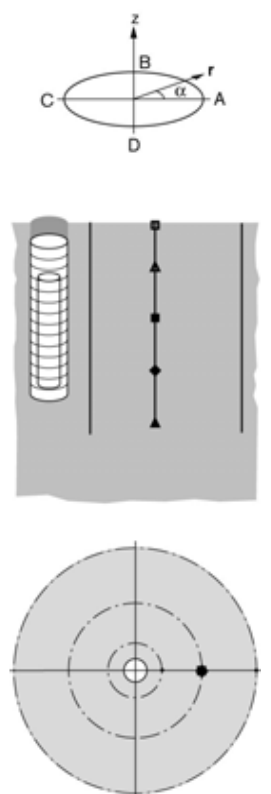
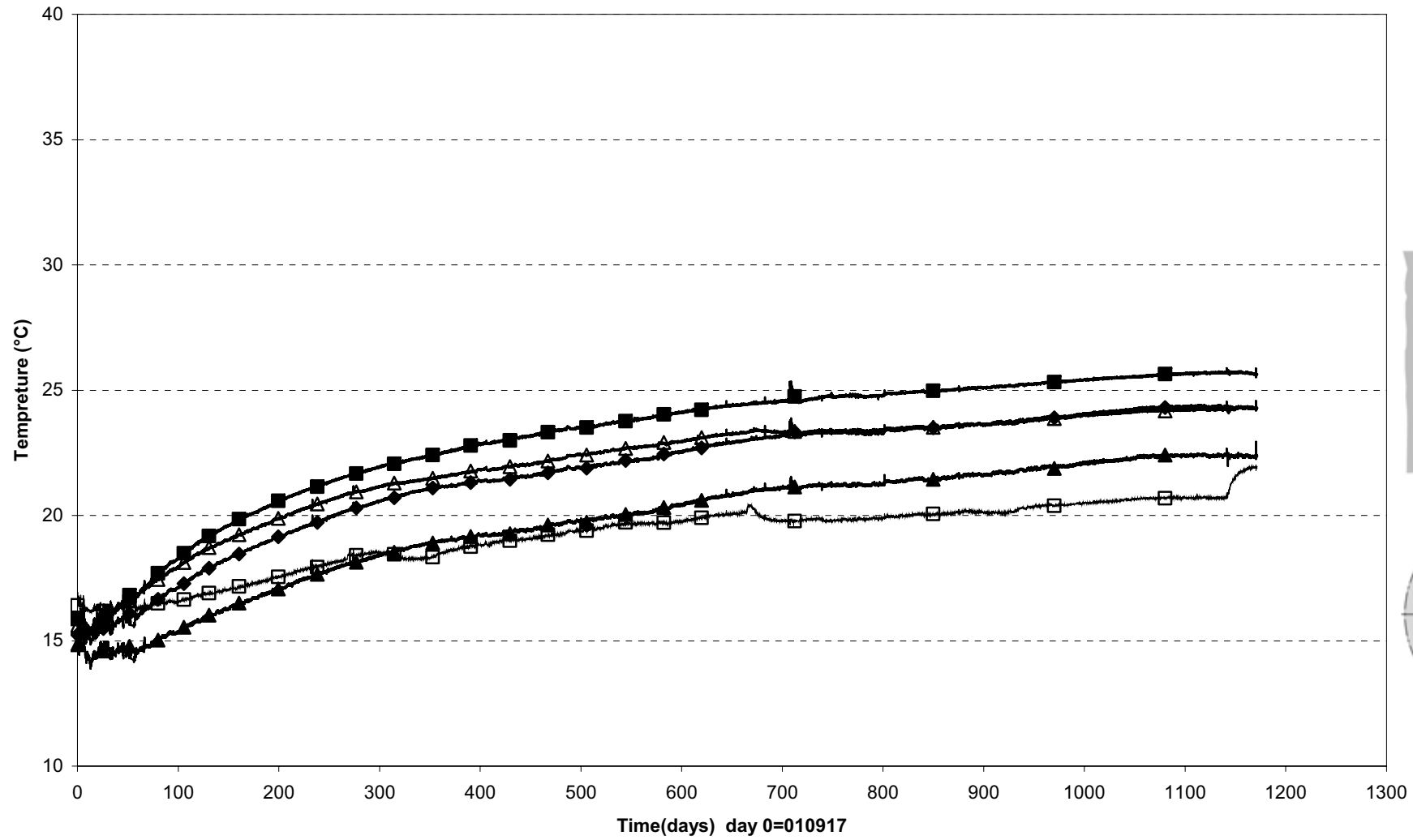

□ TROA650(7.921\360°\4.966) △ TROA640(5.921\360°\4.988) ■ TROA630(3.521\360°\4.978) ◆ TROA620(1.121\360°\4.968) ▲ TROA610(-1.479\360°\4.956)

Prototype\Rock\Hole 1 (010917-041201)
 Temperature - Pentronic

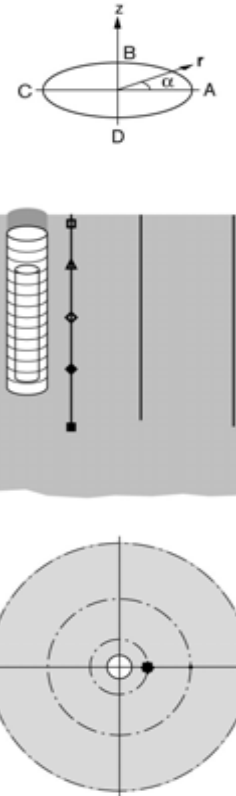
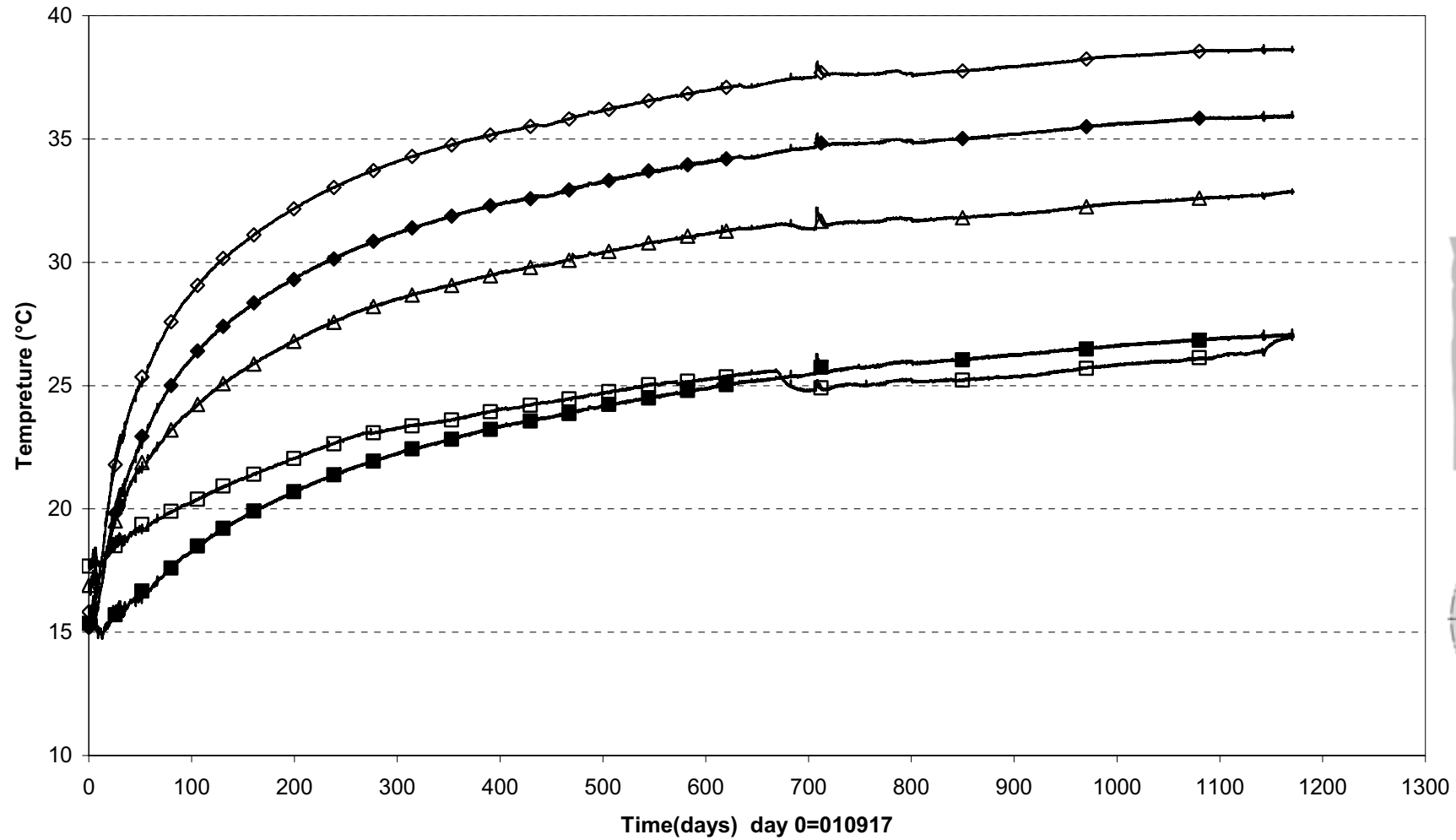

□ TROA1050(7.662\359°\2.020) Δ TROA1040(5.662\359°\2.028) ◇ TROA1030(3.262\359°\2.038) ◆ TROA1020(0.862\359°\2.048) ■ TROA1010(-1.838\359°\2.059)

Prototype\ Hole 1 (010917-041201)
Canister power

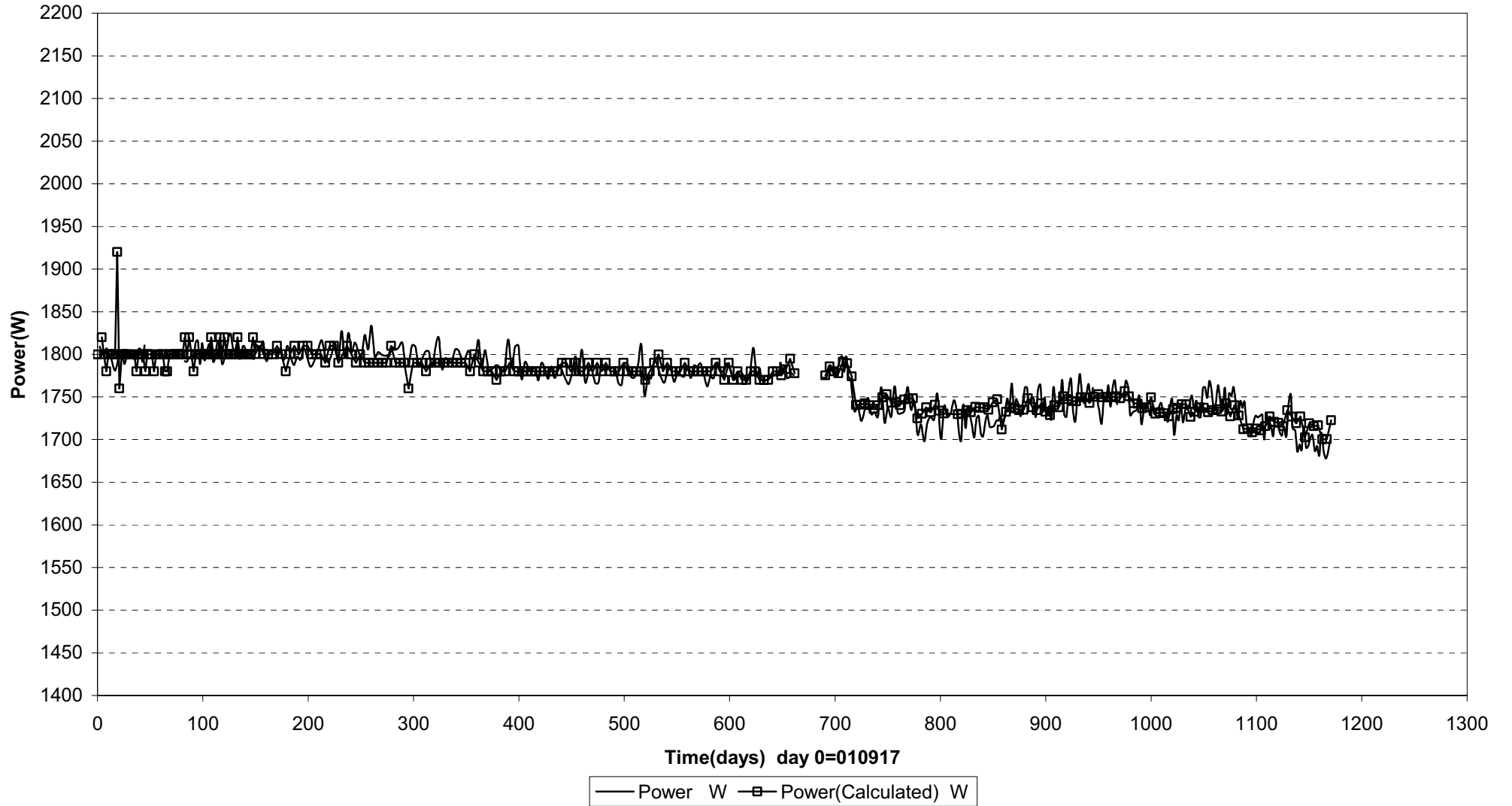

Prototype\ Hole 1 \Canister (010917-041201)
 Max. temperature on the canister surface - Optical fiber cables

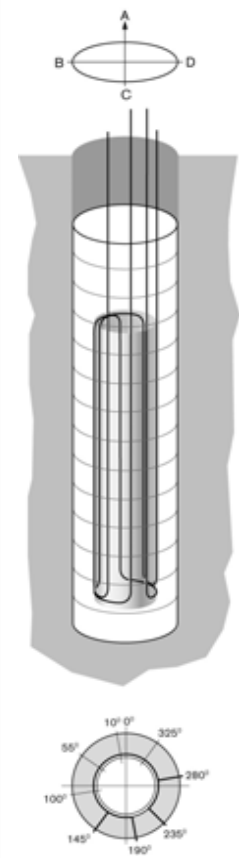
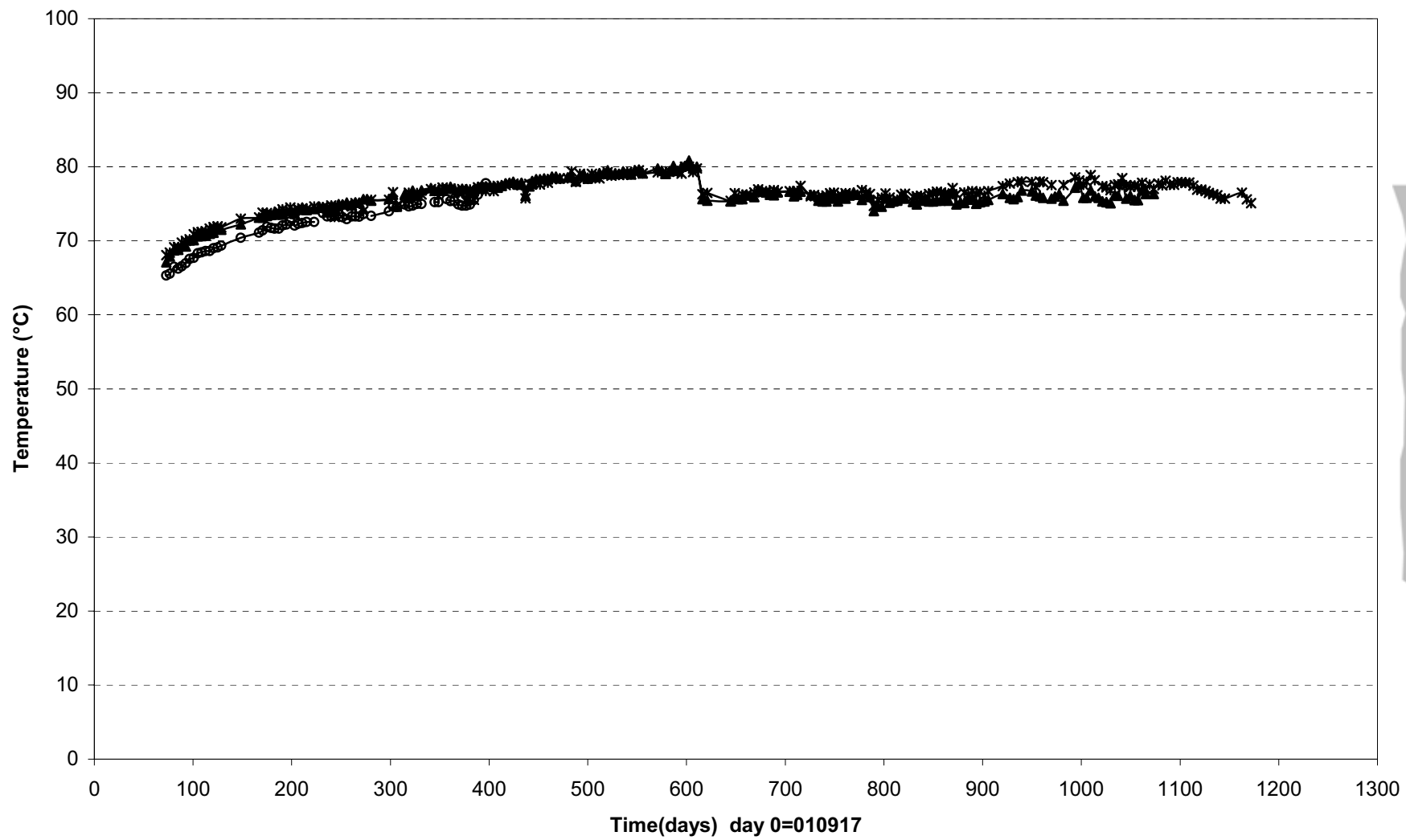

○ Cable 1, outlet °C * Cable 1, inlet °C ▲ Cable 2, outlet °C

Prototype\ Hole 1 \ Canister (041201)
Temperature profile on the canister surface - Optical fiber cables

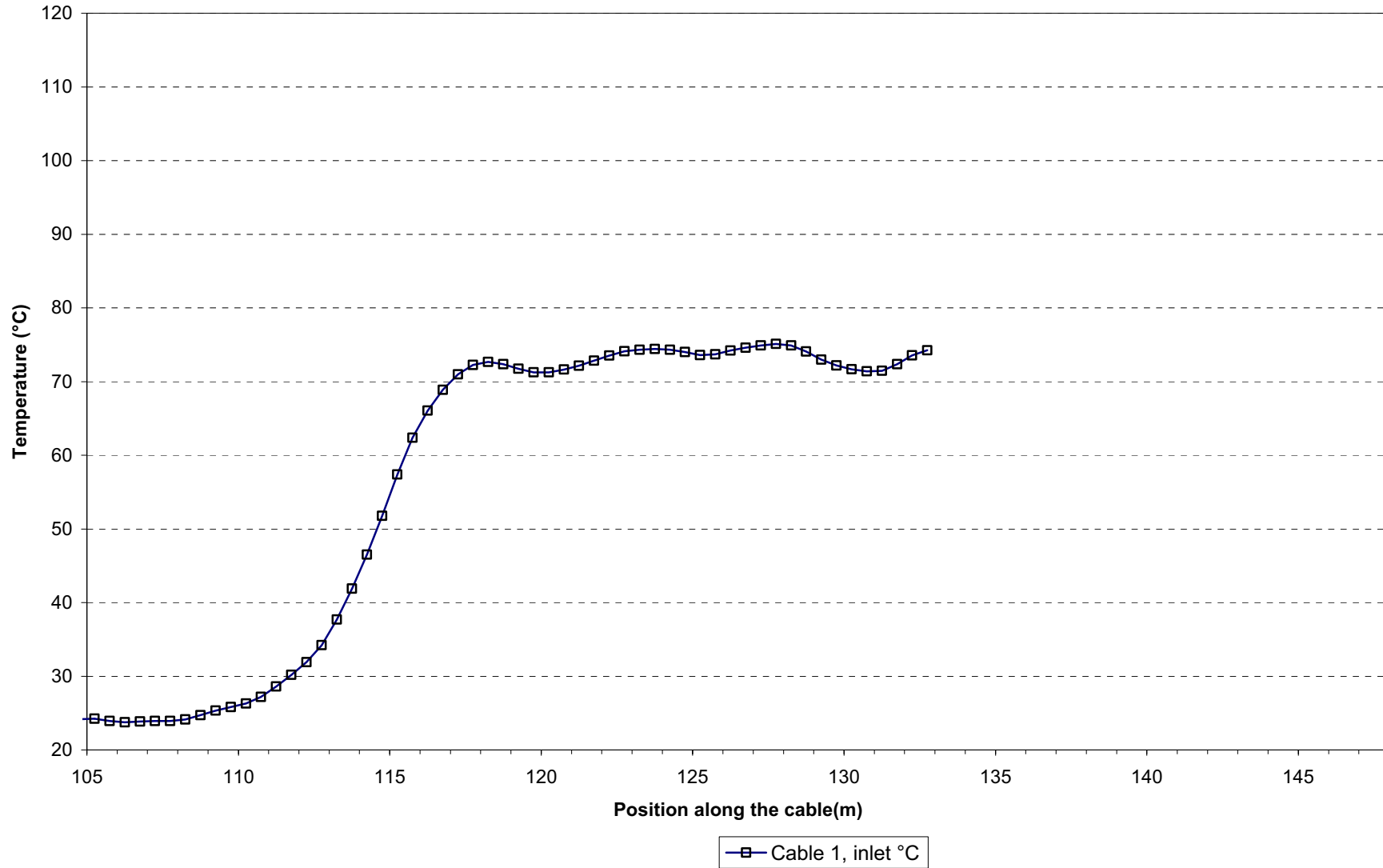

Appendix 2

Dep. hole 3

Prototype\Hole 3\Cyl.1 (010917-041201)
Total pressure - Geokon

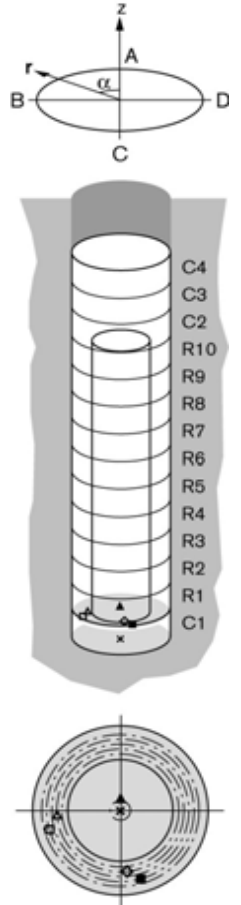
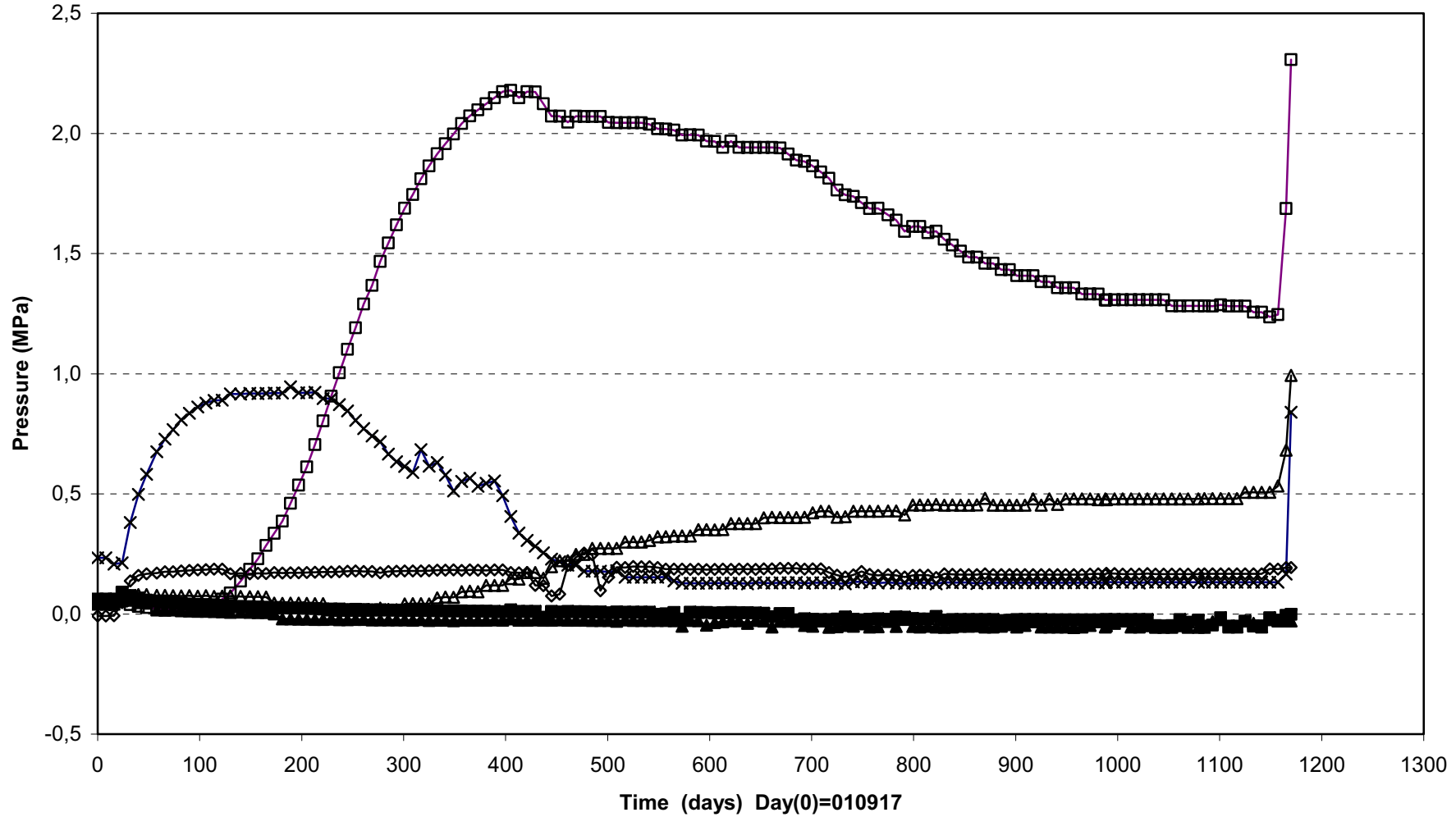

- | | | |
|-------------------------------|--------------------------------|--------------------------------|
| —x— PBU30001(0\0°\0) | —▲— PBU30002(0.495\0°\0.100) | —◇— PBU30008(0.495\185°\0.635) |
| —△— PBU30006(0.495\95°\0.635) | —□— PBU30007(0.495\105°\0.735) | —■— PBU30009(0.495\195°\0.735) |

Prototype\Hole 3 \Ring5 (010917-041201)
 Total pressure - Geokon

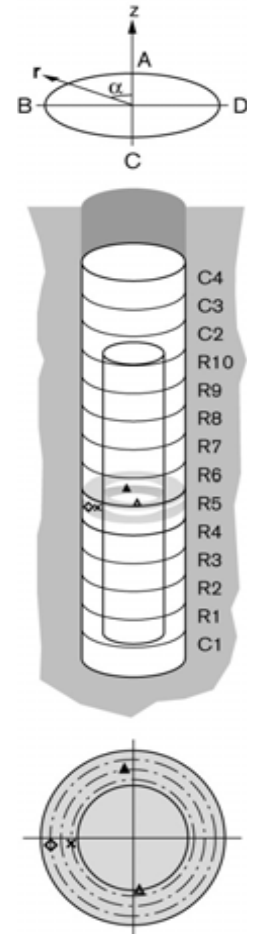
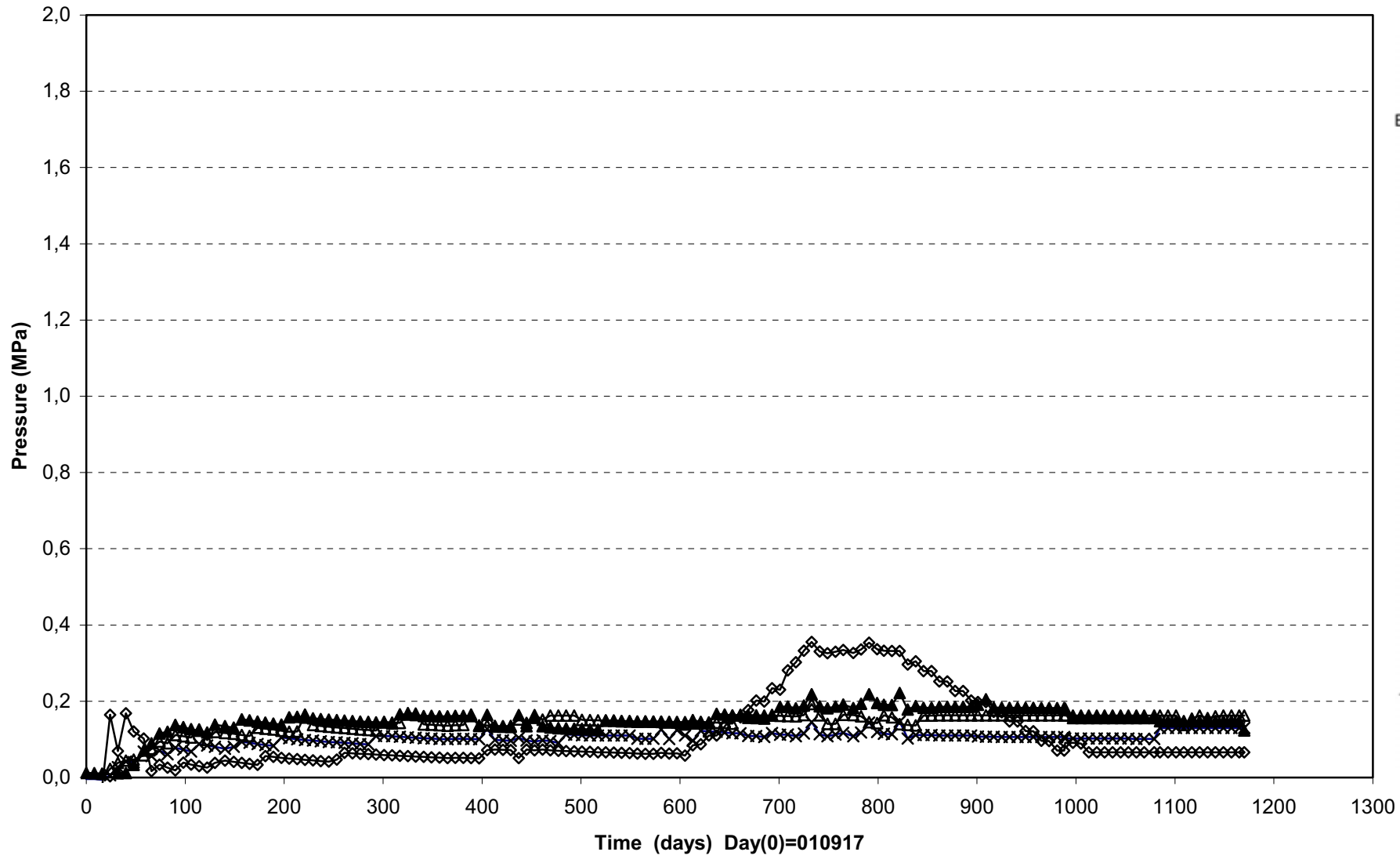

—x— PBU30013(2.771\95°\0.585) —▲— PBU30011(2.771\5°\0.685) —◇— PBU30014(2.771\95°\0.785) —△— PBU30015(3.021\185°\0.535)

Prototype\Hole 3\Ring10 and Cyl.3 (010917-041201)
 Total pressure - Geokon

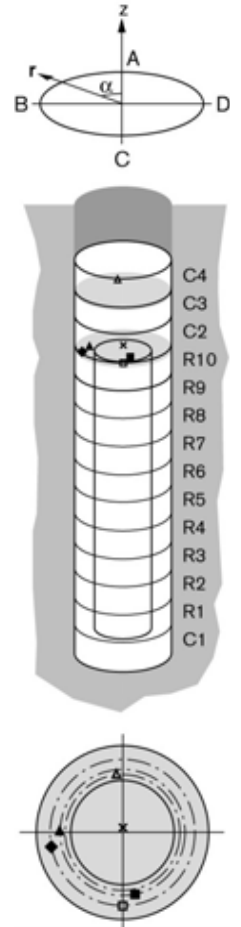
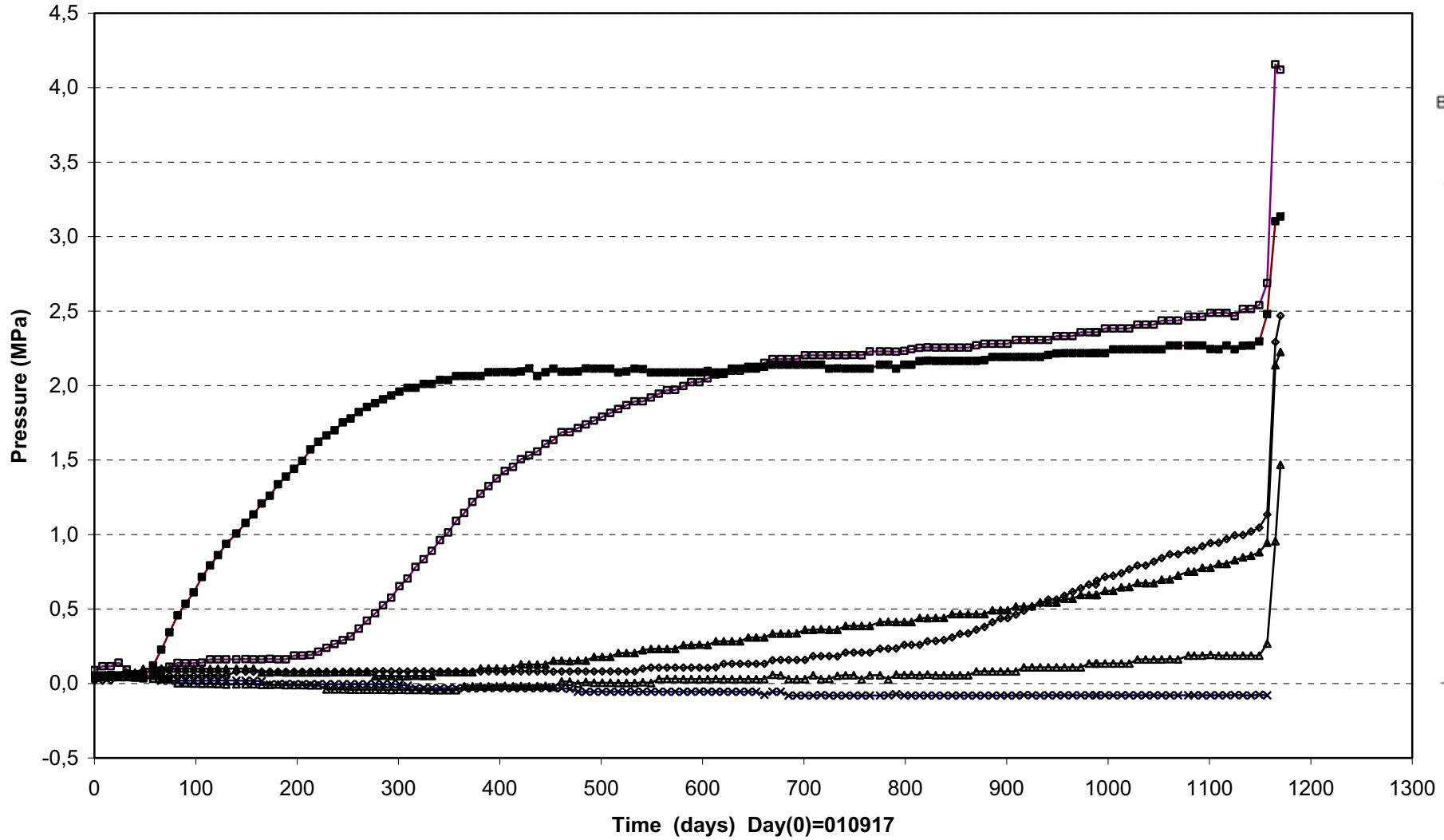

- | | | |
|------------------------------|--------------------------------|--------------------------------|
| —x— PBU30017(5.556\0°\0.050) | —▲— PBU30021(5.556\90°\0.635) | —◆— PBU30022(5.556\100°\0.735) |
| —△— PBU30026(6.654\5°\0.585) | —◻— PBU30023(5.556\190°\0.735) | —■— PBU30024(5.556\190°\0.635) |

Prototype\Hole 3 \Cyl.1 and Ring5 (010917-0401201)
Total pressure - Kulite

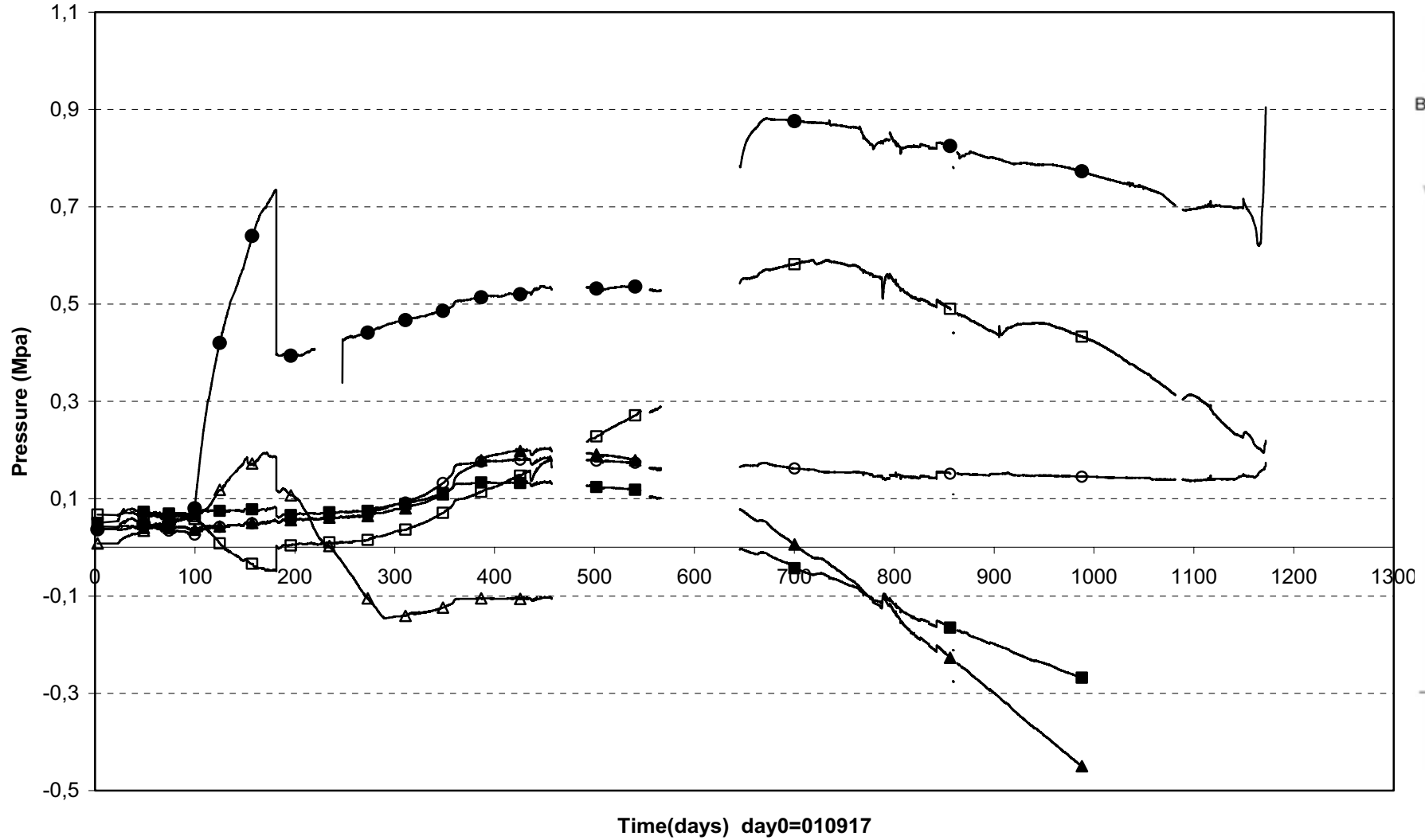

- | | | | |
|----------------------------|------------------------------|----------------------------|----------------------------|
| □ PBU30003(Cyl.1\5°\0.585) | ▲ PBU30004(Cyl.1\5°\0.685) | ○ PBU30005(Cyl.1\5°\0.785) | △ PBU30010(Ring5\5°\0.585) |
| ● PBU30012(Ring5\5°\0.825) | ■ PBU30016(Ring5\185°\0.825) | | |

Prototype\Hole 3\Ring10 and Cyl.3-4 (010917-041201)
 Total pressure - Kulite

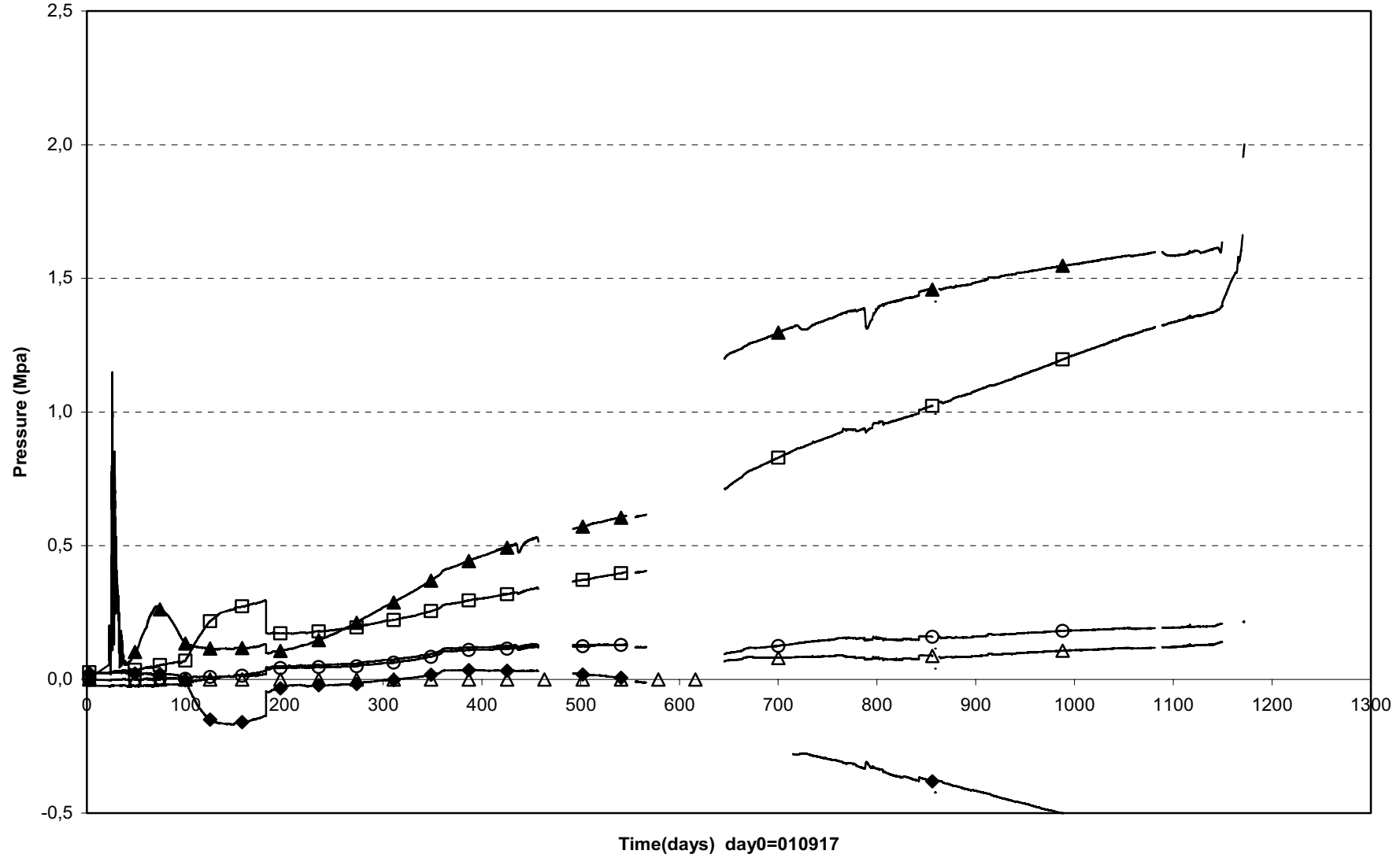

◆ PBU30018(Ring10\5°\0.585) □ PBU30019(Ring10\5°\0.685) ▲ PBU30020(Ring10\5°\0.785) ○ PBU30025(Cyl.3\0°\0.050) △ PBU30027(Cyl.4\0°\0.050)

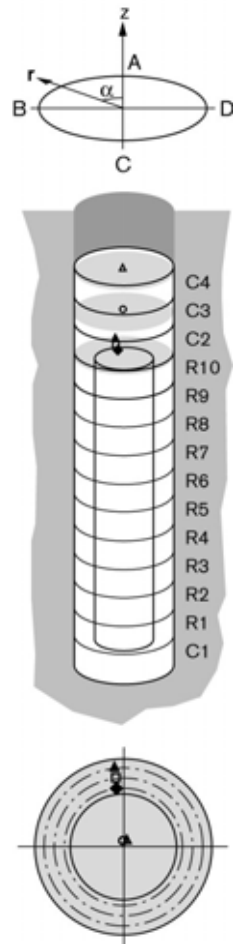

Prototype\Hole 3\Cyl.1 (010917-041201)
Relative humidity - Vaisala

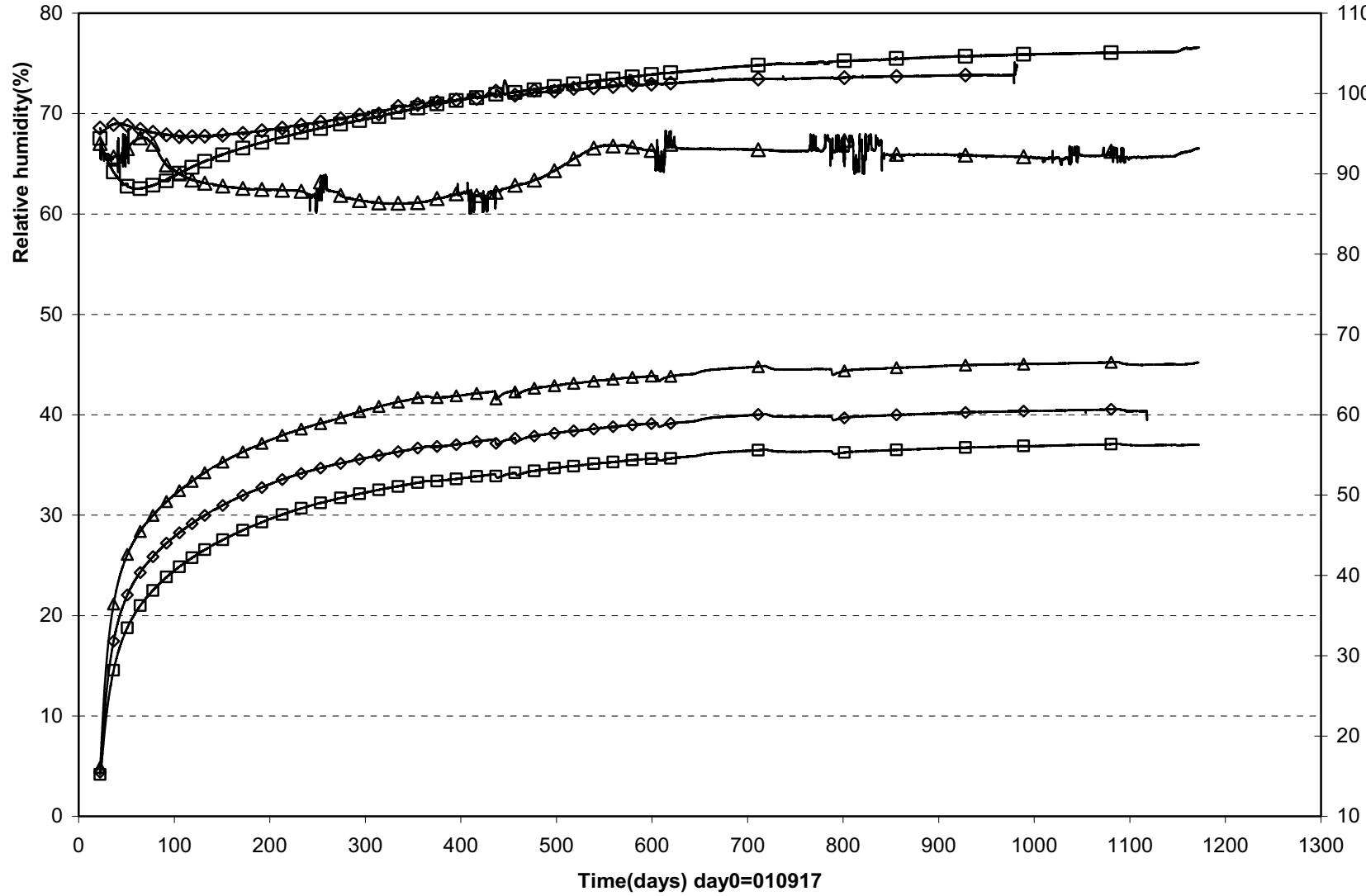

□ WBU30004(0.335\350°\0.785) ◇ WBU30005(0.335\350°\0.685) △ WBU30006(0.335\350°\0.585)

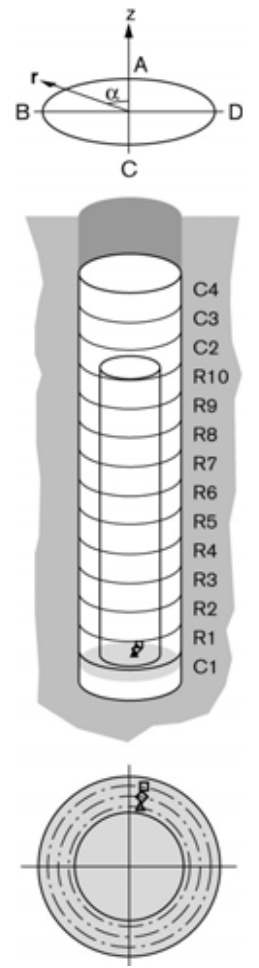

Prototype\Hole 3\Ring 5 (010917-041201)
Relative humidity - Vaisala

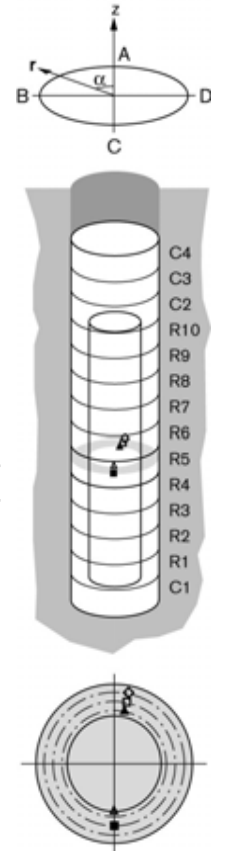
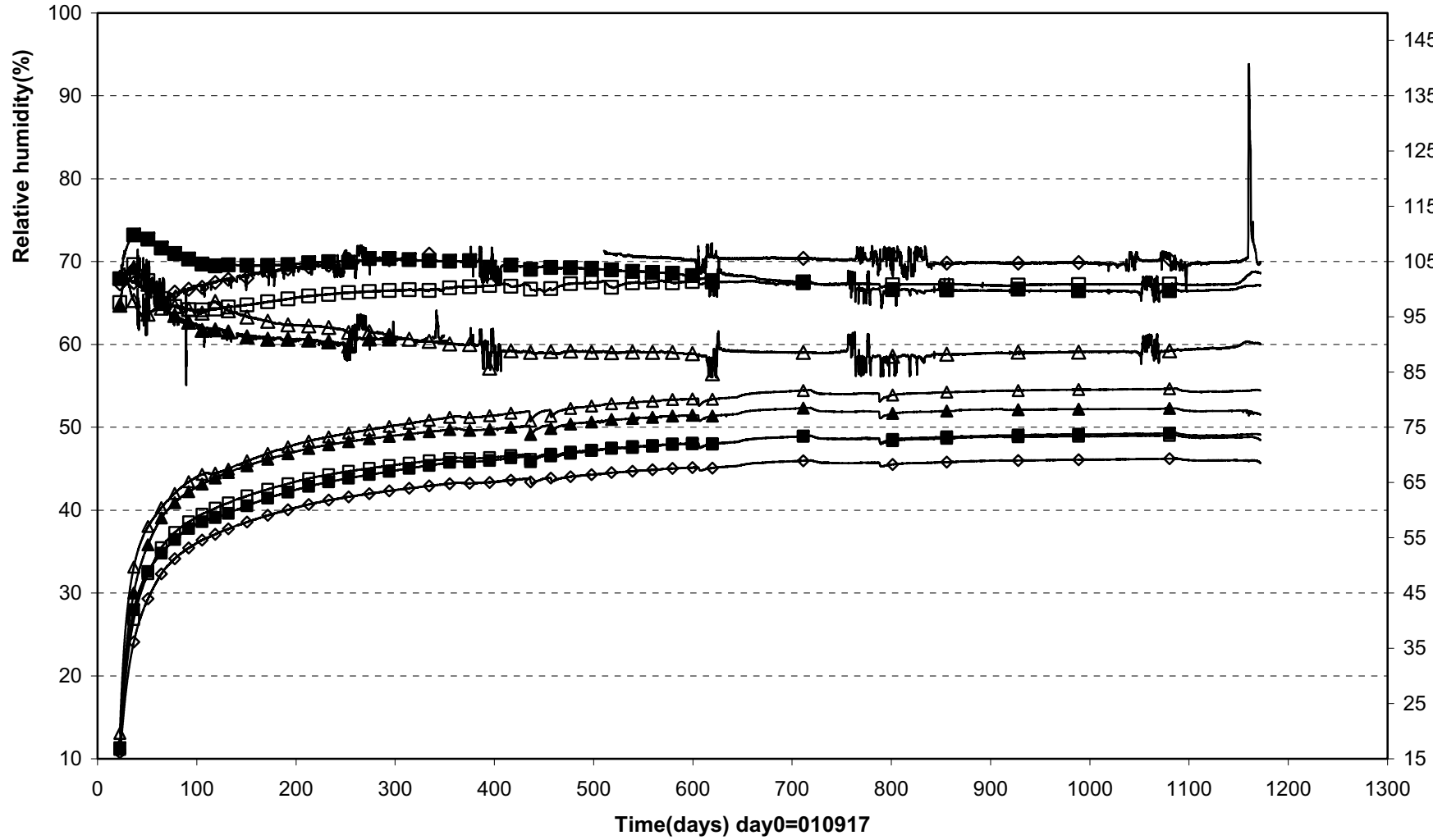

- ▲ WBU30013(2.840\350°\0.585)
- WBU30014(2.840\350°\0.685)
- ◇ WBU30015(2.840\350°\0.785)
- △ WBU30019(2.840\180°\0.535\In the slot)
- WBU30020(2.840\180°\0.685)

Prototype\Hole 3\Ring 10 (010917-041201)
Relative humidity - Vaisala

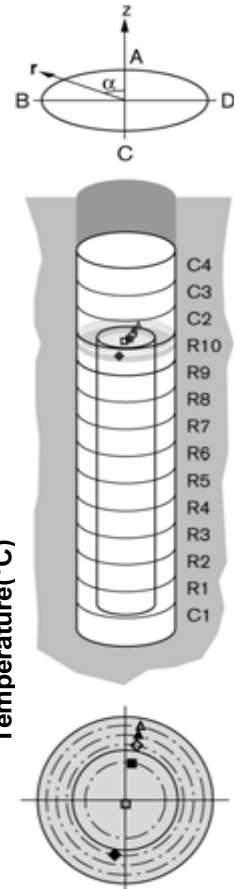
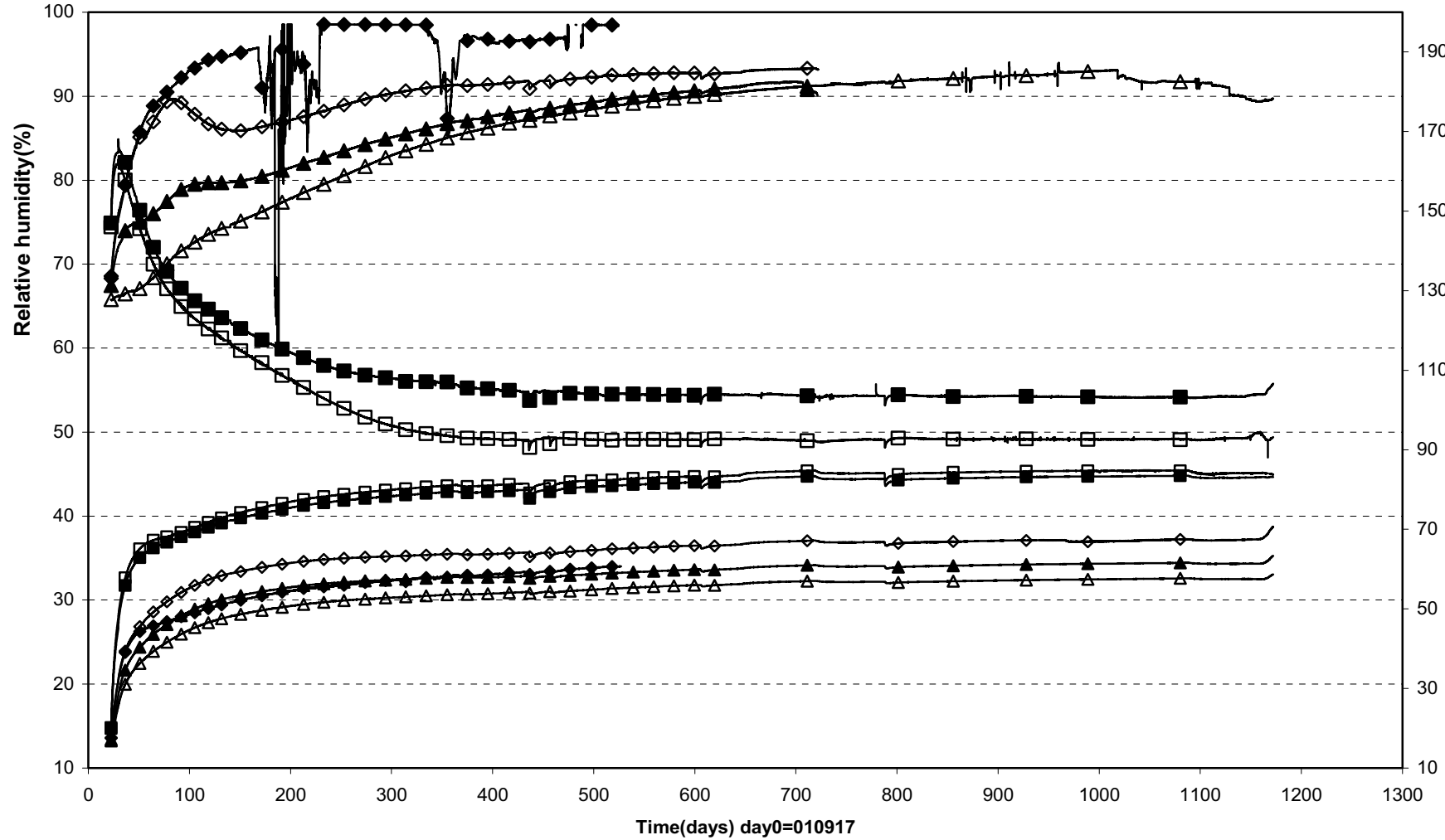

□ WBU30022(5.416\180°\0.050) ■ WBU30023(5.396\352°\0.262) ◇ WBU30024(5.396\350°\0.585) △ WBU30025(5.396\350°\0.785))
 ▲ WBU30026(5.396\350°\0.685) ◆ WBU30030(5.396\170°\0.585)

Prototype\Hole 3\Cyl.3 and Cyl.4 (010917-041201)
 Relative humidity - Vaisala

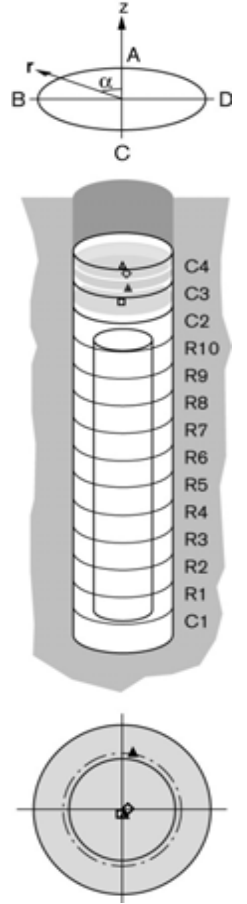
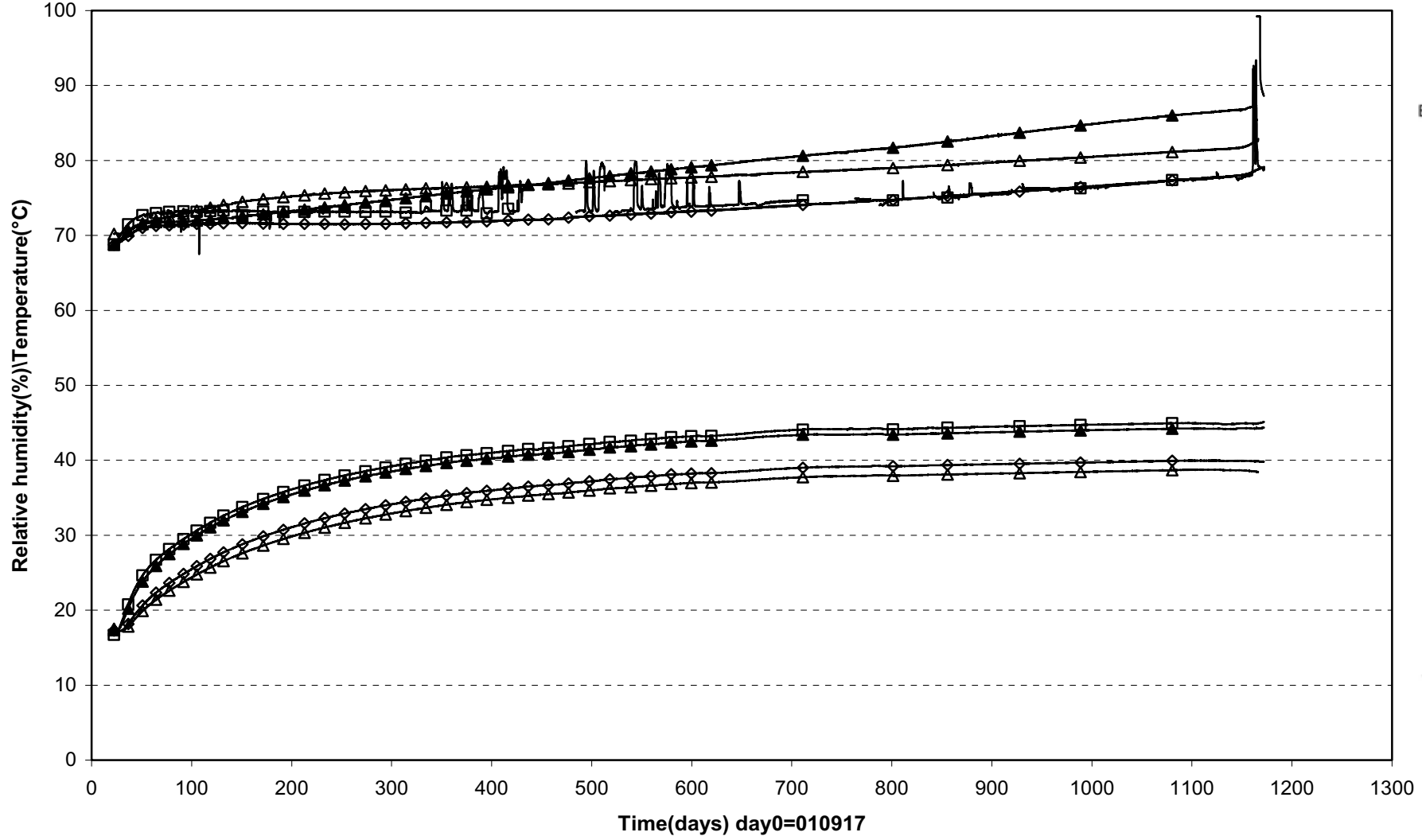

□ WBU30032(6.314\180°\0.050) ▲ WBU30033(6.314\350°\0.585) △ WBU30036(6.680\180°\0.050) ◇ WBU30037(6.840\270°\0.050)

Prototype\Hole 3\Cyl.1 (010917-041201)
Relative humidity - Rotronic

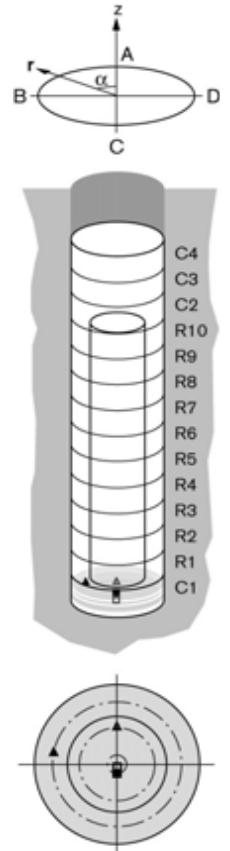
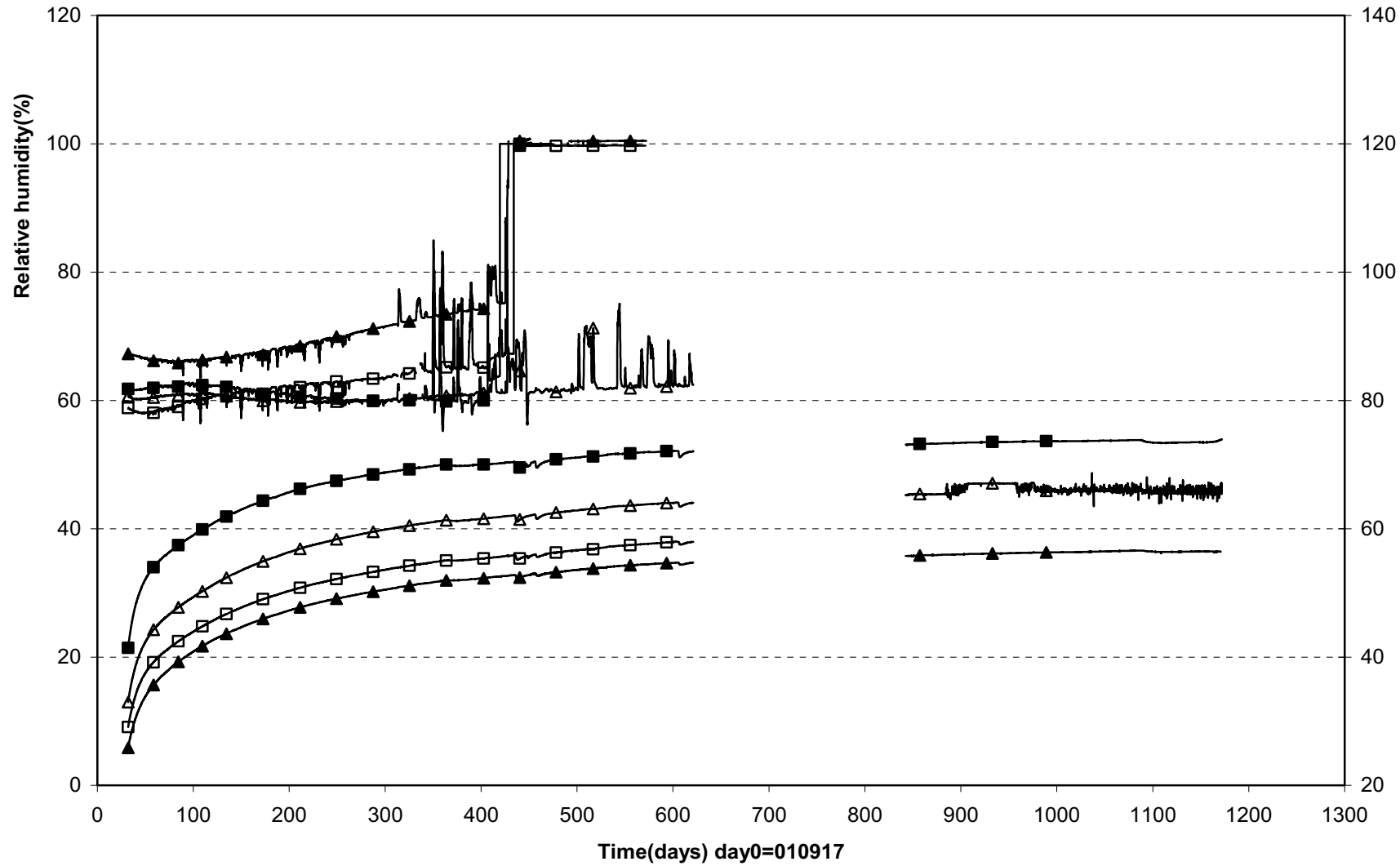

□ WBU30001(0.045\180°\0.050) △ WBU30002(0.215\0°\0.400) ■ WBU30003(0.245\180°\0.100) ▲ WBU30008(0.245\80°\0.685)

Prototype\Hole 3\Cyl.1 (010917-041201)
Relative humidity - Rotronic

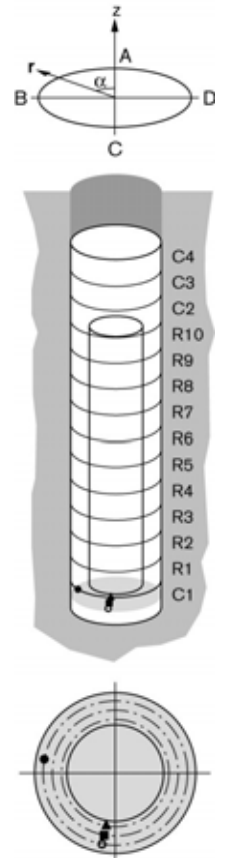
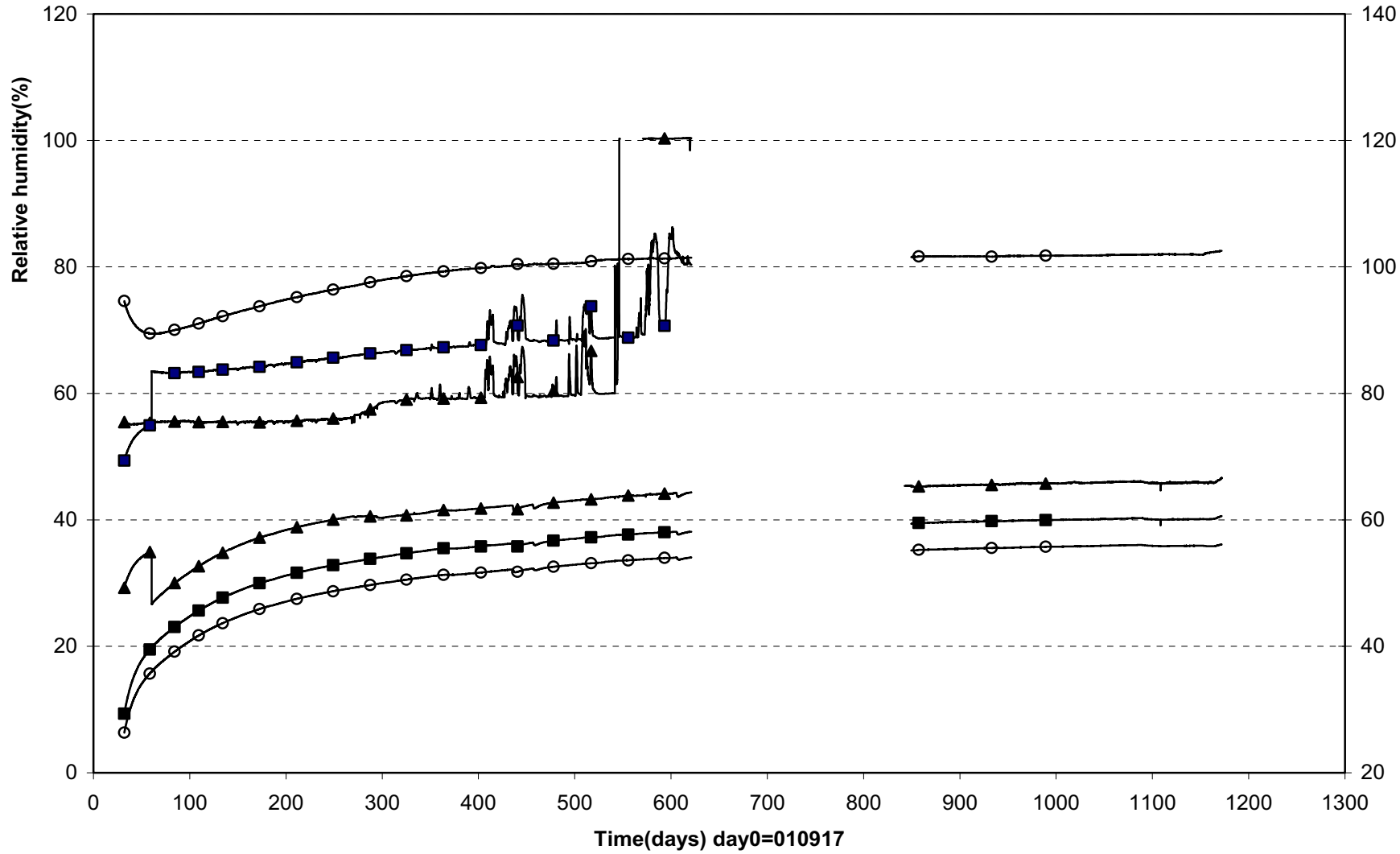

Prototype\Hole 3\Ring 5 (010917-041201)
Relative humidity - Rotronic

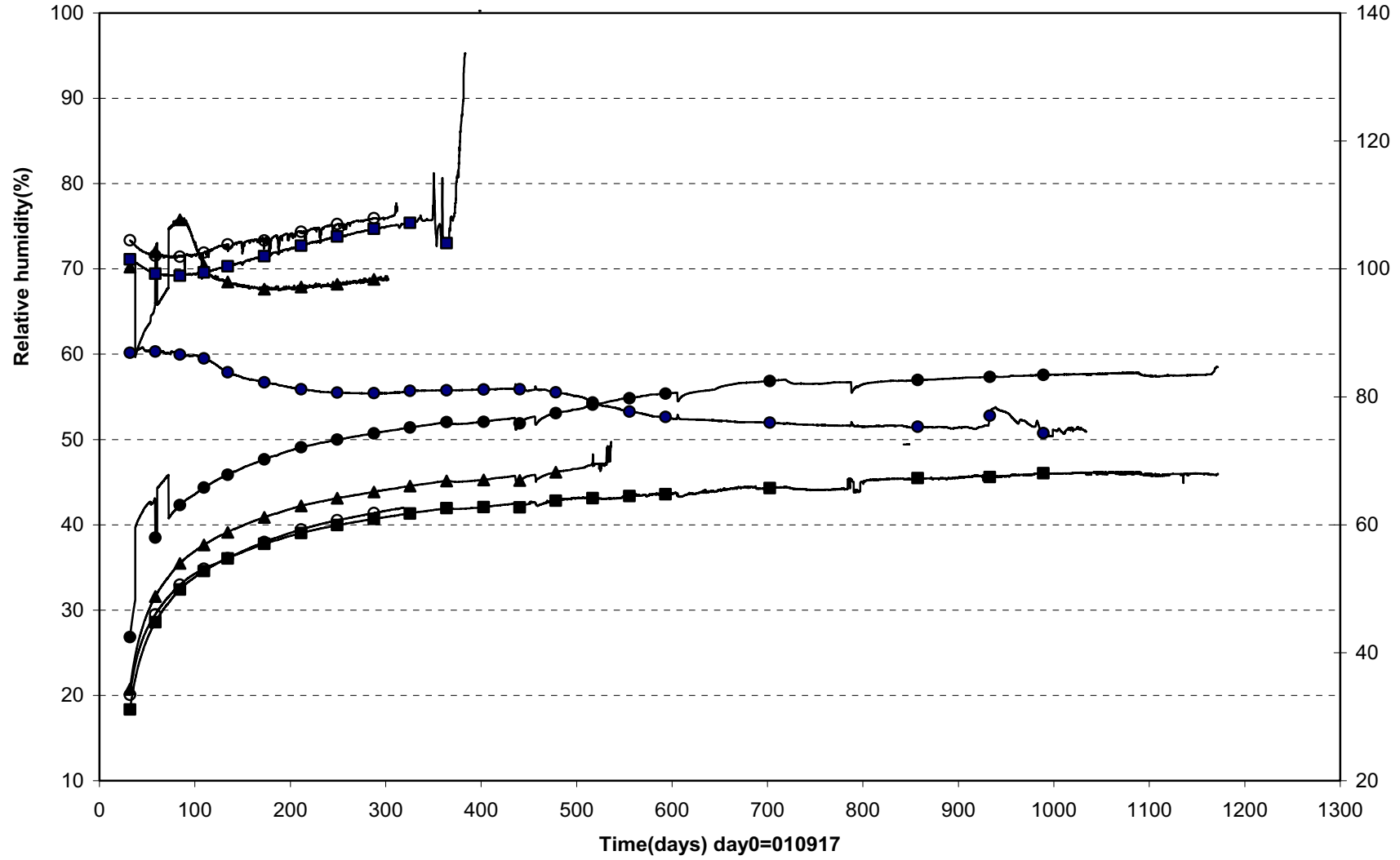

● WBU30016(2.750\80°\0.535) ▲ WBU30017(2.750\80°\0.685) ■ WBU30018(2.750\80°\0.785) ○ WBU30021(2.750\180°\0.785)

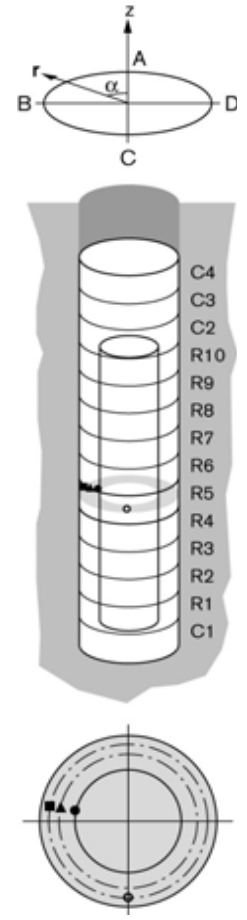

Prototype\Hole 3\Ring 10 (010917-041201)
Relative humidity - Rotronic

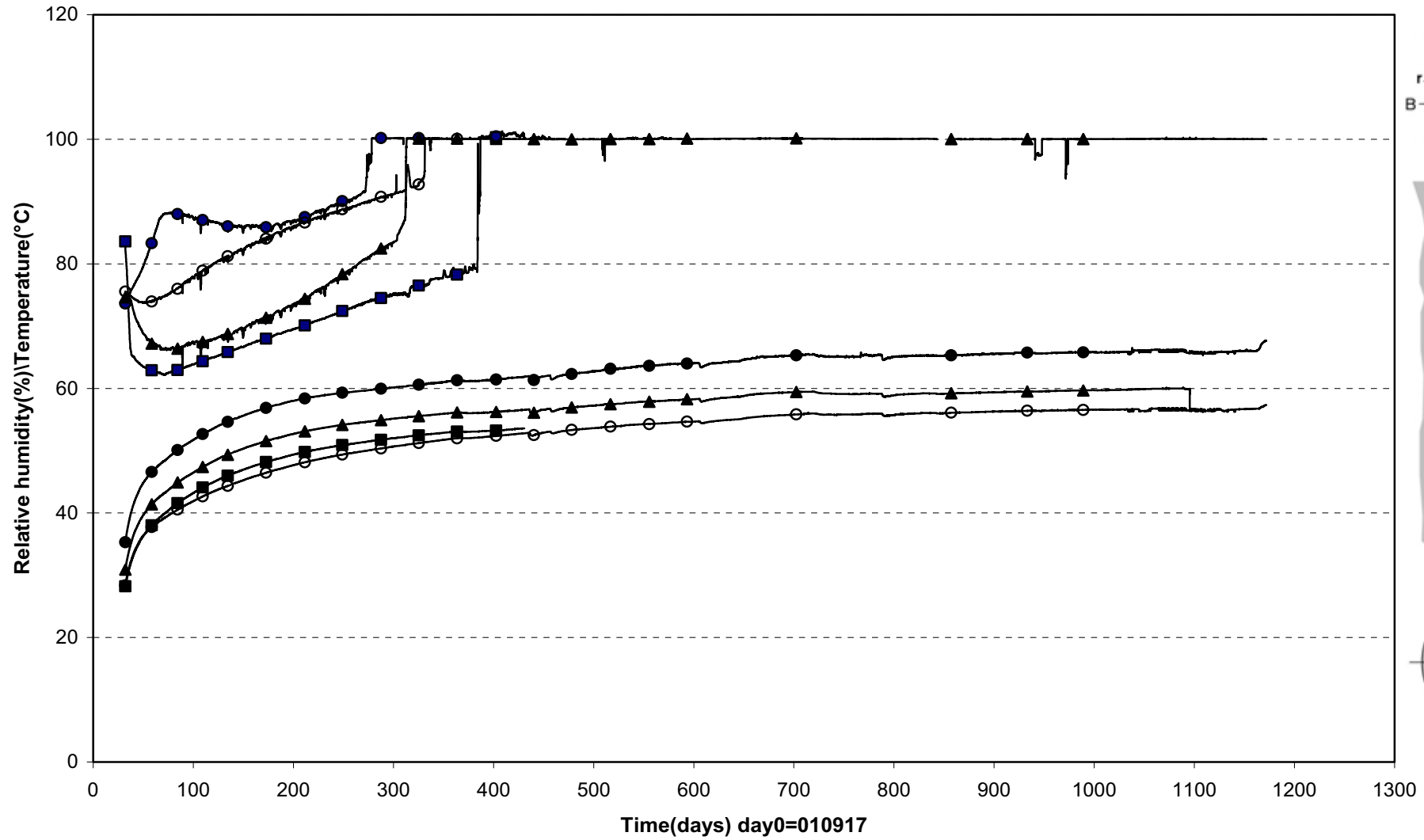

● WBU30027(5.306\80°\0.585) ▲ WBU30028(5.306\80°\0.685) ■ WBU30029(5.306\80°\0.785) ○ WBU30031(5.306\170°\0.785)

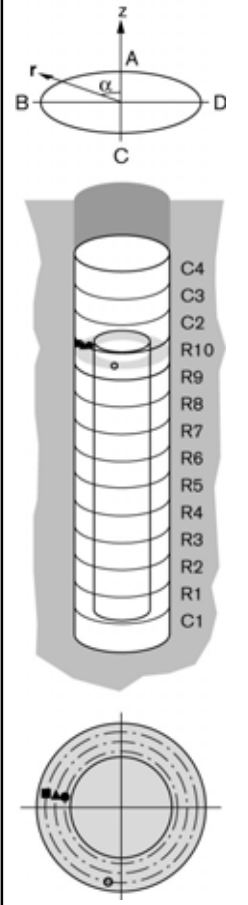

Prototype\Hole 3\Cyl.3 (010917-041201)
 Relative humidity - Rotronic

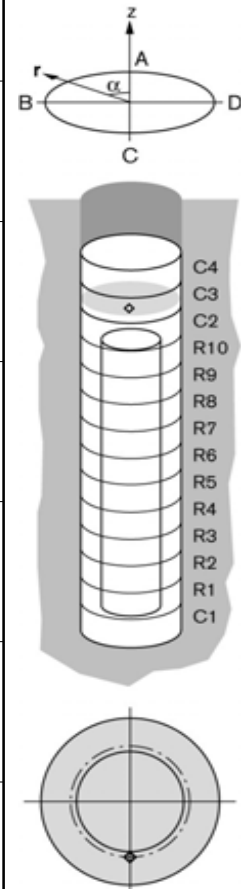
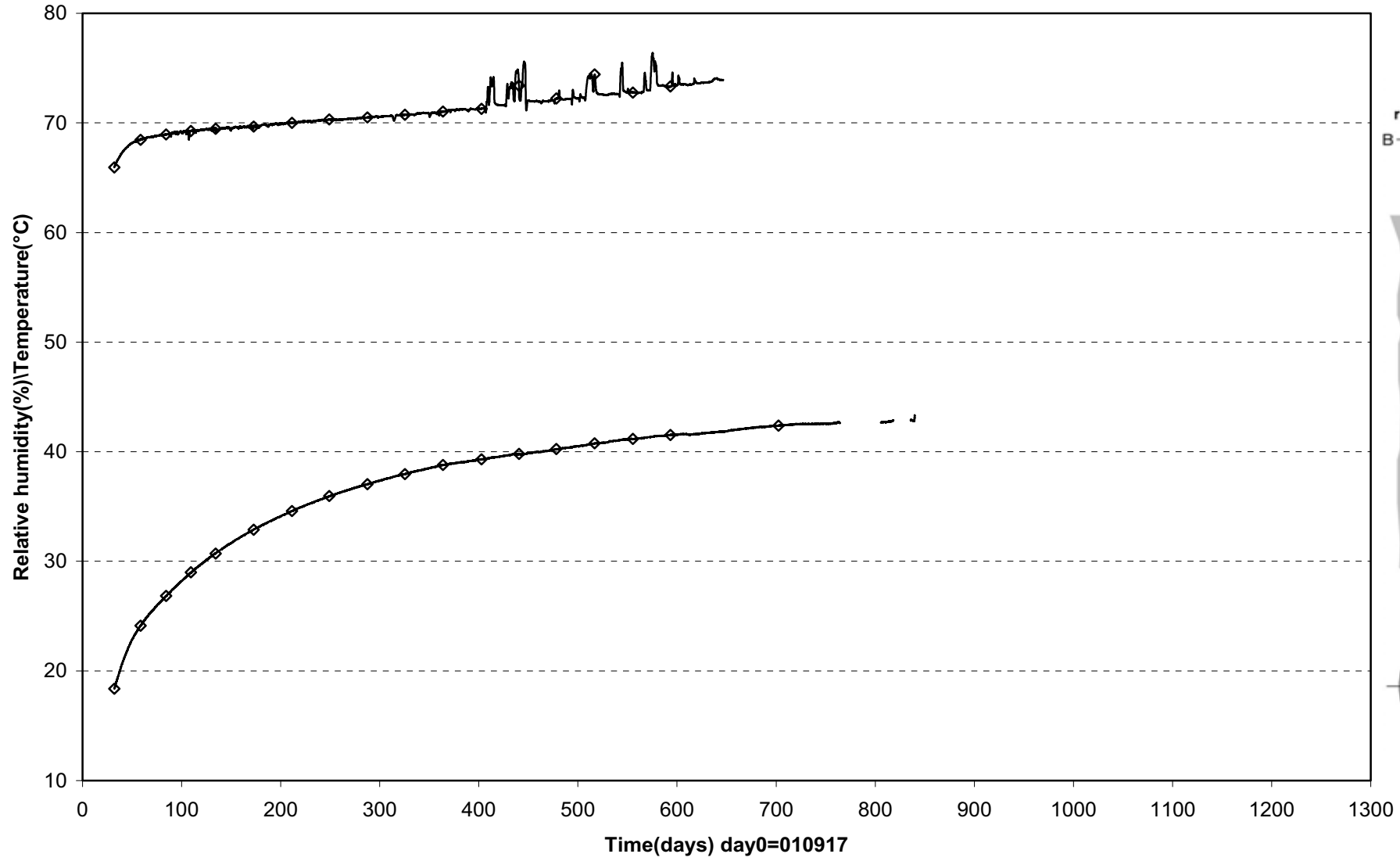

◇ WBU30035(6.314\180°\0.585)

Prototype\Hole 3 (010917-041201)
Pore pressure - Geokon

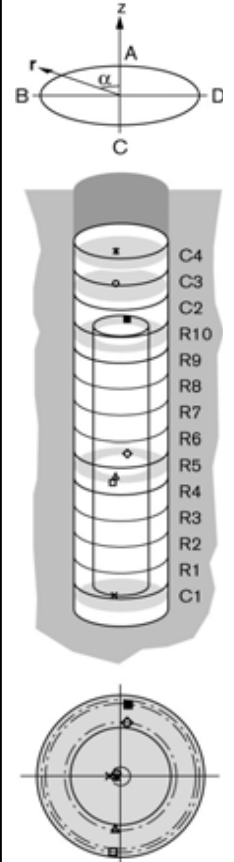
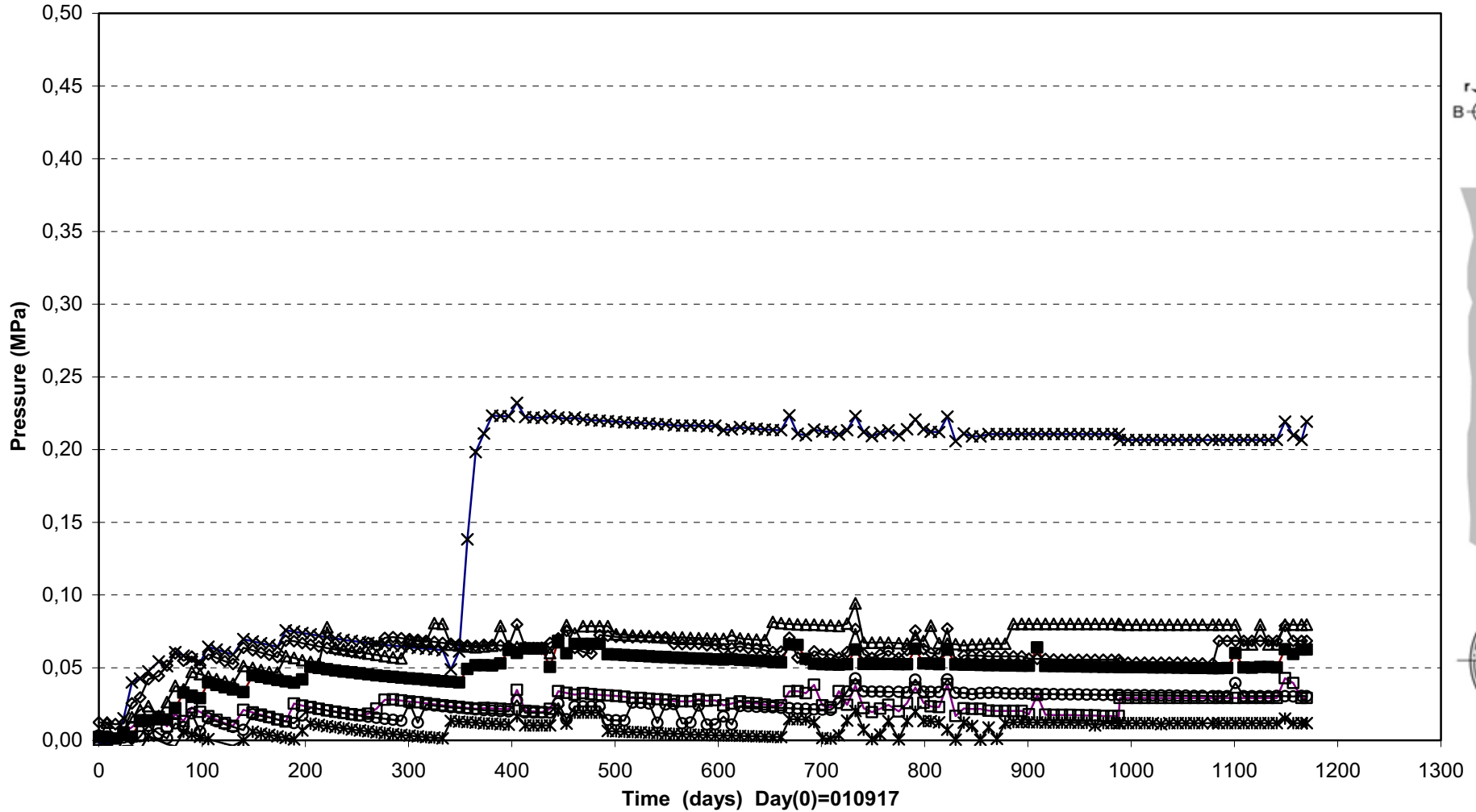

—x— UBU30002(0.245\90°\0.100)	—◇— UBU30005(2.771\355°\0.585)	—△— UBU30009(2.771\175°\0.535\in the slot)
—□— UBU30010(2.771\175°\0.825\in the slot)	—■— UBU30012(5.306\355°\0.785)	—○— UBU30013(6.314\90°\0.050)
—*— UBU30014(6.910\90°\0.050)		

Prototype\Hole 3 (010917-041201)
Pore pressure - Kulite

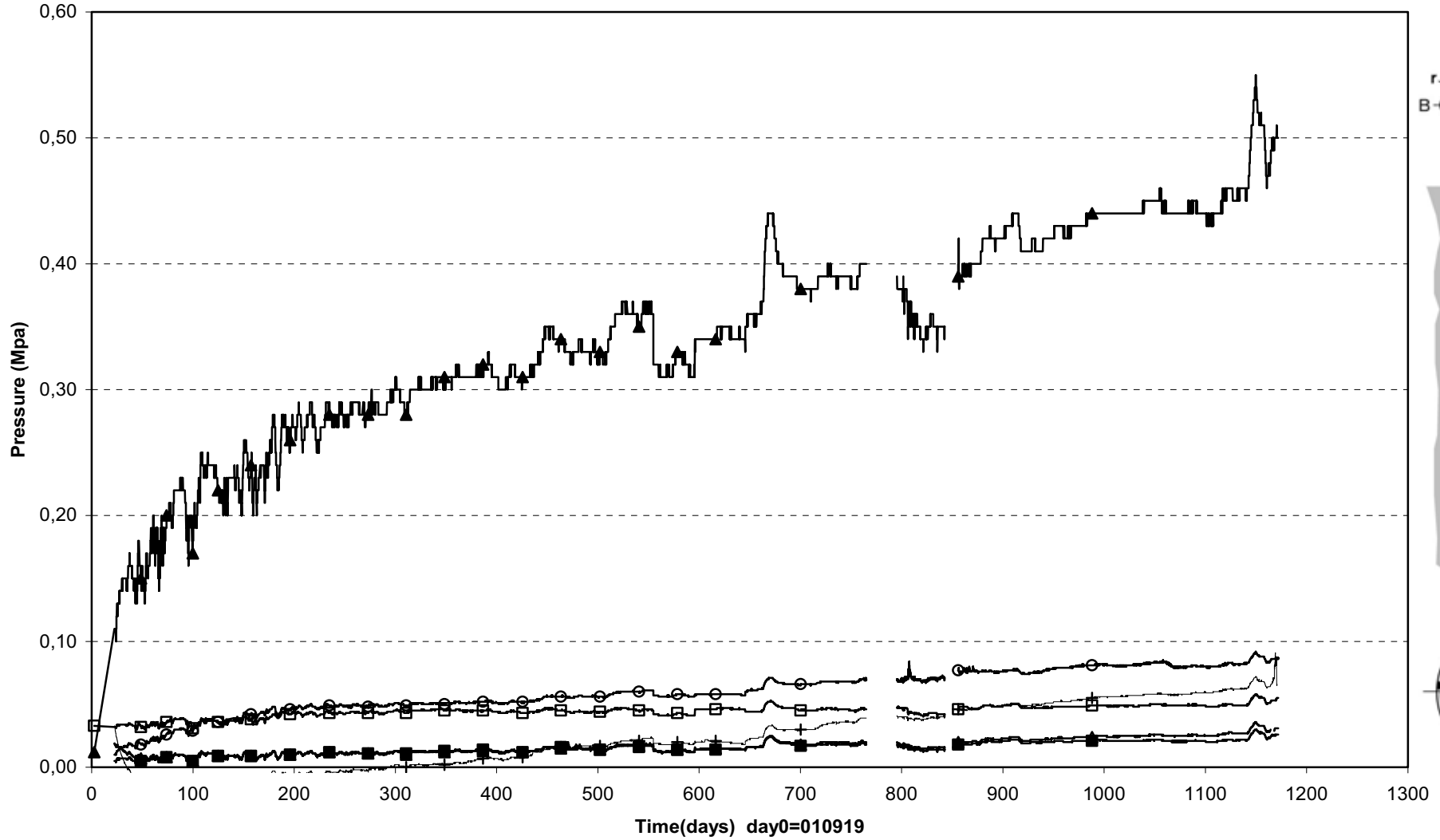

- | | | |
|--|--|-------------------------------|
| □ UBU30001(Cyl.1\90°\0.050) | ▲ UBU30004(Cyl.1\355°\0.785) | ○ UBU30006(Ring5\355°\0.785) |
| + UBU30007(Ring.5\85°\0.535\In the slot) | ■ UBU30008(Ring.5\85°\0.825\In the slot) | △ UBU30011(Ring10\355°\0.585) |

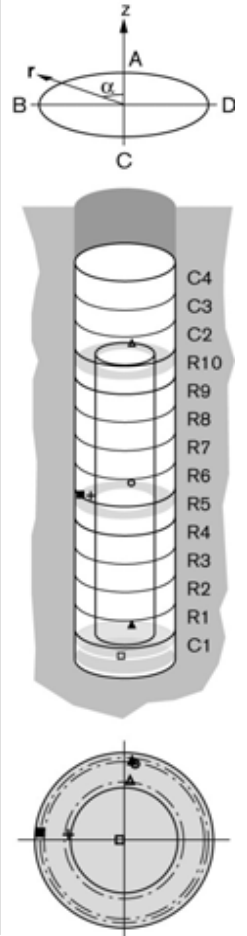

Prototype\Hole 3\Cyl.1 (010917-041201)
 Temperature - Pentronic

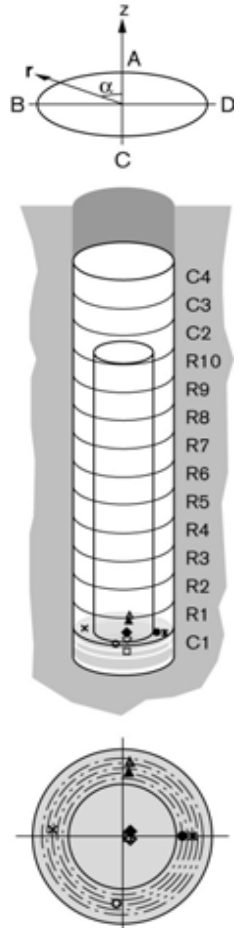
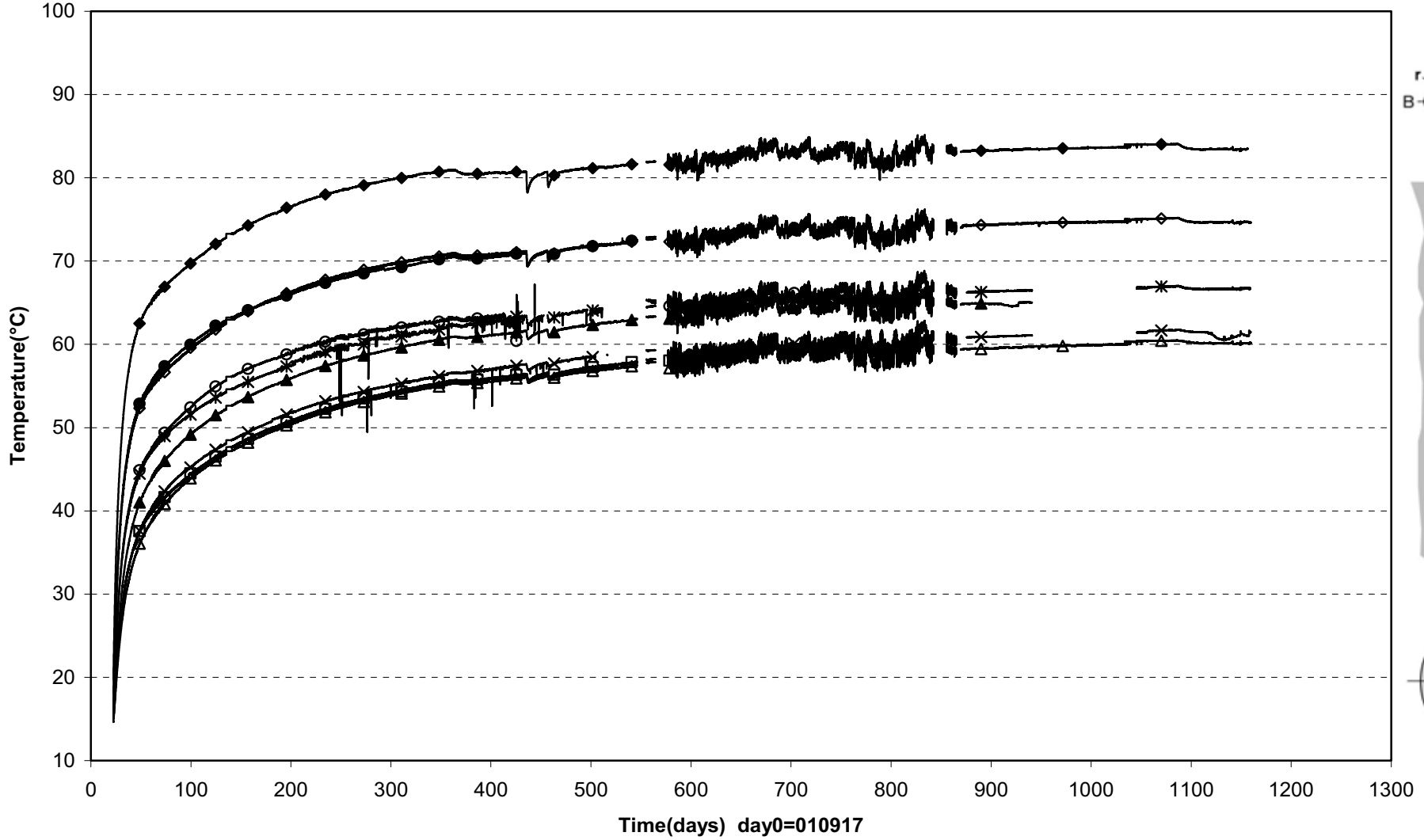

□ TBU30001(0.095\270°\0.050) ◇ TBU30002(0.295\270°\0.050) ◆ TBU30003(0.445\270°\0.050) ▲ TBU30004(Cyl.1\355°\0.635) △ TBU30005(Cyl.1\355°\0.735)
 × TBU30006(Cyl.1\85°\0.685) ○ TBU30007(Cyl.1\175°\0.685) ● TBU30008(Cyl.1\270°\0.585) ✖ TBU30009(Cyl.1\270°\0.685)

c

Prototype\Hole 3\Ring5 (010917-041201)
 Temperature - Pentronic

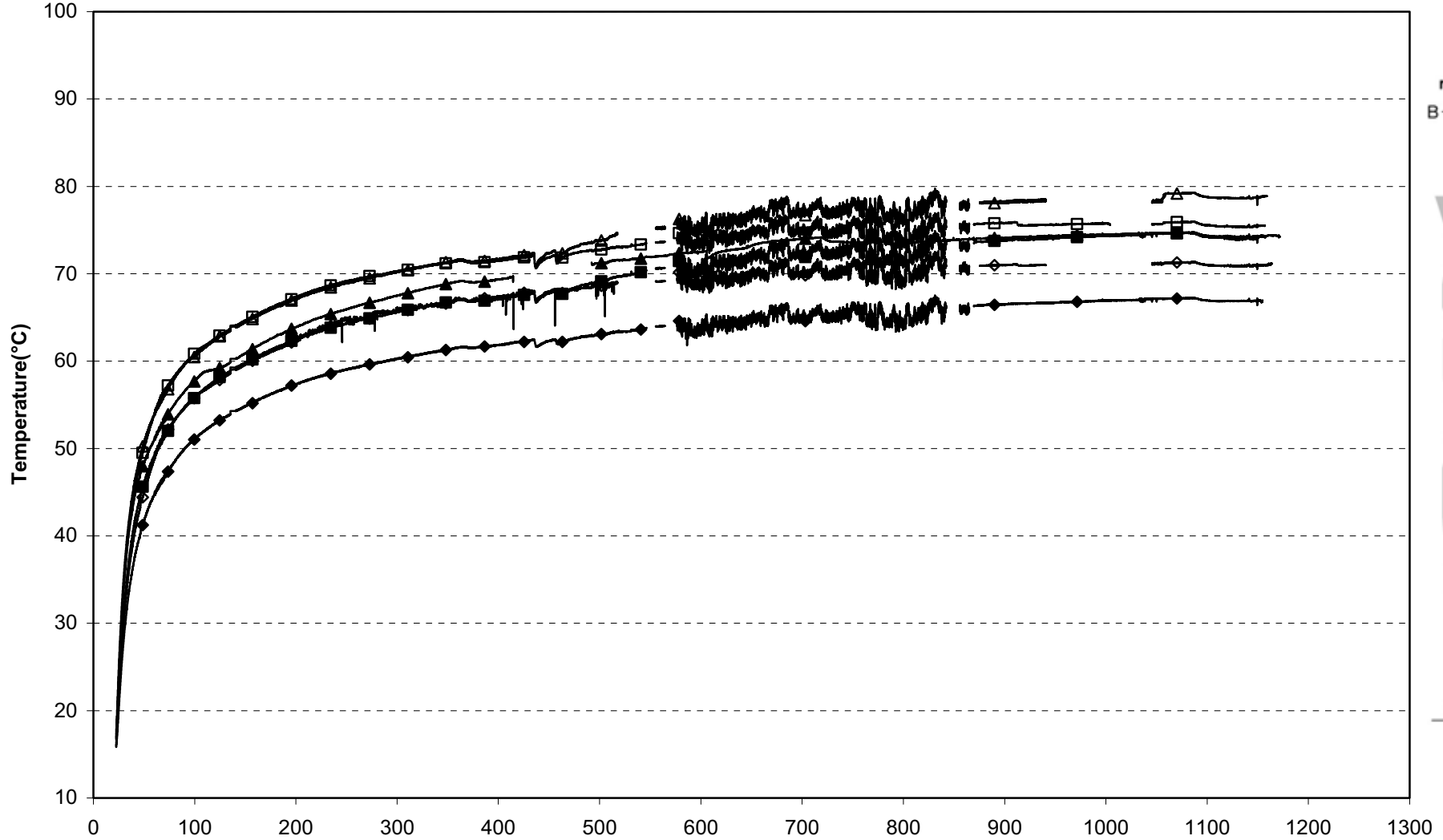

□ TBU30011(2.971\0°\0.635) ◇ TBU30012(2.971\0°\0.735) △ TBU30013(2.971\90°\0.585) ■ TBU30014(2.971\90°\0.685)
 ◆ TBU30015(2.971\90°\0.785) ▲ TBU30017(2.971\175°\0.685)

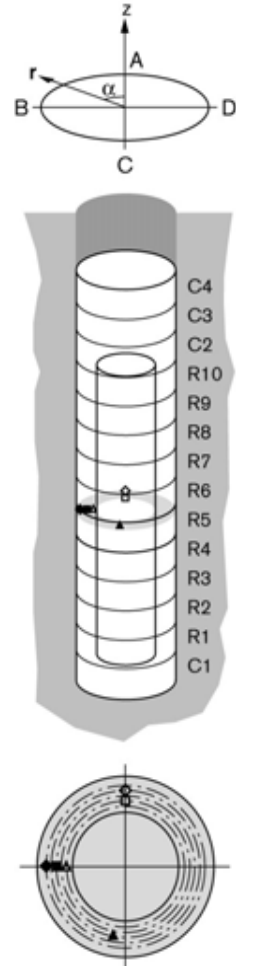

Prototype\Hole 3\Ring5 (010917-041201)
 Temperature - Pentronic

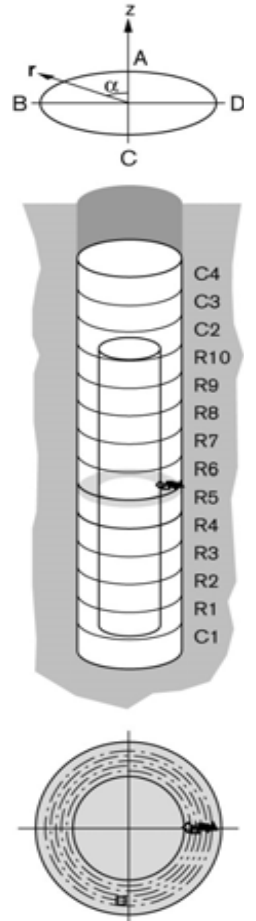
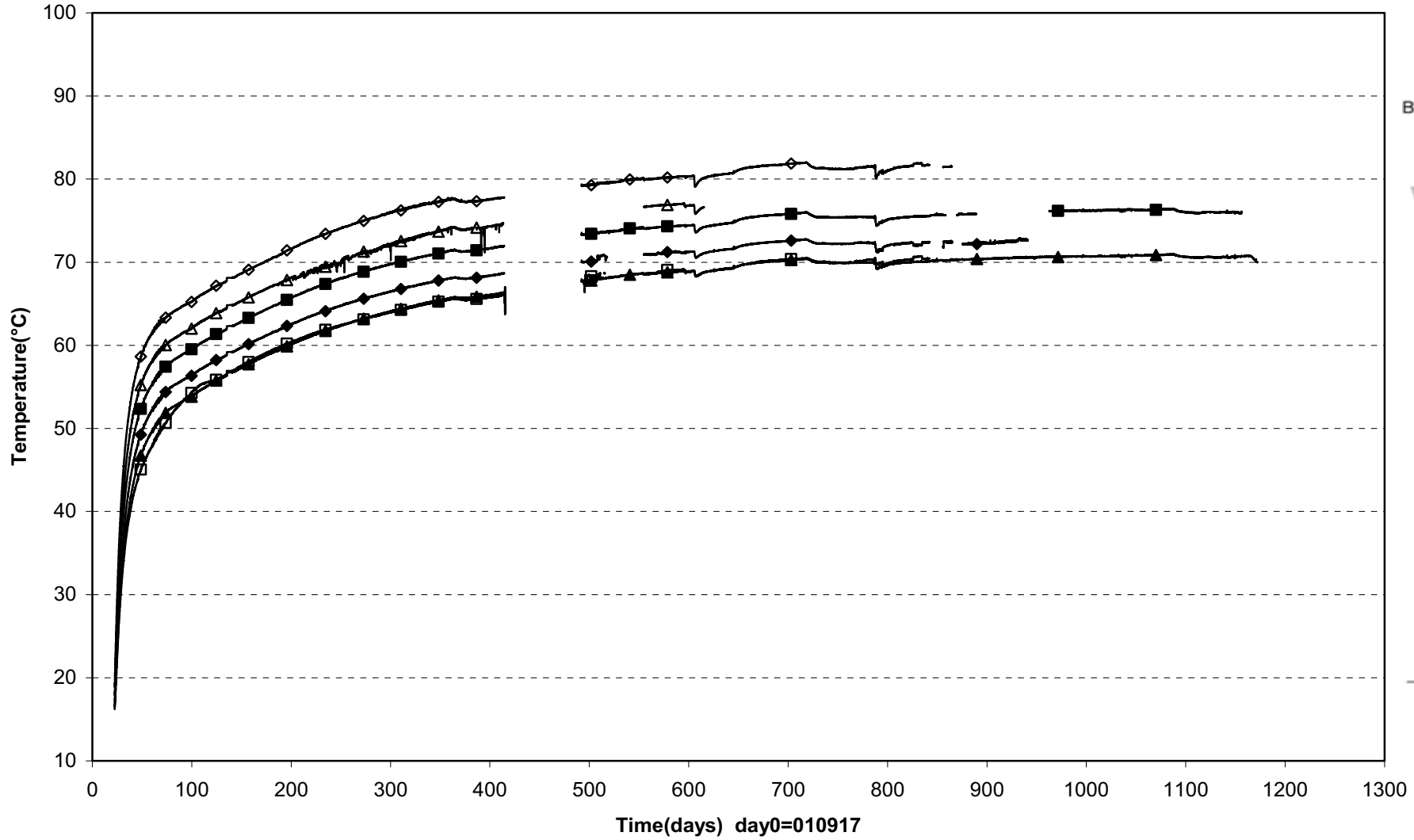

Prototype\Hole 3\Ring10 (010917-041201)
 Temperature - Pentronic

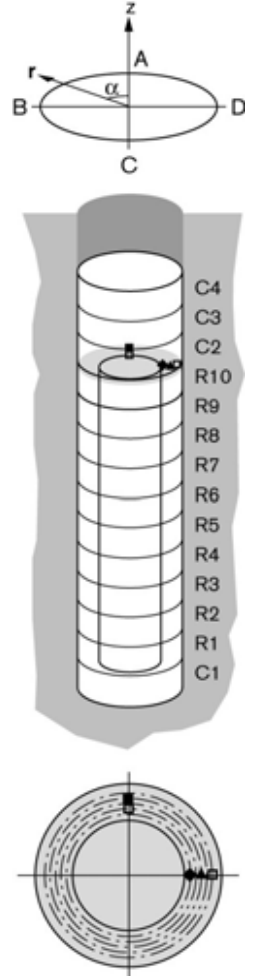
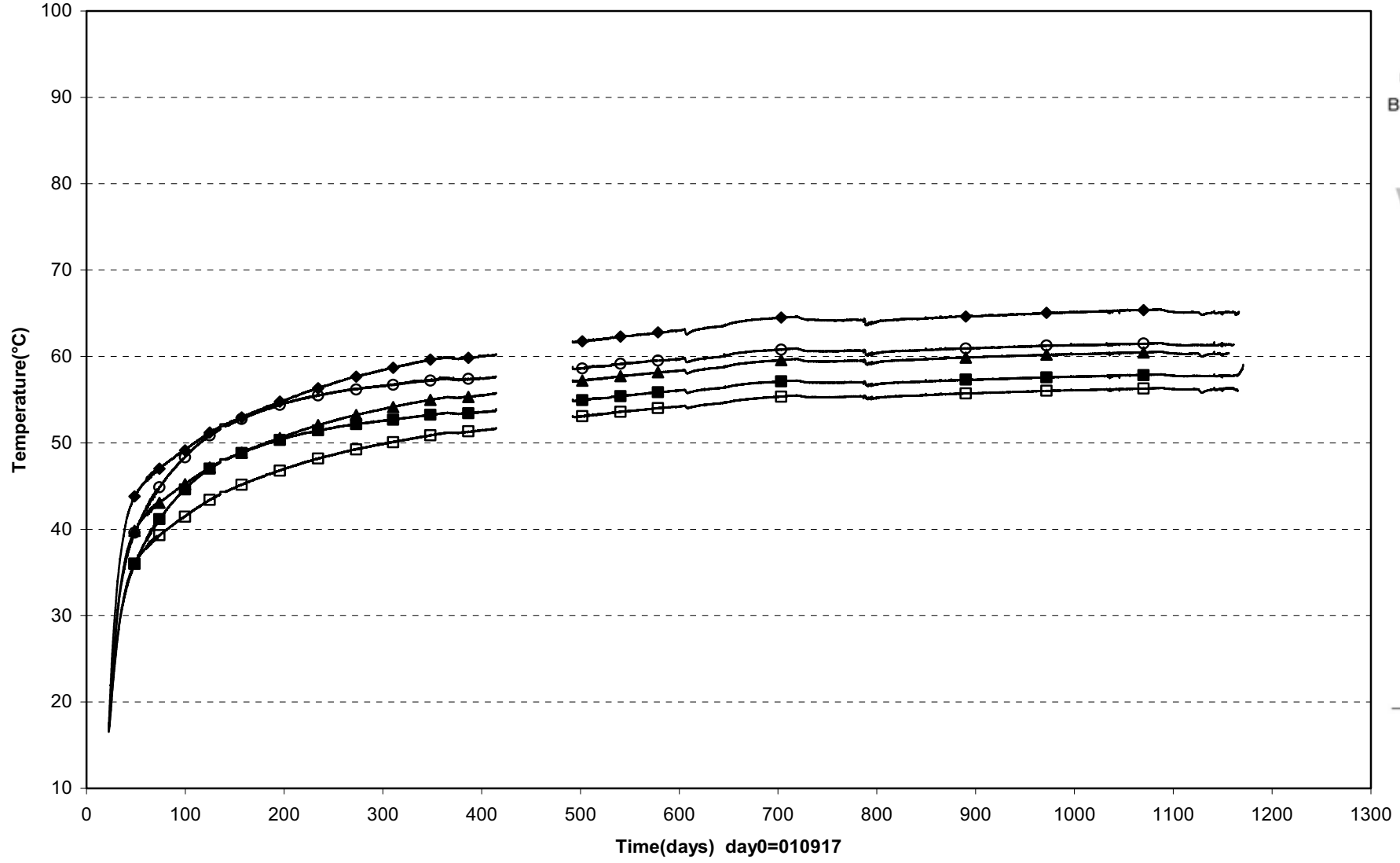

○ TBU30024(5.504\0°\0.635) ■ TBU30025(5.504\0°\0.735) ◆ TBU30026(5.504\270°\0.585) ▲ TBU30027(5.504\270°\0.685) □ TBU30028(5.504\270°\0.785)

Prototype\Hole 3\Cyl.3 and Cyl.4 (010917-041201)
 Temperature - Pentronic

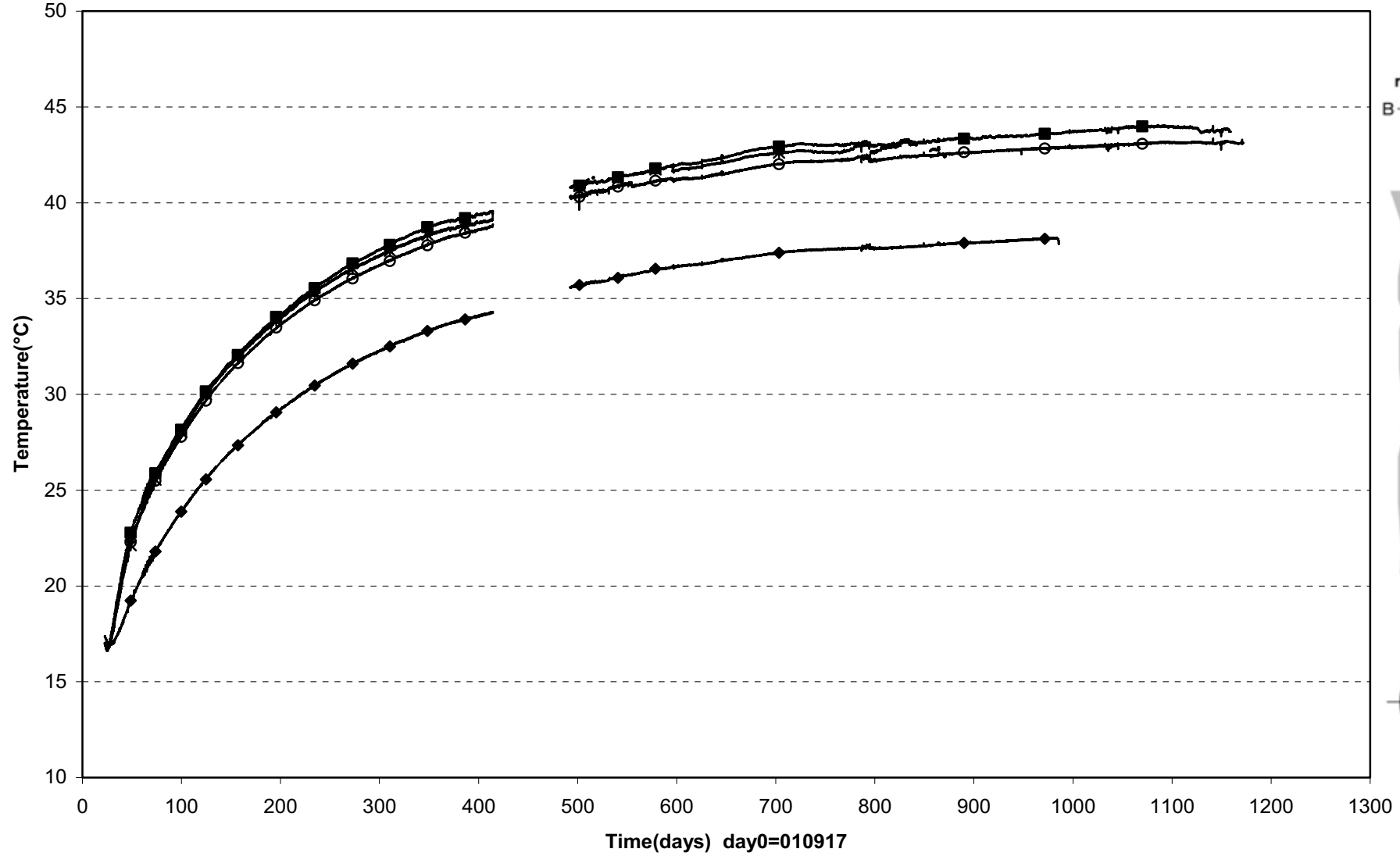

× TBU30029(6.314\0°\0.785)
 ○ TBU30030(6.314\95°\0.585)
 ■ TBU30031(6.314\185°\0.585)
 ◆ TBU30032(7.015\0°\0.785)

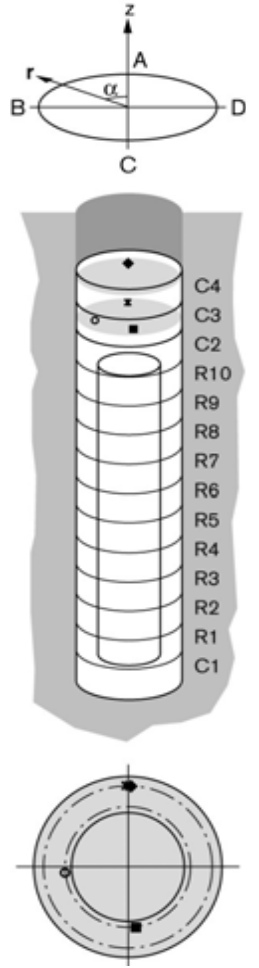

Prototype\Rock\Hole 3 (010917-041201)
 Temperature - Pentronic

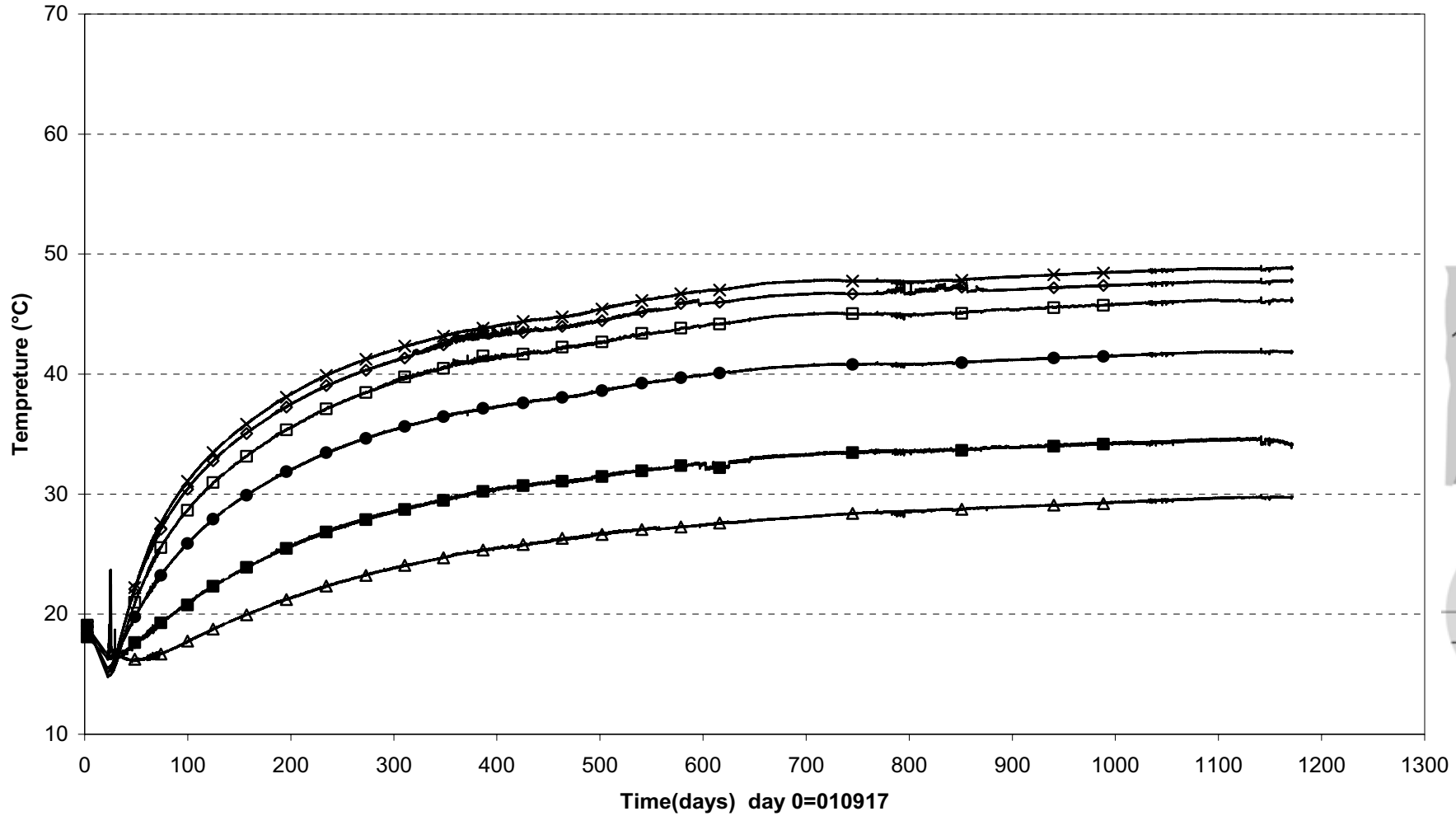

Δ TROA2150(7.958\134°\3.284) ● TROA2140 (5.979\1°\1.999) ◇ TROA2130(4.230\2°\1.981) × TROA2120(2.840\2°\1.967)
 □ TROA2110(1.170\3°\1.950) ■ TROA1850 (7.889\0°\2.019)

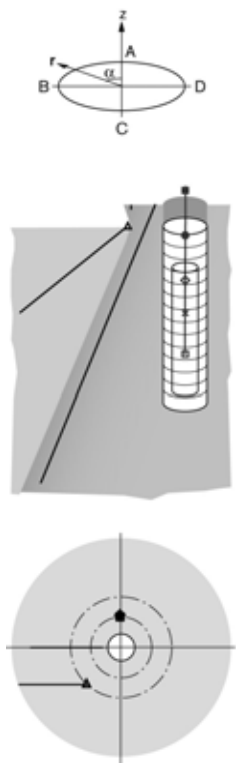

Prototype\Rock\Hole 3 (010917-041201)
 Temperature - Pentronic

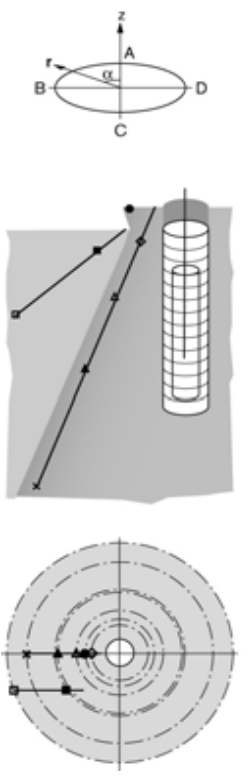
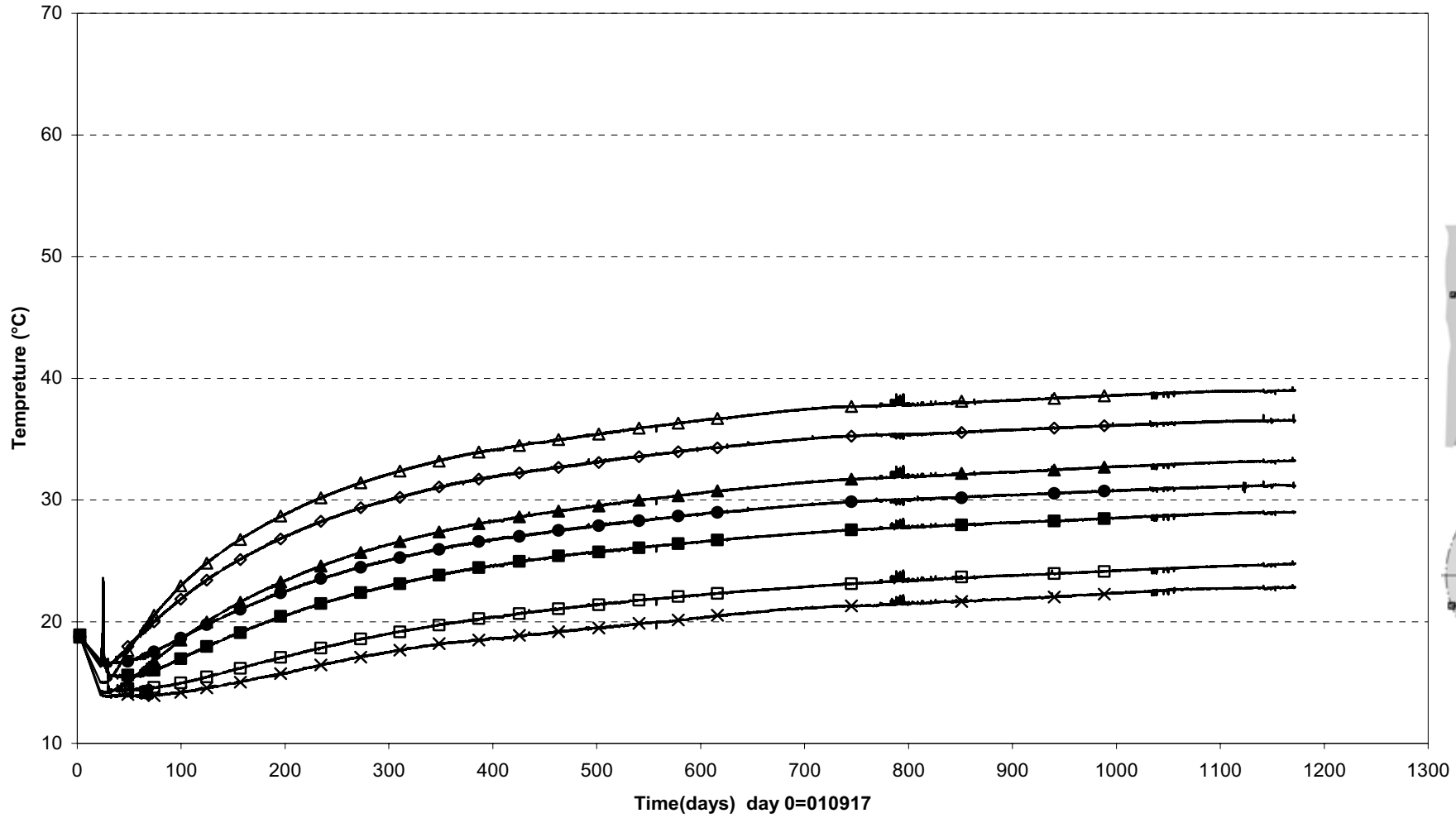

- | | | | |
|------------------------------|------------------------------|------------------------------|-------------------------------|
| ● TROA2330(7.924\90°\2.169) | ◇ TROA2320 (6.632\90°\1.787) | □ TROA2310(4.640\109°\7.111) | ■ TROA2440 (7.174\124°\4.088) |
| △ TROA2430 (4.319\90°\4.319) | ▲ TROA2420(1.451\89°\3.914) | × TROA2410(-3.295\89°\5.861) | |

Prototype\Hole 3\ On canister top (010917-041201)
Temperature - Pentronic

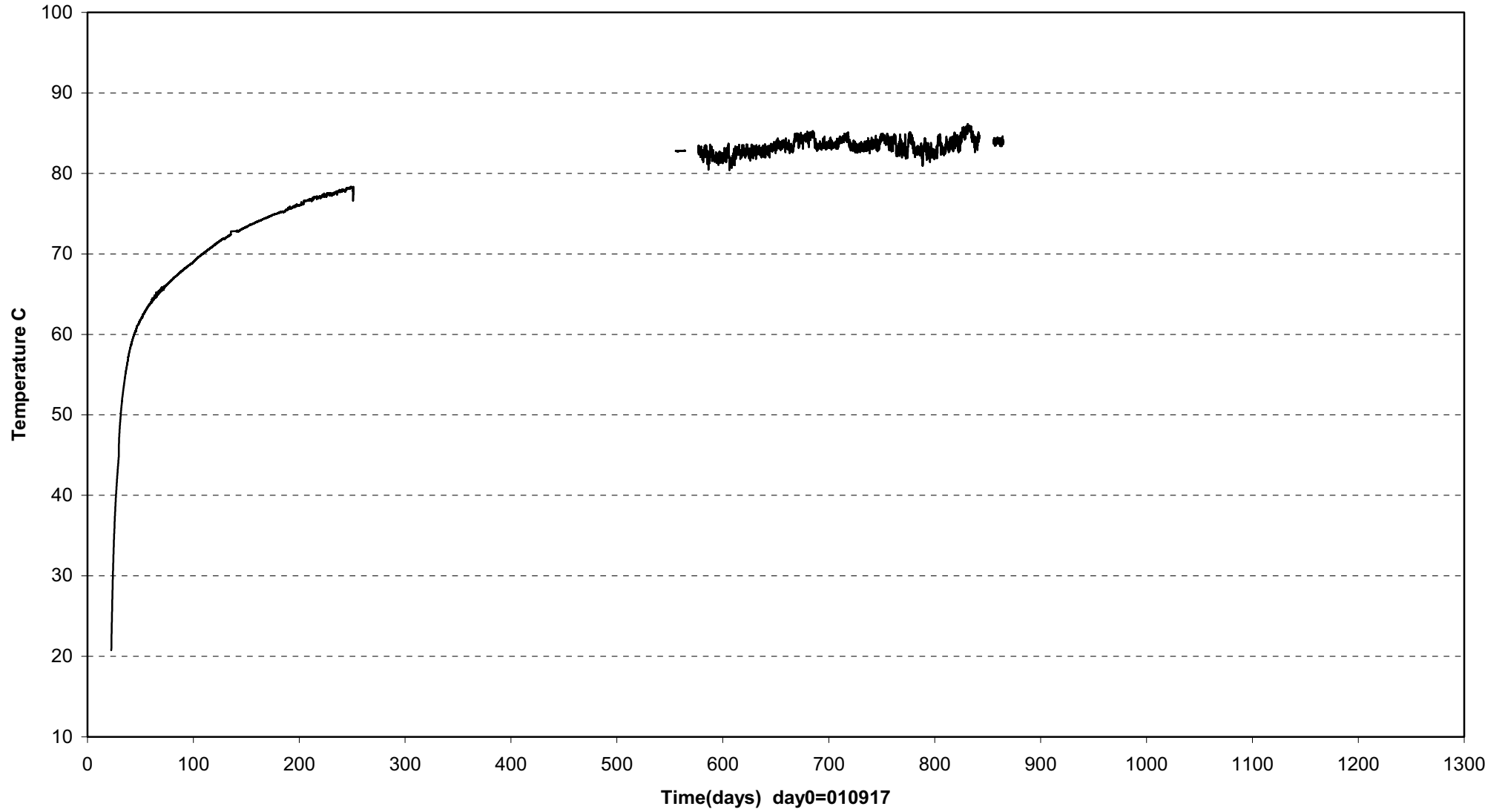

— TBU30016(5394\329°\410)-On canister top)

Prototype\ Hole 3 (010917-041201)
Canister power

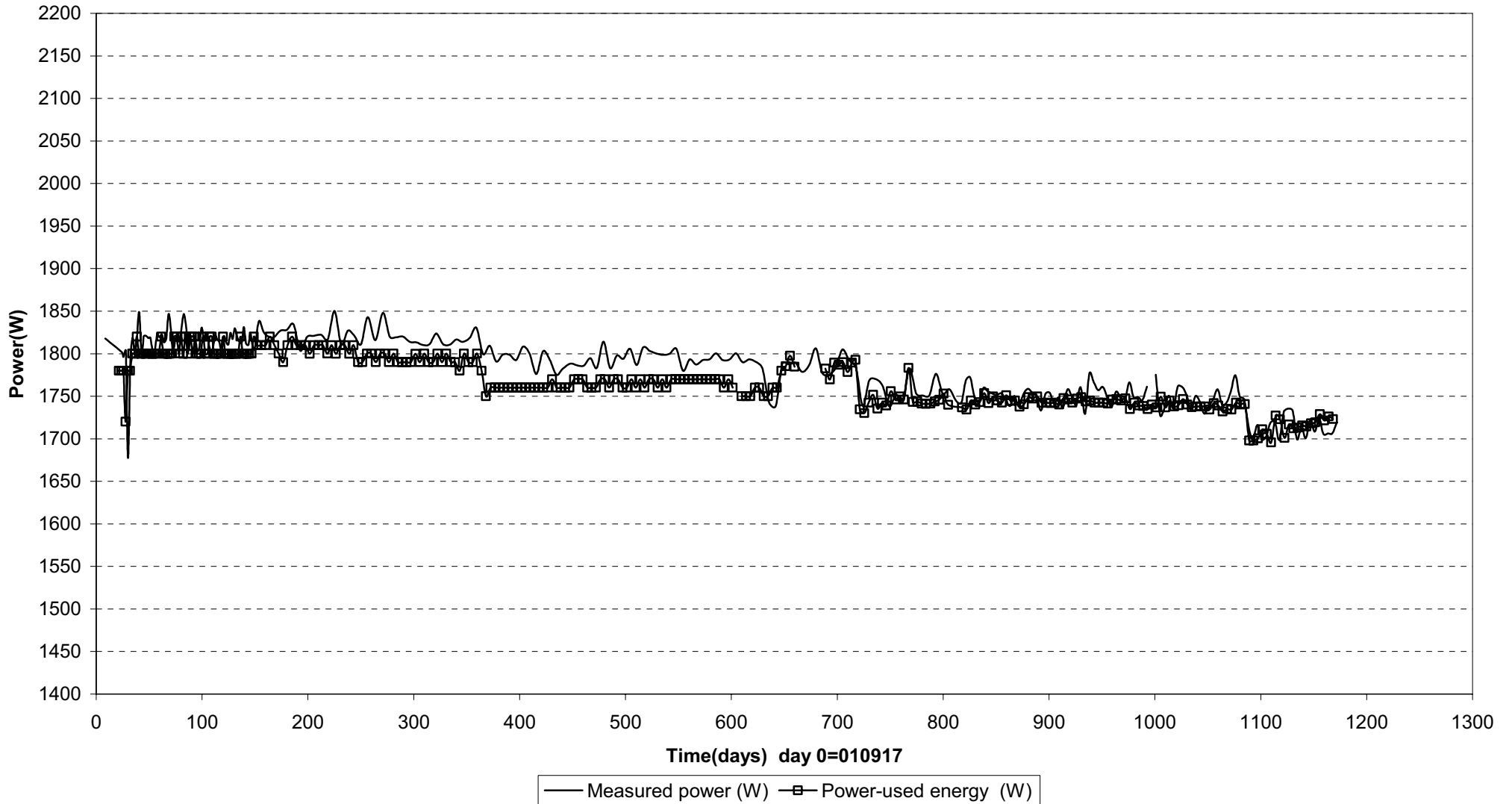

Prototype\ Hole 3 \Canister (041015-041201)
 Max. temperature on the canister surface - Optical fibre cables

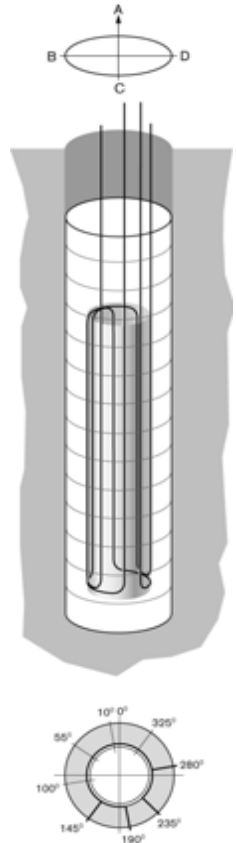
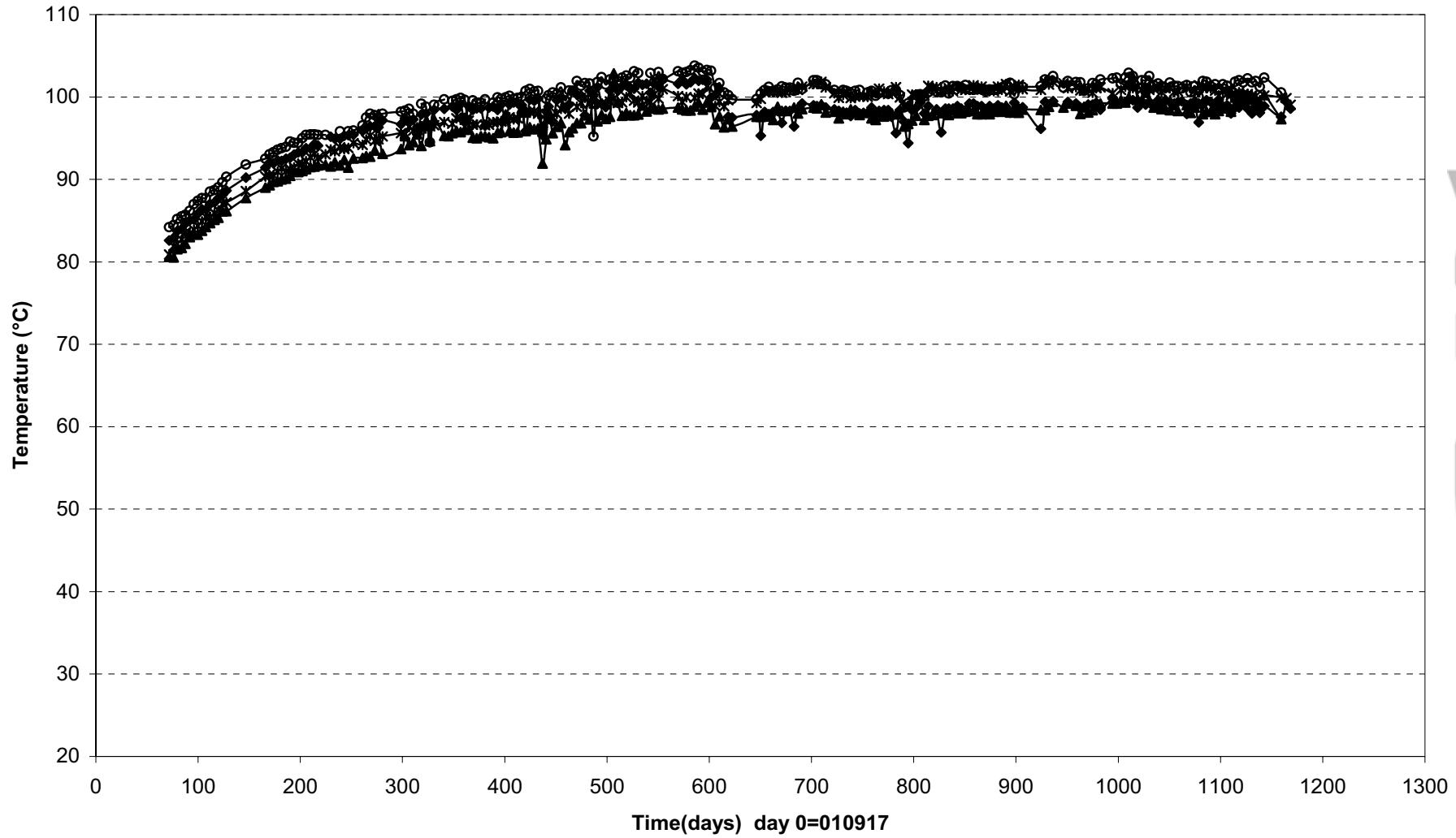

Prototype\ Hole 3 \Canister (041201)
Temperature profile on the canister surface - Optical fiber cables

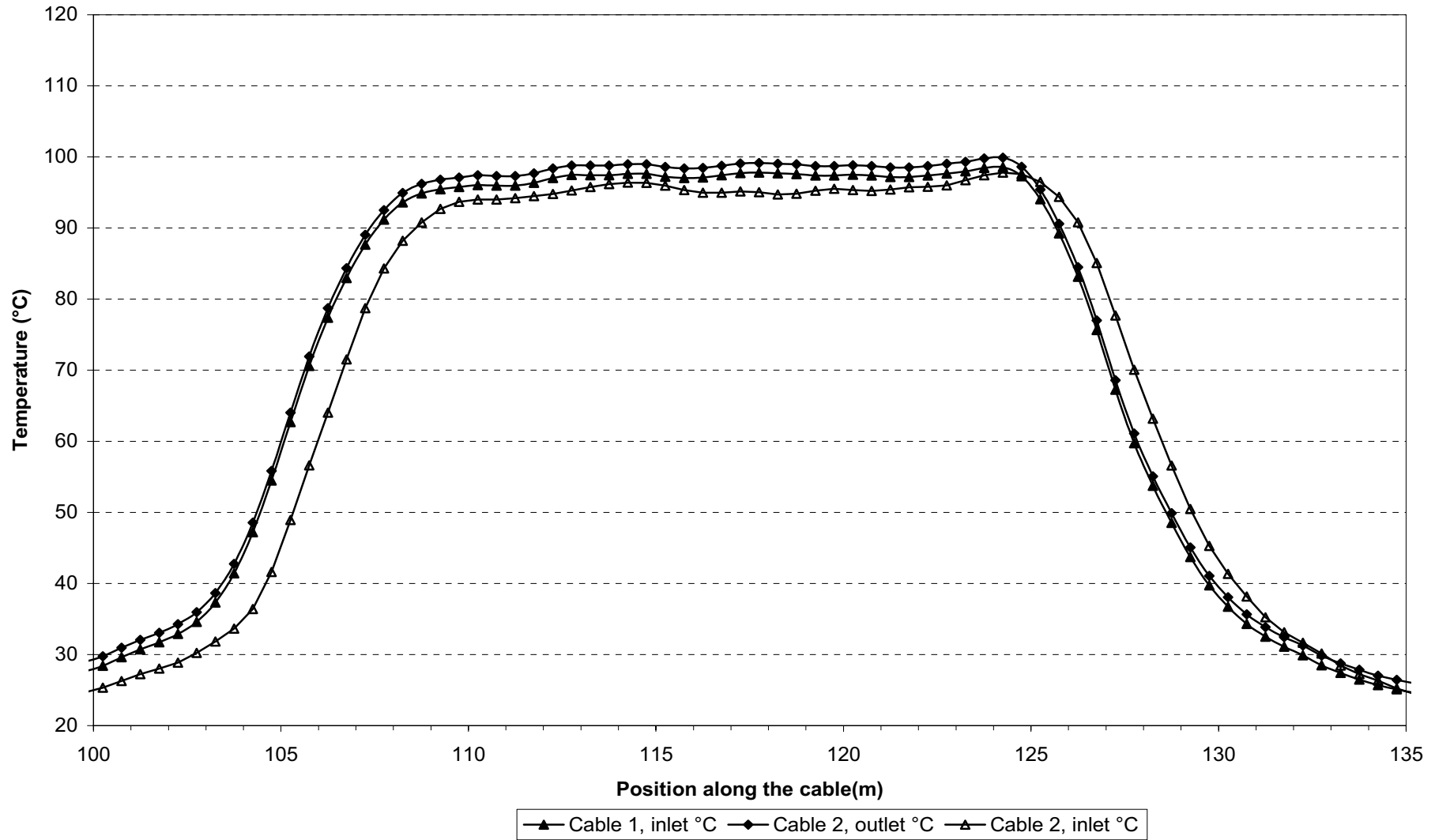

Appendix 3

Dep. holes 2 and 4

Prototype\Rock\Hole 2 (010917-041201)
 Temperature - Pentronic

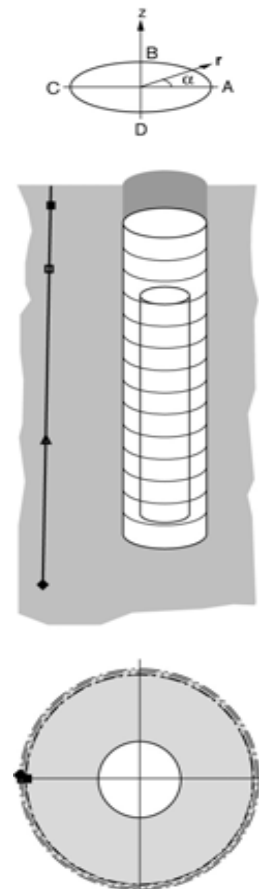
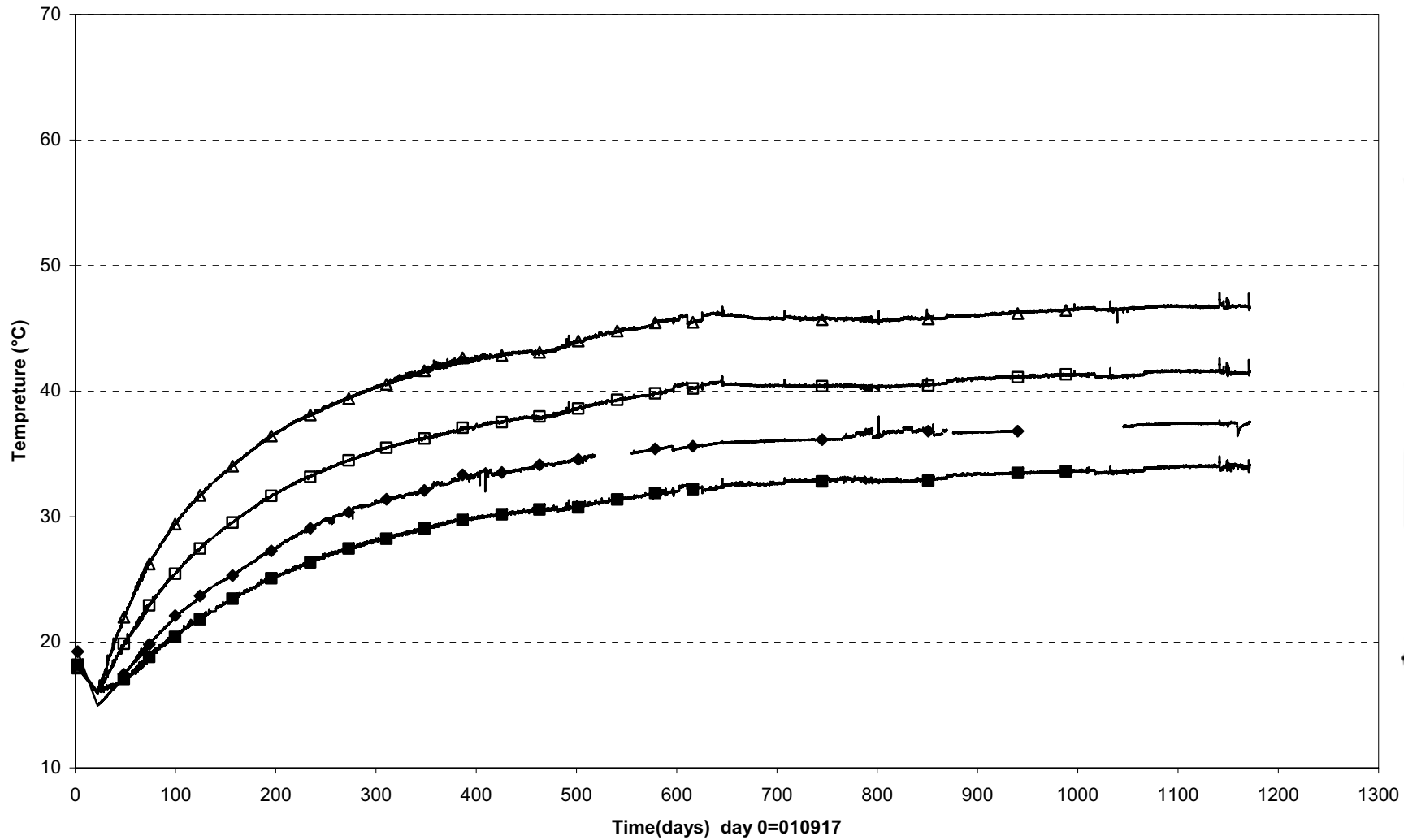

TROA1840(7.587\180°\2.404)
 TROA1830 (6.087\180°\2.427)
 TROA1820(2.138\179°\2.490)
 TROA1810 (-1.162\179°\2.542)

Prototype\ Hole 2 (010917-041201)
Canister power

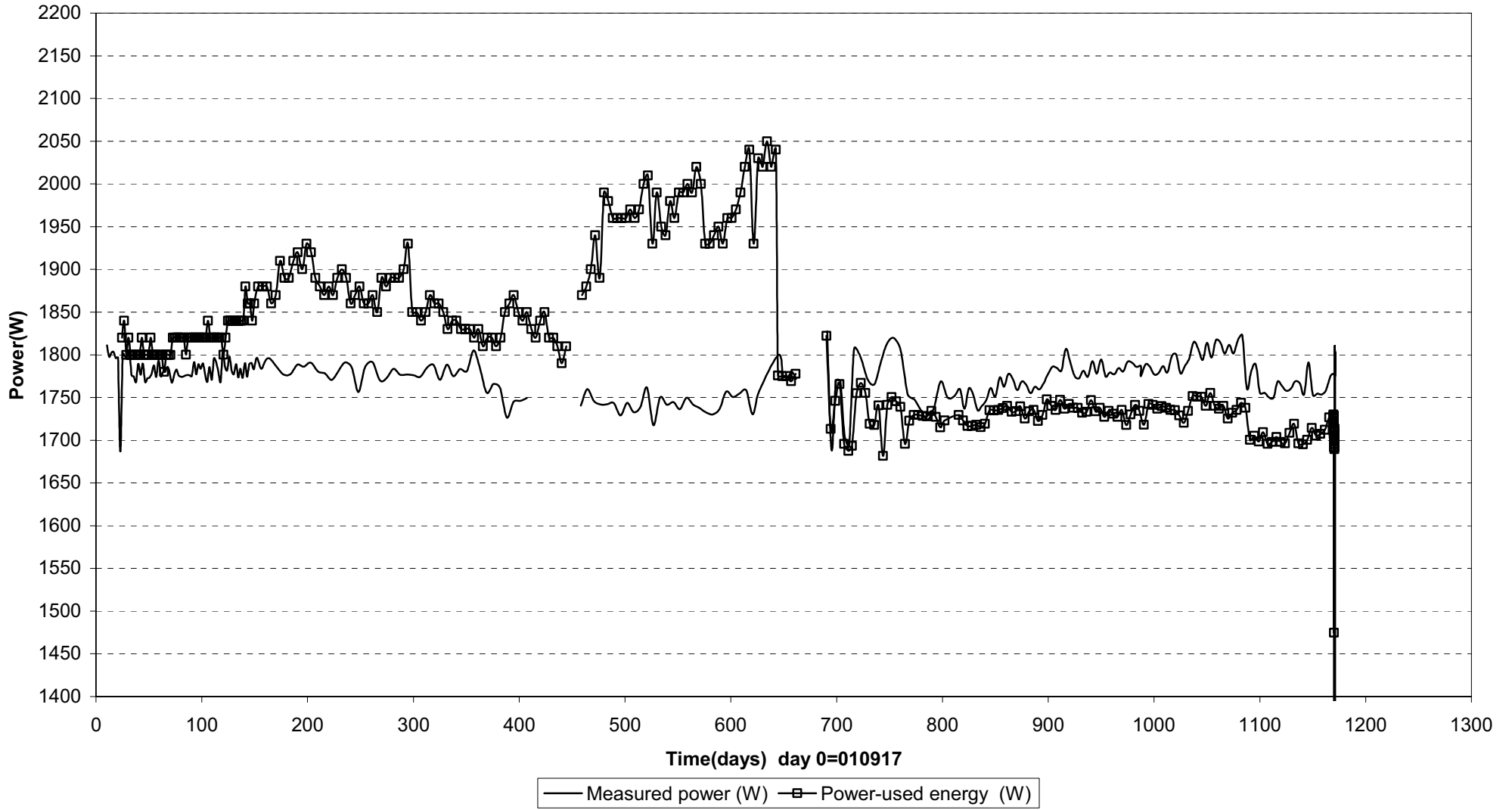

Prototype\ Hole 2 \Canister (010917-041201)
Max. temperature on the canister surface - Optical fiber cables

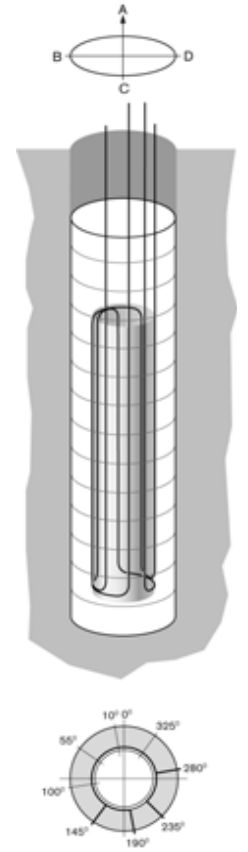
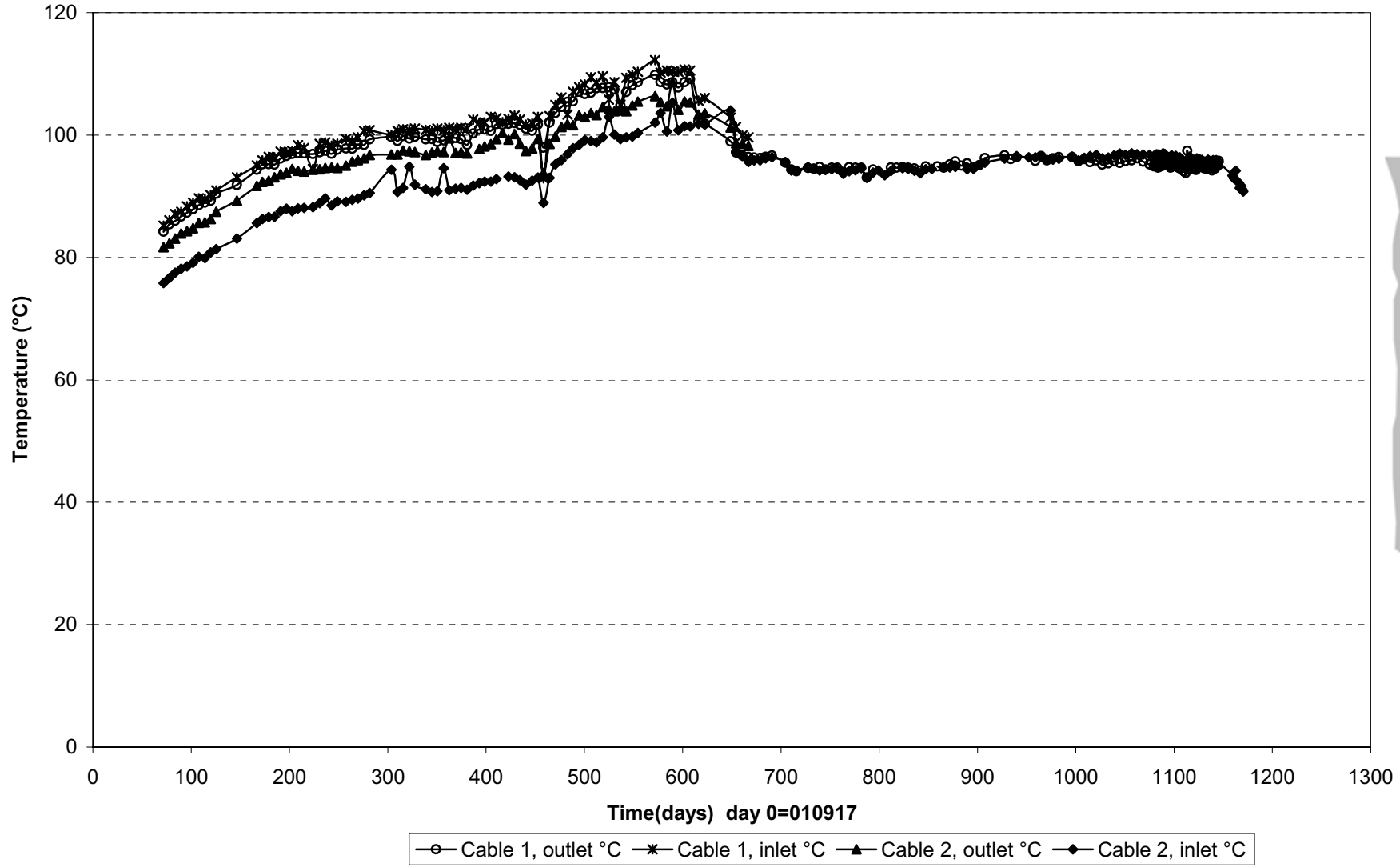

Prototype\ Hole 2 \Canister (041130)
Temperature profile on the canister surface - Optical fiber cables

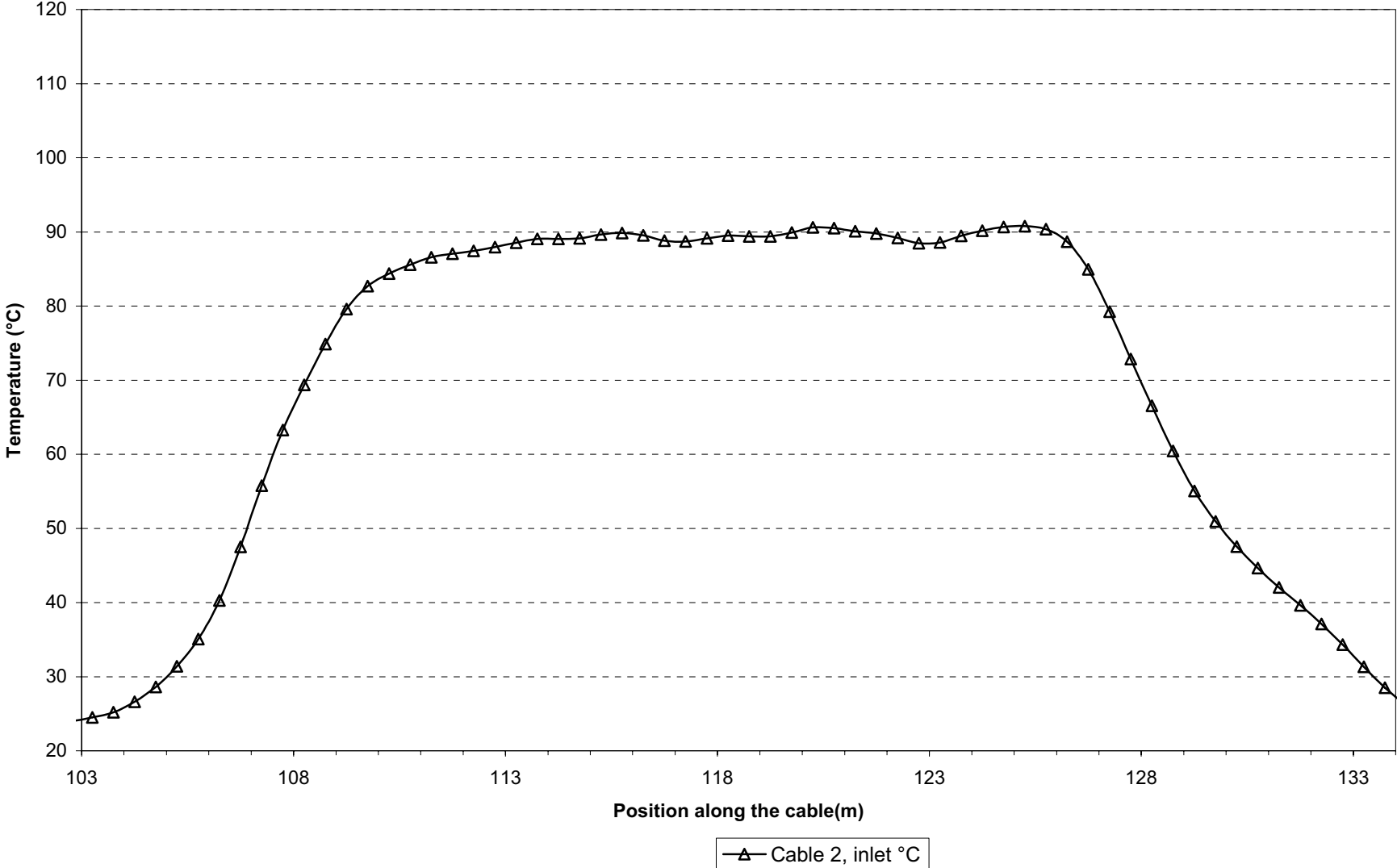

Prototype\Hole 2 \Canister top (010917-041201)
Temperature - Pentronic

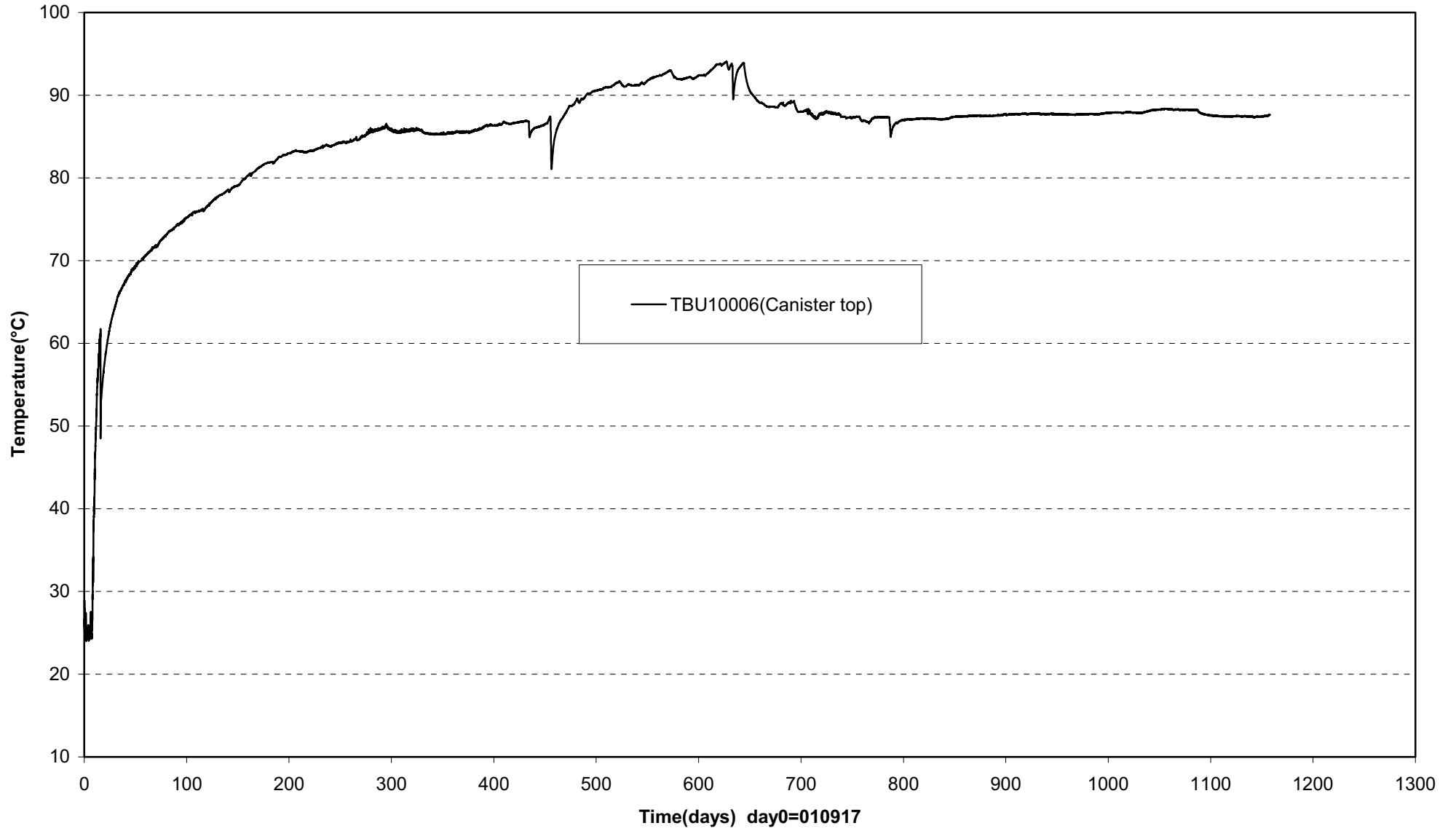

Prototype\Rock\Hole 4 (010917-041201)
 Temperature - Pentronic

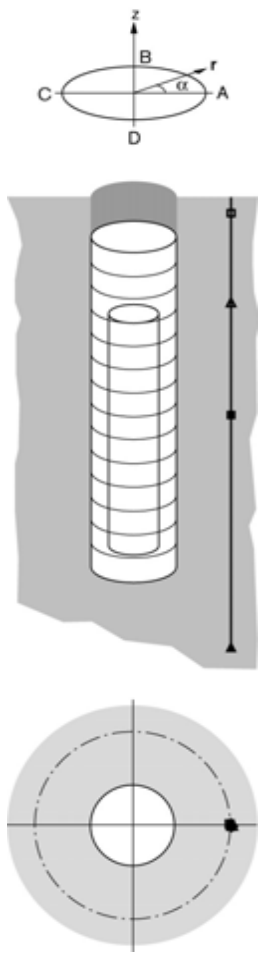
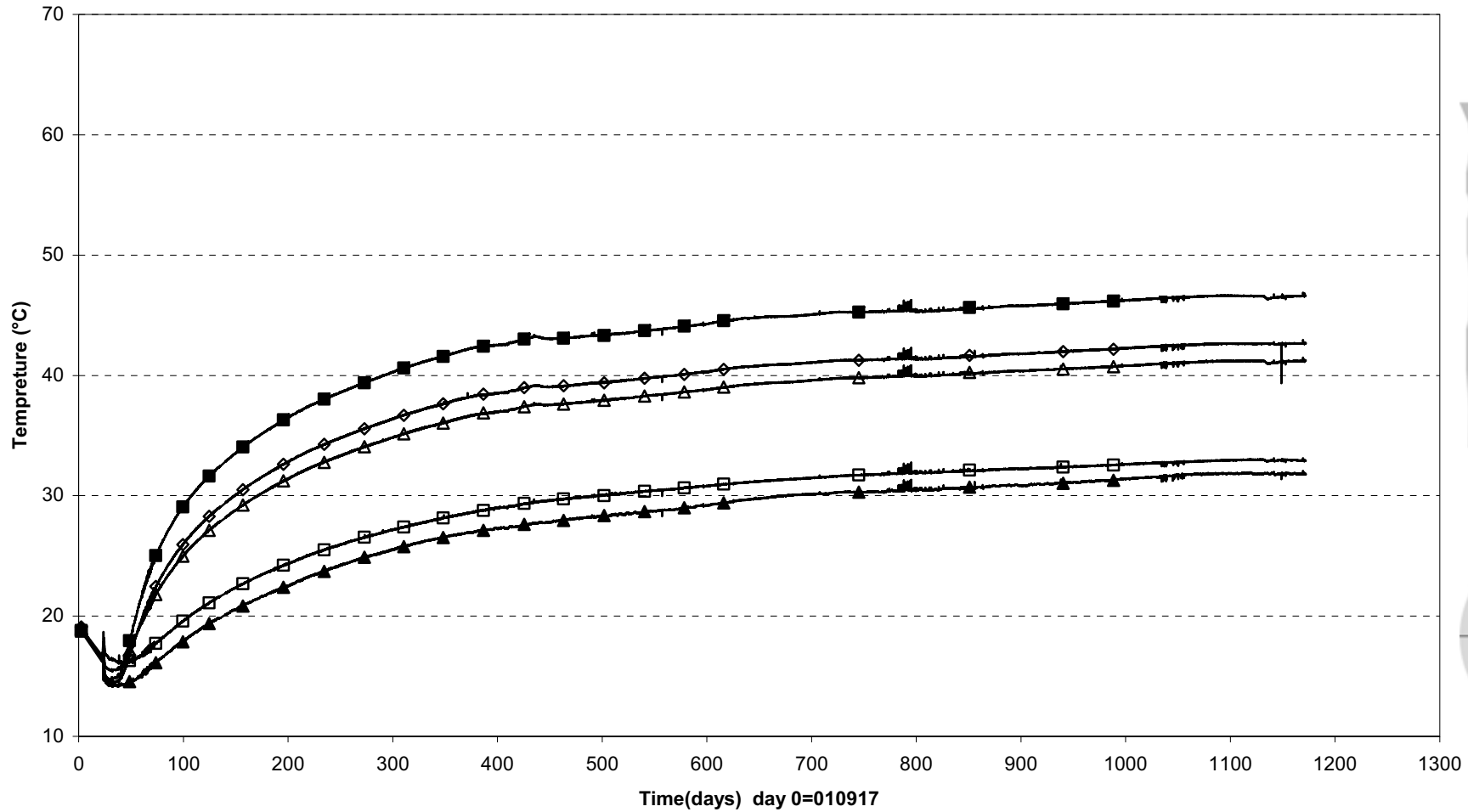

□ TROA3050 (7.671\360°\2.017)	△ TROA3040 (5.671\359°\2.025)	■ TROA3030(3.271\358°\2.034)
◇ TROA3020(0.871\358°\2.045)	▲ TROA3010(-1.778\357°\2.056)	

Prototype\Hole 4 (010917-041201)
Canister power

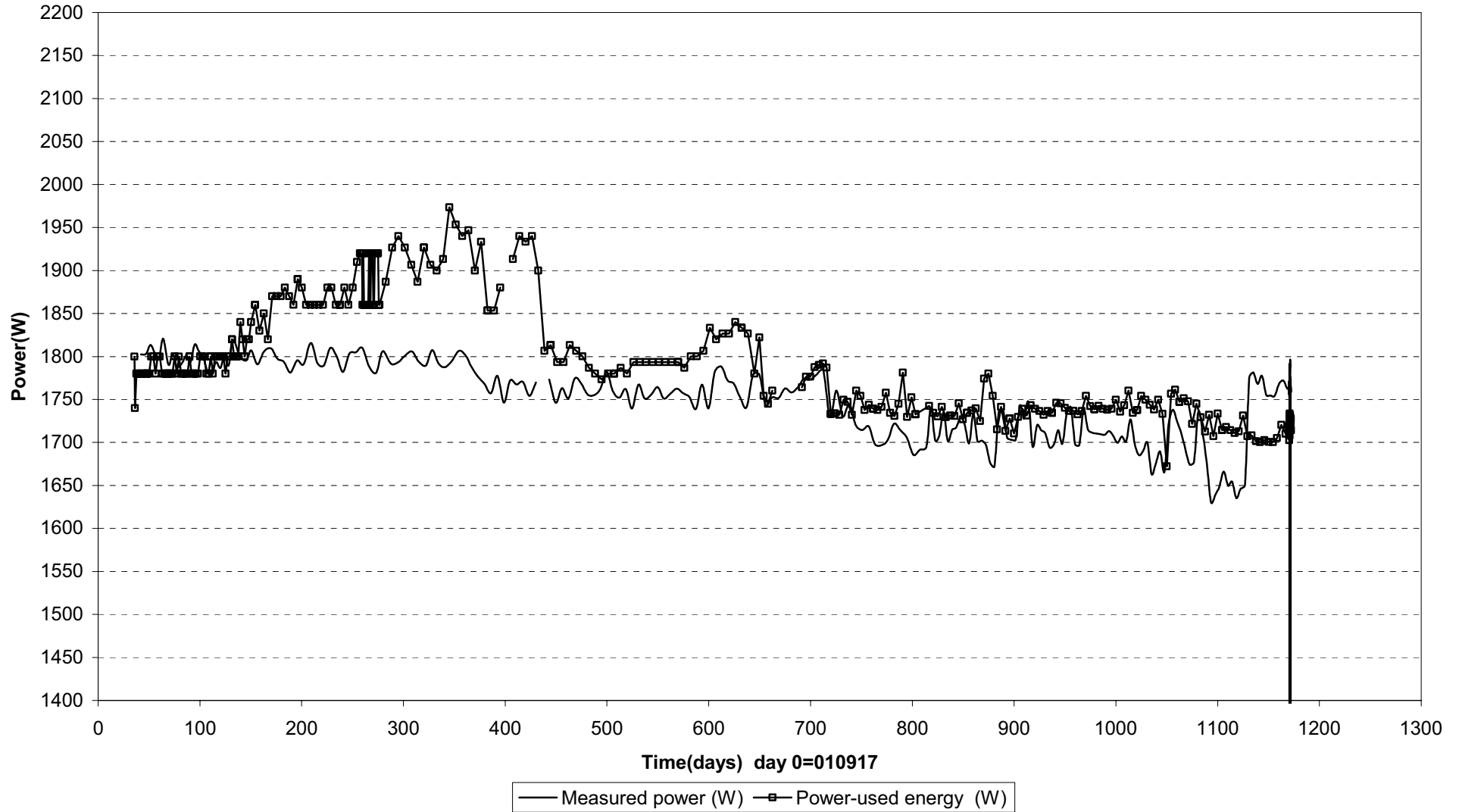

Prototype\ Hole 4 \Canister (010917-041201)
 Max. temperature on the canister surface - Optical fiber cables

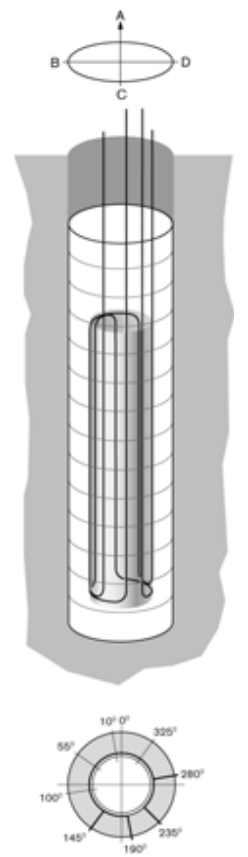
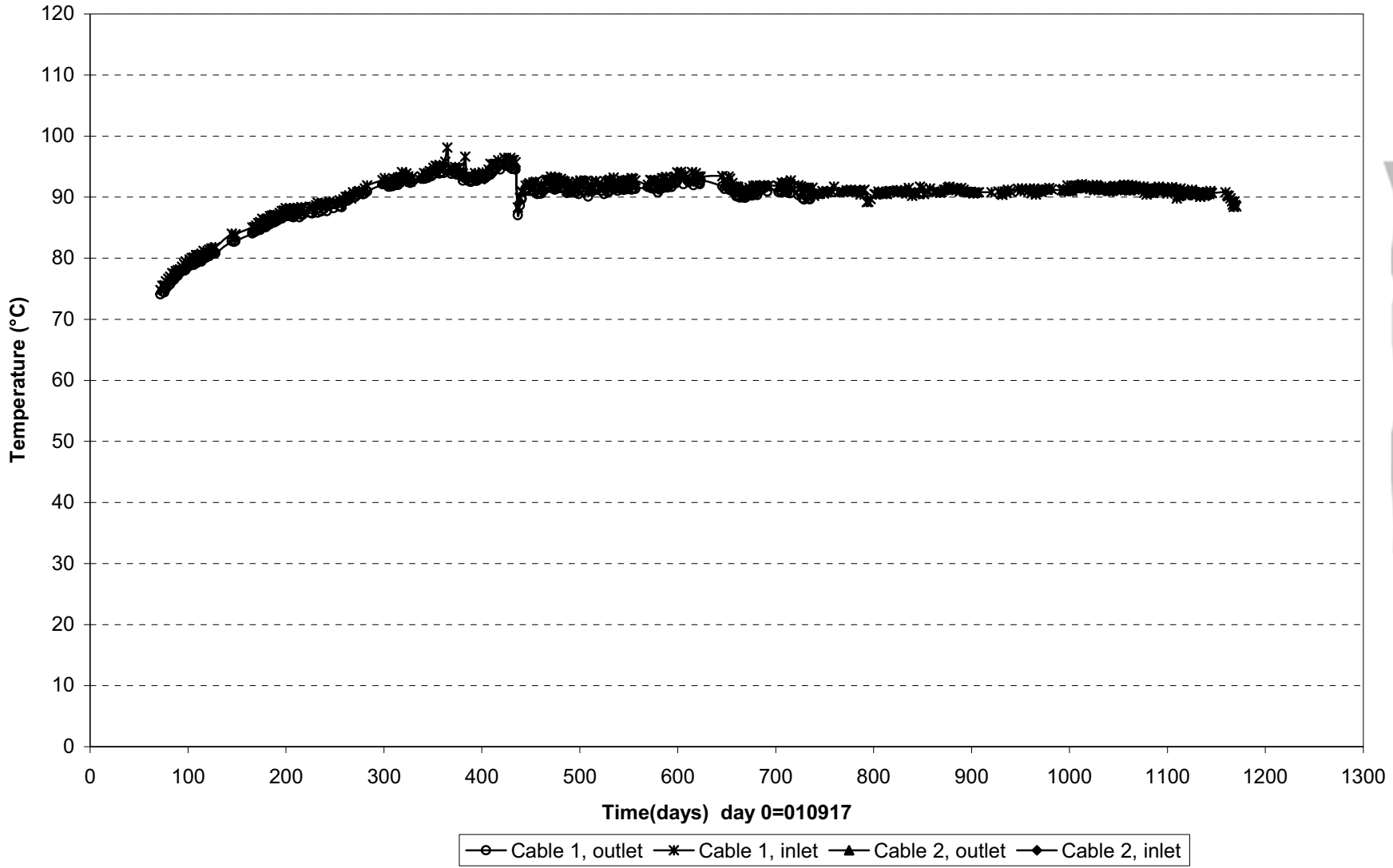

Prototype\ Hole 4\Canister (041130)
Temperature profile on the canister surface - Optical fiber cables

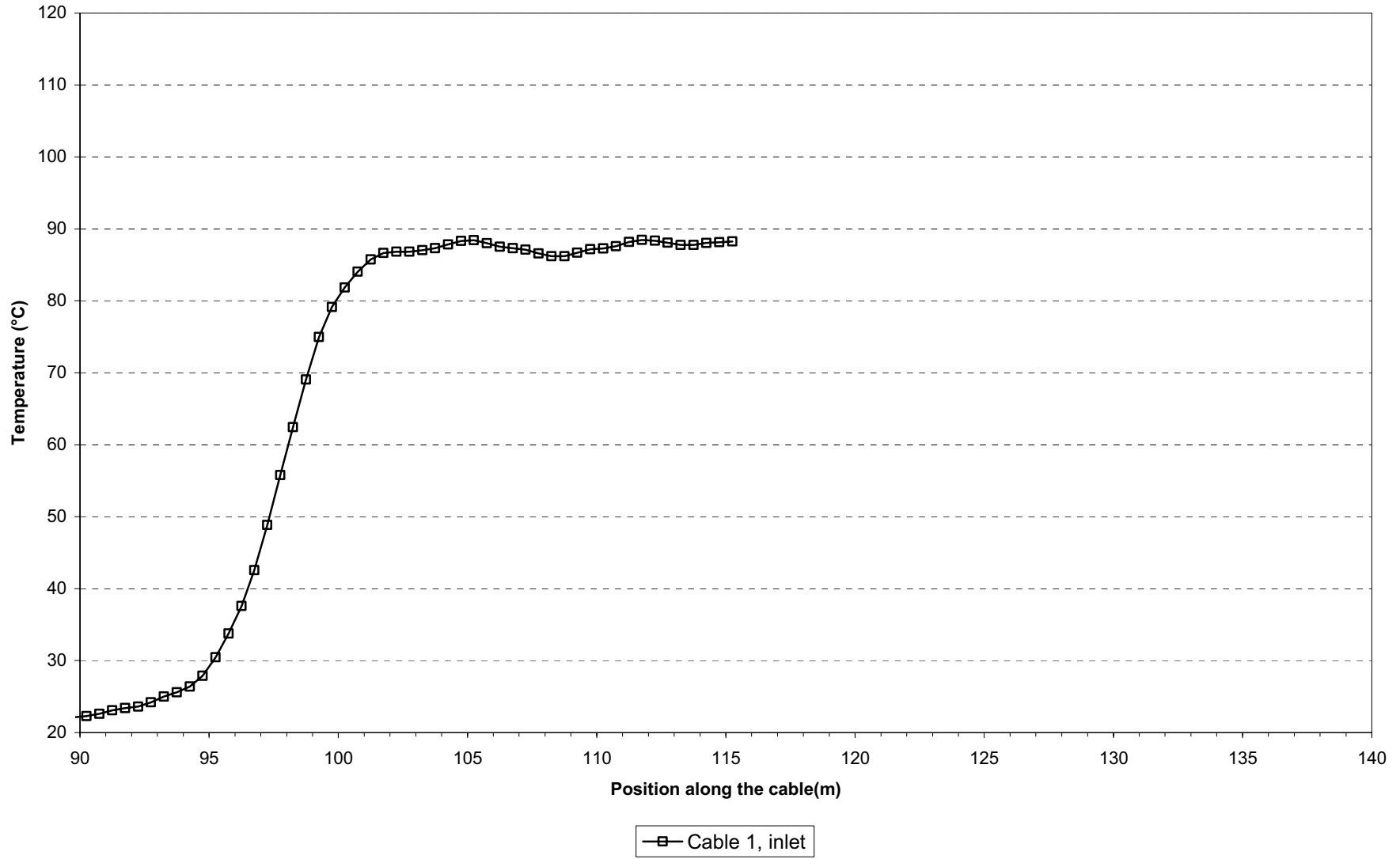

Appendix 4

Backfill in section 1

Prototype\Backfill\Section 1 (010917-041201)
Total pressure - Geokon

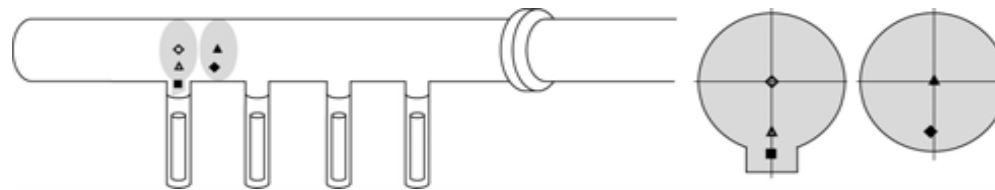
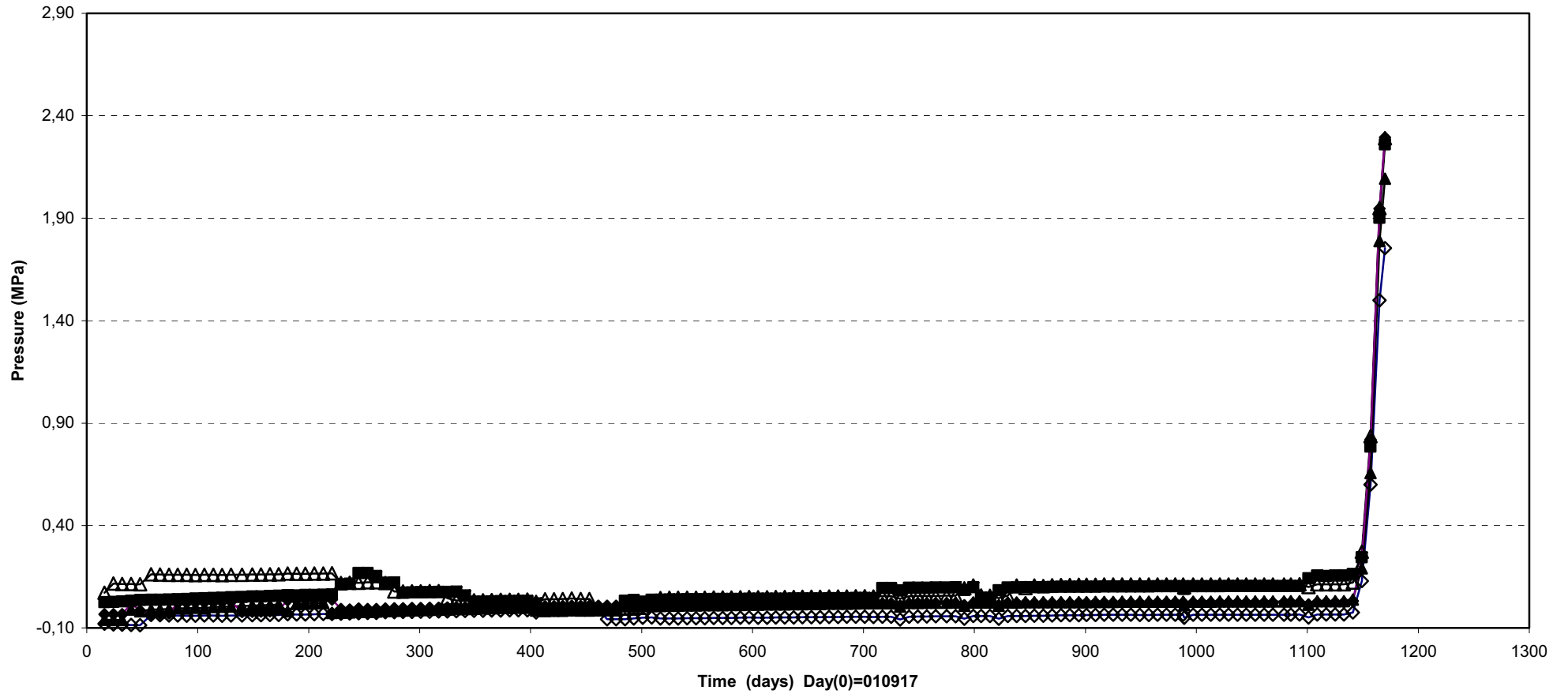

◆ PBA10002(E1\0\0\3587)
 ▲ PBA10003(E1\0 \-1,8\3587)
 ■ PBA10004(E1\0 \-2,6\3587)
 ▲ PBA10008(F1-2\0\0\3584)
 ◆ PBA10009(F1-2\0.1\1,8\3584)

Prototype\Backfill\ Section 1 (010917-041201)
 Total pressure - Geokon

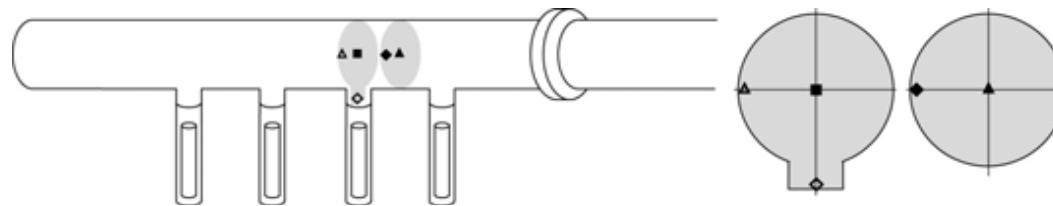
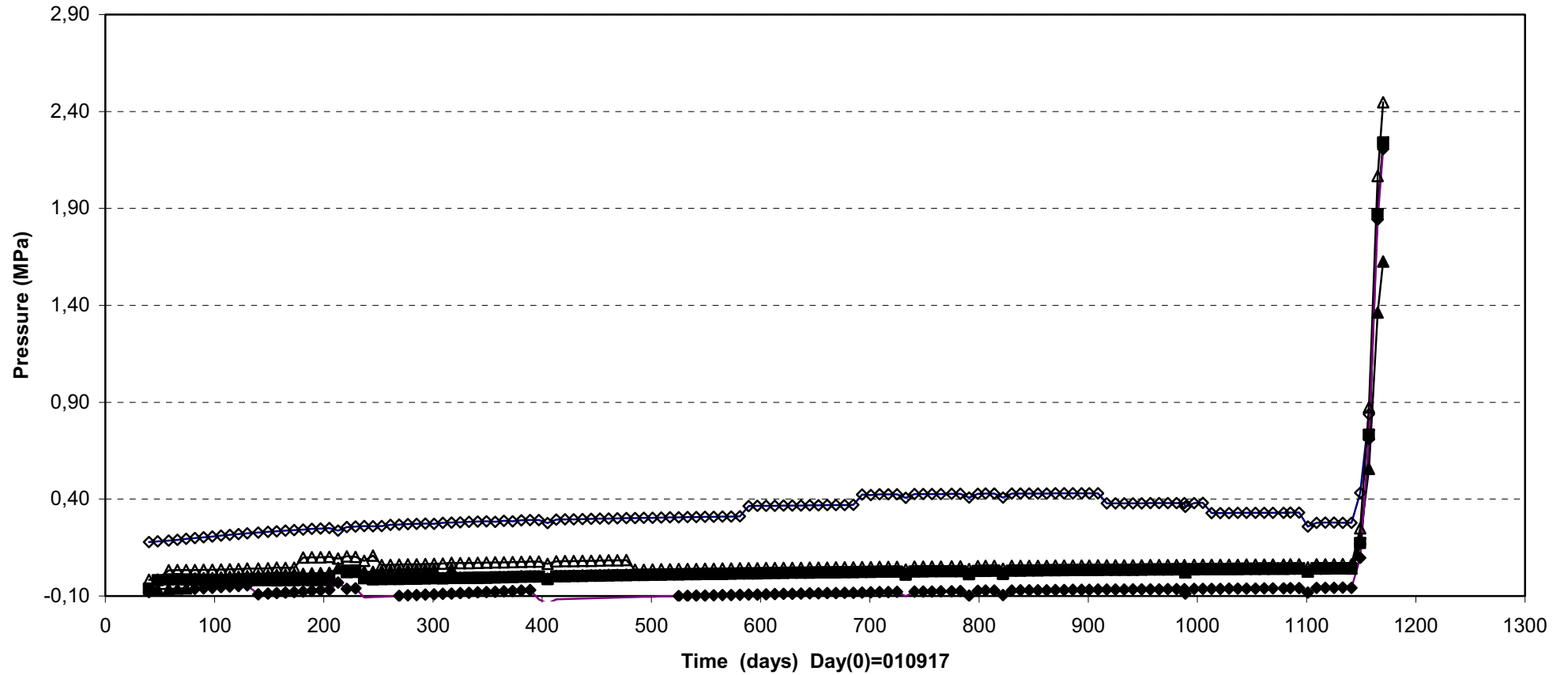

PBA10015(E3\0\3.1\3575)
 PBA10016(E3\2.3\0\3575)
 PBA10017(E3\0\0\3574)
 PBA10018(F3-4\0\0\3572)
 PBA10019(F3-4\0\2.3\3572)

Prototype\Backfill\Section 1 (010917-041201)
Total pressure - Kulite

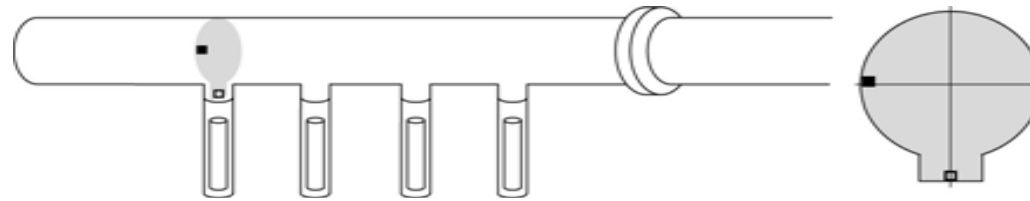
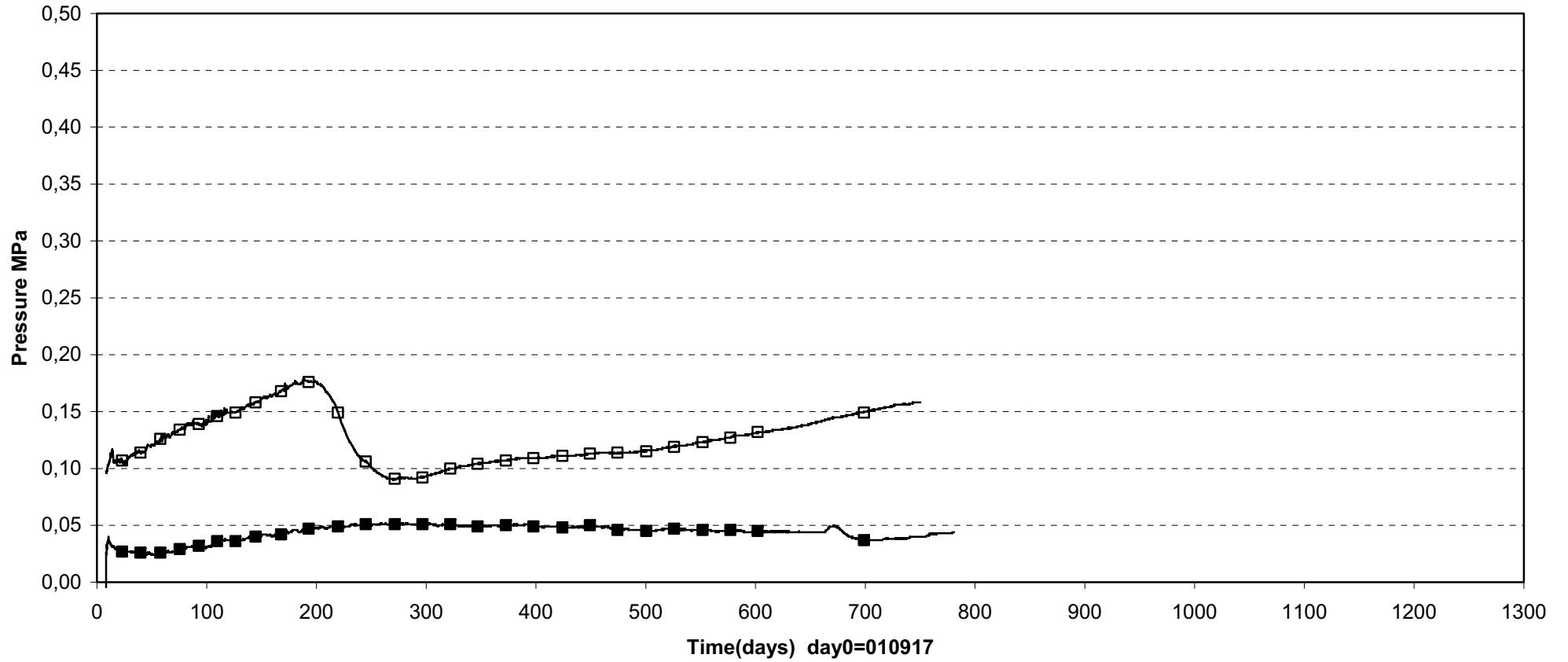

□ PBA10005(E1\0\ -3.1\3587) ■ PBA10006(E1\ -2.3\0.1\3587)

Prototype\Backfill\Section 1 (010917-041201)
 Total pressure - Kulite

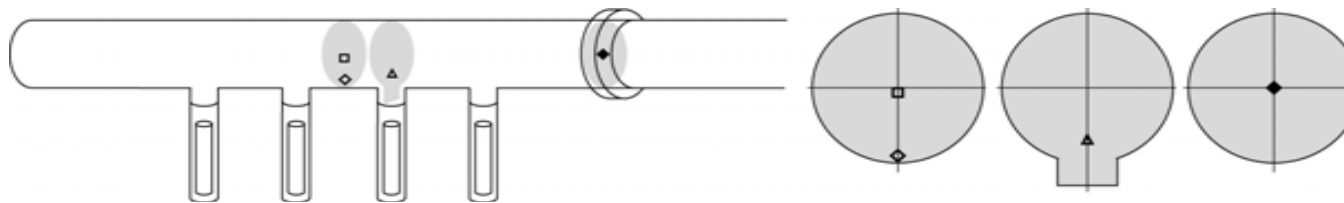
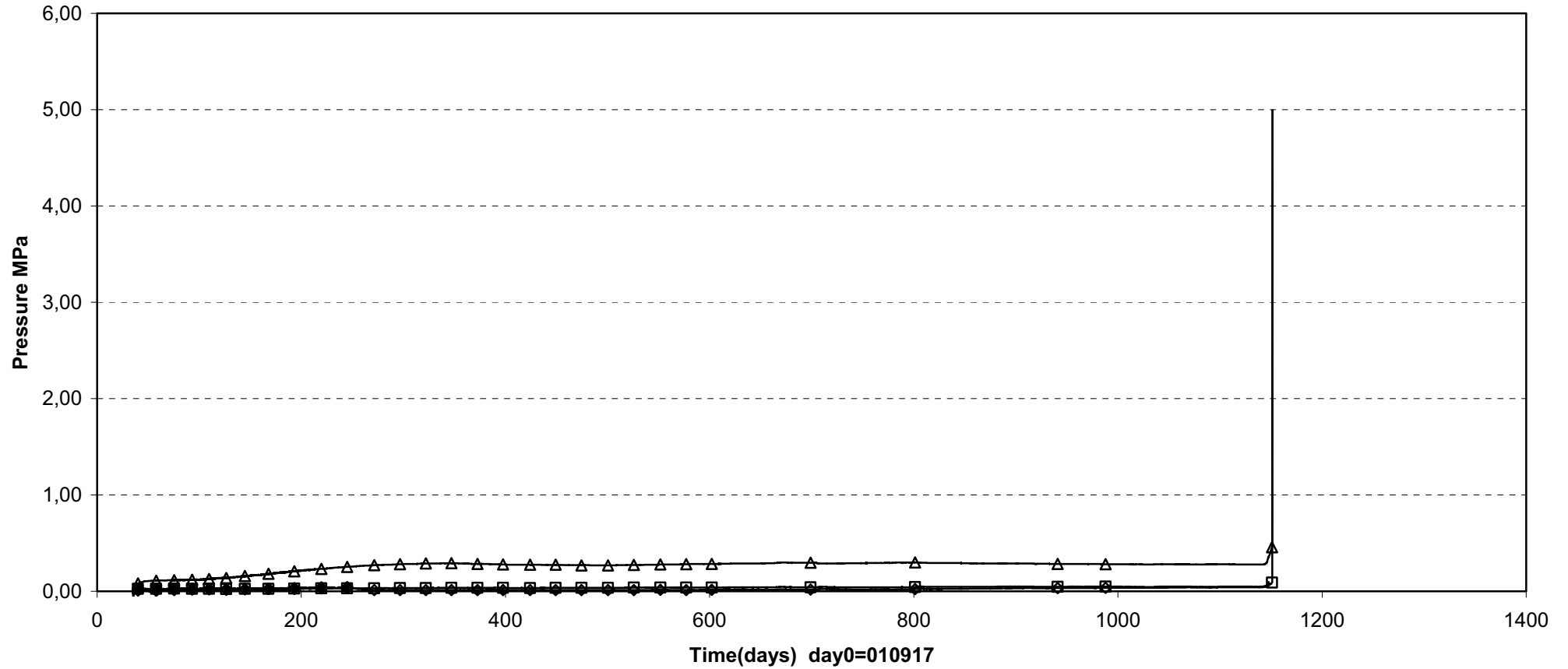

□ PBA10010(F1-2\0\0-0.2\3578) ◇ PBA10011(F1-2\0\0-2.3\3578) △ PBA10013(E3\0\0-1.82\3575) ◆ PBA10020(In front of plug\0\0\3561)

Prototype\Backfill \ Inner part (010917-041201)
Suction - Wescor

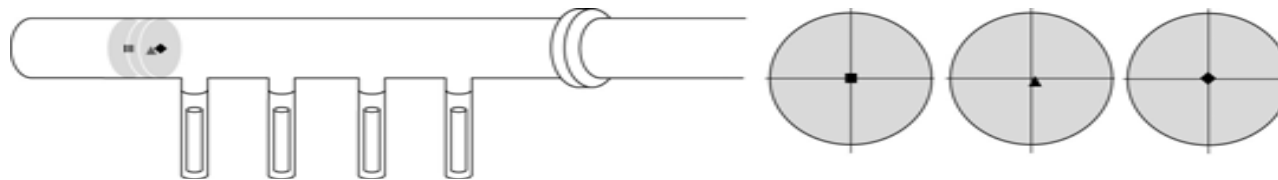
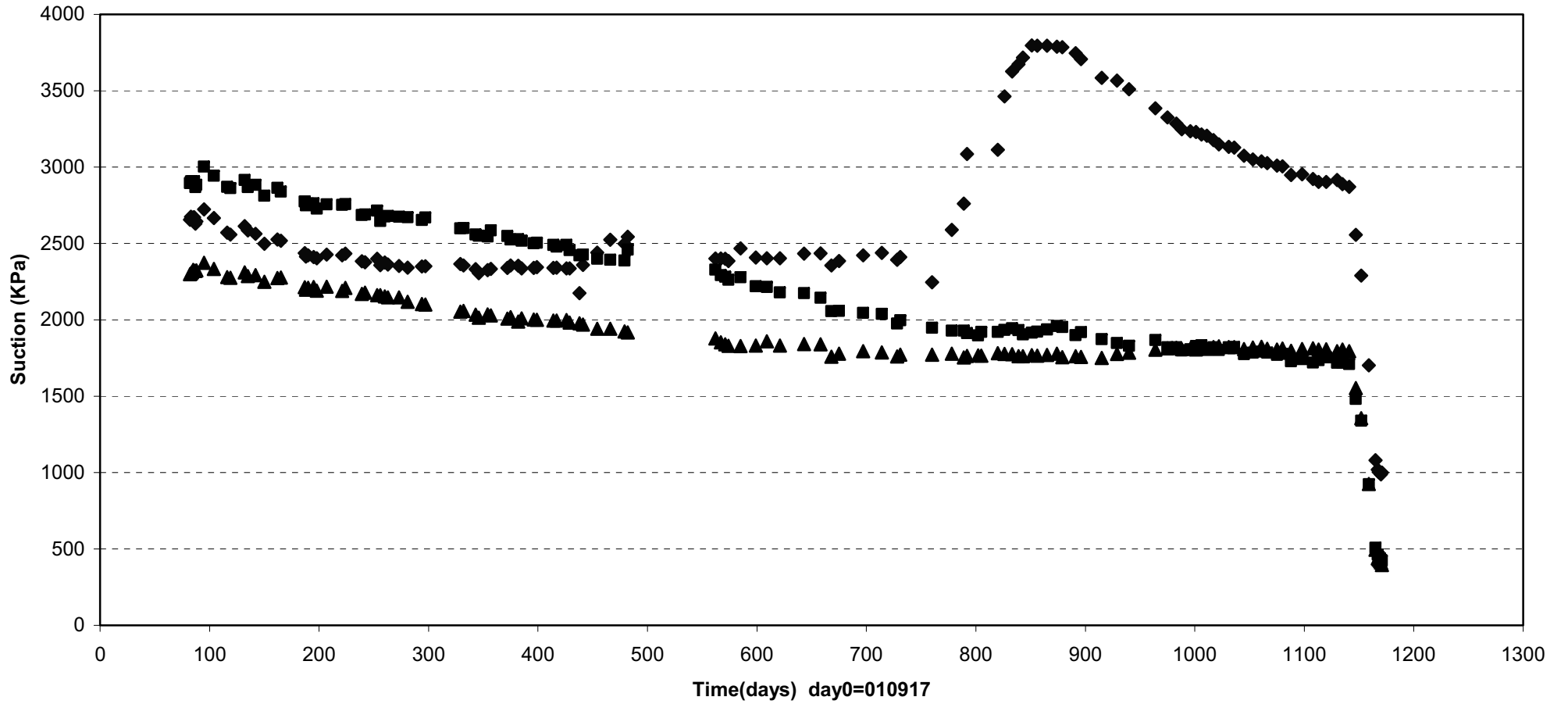

◆ WBA10001(Inner part\0\0\3589) ■ WBA10002(Inner part\0\0\3592) ▲ WBA10003(Inner part\0.1\0.1\3590)

Prototype\Backfill\ Above dep.hole 1 (010917-041201)
Suction - Wescor

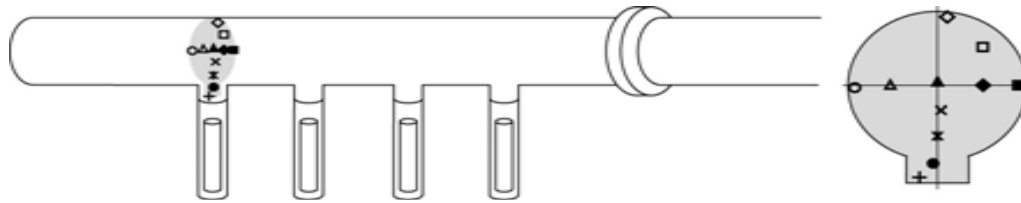
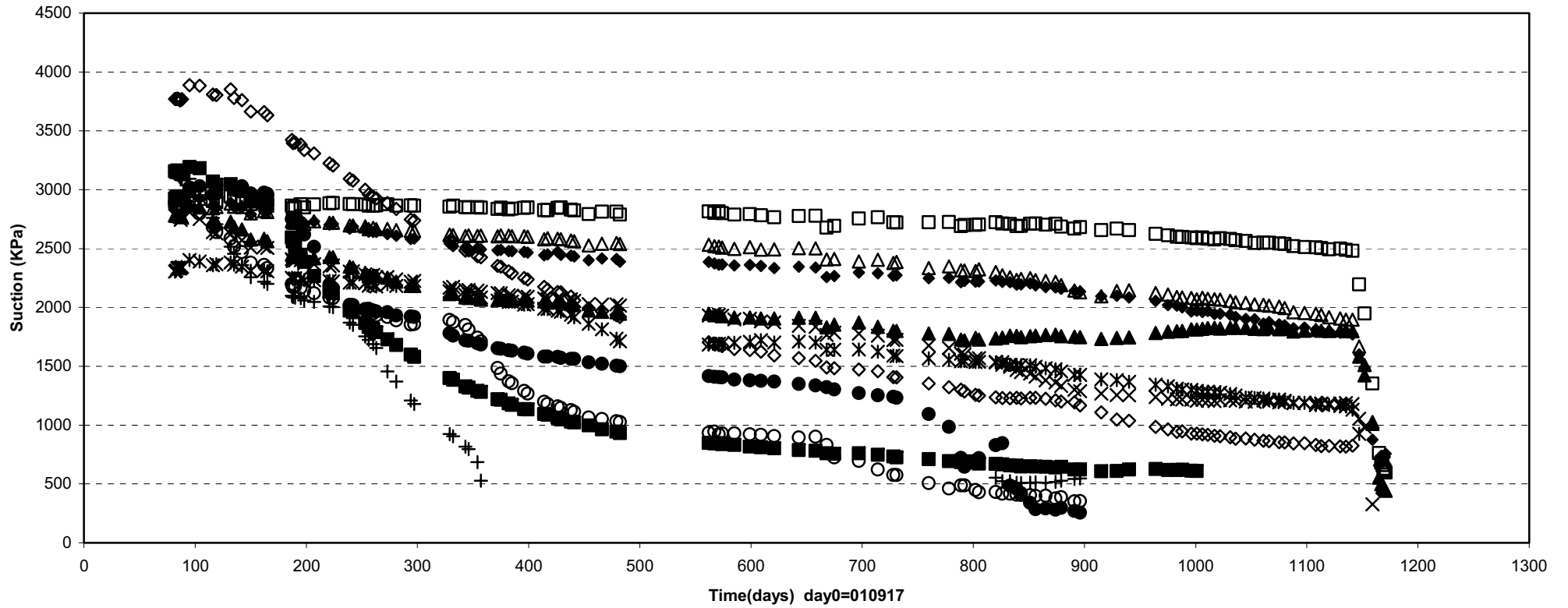

- | | | | |
|------------------------------|-----------------------------|---------------------------|-----------------------------|
| ◇ WBA10004(E1\0.25\2.3\3587) | □ WBA10005(E1\0\1.25\3587) | ▲ WBA10006(E1\0\0.1\3587) | × WBA10007(E1\0.1\0.8\3587) |
| ✱ WBA10008(E1\0\1.7\3587) | ● WBA10009(E1\0.1\2.6\3587) | + | ○ WBA10011(E1\2.3\0.1\3587) |
| △ WBA10012(E1\1.3\0\3587) | ◆ WBA10013(E1\1.3\0\3587) | ■ WBA10014(E1\2.3\0\3587) | |

Prototype\Backfill \ Between dep.hole 1 and hole 2 (010917-041201)
Suction - Wescor

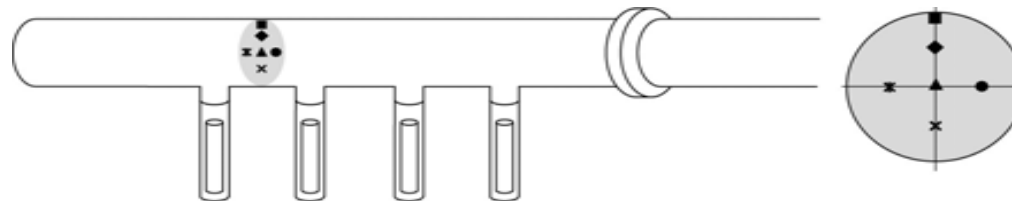
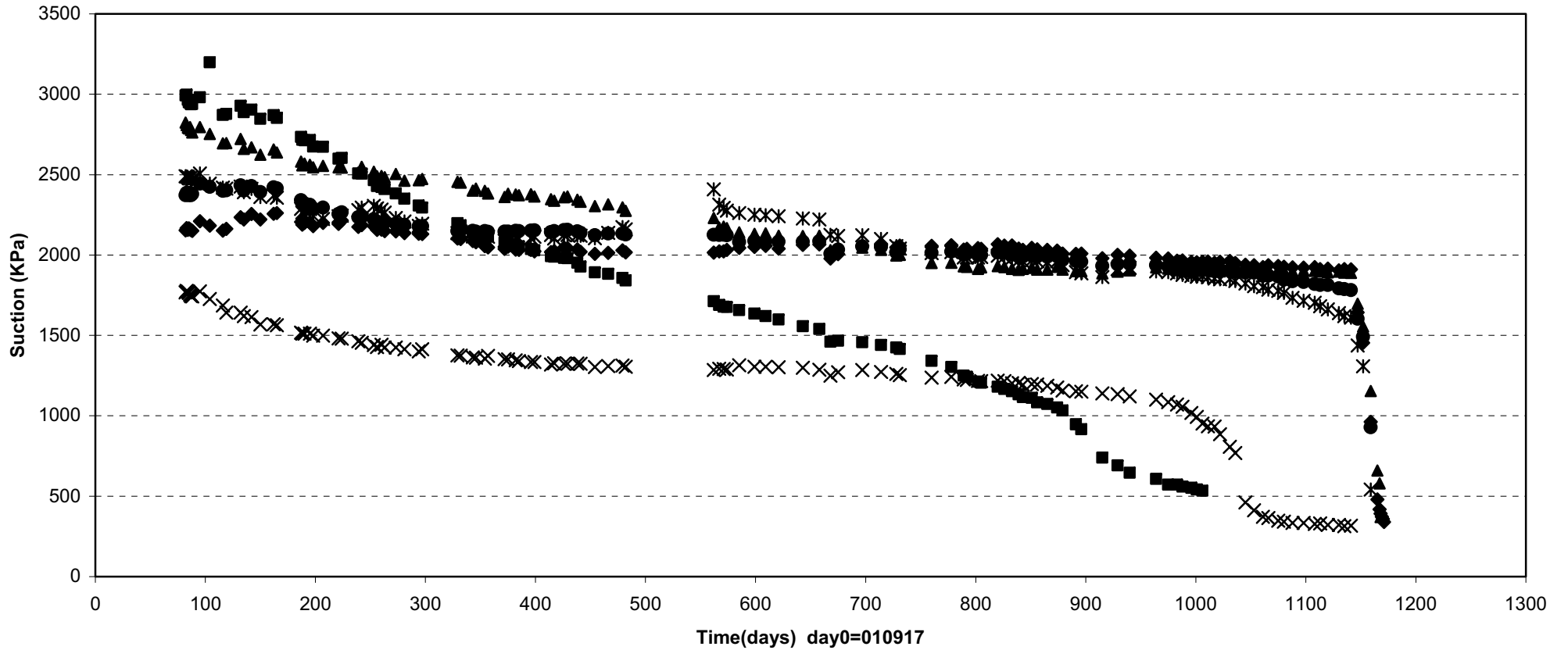

◆ WBA10015(F1-2\0\1.3\3584) ■ WBA10016(F1-2\0\2.3\3584) ▲ WBA10017(F1-2\0\0\3584) × WBA10018(F1-2\0\-1.3\3584)
 ✱ WBA10019(F1-2\-1.3\0\3584) ● WBA10020(F1-2\1.3\0\3584)

Prototype\Backfill \ Between dep.hole 2 and hole 3 (010917-041201)

Suction - Wescor

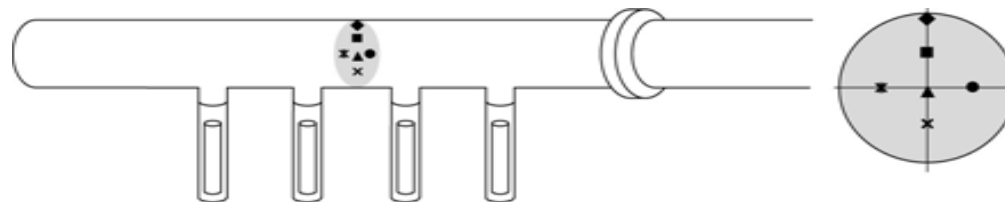
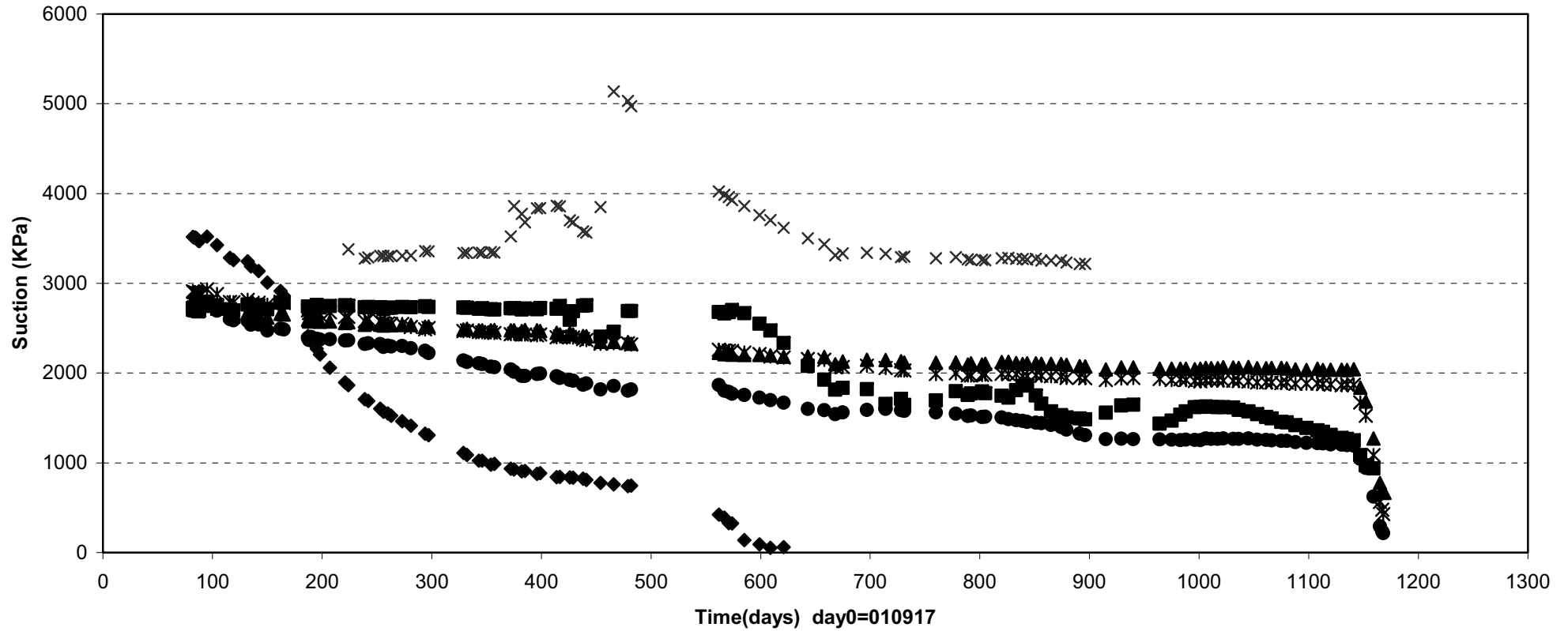

- ◆ WBA10021(F2-3\0\2.3\3578) ■ WBA10022(F2-3\0\1.2\3578) ▲ WBA10023(F2-3\0\0.2\3578) ✖ WBA10025(F2-3\0\1.3\3578)
- WBA10026(F2-3\1.3\0\3578) × WBA10024(F2-3\0\1.2\3578)

Prototype\Backfill\ Above dep.hole 3 (010917-041201)
Suction - Wescor

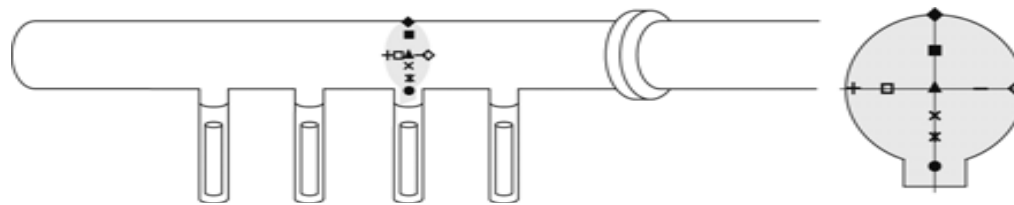
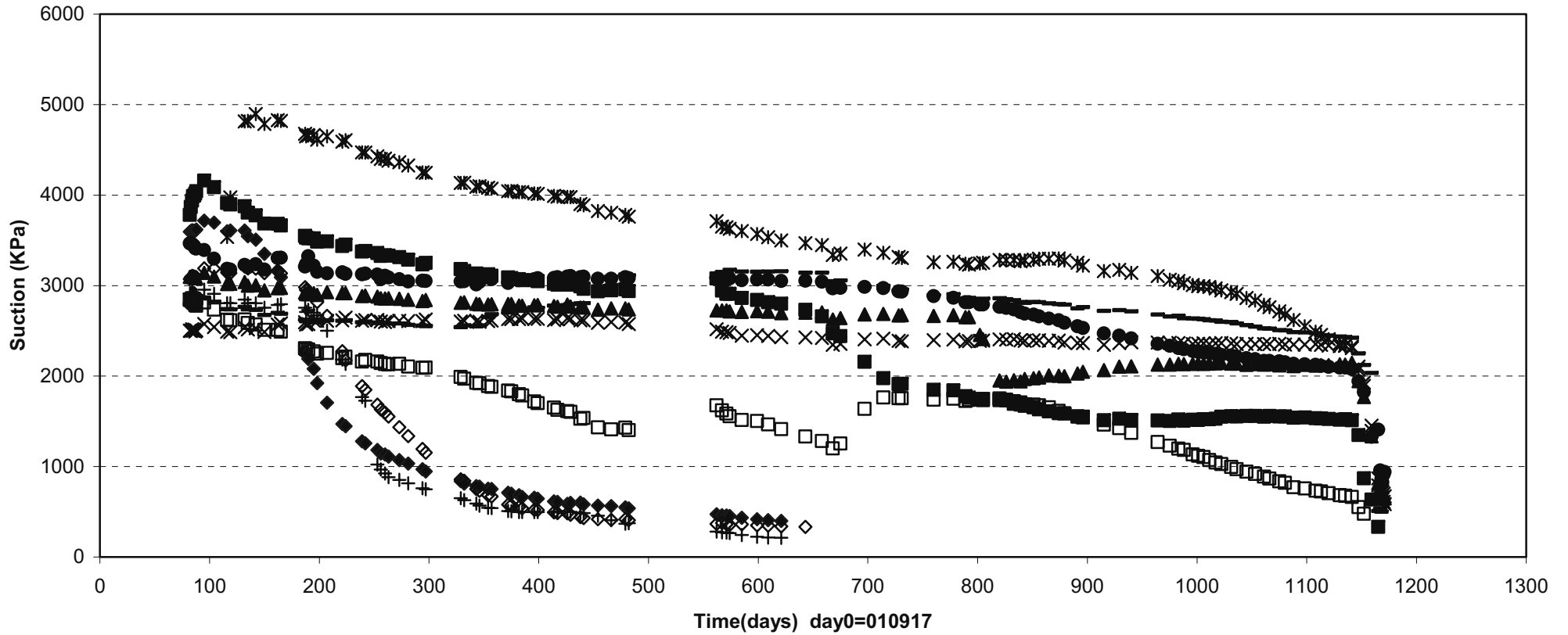

- ◆ WBA10027(E3\0\2.5\3574) ■ WBA10028(E3\0\1.3\3575) ▲ WBA10029(E3\0\0\3575) × WBA10030(E3\0\0-0.9\3575) ✖ WBA10031(E3\0\1.6\3575)
- WBA10032(E3\0-0.3\2.6\3575) + WBA10034(E3\2.3\0\3575) □ WBA10035(E3\1.3\0\3575) - WBA10036(E3\1.3\0\3575) ◇ WBA10037(E3\2.3\0\3575)

Prototype\Backfill \ Between dep.hole 3 and hole 4 (010917-041201)
Suction - Wescor

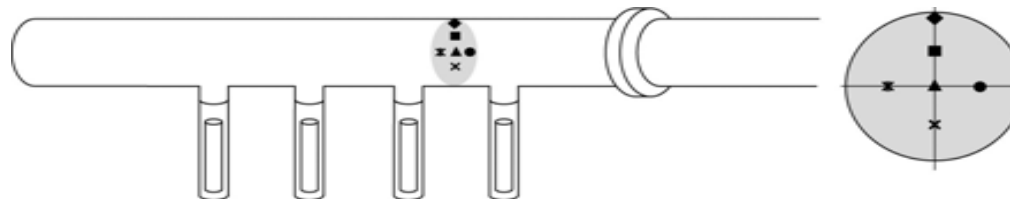
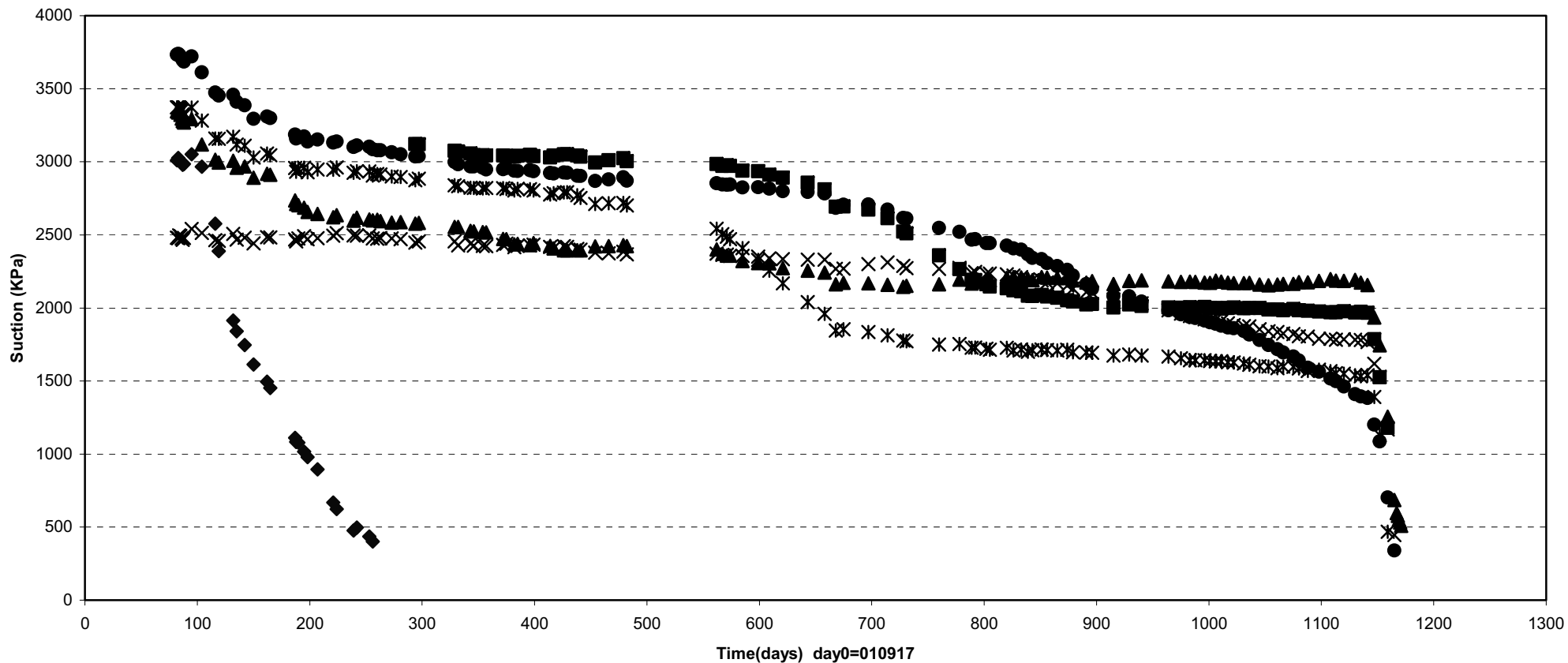

- | | | | |
|------------------------------|------------------------------|----------------------------|-------------------------------|
| ◆ WBA10038(F3- 4\0\2.3\3572) | ■ WBA10039(F3- 4\0\1.2\3572) | ▲ WBA10040(F3- 4\0\0\3572) | × WBA10041(F3- 4\0\-1.3\3572) |
| ✱ WBA10042(F3- 4\1.3\0\3572) | ● WBA10043(F3- 4\1.3\0\3572) | | |

Prototype\Backfill \ In front of plug (010917-041201)
 Suction - Wescor

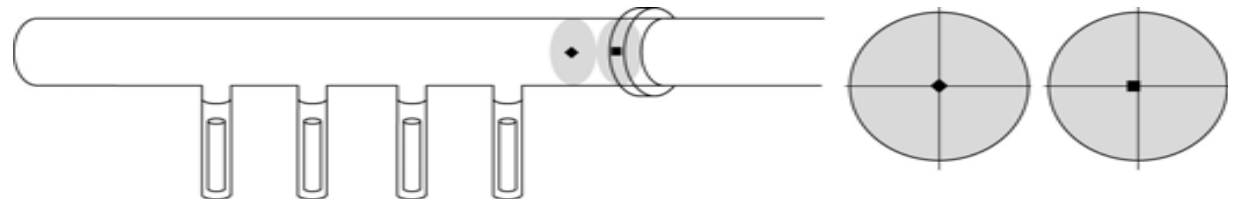
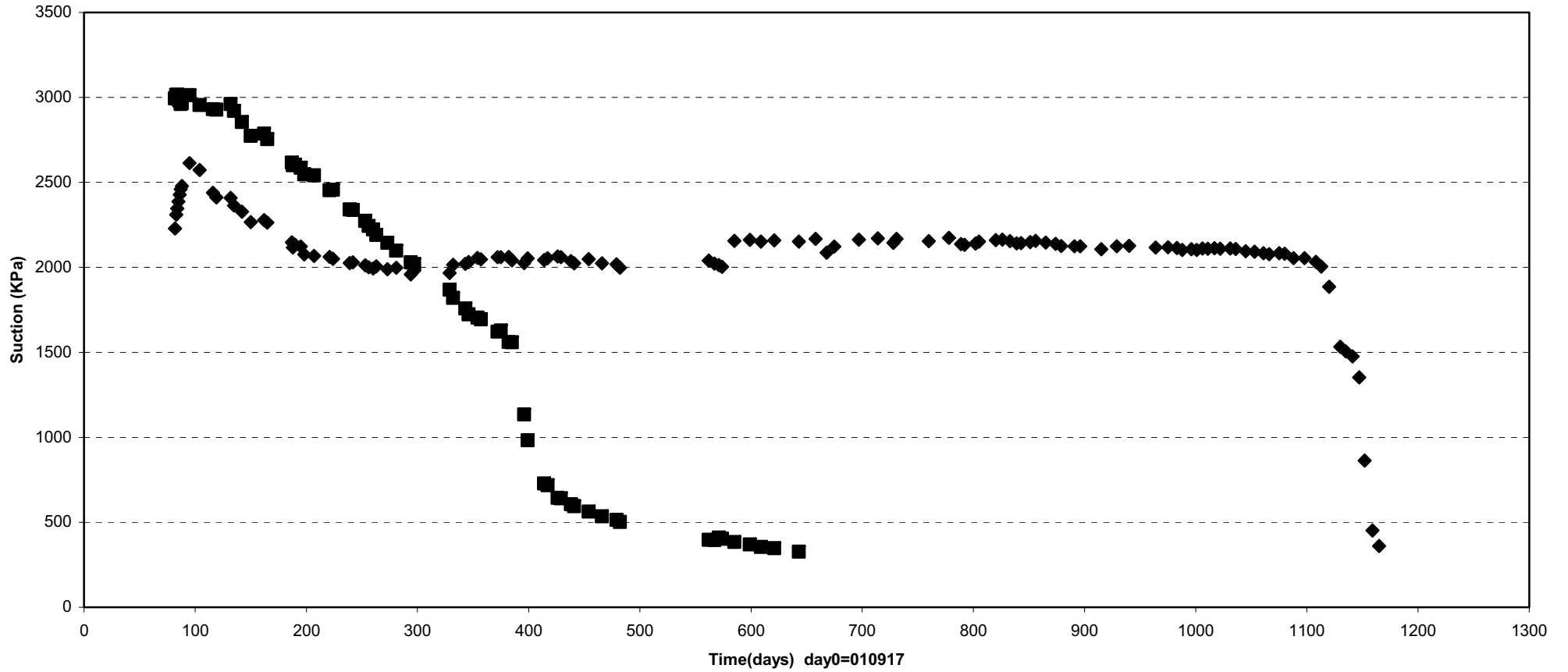

◆ WBA10044(In front of plug\0\0\3565) ■ WBA10045(In front of plug\0.1\0\3562)

Prototype\Backfill\Section 1 (010917-041201)
Pore pressure - Geokon

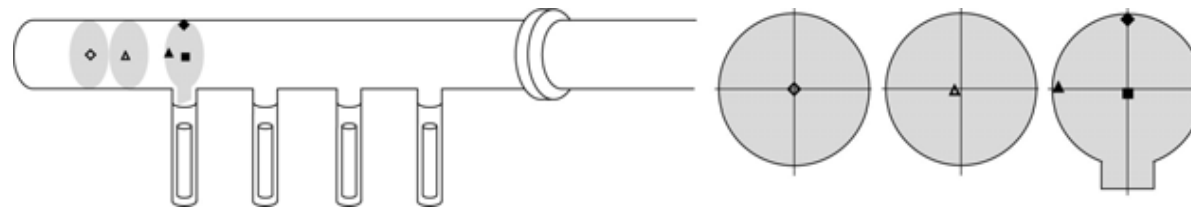
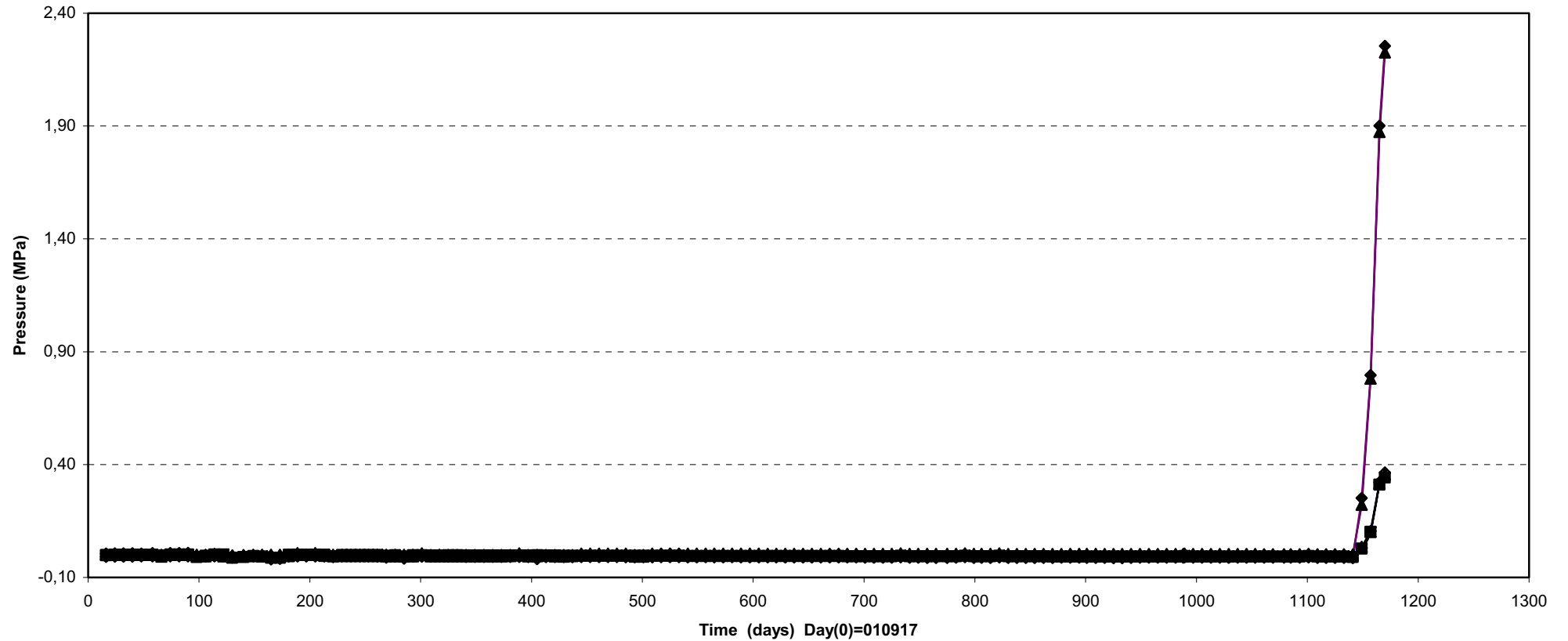

- ◇— UBA10002 (Inner part\0\0\3592)
- ▲— UBA10003 (Inner part\0.2\0.1\3590)
- UBA10004 (E1\0\0\3587)
- ▲— UBA10008 (E1\2.3\0\3587)
- ◆— UBA10009 (E1\0\2.3\3587)

Prototype\Backfill \ Section 1 (010917-041201)
 Pore pressure - Geokon

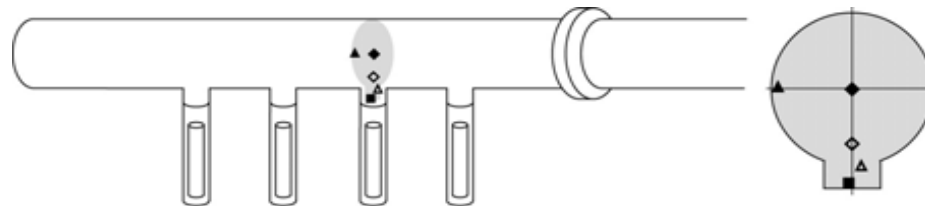
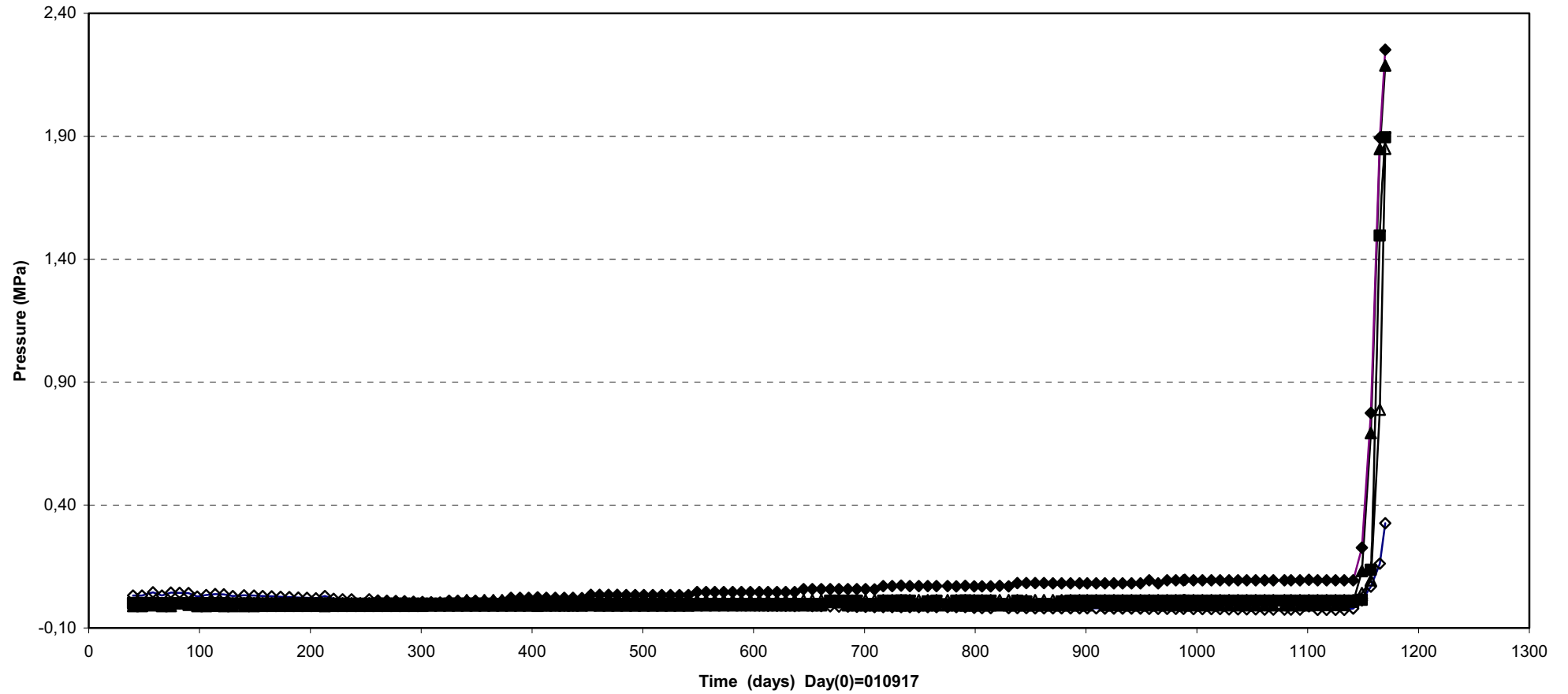

◆ UBA10015(E3\0\1.82\3575)
 ▲ UBA10016(E3\0.25\2.6\3575)
 ■ UBA10017(E3\0.1\3.1\3575)
 ▲ UBA10018(E3\2.3\0\3575)
 ◆ UBA10019(E3\0\0\3574)

Prototype\Backfill\ Section 1 (010917-041201)
 Pore pressure - Kulite

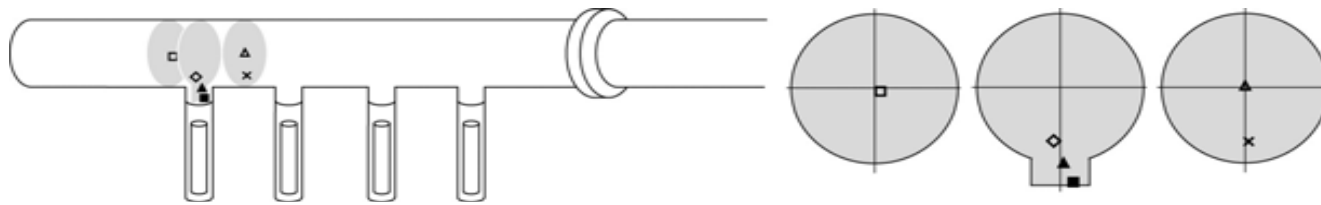
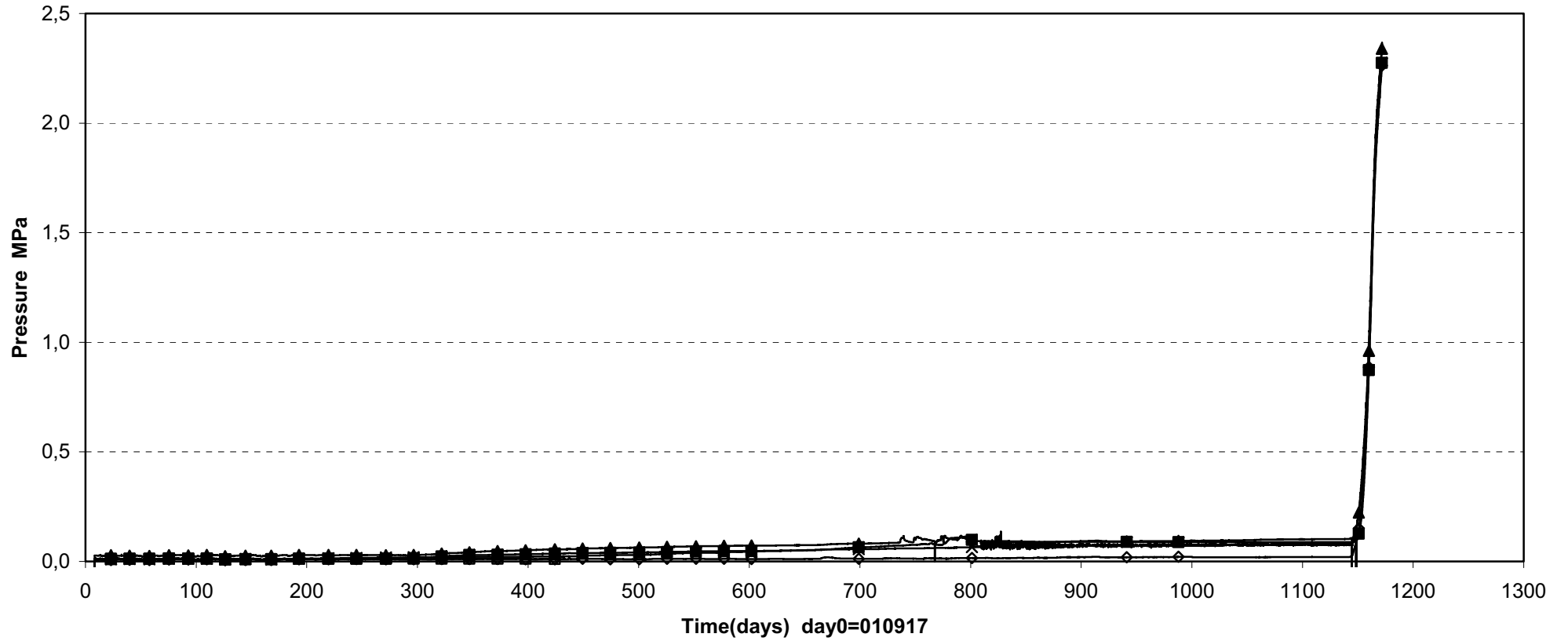

- | | | |
|-------------------------------------|-----------------------------|-------------------------------|
| □ UBA10001(Inner part\0.2\0.1\3589) | ◇ UBA10005(E1\0.2\1.8\3587) | ▲ UBA10006(E1\0.1\2.6\3587) |
| ■ UBA10007(E1\0.4\3.2\3587) | △ UBA10010(F1-2\0\0\3584) | × UBA10011(F1-2\0.1\1.2\3584) |

Prototype\Backfill \Section 1 (010917-041201)
Pore pressure - Kulite

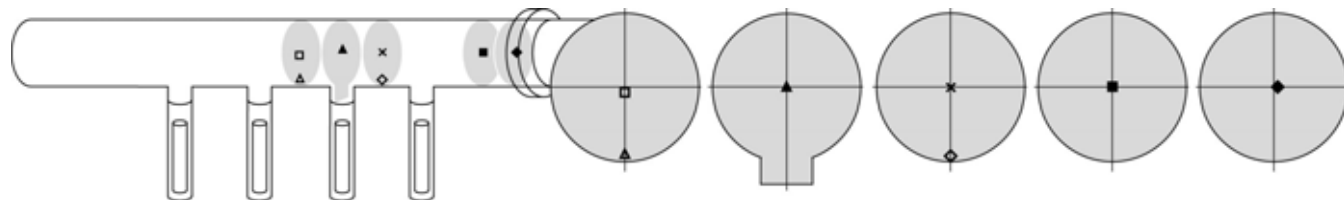
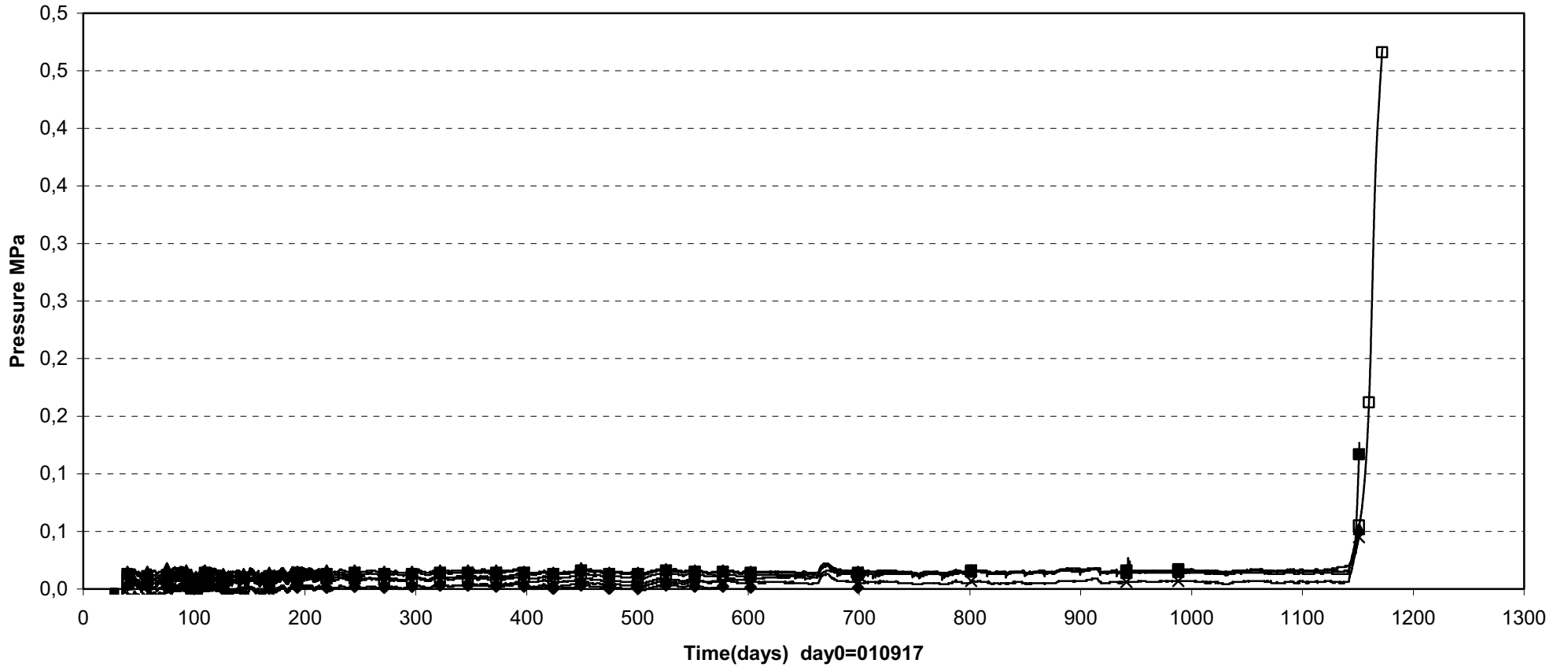

□ UBA10012(F2-3\0\0.2\3578)	△ UBA10013(F2-3\0\0.2.3\3578)	▲ UBA10014(E3\0\0\3575)	× UBA10020(F3-4\0\0\3572)
◇ UBA10021(F3-4\0\0.2.3\3572)	■ UBA10022(In front of plug\0\0\3565)	◆ UBA10023(In front of plug\0.1\0\3561)	

Prototype\ Backfill \ Above dep.hole1 (010917-041201)
 Temperature - Pentronic

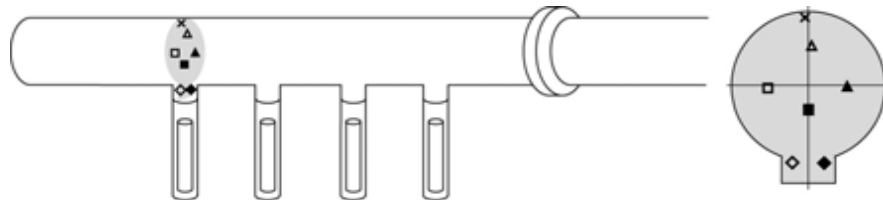
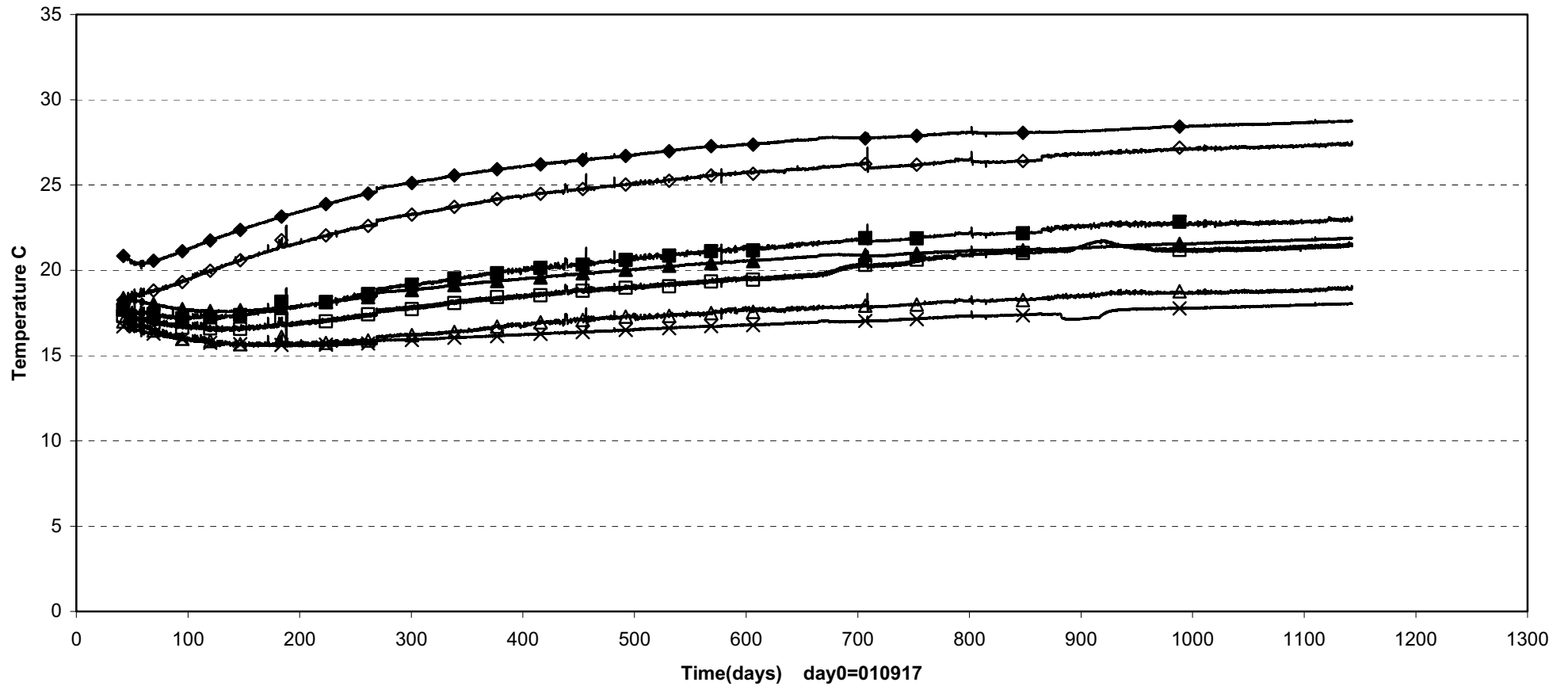

- TBA10001(E1\1.25\0.1\3587) △ TBA10002(E1\0.1\1.3\3587) ■ TBA10003(E1\0-0.8\3587) ◇ TBA10004(E1\0.5\2.6\3587)
- ◆ TBA10005(E1\0.5\2.6\3587) × TBA10006(E1\0.1\2.3\3587) ▲ TBA10007(E1\1.25\0.1\3587)

Prototype\ Backfill \ Between dep.hole 1-2 (010917-041201)
 Temperature - Pentronic

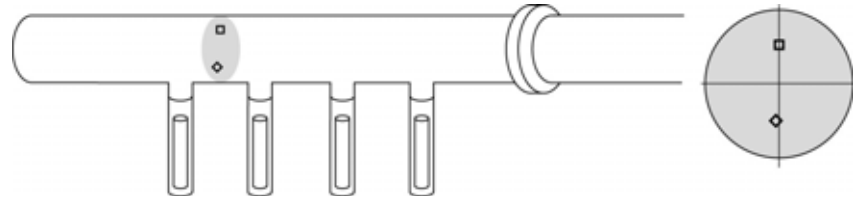
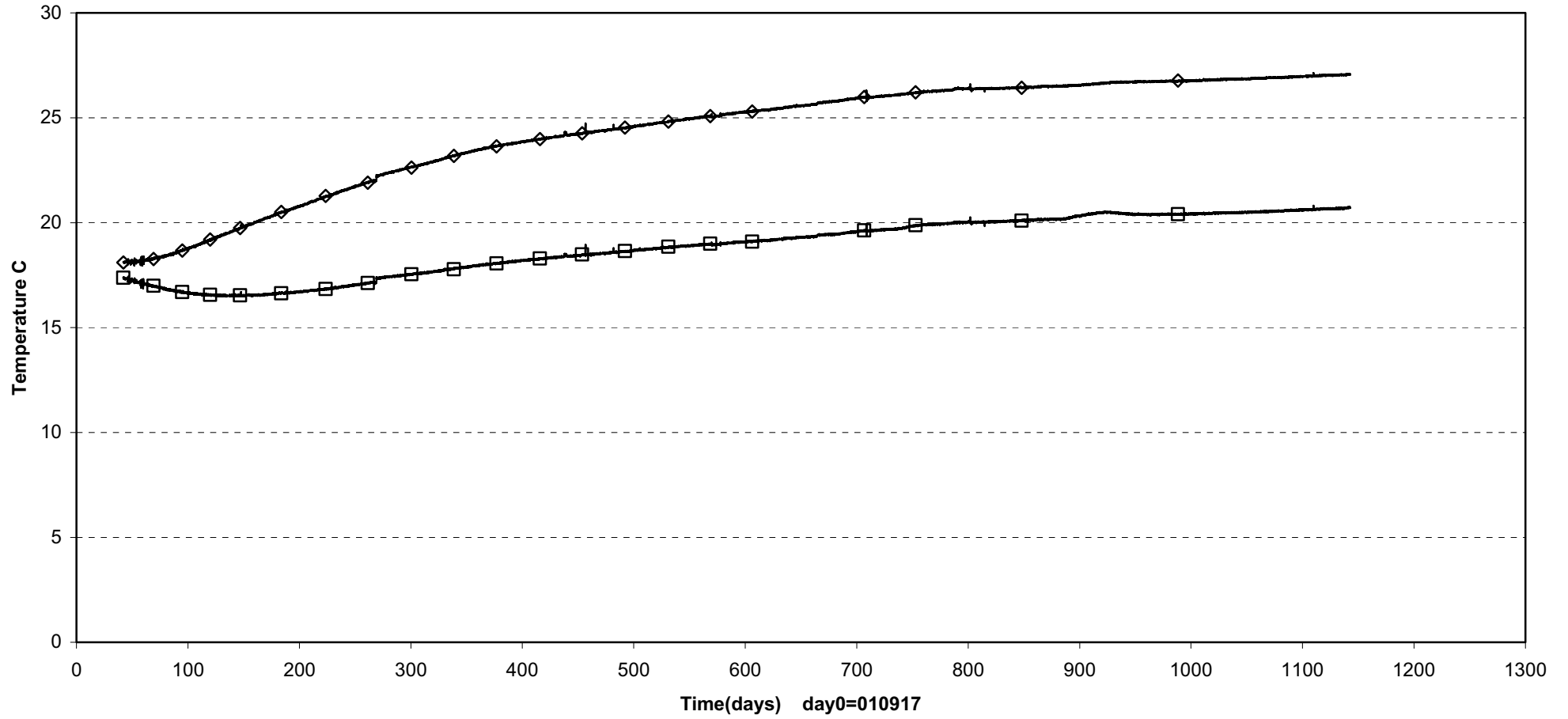

□ TBA10008(F1-2\0\1.25\3584) ◇ TBA10009(F1-2\0\0.1\1.3\3584)

Prototype\ Backfill \ Between dep.hole 2-3 (010917-041201)
 Temperature -Pentronic

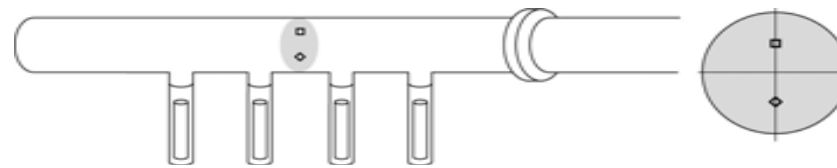
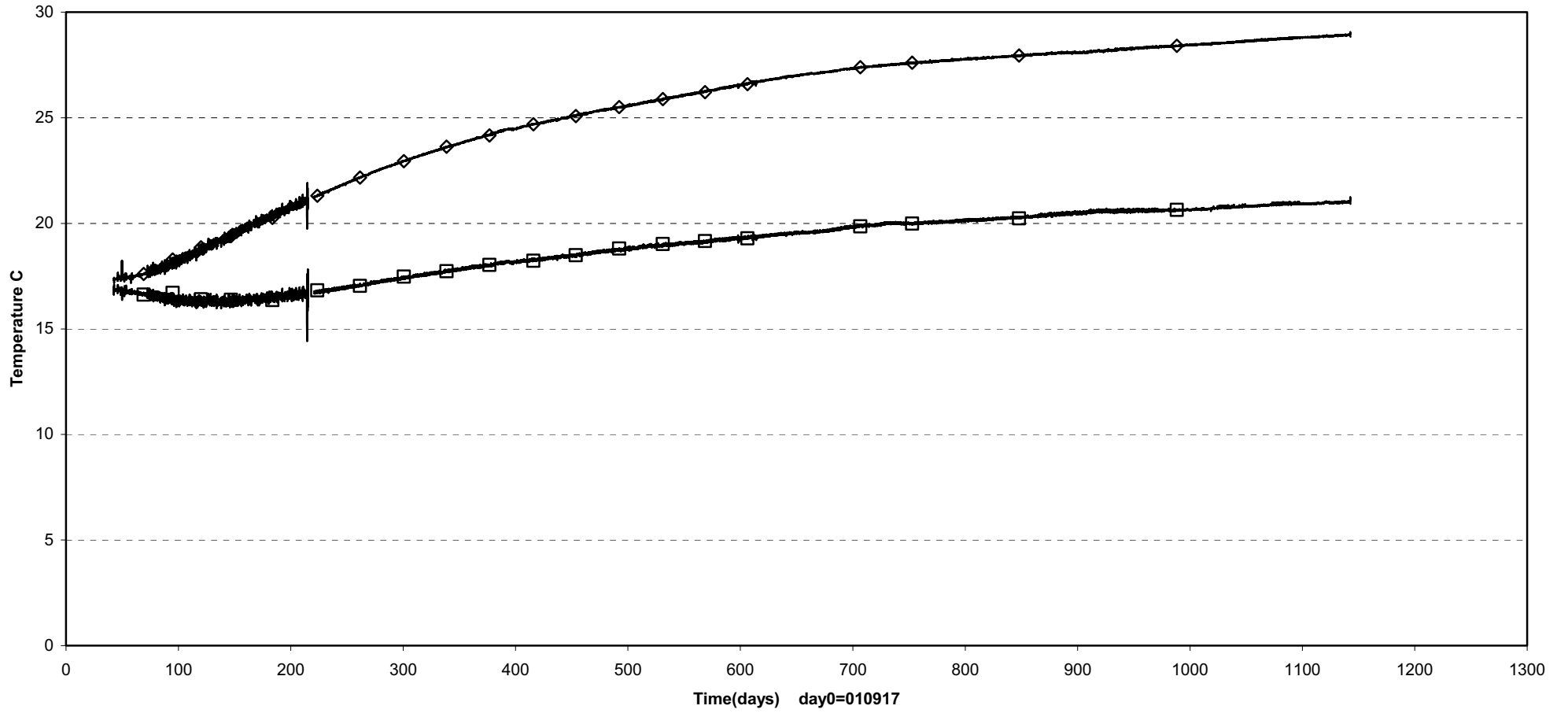

□ TBA10010(F2-3\0\1.15\3578) ◇ TBA10011(F2-3\0\1.24\3578)

Prototype\ Backfill \ Above dep.hole3 (010917-041201)
 Temperature - Pentronic

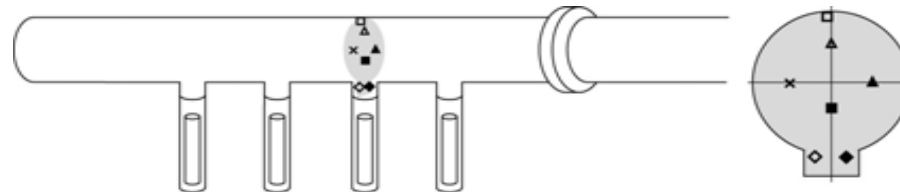
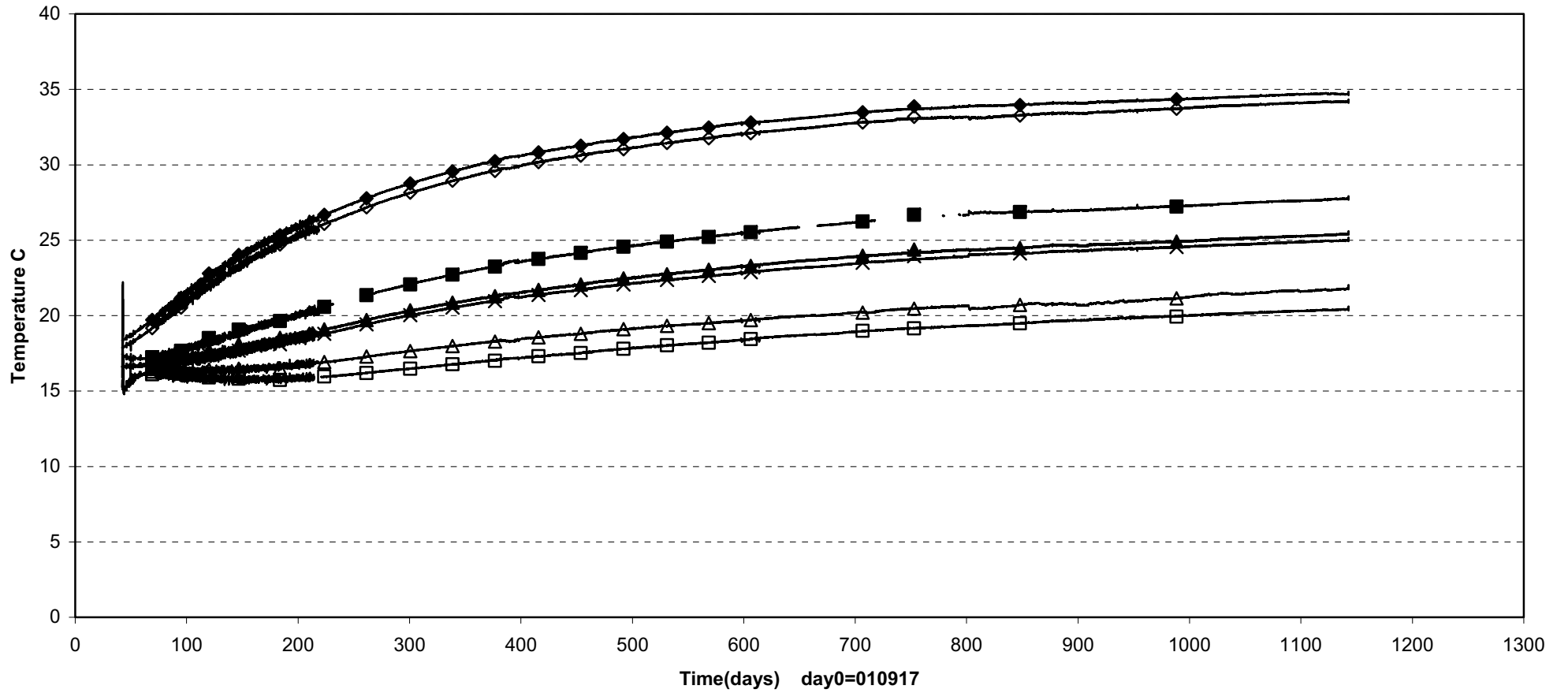

- TBA10012(E3\0.1\2.3\3575) △ TBA10013(E3\0\1.3\3575) ■ TBA10014(E3\0\0.9\3575) ◇ TBA10015(E3\0.5\2.6\3575)
- ◆ TBA10016(E3\0.5\2.6\3575) × TBA10017(E3\1.3\0\3575) ▲ TBA10018(E3\1.3\0\3575)

Prototype\ Backfill \ Between dep.hole 3-4 (010917-041201)
 Temperature - Pentronic

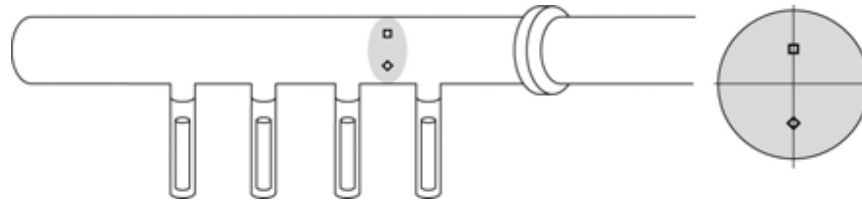
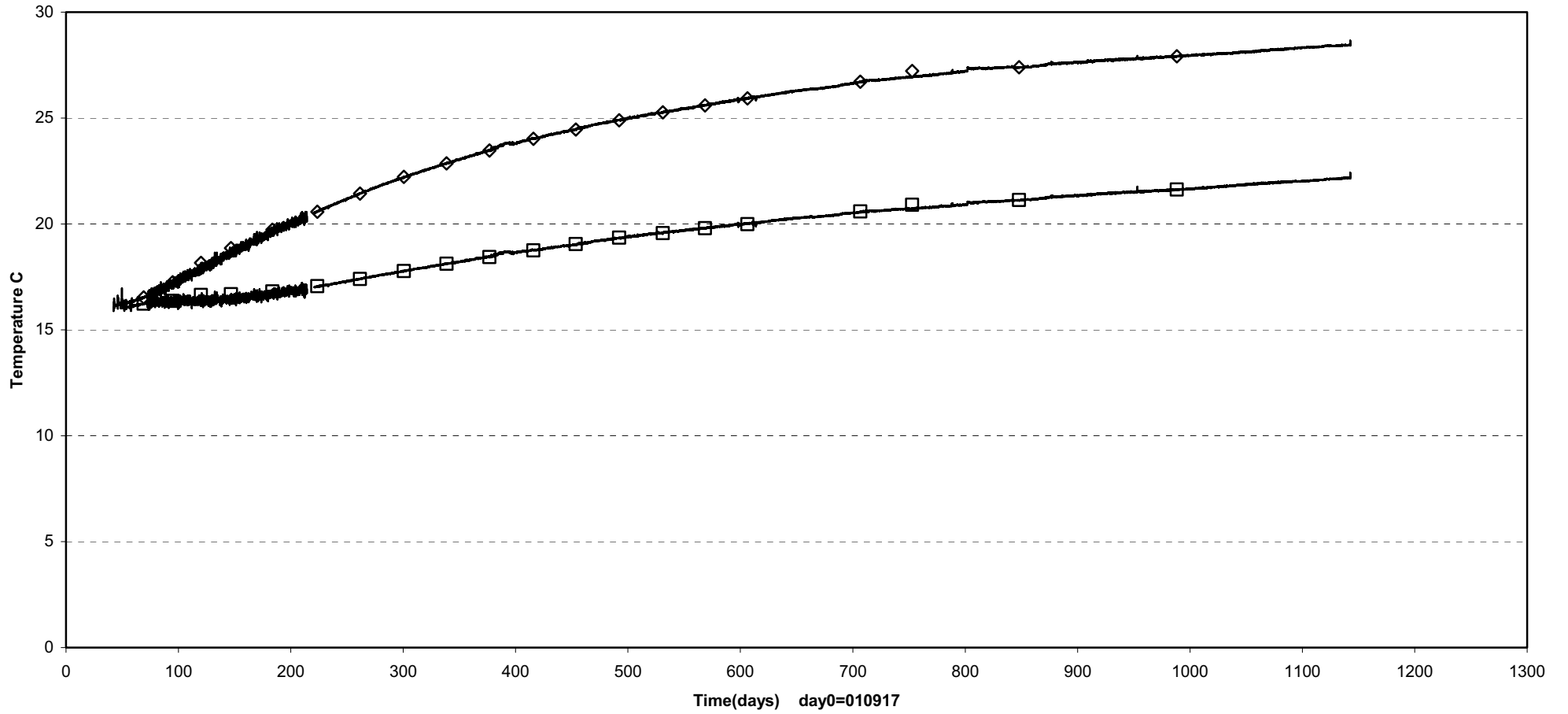

□ TBA10019(F3-4\0\1.2\3572) ◇ TBA10020(F3-4\0\1.3\3572)

Appendix 5

Dep. hole 5

Prototype\Hole 5\Cyl.1 (0430508-041201)
 Total pressure - Geokon

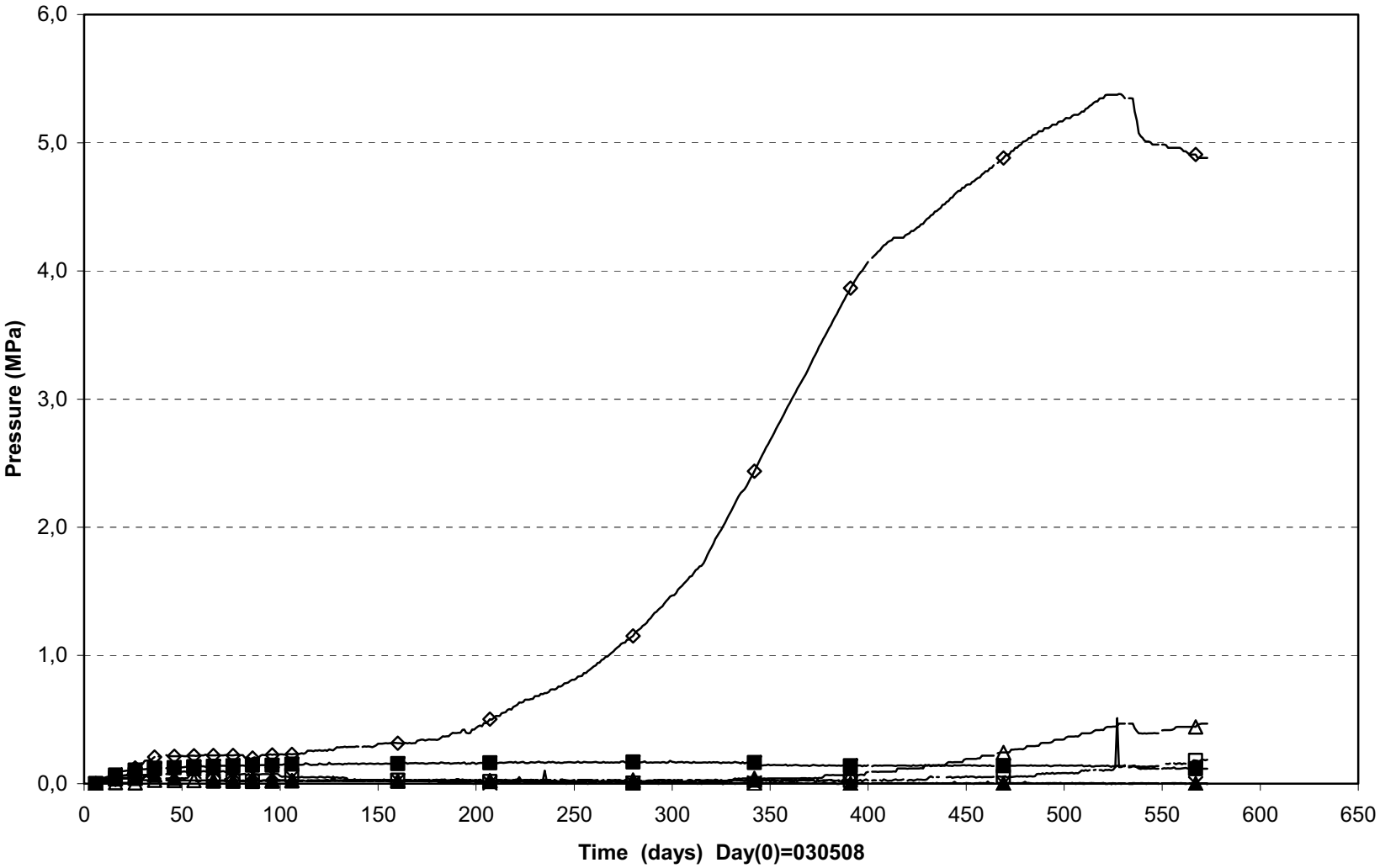

× PB501(0\0°\0)	▲ PB502(0.500\0°\0.100)	◇ PB506(0.500\95°\0.635)
△ PB507(0.500\105°\0.735)	□ PB508(0.500\185°\0.635)	■ PB509(0.500\195°\0.735)

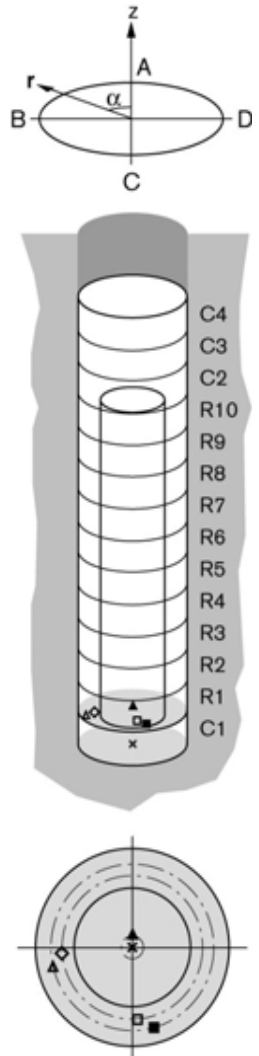

Prototype\Hole 5\Ring5 (030508-041201)
 Total pressure - Geokon

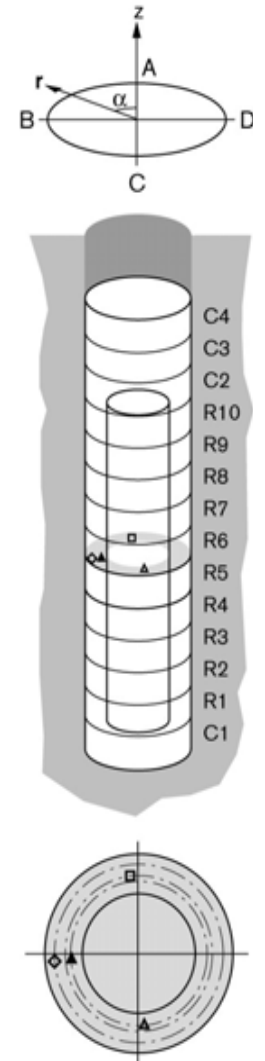
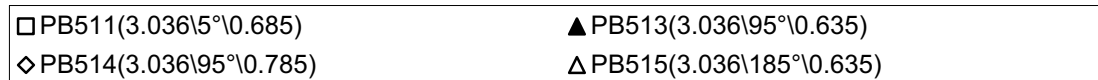
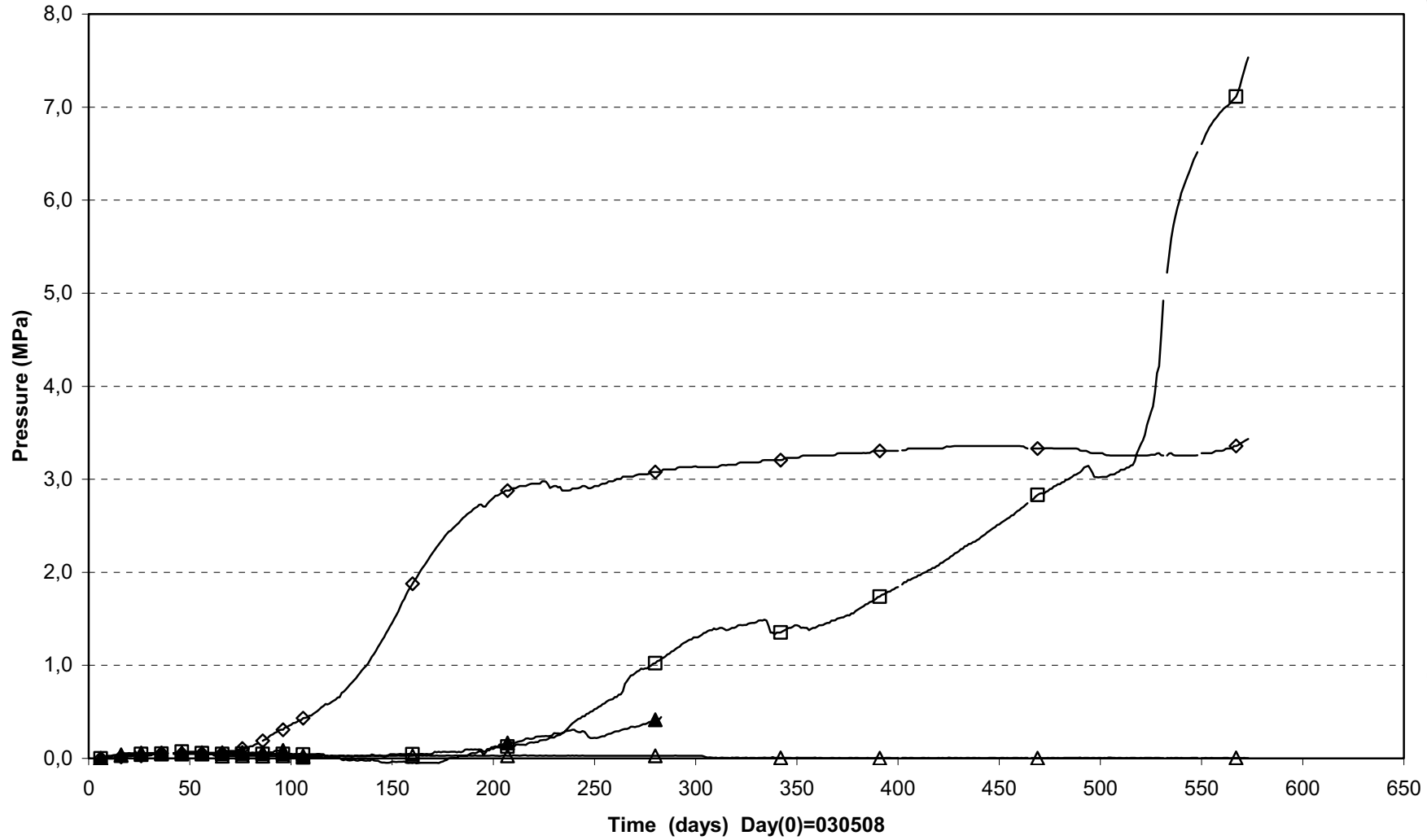

Prototype\Hole 5\Ring10 (030508-041201)
 Total pressure - Geokon

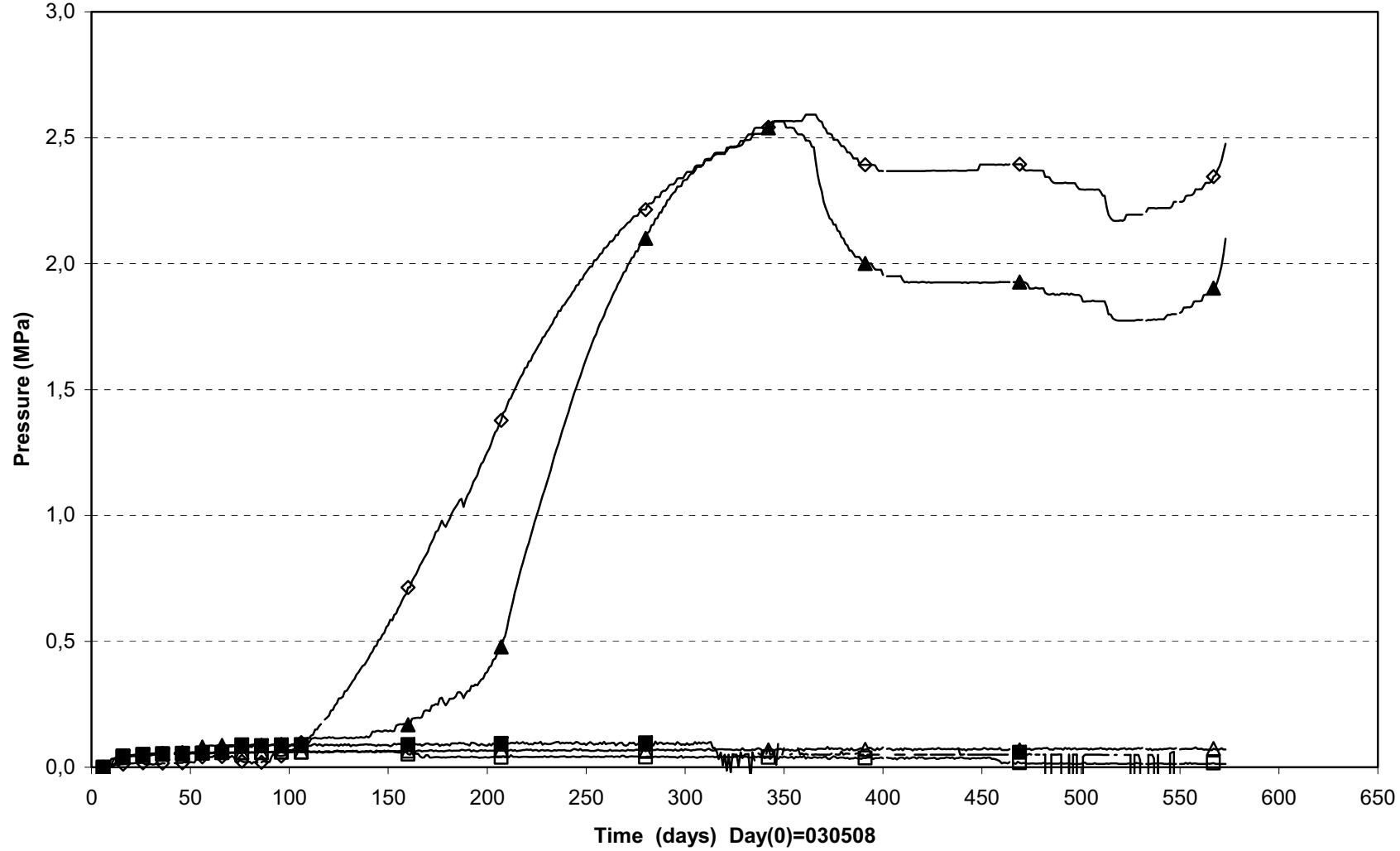

□ PB517(5.593\0°\0.050)	▲ PB521(5.593\95°\0.635)	◇ PB522(5.593\105°\0.735)
△ PB523(5.593\180°\0.635)	■ PB524(5.593\190°\0.735)	

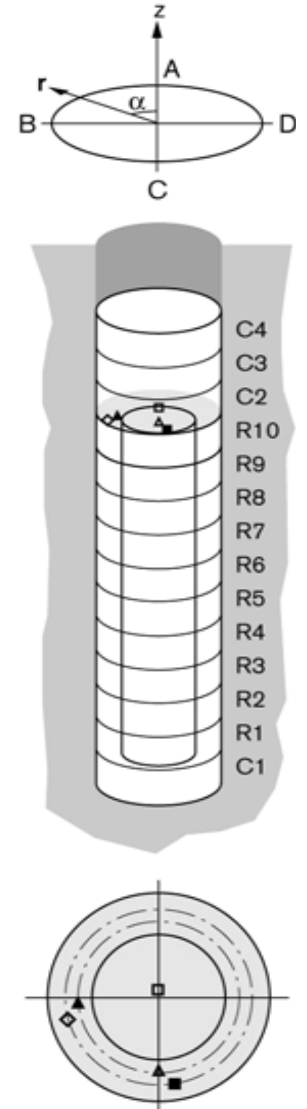

Prototype\Hole 5\Cyl.3 and Cyl.4 (041015-041201)
 Total pressure - Geokon

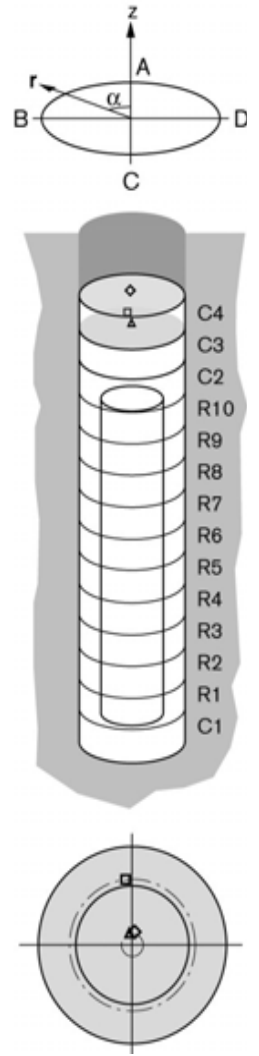
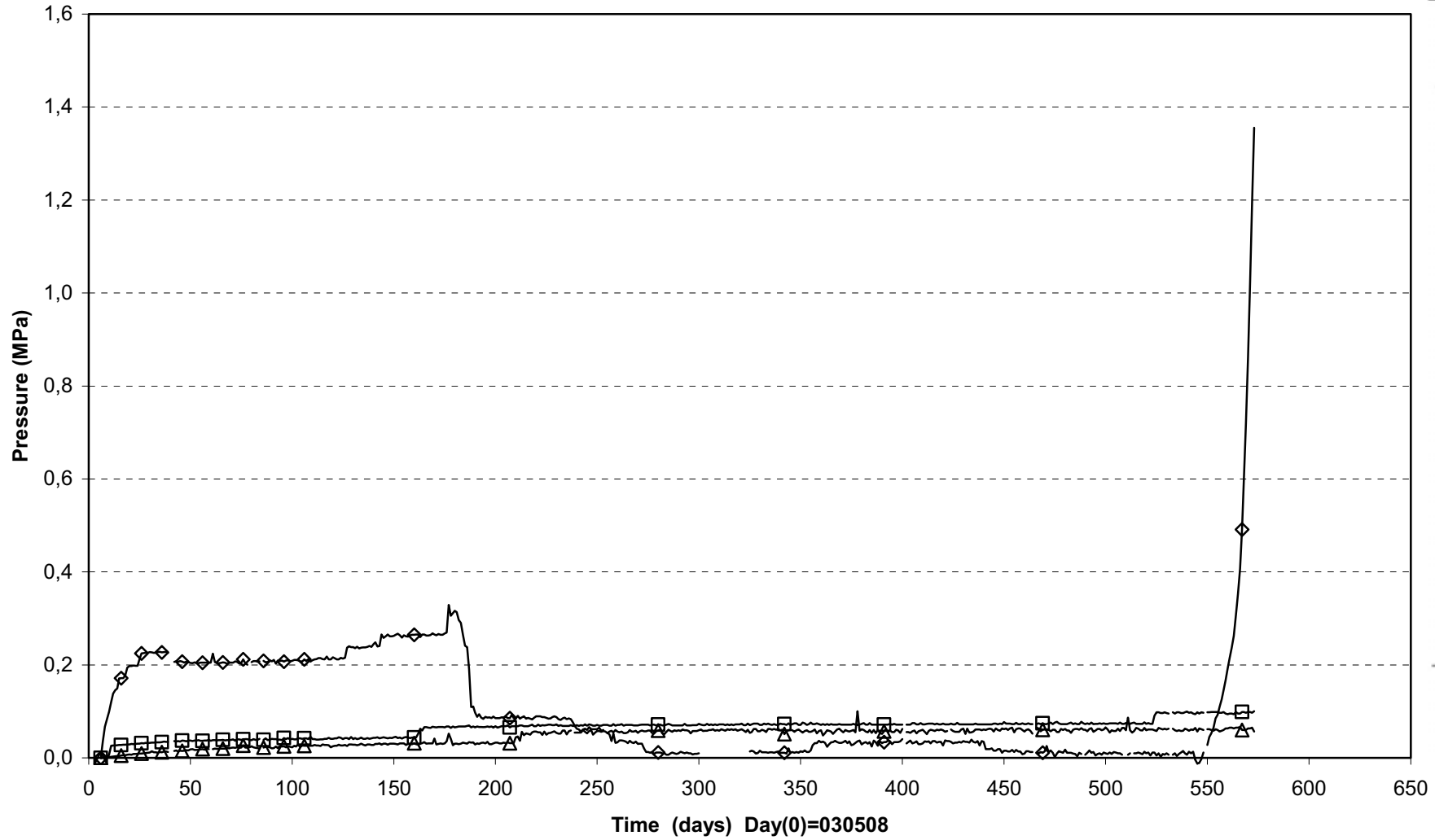

△ PB525(6.603\0°\0.100)
□ PB526(6.603\5°\0.585)
◇ PB527(7.110\0°\0.100)

Prototype\ Hole 5 (030508-041201)
 Total pressure - Kulite

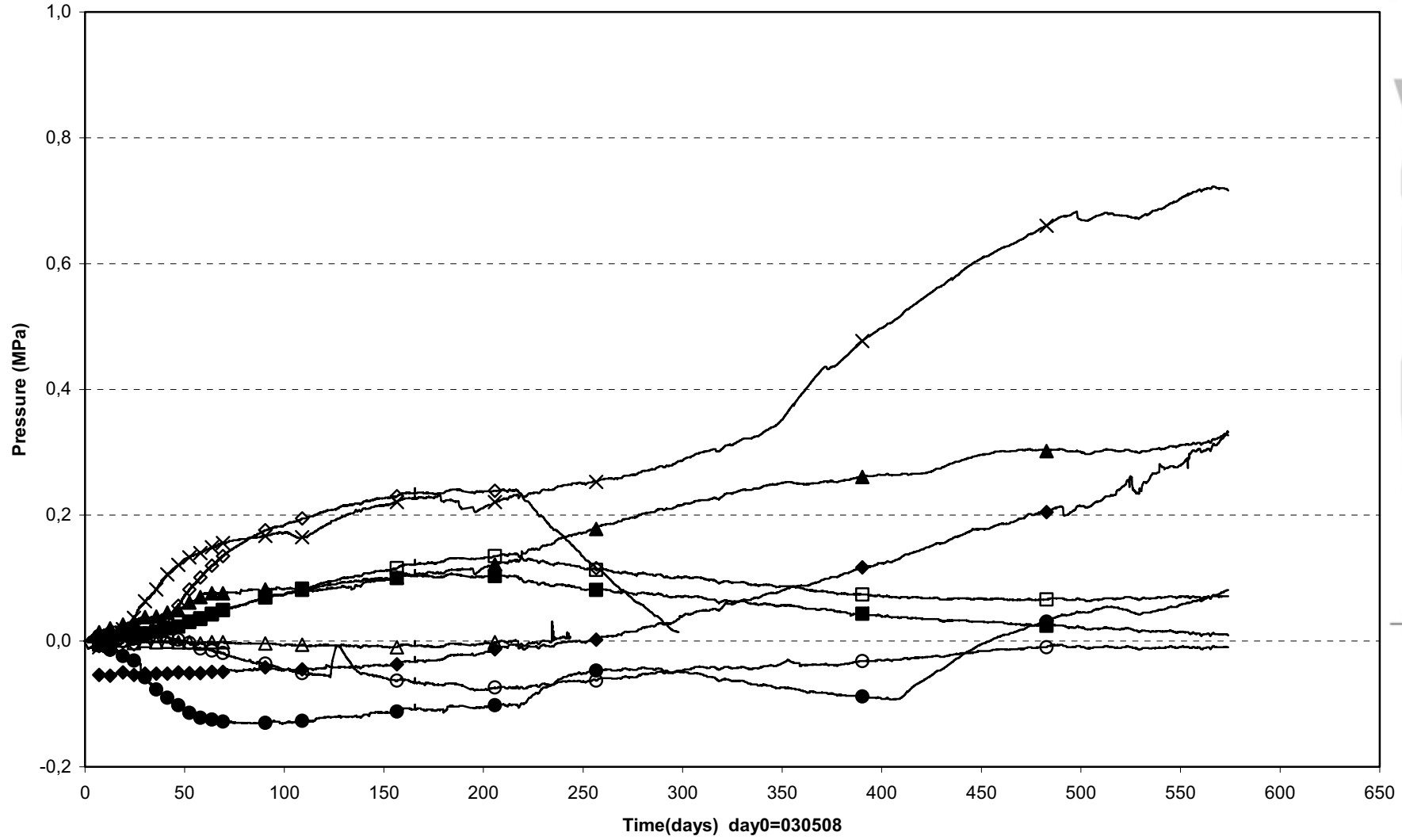

- | | | | | |
|-----------------------------|----------------------------|----------------------------|----------------------------|---------------------------|
| □ PB503(0.340 \5°\ 0.585) | ■ PB504(0.340 \5°\0.685) | ◇ PB505(0.340 \5°\ 0.785) | ◆ PB510(2.876 \10°\ 0.535) | △ PB512(2.876 \5°\ 0.825) |
| ▲ PB516(2.876 \190°\ 0.825) | ○ PB518(5.433 \10°\ 0.585) | ● PB519(5.433 \10°\ 0.685) | × | × |

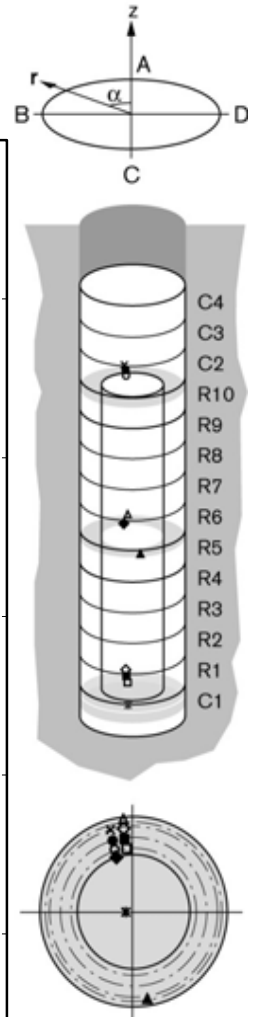

Prototype\Hole 5\Cyl.1 (030508-041201)
Relative humidity - Vaisala

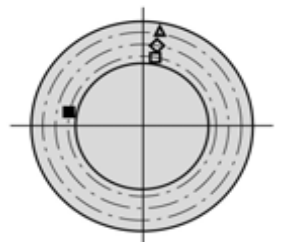
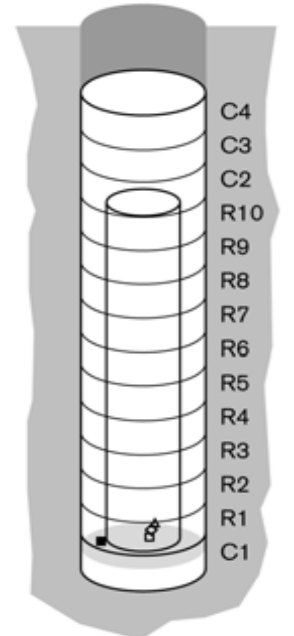
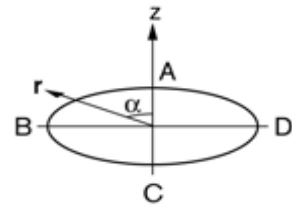
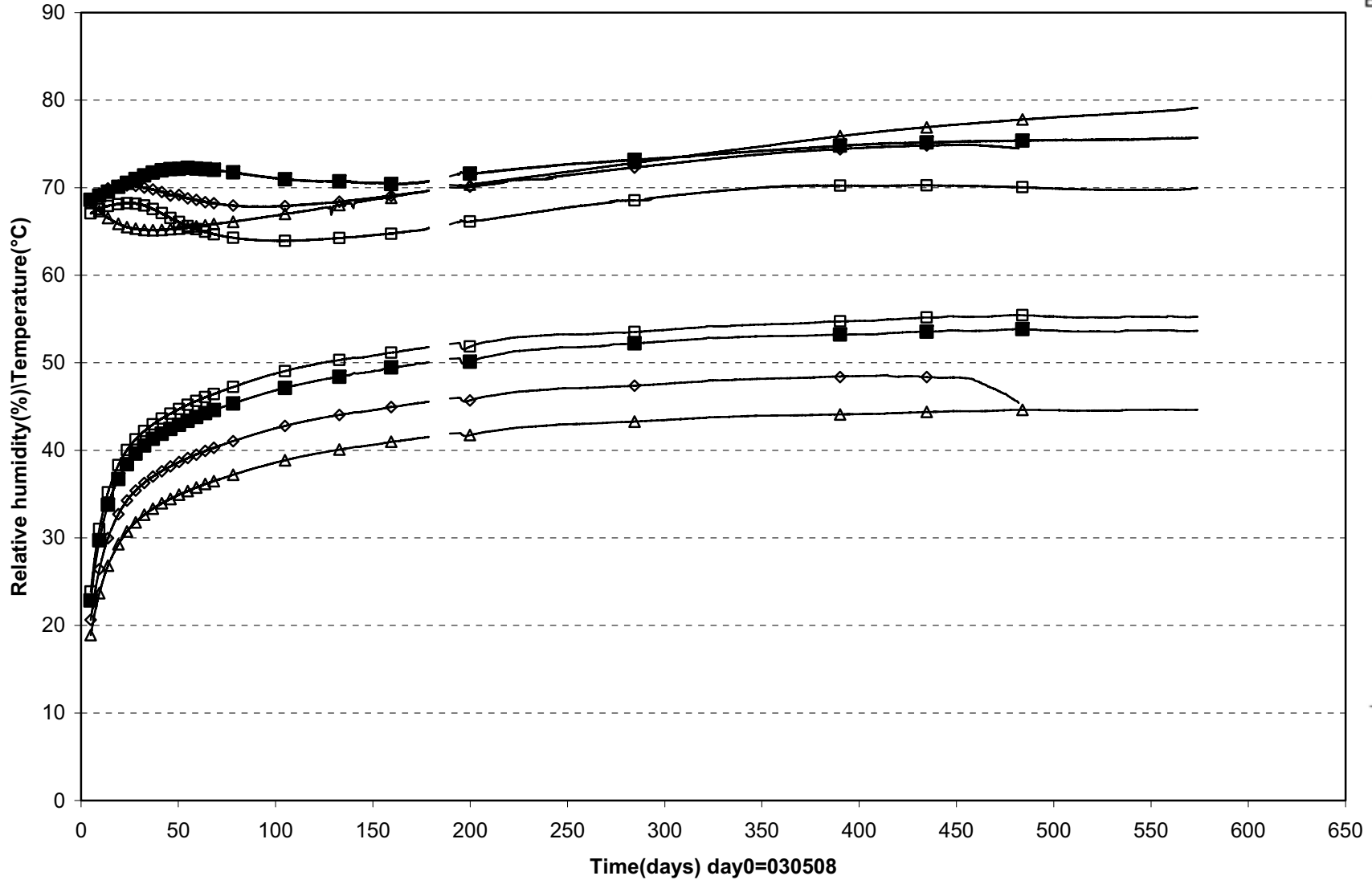

□ WB504(0.340\350°\0.585) ◇ WB505(0.340\350°\0.685) △ WB506(0.340\350°\0.785) ■ WB507(0.340\80°\0.585)

Prototype\Hole 5\Ring 5 (030508-041201)
Relative humidity - Vaisala

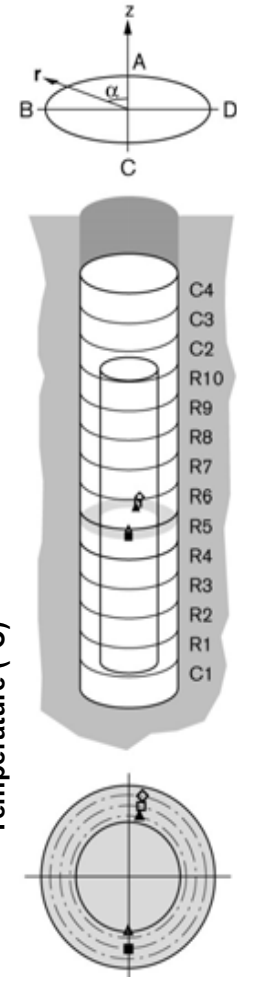
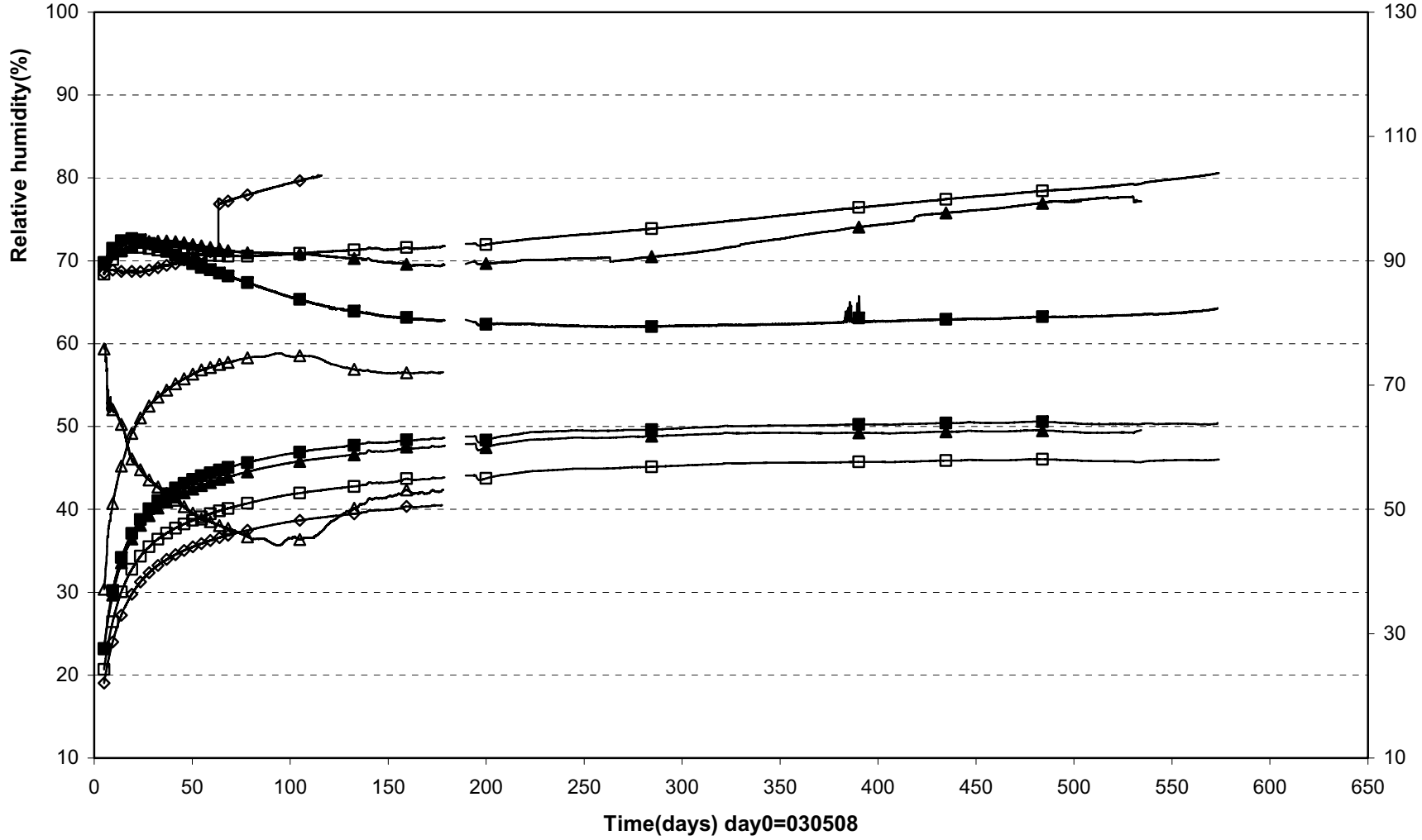

▲ WB513(2.876\350°\0.585) □ WB514(2.876\350°\0.685) ◇ WB515(2.876\350°\0.785) △ WB519(2.876\180°\0.535\In the slot) ■ WB520(2.876\180°\0.685)

Prototype\Hole 5\Ring 10 (030508-041201)
Relative humidity - Vaisala

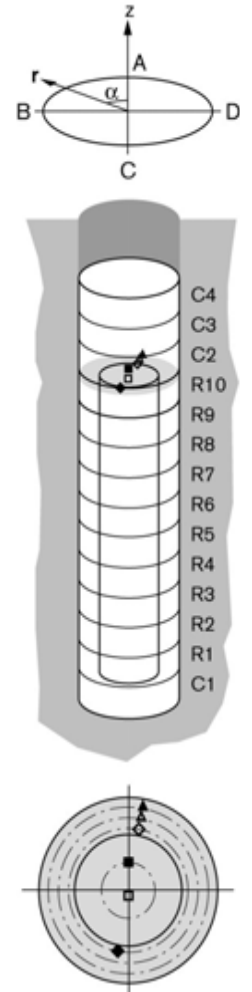
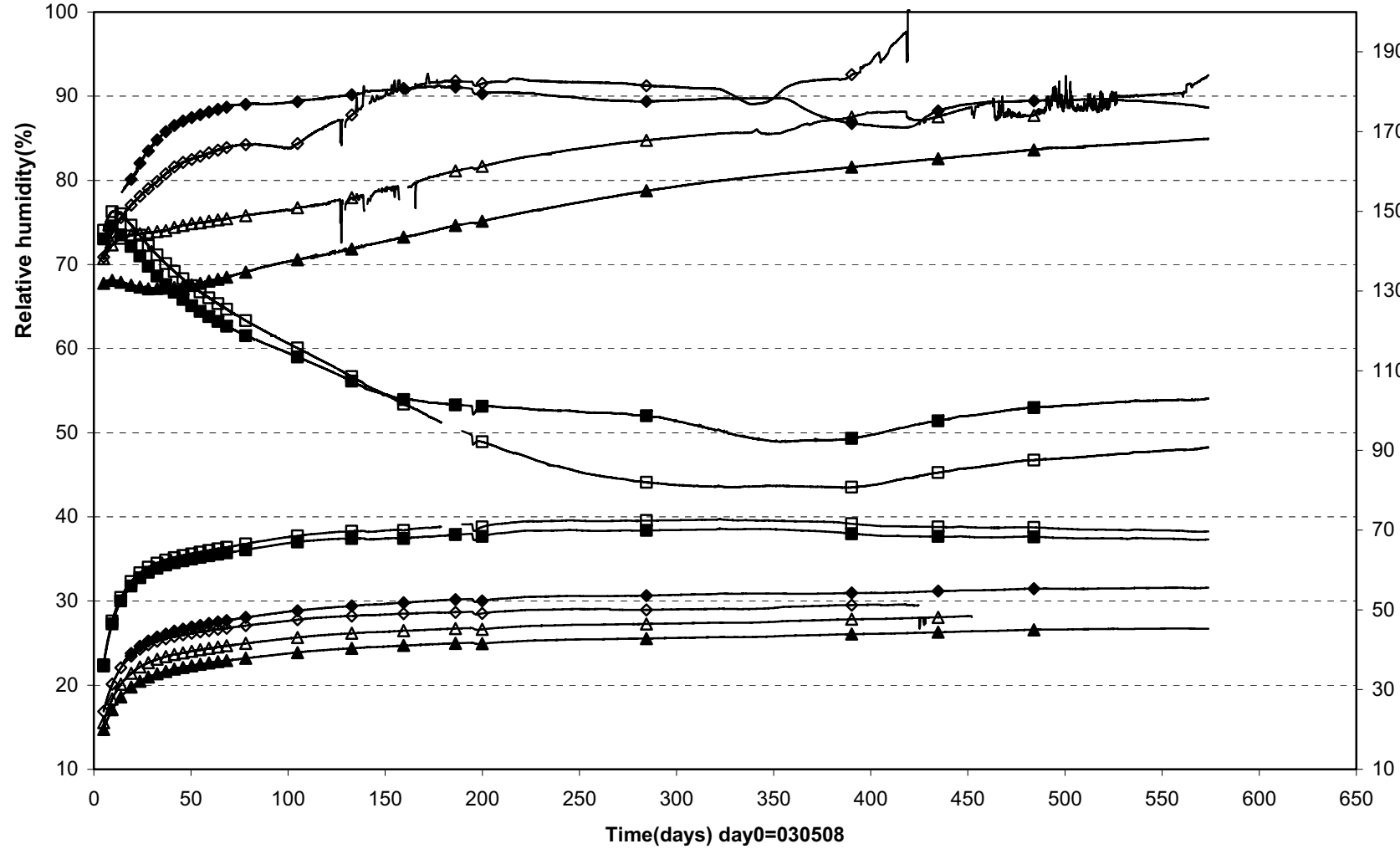

□ WB522(5.433\180°\0.050) ■ WB523(5.433\ 0° \0.262) ◇ WB524(5.433\350°\0.585) △ WB525(5.433\350°\0.685) ▲ WB526(5.433\350°\0.785) ◆ WB530(5.433\170°\0.585)

Prototype\Hole 5\Cyl.3 and Cyl.4 (030508-041201)
Relative humidity - Vaisala

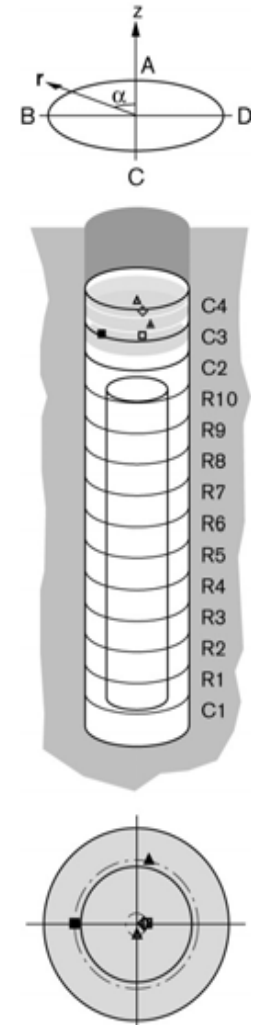
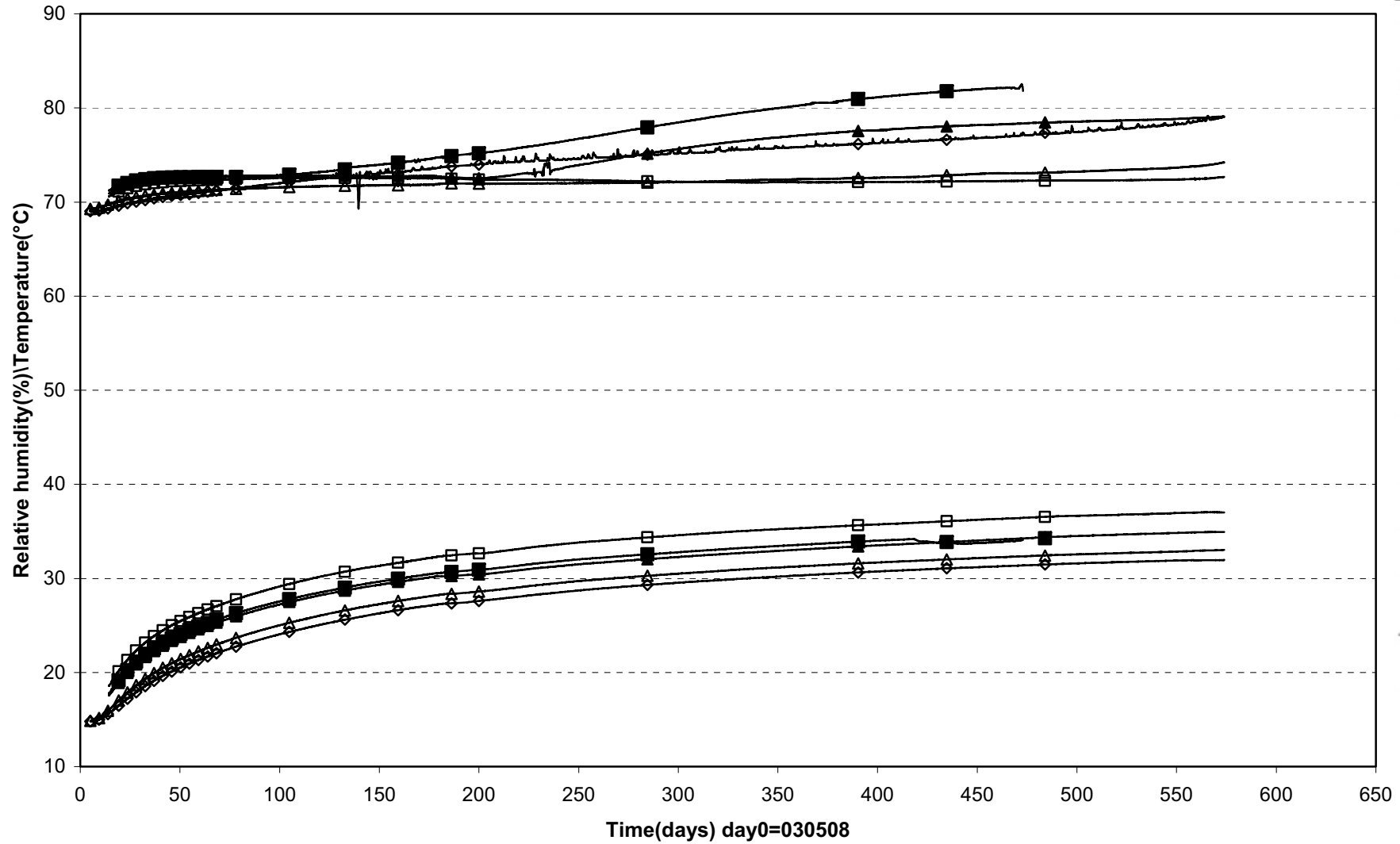

□ WB532(6.353\270°\0.100) ▲ WB533(6.353\350°\0.585) ■ WB534(6.353\90°\0.585) △ WB536(6.790\180°\0.100) ◇ WB537(6.950\270°\0.100)

Prototyp\Hole 5\Cyl.1 (030508-041201)
 Relative humidity - Rotronic

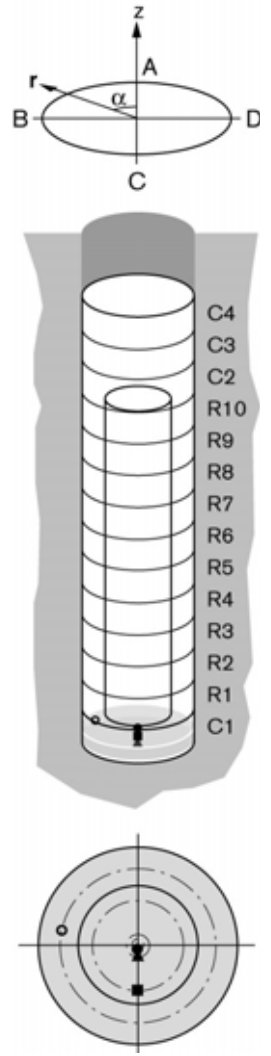
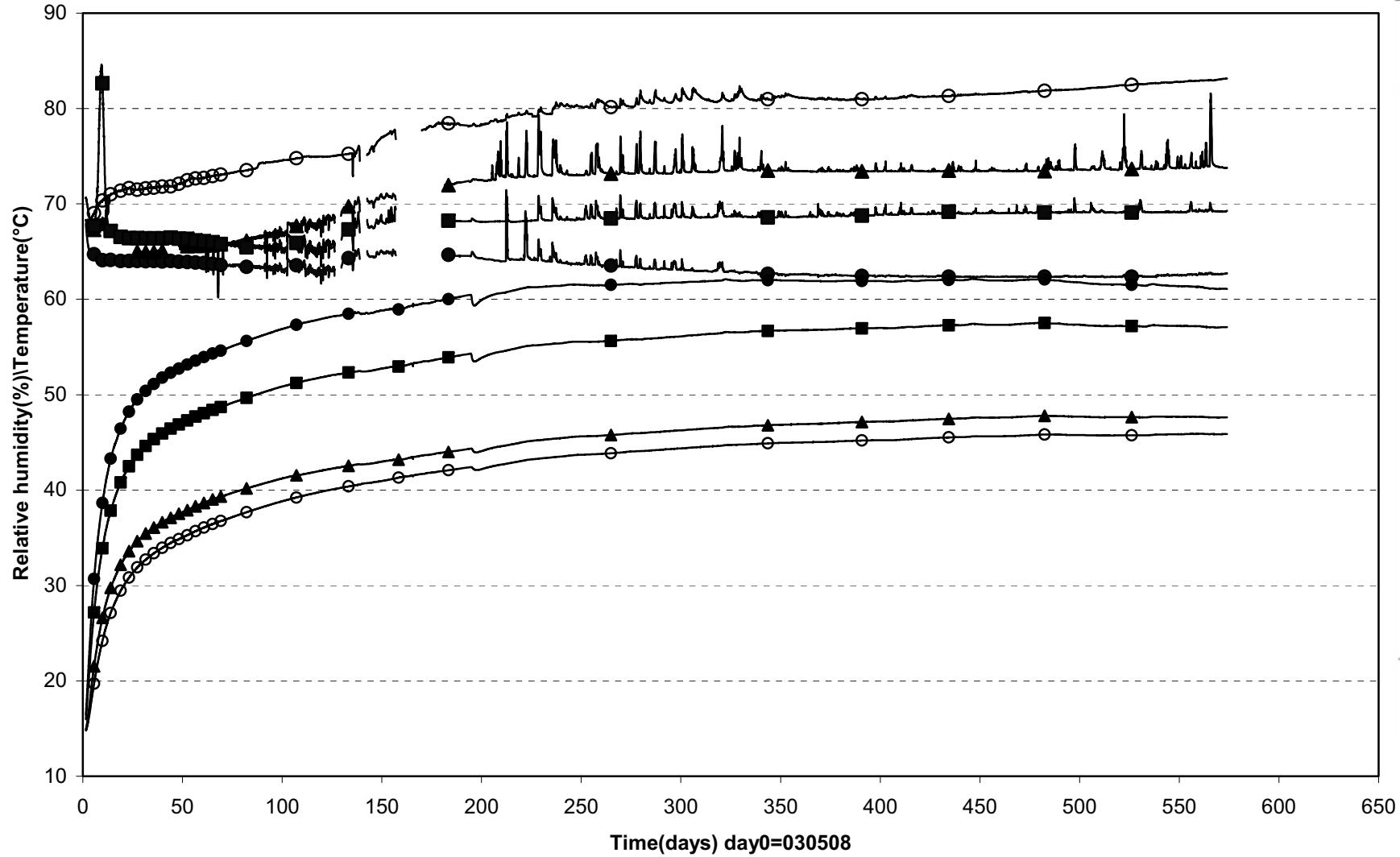

● WB501 (0.250\180°\0.050) ▲ WB502 (0.05\180°\0.100) ■ WB503 (0.250\180°\0.400) ○ WB508(0.250\80°\0.685)

Prototyp\Hole 5\Cyl.1 (030508-041201)
Relative humidity - Rotronic

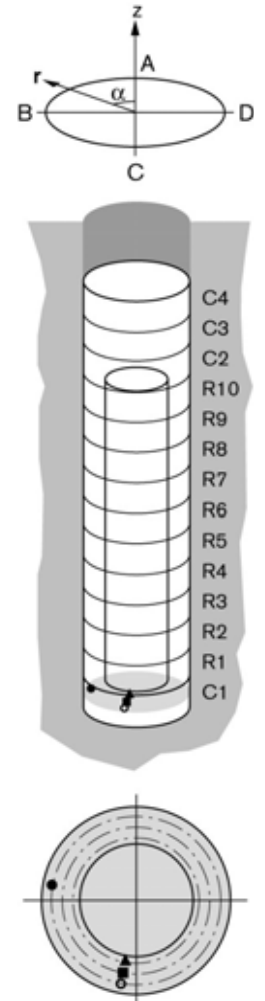
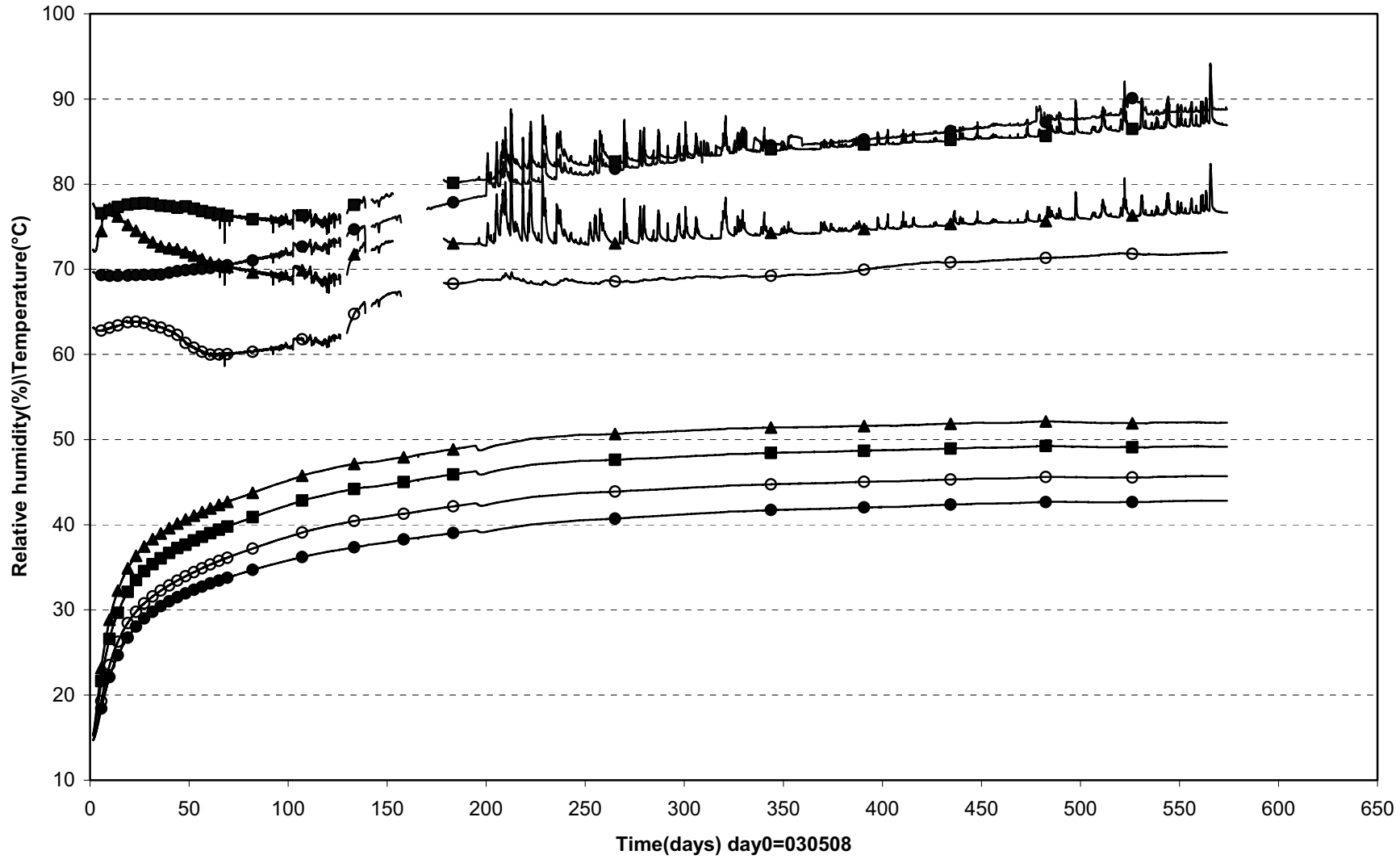

● WB509(0.250\80°\0.785) ▲ WB510(0.250\170°\0.585) ■ WB511(0.250\170°\0.685) ○ WB512(0.250\170°\0.785)

Prototyp\Hole 5\Ring5 (030508-041201)
Relative humidity - Rotronic

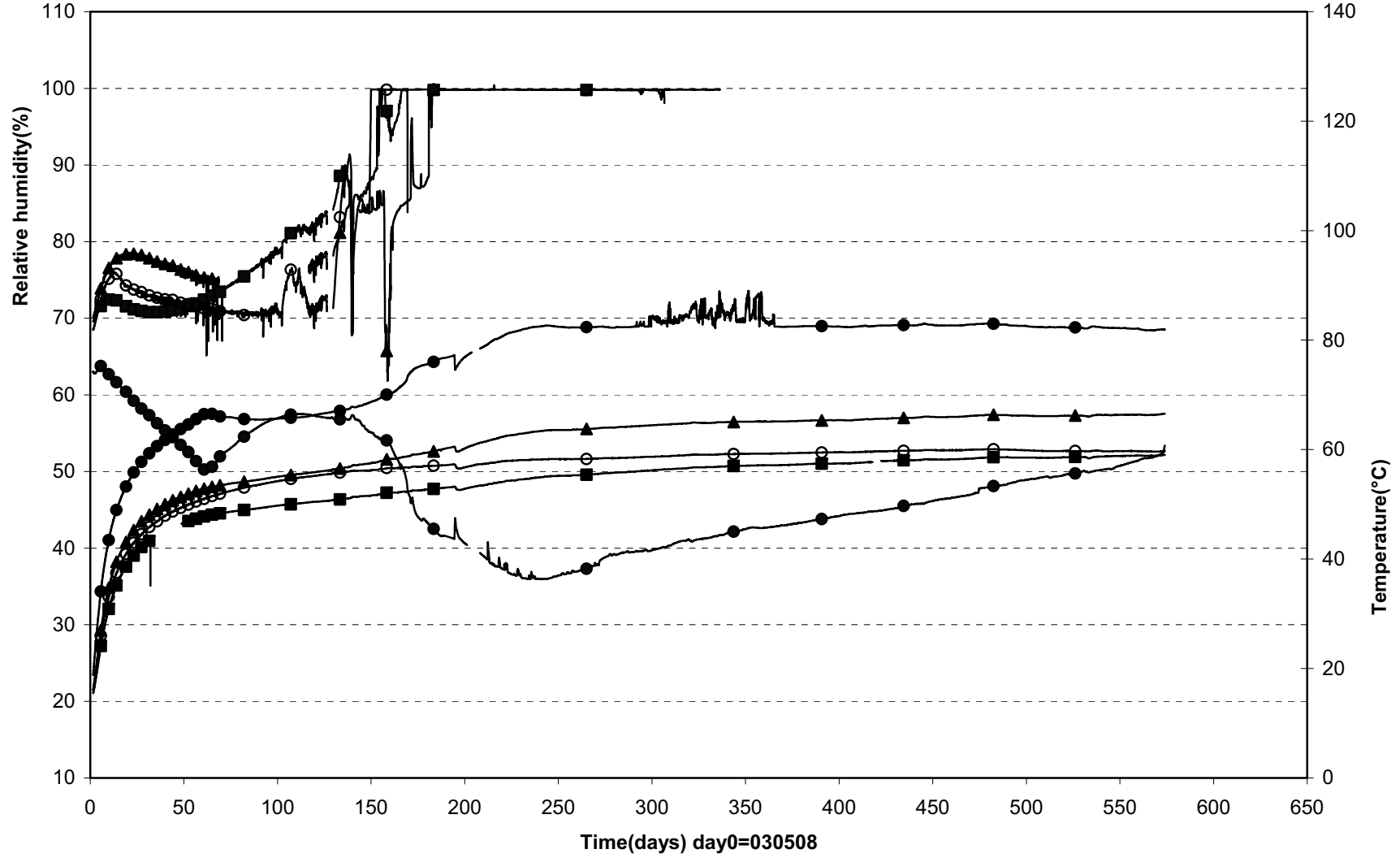

● WB516(2.786\80°\0.535) ▲ WB517(2.786\80°\0.685) ■ WB518(2.786\80°\0.785) ○ WB521(2.786\180°\0.785)

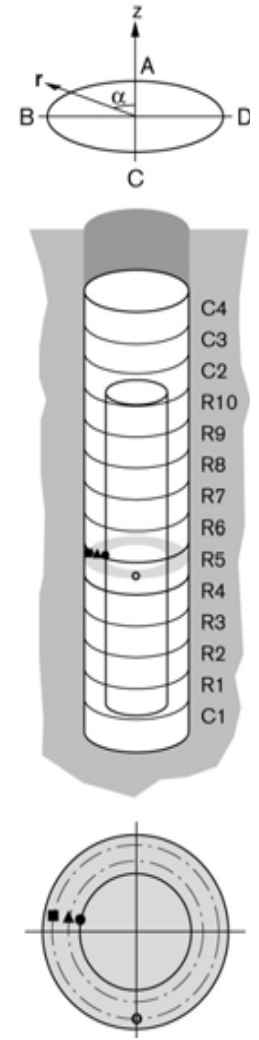

Prototyp\Hole 5\Ring10 (030508-041201)
 Relative humidity - Rotronic

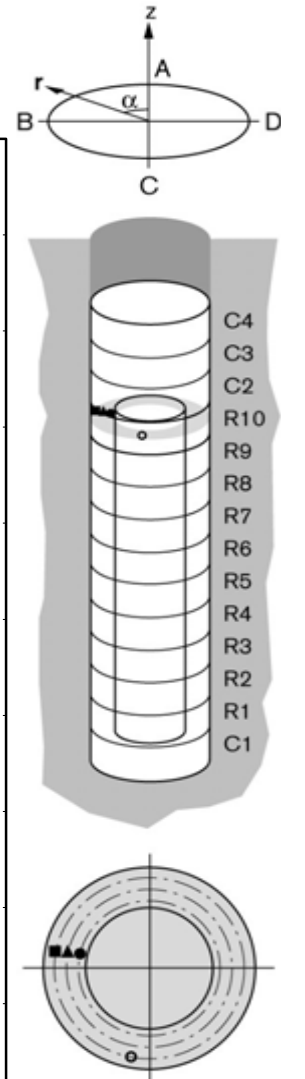
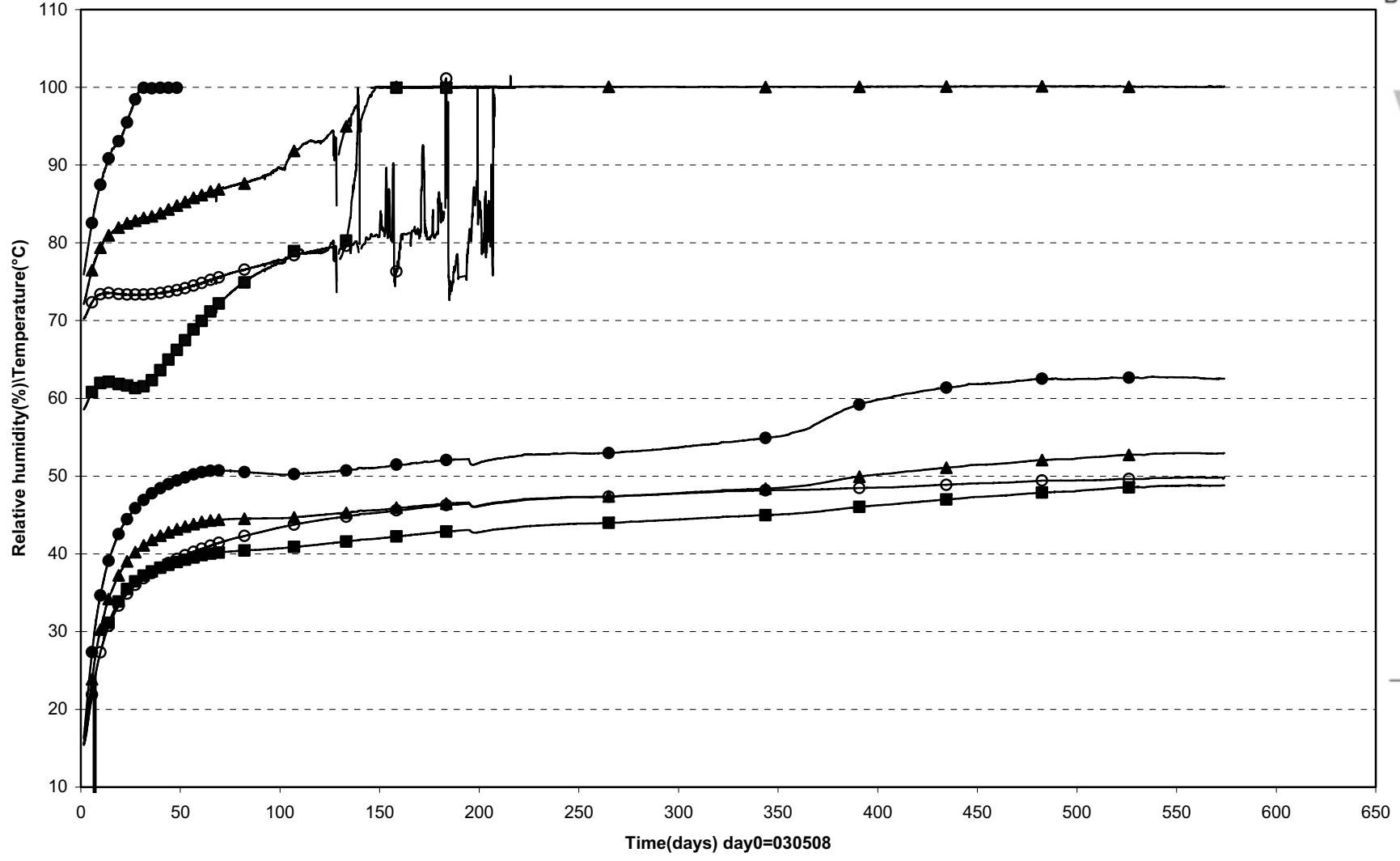

● WB527(5.343\80°\0.585) ▲ WB528(5.343\80°\0.685) ■ WB529(5.343\80°\0.785) ○ WB531(5.343\170°\0.785)

Prototyp\Hole 5\Cyl.3 (030508-041201)
 Relative humidity - Rotronic

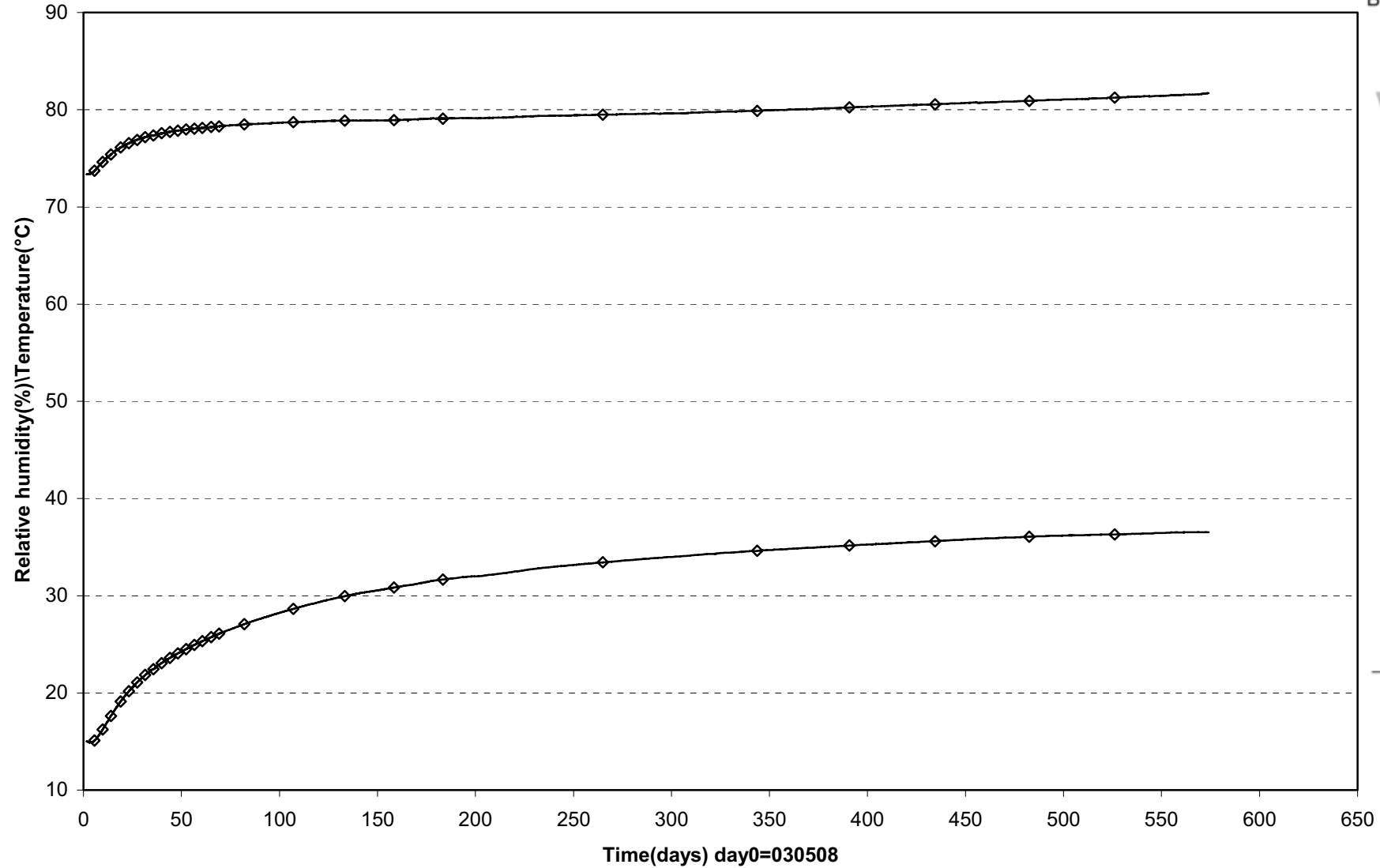

◇ WB535(6.353\180°\0.585)

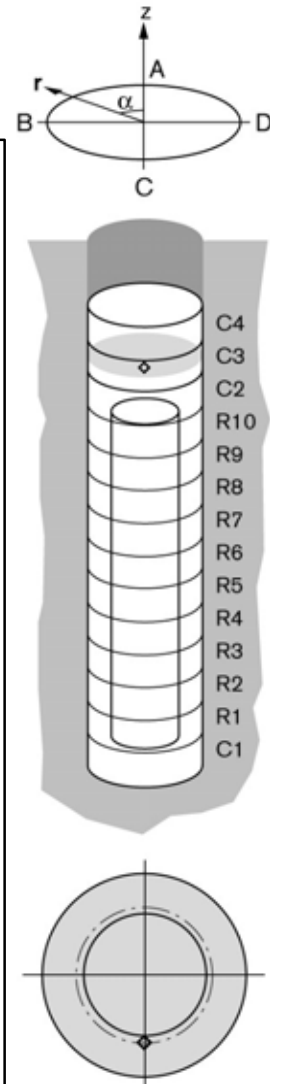

Prototype\ Hole 5 \ Ring 3 (030508-041201)
Suction - Wescor

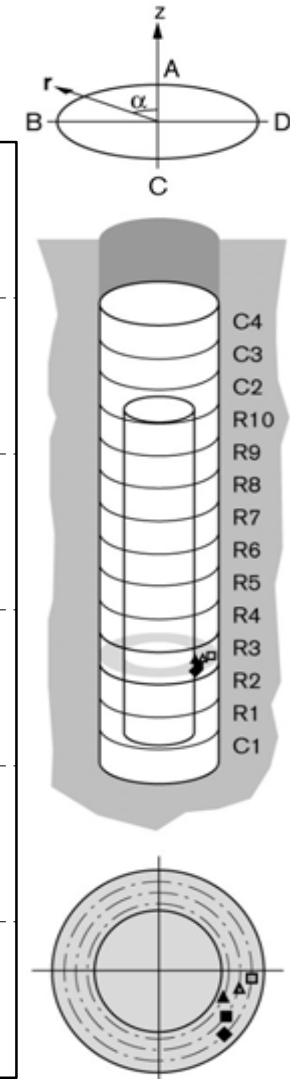
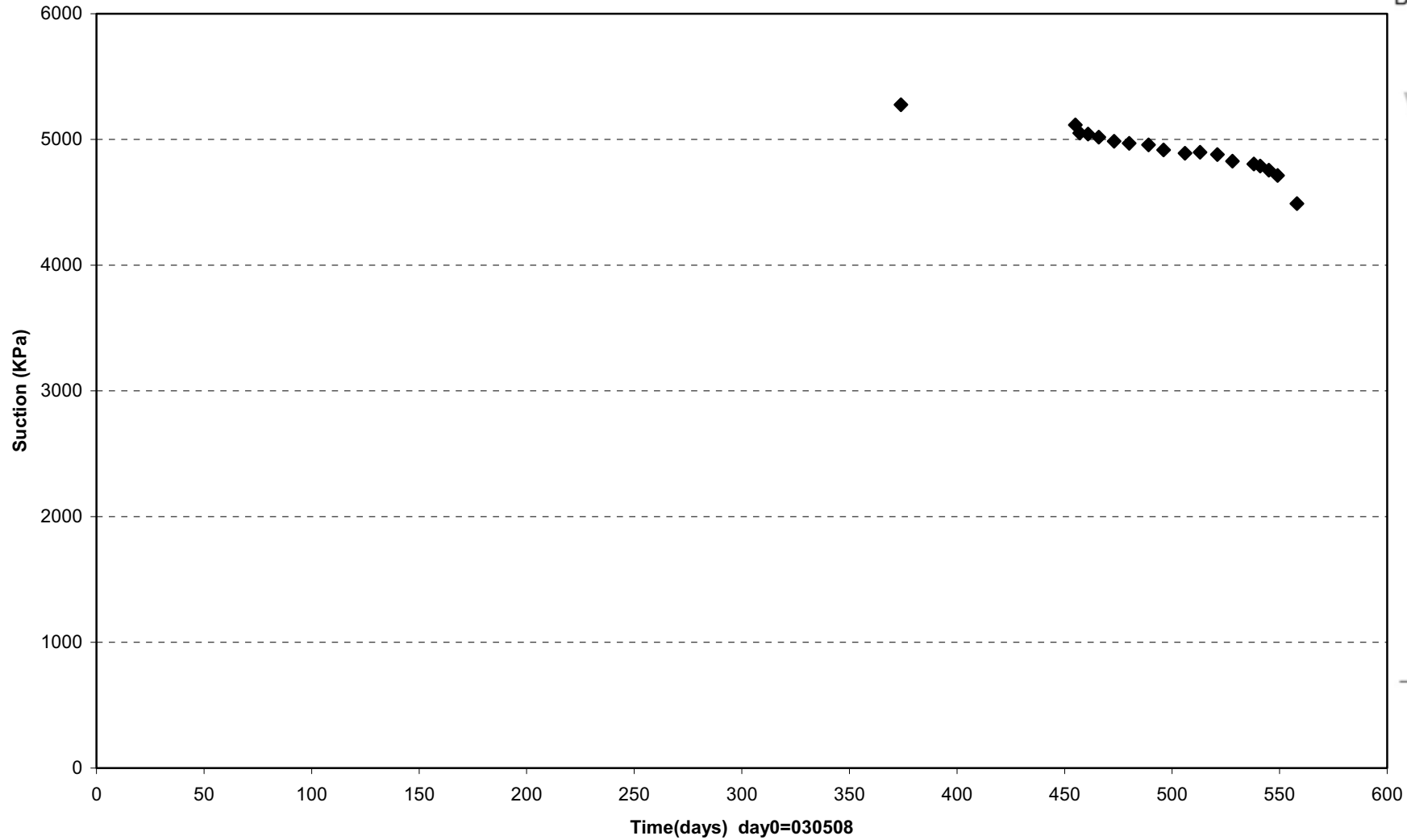

◆ WB538(1.624\225°\0.775) ■ WB539(1.624\235°\0.680) ▲ WB540(1.624\245°\0.585) △ WB541(1.624\255°\0.680) □ WB542(1.624\265°\0.775)

Prototype\Hole5 (041015-041201)
Pore pressure - Geokon

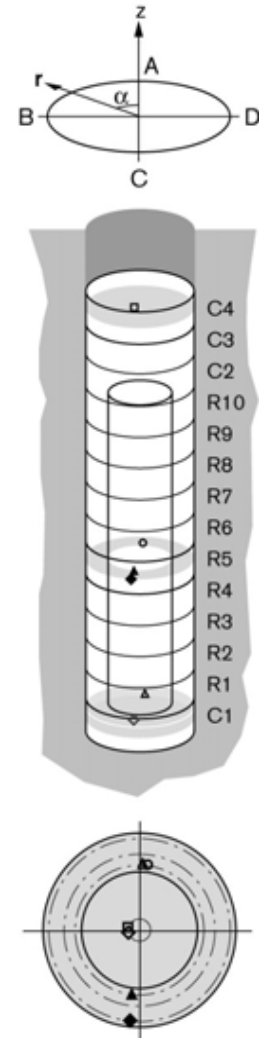
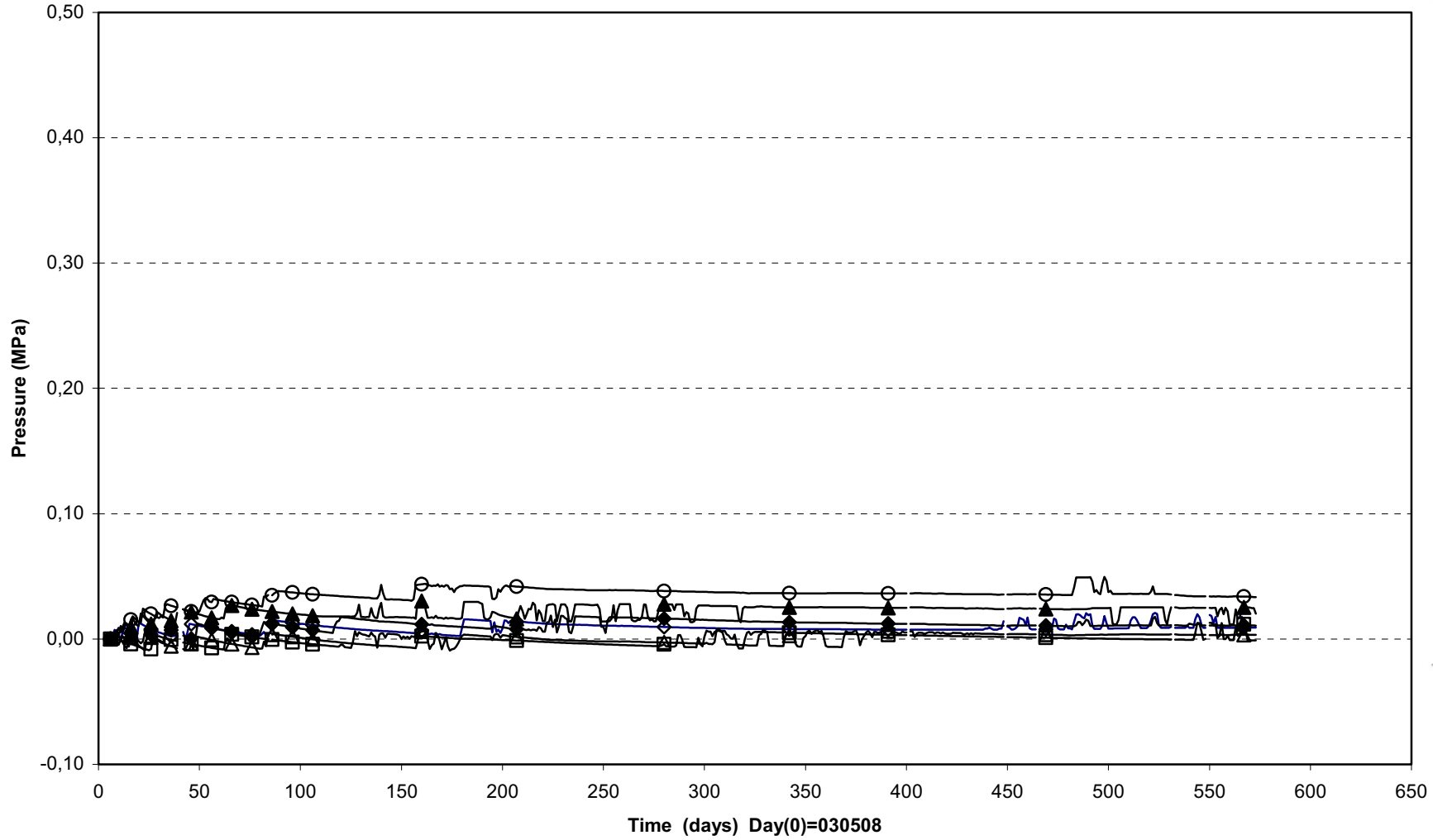

◇ UB502(0.050\90°\0.100)	△ UB503(0.250\355°\0.585)	○ UB505(2.786\355°\0.585)
▲ UB509(2.786\175°\0.535)	◆ UB510(2.786\175°\0.825)	□ UB514(6.860\90°\0.100)

Prototype\ Hole 5 (030508-041201)
Pore pressure - Kulite

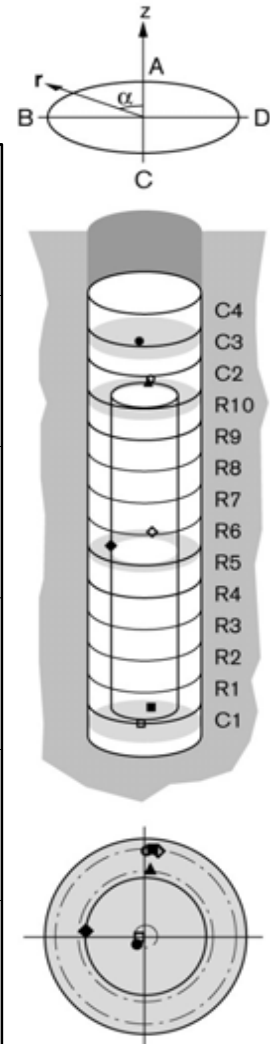
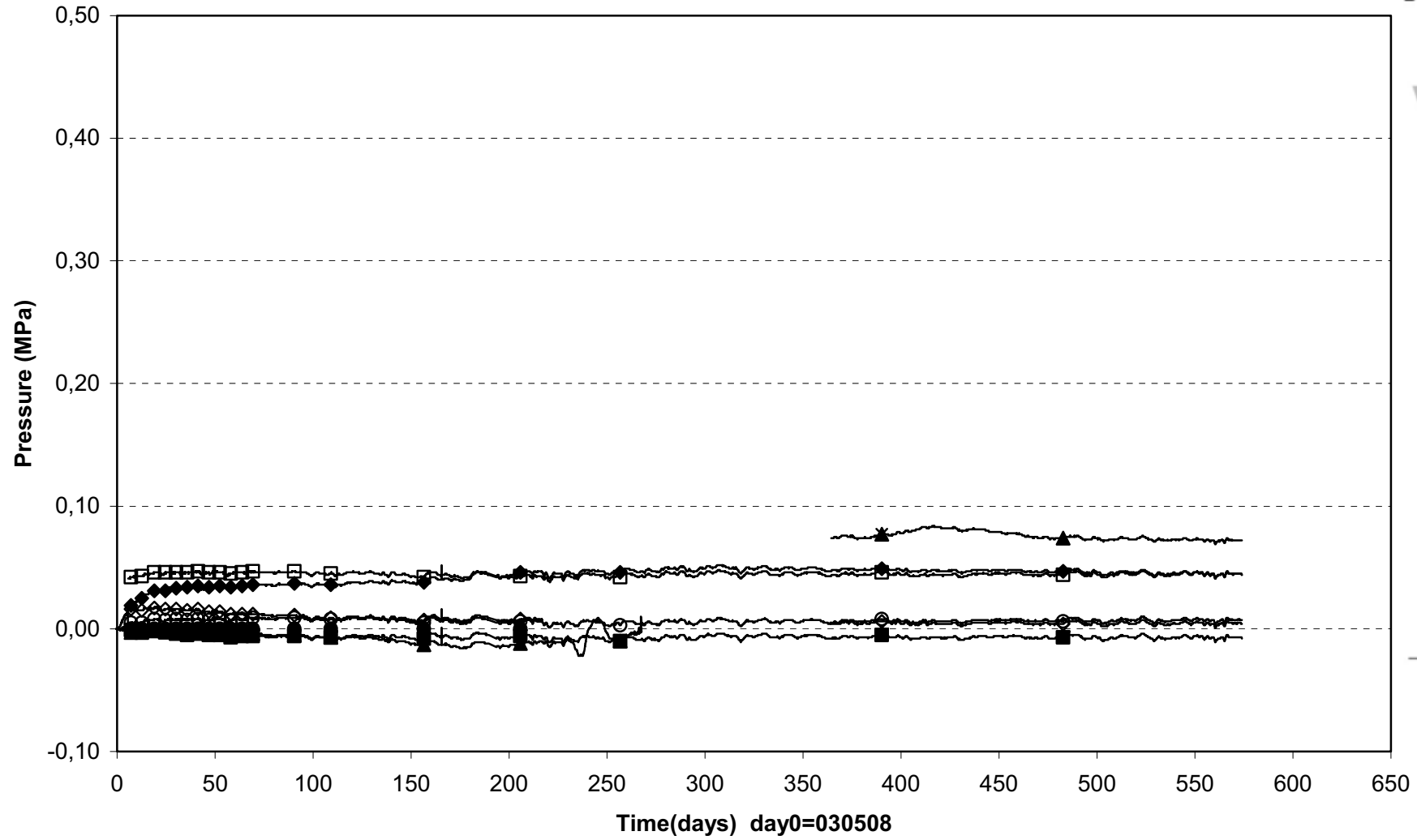

Prototype\Hole 5\Cyl.1 (030508-041201)
 Temperature - Pentronic

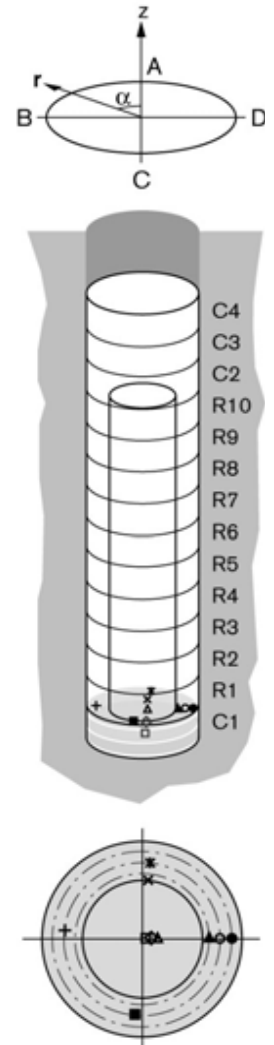
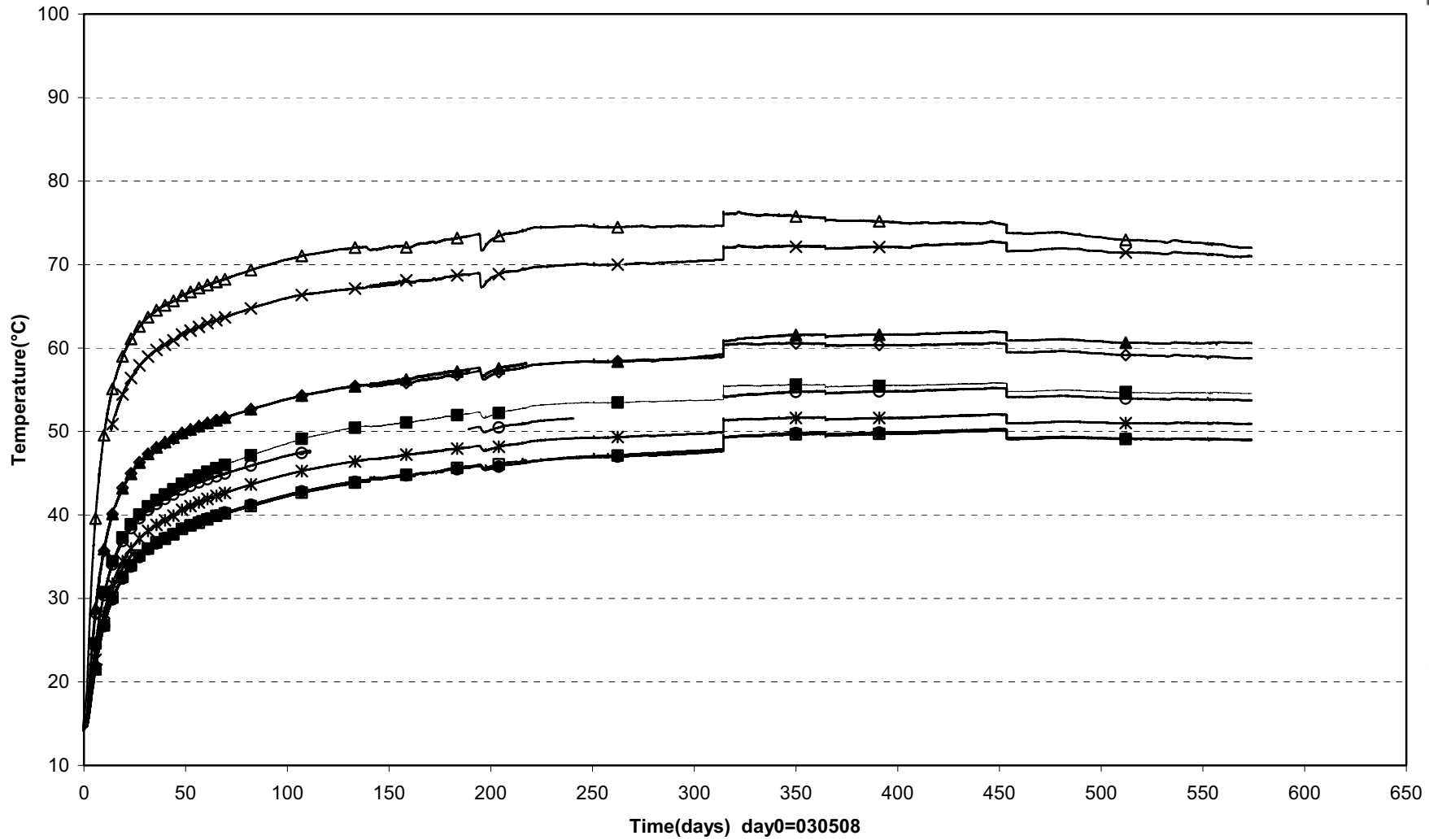

□ TB501(0.080\270°\0.050) ◇ TB502(0.250\270°\0.060) △ TB503(0.450\270°\0.070) × TB504(0.450\355°\0.525) ✖ TB505(0.450\355°\0.685)
 + TB506(0.450\85°\0.685) ■ TB507(0.450\175°\0.685) ▲ TB508(0.450\270°\0.585) ○ TB509(0.450\270°\0.685) ● TB510(0.450\270°\0.785)

Prototype\Hole 5 \Ring5 (030508-041201)
 Temperature - Pentronic

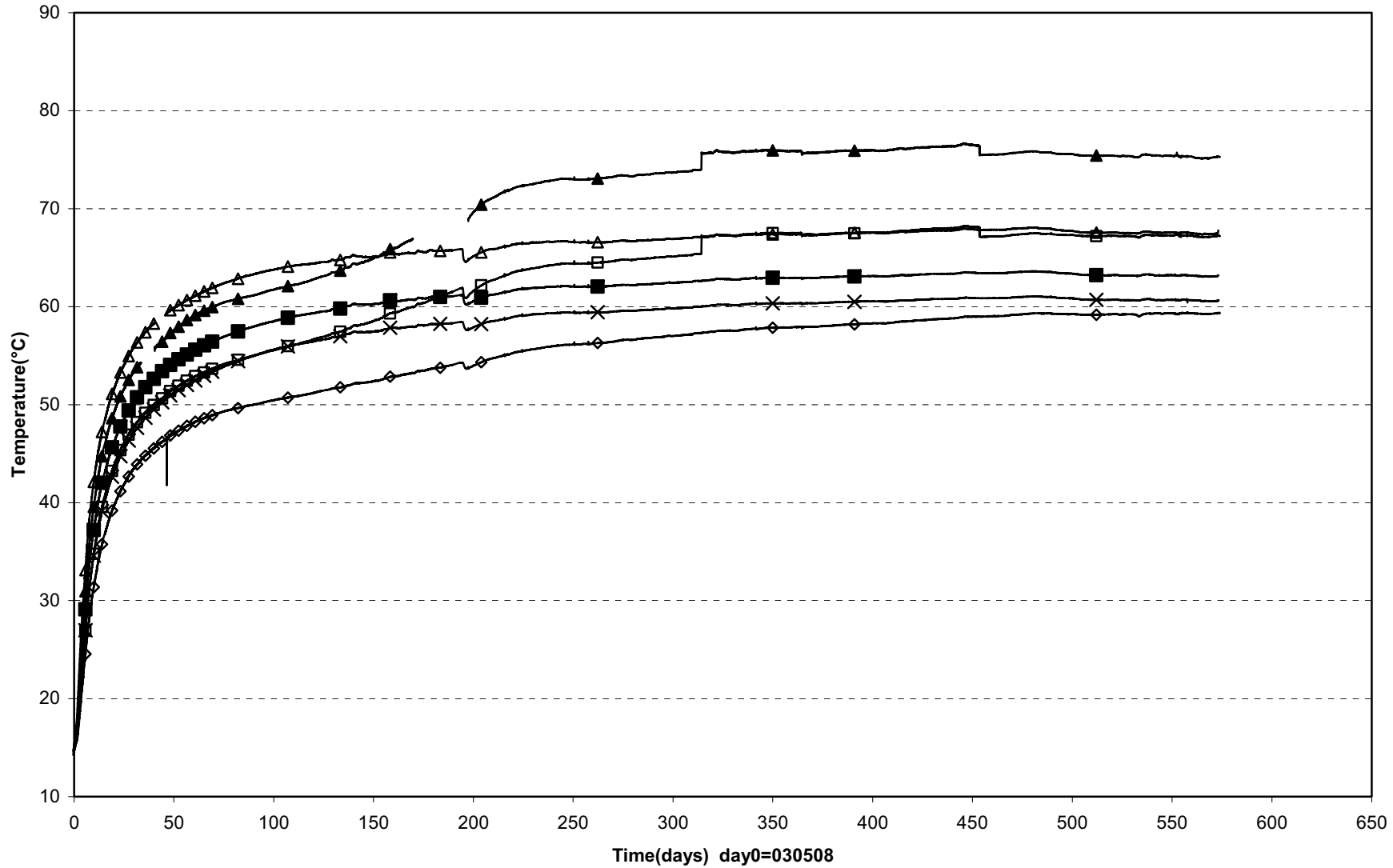

▲ TB513(2.986\85°\0.585)	□ TB514(2.986\85°\0.685)	◇ TB515(2.986\85°\0.785)
△ TB516(2.986\175°\0.585)	■ TB517(2.986\175°\0.685)	× TB518(2.986\175°\0.735)

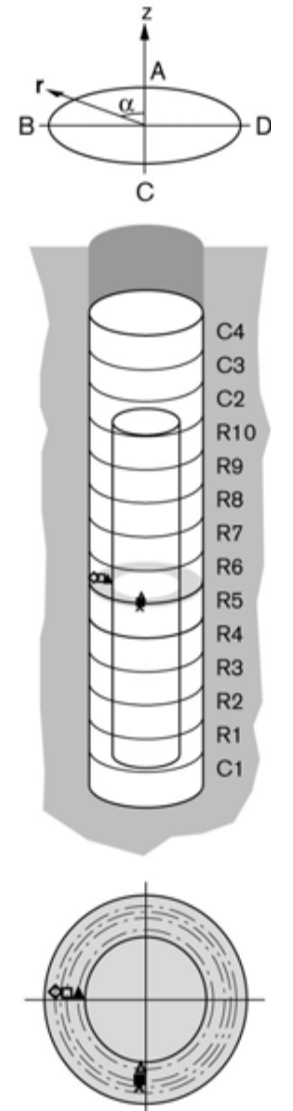

Prototype\Hole 5 \Ring5 (030508-041201)
 Temperature - Pentronic

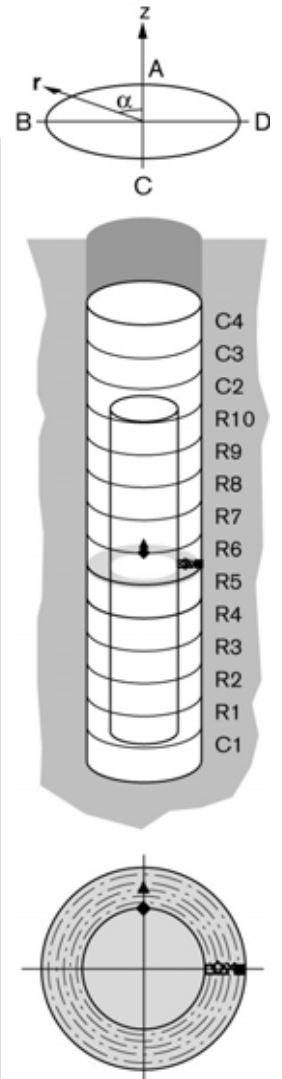
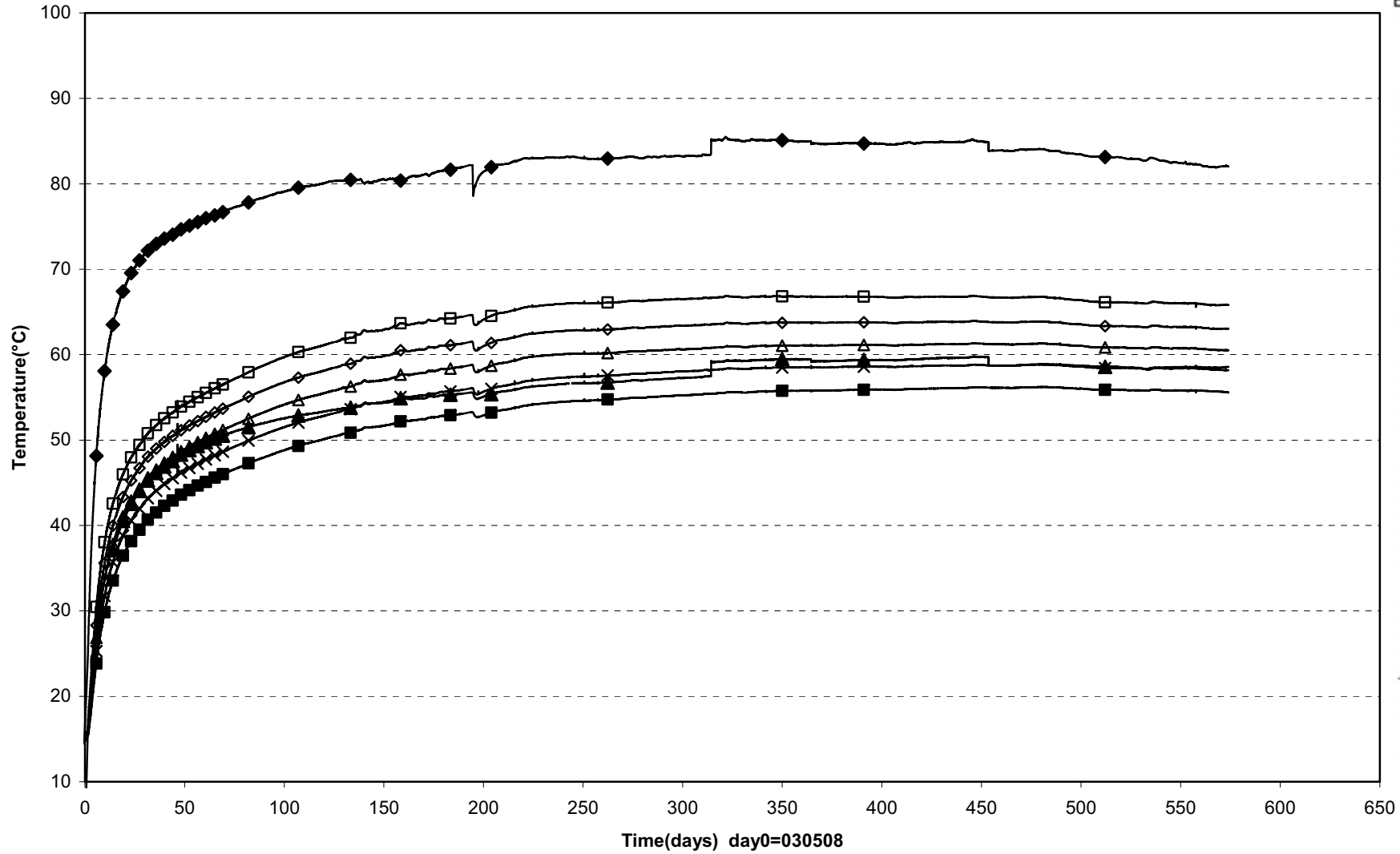

□ TB519(2.986\270°\0.585) ◇ TB520(2.986\270°\0.635) △ TB521(2.986\270°\0.685) × TB522(2.986\270°\0.735) ■ TB523(2.986\270°\0.785)
 ◆ TB511(2.950\0°\0.525) ▲ TB512(2.986\0°\0.685)

Prototype\Hole 5 \Ring10 (030508-041201)
 Temperature - Pentronic

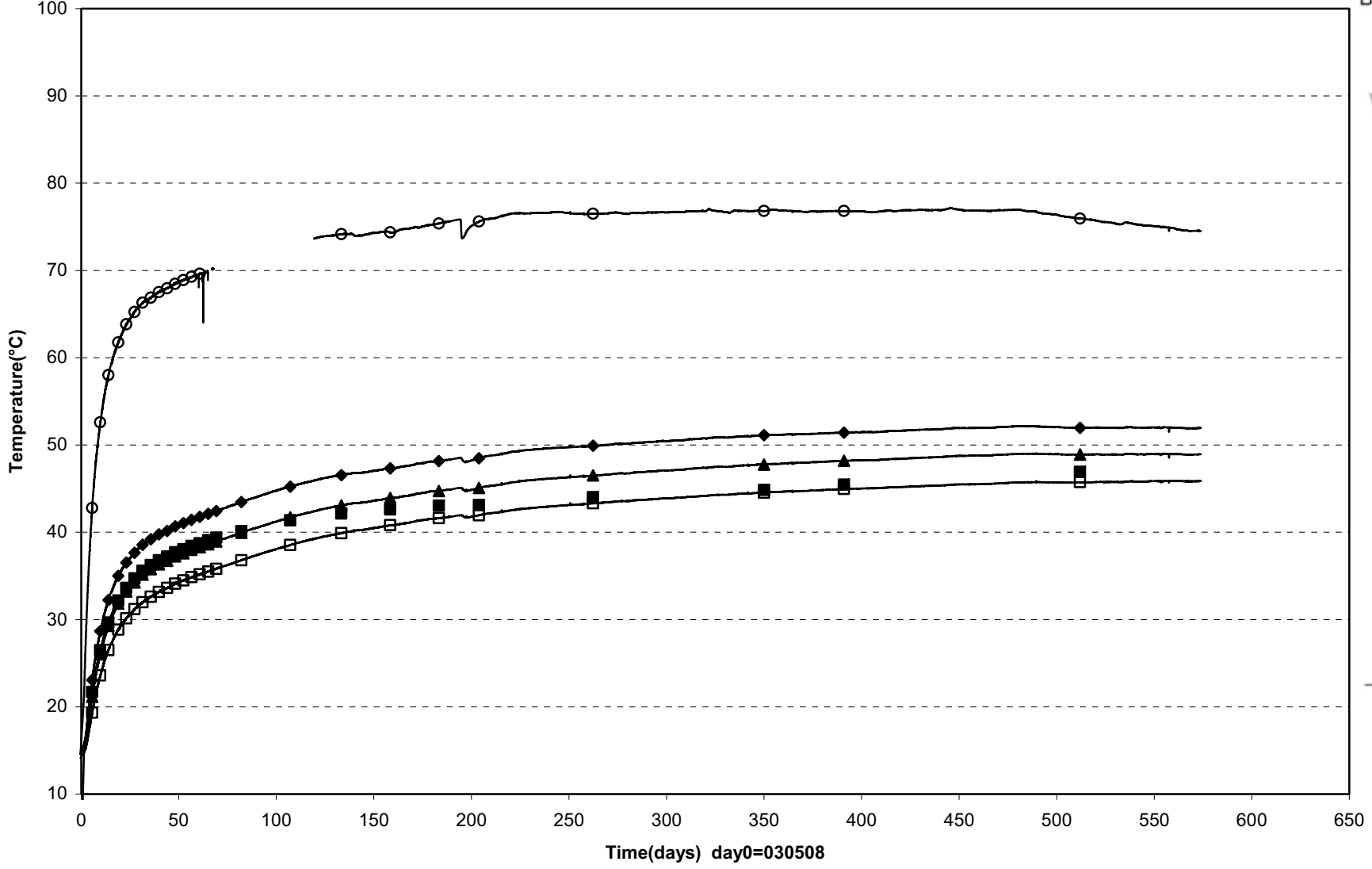

○ TB524(5.150\ 0°\0.525) ■ TB525(5.543\ 0°\0.685) ◆ TB526(5.543\ 270°\0.585) ▲ TB527(5.543\ 270°\0.685) □ TB528(5.543\ 270°\0.785)

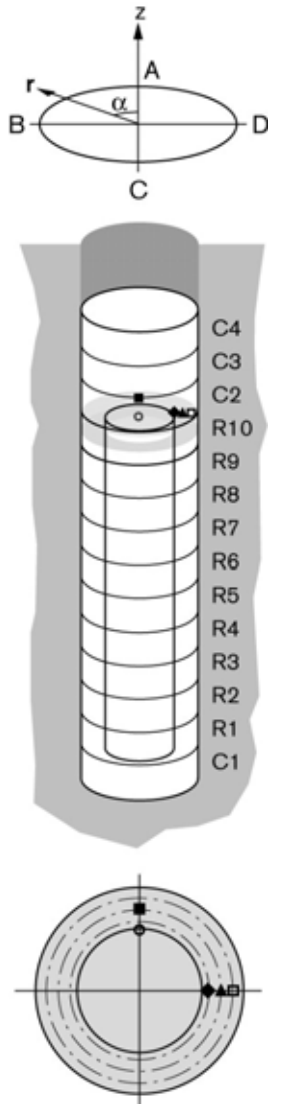

Prototype\Hole 5 \Cyl.3 and Cyl.4 (030508-041201)
 Temperature - Pentronic

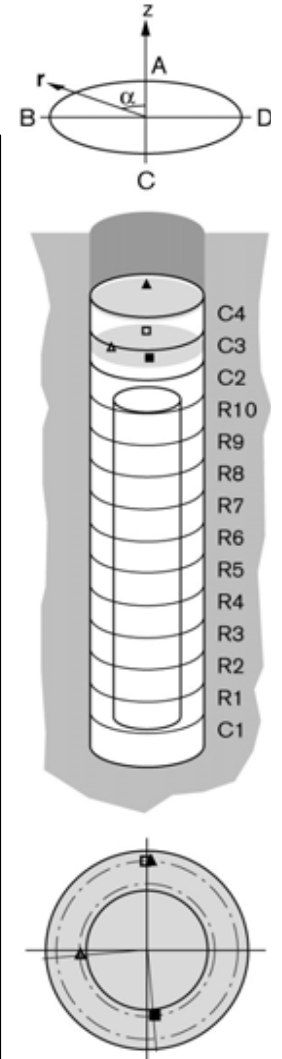
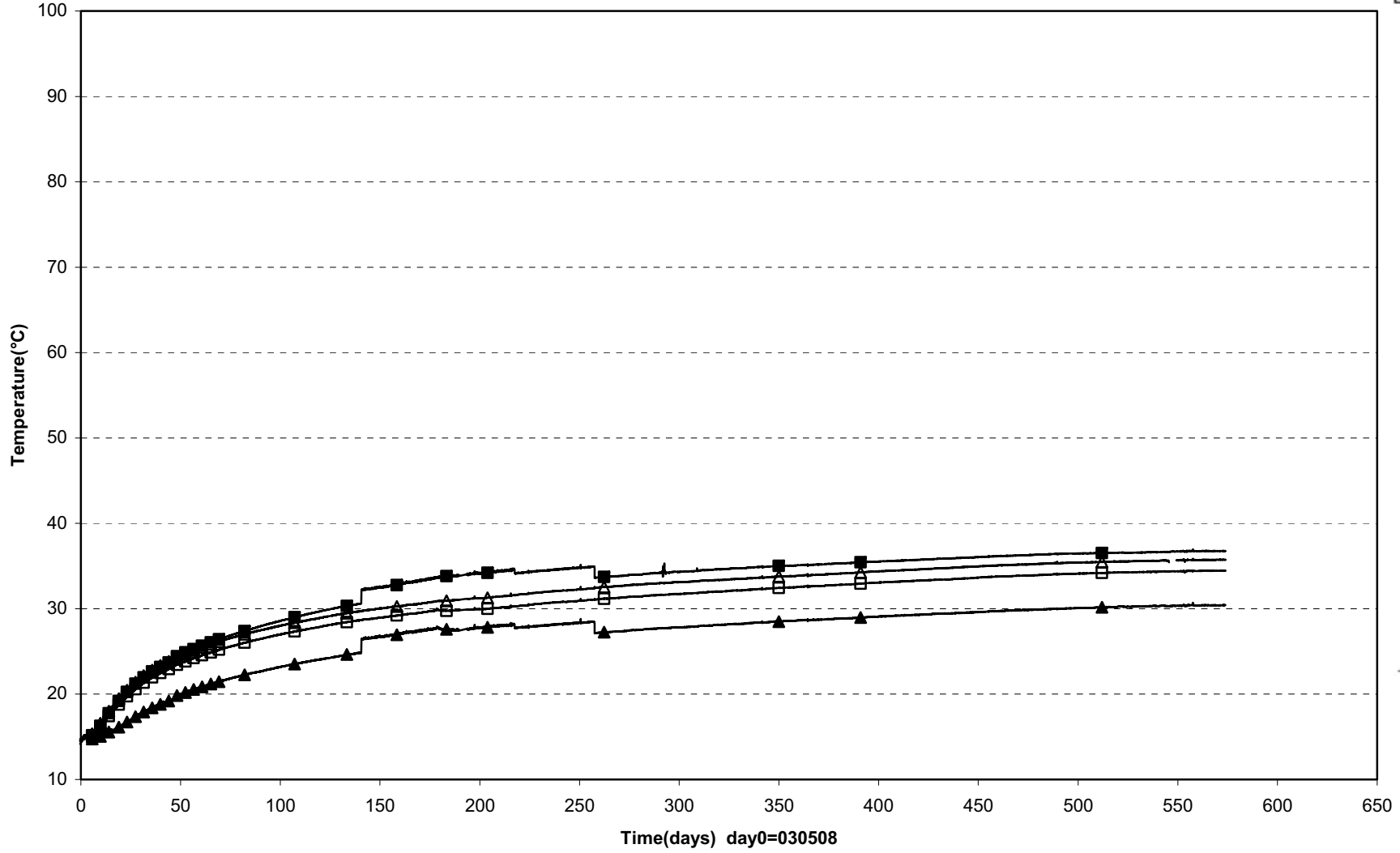

□ TB529(6.353\ 0°\0.785) △ TB530(6.353\ 95°\0.585) ■ TB531(6.353\ 185°\0.585) ▲ TB532(7.060\ 0°\0.785)

Prototype\Hole 5\Cyl.1 (030508-041201)
 Temperature - Geokon

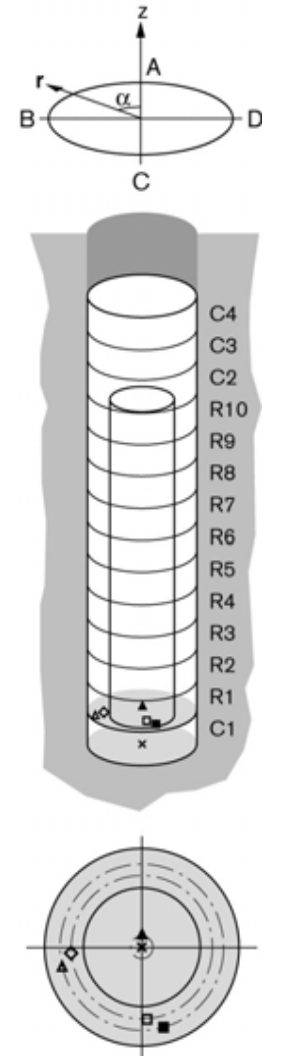
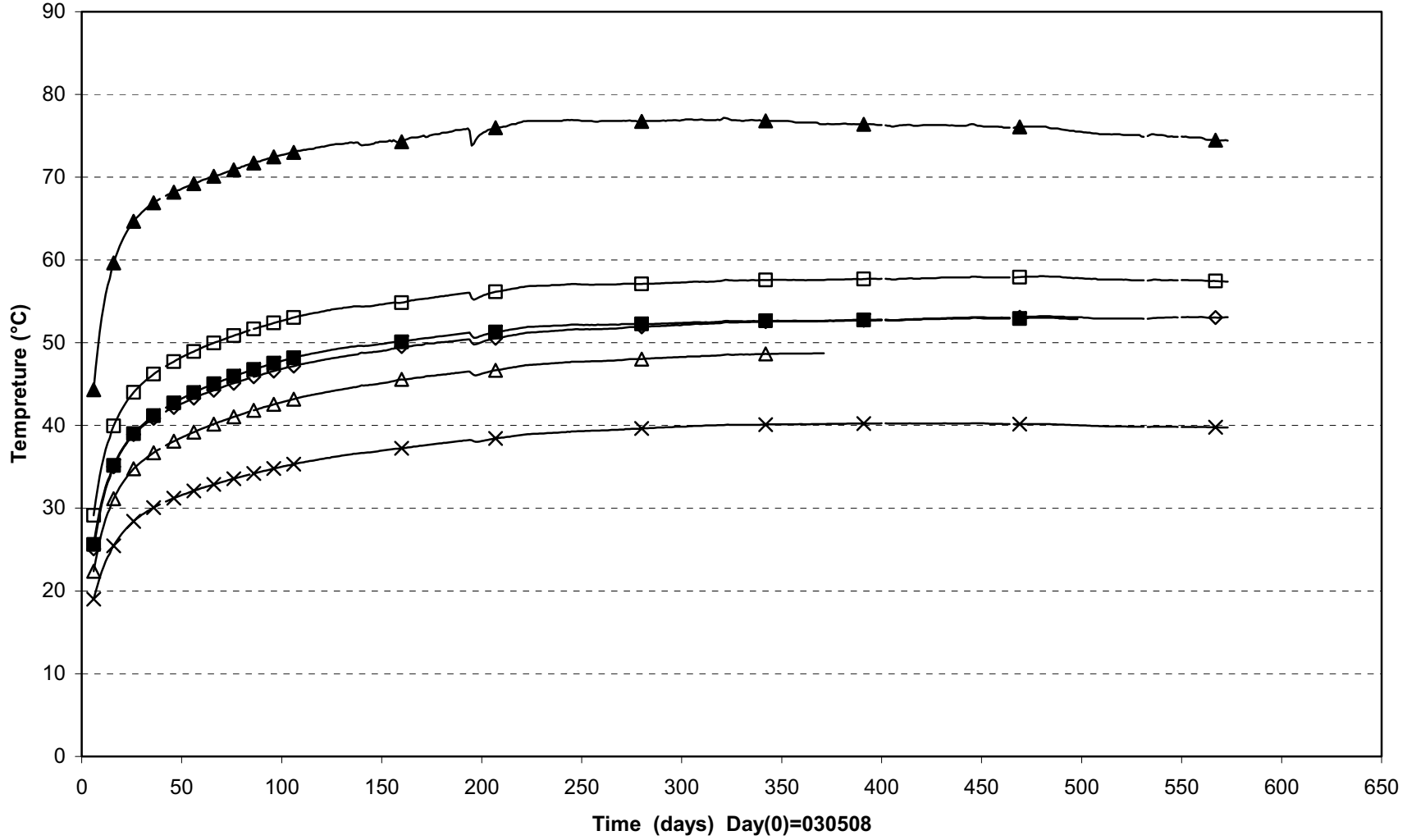

× PB501T(0\0°\0)	▲ PB502T(0.500\0°\0.100)	◇ PB506T(0.500\95°\0.635)
△ PB507T(0.500\105°\0.735)	□ PB508T(0.500\185°\0.635)	■ PB509T(0.500\195°\0.735)

Prototype\Hole 5\Ring5 (030508-041201)
 Temperature - Geokon

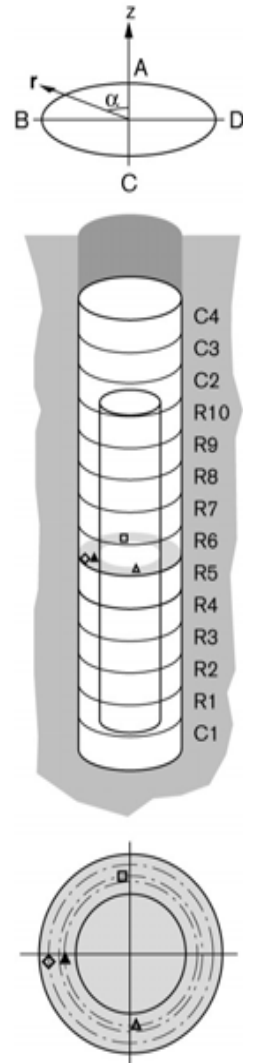
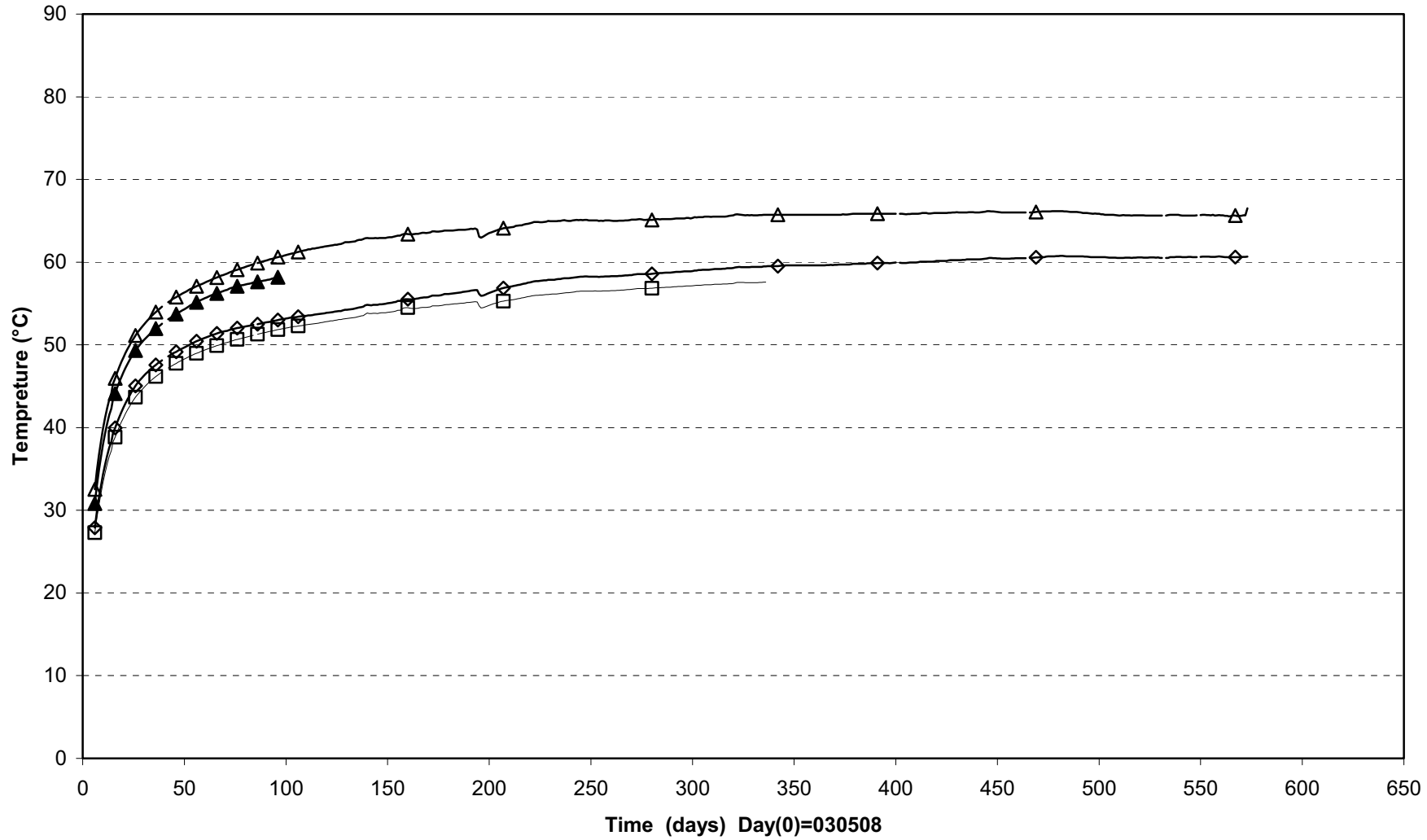

□ PB511T(3.036\5°\0.685)	▲ PB513T(3.036\95°\0.635)
◇ PB514T(3.036\95°\0.785)	△ PB515T(3.036\185°\0.635)

Prototype\Hole 5\Ring10 (030508-041201)
 Temperature - Geokon

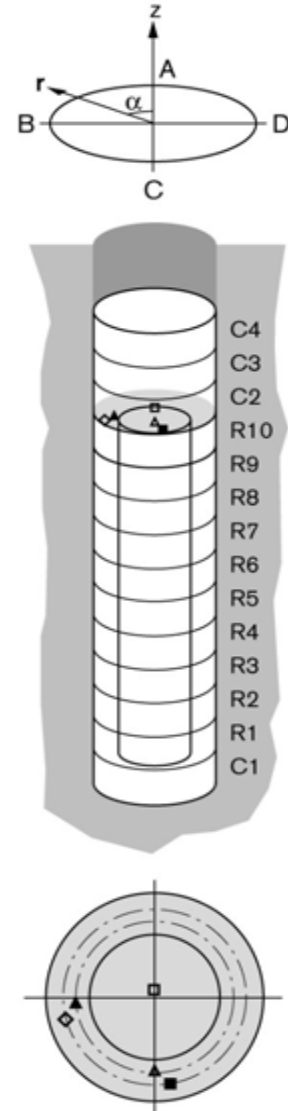
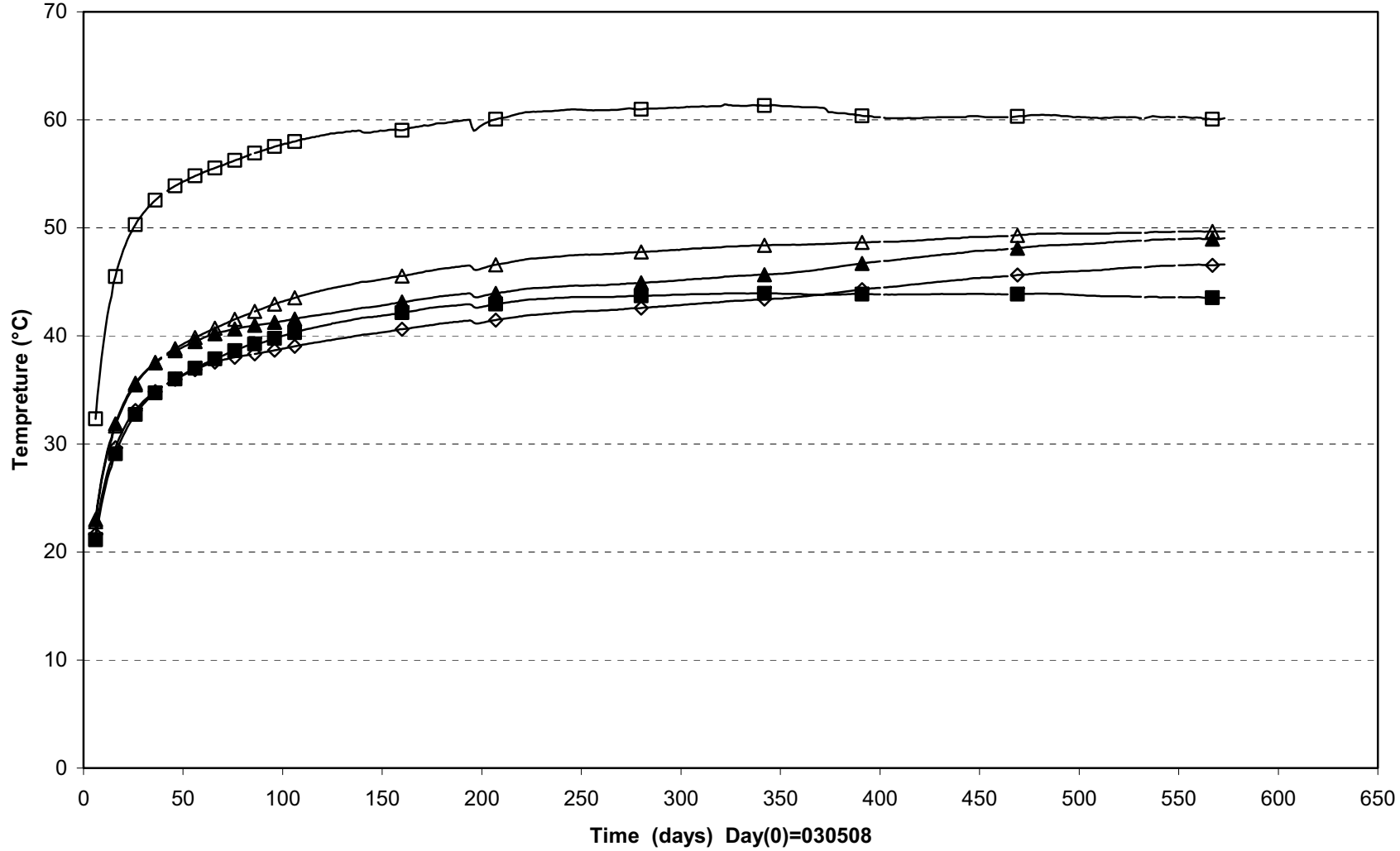

□ PB517T(5.593\0°\0.050)	▲ PB521T(5.593\95°\0.635)	◇ PB522T(5.593\105°\0.735)
△ PB523T(5.593\180°\0.635)	■ PB524T(5.593\190°\0.735)	

Prototype\Hole 5\Cyl.3 and Cyl.4 (030508-041201)
 Temperature - Geokon

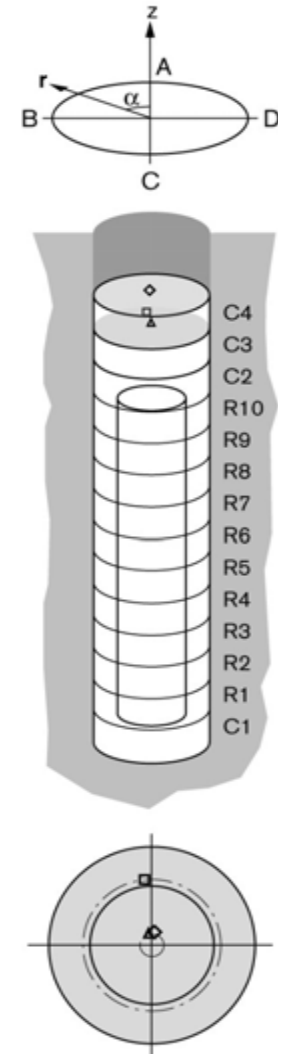
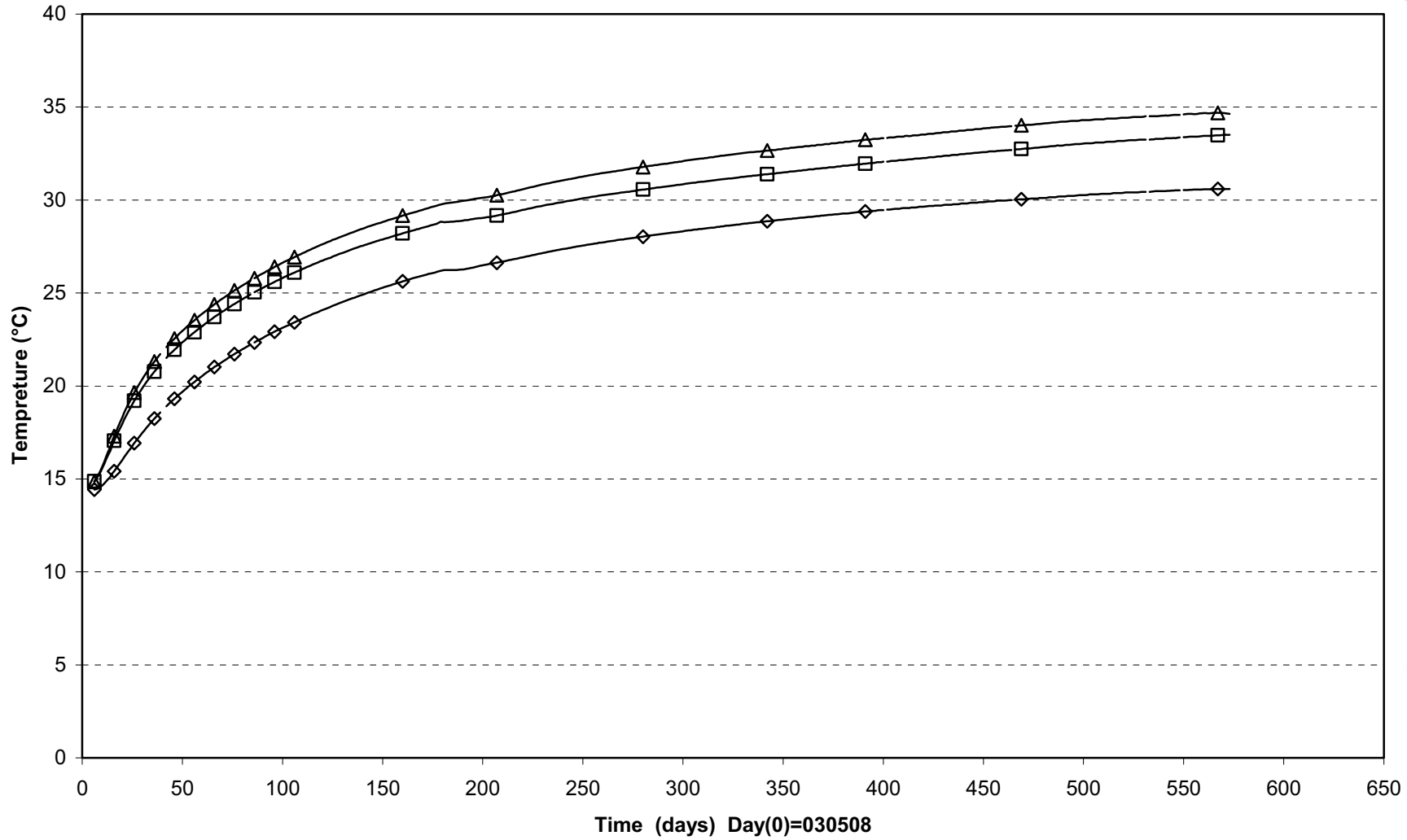

△ PB525T(6.603\0°\0.100)
□ PB526T(6.603\5°\0.585)
◇ PB527T(7.110\0°\0.100)

Prototype\Hole5 (030508-041201)
Temperature - Geokon

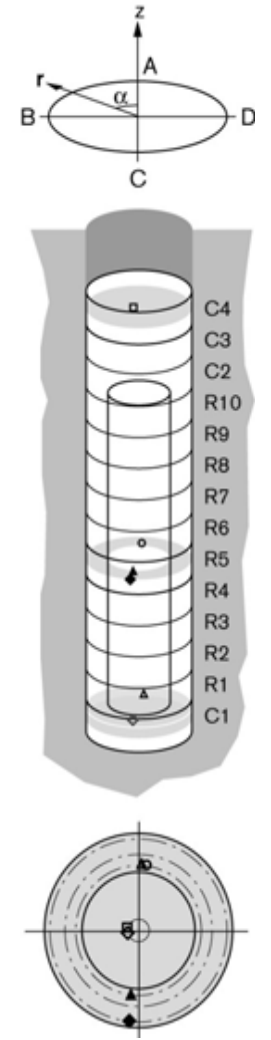
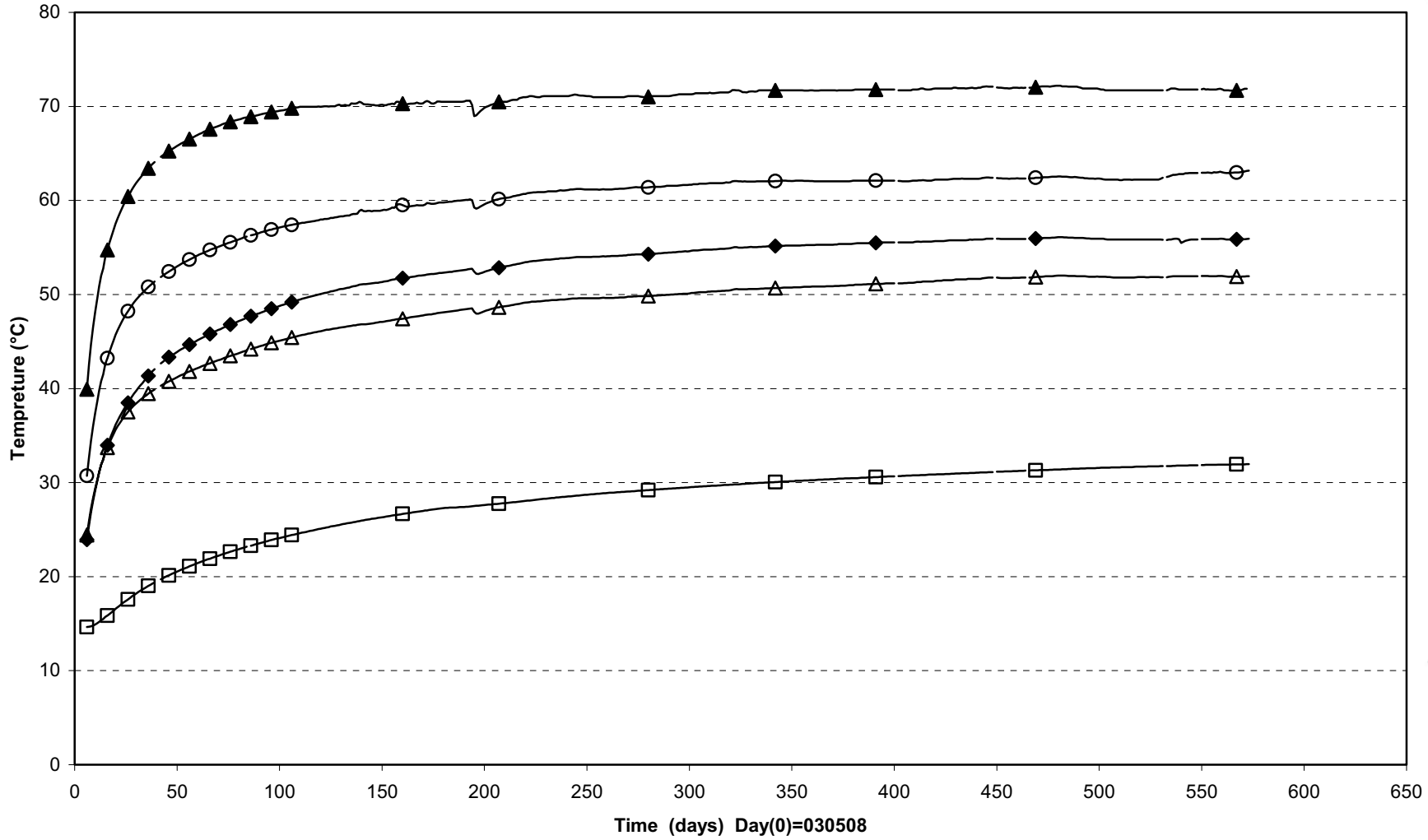

- ◇ UB502T(0.050\90°\0.100)
- △ UB503T(0.250\355°\0.585)
- UB505T(2.786\355°\0.585)
- ▲ UB509T(2.786\175°\0.535)
- ◆ UB510T(2.786\175°\0.825)
- UB514T(6.860\90°\0.100)

Prototype\Rock\Hole 5\ Bottom (030508-041201)
 Temperature - Pentronic

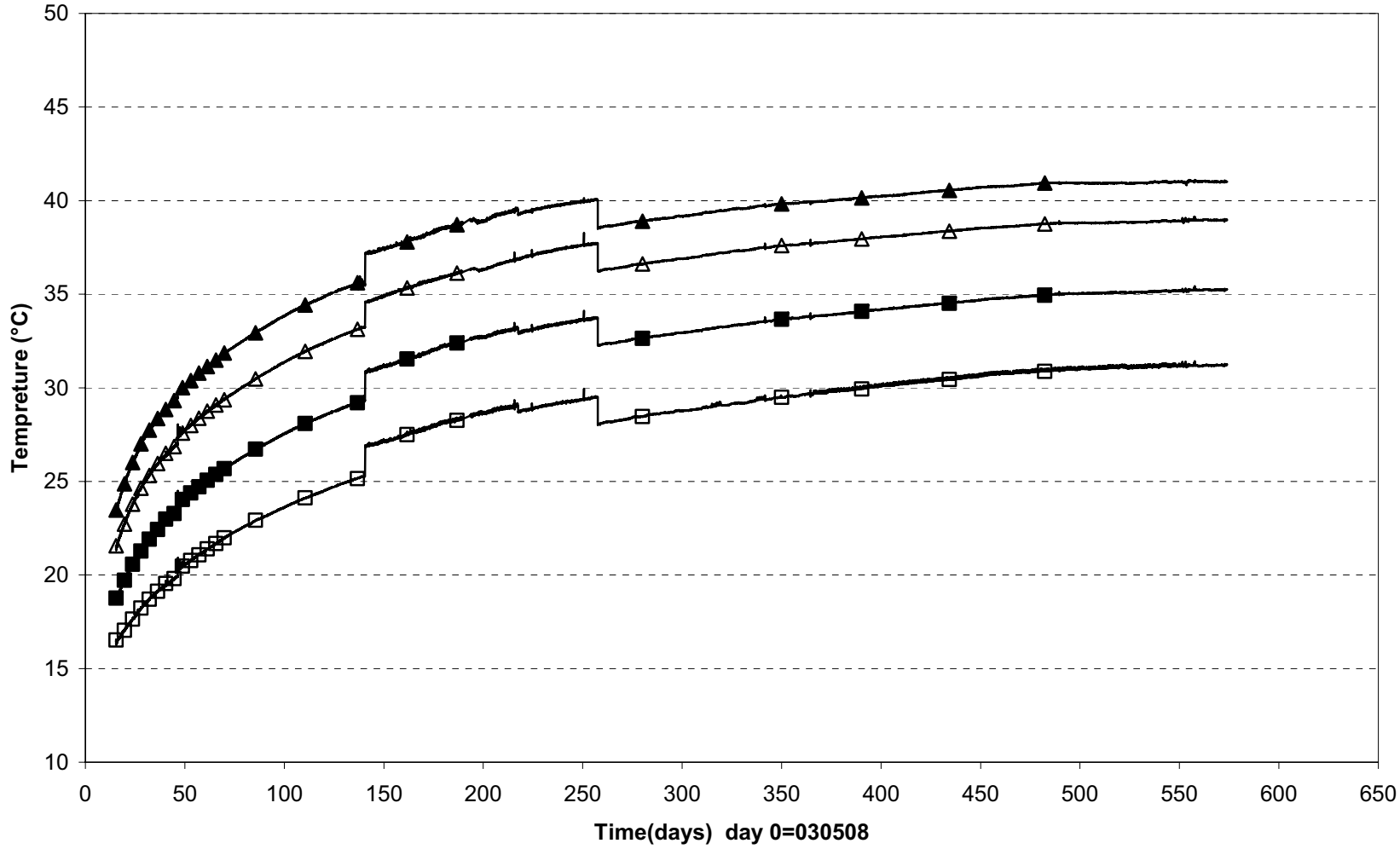

□ TR5011(-1.00°\0.0) ■ TR5012(-0.50°\0.0) △ TR5013(-0.20°\0.0) ▲ TR5014(0.00°\0.0)

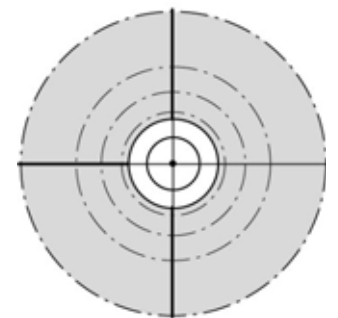
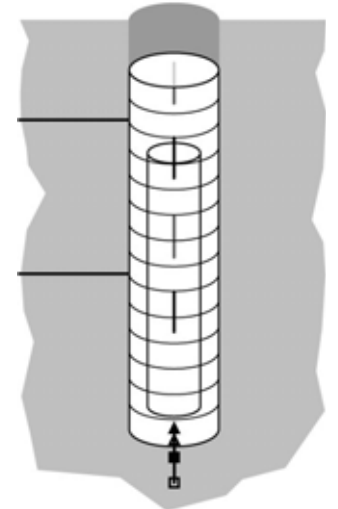
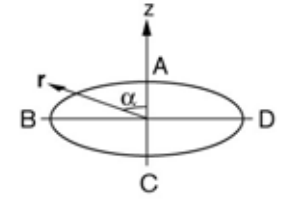

Prototype\Rock\Hole 5 \Level 3,0 m (030508-041201)
 Temperature - Pentronic

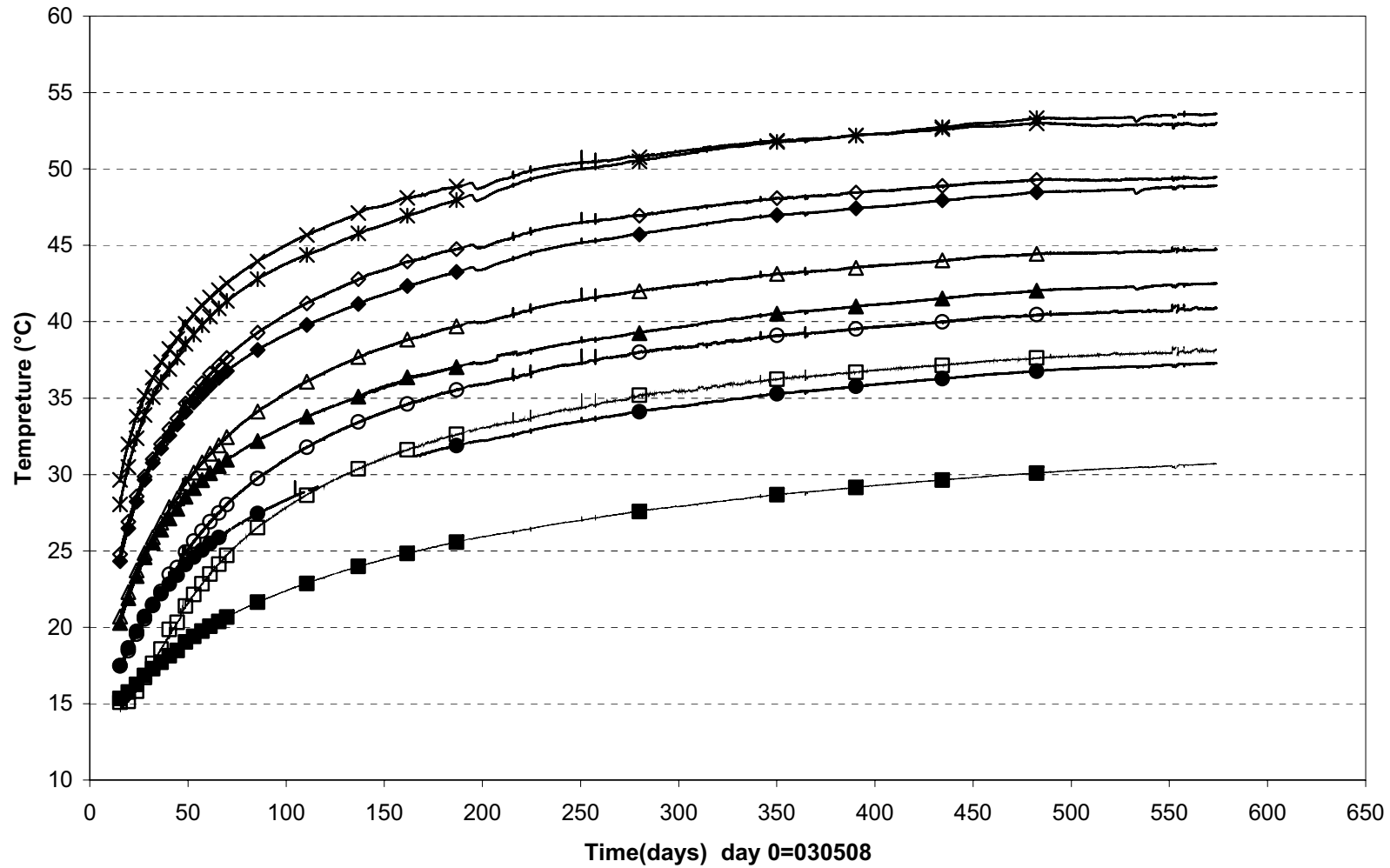

□ TR5041 (3.0\180°\3.95) ○ TR5042 (3.0\180°\2.85) △ TR5043 (3.0\180°\2.35) ◇ TR5044 (3.0\180°\1.95) × TR5045 (3.0\180°\1.75)
 ■ TR5051 (3.0\90°\3.95) ● TR5052 (3.0\90°\2.85) ▲ TR5053 (3.0\90°\2.35) ◆ TR5054 (3.0\90°\1.95) ✱ TR5055 (3.0\90°\1.75)

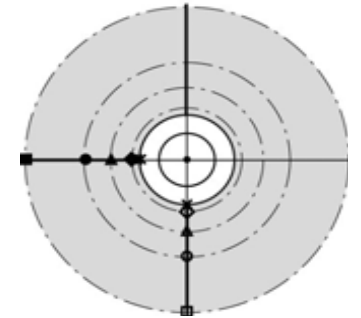
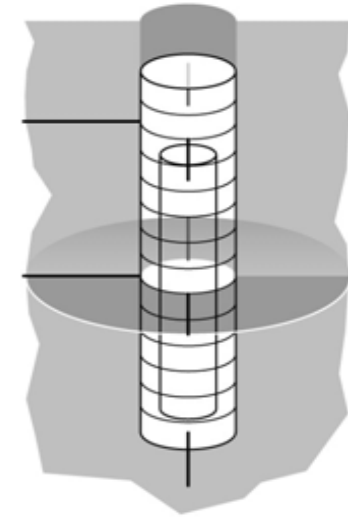
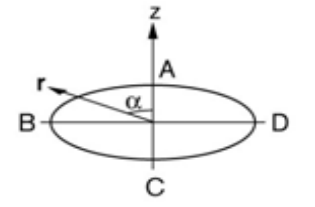

Prototype\Rock\Hole 5 \Level 6,0 m (030508-041201)
 Temperature - Pentronic

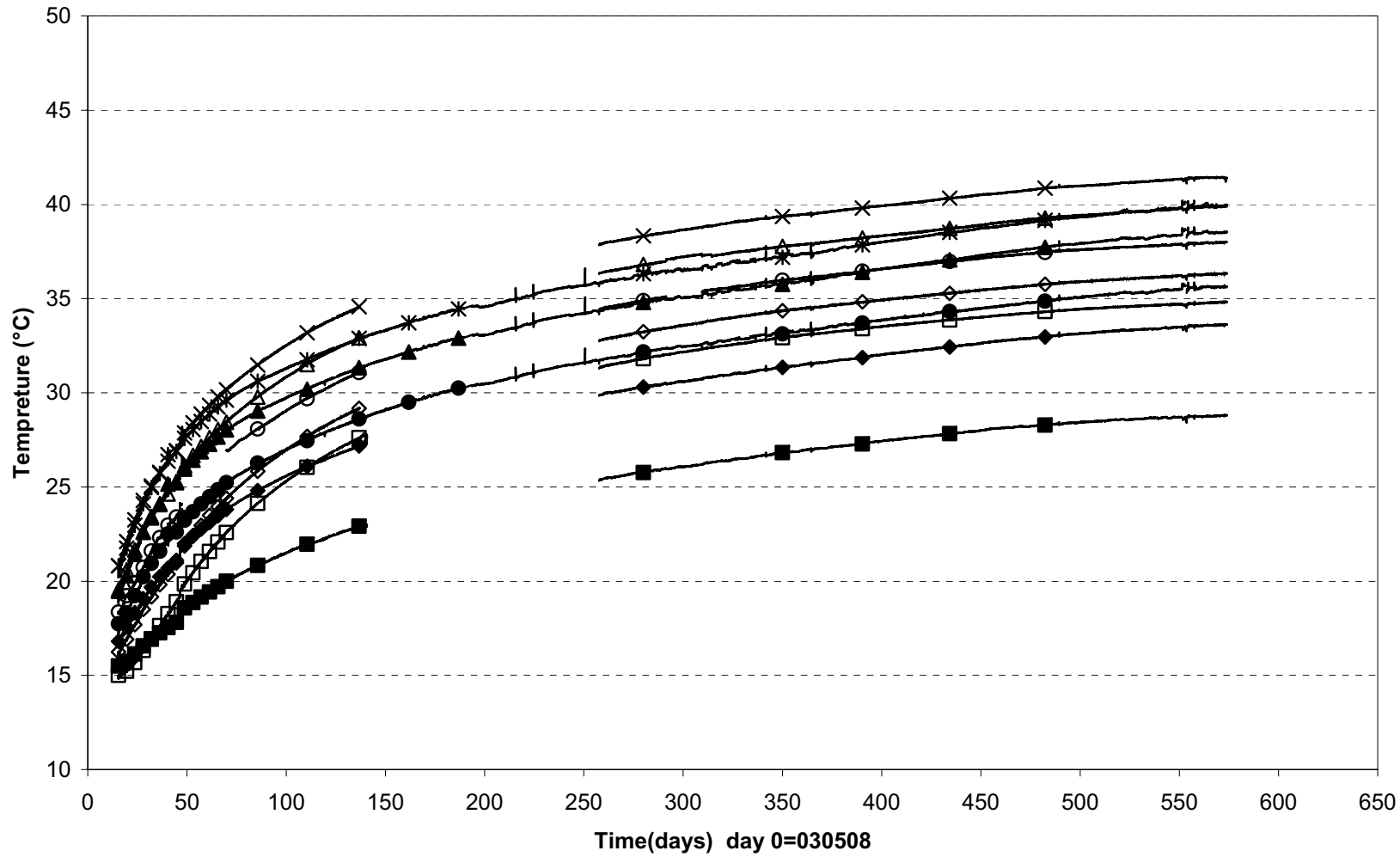

- | | | | | |
|--------------------------|--------------------------|--------------------------|--------------------------|--------------------------|
| □ TR5021 (6.0\180°\3.95) | ◇ TR5022 (6.0\180°\2.85) | ○ TR5023 (6.0\180°\2.35) | △ TR5024 (6.0\180°\1.95) | × TR5025 (6.0\180°\1.75) |
| ■ TR5031 (6.0\90°\3.95) | ◆ TR5032 (6.0\90°\2.85) | ● TR5033 (6.0\90°\2.35) | ▲ TR5034 (6.0\90°\1.95) | ✱ TR5035 (6.0\90°\1.75) |

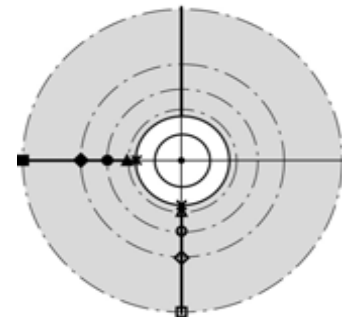
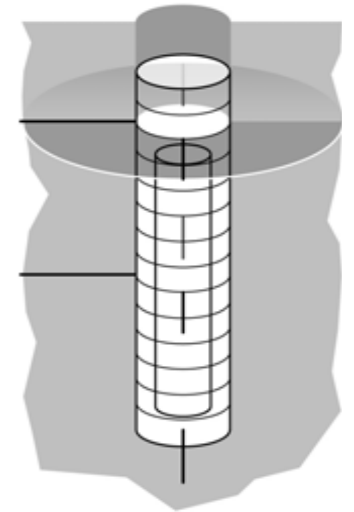
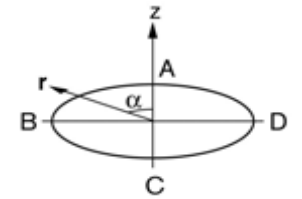

Prototype\Hole 5 (030508-041201)
Canister power

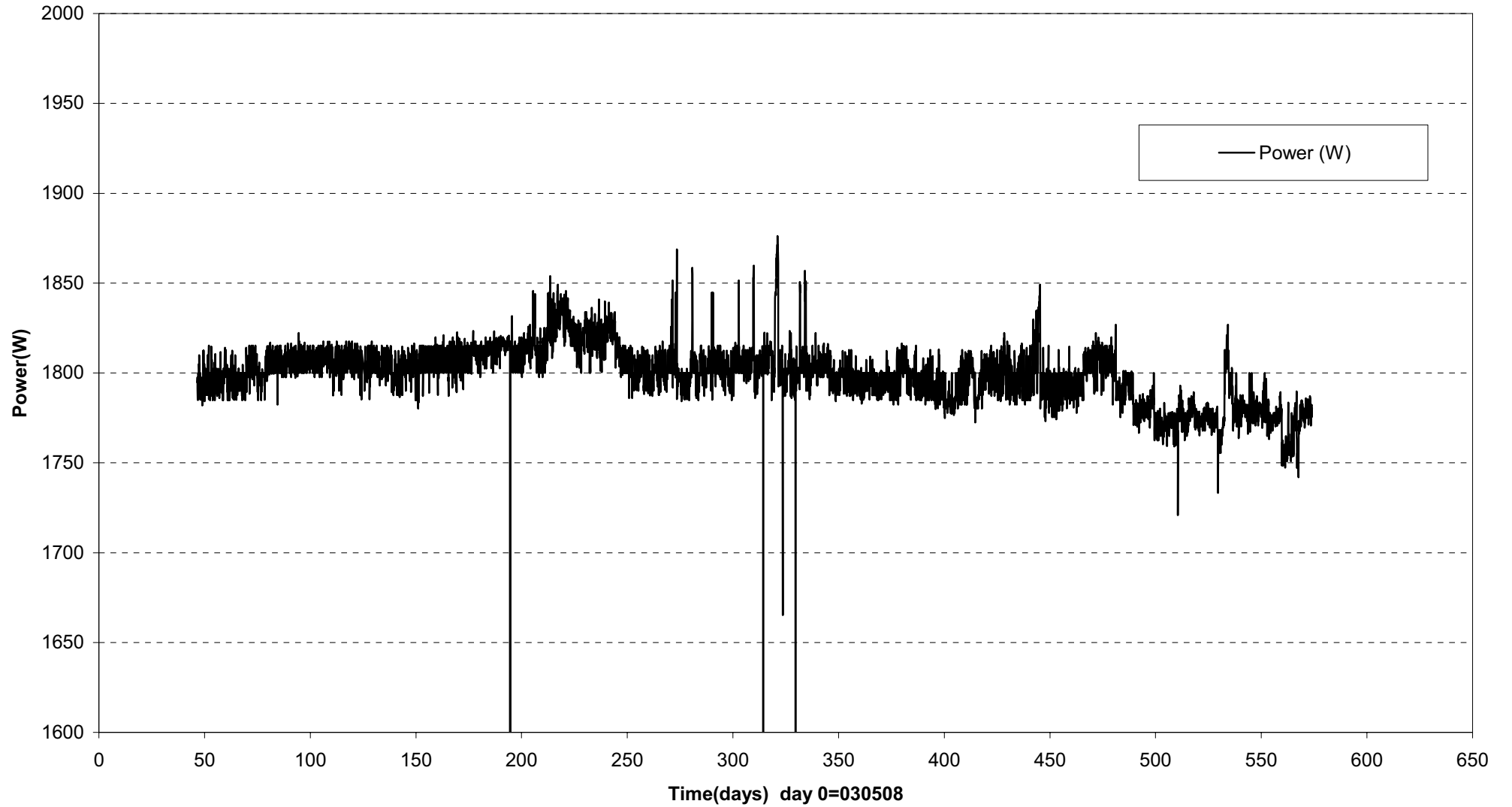

Prototype\ Hole 5 \Canister (040901-041201)
 Max. temperature on the canister surface - Optical fiber cables

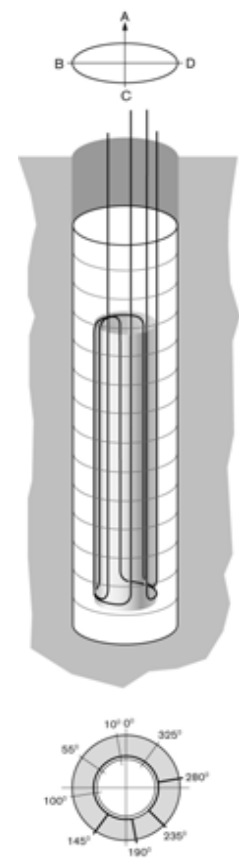
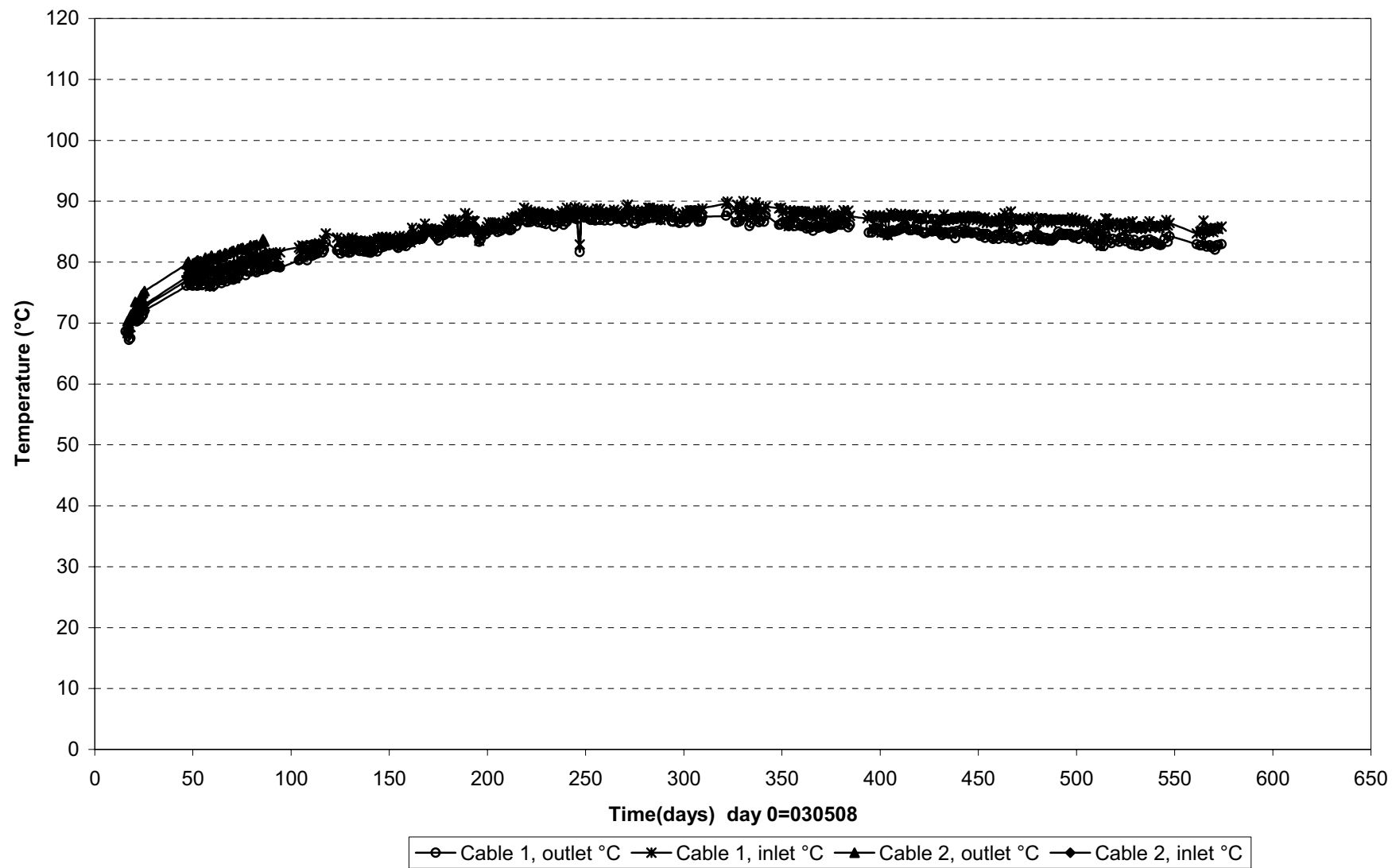

Temperature profile on the canister surface-No5 (041201)
Optical fiber cables

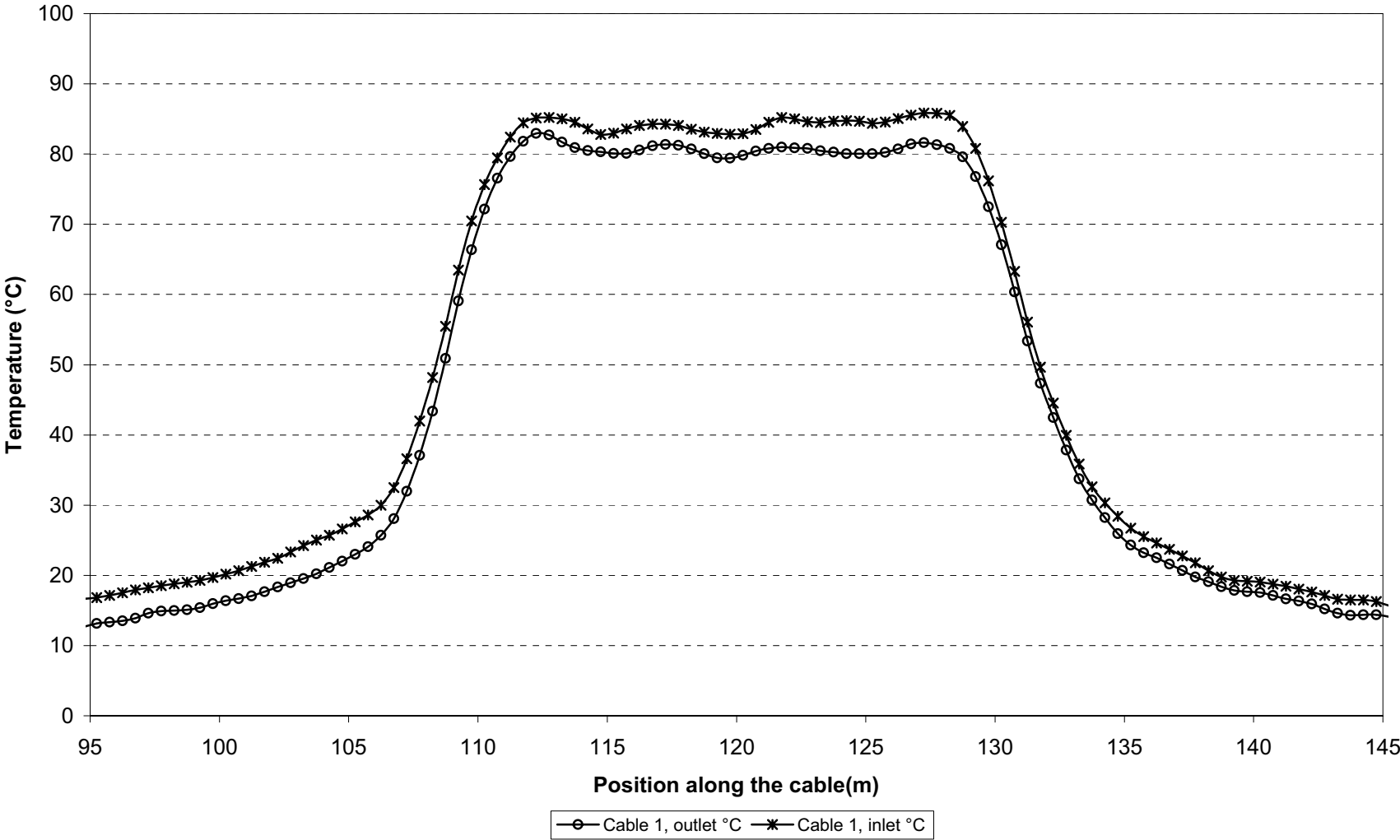

Prototype\Hole 5 \On the canister surface (030508-041201)
 Temperature - Pentronic

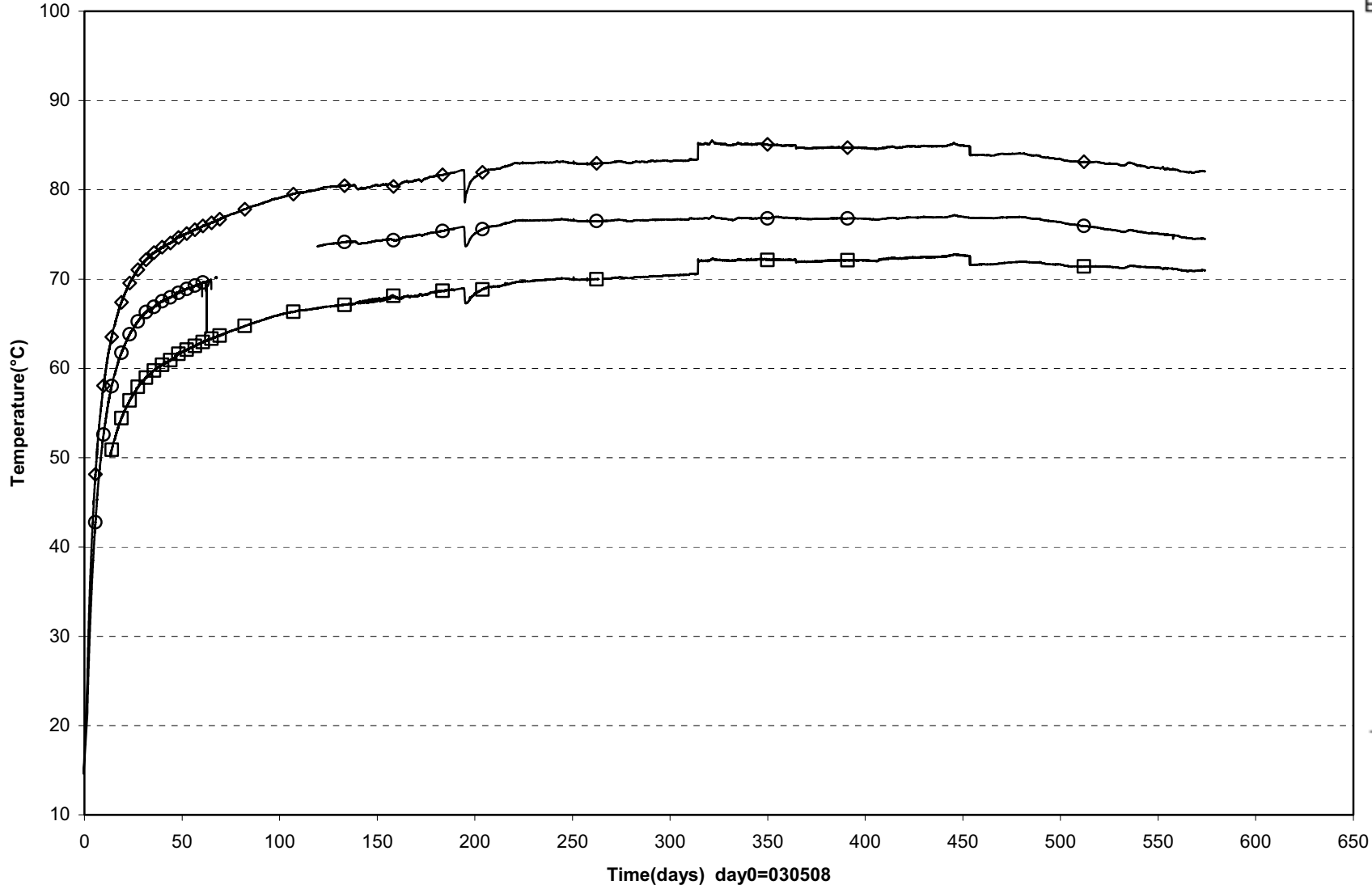

□ TB504(0.450\355°\0.525) ◇ TB511(2.950\0°\0.525) ○ TB524(5.150\ 0°\0.525)

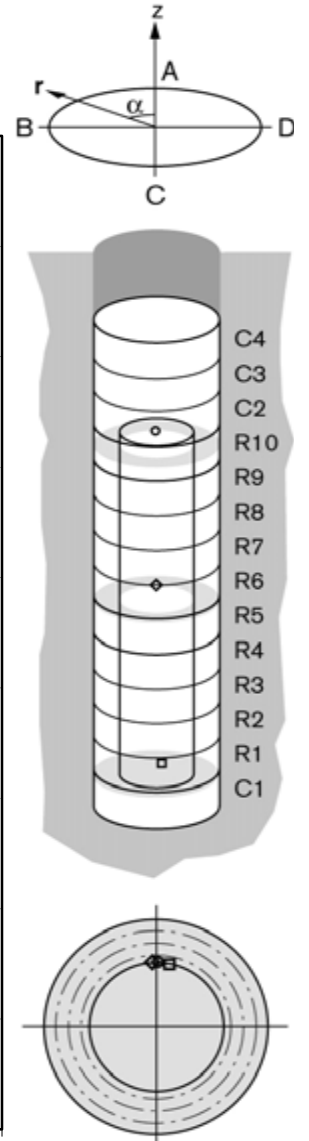

Appendix 6

Dep. hole 6

Prototype\Hole 6\Cyl.1 , Cyl.2 and Cyl.3 (030508-041201)
Total pressure

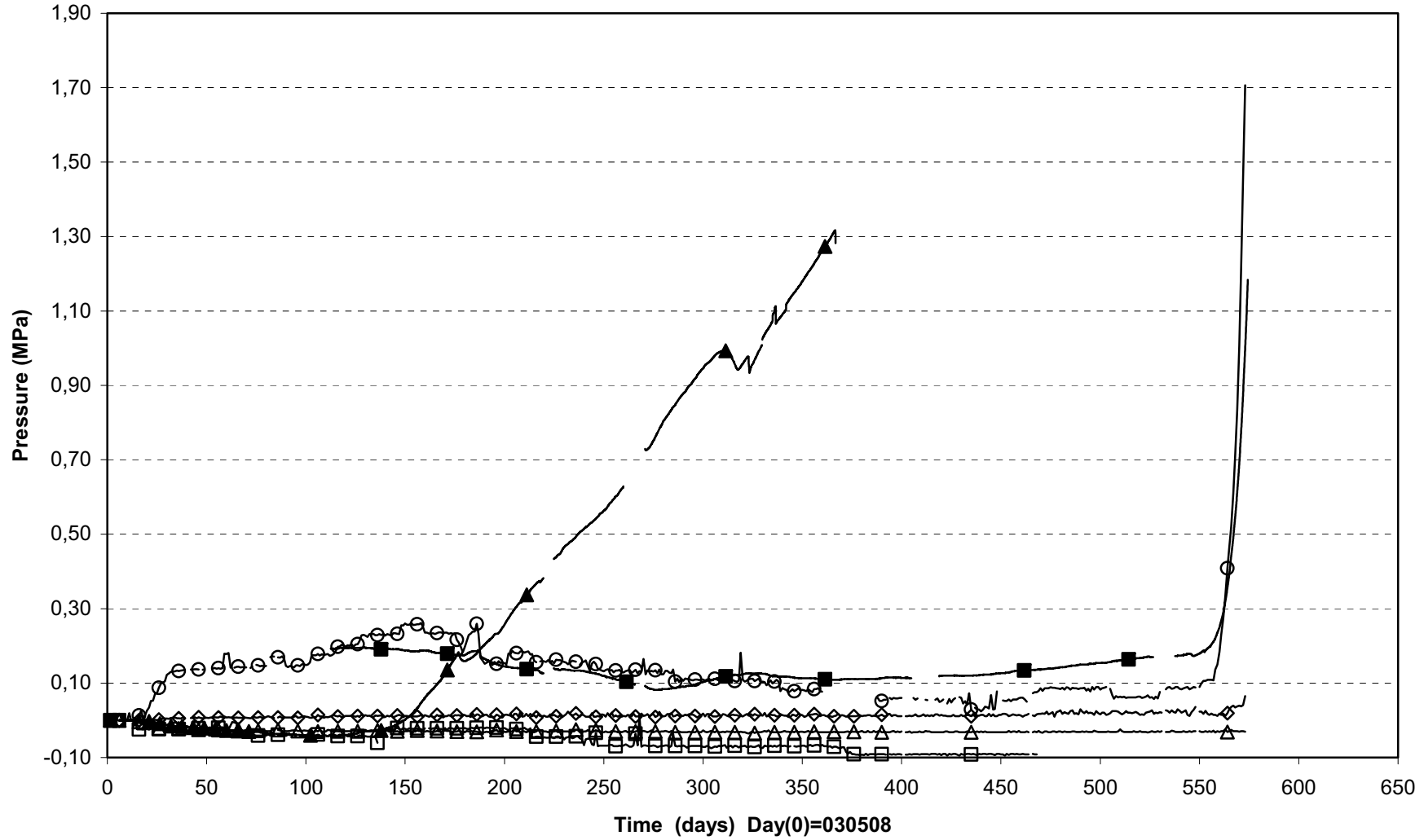

△ PB601(0.510\315°\0.210)	▲ PB602(0.260 \80°\ 0.685)	■ PB624(7.121 \135°\ 0.585)
□ PB625(6.616\0°\0.100)	◇ PB626(6.616\5°\0.585)	○ PB627(7.121\0°\0.100)

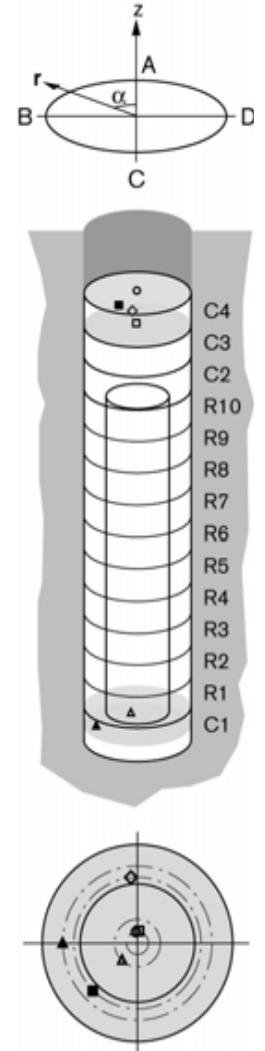

Prototype\Hole 6\ Ring1 and Ring 2 (030508-041201)
Total pressure

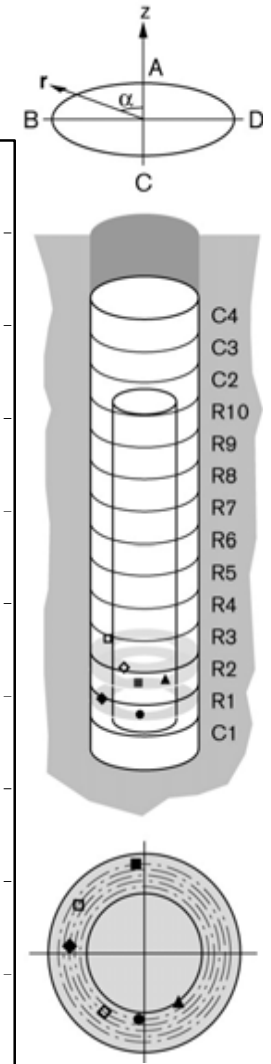
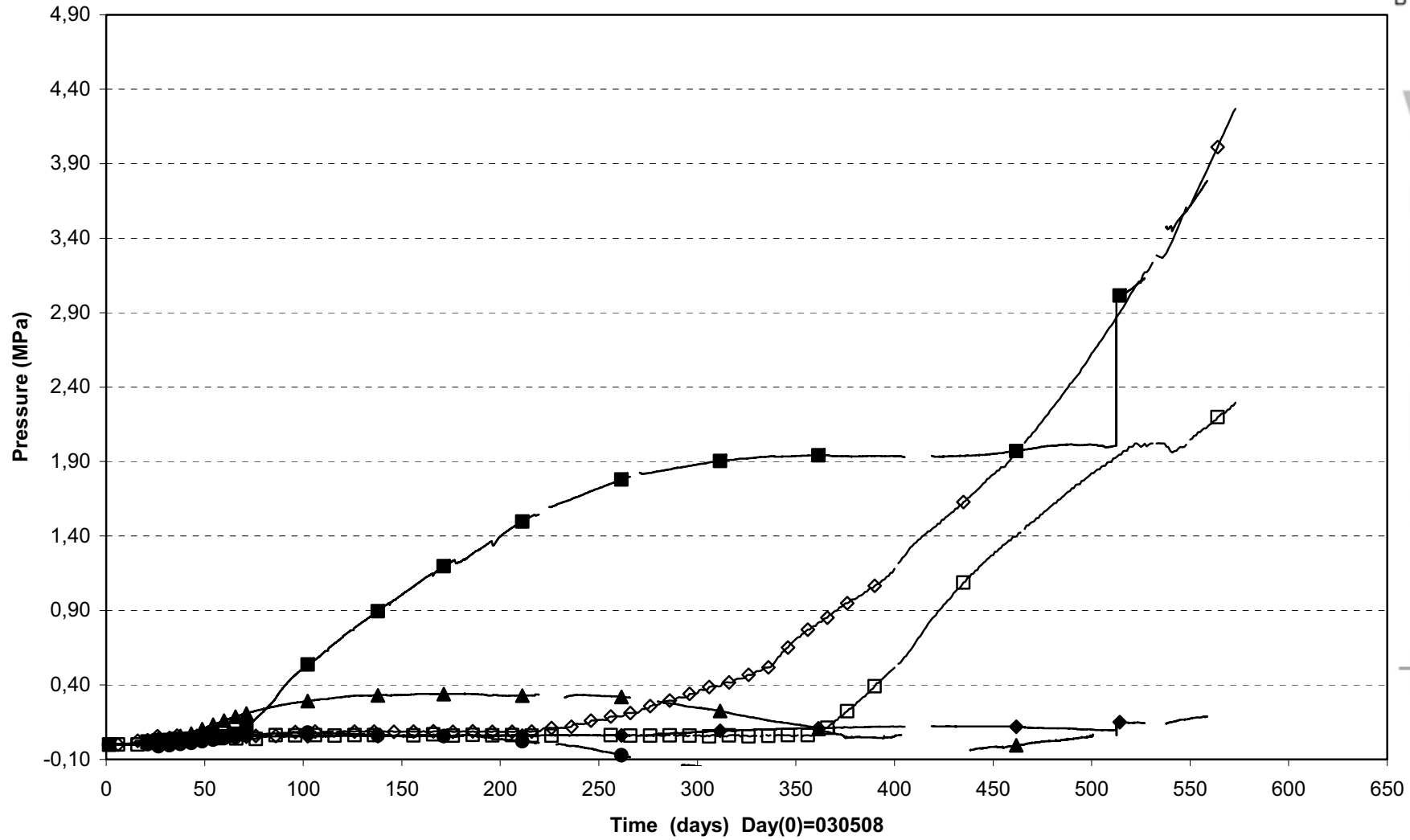

■ PB603(0.770 \10^\ 0.785)	◆ PB604(0.770 \80^\ 0.685)	● PB605(0.770 \170^\ 0.585)
□ PB606(1.534\55^\ 0.735)	◇ PB607(1.534\145^\ 0.635)	▲ PB608(1.284 \215^\ 0.535)

Prototype\Hole 6\ Ring 5 and Ring 6 (030508-041201)
Total pressure

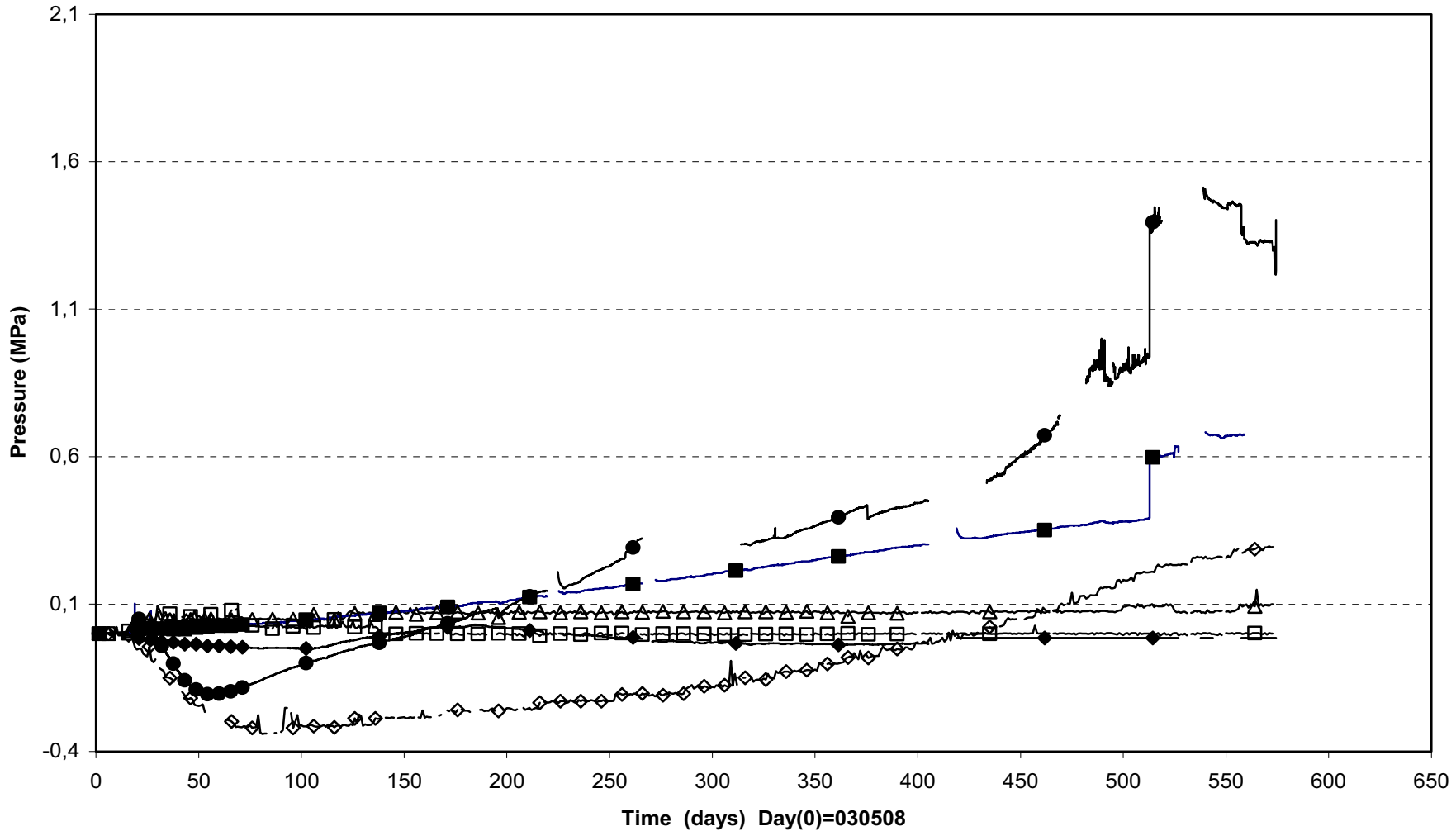

▲ PB610(2.795 \10°\ 0.785)	■ PB611(2.795 \80°\ 0.685)	◆ PB612(2.795 \170°\ 0.585)
△ PB613(3.550\55°\0.785)	□ PB614(3.550\145°\0.635)	● PB615(3.300 \215°\ 0.535)
◇ PB616(3.253\325°\0.875)		

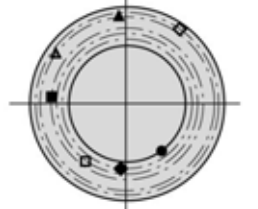
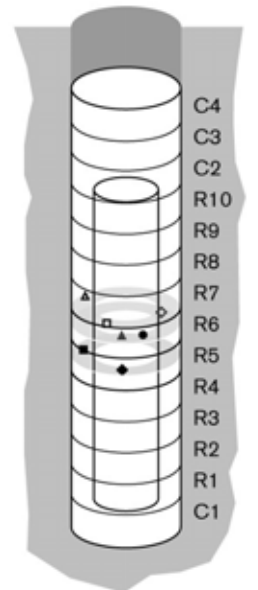
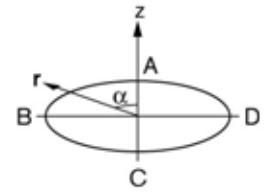

Prototype\Hole 6\ Ring 8 and Ring 9 (030508-041201)

Total pressure

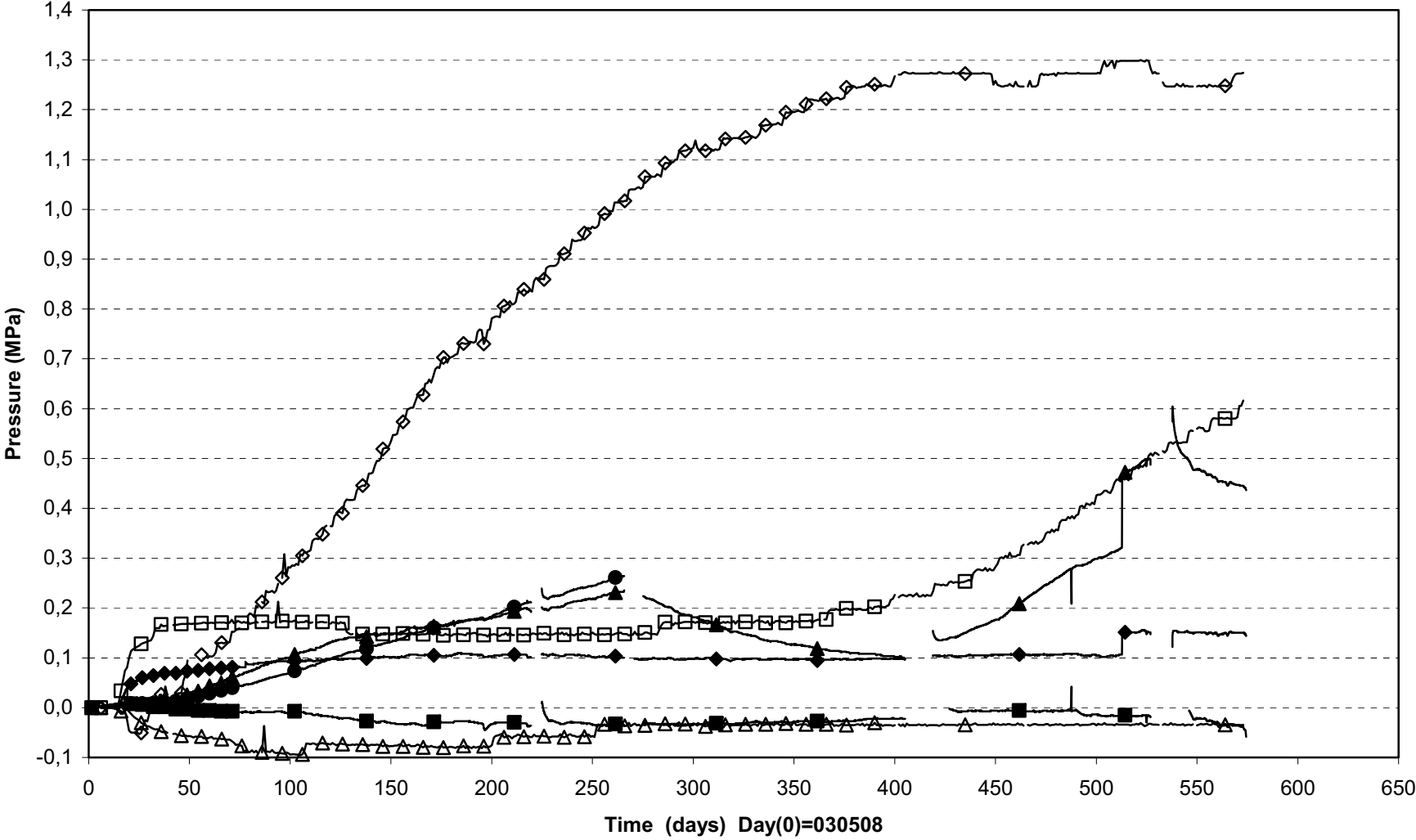

▲ PB617(4.324 \10°\ 0.785)	■ PB618(4.324 \80°\ 0.685)	◆ PB619(4.324 \170°\ 0.585)
△ PB620(5.084\55°\0.735)	□ PB621(5.084\145°\0.635)	● PB622(4.834 \215°\ 0.535)
◇ PB623(4.753\325°\0.875)		

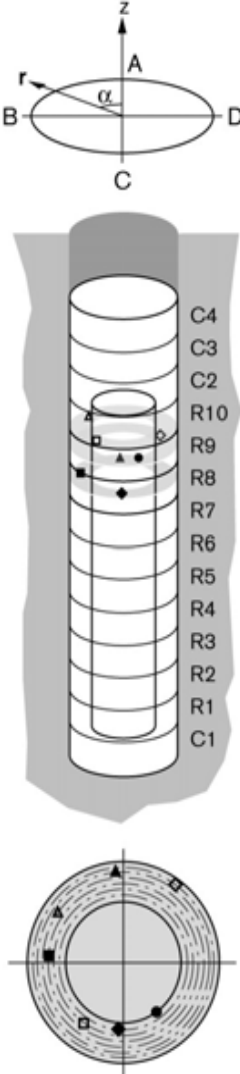

Prototype\Hole 6\Cyl.1 (030508-041201)
Relative humidity

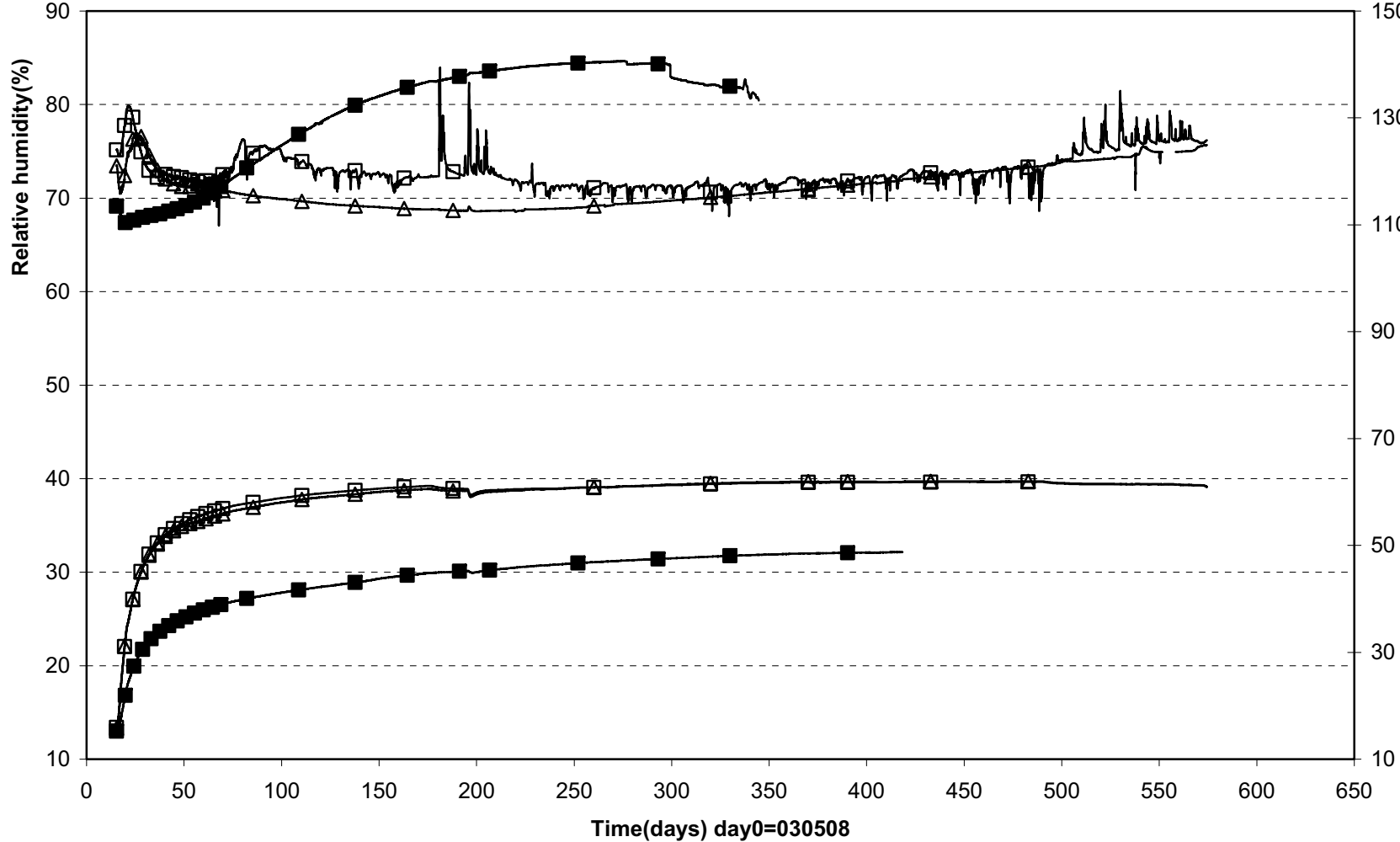

■ WB667(0.260\280°\0.685) □WB601 (0.260\135°\0.050) △WB604 (0.260\270°\0.210)

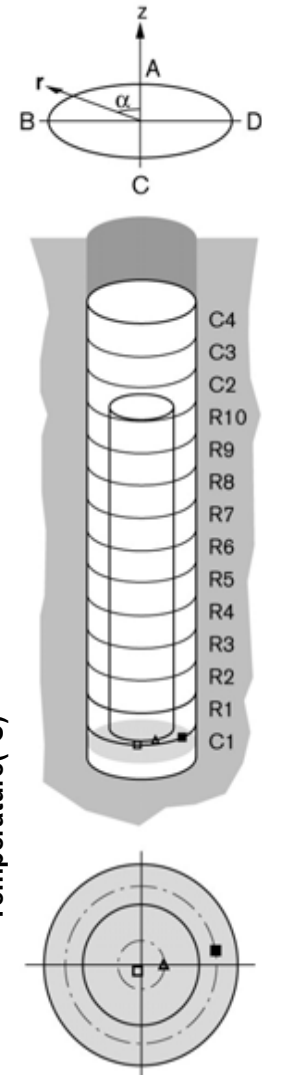

Prototype\Hole 6\ Ring 1 and Ring 2 (030508-041201)
Relative humidity

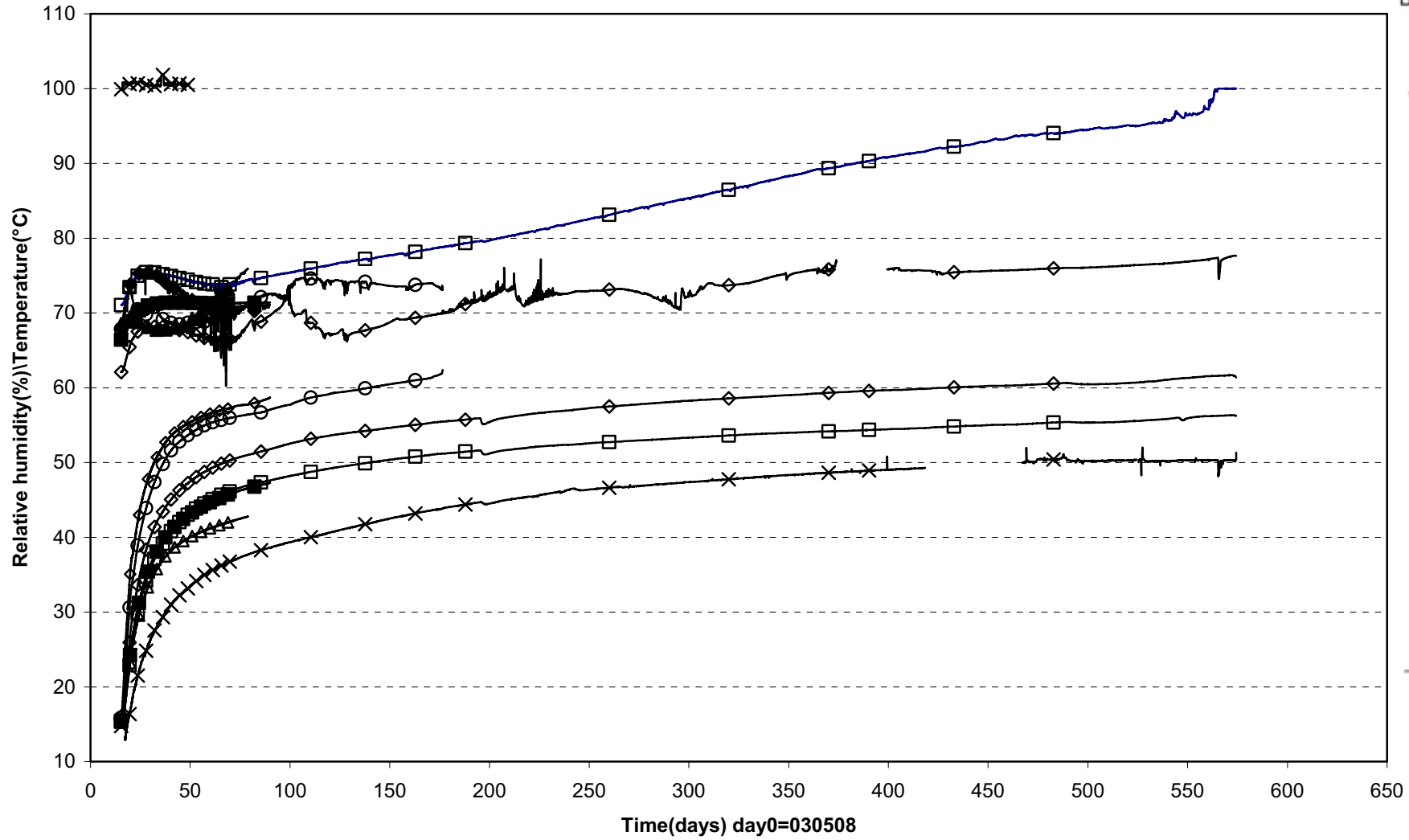

■ WB607(0.770\90°\0.685)	◆ WB609(0.770\180°\0.585)	▲ WB612(0.770\360°\0.785)	□ WB613(1.284\40°\0.735)
◇ WB615(1.284\130°\0.635)	○ WB617(1.284\230°\0.535)	× WB620(1.253\315°\0.875)	

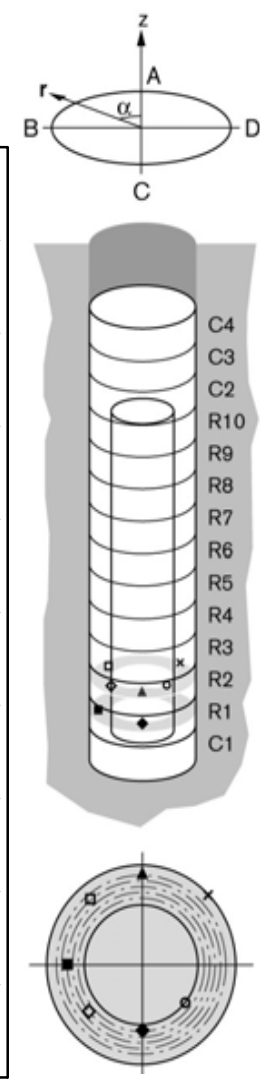

Prototype\Hole 6\Ring 5 and Ring 6 (030508-041201)
Relative humidity

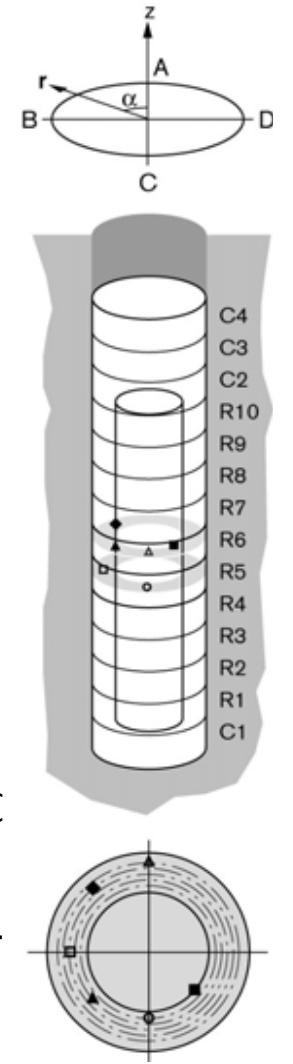
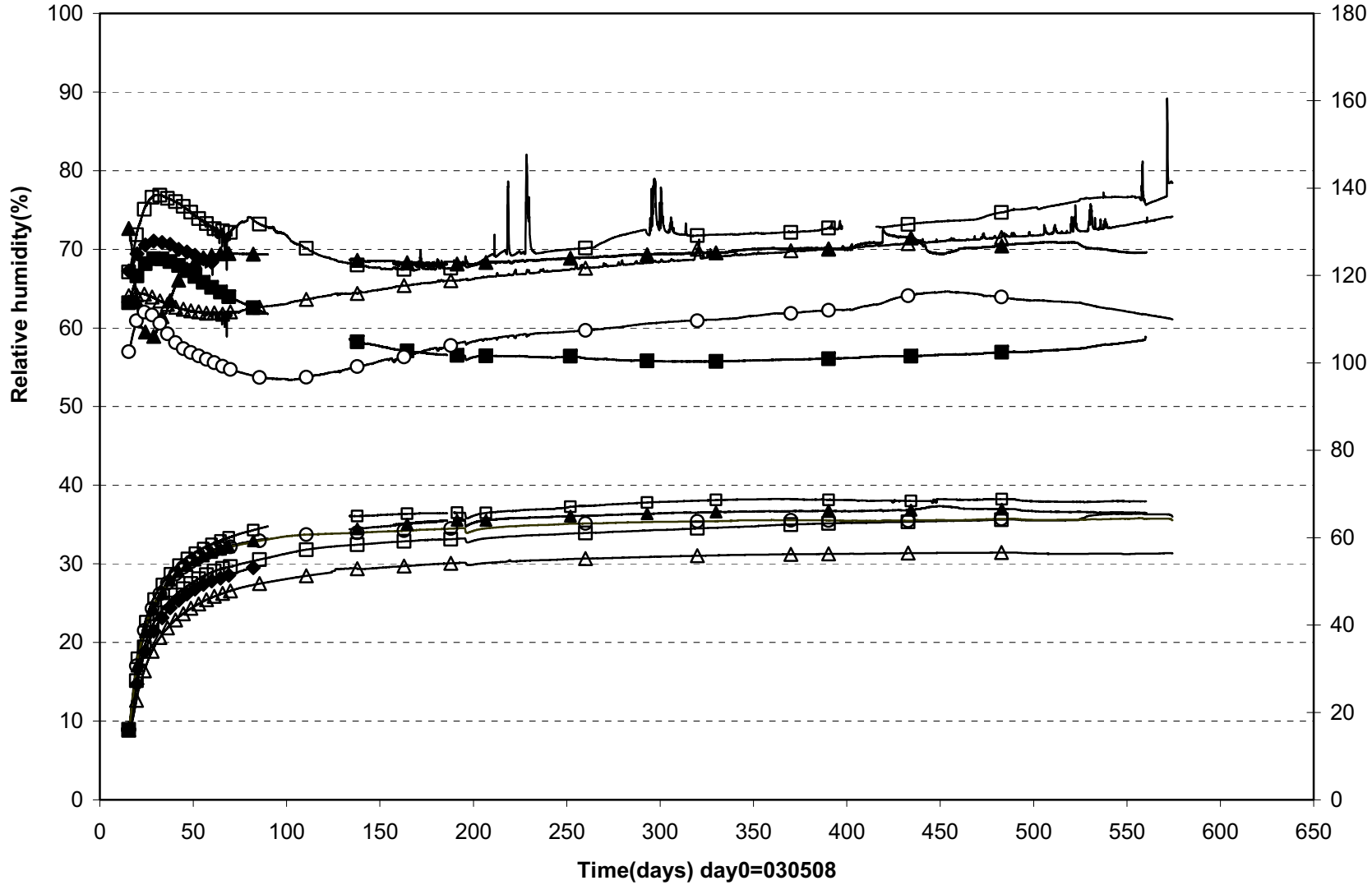

▲ WB629(3.300\130°\0.635)	■ WB631(3.300\230°\0.535)	◆ WB627(3.300\40°\0.735)	□ WB621(2.795\90°\0.685)
○ WB623(2.795\180°\0.585)	△ WB626(2.795\360°\0.785)		

Prototype\Hole 6\ Ring 8 and Ring9 (030508-041201)
Relative humidity

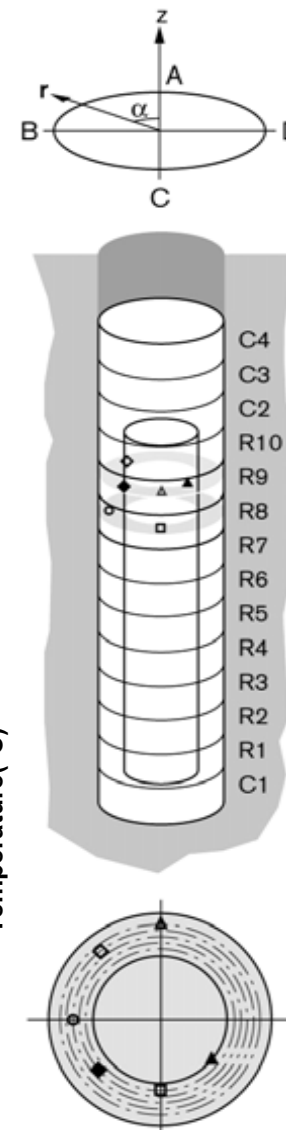
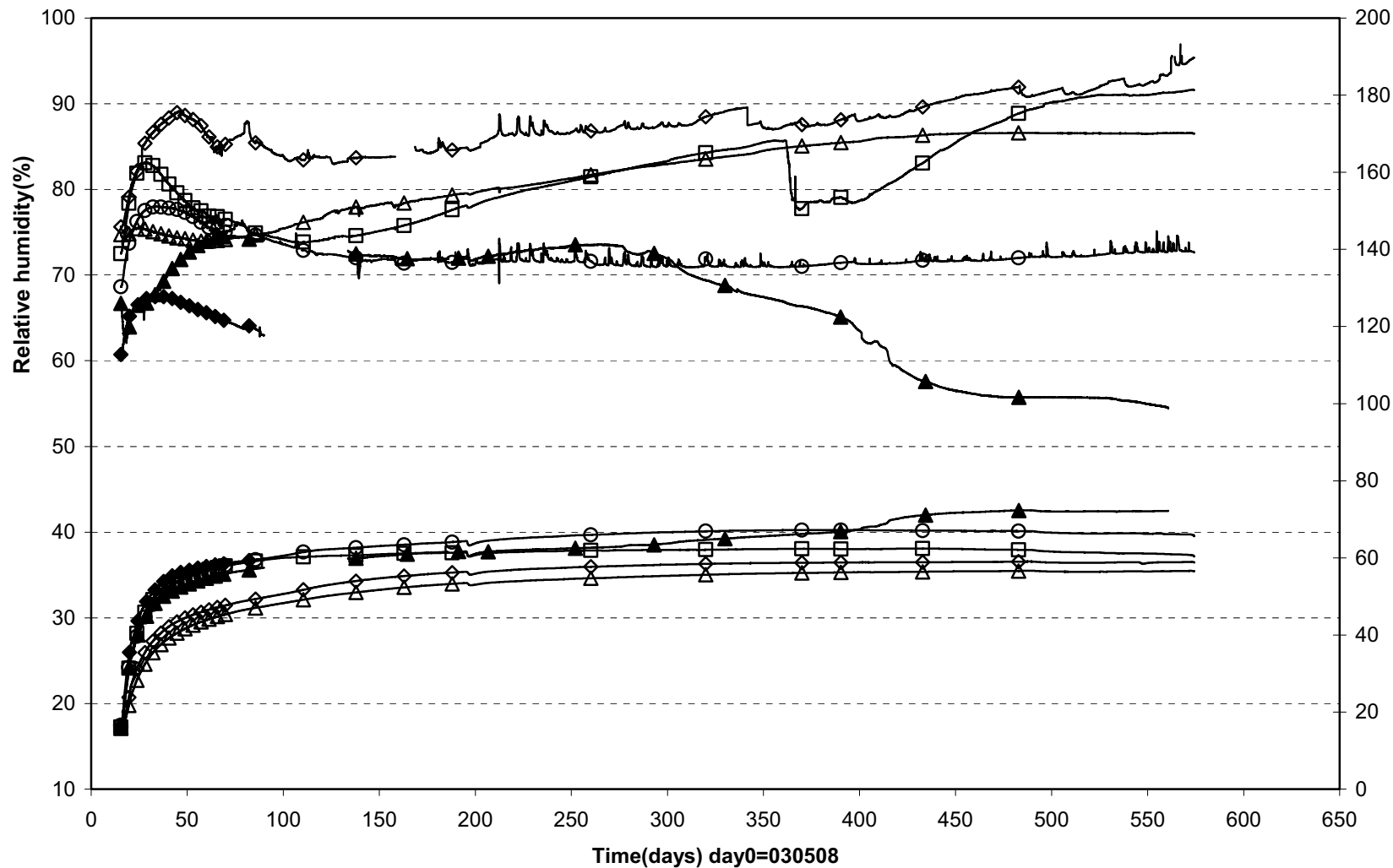

- ◆ WB643(4.834\130°\0.635)
- ▲ WB645(4.834\230°\0.535)
- WB635(4.324\90°\0.685)
- WB637(4.324\180°\0.585)
- △ WB640(4.324\360°\0.785)
- ◇ WB641(4.834\40°\0.735)

Prototype\Hole 6\ Ring10 (030508-041201)
Relative humidity

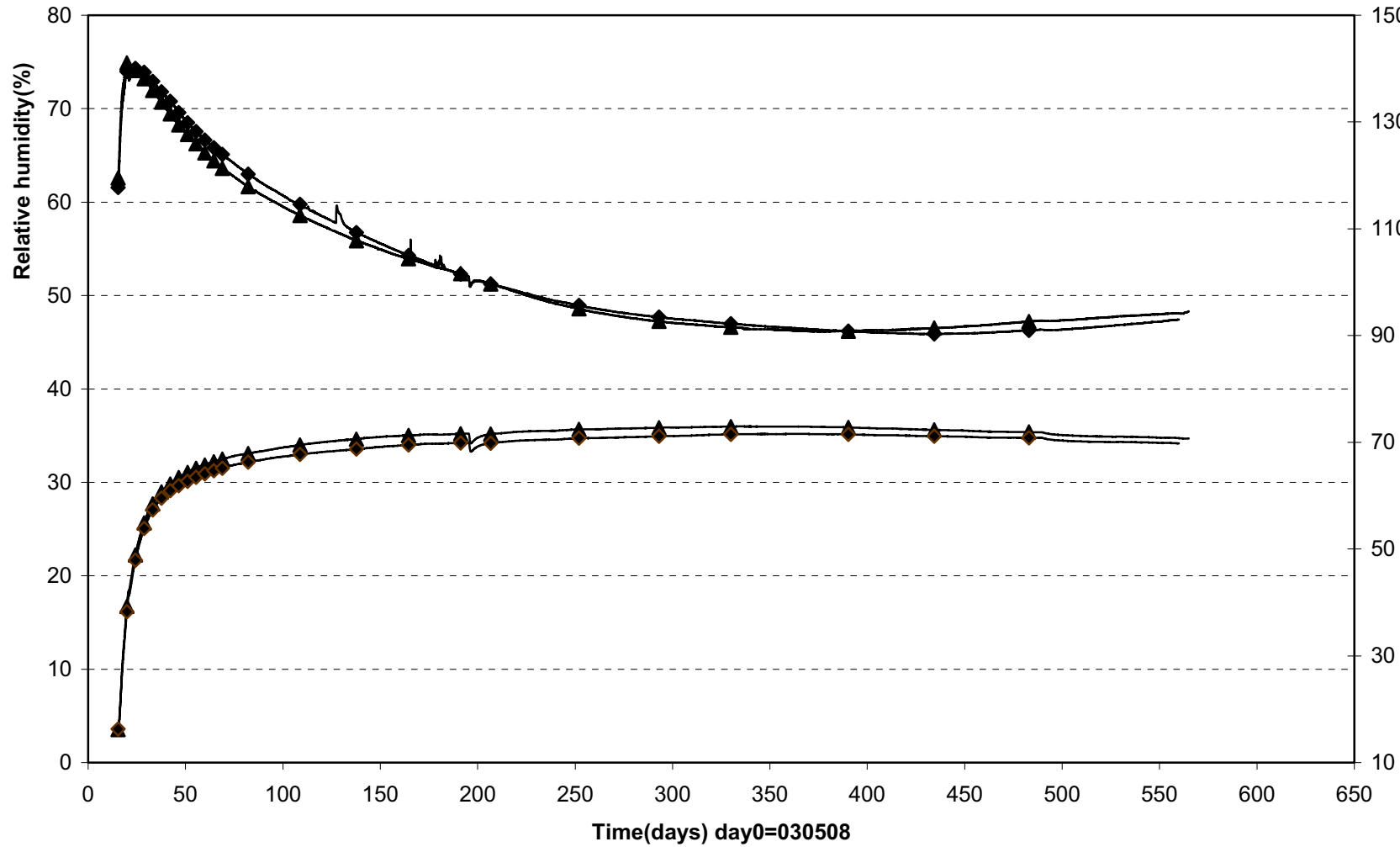

▲ WB649(5.439\90°\0.50) ◆ WB650(5.439\270°\0.210)

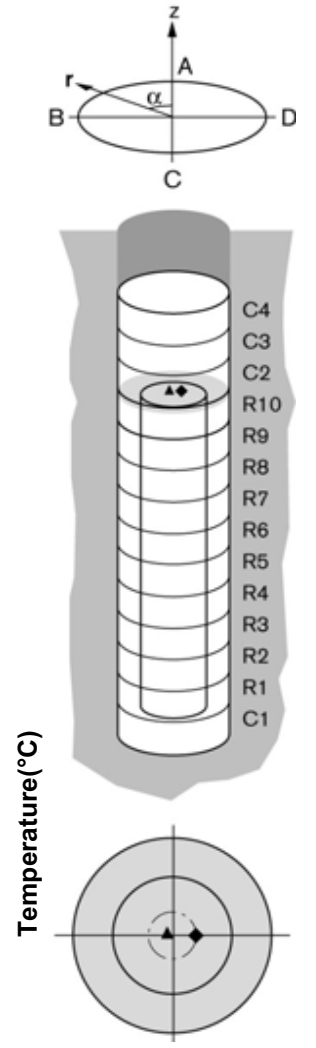

Prototype\Hole 6\Cyl.3 and Cyl.4 (030508-041201)
Relative humidity

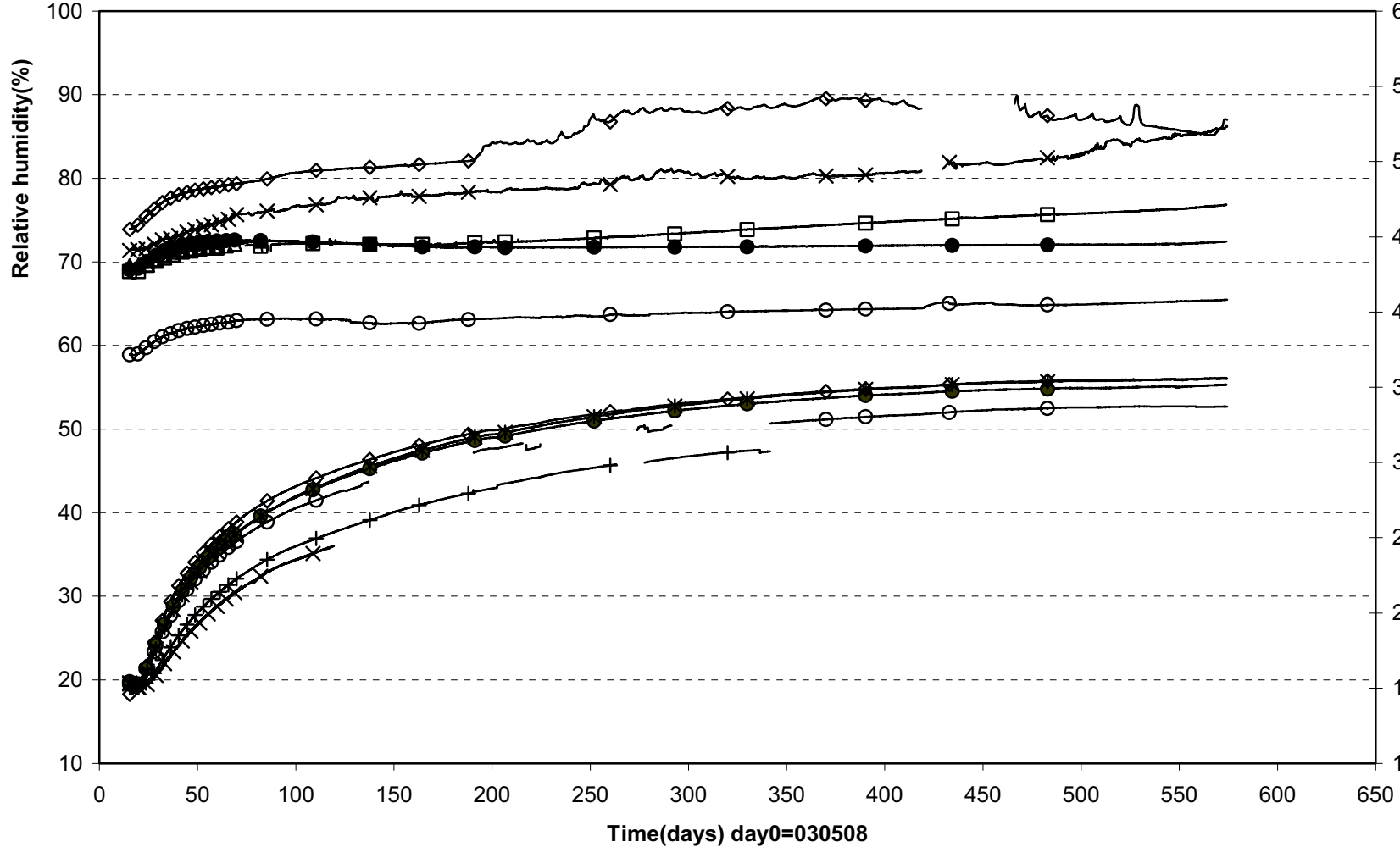

- WB652(6.366\90°\0.585) □ WB654(6.366\350°\0.585) △ WB656(6.961\270°\0.100) ◇ WB651(6.366\225°\0.100)
- WB653(6.366\180°\0.585) × WB655(6.801\180°\0.100)

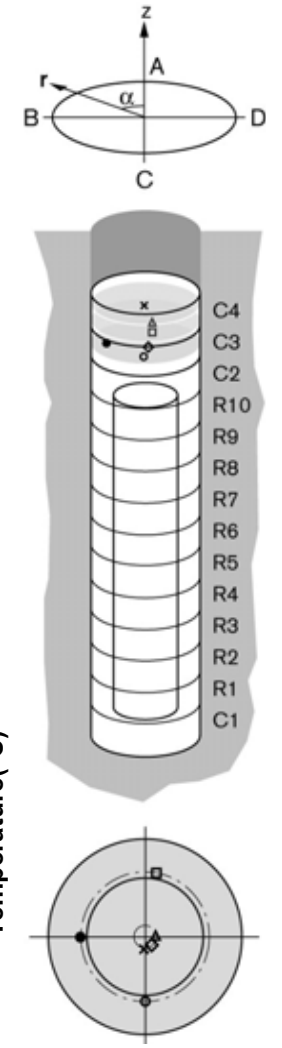

Prototype\Hole 6\Cyl.1 , Ring 6 and Ring8 (030508-041201)
Relative humidity

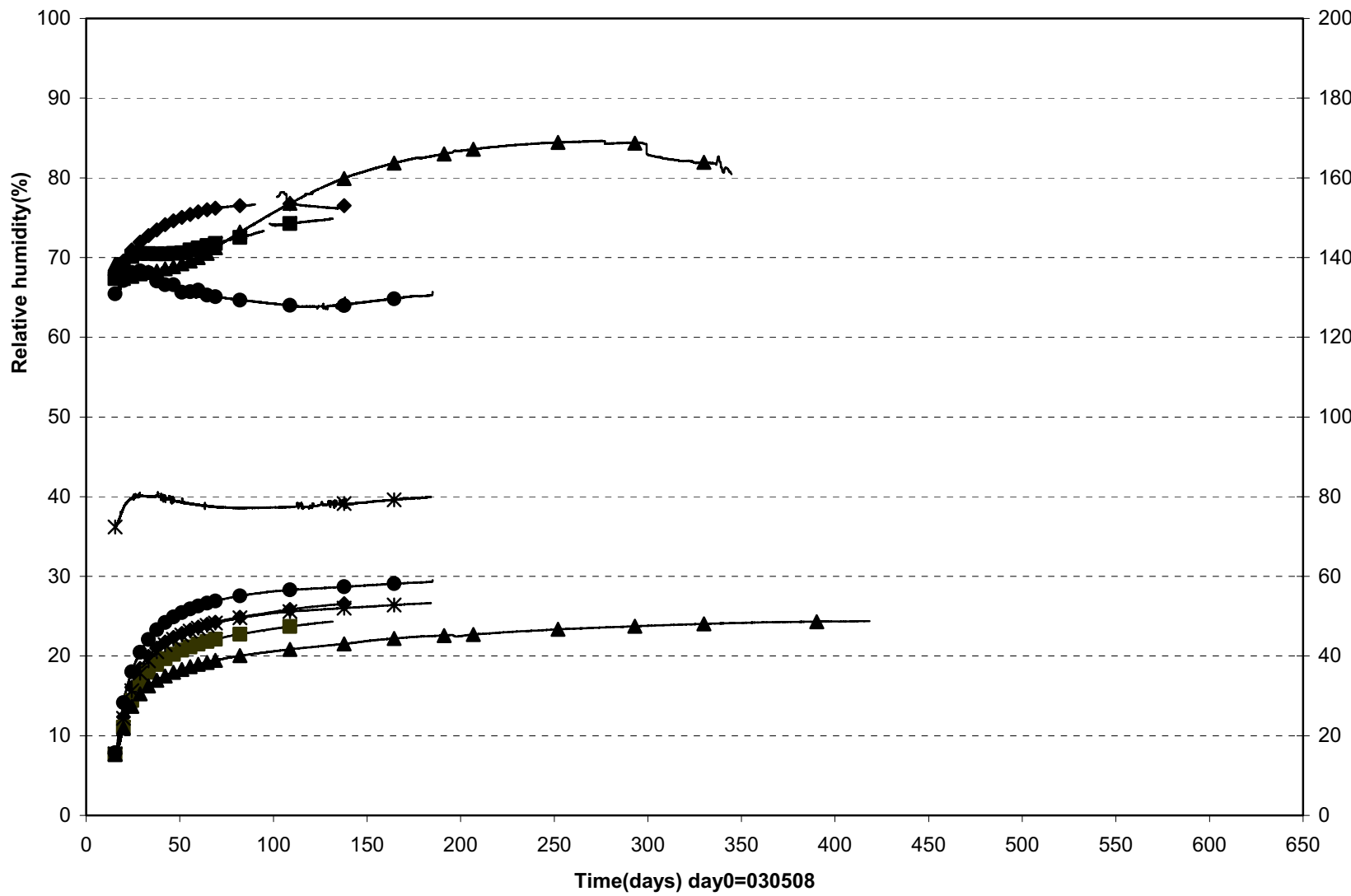

▲ WB667(0.260\280°\0.685) ● WB668(3.300\200°\0.625) ✖ WB669(3.300\200°\0.725) ◆ WB670(4.324\290°\0.625) ■ WB671(4.324\290°\0.725)

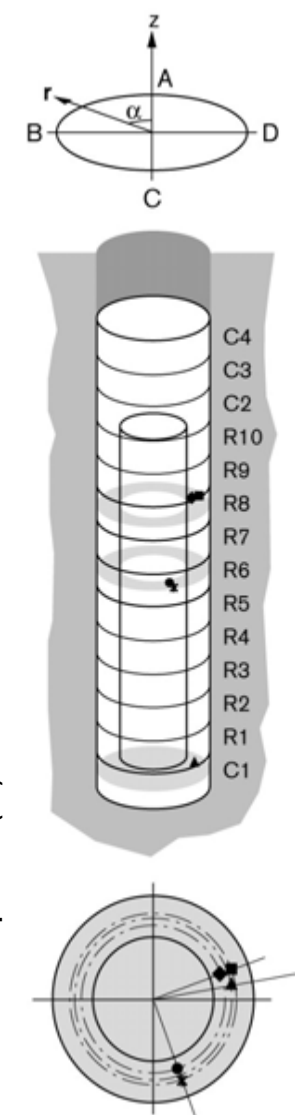

Prototype\ Hole 6 \Rock (030508-041201)
Suction - Wescor

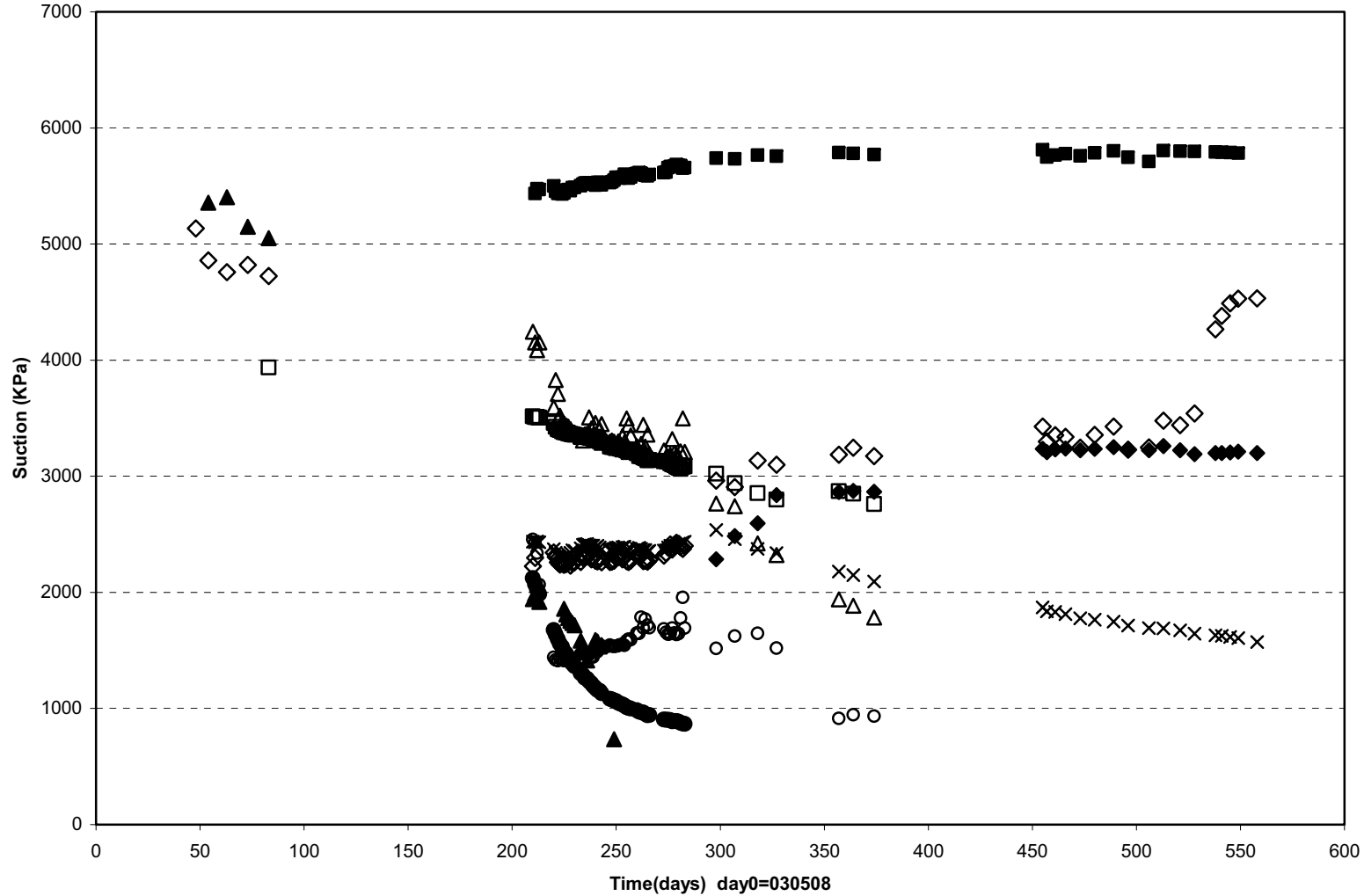

- ◆ WB659(3.100\190°\0.900\Rock)
- ▲ WB661(3.400\190°\0.975\Rock)
- △ WB664(4.100\280°\0.900\Rock)
- WB665(4.250\280°\0.925\Rock)
- ◇ WB666(4.400\280°\0.975\Rock)
- WB619(1.253\305°\0.875\Rock)
- WB633(3.253\305°\0.875\Rock)
- × WB647(4.753\305°\0.875\Rock)

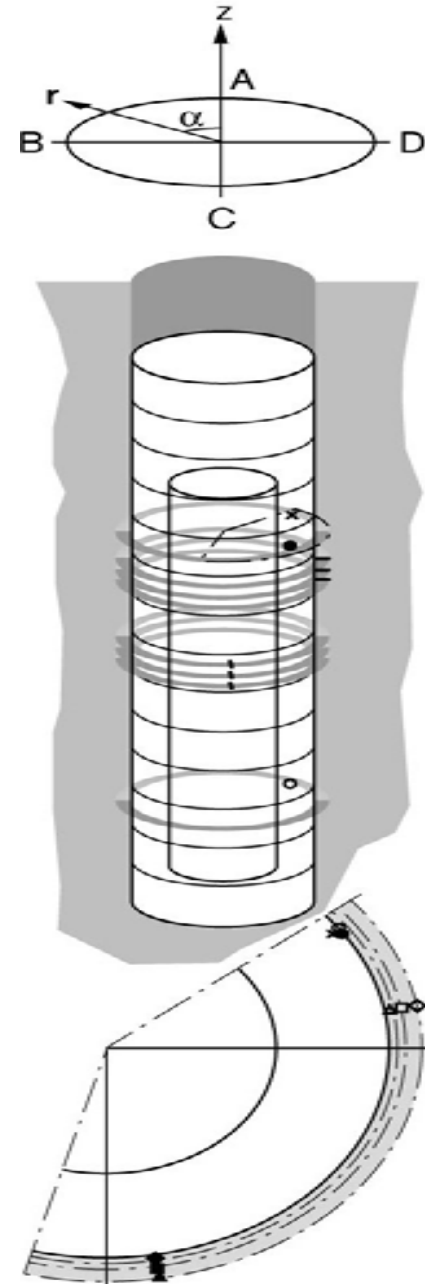

Prototype \ Hole 6 \ Ring 1 and Ring 2 (030508-041201)
Suction - Wescor

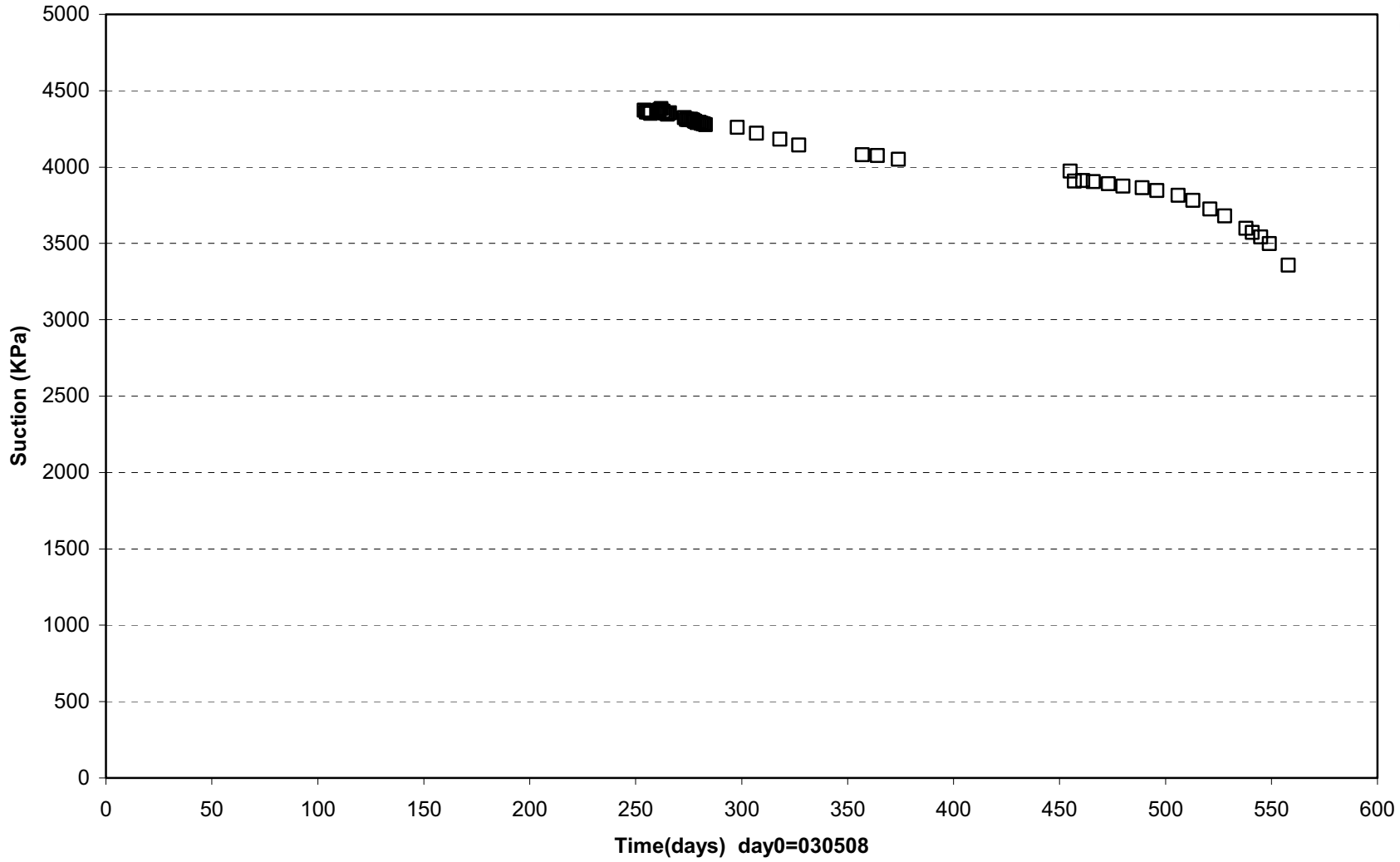

- WB608(0.770\95°\0.685) ◆ WB612(0.750\185°\0.585) □ WB611(0.770\355°\0.785)
- △ WB614(1.284\45°\0.735) ■ WB616(1.284\135°\0.635) ◇ WB618(1.284\235°\0.535)

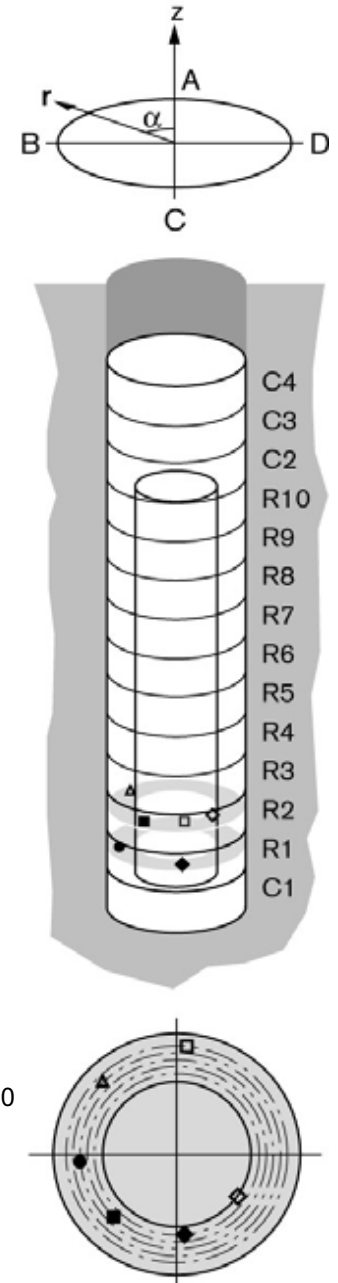

Prototype\Hole6 \Cyl.1 and Ring2 (030508-041201)
 Pore pressure

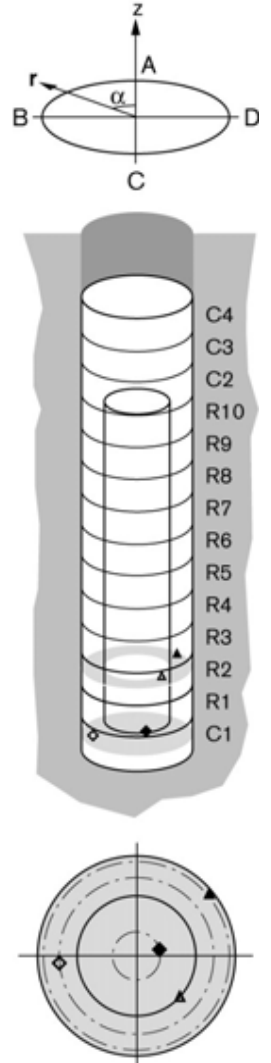
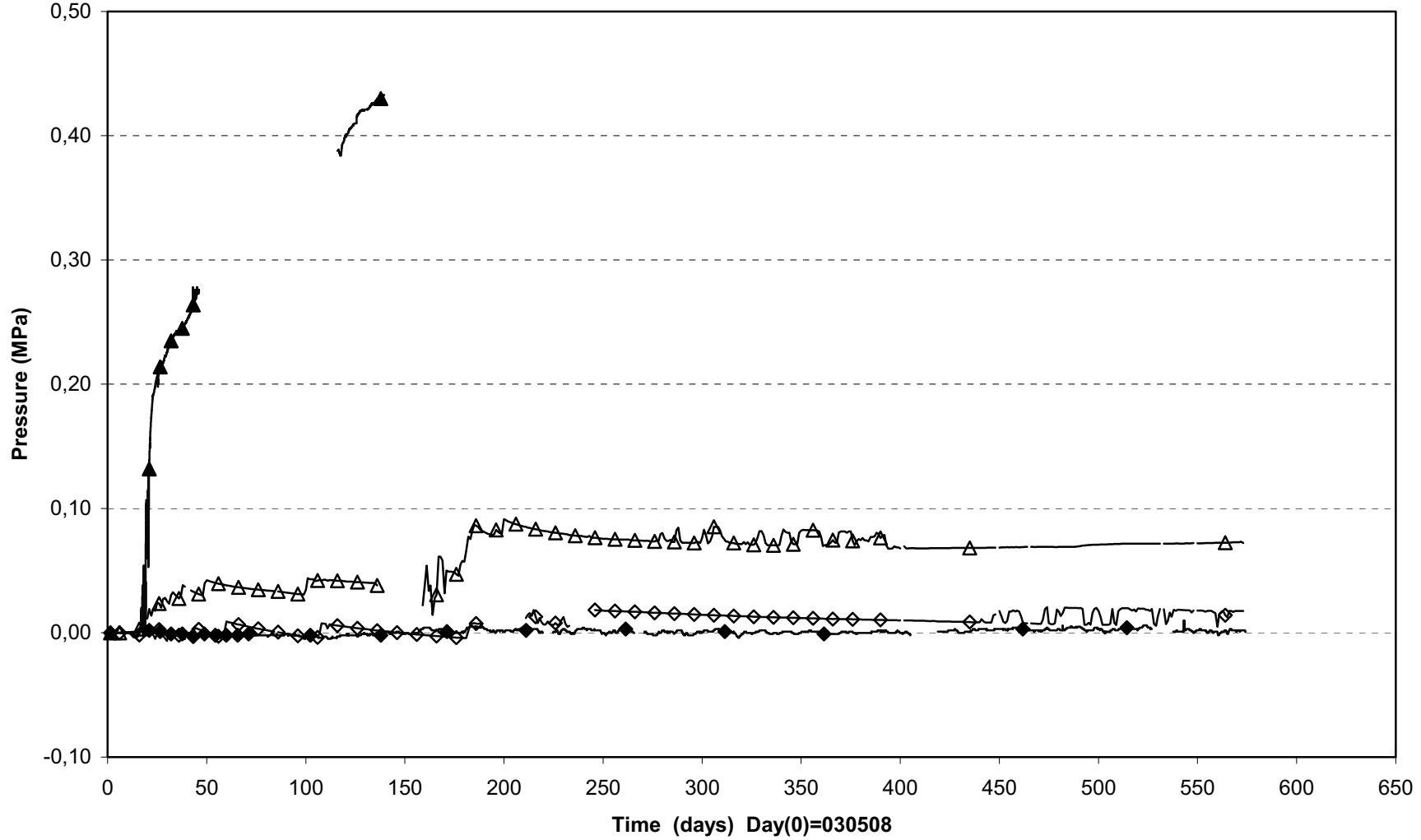

◆ UB601(0.260 \280^\0.210) ◇ UB602(0.260\95^\0.685) △ UB603(1.284\225^\0.535) ▲ UB604(1.253 \310^\0.875)

Prototype\Hole6 \ Ring 5 and Ring 6 (030508-041201)
 Pore pressure

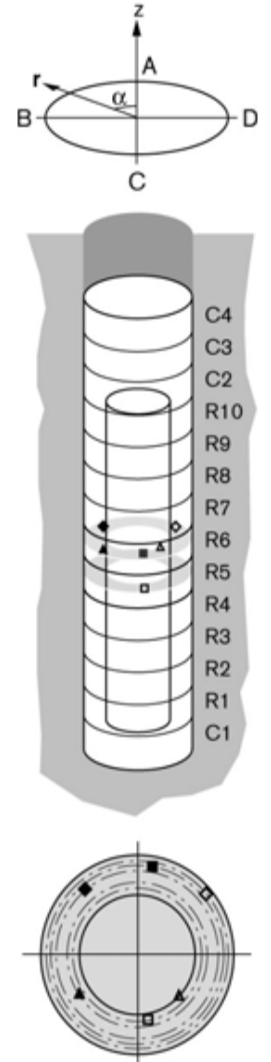
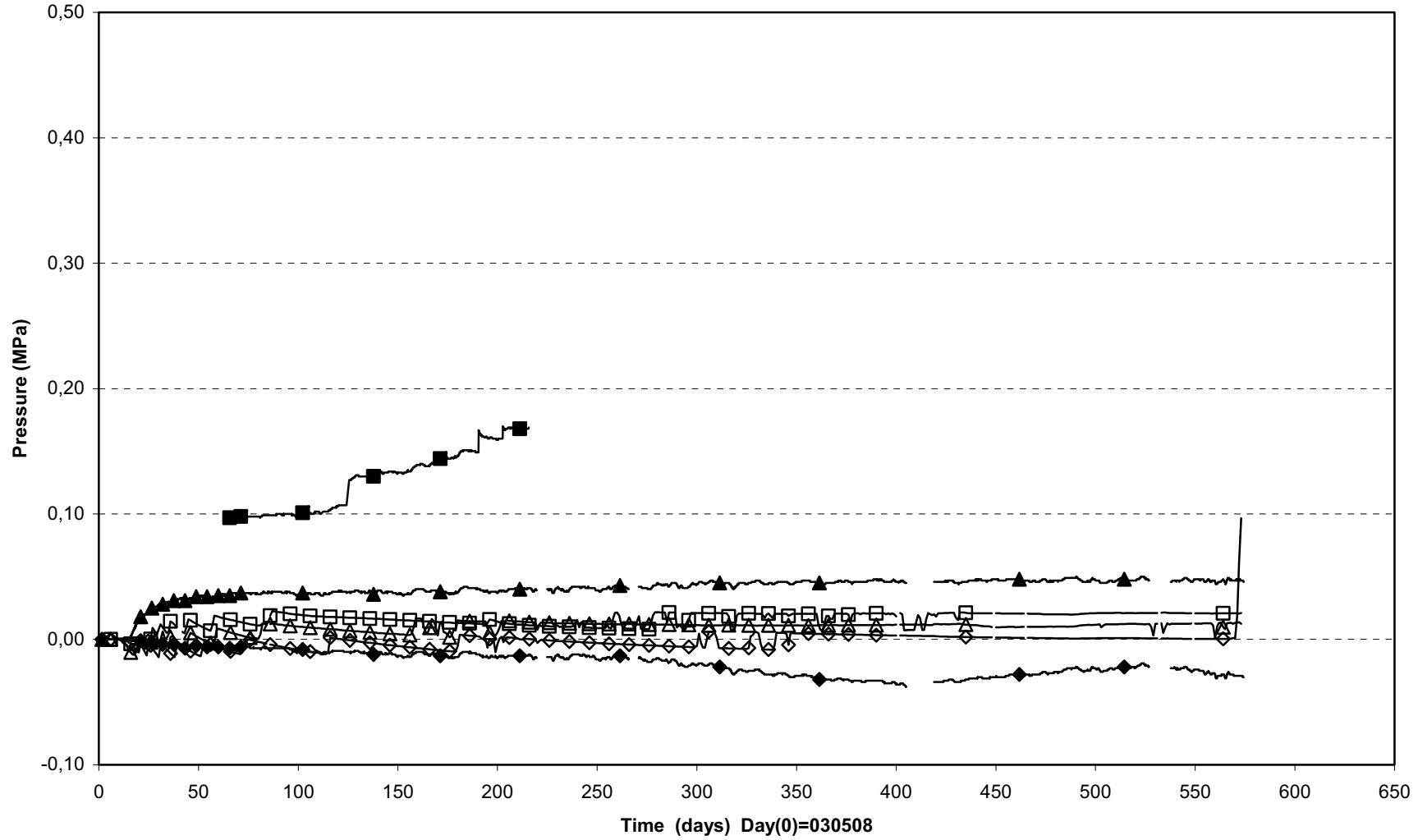

□ UB605(2.795\190°\0.585)	■ UB606(2.795 \350°\ 0.785)	◆ UB607(3.300 \35°\ 0.735)
▲ UB608(3.300 \125°\ 0.635)	△ UB609(3.300\225°\0.535)	◇ UB610(3.253\310°\0.875)

Prototype\Hole6\Ring 9 , Cyl.3 and Cyl.4 (030508-041201)
 Pore pressure

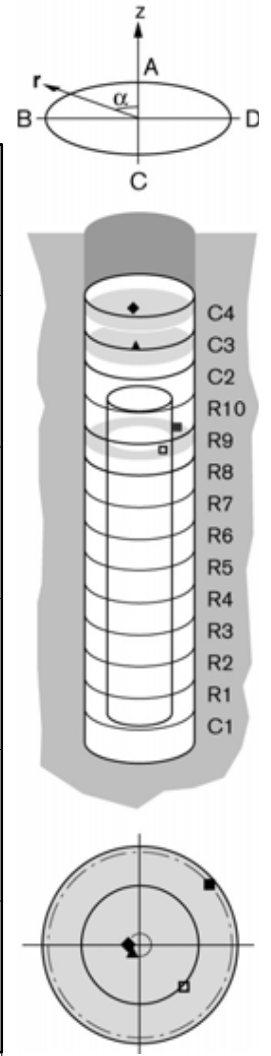
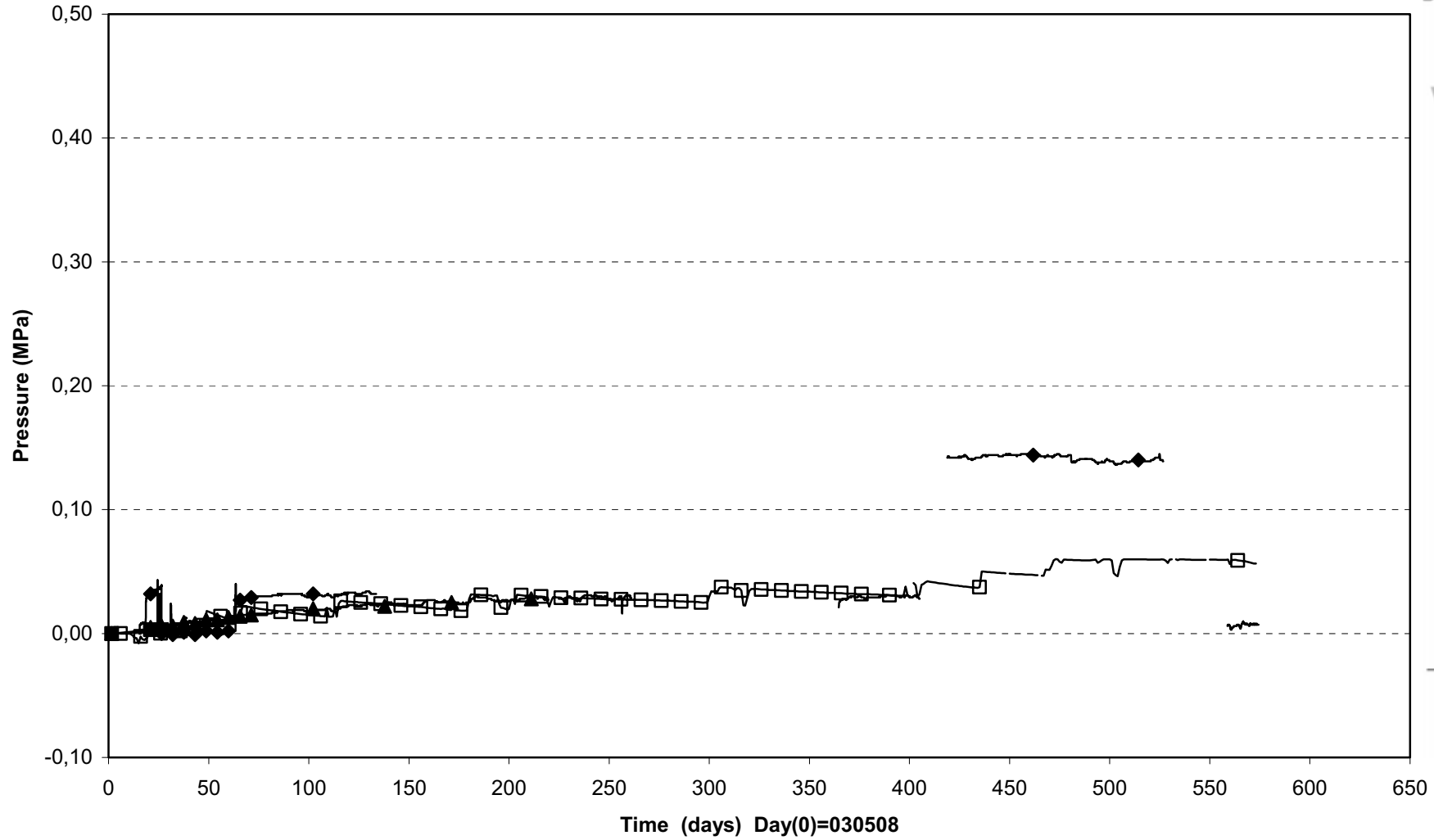

□ UB611(4.834\225°\0.535)
■ UB612(4.753 \310°\ 0.875)
▲ UB613(6.366 \135°\ 0.100)
◆ UB614(6.961 \90°\ 0.100)

Prototype\Hole 6\Cyl.1 and Ring1 (030508-041201)
 Temperature - Pentronic

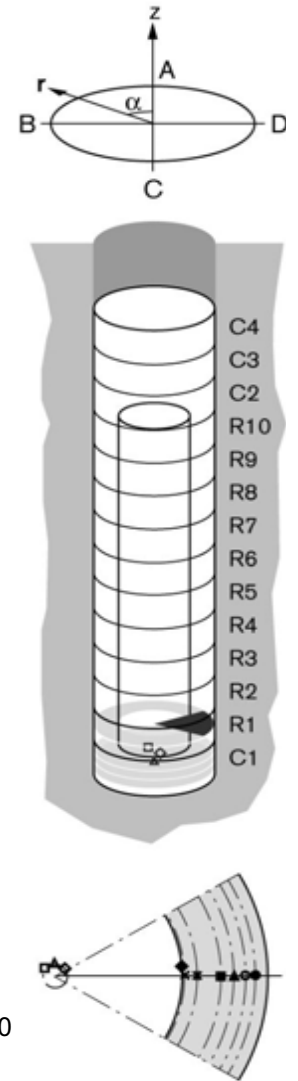
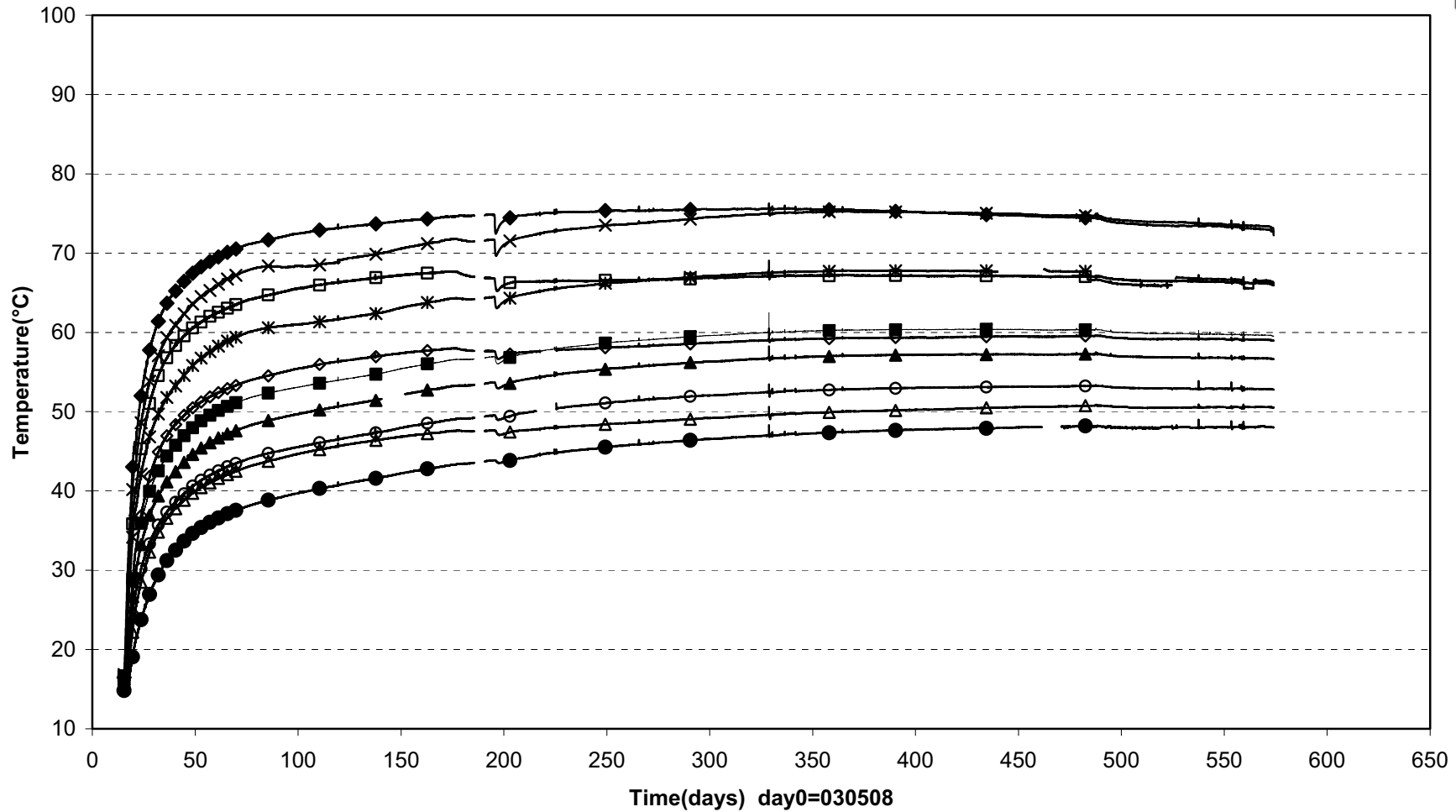

Prototype\Hole 6 \Ring5 (030508-041201)
 Temperature - Pentronic

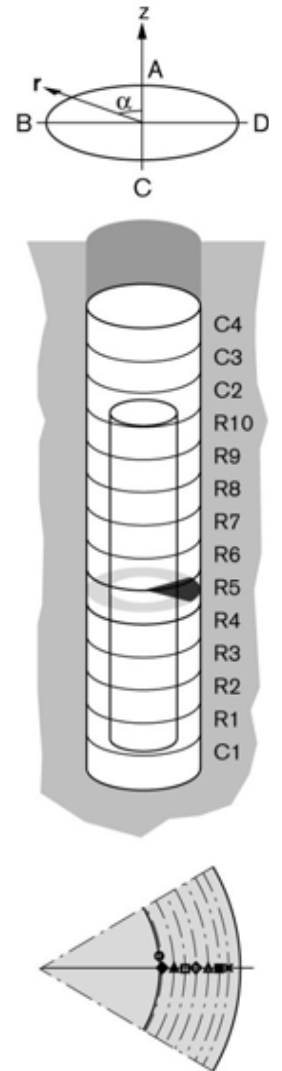
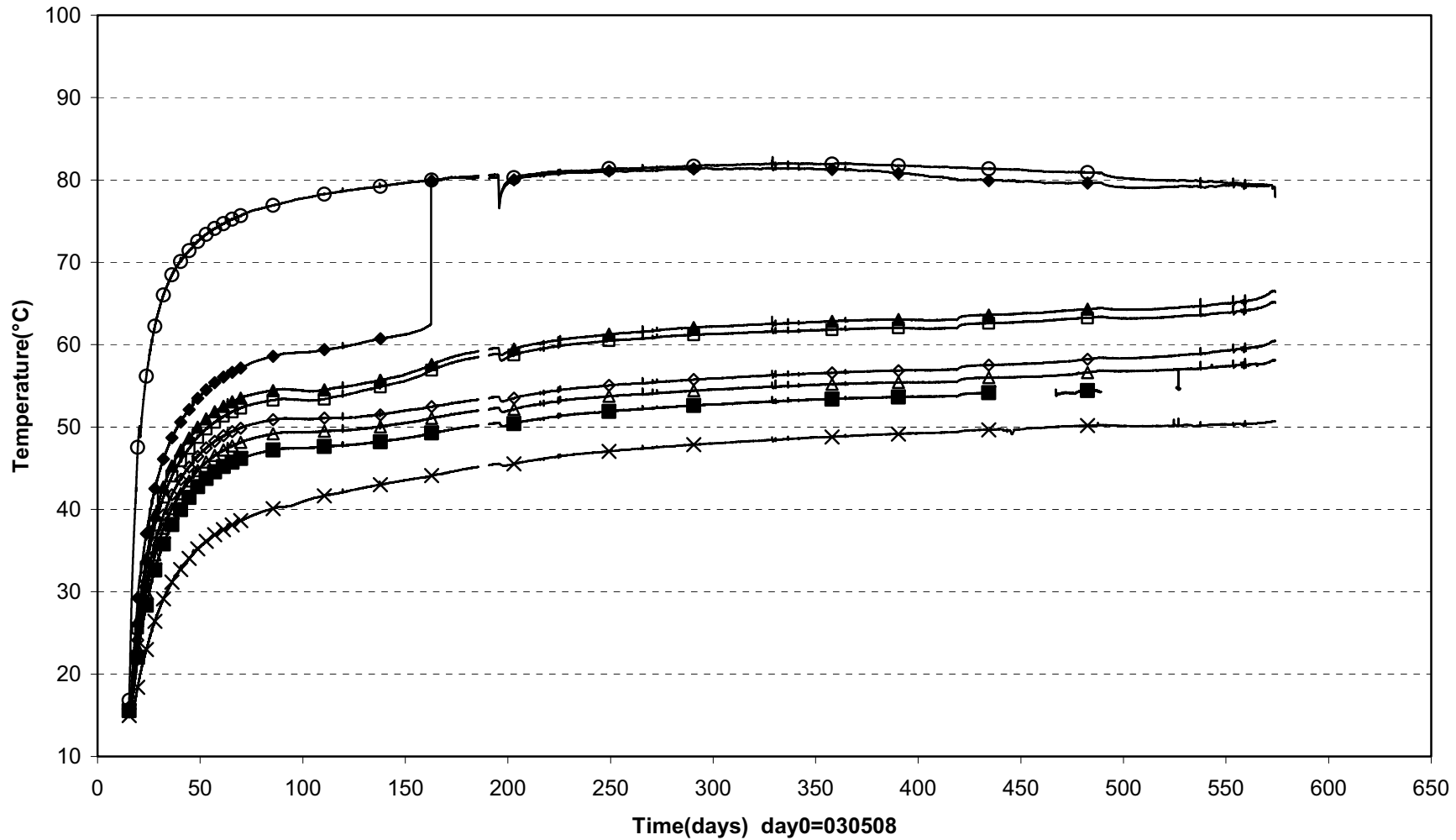

◆ TB612(2.795\270°\0.535) ▲ TB613(2.795\270°\0.585) □ TB614(2.795\270°\0.635) ◇ TB615(2.795\270°\0.685) △ TB616(2.795\270°\0.735)
 ■ TB617(2.795\270°\0.785) × TB618(2.753\270°\0.875) ○ TB619(2.753\ 0°\0.525)

Prototype\Hole 6 \Ring8 (030508-041201)
 Temperature - Pentronic

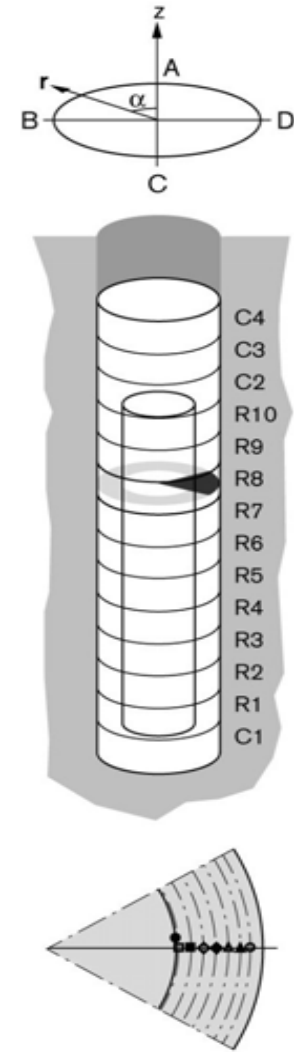
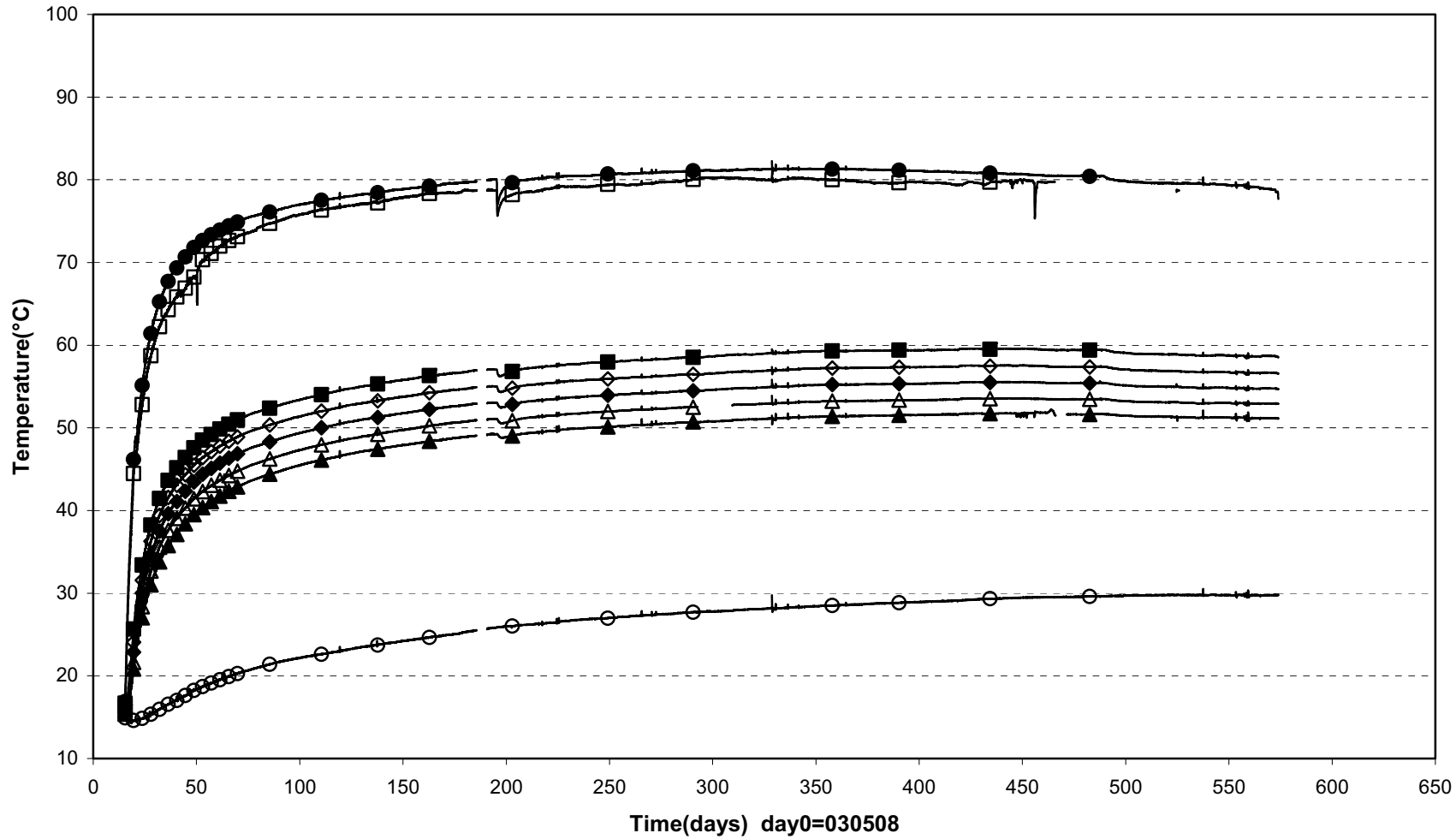

□ TB620(4.324\270°\0.535) ■ TB621(4.324\270°\0.585) ◇ TB622(4.324\270°\0.635) ◆ TB623(4.324\270°\0.685) △ TB624(4.324\270°\0.735)
 ▲ TB625(4.324\270°\0.785) ○ TB626(4.253\270°\0.875) ● TB627(4.253\0°\0.525)

Prototype\Hole 6 \Cyl.3 and Cyl.4 (030508-041201)
 Temperature - Pentronic

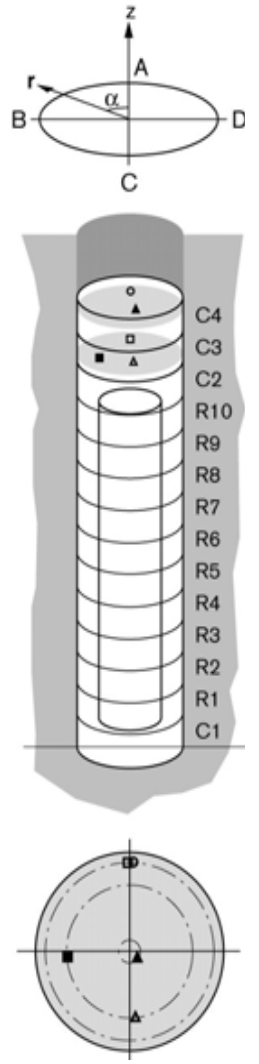
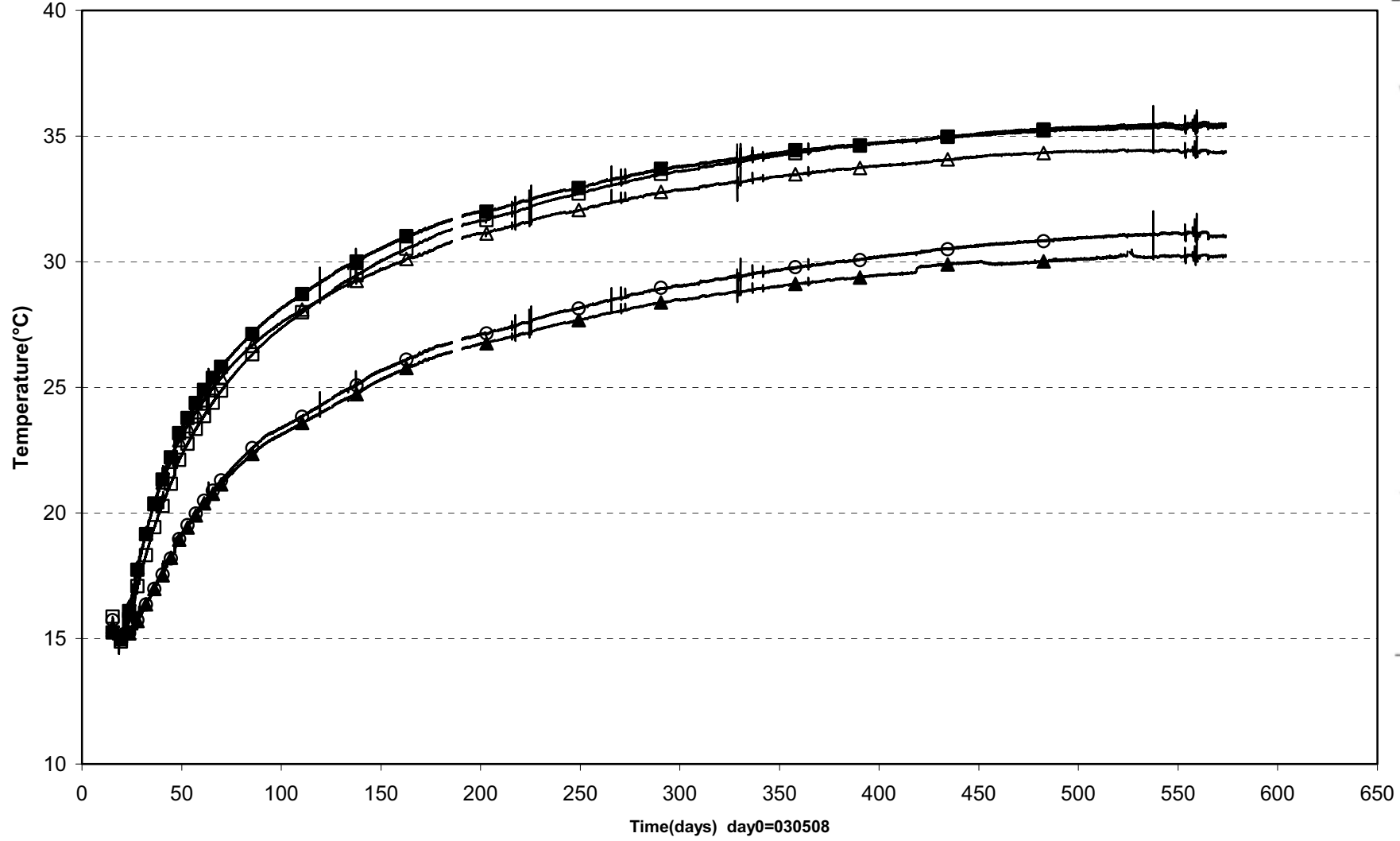

□ TB628(6.366\0°\0.785) ■ TB629(6.366\95°\0.585) △ TB630(6.366\185°\0.585) ▲ TB631(7.071\225°\0.100) ○ TB632(7.071\0°\0.785)

Prototype\Hole 6\Cyl.1 and Ring2 (030508-041201)
 Temperature - Geokon

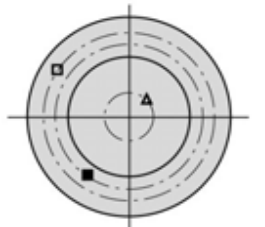
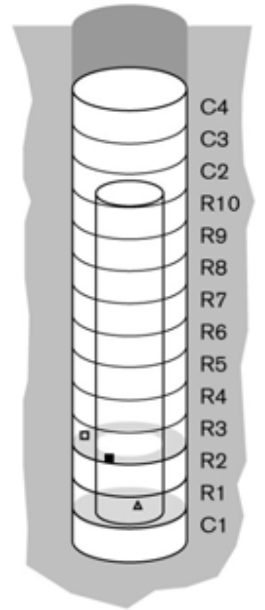
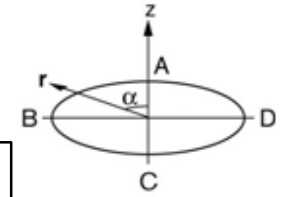
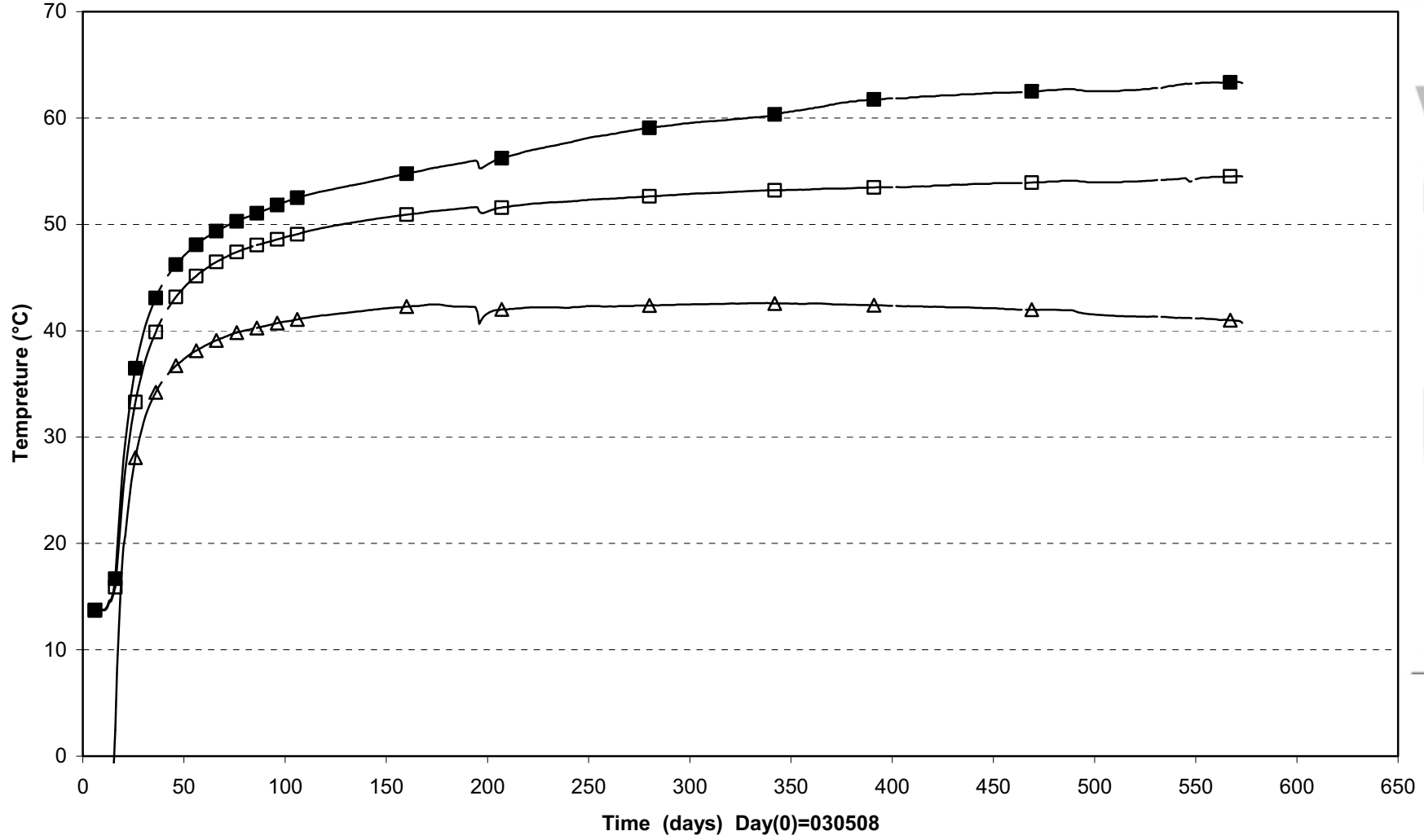

△ PB601T(0.510\315°\0.210)
□ PB606T(1.534\55°\0.735)
■ PB607T(1.534\145°\0.635)

Prototype\Hole 6\ Ring6 (030508-041201)
 Temperature - Geokon

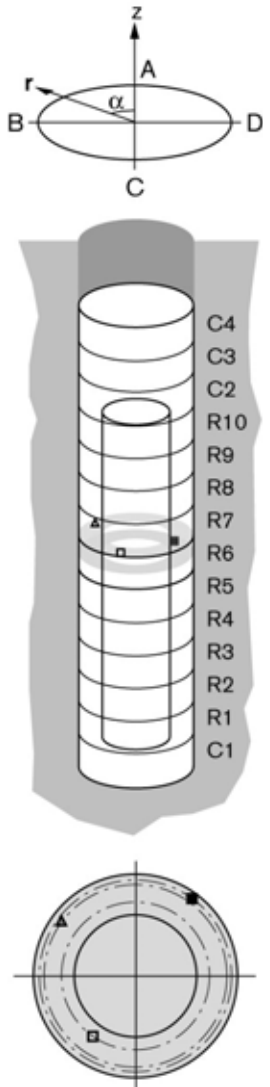
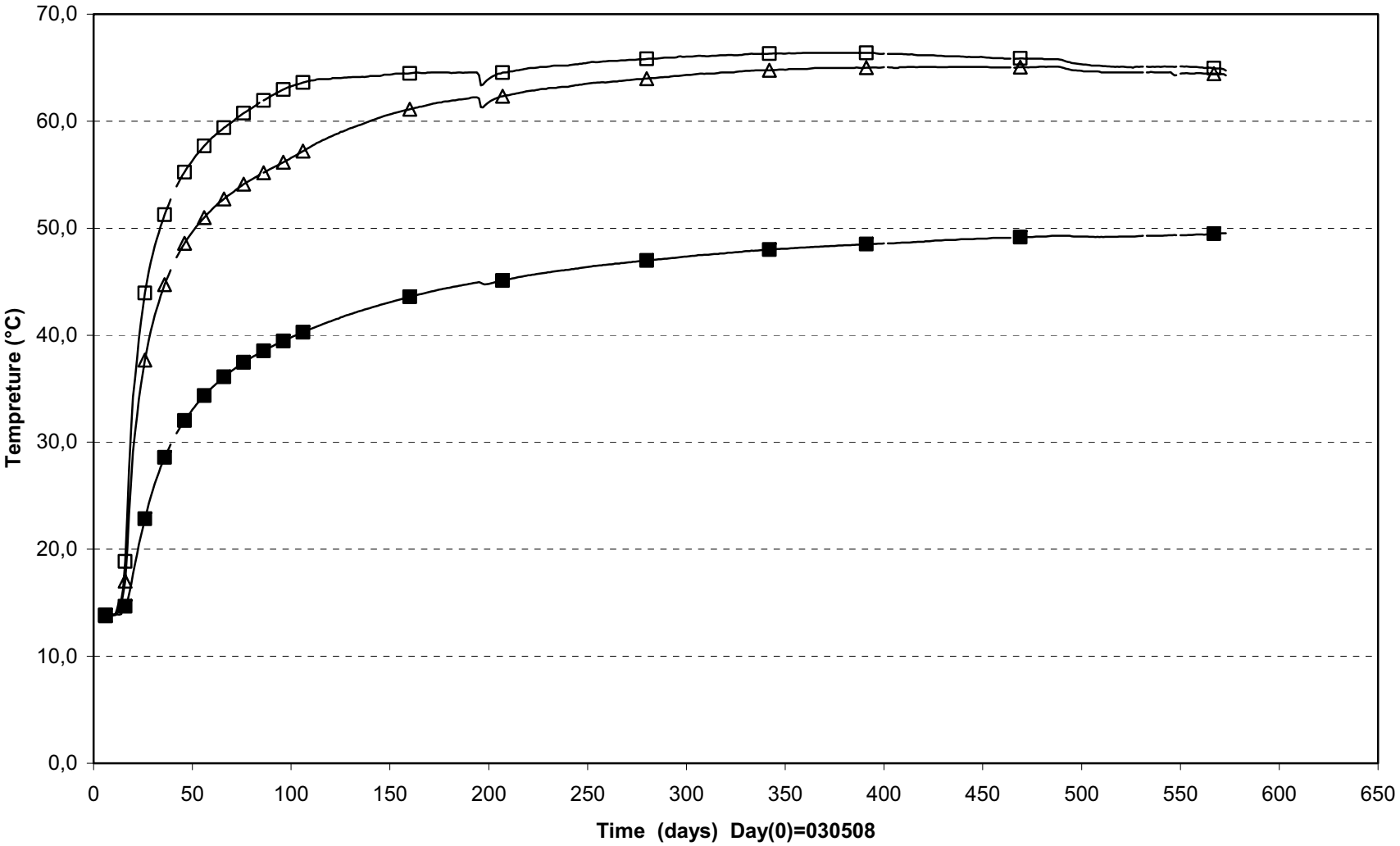

△ PB613T(3.550\55°\0.785)

 □ PB614T(3.550\145°\0.635)

 ■ PB616T(3.253\325°\0.875)

Prototype\Hole 6\ Ring9 (030508-041201)
 Temperature - Geokon

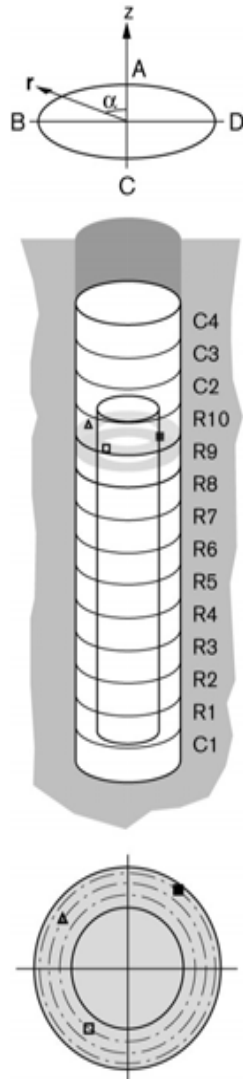
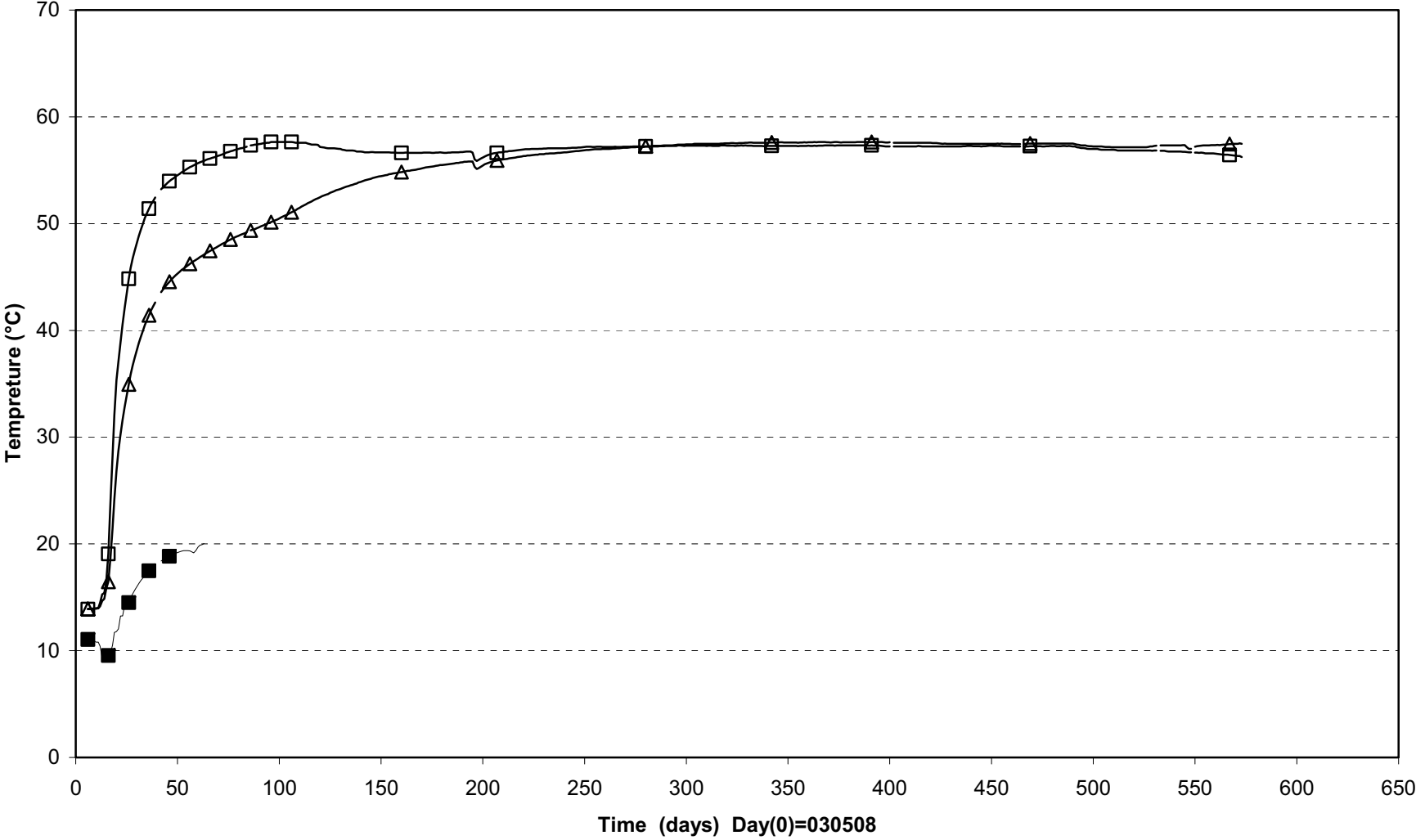

△ PB620T(5.084\55°\0.735)
□ PB621T(5.084\145°\0.635)
■ PB623T(4.753\325°\0.875)

Prototype\Hole 6\Cyl.3 and Cyl.4 (030508-041201)
 Temperature - Geokon

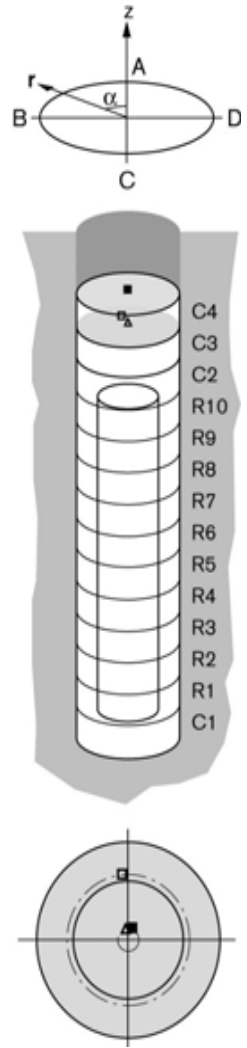
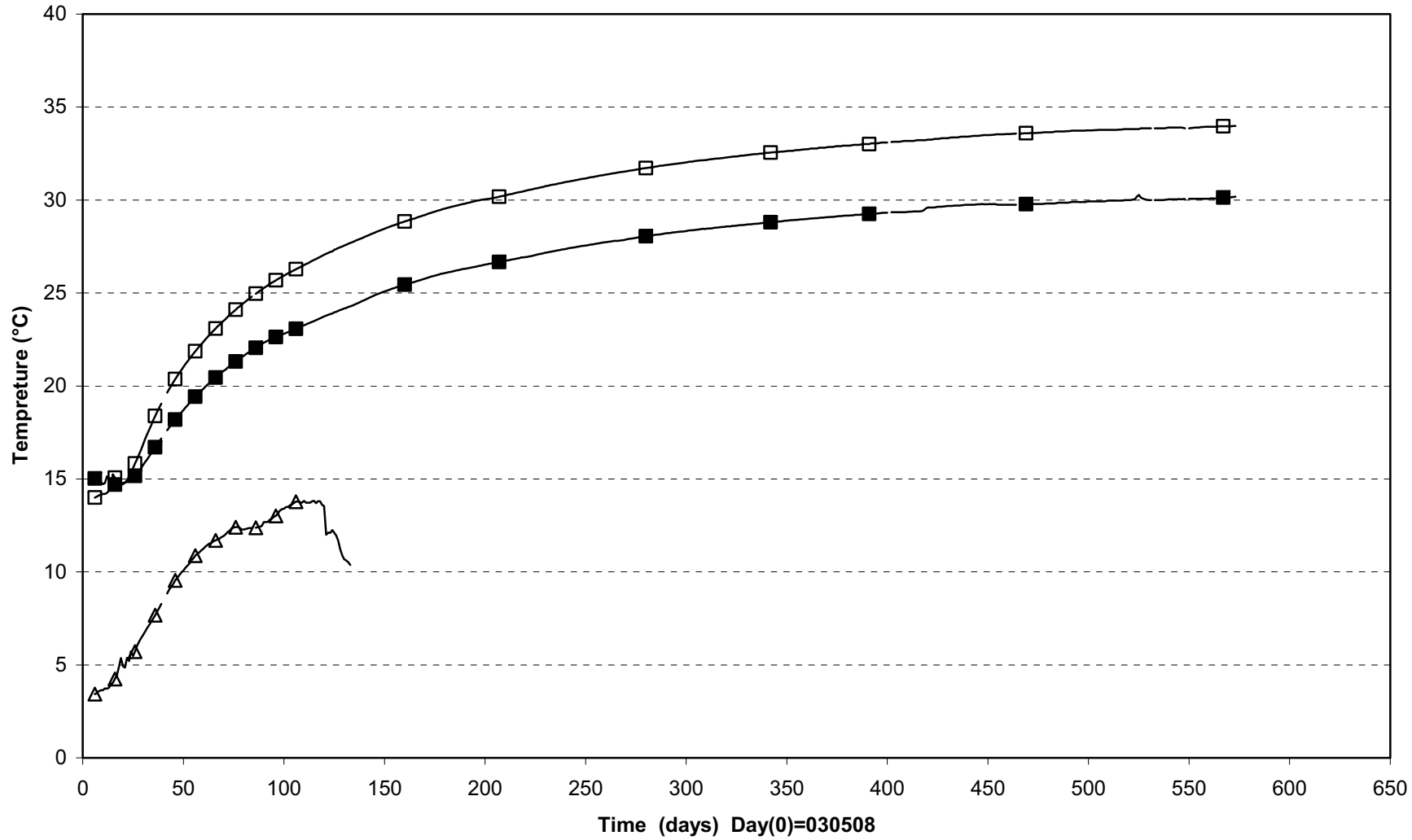

△ PB625T(6.616\0°\0.100) □ PB626T(6.616\5°\0.585) ■ PB627T(7.121\0°\0.100)

Prototype\Hole6 (030508-041201)
Temperature- Geokon

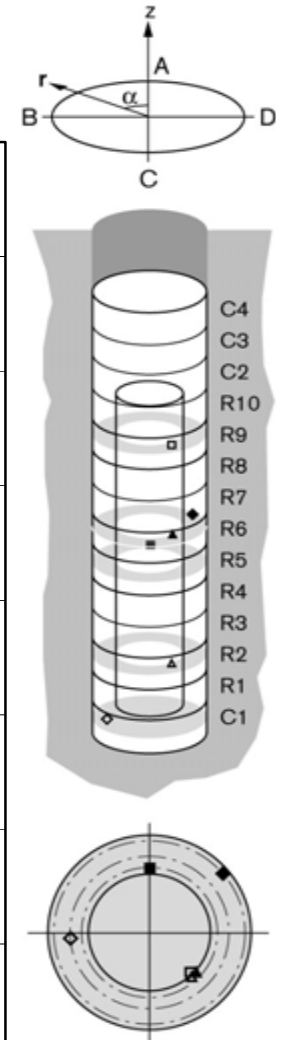
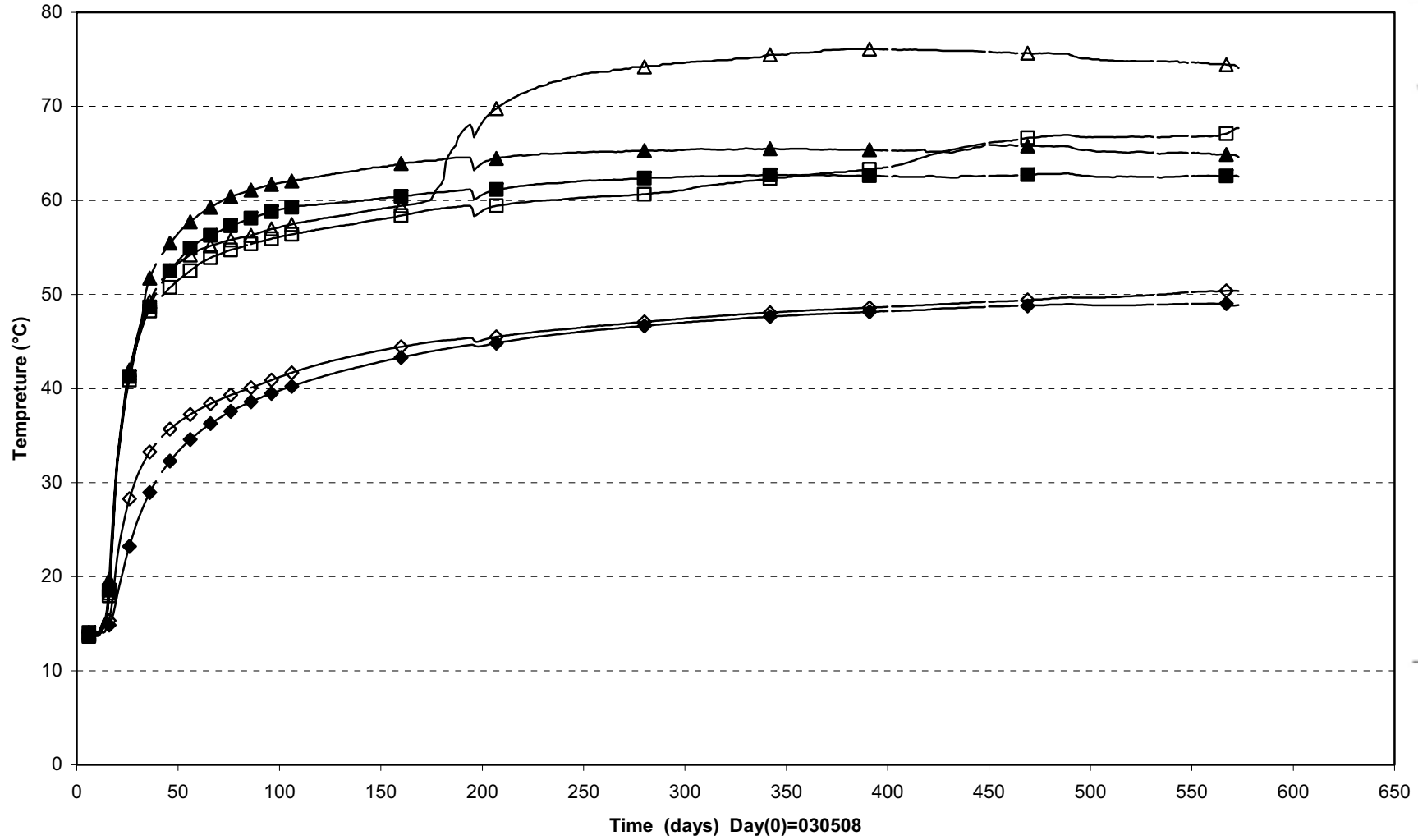

◇ UB602T(0.260\95°\0.685)	△ UB603T(1.284\225°\0.535)	■ UB605T(2.795\190°\0.585)
▲ UB609T(3.300\225°\0.535)	◆ UB610T(3.253\310°\0.875)	□ UB611T(4.834\225°\0.535)

Prototype\Rock\Hole 6\ Level bottom (030508-041201)
 Temperature - Pentronic

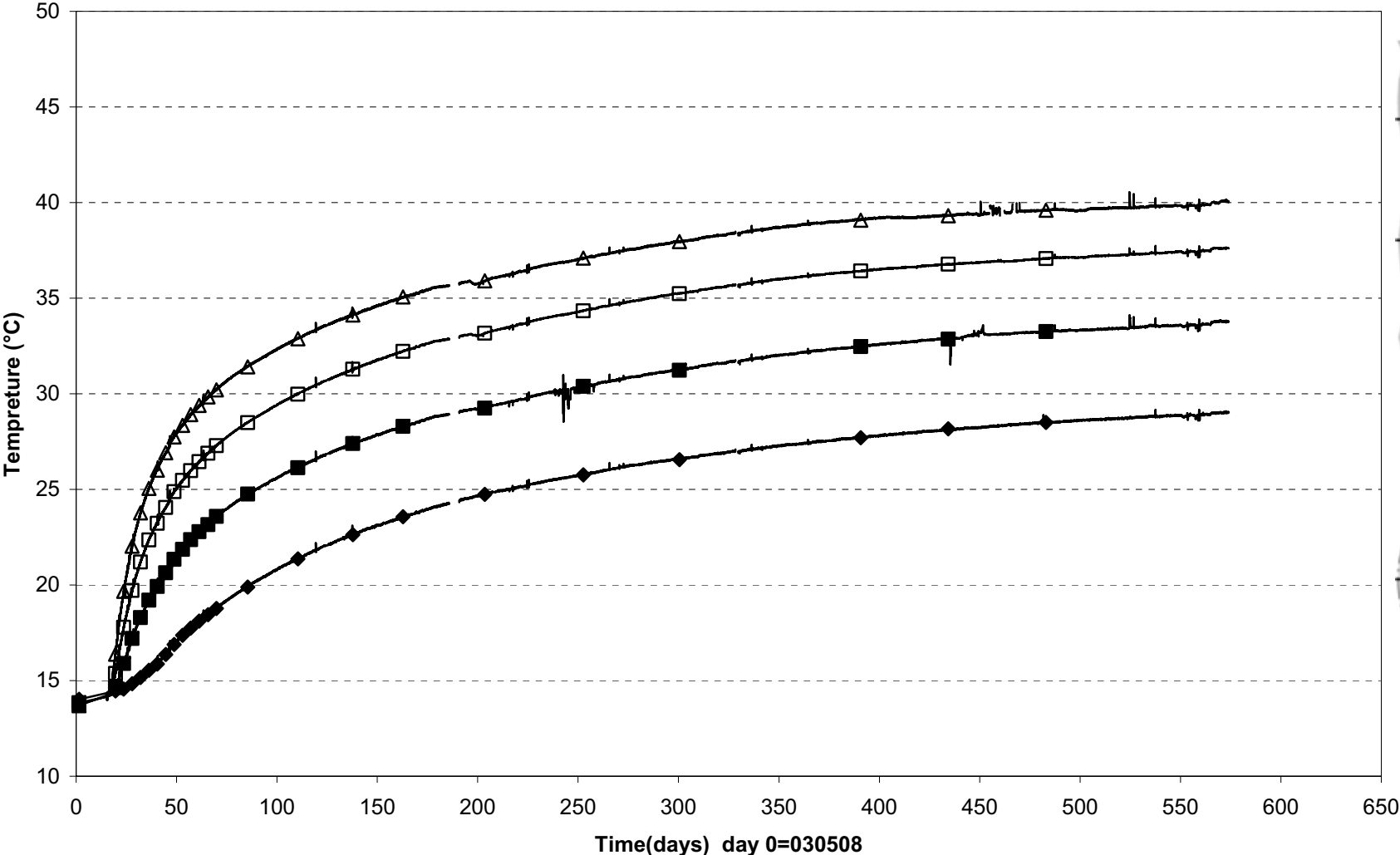

■ TR6011(-1.0\0^\ 0.0) □ TR6012(-0.5\0^\ 0.0) △ TR6013(-0.2\0^\ 0.0) ◆ TR6014(0.0\0^\ 0.0)

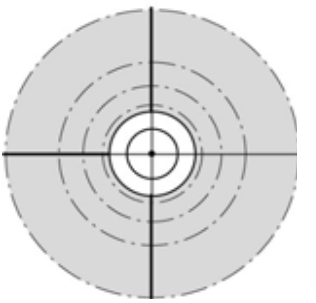
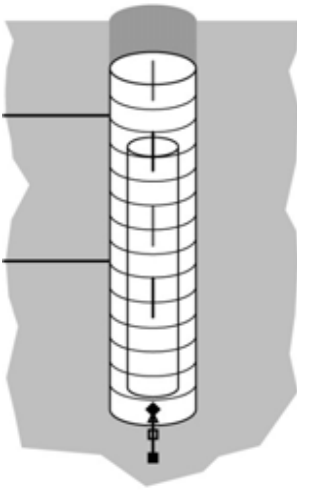
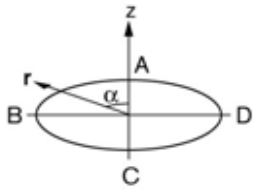

Prototype\Rock\Hole 6 \ Level 3,0 m (030508-041201)
 Temperature - Pentronic

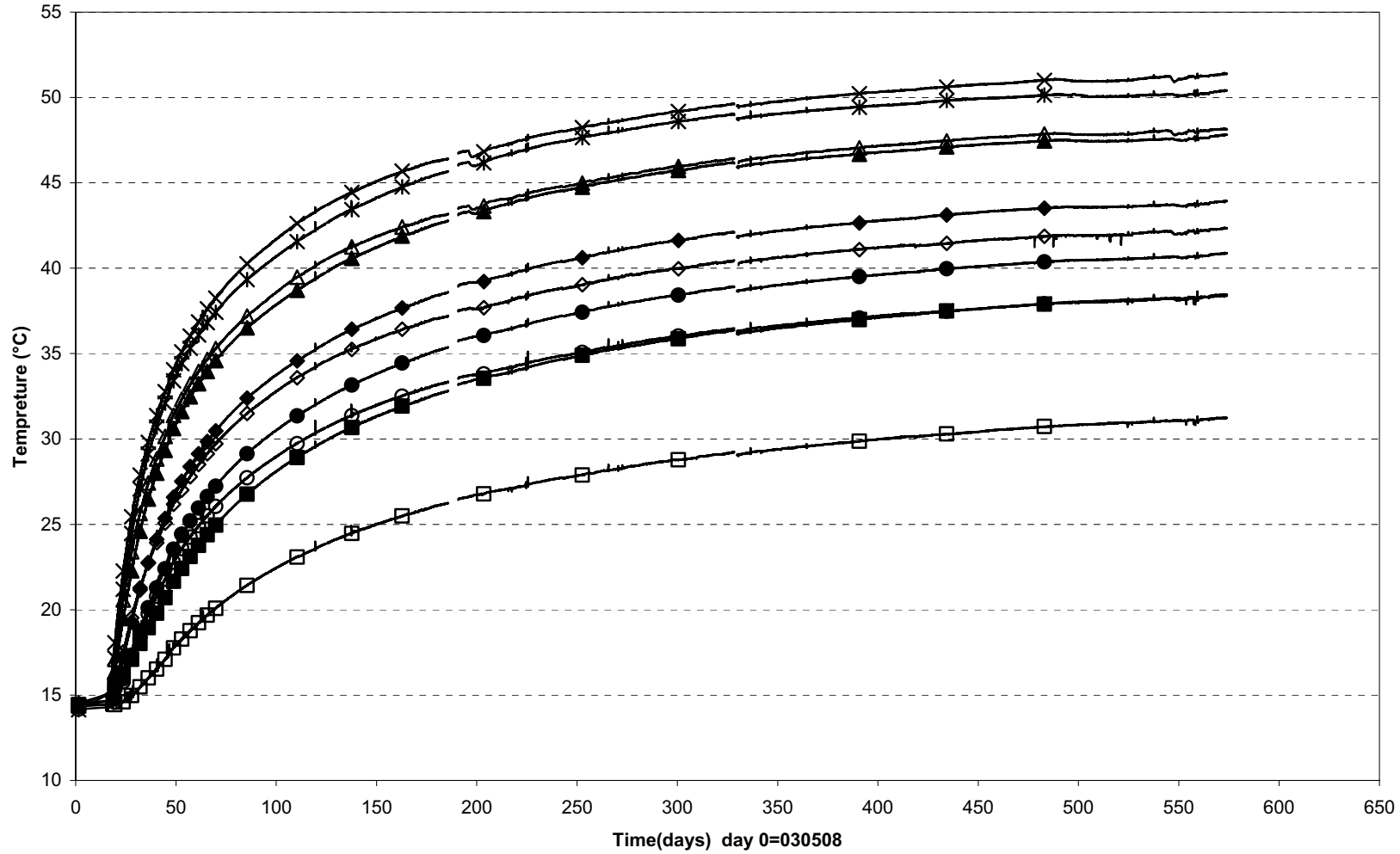

- TR6041(3.0\90°\ 3.95) ○ TR6042(3.0\90°\ 2.85) ◇ TR6043(3.0\90°\ 2.35) △ TR6044(3.0\90°\ 1.95) × TR6045(3.0\90°\ 1.75)
- TR6051(3.0\360°\3.95) ● TR6052(3.0\360°\2.85) ◆ TR6053(3.0\360°\2.35) ▲ TR6054(3.0\360°\1.95) ✱ TR6055(3.0\360°\1.75)

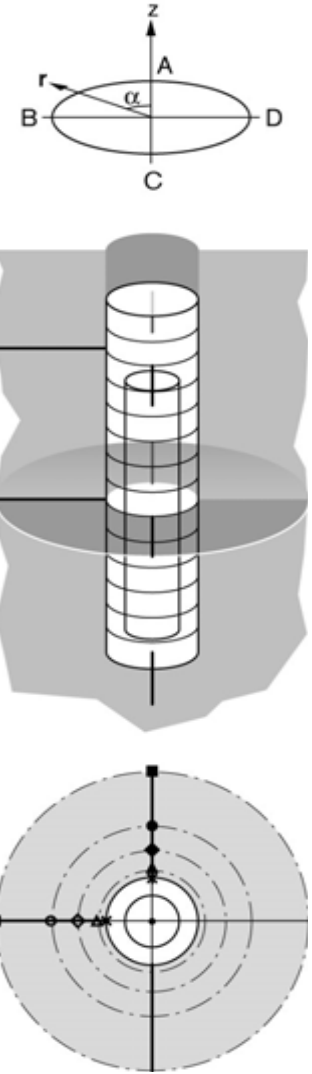

Prototype\Rock\Hole 6\ Level 6,0 m (030508-041201)
 Temperature - Pentronic

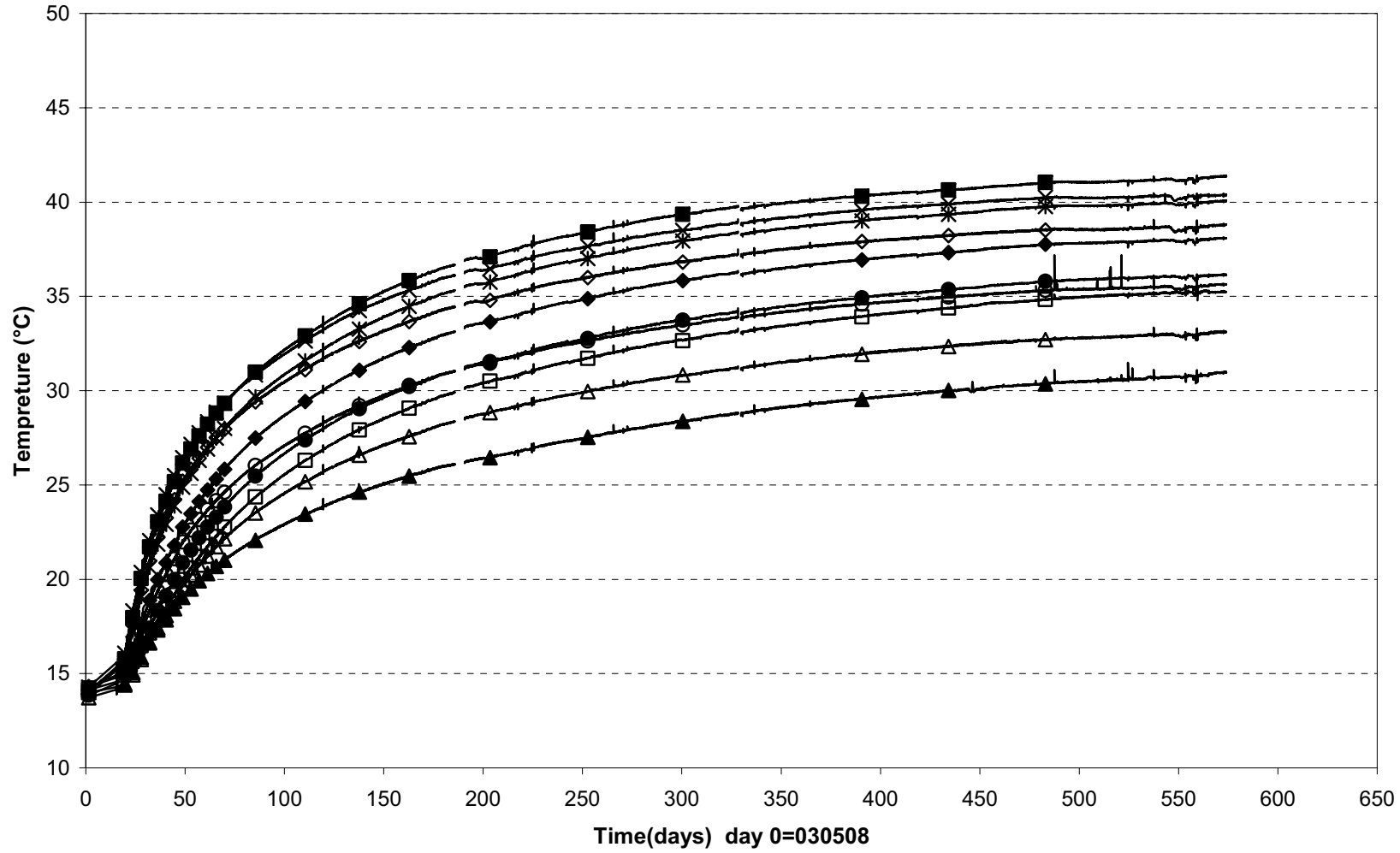

△ TR6021(6.0\90°\ 3.95) ○ TR6022(6.0\90°\ 2.85) ◇ TR6023(6.0\90°\ 2.35) × TR6024(6.0\90°\ 1.95) □ TR6025(6.0\90°\ 1.75)
 ▲ TR6031(6.0\360°\ 3.95) ● TR6032(6.0\360°\ 2.85) ◆ TR6033(6.0\360°\ 2.35) ✱ TR6034(6.0\360°\ 1.95) ■ TR6035(6.0\360°\ 1.75)

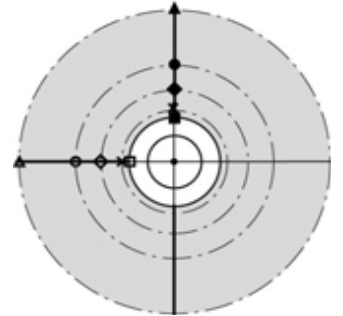
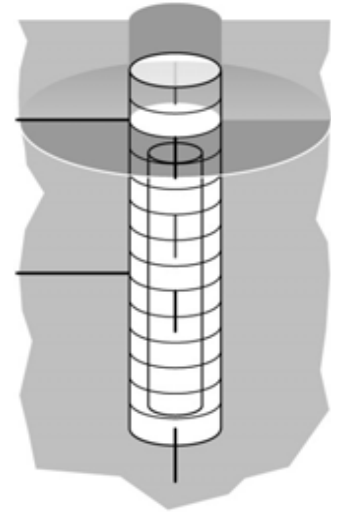
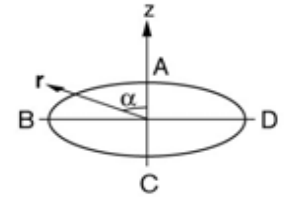

Prototype\Hole 6 (030508-041201)
Canister power

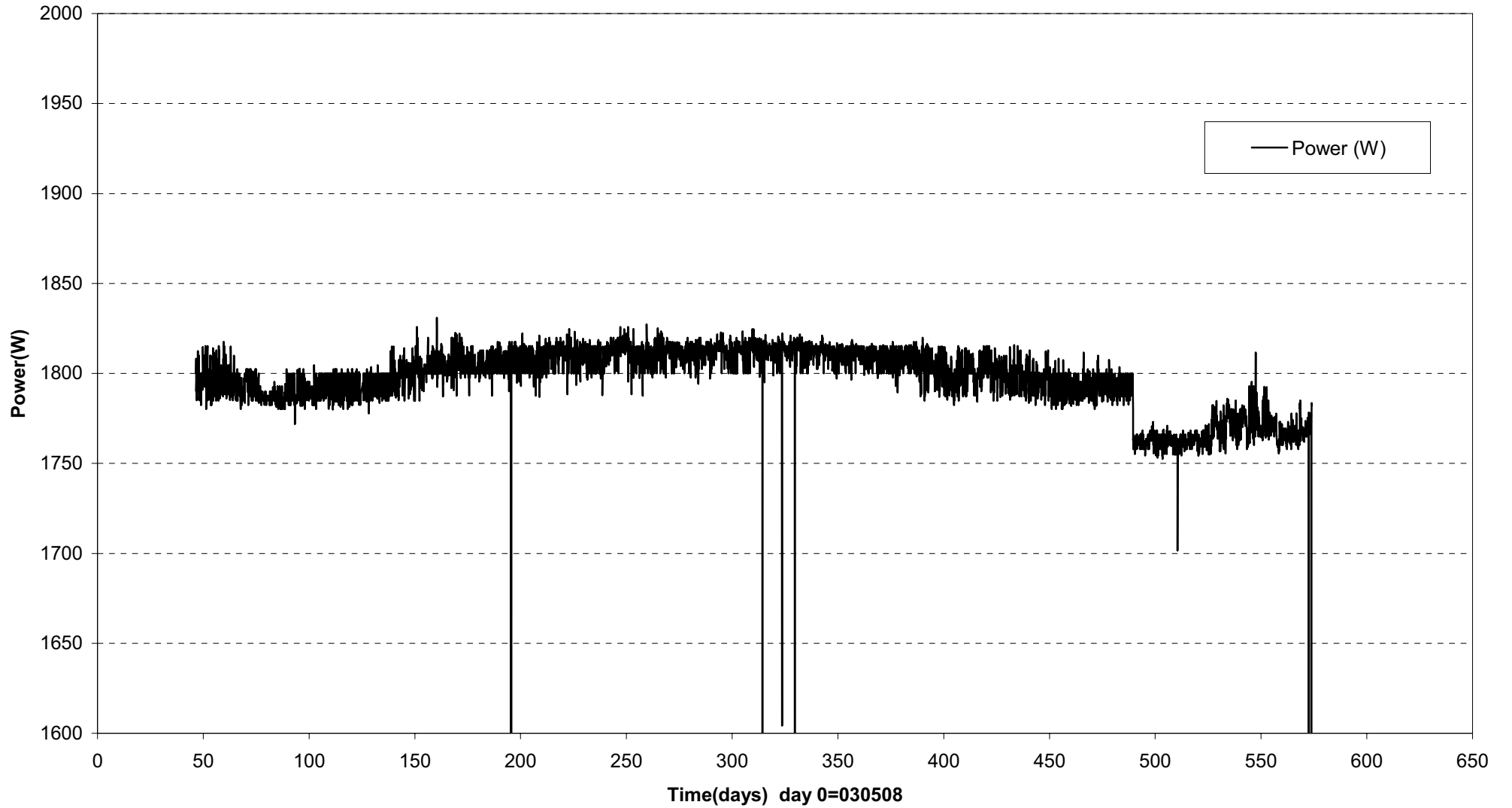

Prototype\ Hole 6 \Canister (030508-041201)
 Max. temperature on the canister surface - Optical fiber cables

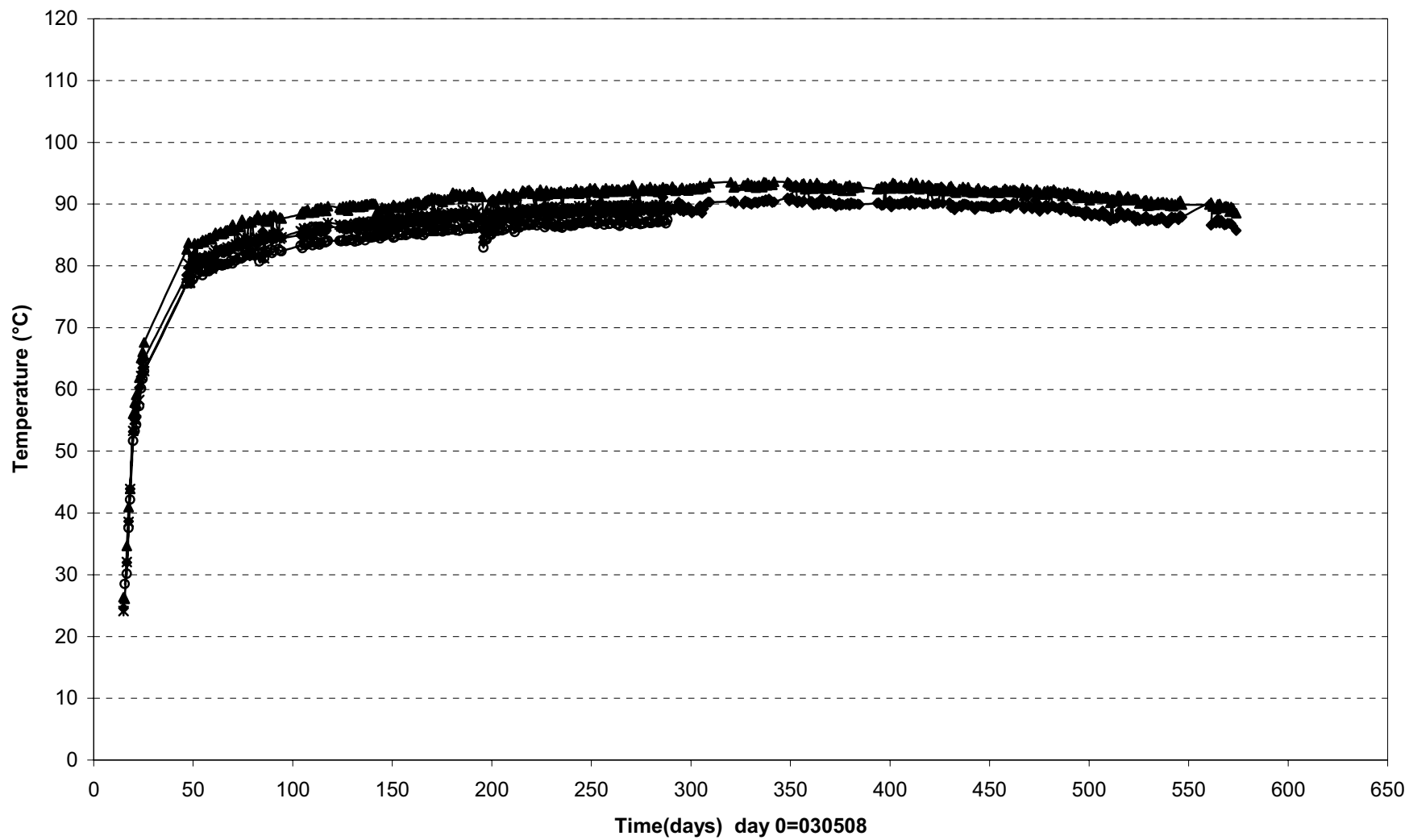

—○— Cable 1, outlet °C —*— Cable 1, inlet °C —▲— Cable 2, outlet °C —◆— Cable 2, inlet °C

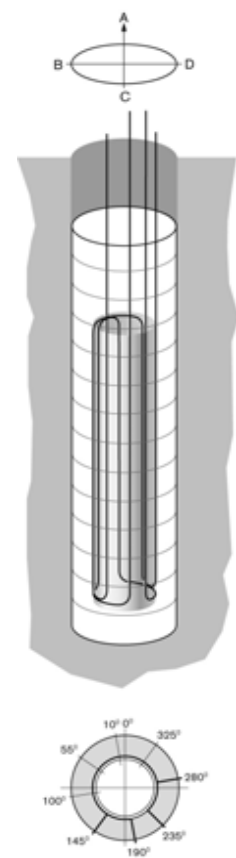

Temperature profile on the canister surface-No6 (041201)
Optical fiber cables

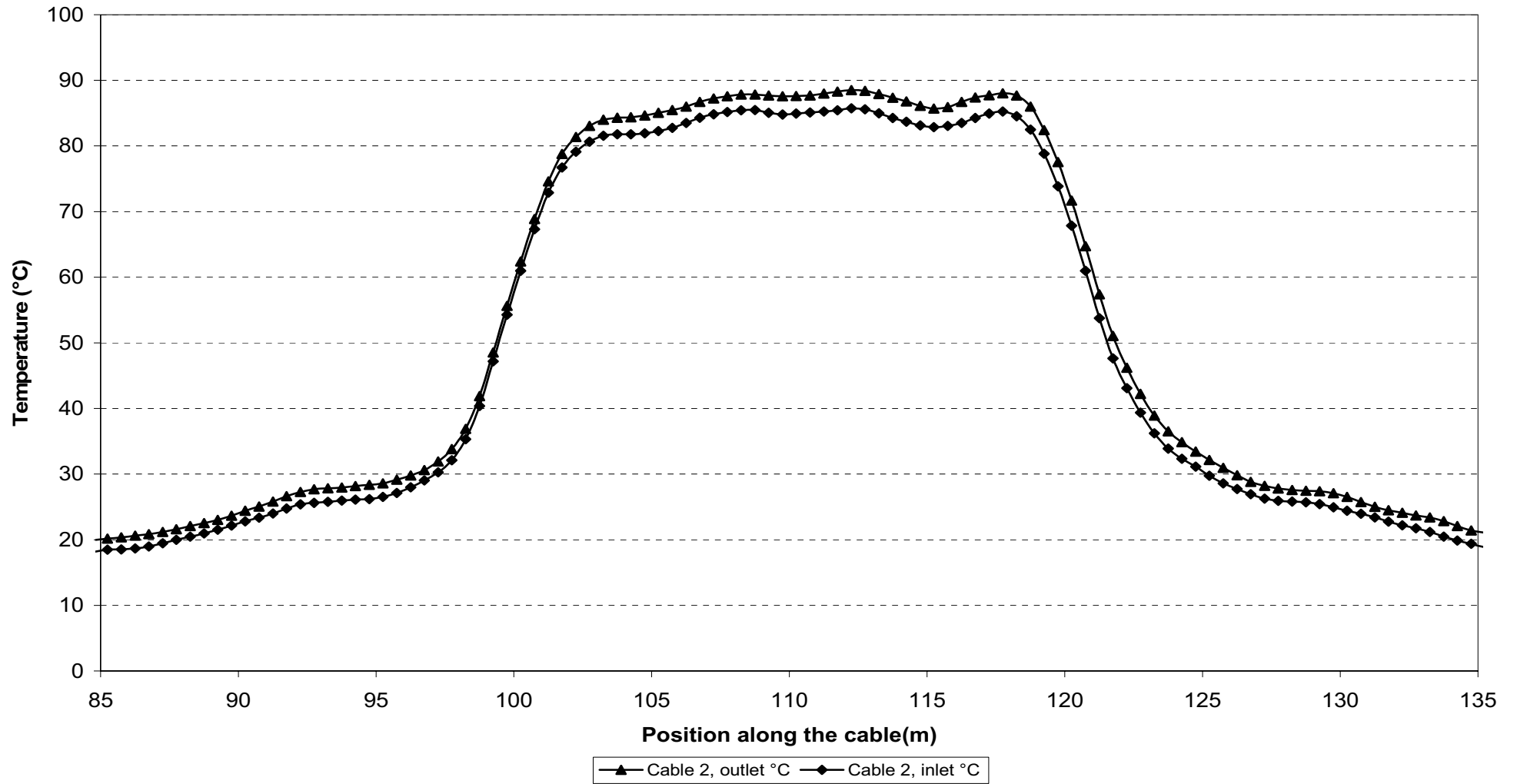

Prototype\Hole 6 \On the canister surface (030508-041201)
 Temperature - Pentronic

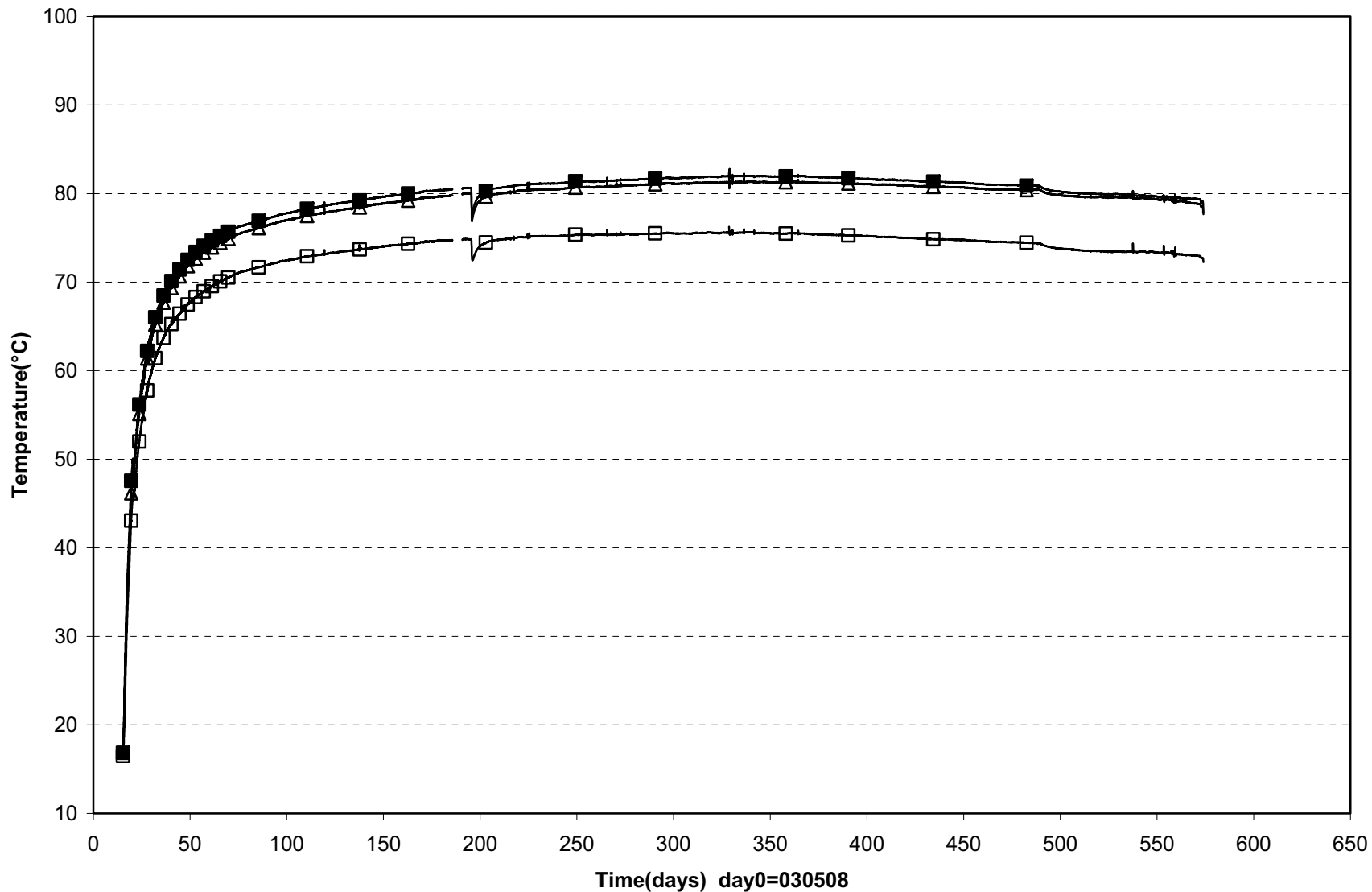

□ TB611(0.753\ 0°\0.525) ■ TB619(2.753\ 0°\0.525) △ TB627(4.253\0°\0.525)

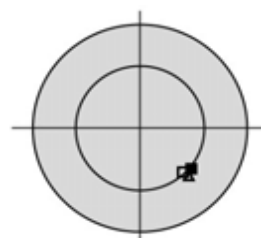
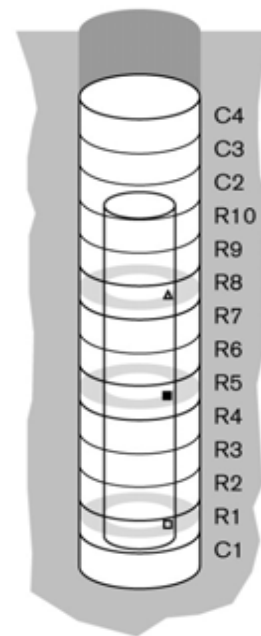
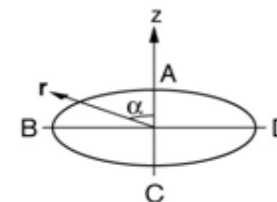

Appendix 7

Backfill in section 2

**Total pressure\ Backfill \ Section 2 (041015-041201)
Geokon**

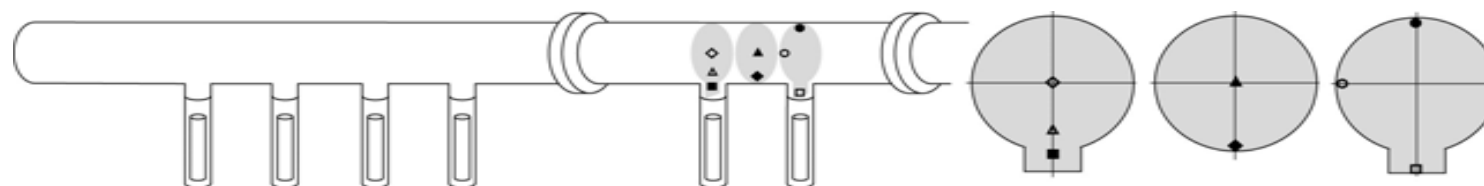
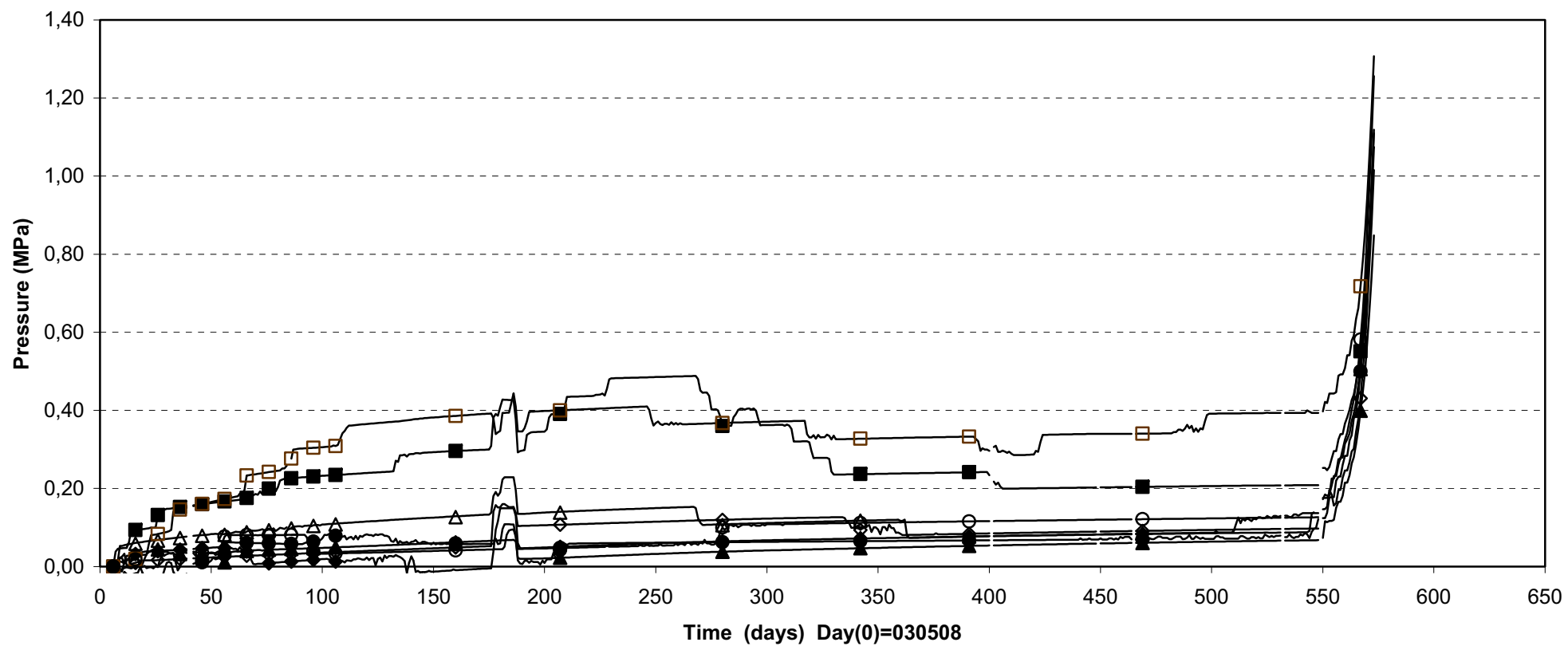

◇ PFA02 (E5\0\0\3551)	△ PFA03 (E5\0\1.75\3551)	■ PFA04 (E5\0\2.6\3551)
▲ PFA08 (F5-6\0\0\3548)	◆ PFA09 (F5-6\0\1\2.3\3548)	□ PFA13 (E6\0\3.15\3545)
○ PFA14 (E6\2.3\0\3545)	● PFA15 (E6\0\2.3\3545)	

Prototype\ Backfill \ Section 2 (041015-041201)
 Total pressure - Kulite

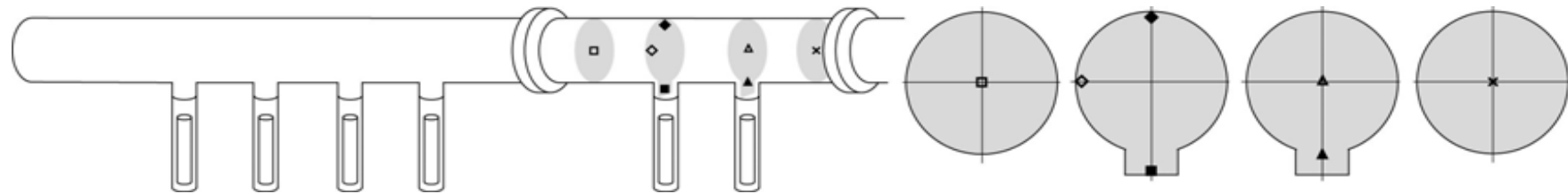
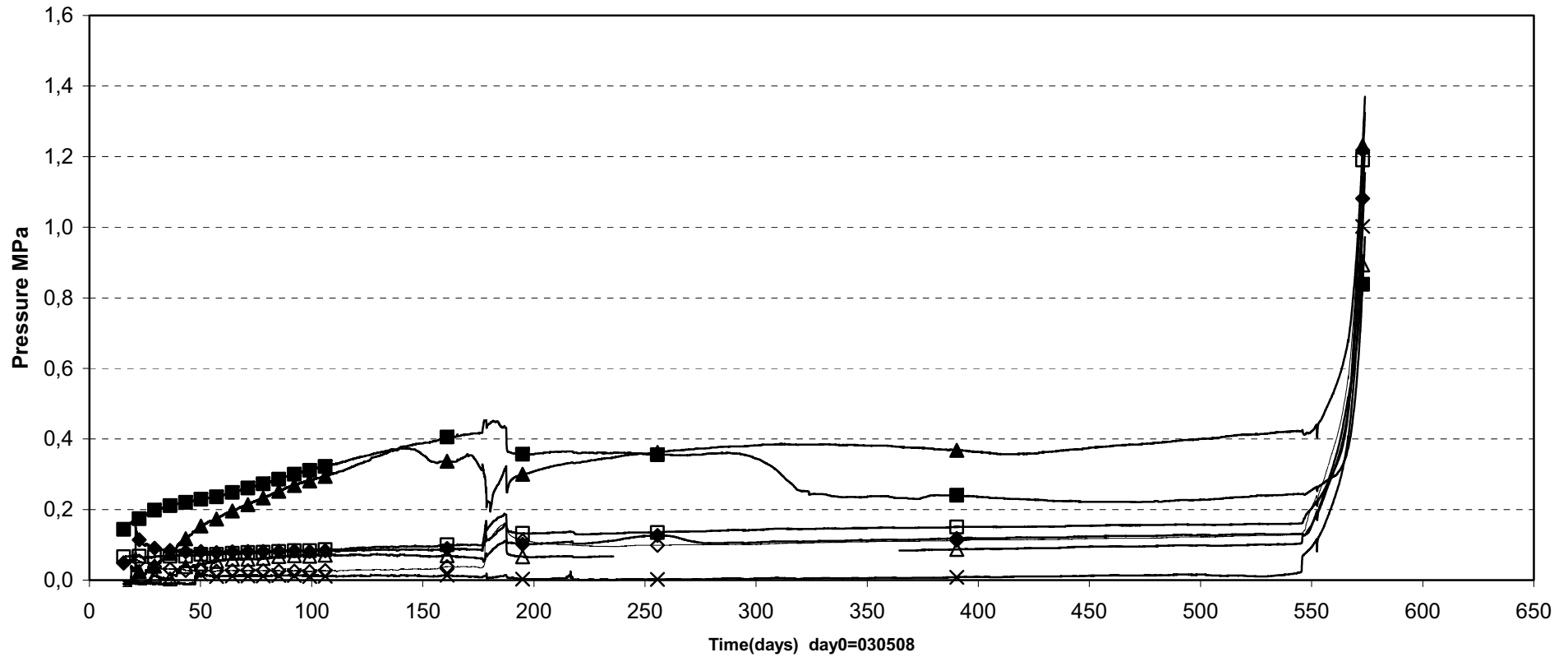

□ PFA01 (Inner part\0\0\3556)	■ PFA05 (E5\0\3.15\3551)	◇ PFA06 (E5\0\2.3\0\3551)	◆ PFA07 (E5\0\2.3\3551)
△ PFA10 (E6\0\0\3545)	▲ PFA12 (E6\0\0\2.6\3545)	× PFA16 (In front of plug\0\0\3539)	

Prototype\Backfill \Section2\ Inner part (030508-041201)
 Suction - Wescor

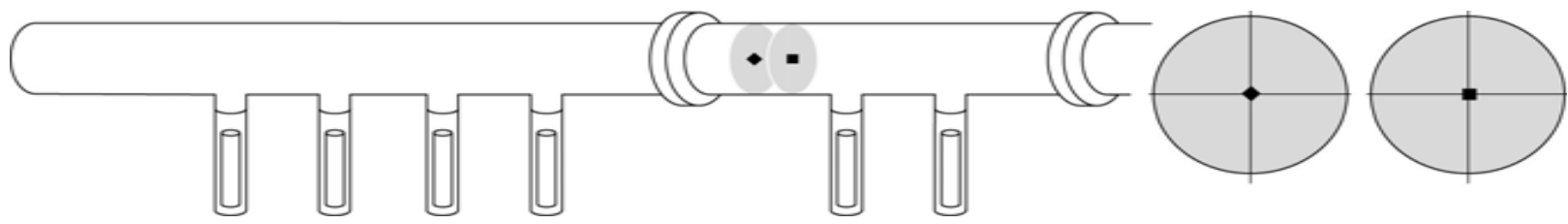
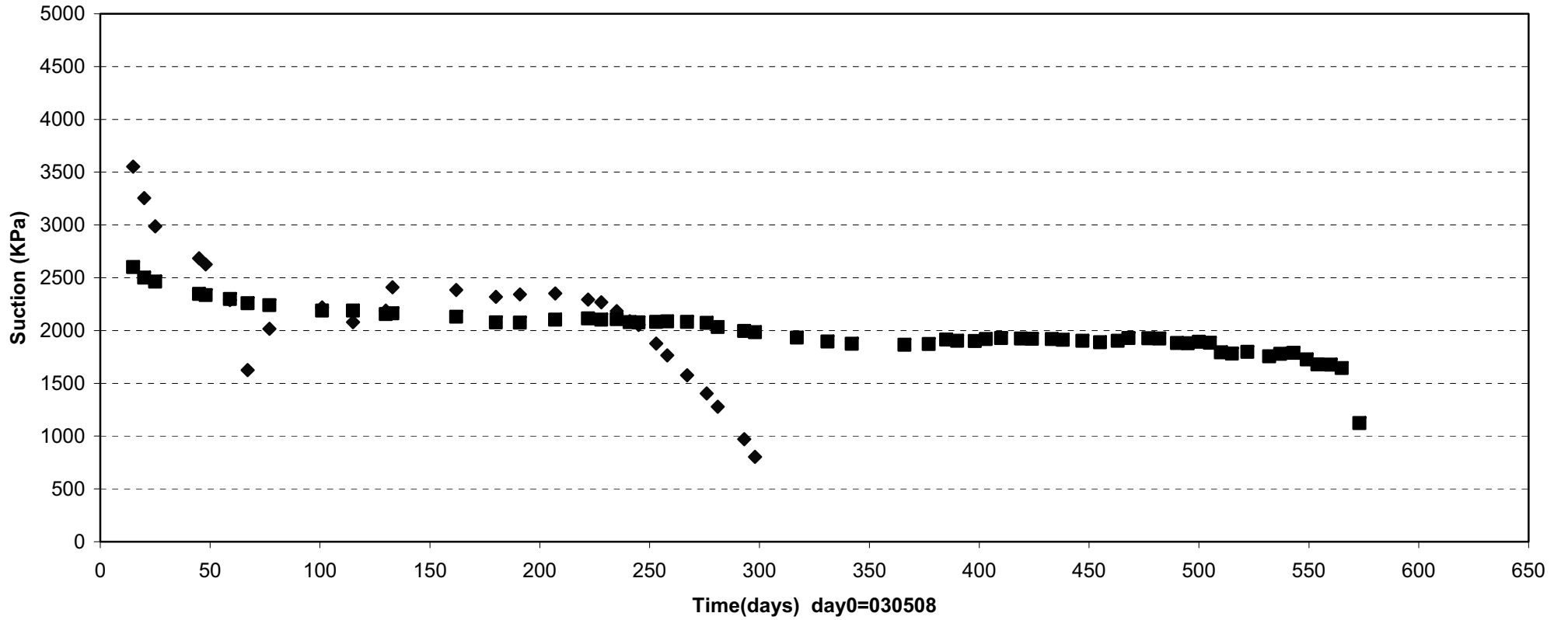

◆ WFA01(Inner part\0\0\3556) ■ WFA02(Inner part\0\0\3554)

Prototype\Backfill\ Above dep.hole 5 (030508-041201)
Suction - Wescor

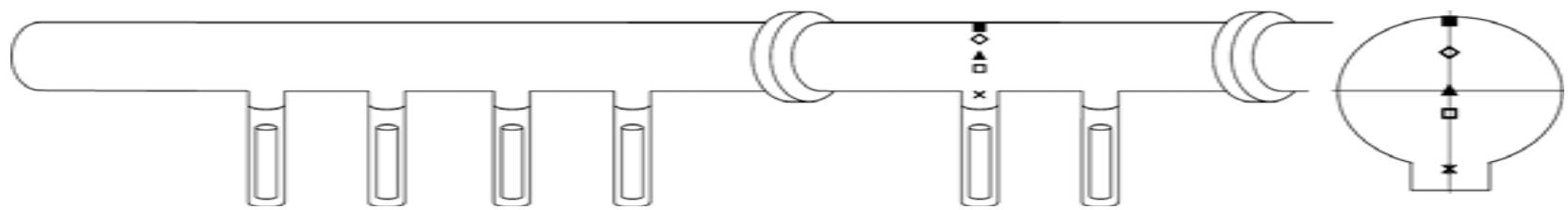
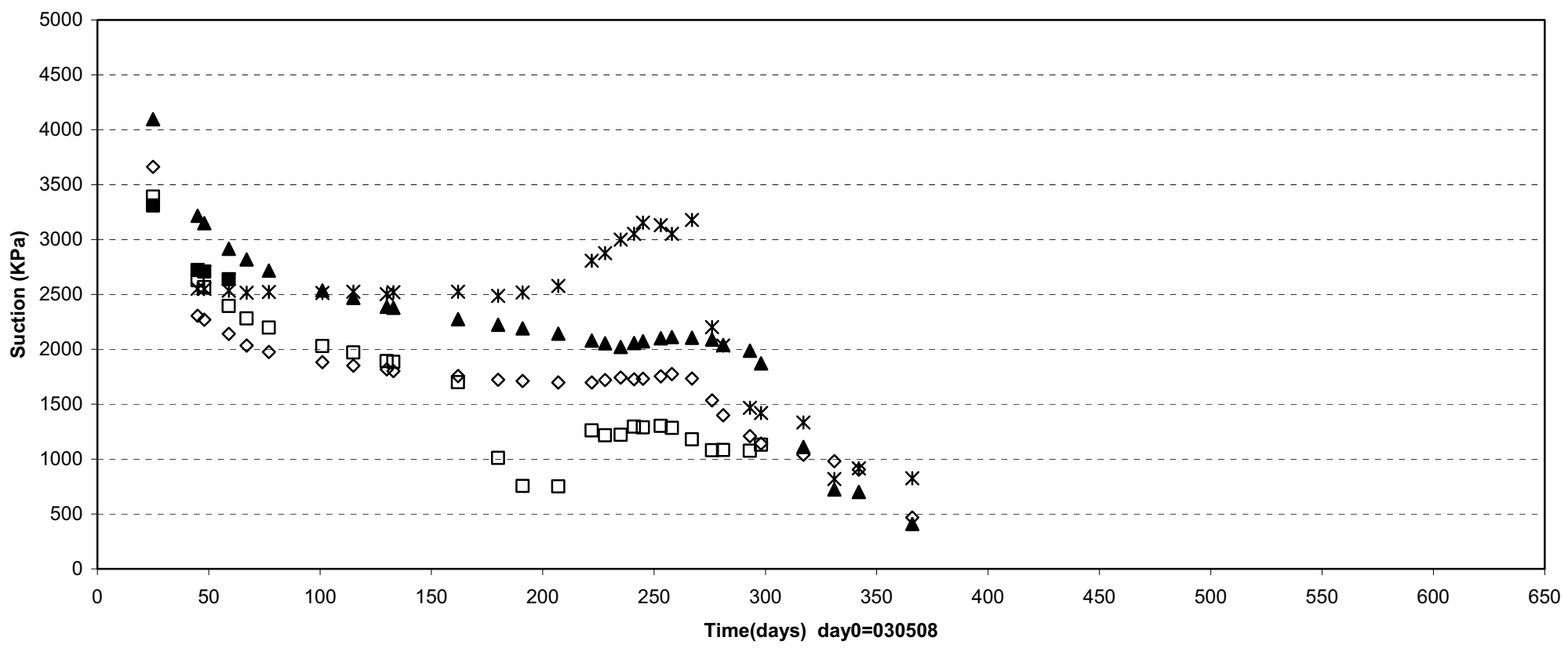

WFA03(E5\0\2.3\3551)
 WFA04(E5\0\1.25\3551)
 WFA05(E5\0\0\3551)
 WFA06(E5\0\0.8\3551)
 WFA08(E5\0\2.6\3551)

Prototype\Backfill\ Above dep.hole 5 (030508-041201)
Suction - Wescor

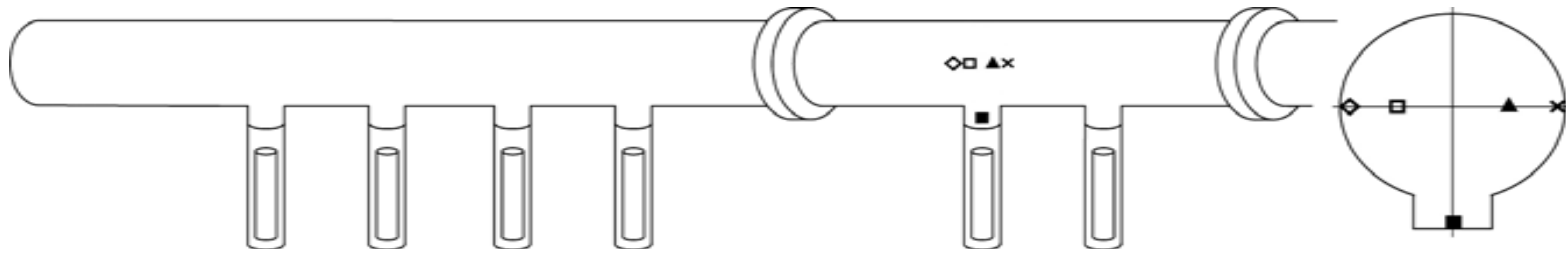
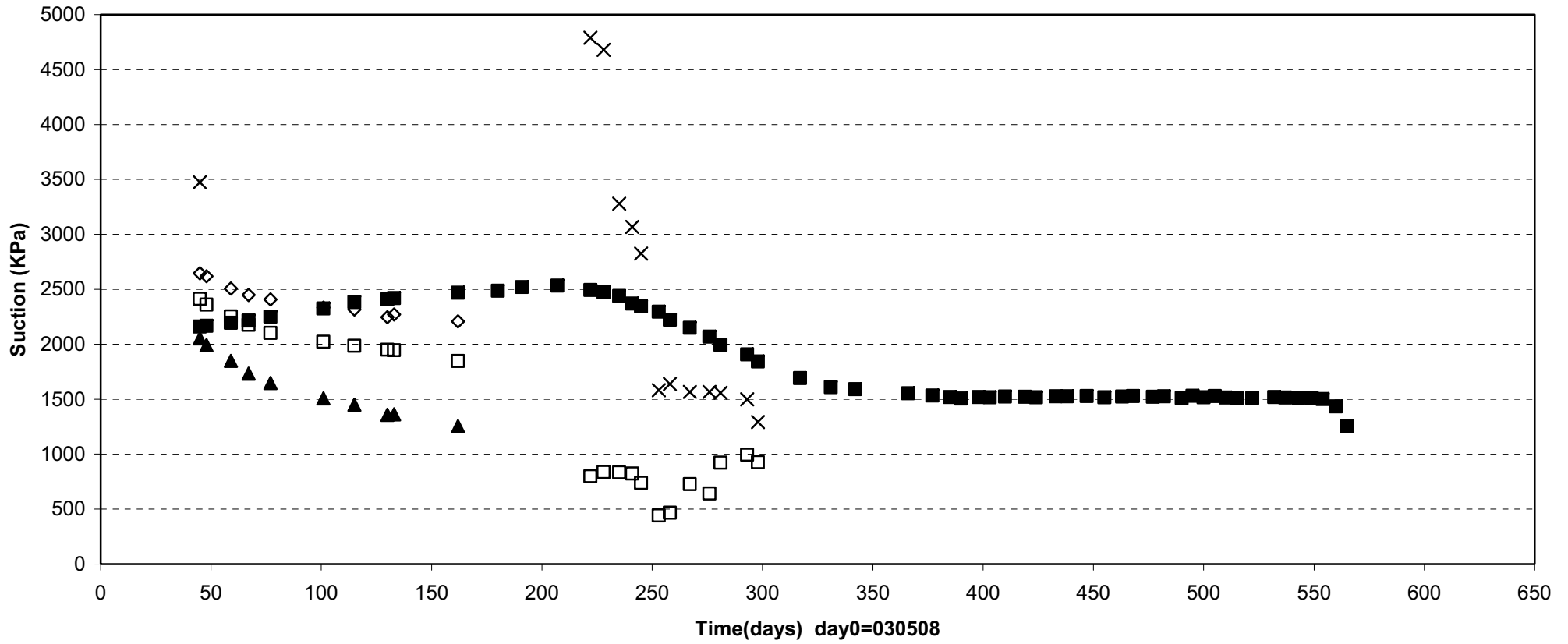

WFA09(E5\0-3.15\3551)
 WFA10(E5\ -2.3\0\3551)
 WFA11(E5\ -1.25\0\3551)
 WFA12(E5\1.25\0\3551)
 WFA13(E5\2.3\0\3551)

Prototype\Backfill \ Between dep.hole 5 and hole 6 (030508-041201)

Suction - Wescor

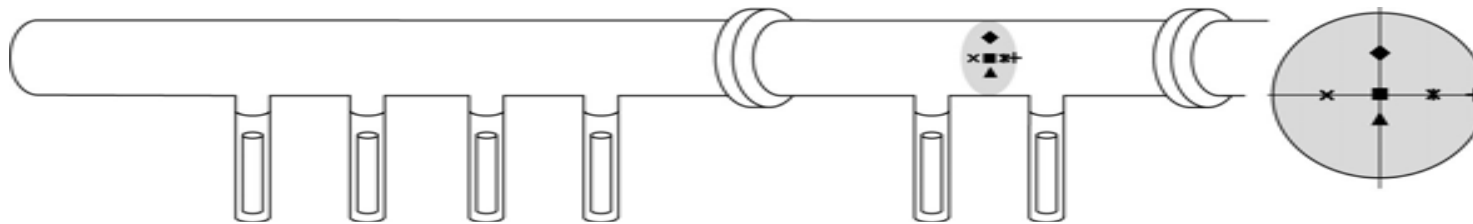
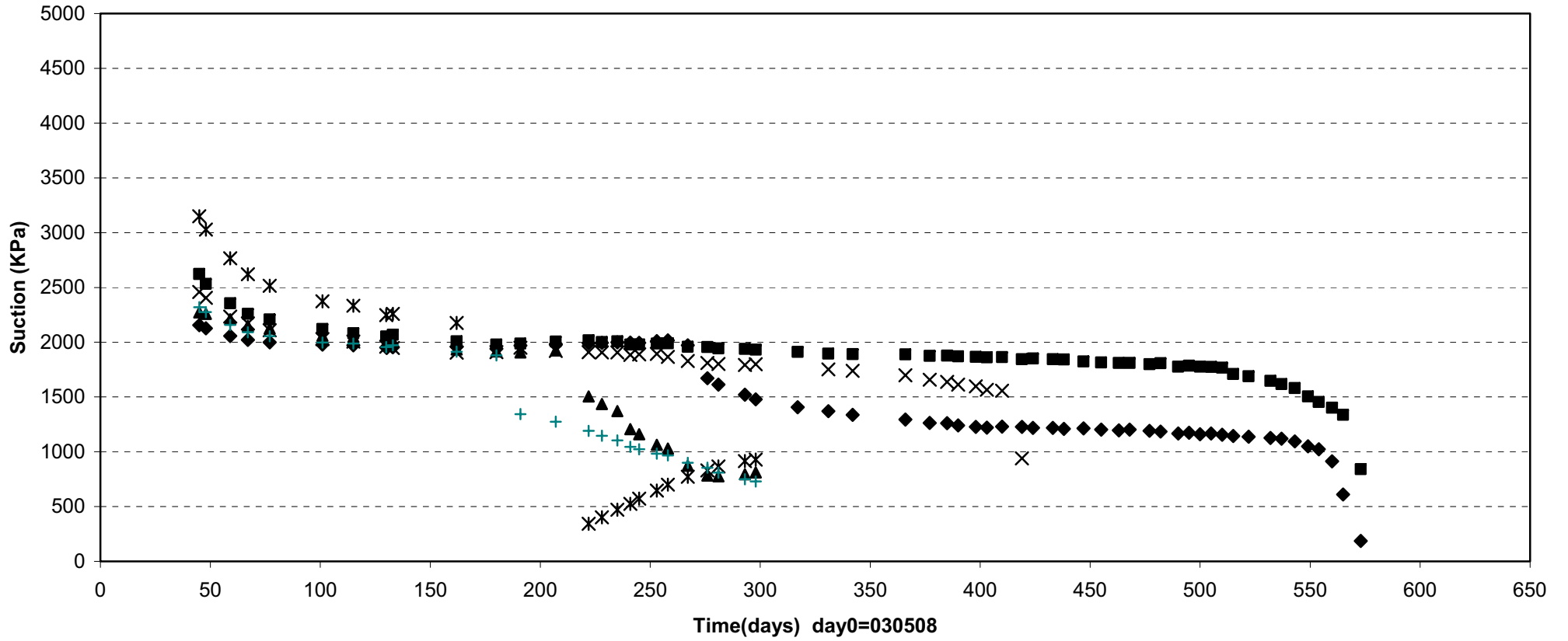

◆ WFA15(F5-6\0\1.25\3548) ■ WFA16(F5-6\0\0\3548) ▲ WFA17(F5-6\0\0.8\3548) × WFA18(F5-6\1.25\0\3548)
 ✱ WFA19(F5-6\1.25\0\3548) + WFA30(E5-6\0\2.3\3548)

Prototype\Backfill \Section2\ Above dep.hole 6 (030508-041201)
Suction - Wescor

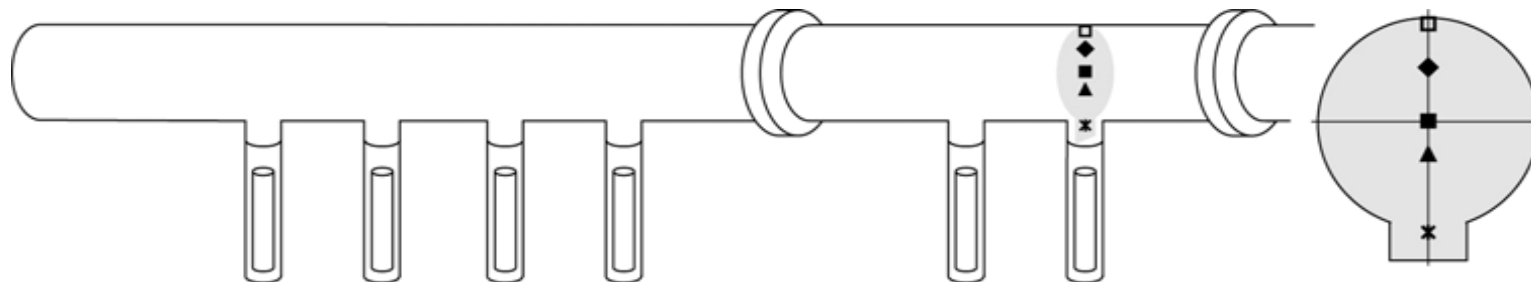
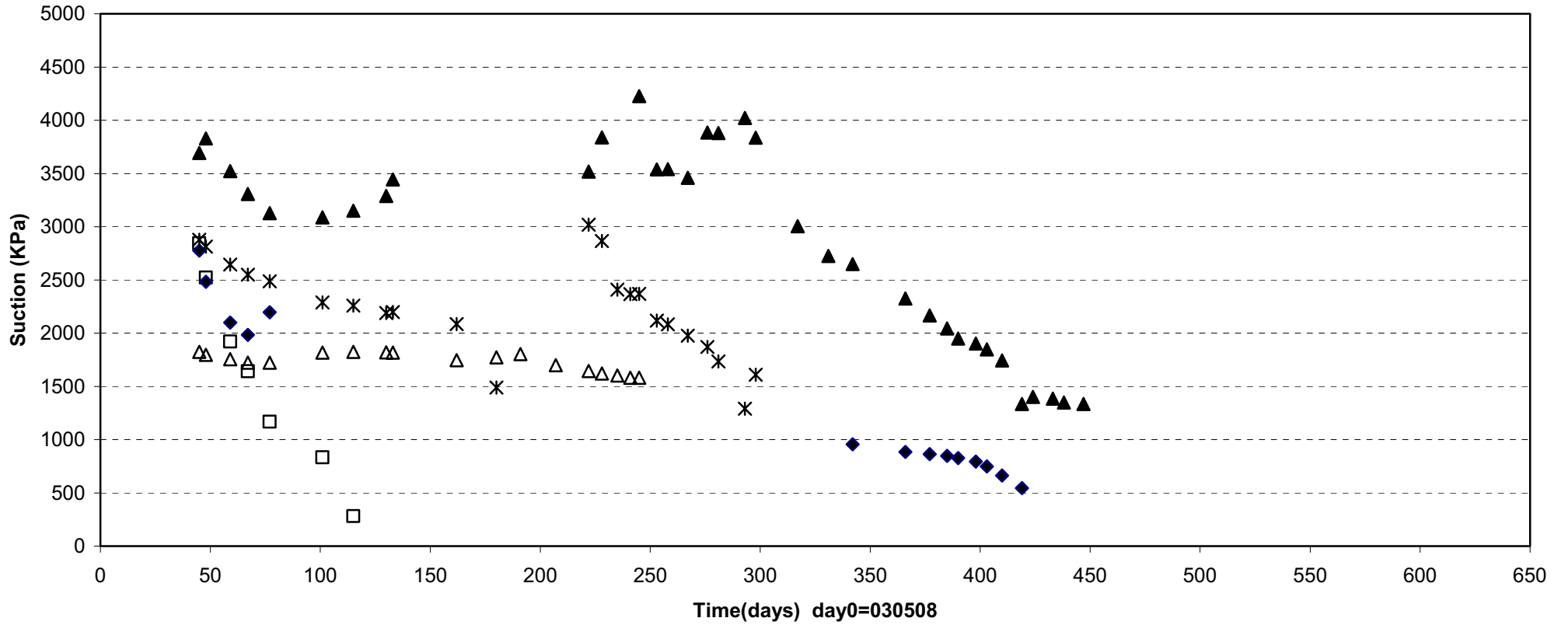

□ WFA20(E6\0\2.3\3545) ◆ WFA21(E6\0\1.25\3545) ■ WFA22(E6\0\0\3545) ▲ WFA23(E6\0\0.8\3545) ✱ WFA25(E6\0\2.6\3545) △ WFA24(E6\0\1.75\3545)

Prototype\Backfill\Section2\ Above dep.hole 6 (030508-041201)
Suction - Wescor

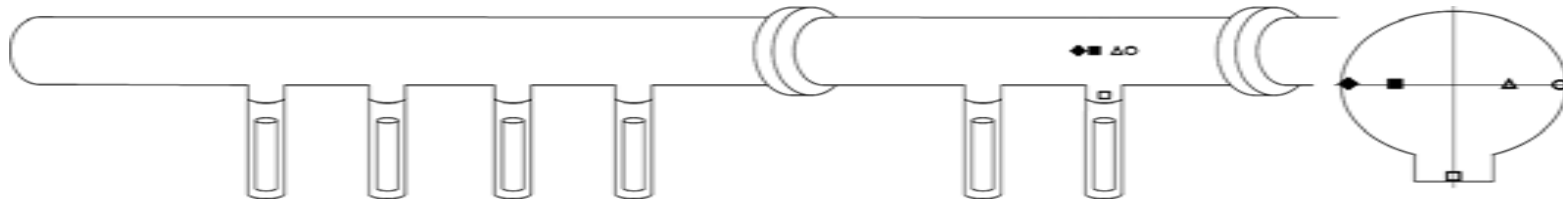
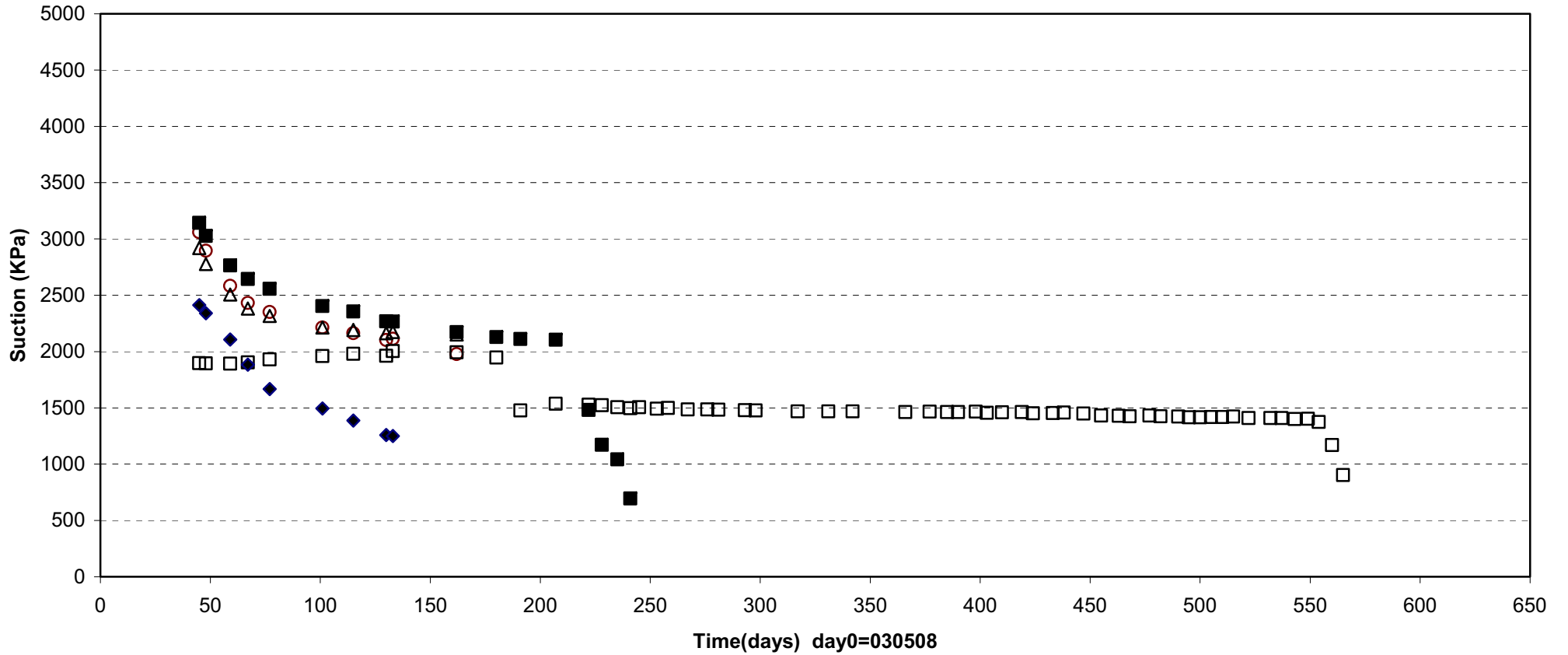

○ WFA07(E6\2.3\0\3545) □ WFA26(E6\0-3.15\3545) ◆ WFA27(E6\2.3\0\3545) ■ WFA28(E6\1.25\0\3545) △ WFA29(E6\1.25\0\3545)

Prototype\Backfill \Section2 \ In front of plug (030508-041201)
 Suction - Wescor

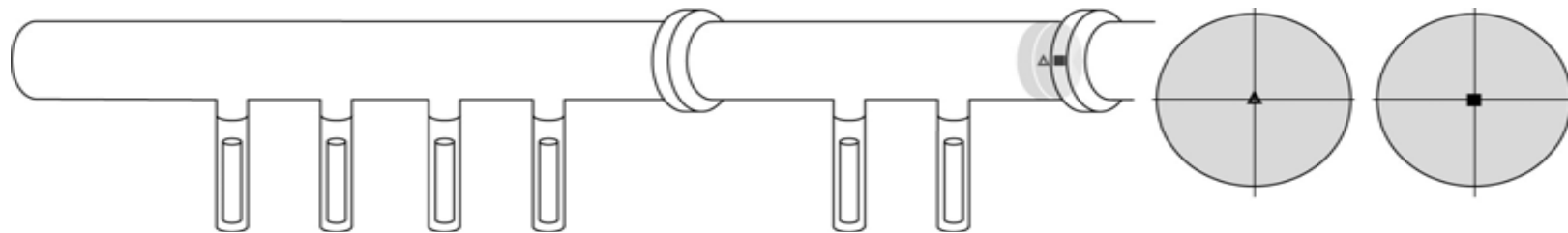
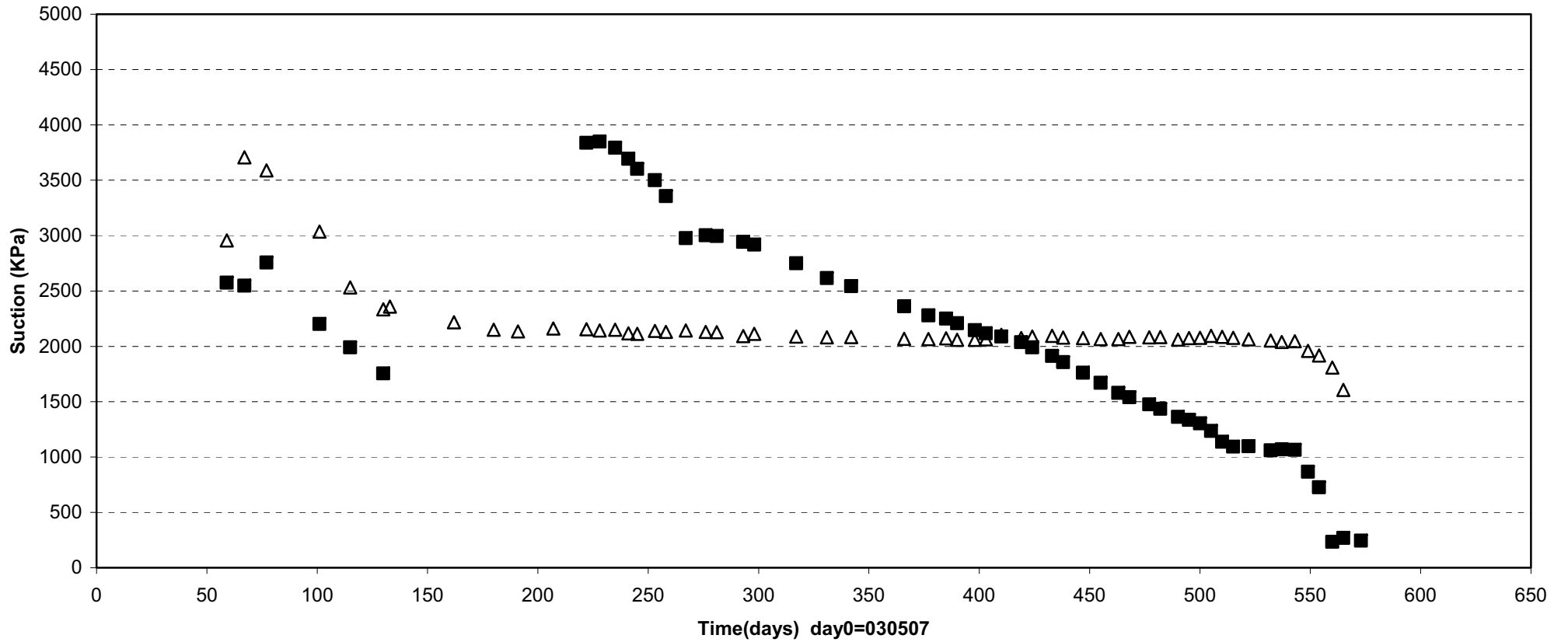

△ WFA31(In front of plug\0\0\3540) ■ WFA32(In front of plug\0\0\3539)

Prototype\Backfill \Over hole 5 (041015-041201)
Pore pressure - Geokon

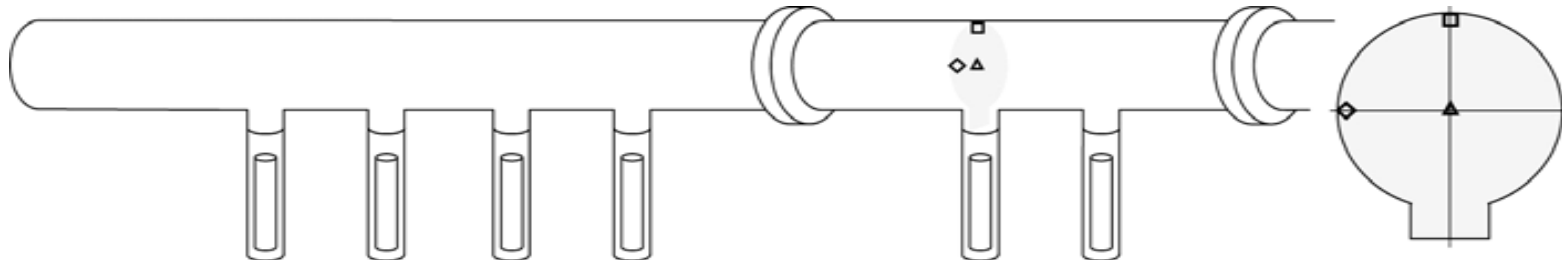
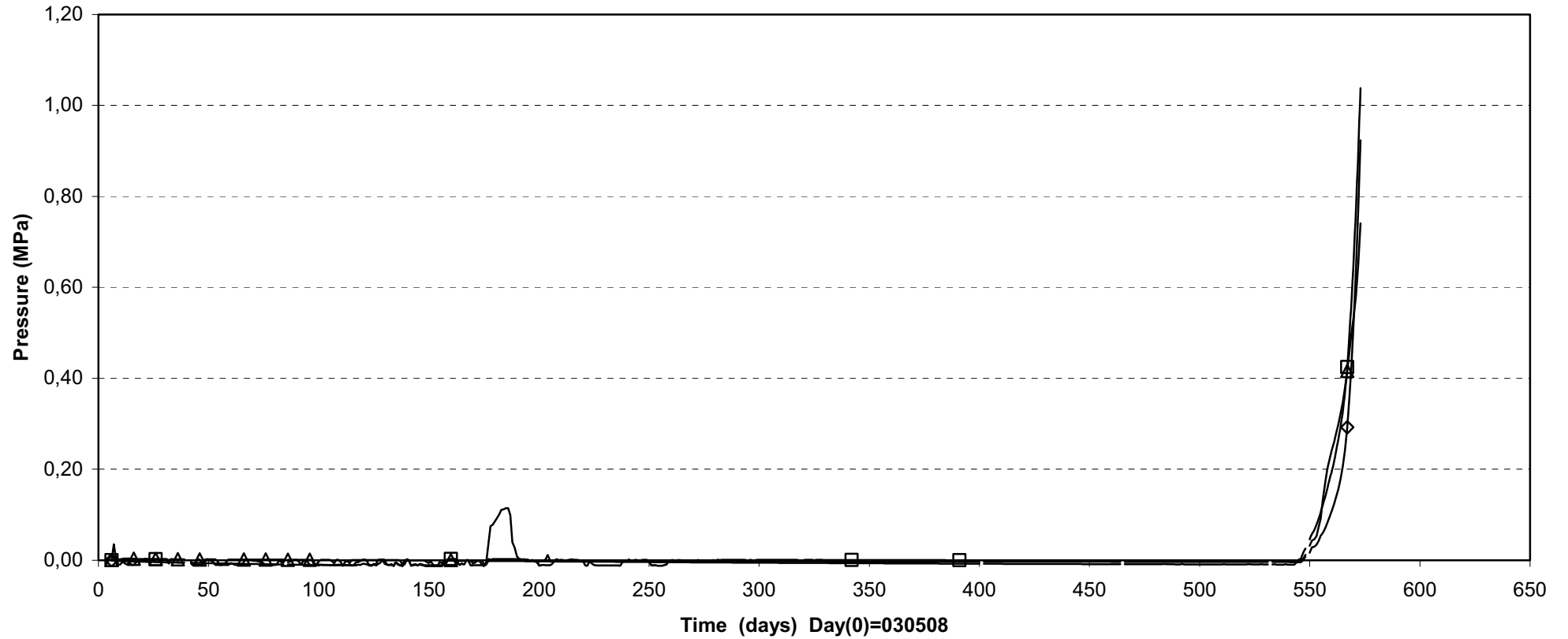

△ UFA03 (E5\0\0\3551) ◇ UFA07 (E5\0\1.75\3551) □ UFA08 (E5\0\2.3\3551)

Prototype \Backfill \ Over hole 6 (041015-041201)
 Pore pressure - Geokon

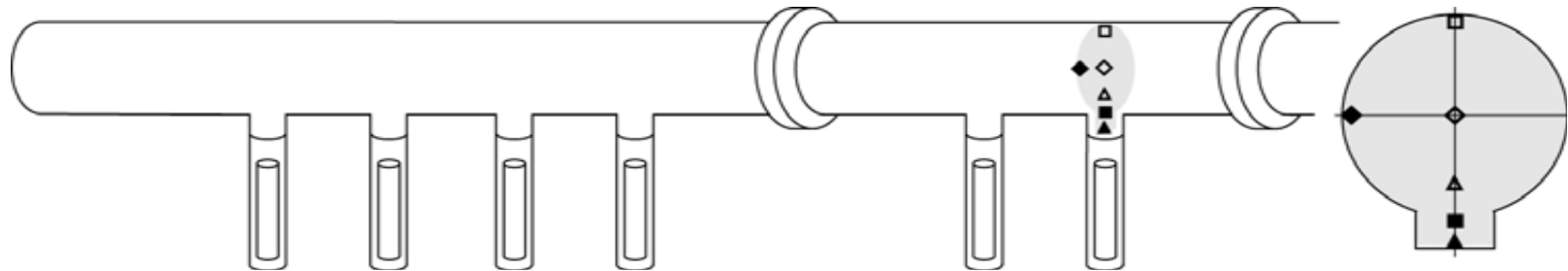
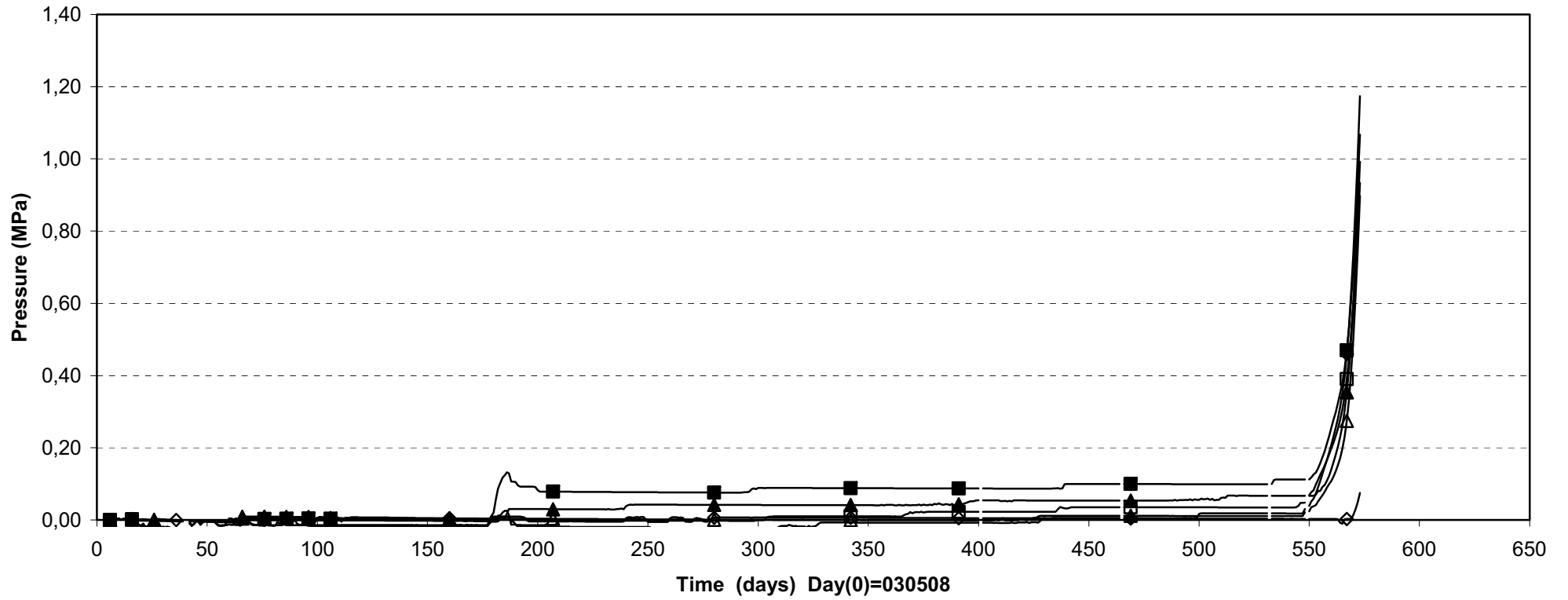

◇ UFA11 (E6\0\0\3545)	△ UFA12 (E6\0\ -1.75\3545)	■ UFA13 (E6\0\ -2.6\3545)
▲ UFA14 (E6\0\ -3.15\3545)	◆ UFA15 (E6\ -2.3\0\3545)	□ UFA16 (E6\0\2.3\3545)

Prototype\Backfill \ Section2 (041202-041201)
 Pore pressure - Geokon

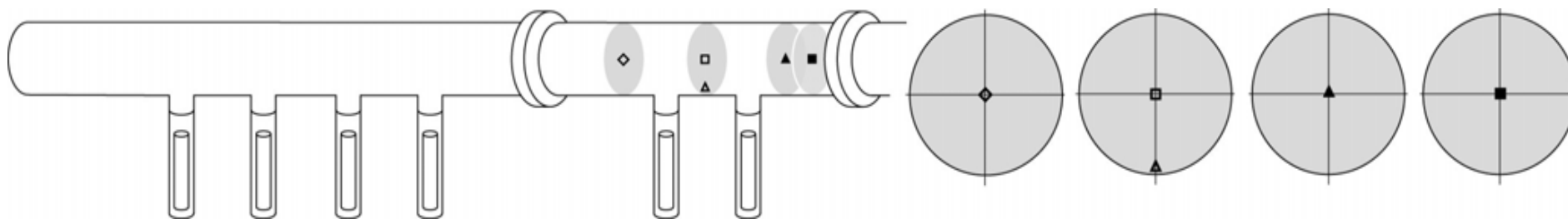
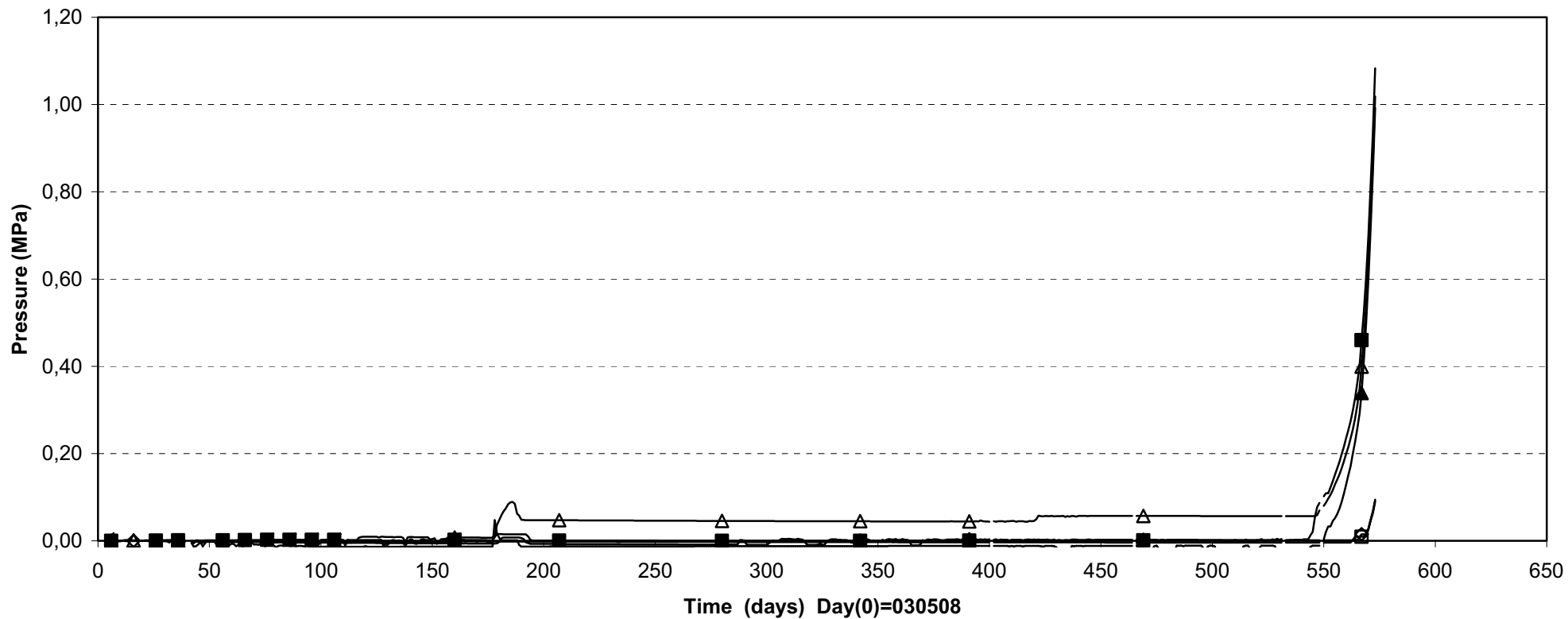

- ◇ UFA02 (Inner part\0\0\3554.1)
- ▲ UFA17(E5\ -2.3\0\3551)
- UFA09 (F5-6\0\0\3548)
- UFA18 (In front of plug\0\0\3539)
- △ UFA10 (F5-6\0\ -2.0\3548)

**Prototype\ Backfill \ Section 2 (041015-041201)
Pore pressure - Kulite**

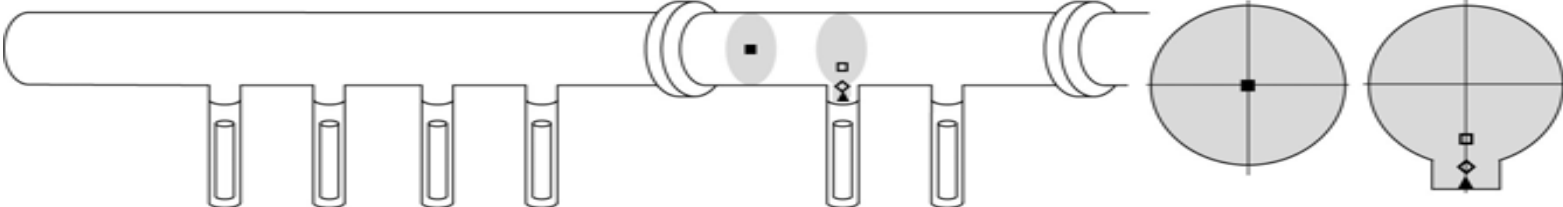
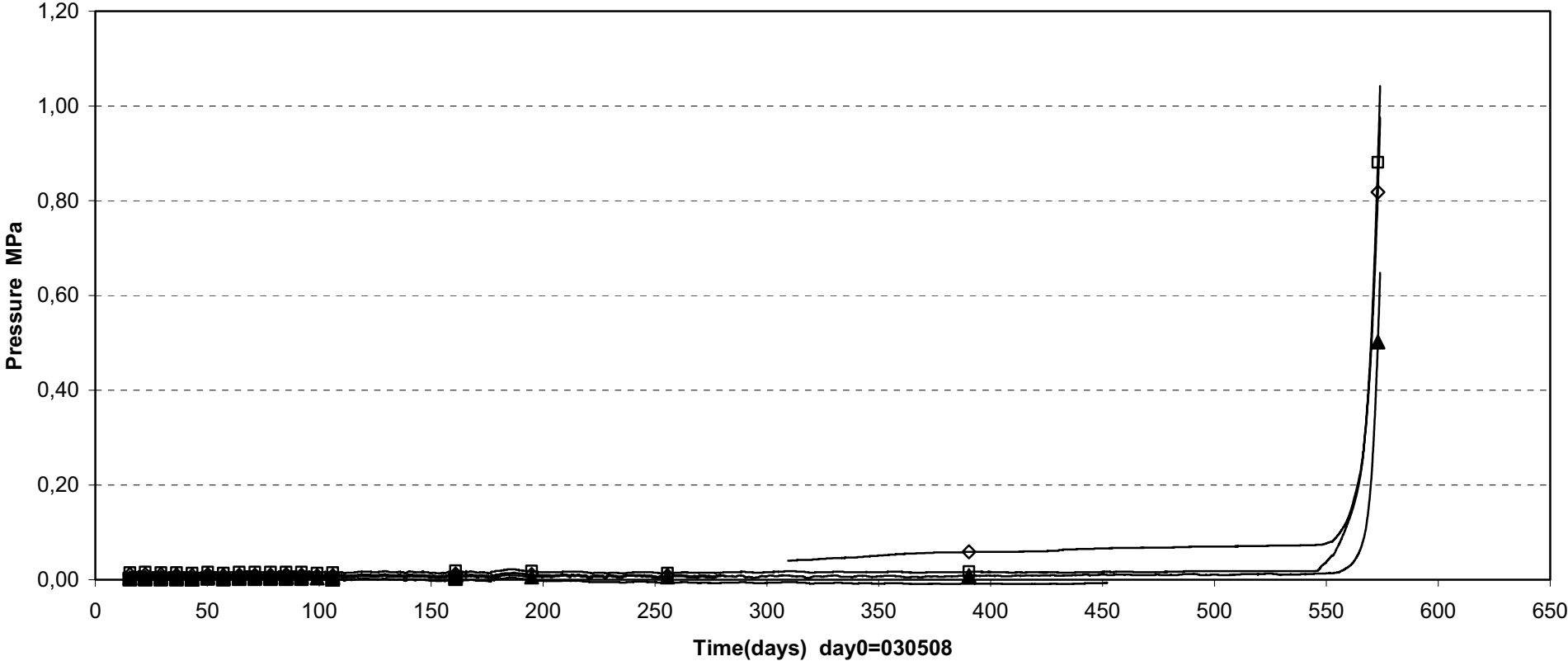

UFA01(Inner part\0\0\3556)
 UFA04(E5\0\ -1.75\3551)
 UFA05(E5\0\ -2.6\3551)
 UFA06(E5\0\ -3.15\3551)

Prototype\ Backfill \ Above dep.hole5 (030508-041201)
 Temperature - Pentronic

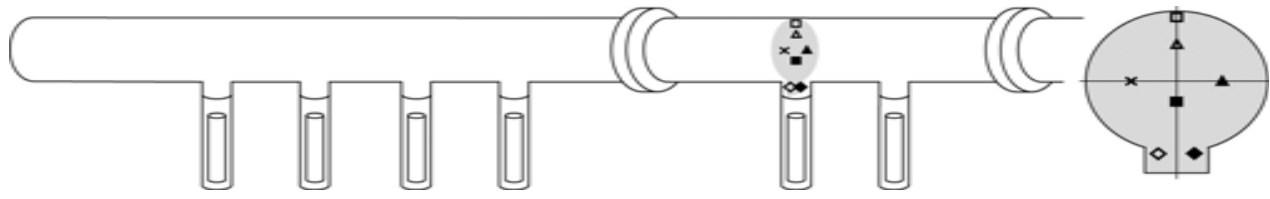
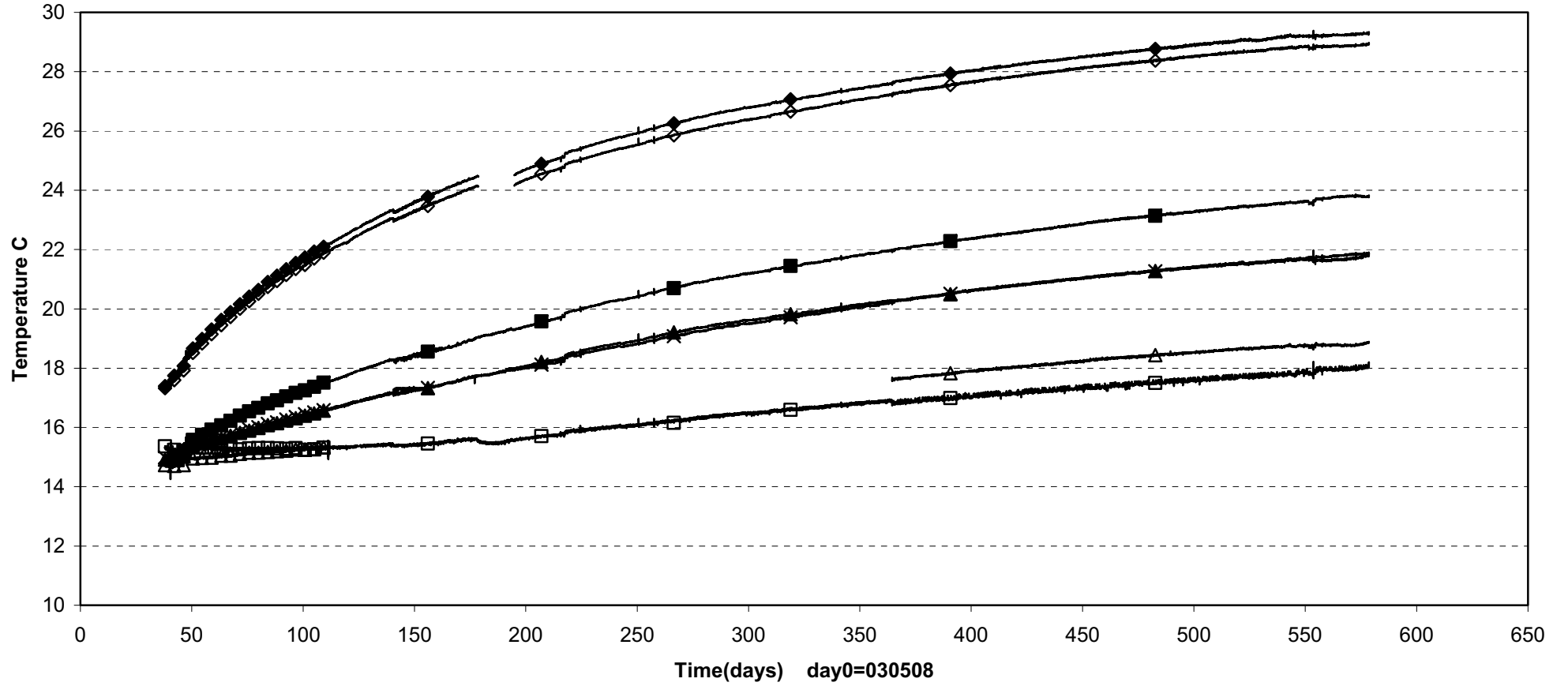

- TFA01(E5\0.2.3\3551) Δ TFA02(E5\0.1.25\3551) ■ TFA03(E5\0.1.8\3551) ◇ TFA04(E5\0.5\2.6\3551)
- ◆ TFA05(E5\0.5\2.6\3551) × TFA06(E5\1.25\0\3551) ▲ TFA07(E5\1.25\0\3551)

Prototype\ Backfill \ Above dep.hole6 (030508-041201)
 Temperature - Pentronic

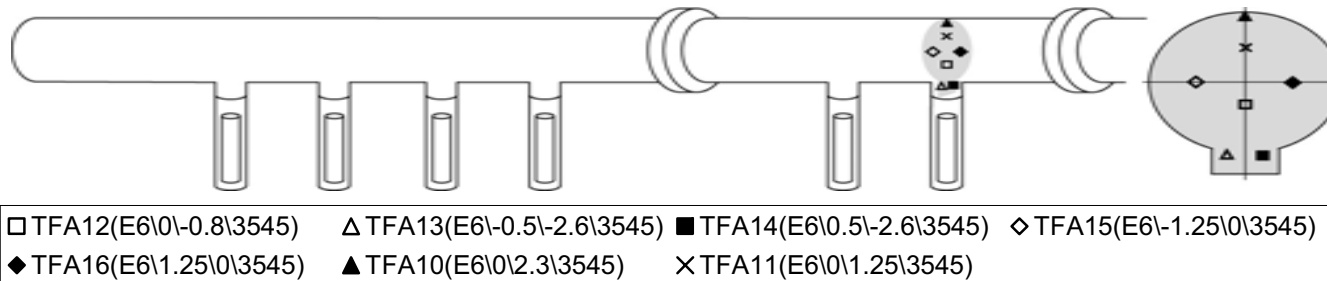
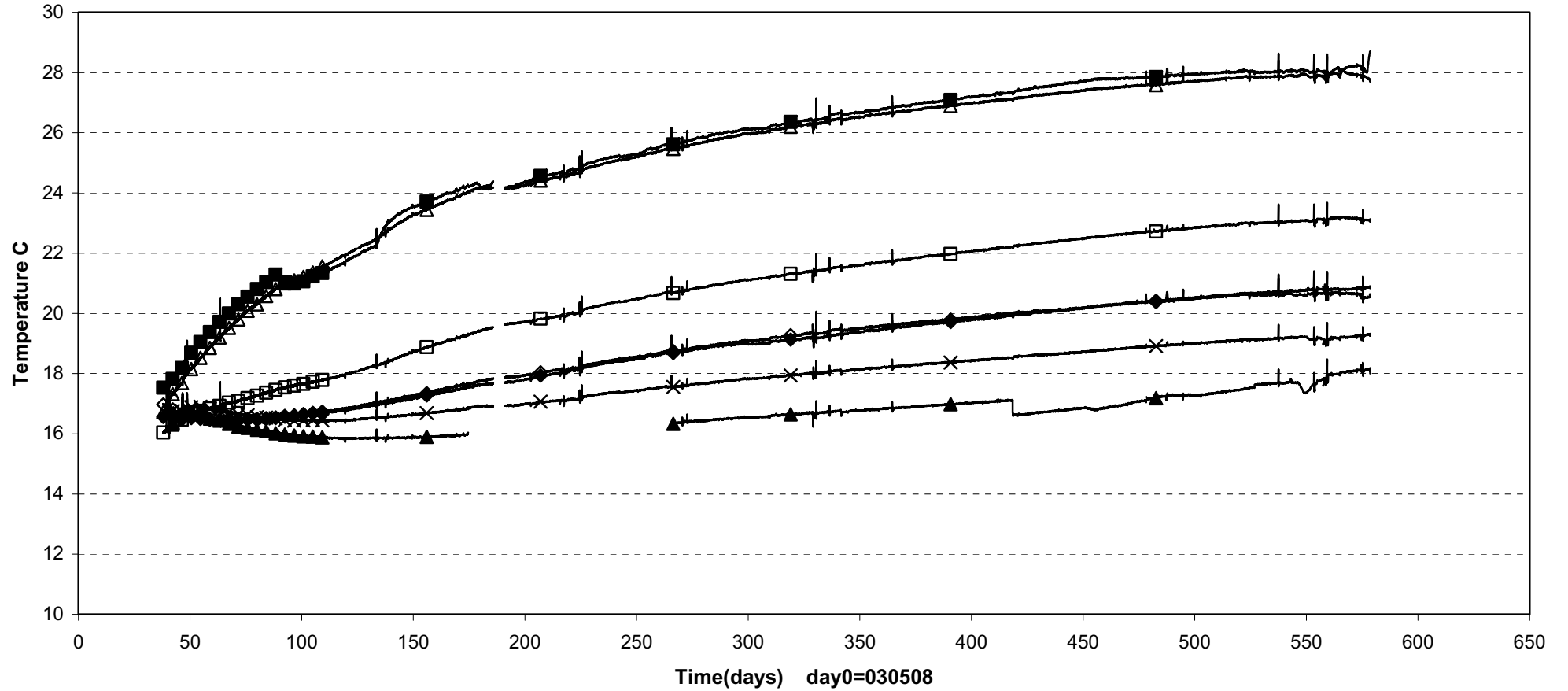

- TFA12(E6\0\ -0.8\3545) △ TFA13(E6\ -0.5\ -2.6\3545) ■ TFA14(E6\0.5\ -2.6\3545) ◇ TFA15(E6\ -1.25\0\3545)
- ◆ TFA16(E6\1.25\0\3545) ▲ TFA10(E6\0\2.3\3545) × TFA11(E6\0\1.25\3545)

Prototype\ Backfill \ Between dep.hole 5-6 (030508-041201)
 Temperature - Pentronic

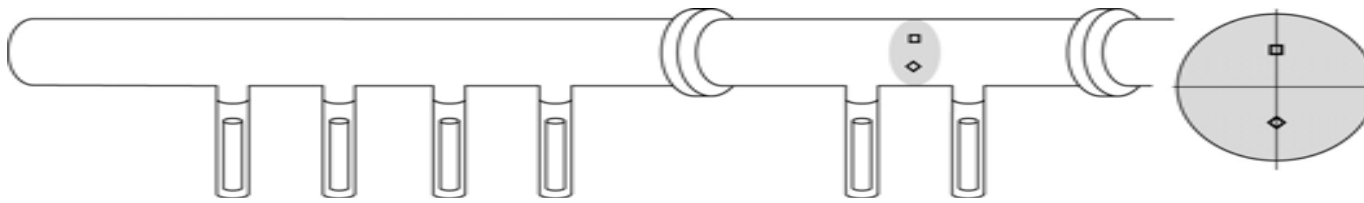
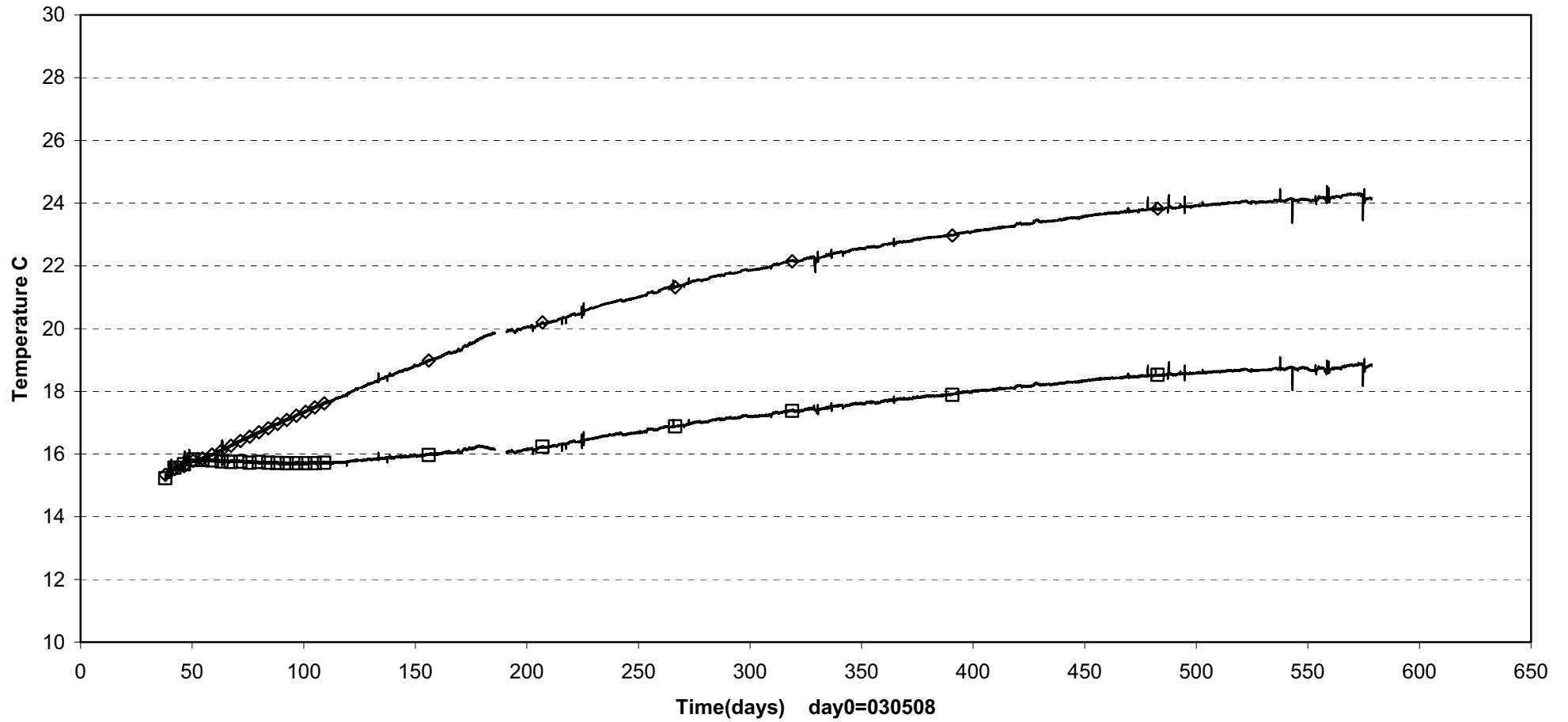

□ TFA08(F5-6\0\1.25\3548) ◇ TFA09(F5-6\0\1.25\3548)

Appendix 8

Canister displacements

Barcena, I. and P.A. Fernández, AITEMIN



PROTOTYPE REPOSITORY IN OPERATION

CANISTER DISPLACEMENT TRACKING

P.A. Fernández, I. Bárcena

December 2004

Contents

1. Layout	259
2. General comments	261
3. Deposition hole 3	263
3.1. Vertical sensors	263
3.2. Horizontal sensors	263
4. Deposition hole 6	265
4.1. Vertical sensors	265
4.2. Horizontal sensors	265
5. DATA PLOT deposition hole 3	267
6. DATA PLOT deposition hole 6	268
7. MONITORING SCREEN	269

1. Layout

The measurement of displacements is carried out in Section 1 on the canister in deposition hole 3. In Section 2 the displacements are measured on the canister in deposition hole 6. In deposition hole 3 six sensors are grouped into one measuring section, while in deposition hole 6 there are two measuring sections, at the bottom and on top of the canister, as shown in Figure 1.

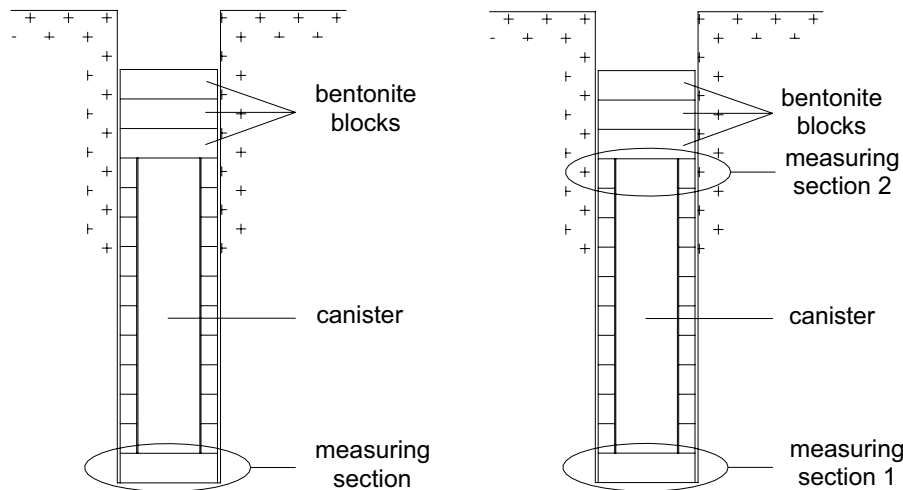

Figure 1. Location of measuring sections for deposition hole 3 (left) and deposition hole 6 (right)

For deposition hole No. 3 three sensors, named MCA30001 to MCA30003, have been placed in vertical position into holes drilled into the bottom bentonite block. These three sensors determine the vertical displacement of the canister, as well as any possible tilt. The points where the sensors are attached to the canister are the same as for the horizontal sensors.

The other three displacement sensors for deposition hole 3, named MCA30004 to MCA30006, are placed horizontally at the top of the lower bentonite block, close to the lower lid of the canister and attached to it, in a 120° radial disposition. Thus, the sensors will be always in a horizontal position, so that the horizontal displacement of the canister can be measured. The sensors have been placed so as to avoid interfering with other sensors installed in the block. Figure 2 illustrates the position of the six sensors.

For deposition hole 6 three sensors, named MC6001 to MC6003, have been placed in vertical position in the same way as for deposition hole 3. The horizontal sensors, named MCA6004 to MCA6006, have been placed in the same position as in deposition 3, but in the tenth bentonite ring, attached to the upper lid of the canister. Figure 3 shows the position of the sensors in this deposition hole.

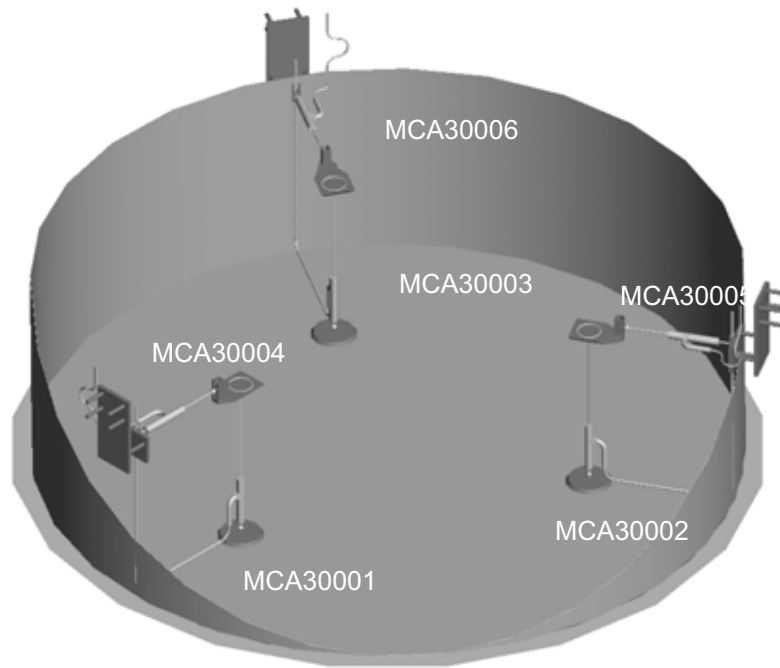

Figure 2. General view of sensors in deposition hole 3

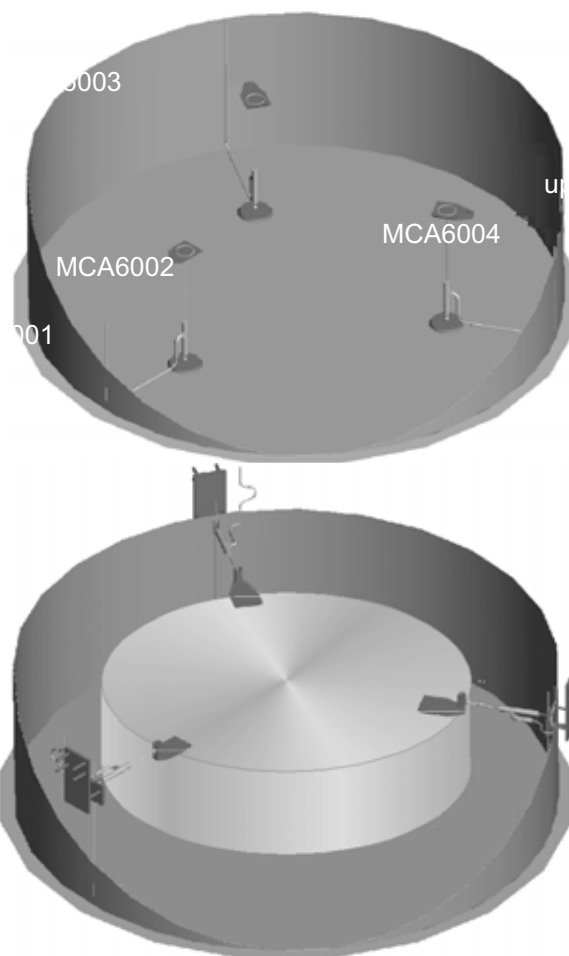

Figure 3. General view of vertical (left) and horizontal (right) sensors in deposition hole 6

2. General comments

This is the third “Prototype Repository in Operation” report issued for SKB within the contract No. 10826.

Monitoring is carried out since 010623 in deposition hole 3 and since 030429 in deposition hole 6. Negative values correspond to a retraction of the transducer, which means vertical sinking or horizontal approaching to the rock surface, depending on the transducer position.

It can be clearly noticed in both holes the moment when the protection plastic sheet was removed, right before the backfilling of the tunnel. At that point, the sensors started registering displacements due to the bentonite swelling.

According to the measures carried out prior to the buffer installation, the water inflow in deposition hole 6 is two times that of deposition hole 3. This could be somewhat noticed when comparing the results from both holes, as the registered displacements in deposition hole 6 are much bigger in one year than those of deposition hole 3 in three years.

The closure of the tunnel drainage on 041101 seem to have had a high influence in deposition hole 3.

Only one sensor out of the 12 installed has failed during the monitoring phase. This is MCA30002, one of the vertical sensors in deposition hole 3. Apart from this, no major incidences have occurred during the monitoring phase.

The obtained results in both deposition holes are described hereafter.

3. Deposition hole 3

3.1. Vertical sensors

Two vertical sensors are still in operation in this deposition hole. After an initial small rise of about 0.5 mm, the sensors showed a fast canister sinking that reached about 2 mm below the initial level, when, most likely due to the re-equilibration of pressures below and above the canister, the decrease ceased and the canister started to rise again.

Lately, the rising rate has slowed down, although the values of the two vertical sensors are almost on the initial level (less than one millimetre below), and with a small difference between them. This could indicate that no significant canister tilting has occurred, although the third value for defining the plane of the canister base is unavailable.

From day 041123, a very fast sink of the canister can be noticed, in both vertical sensors at the same time. The canister sank 1.5 mm in one week. This could be an effect of the closure of the tunnel drainage, which was done 23 days before, on 041101.

3.2. Horizontal sensors

Two of the horizontal sensors registered an initial small retraction, while the third one registered a similar elongation, all in the order of half of millimetre. This could indicate a horizontal displacement of the canister. Afterwards, the two sensors showing retraction changed to elongations of about 0.5 mm and 1.5 mm. One of the changes was very fast. No changes were registered in the third sensor, so it is not clear that this is due to a horizontal displacement of the canister. A possible explanation for this behaviour is that it is due to the vertical movement of the canister, although in principle the anchoring points of the horizontal sensors were conceived not to be affected by vertical displacements of the canister.

No changes are registered afterwards until day 041127, when one of the horizontal sensors showed some slight elongation. As the other two horizontal sensors are not showing any displacement, this small elongation of the sensor could be again due to the vertical displacement detected in the same dates.

4. Deposition hole 6

4.1. Vertical sensors

The vertical sensors maintain their trends from the start of the monitoring phase, showing a constant rise of the canister. Although one of the sensors started increasing later than the other two, all the three are now in similar values, what indicates that no tilting of the canister is taking place. The rising rate is about 1.5 mm every 3 months, approximately, with no signs of slowing down, so values at the end of the reported period show a canister rise of almost 10 mm from the start of the monitoring phase.

At the end of the reported period, no influence of the drainage closure can be noticed.

4.2. Horizontal sensors

The horizontal sensors showed some fast initial movement at first, with elongation of two sensors and retraction of the third one, what could indicate a canister movement towards this one in the order of 1 mm. Afterwards, one of the elongated sensors, MCA6005, started increasing at a rate similar to the vertical sensors. Lately the increasing rate of this sensor has slowed down, stabilising in values close to 6 mm. The other two sensors remained more or less constant.

Given the position of the sensors, a horizontal movement of the canister should result in a similar variation of the three sensors in absolute value, so as for deposition hole 3, it is more likely that the mentioned fast elongation of such sensor is due to the vertical movement of the canister.

As for the vertical sensors, at the end of the reported period, no influence of the drainage closure can be noticed.

5. DATA PLOT deposition hole 3

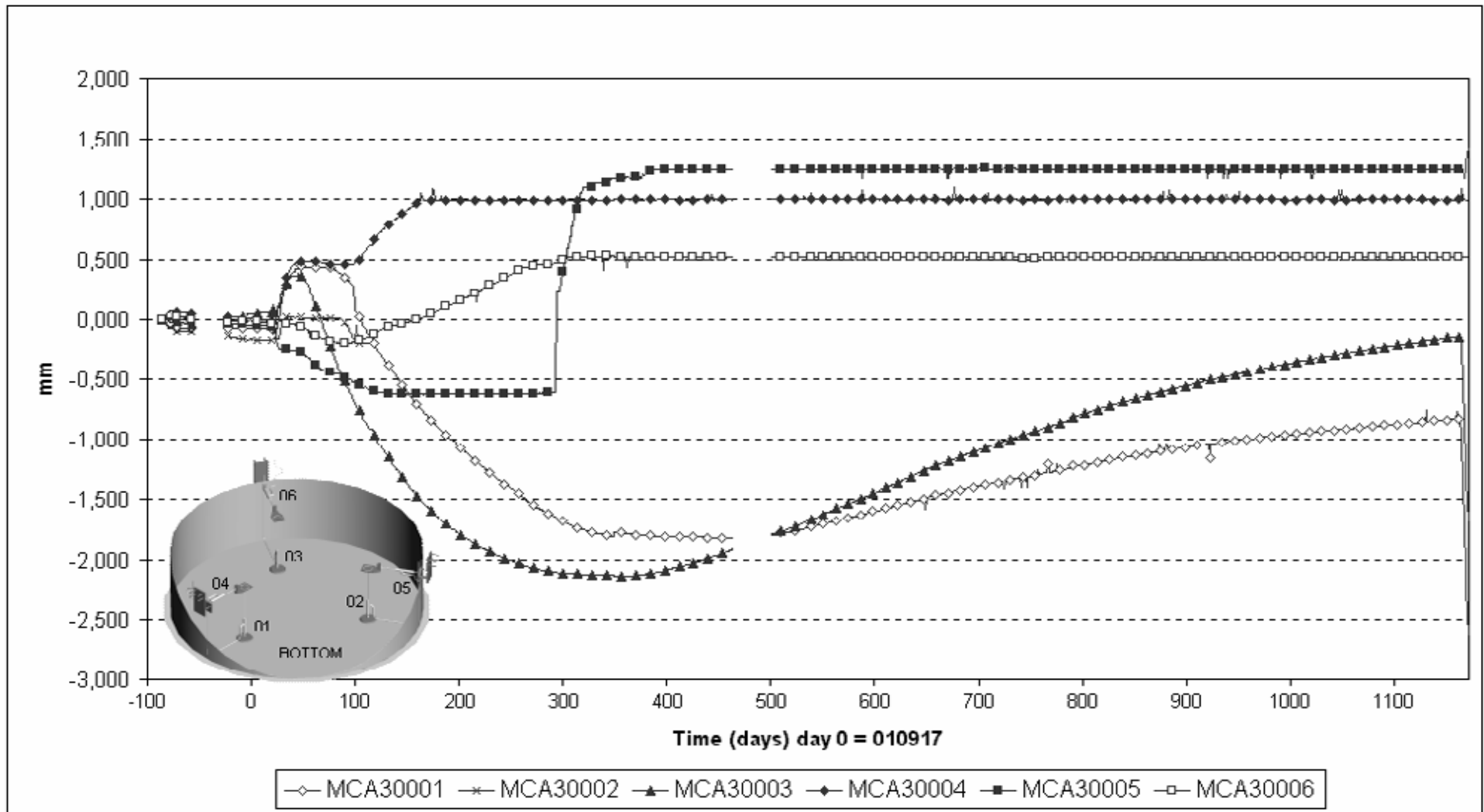

6. DATA PLOT deposition hole 6

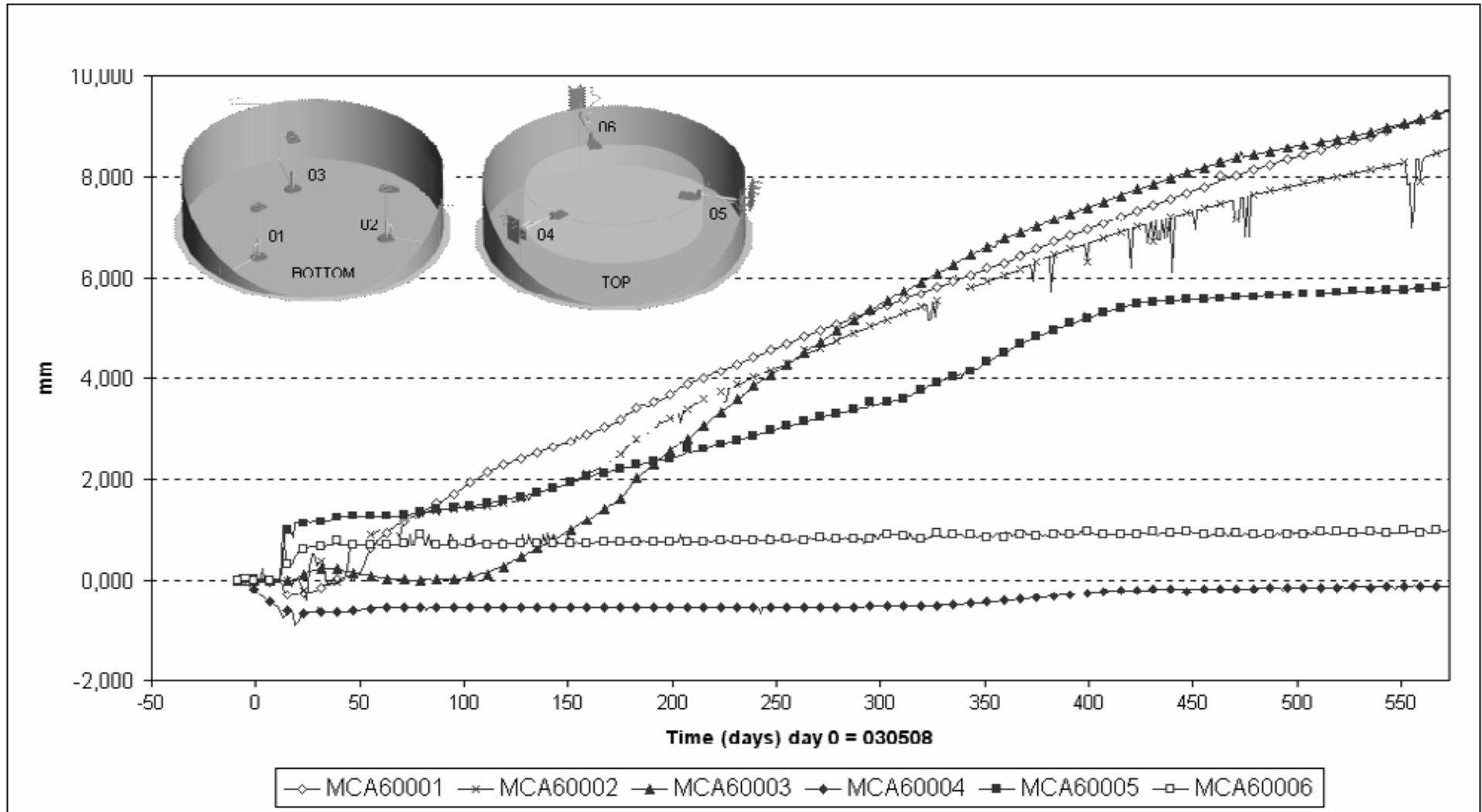

7. MONITORING SCREENS

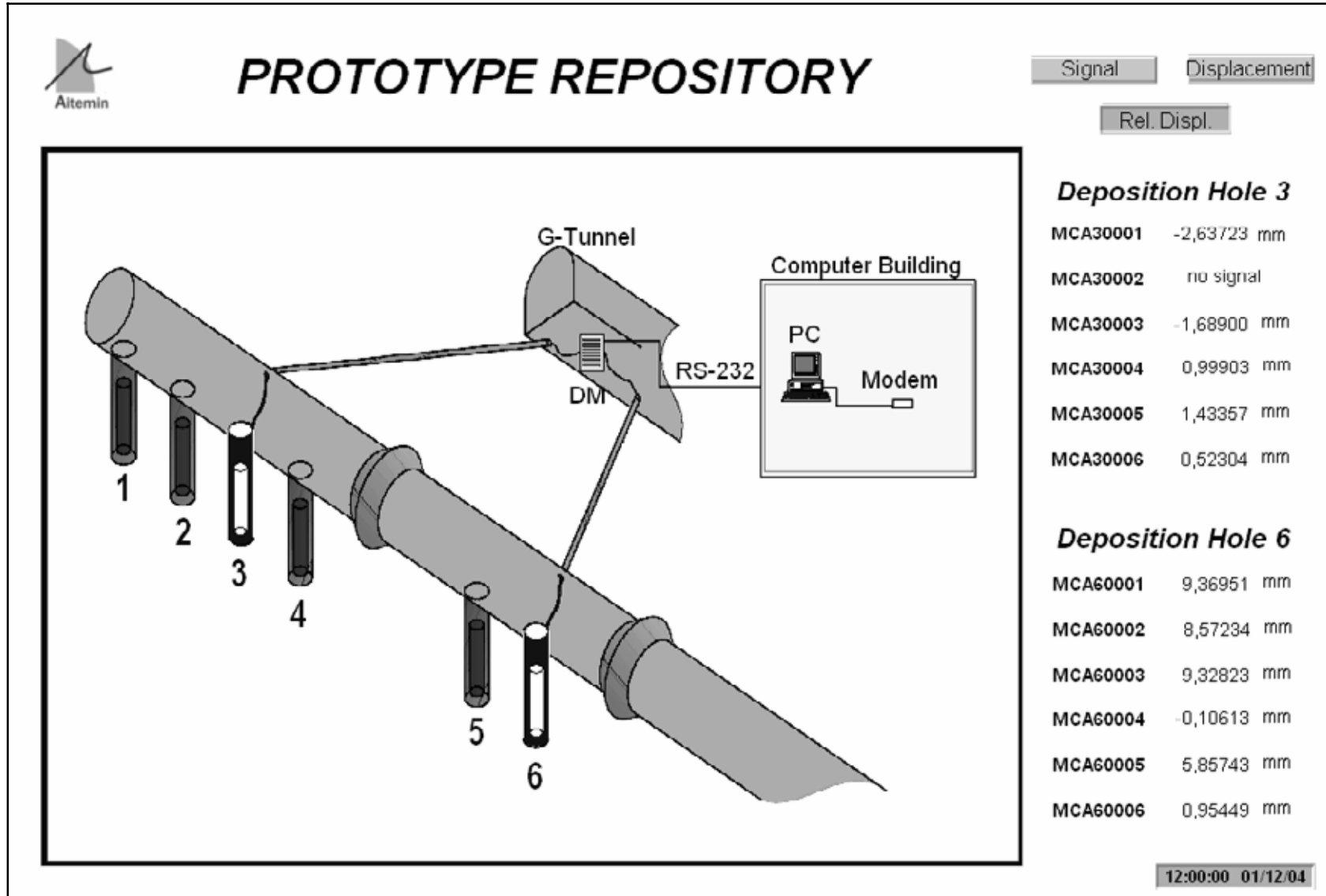

DEPOSITION HOLE 3

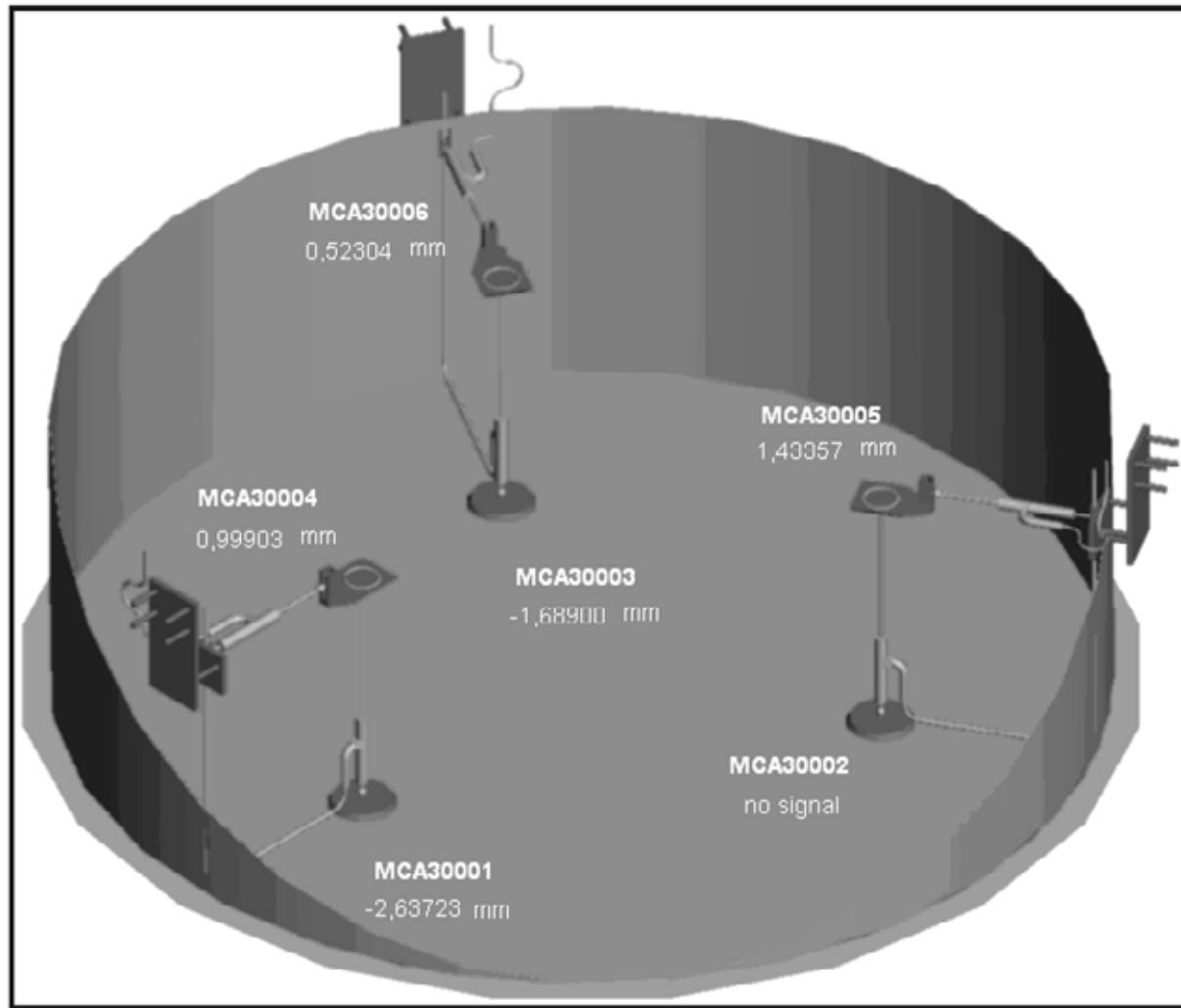

Signal Displacement

Rel. Displ.

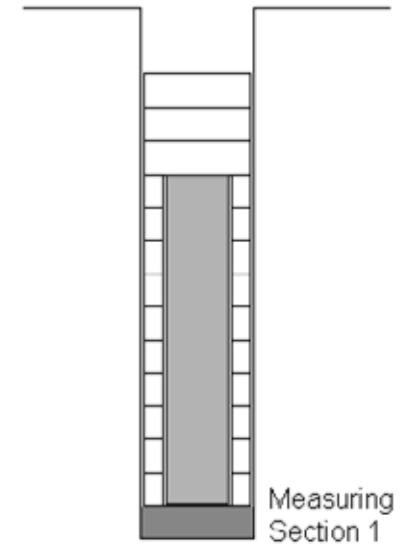

BACK

12:00:09 01/12/04

DEPOSITION HOLE 6

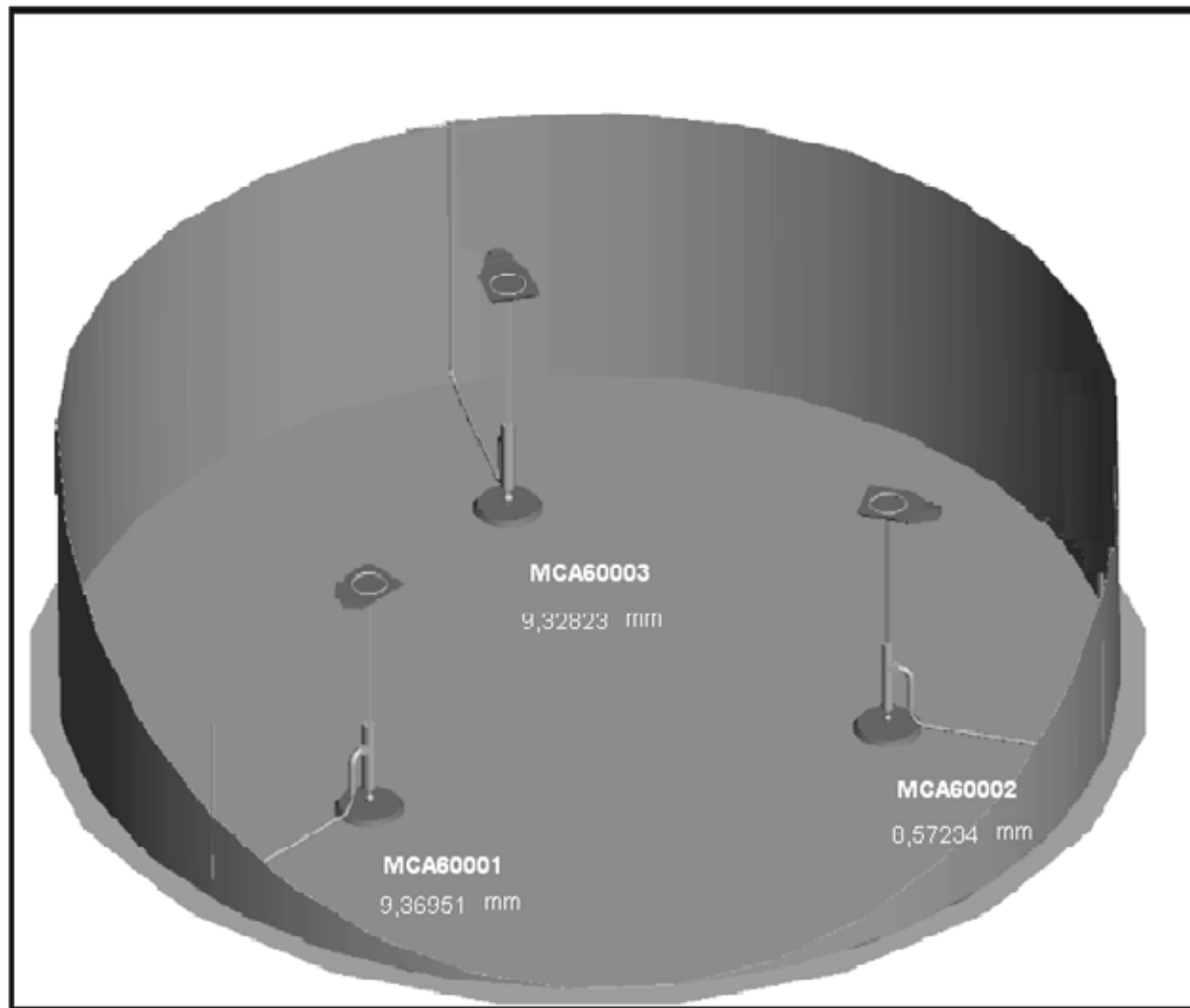

Signal Displacement

Rel. Displ.

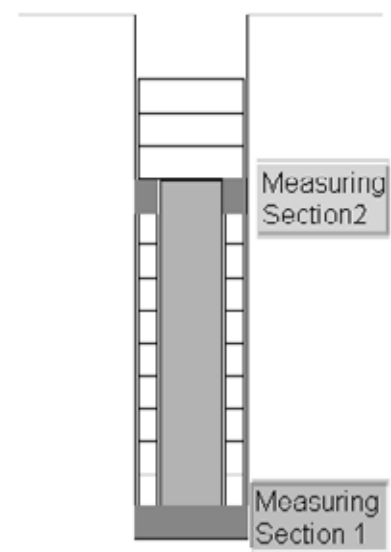

BACK

12:00:19 01/12/04

DEPOSITION HOLE 6

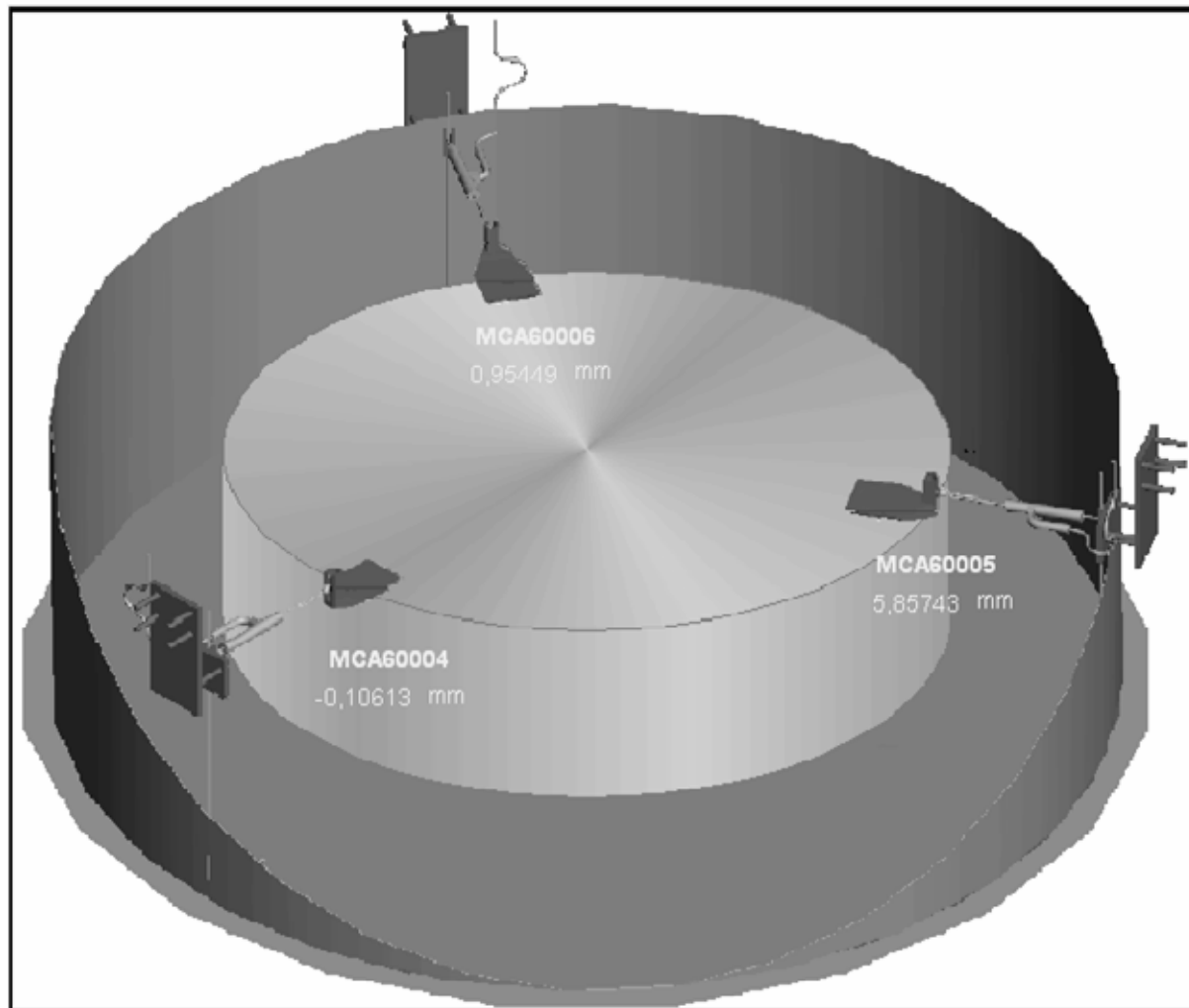

Signal Displacement

Rel. Displ.

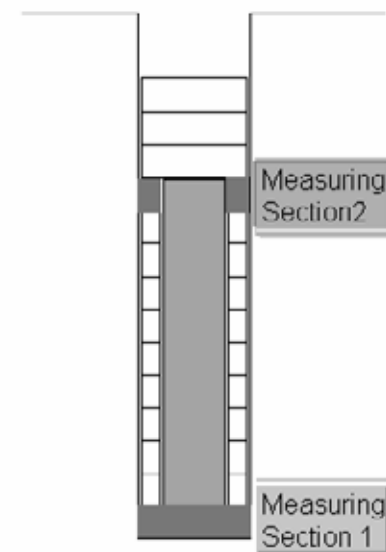

BACK

12:00:30 01/12/04

Appendix 9

Geoelectric monitoring

Rothfuchs T.,GRS



Gesellschaft für Anlagen-
und Reaktorsicherheit
(GRS) mbH

Prototype Repository Project

**Data Report
GEOELECTRIC MONITORING**

Status: 22 December 2004

Written by: ROT, WIE

Approved by: ROT

Contents

1	Introduction	279
2	Backfill Section 1	281
2.1	Layout of electrode array in the backfill of section 1	281
2.2	Tomograms of the backfill array in section 1	282
2.3	Actual Interpretation	289
3	Backfill Section 2	291
3.1	Layout of electrode array in the backfill of section 2	291
3.2	Tomograms of the backfill array in section 2	291
3.3	Actual Interpretation	294
4	Rock Section 2	295
4.1	Layout of electrode array in the rock between deposition boreholes 5 and 6	295
4.2	Tomograms of electrode arrays in the rock	296
4.3	Actual Interpretation	301
5	Buffer in Borehole 5 in Section 2	303
5.1	Layout of electrode array in the buffer of deposition boreholes 5	303
5.2	Tomograms of electrode array in the buffer	304
5.3	Actual Interpretation	307

1 Introduction

Within the frame of research activities in the prototype repository at Äspö GRS employs measurements of electrical resistivity to monitor water uptake in the drift backfill, the borehole buffer, and desaturation effects around one of the deposition boreholes.

The electrical resistivities in the buffer, the backfill, and around the boreholes are determined by use of multi-electrode arrays. The arrays consist of electrode chains. The resistivity distribution in the areas between the chains is determined by means of tomographic dipole-dipole measurements. The recording unit for these arrays is controlled remotely from Braunschweig / Germany through a telephone connection, which allows daily measurements of the in-situ resistivity distribution. From the measured apparent resistivity values the "true" resistivity distributions in the different parts are computed applying the latest inversion software.

In the geoelectric measurements advantage is taken of the dependence of the electrical resistivity in materials on the water (solution) content. In order to interpret the resistivity values in terms of water content the data are to be compared with laboratory calibration results which are available for the different materials.

In the following, quarterly calculated inversion data for the different arrays are provided in the form of tomograms. Additional data for smaller time periods can be made available on demand.

2 Backfill Section 1

2.1 Layout of electrode array in the backfill of section 1

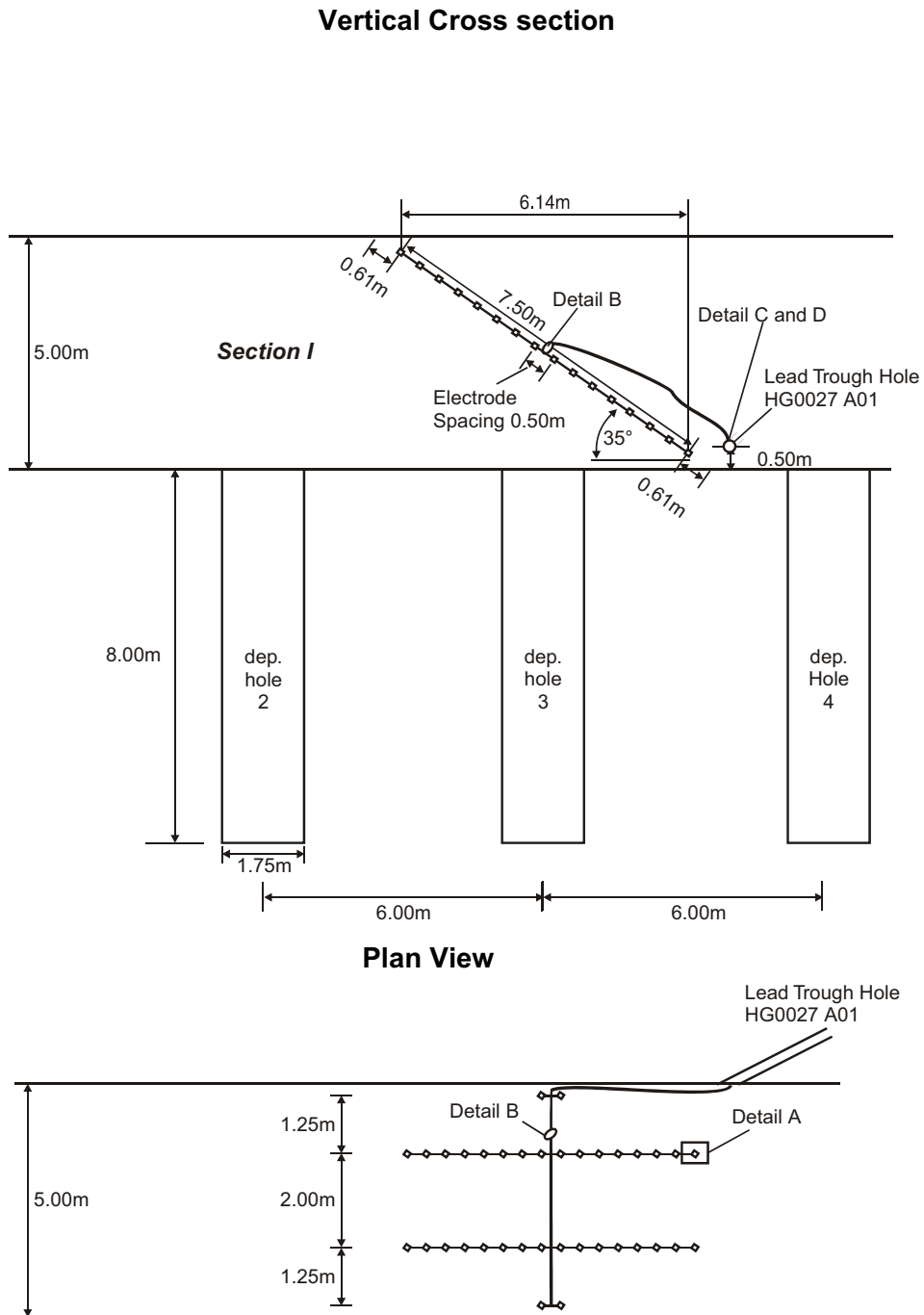
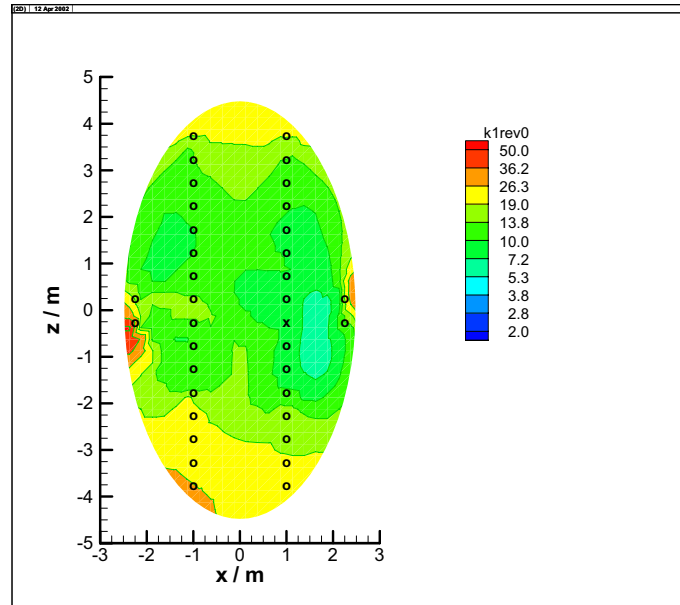
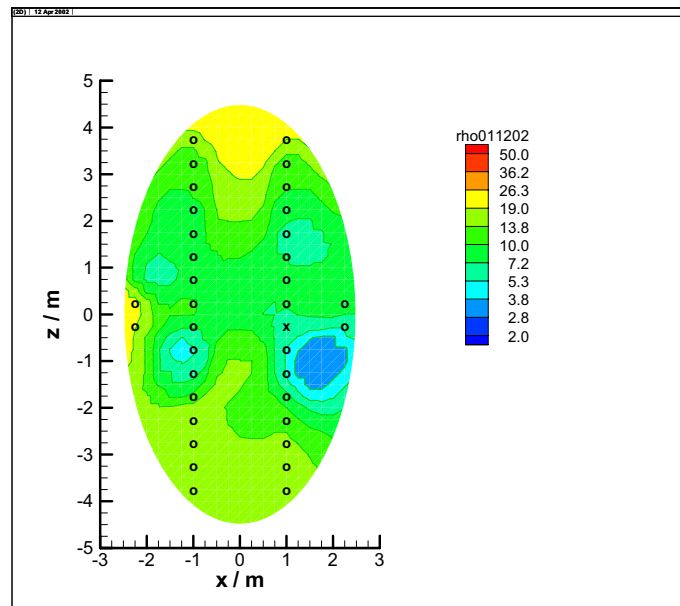

Figure 2-1: Electrode array in the backfill in section 1.

2.2 Tomograms of the backfill array in section 1



2001-10-27



2001-12-02

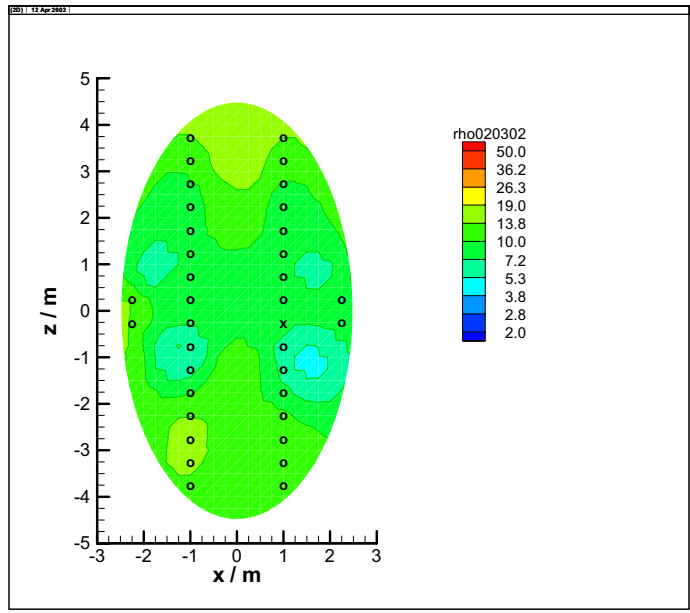

2002-03-02

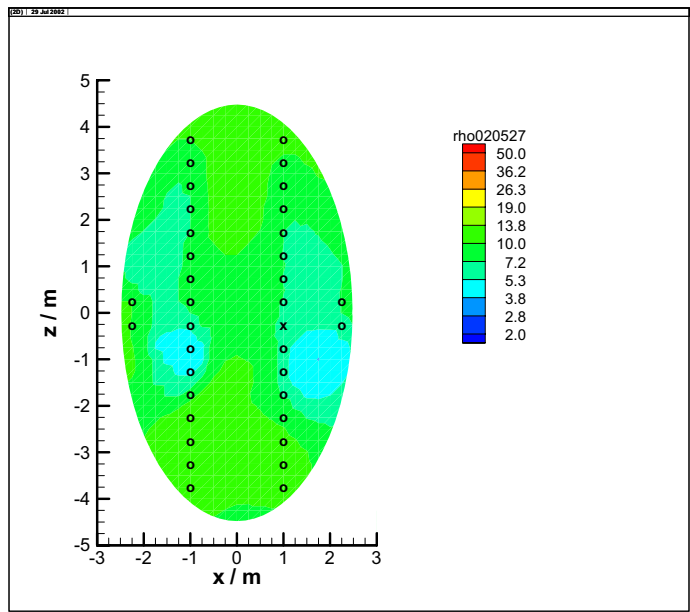

2002-05-27

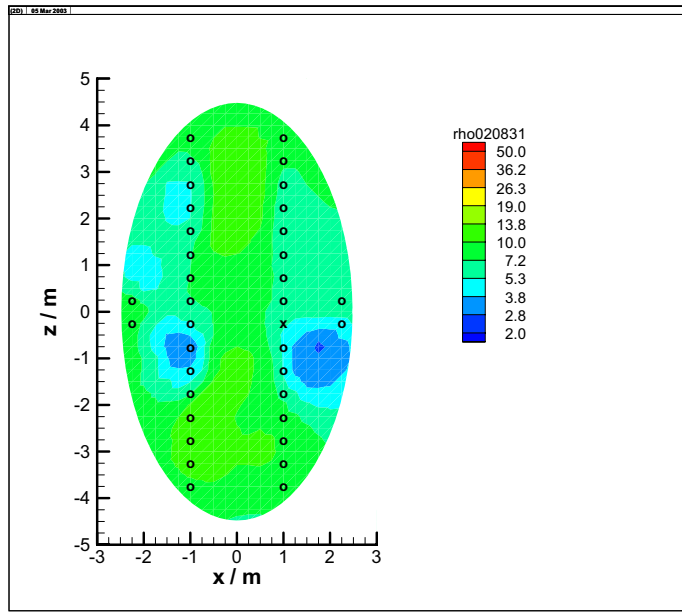

2002-08-31

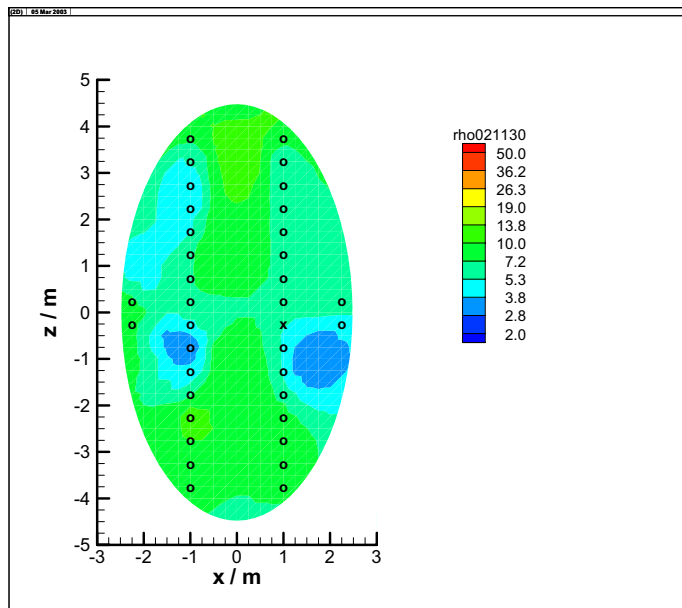

2002-11-30

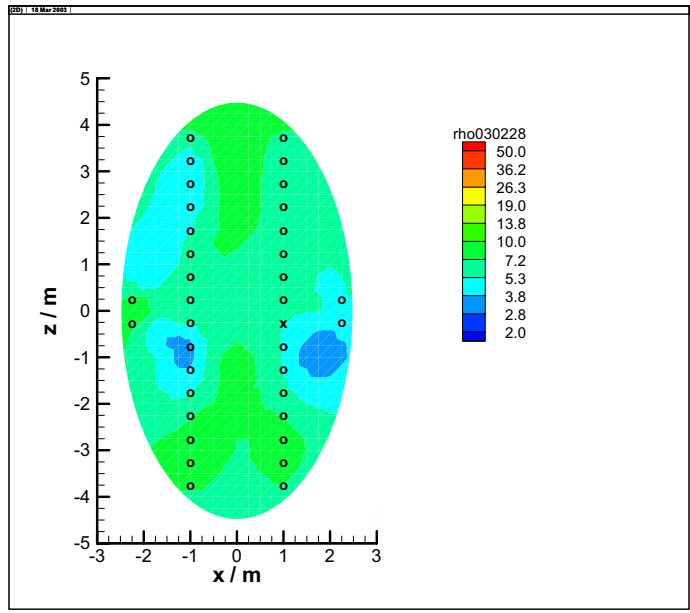

2003-02-28

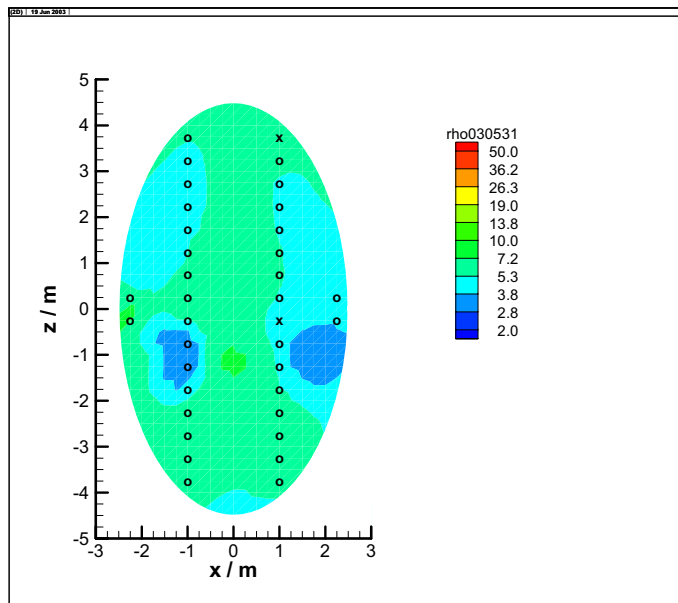

2003-05-31

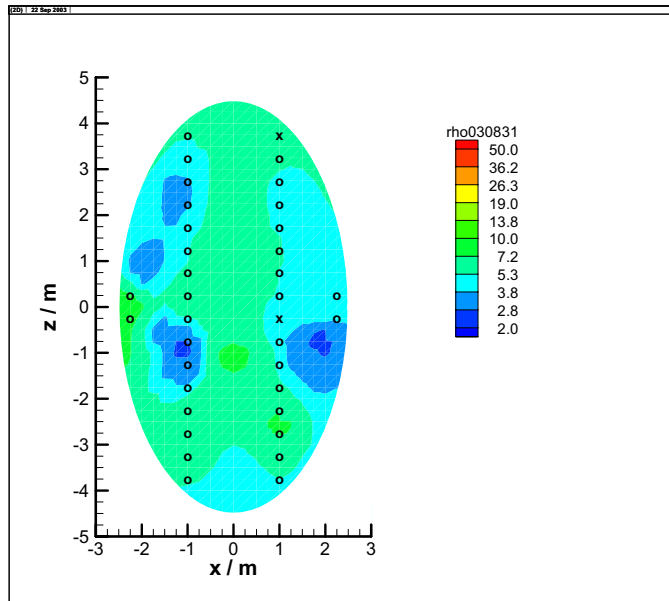

2003-08-31

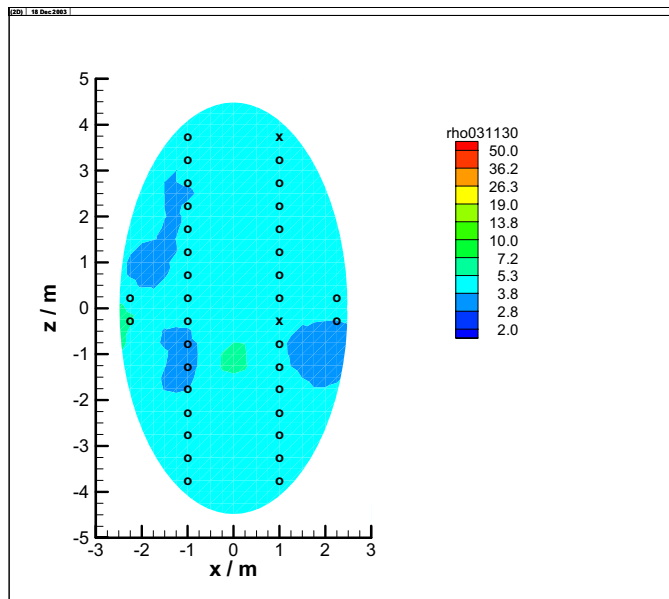

2003-11-30

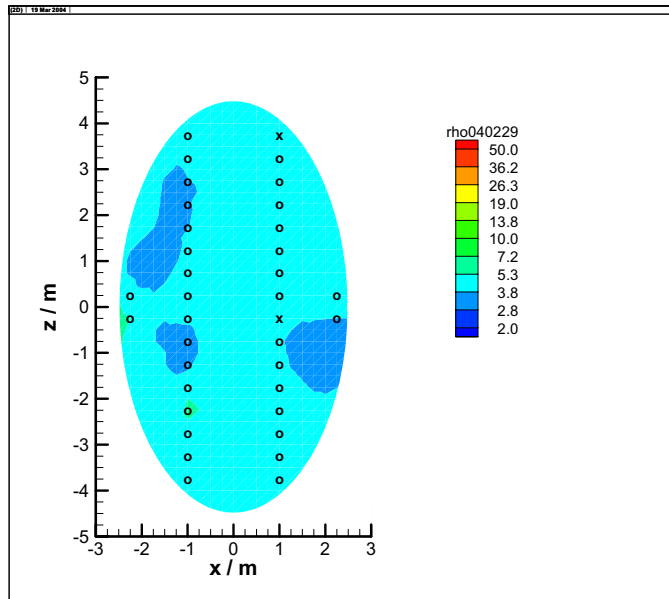

2004-02-29

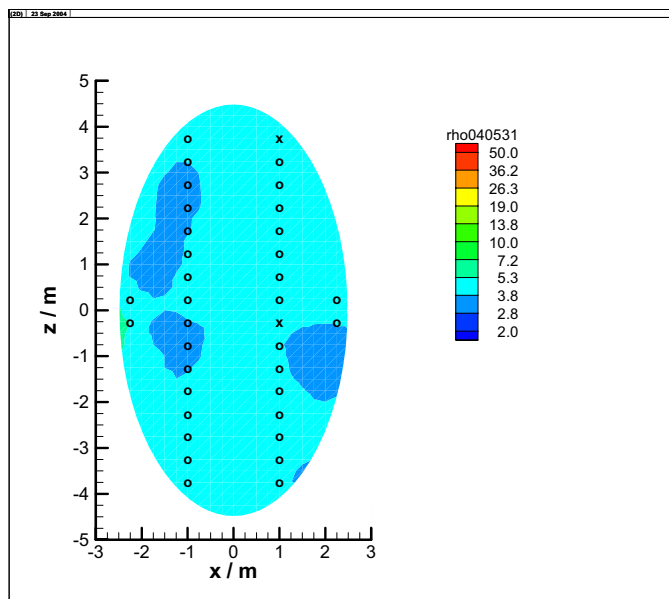

2004-05-31

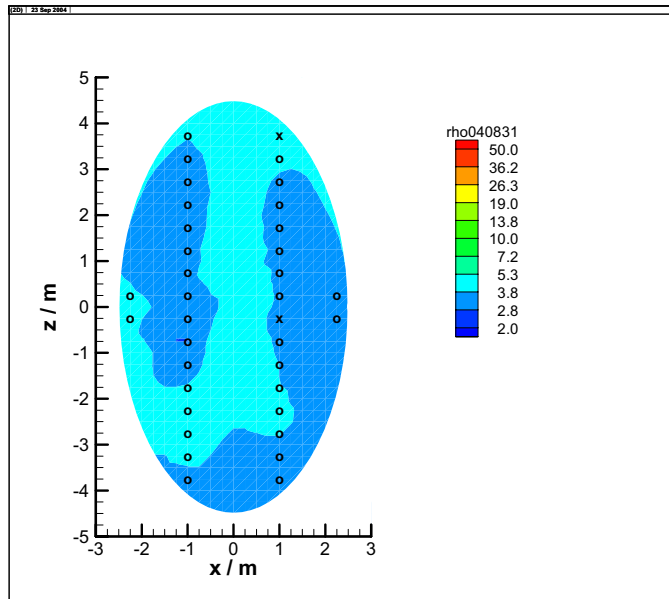

2004-08-31

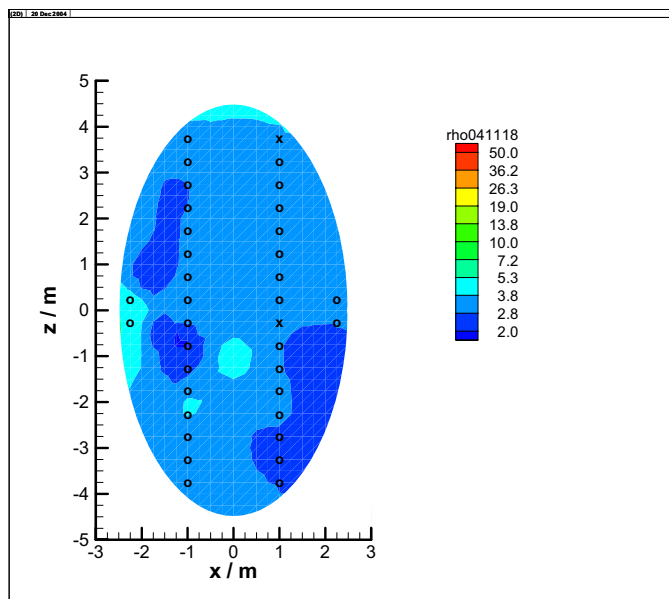

2004-11-18

2.3 Actual Interpretation

The initial resistivity value of the backfill in October 2001 is about 10 to 14 Ωm corresponding to a water content of 13 to 14%. In the following month the resistivity reduces to about 7 to 10 Ωm which corresponds to a water content of about 14 to 16%. However, this reduction in resistivity is most likely generated by the wet (light blue) areas close to the electrode chains. These wet areas are the consequence of moistened backfill used during installation of the electrodes for better covering of the electrode chains. From then on, the resistivity decreases continuously, starting near the drift walls and progressing into the drift centre. Until December 2004, a very homogeneous resistivity distribution is reached; with a value around 3 Ωm corresponding to a water content of 21 - 22 %. The backfill is therefore not far from full saturation.

Besides this overall trend, minor changes in the tomograms from month to month are visible near the edges of the gallery, especially a light blue area on the right side of the tomograms is more or less pronounced. These are no real anomalies, but are caused by the fact that inaccuracies in the measurements can lead to the accumulation of "ghost" anomalies in areas of lower sensitivity. The areas of lower sensitivity are typically the edges of the model. In case of the blue area on the right side of the tomograms, the sensitivity is more reduced because one of the electrodes (marked with an "x" in the tomograms) is not active, as its cable broke after installation during backfilling.

The resistivity is also slightly decreased by the temperature increase in the backfill. Backfill temperature amounted to maximal 32 °C in March 2003. The temperature increase can result in a resistivity reduction by not more than 1 Ωm .

On May 2, 2003, the upper right electrode (also marked with an "x" in the tomogram from May 31, 2003) was lost. The reason is probably a cable failure. It is not clear whether this is already a corrosion effect.

3 Backfill Section 2

3.1 Layout of electrode array in the backfill of section 2

The array layout in the backfill of section 2 is identical to that located in section 1, except for the fact that the array has been placed above deposition borehole #6 instead of #3.

3.2 Tomograms of the backfill array in section 2

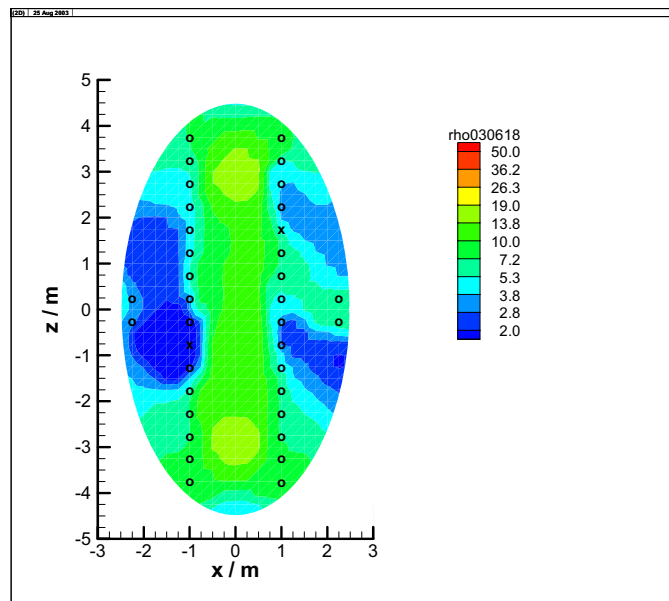

2003-06-18

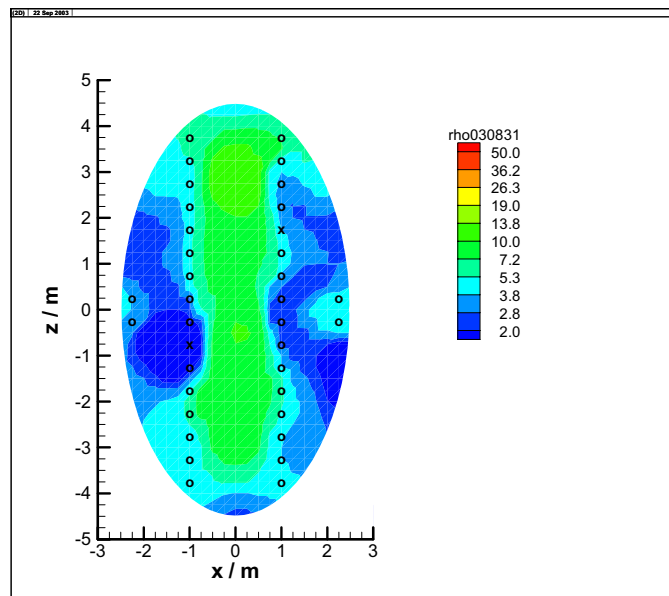

2003-08-31

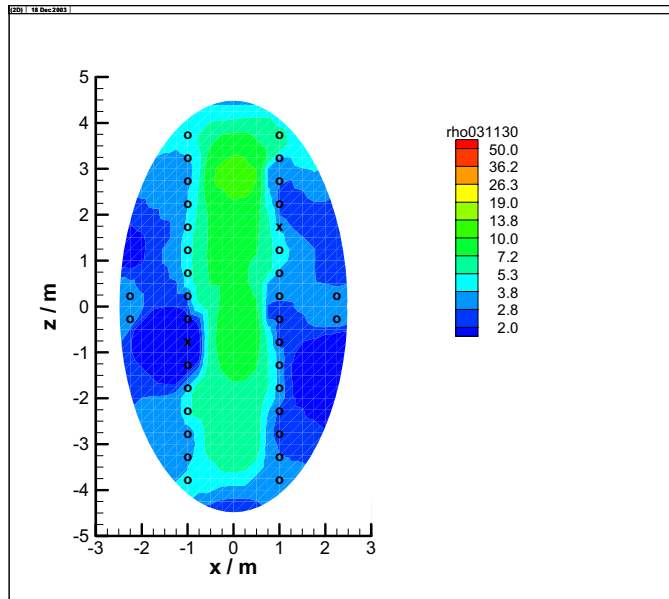

2003-11-30

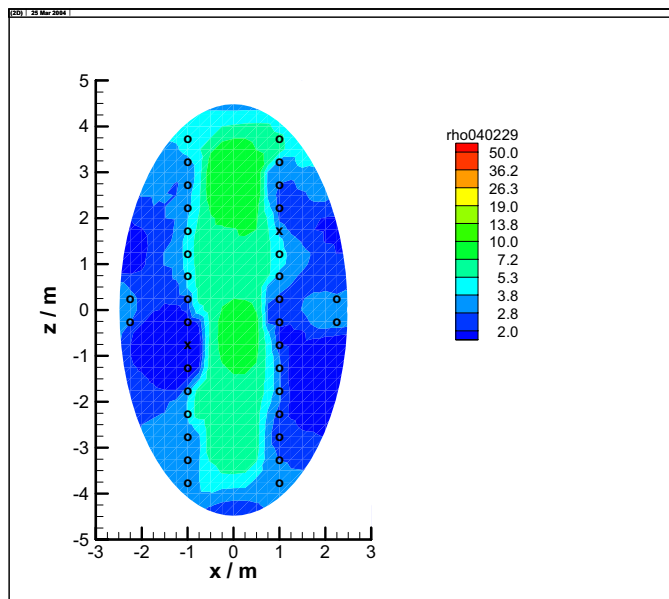

2004-02-29

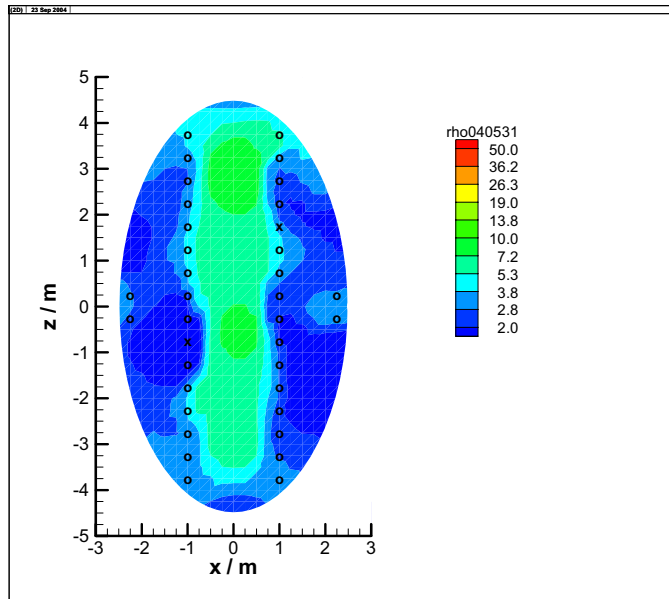

2004-05-31

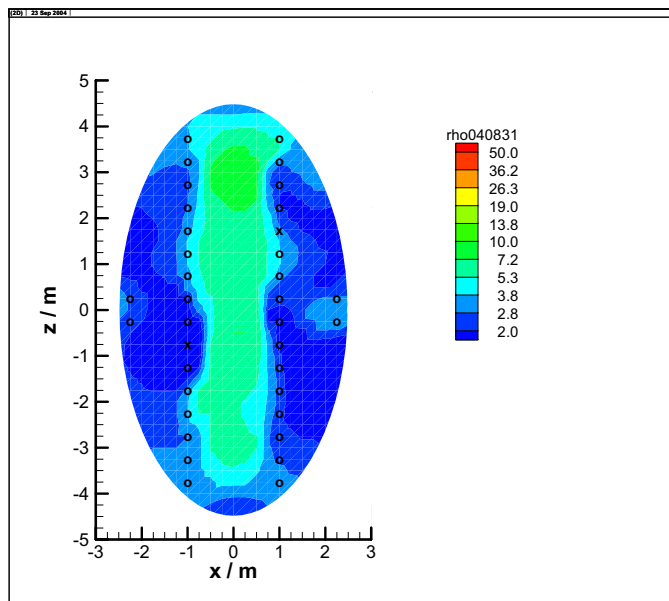

2004-08-31

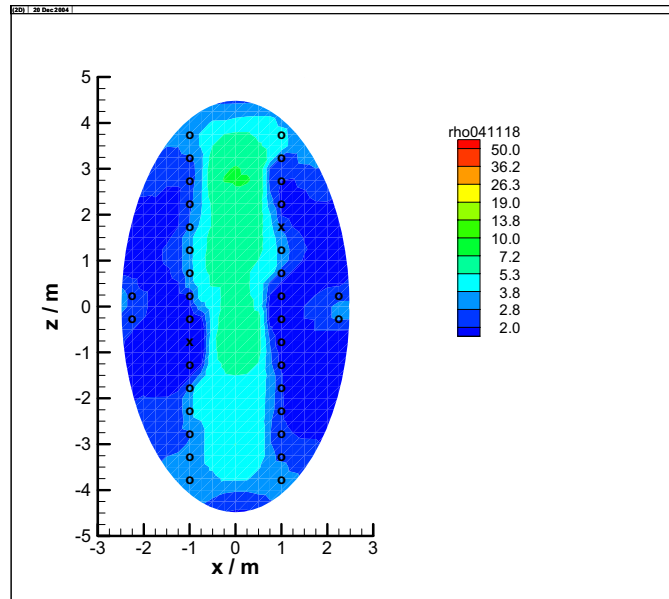

2004-11-18

3.3 Actual Interpretation

The first measurement performed on June 18, 2003 in section 2 shows a much lower resistivity than the early measurements in section 1. Obviously, the backfill had a considerably higher water content already during installation. This observation was also made during instrumentation. Resistivity is decreasing further from the drift walls. Close to the walls it ranges below $3 \Omega\text{m}$; the backfill is therefore not far from full saturation. In the centre resistivity has decreased to values between 3 and $7 \Omega\text{m}$ corresponding to a water content of about 15 to 20%.

4 Rock Section 2

4.1 Layout of electrode array in the rock between deposition boreholes 5 and 6

A) Vertical cross section

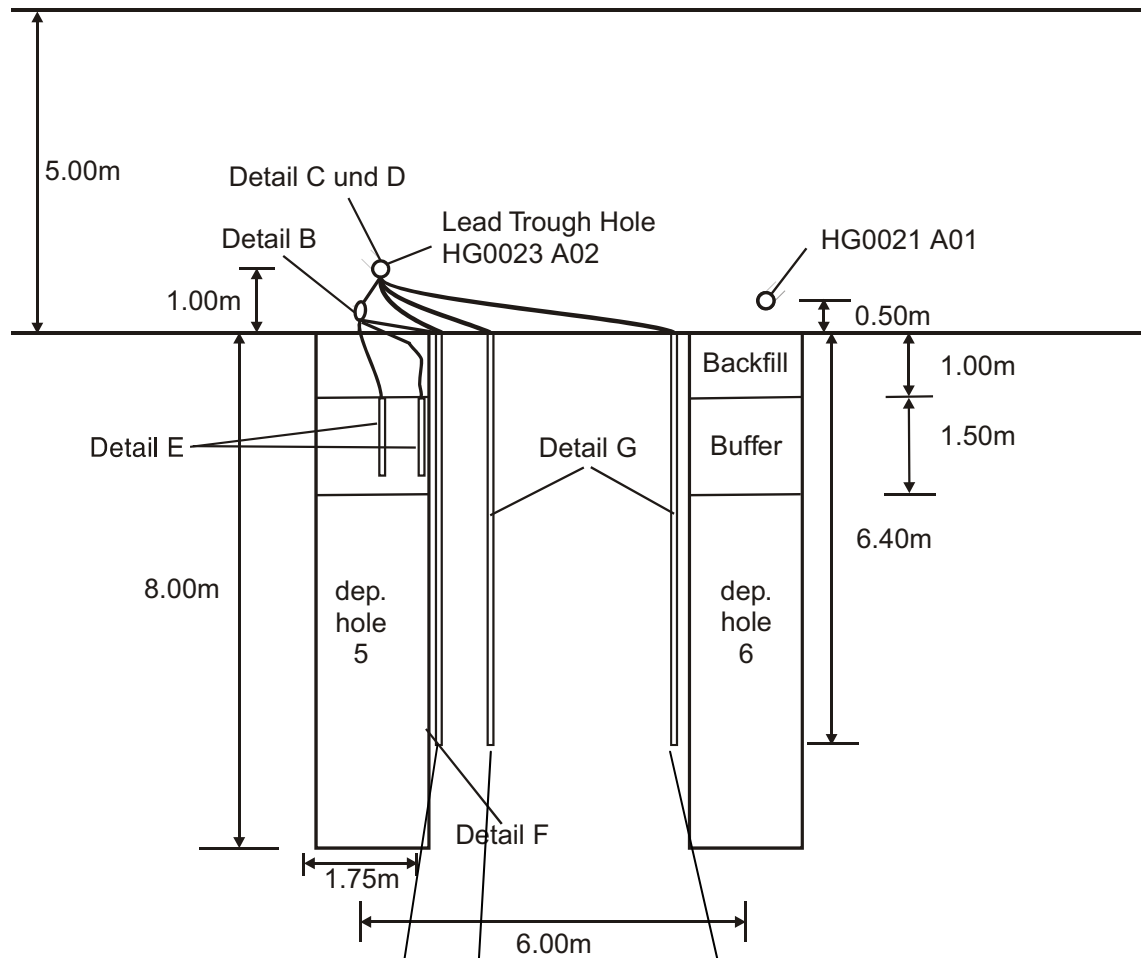

B) Plan view

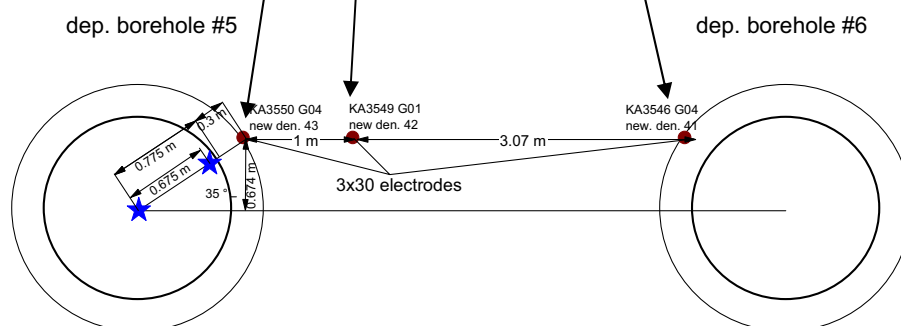

4.2 Tomograms of electrode arrays in the rock

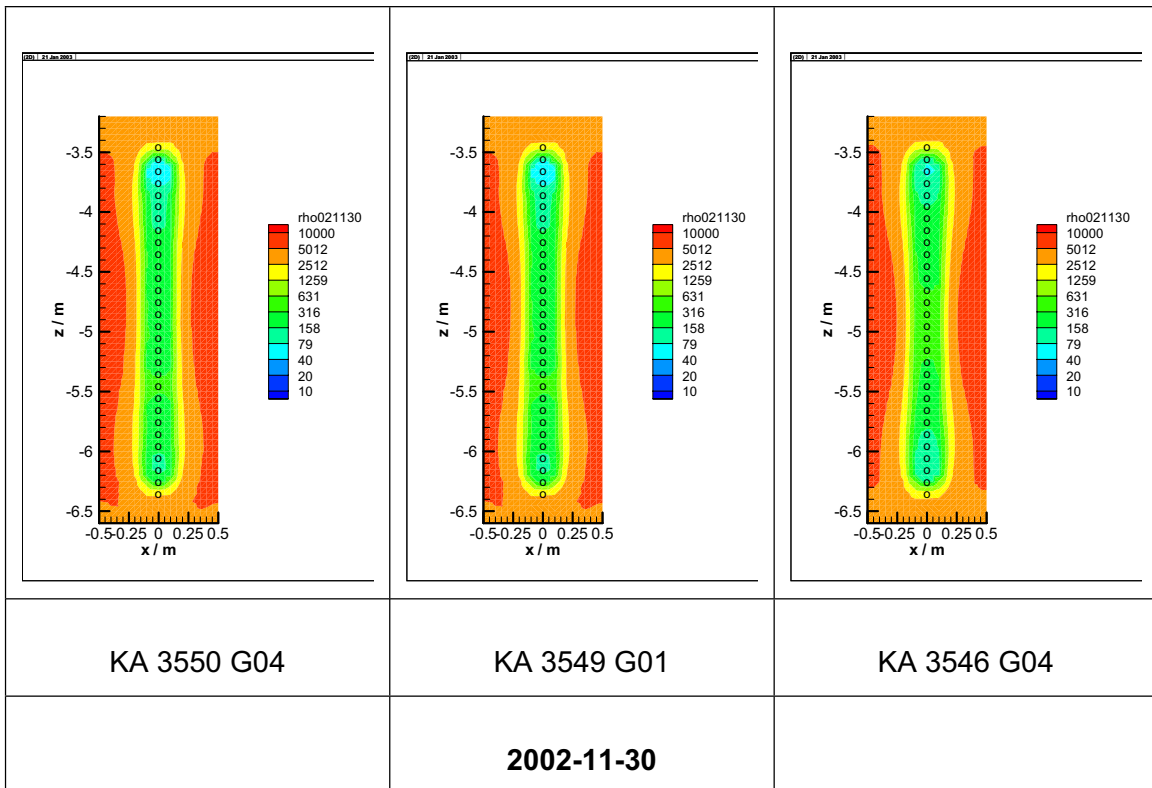
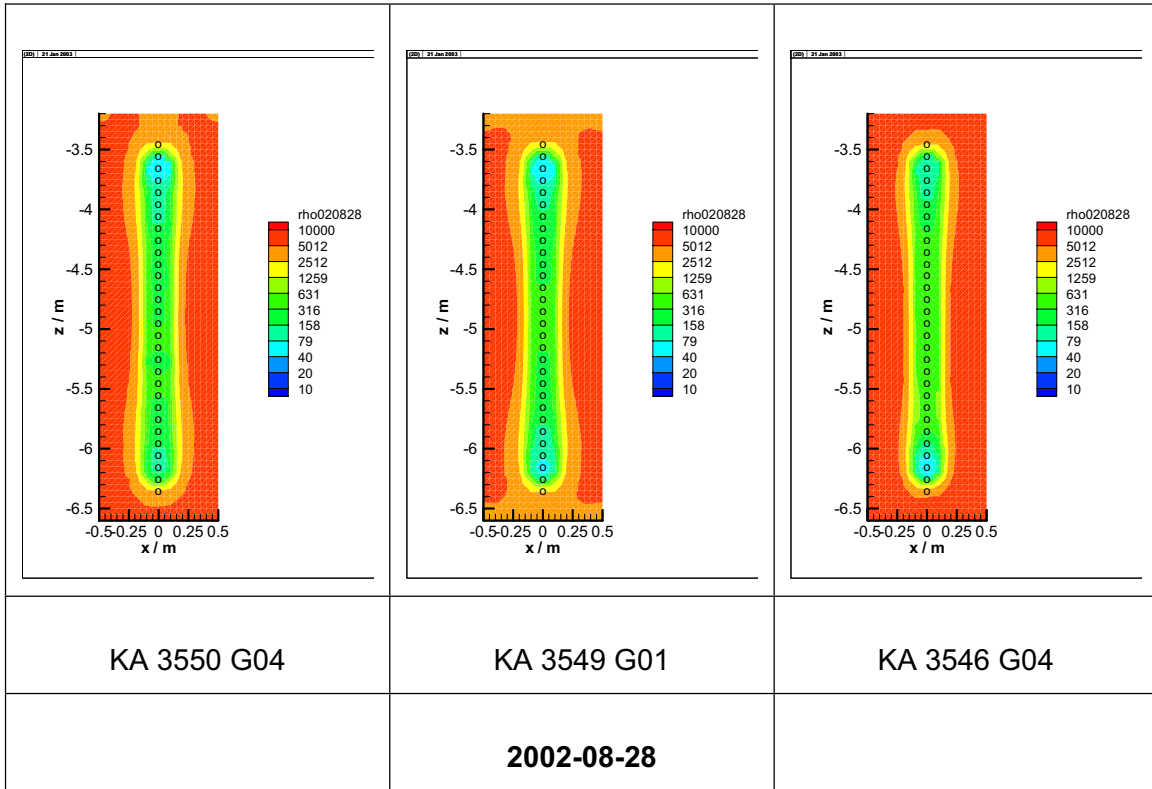

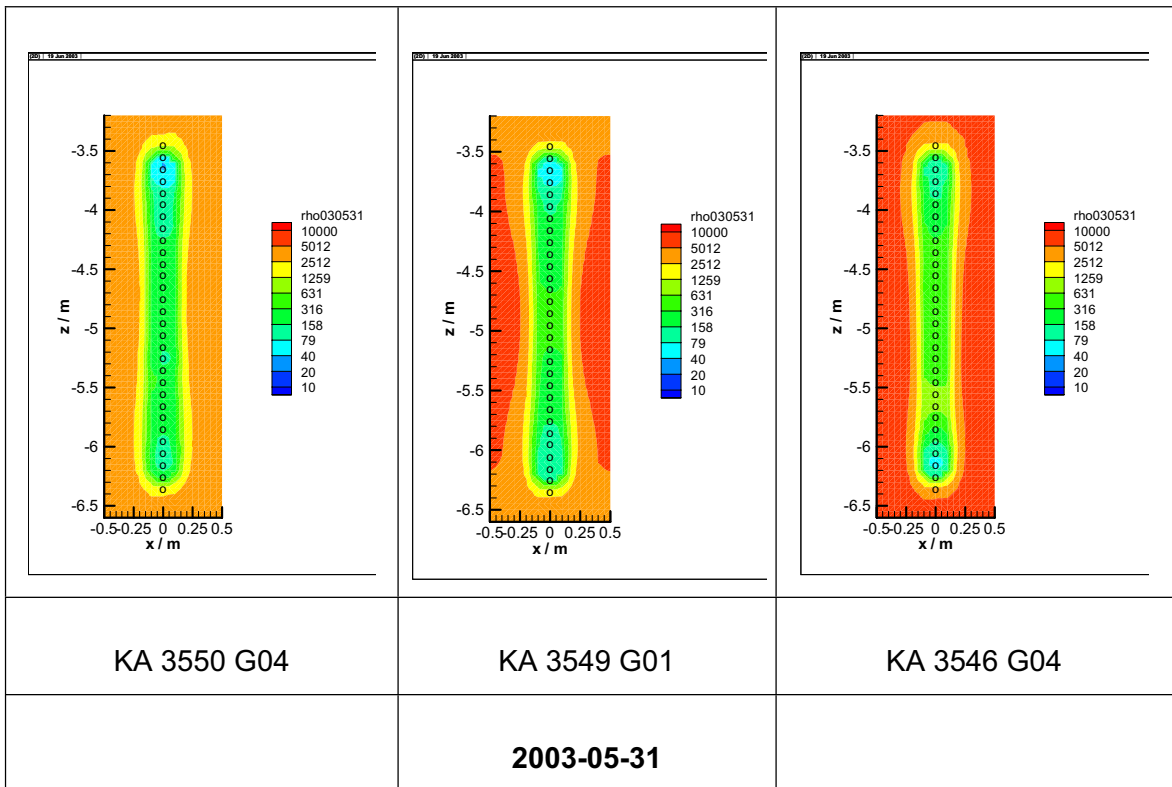
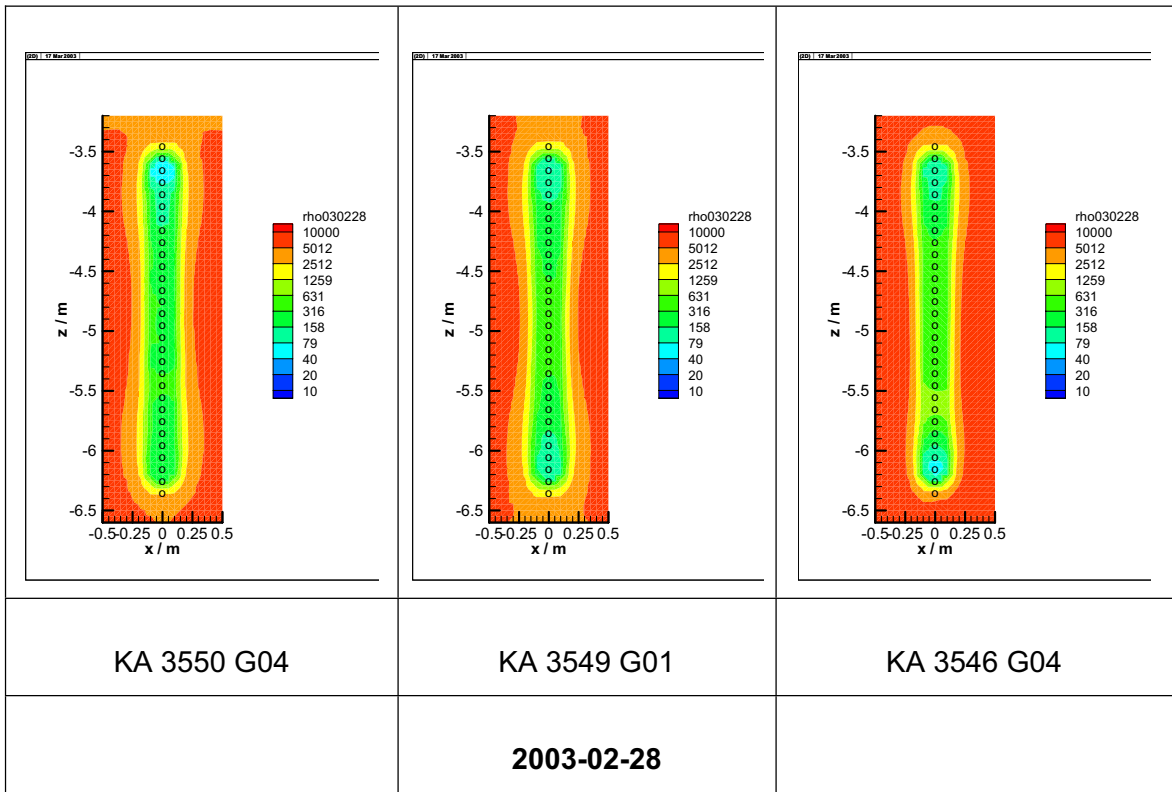

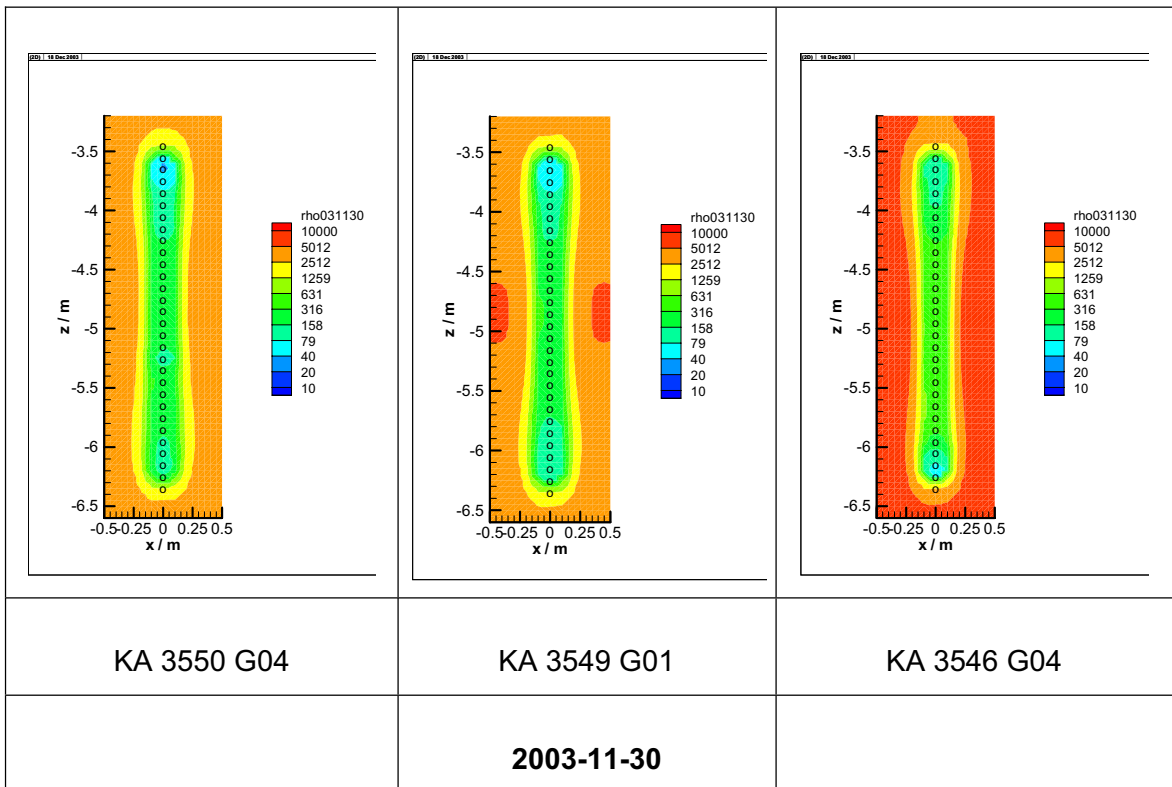
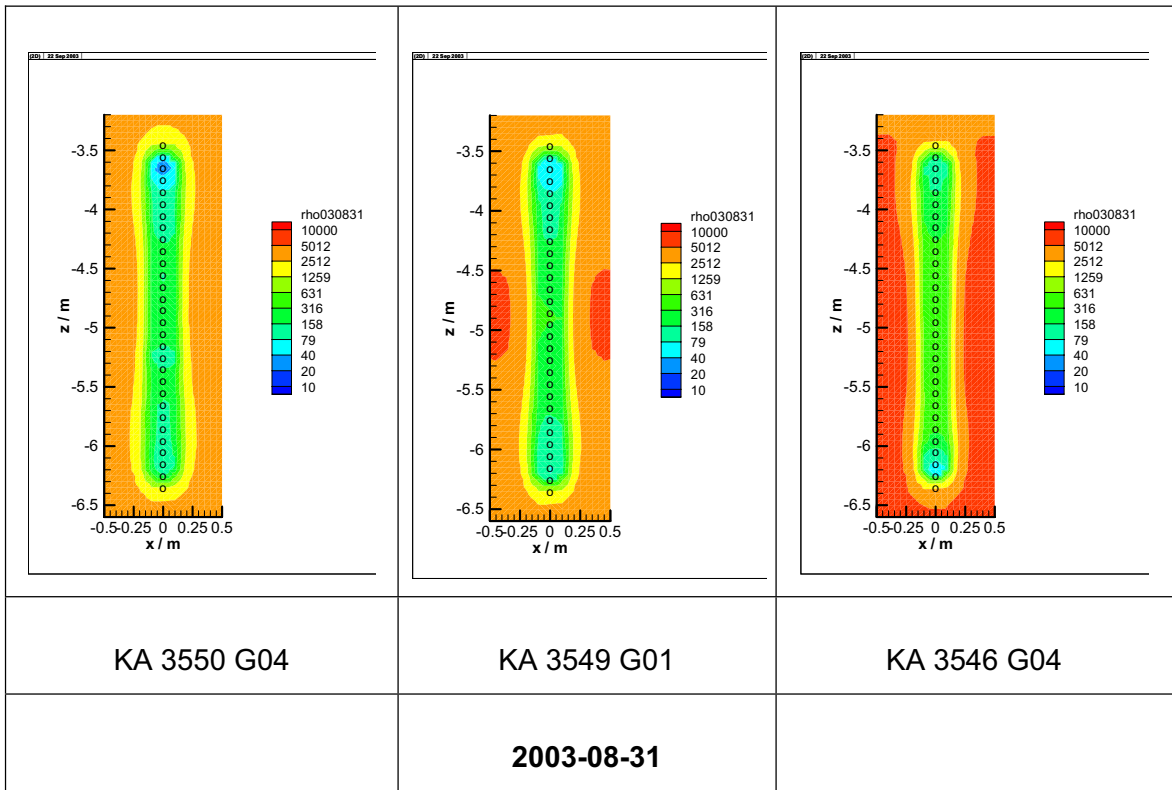

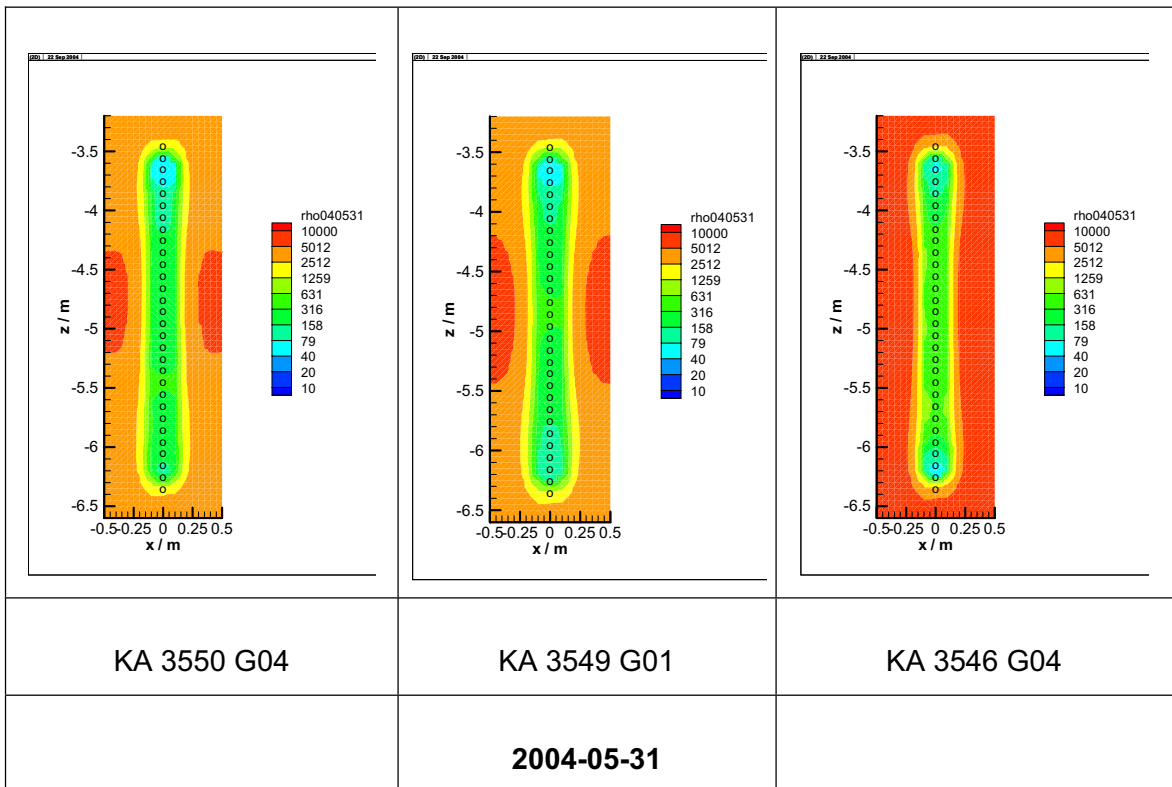
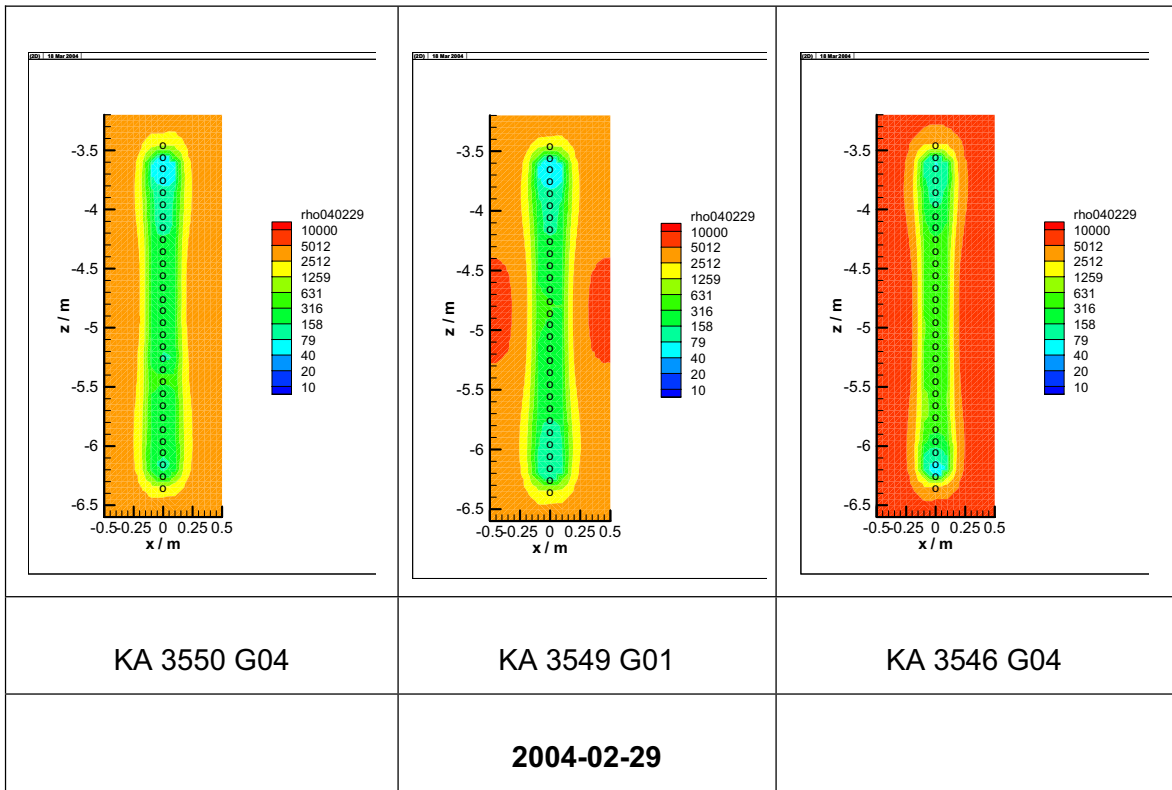

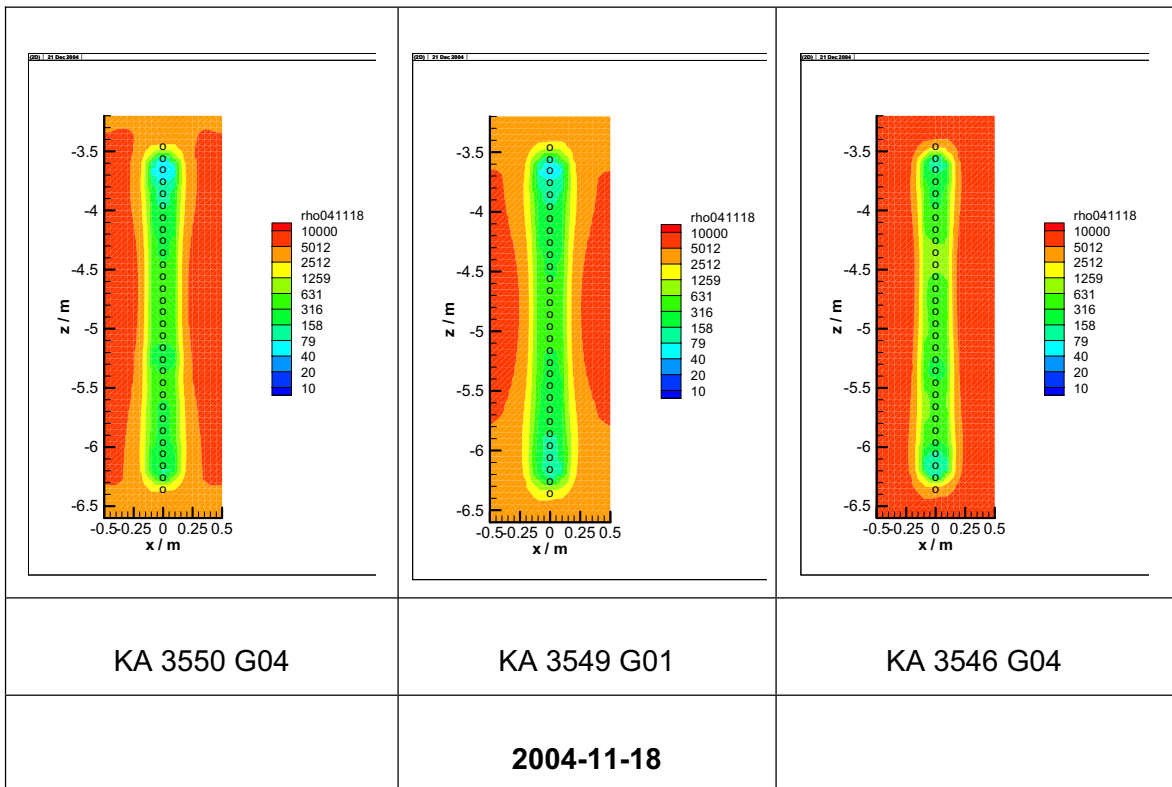
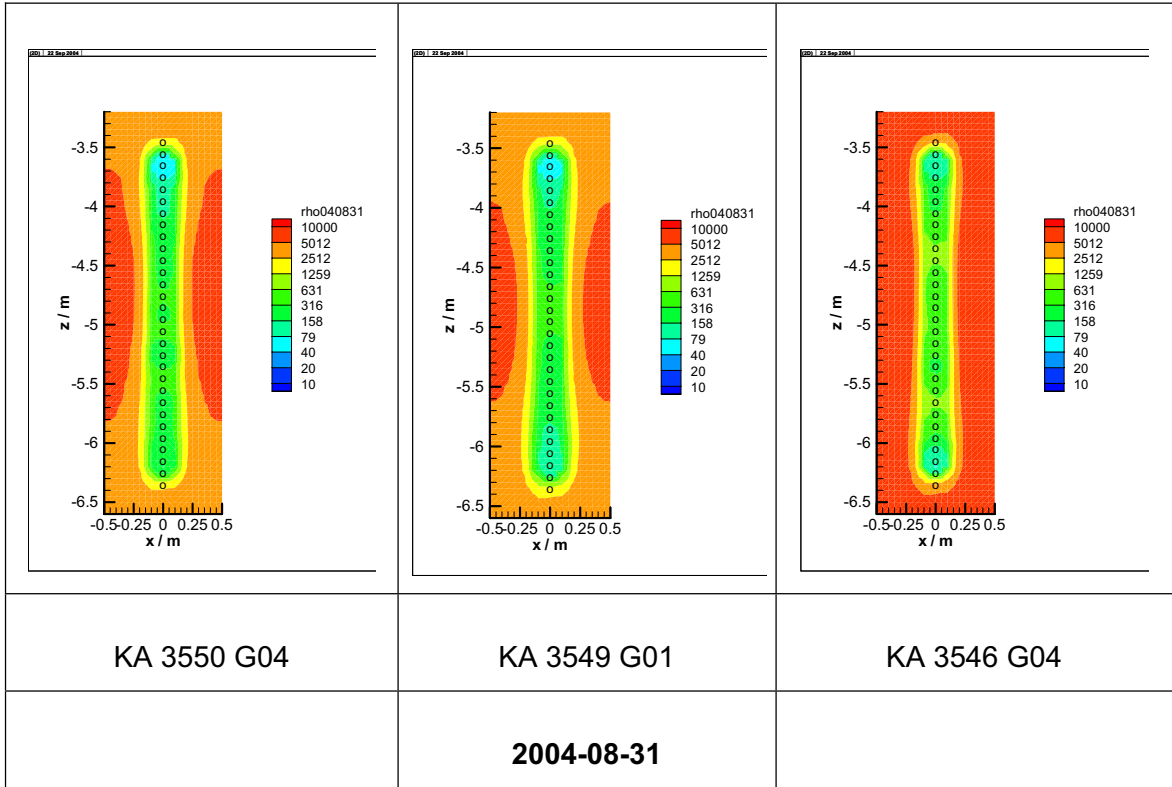

4.3 Actual Interpretation

The resistivity distributions along the three electrode chains installed in the rock are quite similar to each other and show no significant variation in time until April 2003. Close to the electrodes, the resistivity ranges around 200 Ωm . This value characterizes the water-saturated concrete used for backfilling the electrode boreholes. Further away from the boreholes, the resistivity rises to values of 2000 to 7000 Ωm which is characteristic for water-saturated granite.

From April 2003 on, there is a slight decrease in resistivity in the rock near deposition hole #5. This coincides with installation of the buffer which also stopped the pumping of water from the open deposition hole. Apparently, this had caused a slight desaturation of the rock which recovered. From February 2004, resistivity seems to slightly increase again. Near the deposition hole #6, no such effect was detected.

For the plane between the boreholes KA 3550 G04 and KA 3549 G01, also dipole-dipole measurements are performed. Results of these will be included in a future report.

5 Buffer in Borehole 5 in Section 2

5.1 Layout of electrode array in the buffer of deposition boreholes 5

The array is made up of the electrodes located in the buffer at the top of deposition hole #5 (see figure) and of the electrodes in the upper part of borehole KA 3550 G04 in the rock (see figure in section 4.1).

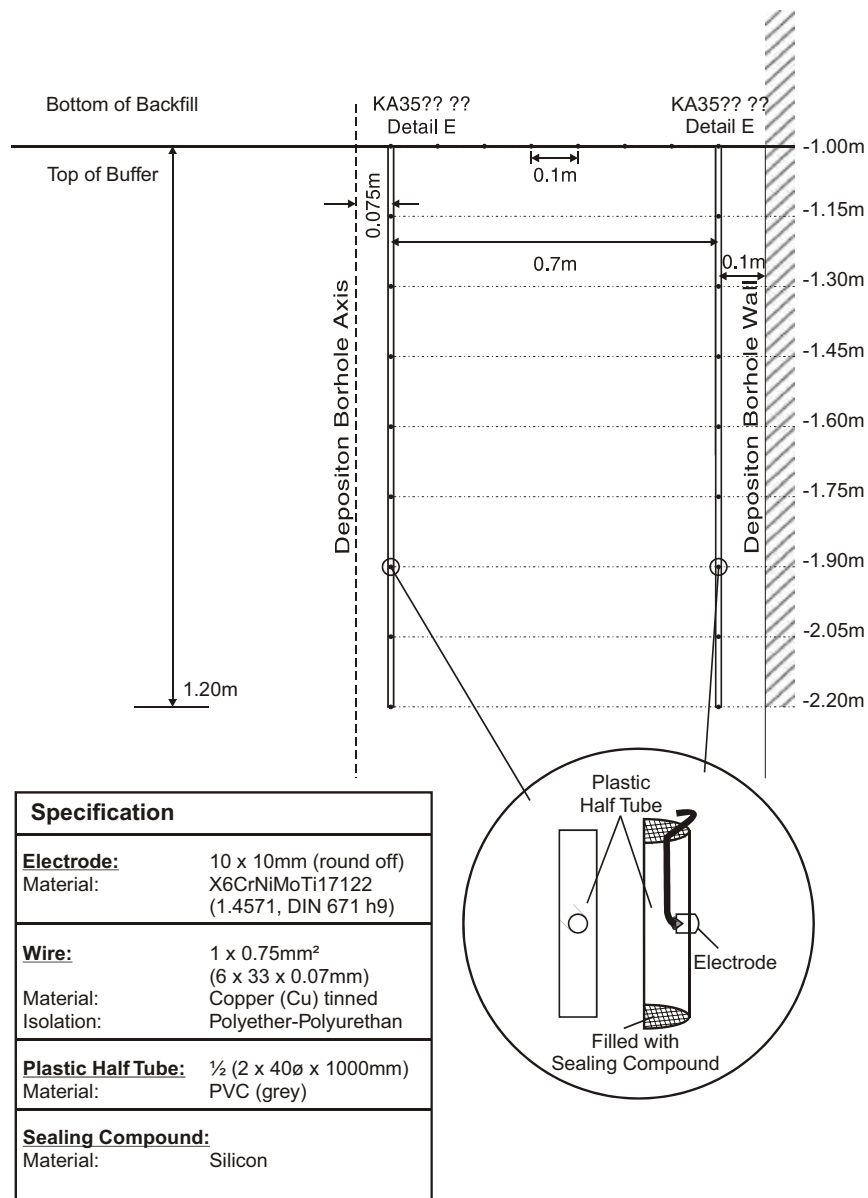

ELECTRODE DETAIL E VERS 01.CDR

5.2 Tomograms of electrode array in the buffer

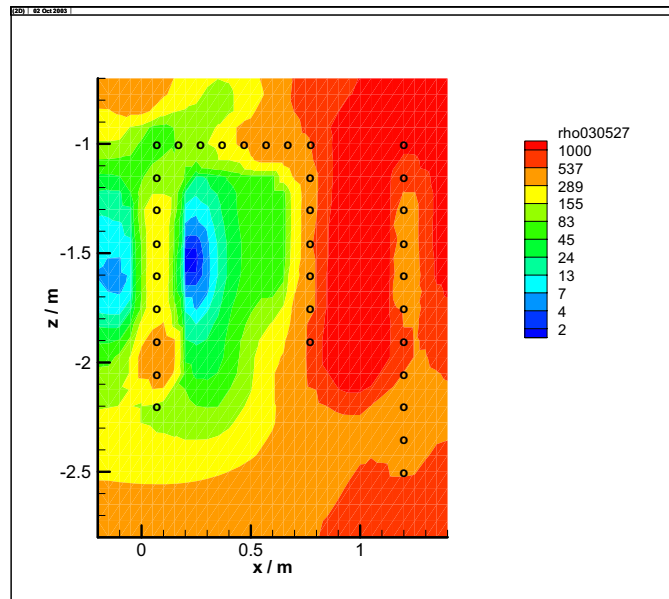

2003-05-27

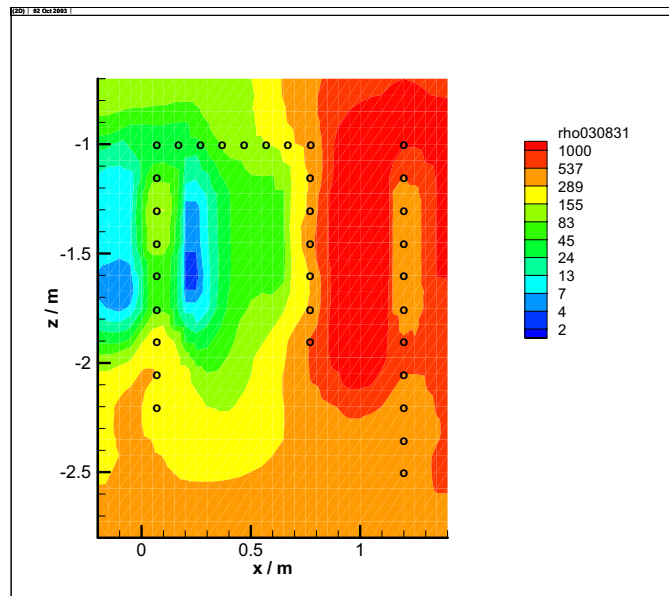

2003-08-31

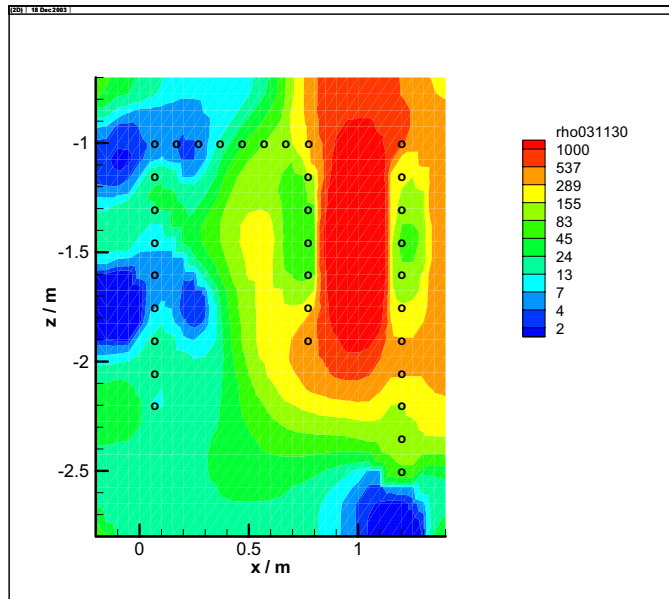

2003-11-30

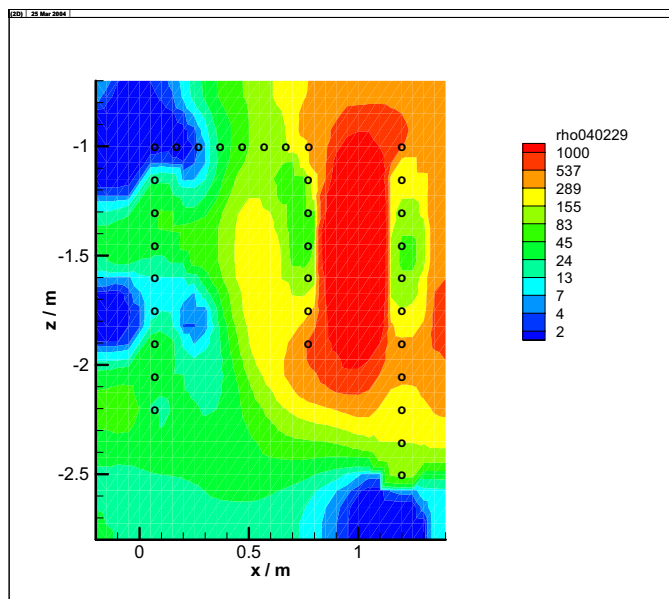

2004-02-29

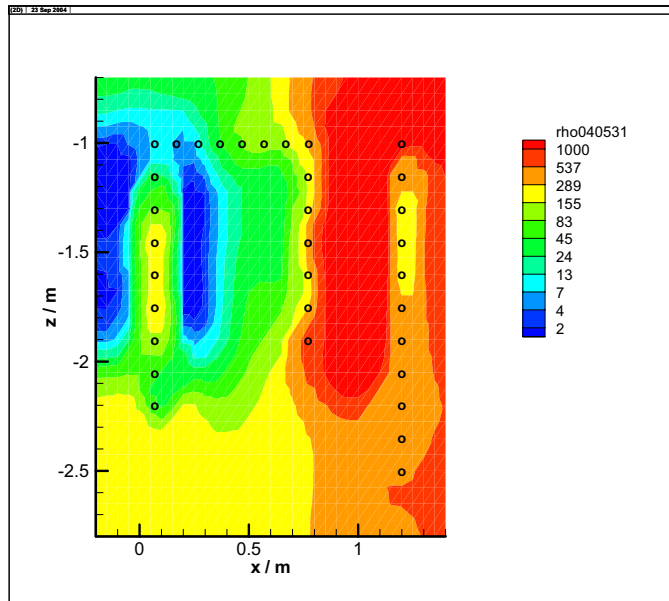

2004-05-31

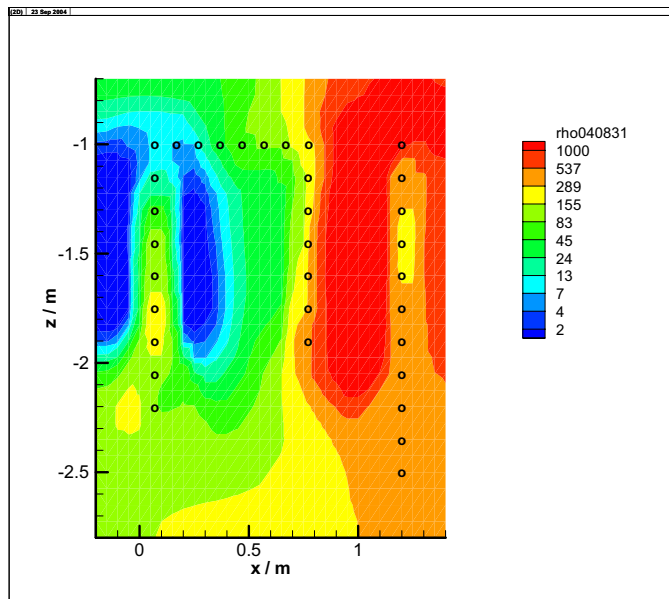

2004-08-31

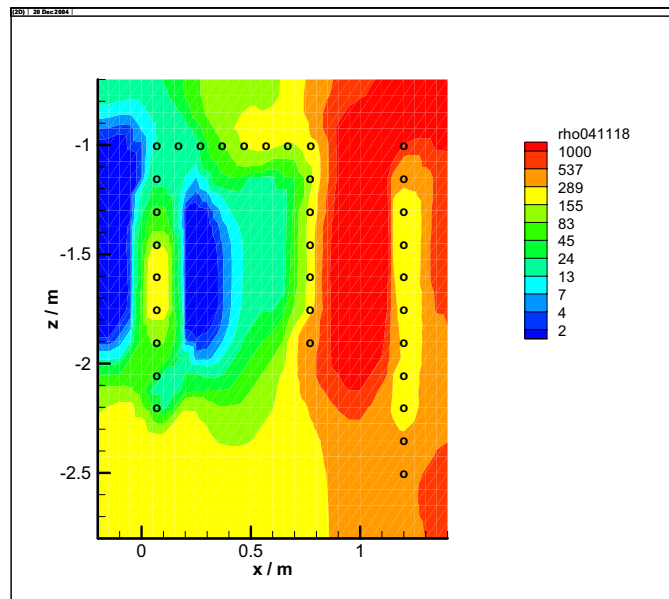

2004-11-18

5.3 Actual Interpretation

The tomogram of May 2003 (first measurement) shows the high resistivity (above $1000 \Omega\text{m}$) of the rock on the right side and the low resistivity of the buffer (below $80 \Omega\text{m}$). The picture is somewhat distorted by the fact that along the electrode chains the resistivity is increased compared to the undisturbed buffer. The increased resistivity along the electrode chains can be attributed to the refilling of the electrode boreholes with bentonite powder produced during borehole drilling. It was, however, expected that the difference will diminish with time, especially if the buffer takes up water. The tomograms of the following months show a progressing decrease of resistivity in the buffer. While the overall behaviour is rather clear, it is difficult to interpret buffer resistivity in terms of water content. In nearly all the buffer monitored by the array the resistivity has decreased to values below $24 \Omega\text{m}$ by November 2004.

Appendix 10

Stress and strain in the rock



**STRESS AND STRAIN MEASUREMENT OF THE ROCK MASS
PROTOTYPE TEST AT ÄSPÖ**

Measuring period
2004-09-01 – 2004-11-30

Martin Edelman
Kennert Röshoff

2005-01-21

1 Extent

BBK AB and NCC Teknik have, on commission of SKB, ÄSPÖ Hard Rock Laboratory, performed rock mechanical measurements in the Prototype tunnel at Äspö. The measurement program comprises registration of the stress and strain response around the two deposition holes during drilling and heating of the rock mass.

In the first phase, the response of the rock mass was monitored during the drilling of the two canister holes. The second phase, which is the subject of this report, includes the response registered during a heating phase. The heating experiment started on 2003-05-08 and will continue for about five years.

The goal of the instrumentation is to monitor the stress, strain and deformation changes due to heating of the rock mass surrounding the deposition holes. Instrumentation has been installed to monitor the relative changes in intact rock as well as across fractures.

The commission extends over field measurement and evaluation.

BBK AB is responsible for measuring equipment, the mobilization, field measurement, the computer processing. BBK AB and NCC Teknik are responsible for the interpretation and reporting of the measurements.

This report presents the measurement results during the period of the heating phase from 2004-09-01 to 2004-11-30.

2 Technical background

2.1 Summary of instruments installed

The instrumentation for monitoring rock mechanical response was installed in two stages. The instruments used to monitor the drilling phase of the canister boreholes were installed within vertically drilled boreholes located 0.3m from the periphery of the deposition hole. These instruments are referred to as primary instruments in the following section. Following drilling of the deposition holes, complementary instruments were then installed within boreholes drilled from within the deposition holes.

The following numbers and types of instruments were selected for installation to allow monitoring of stresses and strains within the host rock surrounding the deposition holes.

Table 2.1. Summary of primary instruments

Parameter measured	Instrument type	Total number installed
Compressive stress change in intact rock	Geokon model 4350 biaxial stressmeter	8
Compressive and tensile stress change in intact rock	Geokon model 4360-1 Soft stress cell	8
Vertical movements in intact rock, over single fractures and within fracture zones	Geokon model 4430 deformation meter	17
Vertical strain measurements in intact rock and over single fractures	Geokon model 4200 strain gauge	7

Table 2.2. Summary of complementary instruments

Parameter measured	Instrument type	Total number installed
Horizontal deformation perpendicular to the axis of the deposition hole	Geokon model 4430 displacement transducer	32
Vertical strains beneath the deposition hole	Geokon model 4200 strain gauge	8

The layout of the primary instruments around the deposition holes is shown in Figures 2.1 and 2.2. A total of eight 60mm diameter boreholes (four around each of the two deposition holes) were drilled. The majority of the instruments were installed within these boreholes. These holes are designated as A, C, E and G- 5 and 6. In addition, a total of four 76mm diameter boreholes (two at each deposition hole) were drilled to shallower depths to allow installation of the soft stress cell meters. These larger diameter holes are designated as H and D-5 and 6.

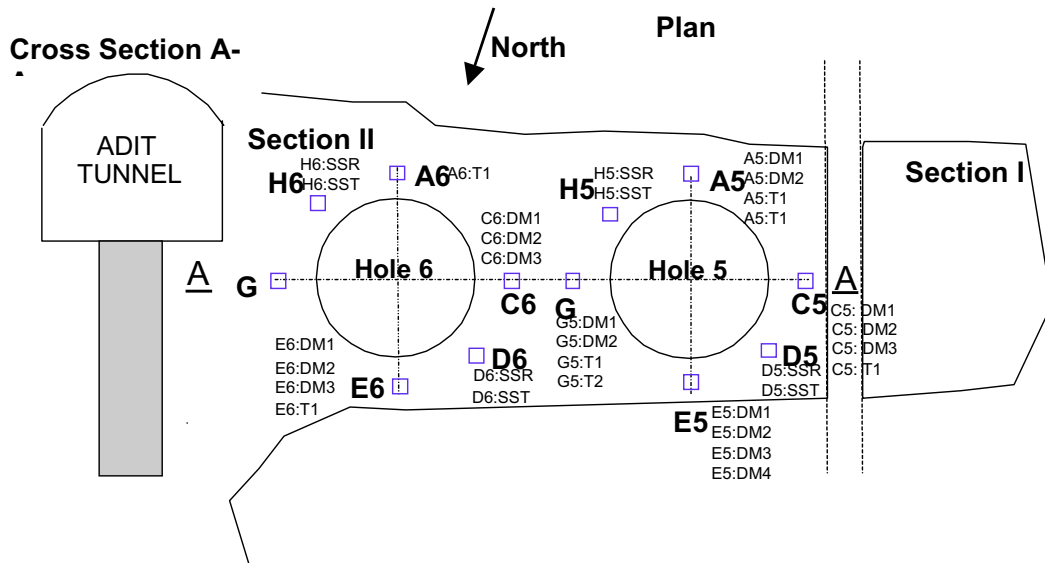

Figure 2.1 Primary instrument locations in plan view

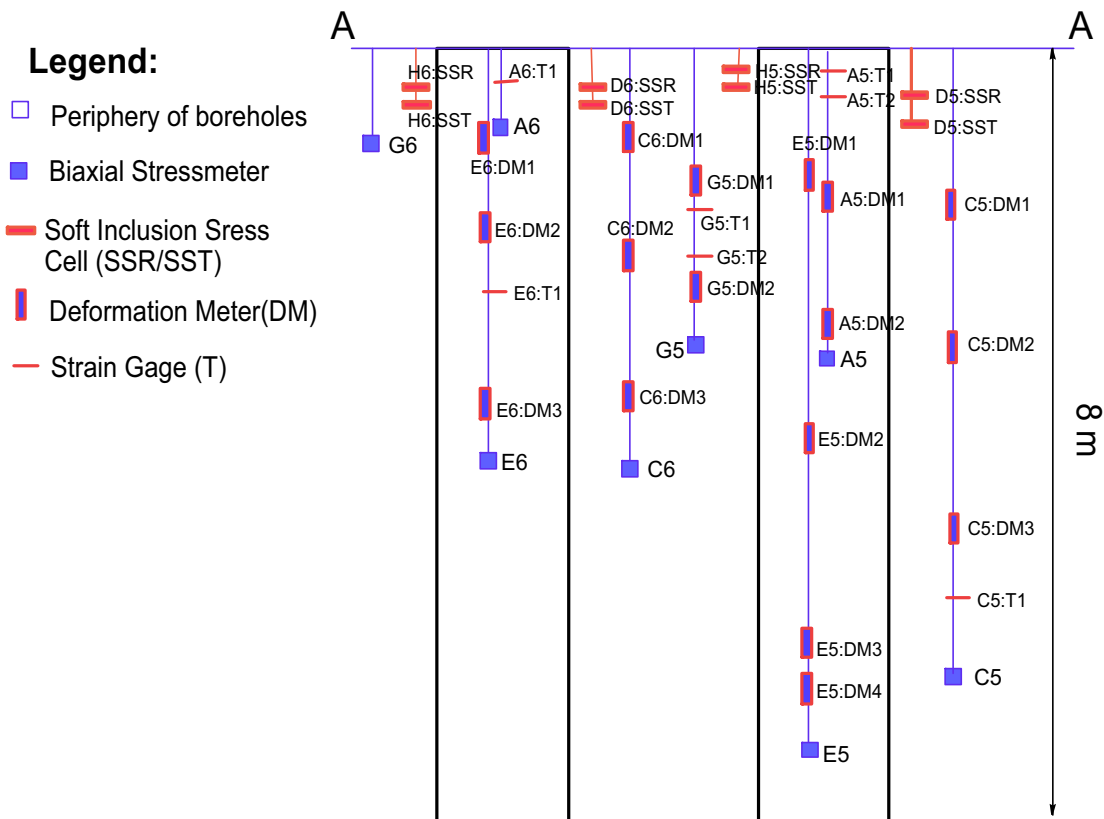

Figure 2.2 Primary instrument locations in elevation view

Installation of the complementary instruments took place following drilling of ten boreholes having about a 75mm diameter from within the two deposition boreholes. The locations of these ten boreholes are shown schematically as well as in plan and elevation in Figures 2.3 to 2.6. The instruments installed within these boreholes consisted of displacement transducers ranging in length from 0.3m to 1.2m, and strain gauges which were 0.15m in length.

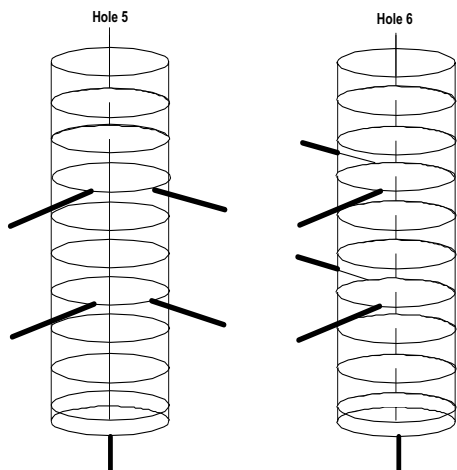

Figure 2.3 Schematic view of complementary boreholes

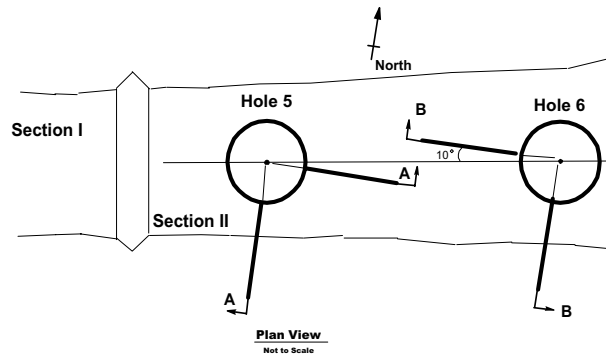

Figure 2.4 Plan view of complementary boreholes

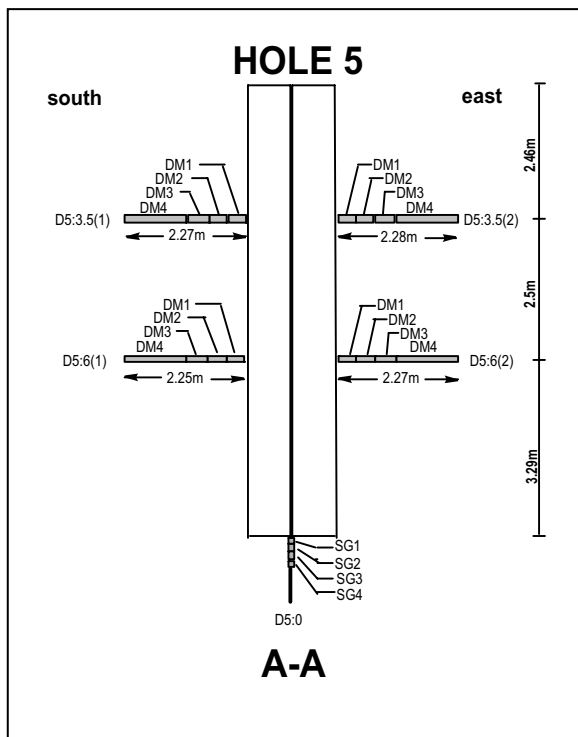

Figure 2.5 Elevation view of complementary instruments in Deposition Hole 5

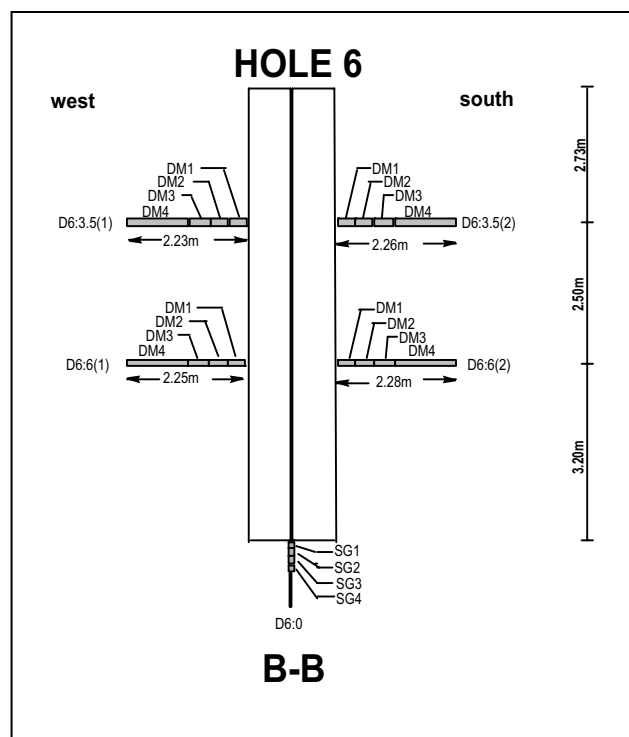
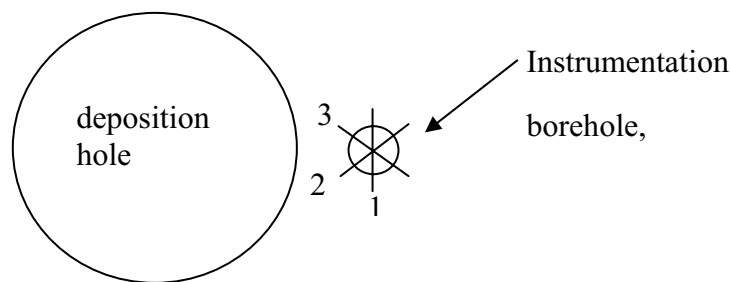

Figure 2.6 Elevation view of complementary instruments in Deposition Hole 6

2.2 Stress measurements

2.2.1 Vibrating wire embedment biaxial stressmeters

The Geokon model 4350 vibrating wire biaxial stressmeter was installed for monitoring stress changes. This instrument was designed to measure compressive stress changes in rock, salt, concrete or ice. The instrument consists of a stiff high-strength steel cylinder, which is grouted into a BX (60 mm) size borehole. Stress changes in the host material cause the cylinder to deform, and the deformations in the plane perpendicular to the borehole are measured by means of two sets of three vibrating wire sensors spaced at 60° intervals (measurements are made at two levels within the cylinder). The gauges also include two longitudinal strain sensors and temperature sensors. The deformation of the steel cylinder, and resulting changes in resonate frequency of the vibrating wires, are used to determine both the magnitude and orientation of the change in stress in the host material.



Installation of the stressmeter gage is accomplished by inserting the gage into a grout-filled borehole using a setting tool and self-aligning setting rod. The stress cell is orientated so that the first vibrating wire is orientated tangentially to the canister hole. The second wire is orientated 60° from tangential direction and the third wire is orientated 120° from tangential direction.

2.2.2 Vibrating wire soft inclusion stress cell

The Geokon model 4360 soft inclusion stress cell is designed to measure changes in borehole diameters caused by changes in stress in rock and concrete. In use, an instrumented steel ring is installed in a borehole and pre-stressed in place by forcing platens into contact with the borehole walls. A vibrating wire strain gage measures the deformation of the ring, which is also the deformation of the borehole. Both compressive and tensile measurements can be made. Unlike the biaxial stressmeters that contain sets of 3 vibrating wires, the soft stress cells measure deformation changes in only one direction. For this reason the soft stress cells are installed in pairs to measure stress changes tangential and radial to the deposition holes.

2.3 Deformation gages

Deformations around the deposition holes are measured with deformation gages installed both within the same boreholes used for the biaxial stressmeters, as well as in the horizontal complementary boreholes.

The Geokon model 4430 Deformation gage is designed to measure longitudinal deformations in boreholes. The deformation meter consists of a tube with an anchor at each end. Within the tube a beam of graphite will transfer any distance changes between the two anchors to a vibrating wire sensor. In each deformation meter a temperature sensor is included for temperature corrections.

2.4 Embedded strain gages

At some particular locations, Geokon model 4200 strain gages have been installed over single fractures. This model gauge is designed for direct embedment in cast concrete and for installation in grouted boreholes. A steel wire is tensioned between two end blocks and the strain of the wire is measured using the vibrating wire principle. Deformations in the rock mass induced movements of the hard cement causing the two end blocks to move in relation to each other across a joint, thereby altering the tension in the wire. The tension in the wire is measured by plucking the wire and measuring its resonant frequency of vibration using an electromagnetic coil.

2.5 Cement

Special expansive grout was used to insure that the gage is in complete contact with the surrounding rock. The instruments are grouted in special cement from Denmark named Densitop T2. This cement is chosen to have as similar properties as the rock as possible. The compression strength is 150 Mpa. The coefficient of expansion is approximate 8.5 microstrain/C° that is similar to hard rock as granite and as 85 % of common concrete.

2.6 Registration

A datalogger type Campbell CR10X has recorded the measurements, which have typically been recorded once every four hours during the period 2004-06-01 to 2004-08-31.

3 Computer processing of field data

3.1 Evaluation of stresses from biaxial stressmeters

The stress changes are evaluated from the measured deformations registered by the vibrating wires.

3.1.1 Radial deformations

Radial deformation for each of the vibrating wires are calculated with the equation:

$$V_r = (R_1 - R_0) * \text{Gagefactor} \quad (\text{mm/ digit})$$

V_r = Radial deformation for each of the vibrating wires

R_1 = Deformation reading in digits (= frequency² / 1000)

R_0 = Deformation zero reading in digits (= frequency² / 1000)

3.1.2 Calculation of deformation to stresses

The magnitude and the direction of the stress changes are determined from the measured radial deformation of the sensor in three directions.

The equations below give the magnitude and the direction of the maximum stress increase and reduction in a plane perpendicular to the borehole axes:

Maximal stress increase

$$p = \frac{1}{2} \left[\frac{1}{3B} \left((2V_{r_1} - V_{r_2} - V_{r_3})^2 + 3(V_{r_2} - V_{r_3})^2 \right)^{1/2} + \frac{1}{3A} (V_{r_1} + V_{r_2} + V_{r_3}) \right]$$

V_{r_1} = Radial deformation for vibrating wire 1

V_{r_2} = Radial deformation for vibrating wire 2

V_{r_3} = Radial deformation for vibrating wire 3

A, B = Coefficients depending on the sensor geometry and the material properties

Maximal stress reduction

$$q = \left[\frac{1}{3A} (V_{r_1} + V_{r_2} + V_{r_3}) - p \right]$$

The angle of the maximal stress increase

The angle in the plane perpendicular to the borehole axes is measured clockwise from the tangential direction of the canister hole.

$$\theta = \frac{1}{2} \cos^{-1} \left[\frac{V_{r_1} - A(p+q)}{B(p-q)} \right]$$

3.2 Evaluation of stress from soft inclusion stress cells

The eight soft inclusion stress cells each contain one vibrating wire which is mounted at a 90° angle from measured direction of stress. Therefore an increase in the readings in digits indicates a reduction on borehole diameter.

The change in the diameter of the borehole is calculated as follows:

$$D = (R_1 - R_0) * G$$

Where R_1 and R_0 are the current and initial readings respectively, in units of digits (frequency² / 1000), and

G is the gage factor in units of (mm/digit)

3.3 Evaluation of deformation

Deformation measurements taken with the Geokon Model 4430 deformation meters were calculated as temperature compensated deformation with the following equations:

$$\text{Deformation}_{\text{corr}} = ((R_1 - R_0) * C) + ((T_1 - T_0) * K) + L_c$$

Where R_1 and R_0 are the current and initial readings respectively, in units of digits (frequency² / 1000),

T_1 and T_0 are the current and initial temperatures respectively in C°,

C is the gage specific calibration factor

K is the thermal coefficient based on the following equation:

$$K = ((R_1 * M) + B) * C$$

$$\text{Where } M = 0.000295, \text{ and } B = 1.724$$

L_c is the gage length correction based on the following equation:

$$L_c = (17.3 * 10^{-6}) * (\text{Length of the deformation meter} - \text{transducer length}) * (T_1 - T_0)$$

For the gages installed at the Prototype project the transducer length is 267 mm

3.4 Evaluation of strain

Strain measurements taken with the Geokon Model 4200 gages were calculated as temperature compensated strain with the following equation:

$$\mu\mathcal{E}_{true} = (R_1 - R_0) * GF * B + (T_1 - T_0)(C_1 - C_2)$$

$\mu\mathcal{E}_{true}$ = temperature compensated microstrain

R_1 and R_0 = Digits reading

GF = theoretical gage factor

B = batch calibration factor

C_1 and C_2 are the coefficients of expansion of steel and concrete, 12.2 microstrain/ C° and 8.5 microstrain/ C° .

3.5 Material parameters

Material parameters used in the calculations are as the following:

- Young's modulus of intact rock 69 Gpa
- Poisson's ratio of intact rock 0.25
- Coefficients of expansion of steel 12.2 microstrain/ C°
- Coefficients of expansion of concrete 8.5 microstrain/ C°

3.6 Processing

The raw data which have been collected using Multilogger software have been processed using Microsoft Excel software.

4 Results

4.1 Overview and comments

The measurement results are presented graphically for each of the sensors in the following sections for the primary and complementary instruments. During the presented measuring period there have been mostly no, or very small variations in measuring values. The temperature has been rather constant. Some sensors have shown signs of disturbance or unstable readings, but mostly the readings are good. A few sensors have stopped presenting values. It should be noted that the readings are currently uncompensated for the temperature effects.

4.1.1 Biaxial stress meter results

Generally the out put values are stable with no, or very small changes. The stress increase 1-3, and stress decrease 4-6, in instrument G6 has increased with about 5 MPa. There is still some electrical noise or disturbance in stress meter E5 and the sensor level 1-3 is not working properly. Some disturbance has also occurred in stress meters A5 and E6 towards the end of the period. Furthermore there are small disturbances in sensors A5 and C5 starting in mid September and ending in mid October.

4.1.2 Soft inclusion stress cell

The values from sensors around Hole 5 are stable with a small tendency of reduction towards the end of the period. There are some disturbances in the D6 and H6 sensors. Temperature sensors D6Soft_2T and H6Soft_1T are still showing unstable values with some disturbances. Sensors H6Soft1_T and H6Soft2_T are both presenting an increase of temperature with 25C and 8C respectively. During this period the readings from sensor H6soft1 have become stable. Sensor D6Soft_1 are displaying a small tendency of increase towards the end of the period. The reason for the temperature increase will be evaluated.

4.1.3 Deformation measurements in vertical primary boreholes

There have been some small disturbance towards the end of the period, but values are stable and mostly with very small changes.

4.1.4 Strain measurements in vertical primary boreholes

The measurements during the period show that there have been very small variations in temperature and strains around Hole 6. The strains around Hole 5 show a tendency of decrease with in general 7 microstrains towards the end of the period. Some disturbance can again be observed in the readings from sensors A6Strain_1, while sensor E6Strain_1 has become stable.

4.1.5 Deformation measurements in D5 horizontal complementary boreholes

The temperature values are stable during the period except for sensor D5_6_1Def2T, but this could be due to heavy disturbance. Sensors D5_6_2Def3T and D5_6_2Def2T are still showing unstable values. However, as noted before the unstable readings are still indicating the same trend. Sensor D5_3.5_2Def3 has not been giving any values since June. Sensor D5_35_2Def1 stopped displaying values in February and sensor D5_35_2Def3 in September.

4.1.6 Deformation measurements in D6 horizontal complementary boreholes

The tendency is stable values with no changes or very small changes, but with some disturbance. The readings of sensors D6_6_1Def2T and D6_6_2Def2T are a little unstable. Sensor D6_6_2Def1 has not been giving any values between September 9th and October 22nd, and the values hereafter are generally displaying a compression of 2,5mm. However, the readings from this sensor are unstable.

4.1.7 Strain measurements in complementary boreholes

The strain readings are generally stable with no or very small changes during most of this period. Towards the end of the period sensor D5_0Str_1 are displaying a tension of about 30 microstrain, and sensor D5_0Str_2 and D5_0Str_3 are presenting heavy compressions. These values are not yet stabilized, and there are no signs of disturbance. Sensor D6_0Str4 has decreased about 10 microstrain.

4.2 Graphical presentation of results

4.2.1 Biaxial Stressmeter results

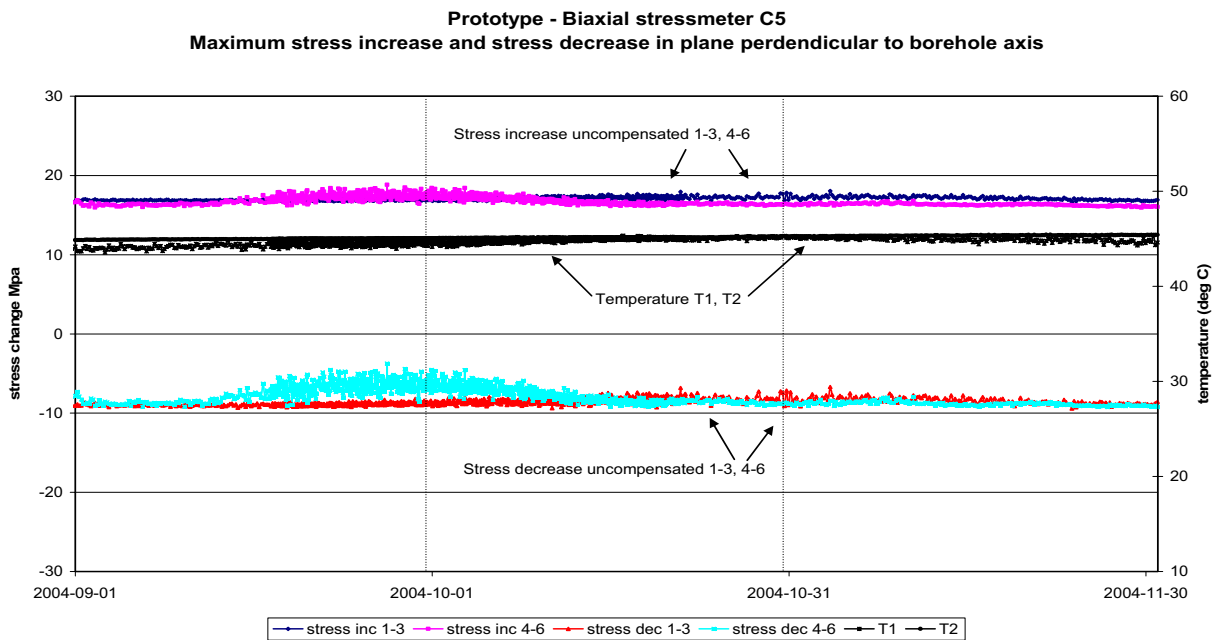
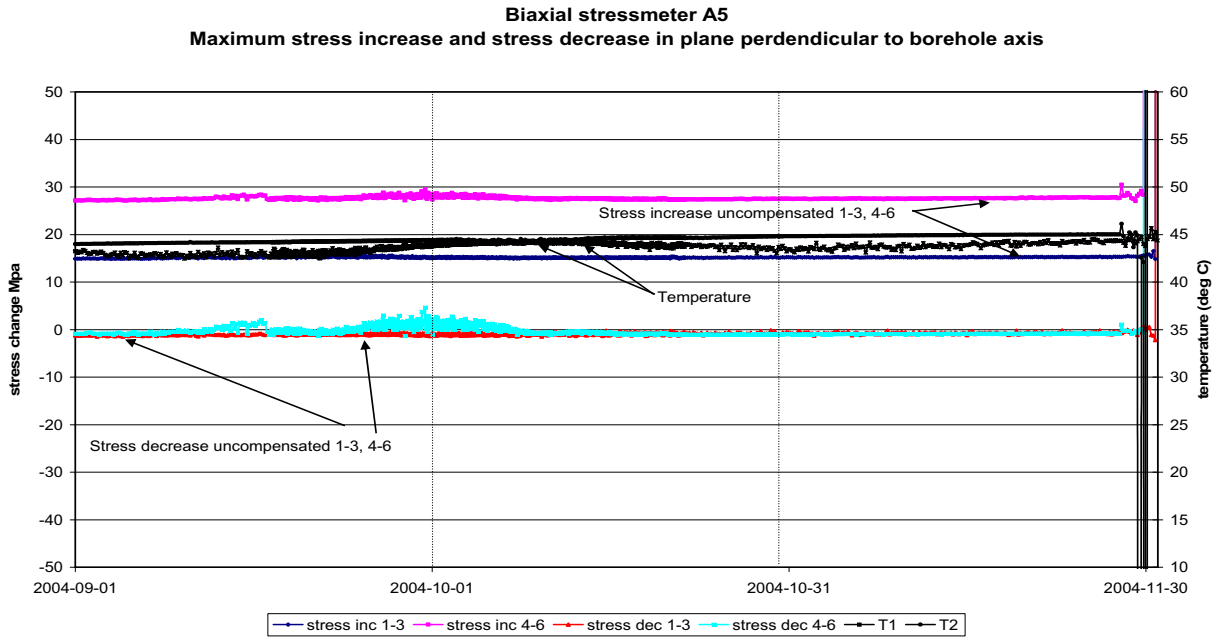

Biaxial stressmeter E5
 Maximum stress increase and stress decrease in plane perpendicular to borehole axis

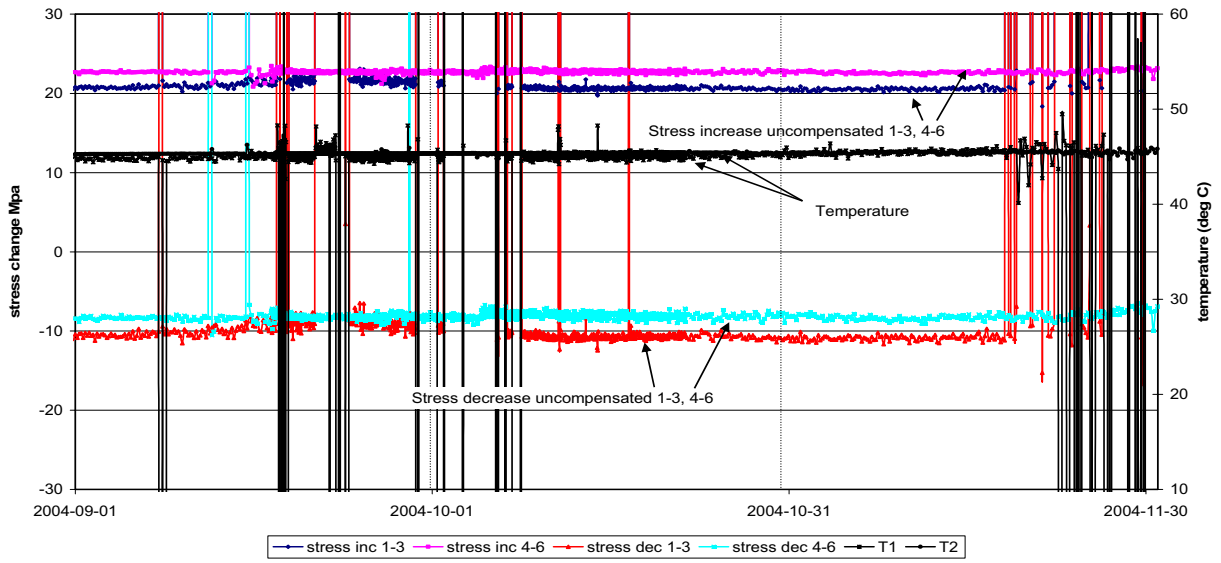

Biaxial stressmeter G5
 Maximum stress increase and stress decrease in plane perpendicular to borehole axis

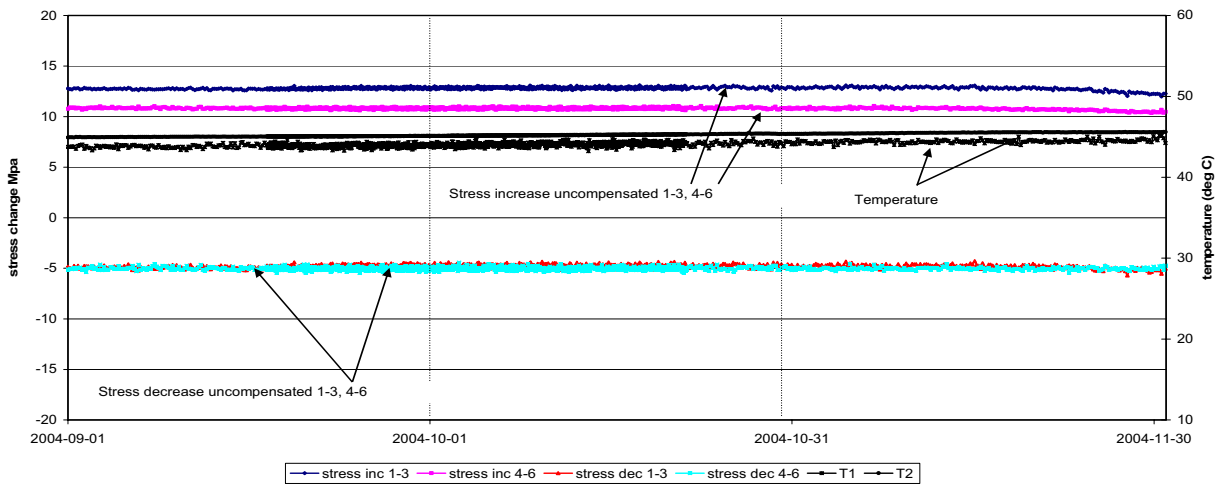

Biaxial stressmeter A6
Maximum stress increase and stress decrease in plane perpendicular to borehole axis

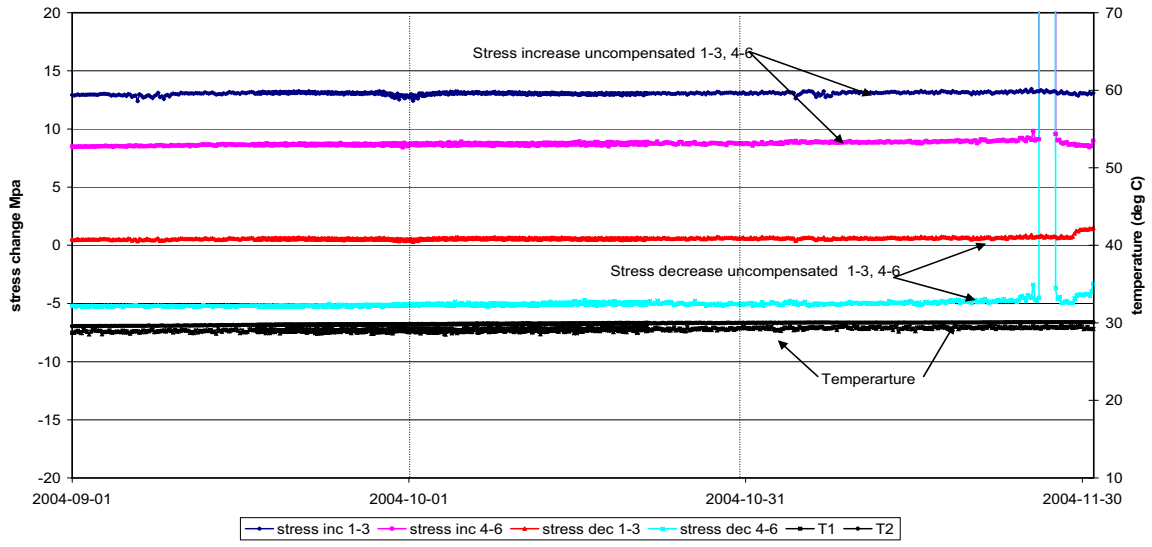

Biaxial stressmeter C6
Maximum stress increase and stress decrease in plane perpendicular to borehole axis

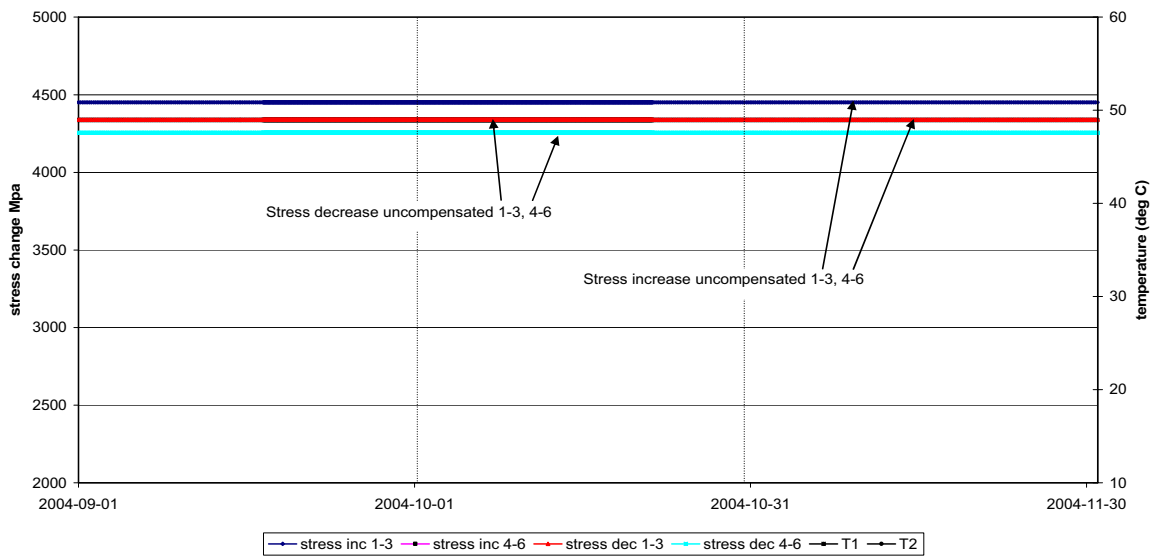

Biaxial stressmeter E6
Maximum stress increase and stress decrease in plane perpendicular to borehole axis

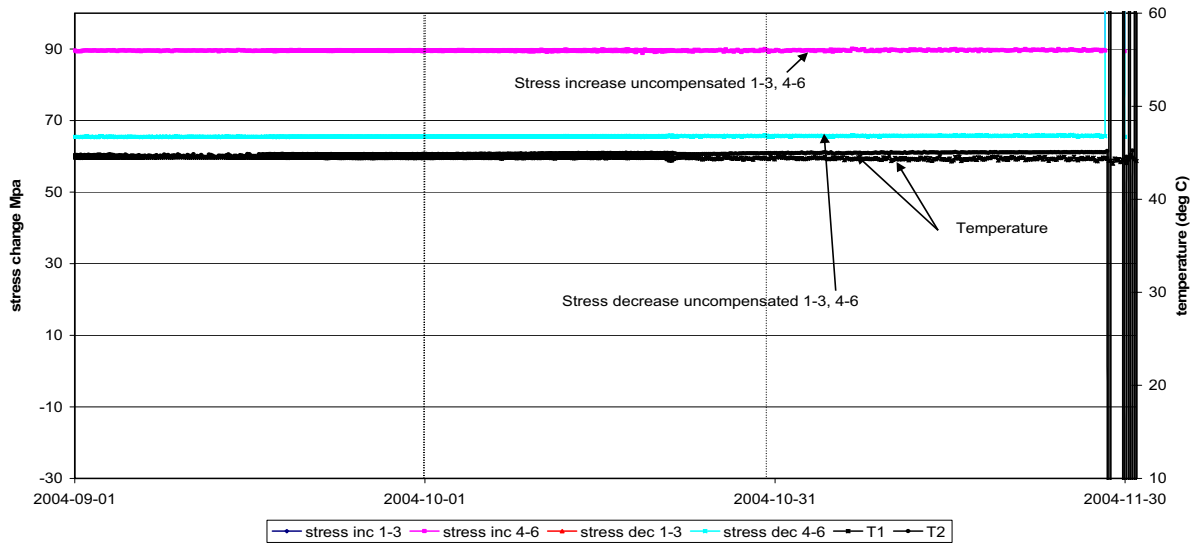

Biaxial stressmeter G6
Maximum stress increase and stress decrease in plane perpendicular to borehole axis

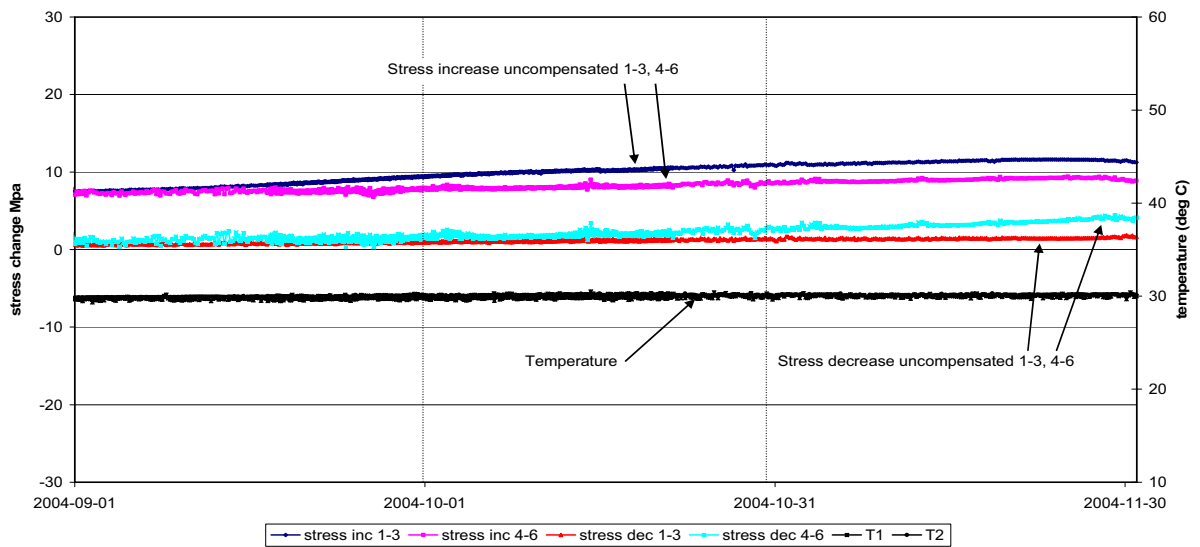

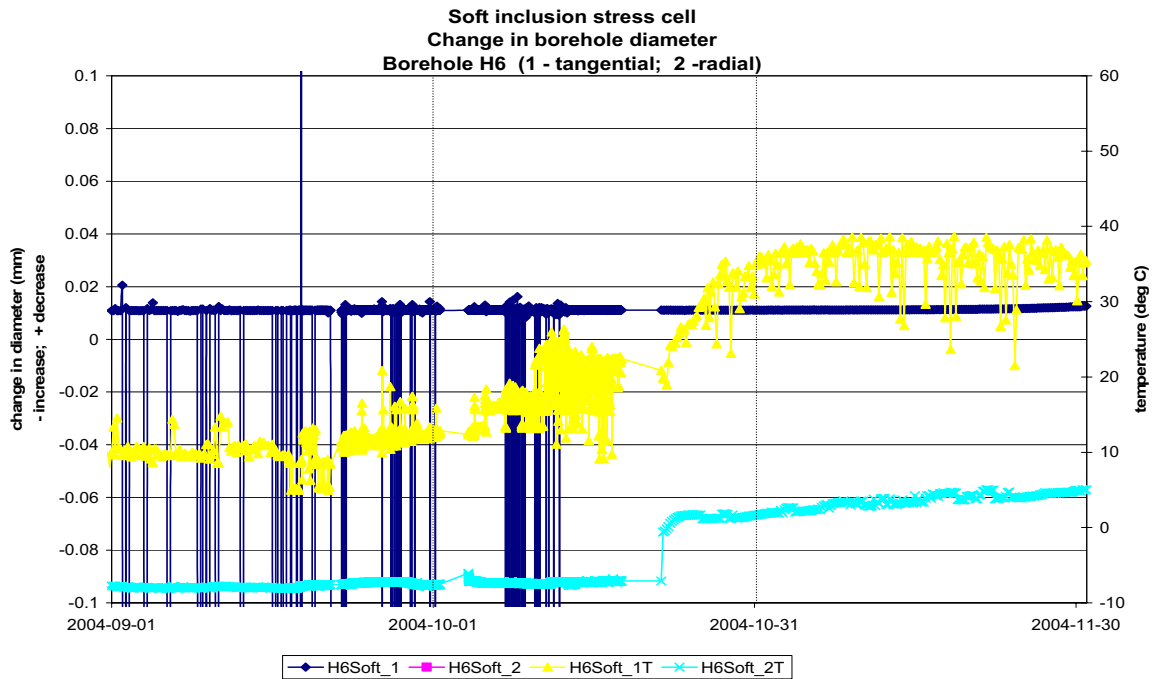
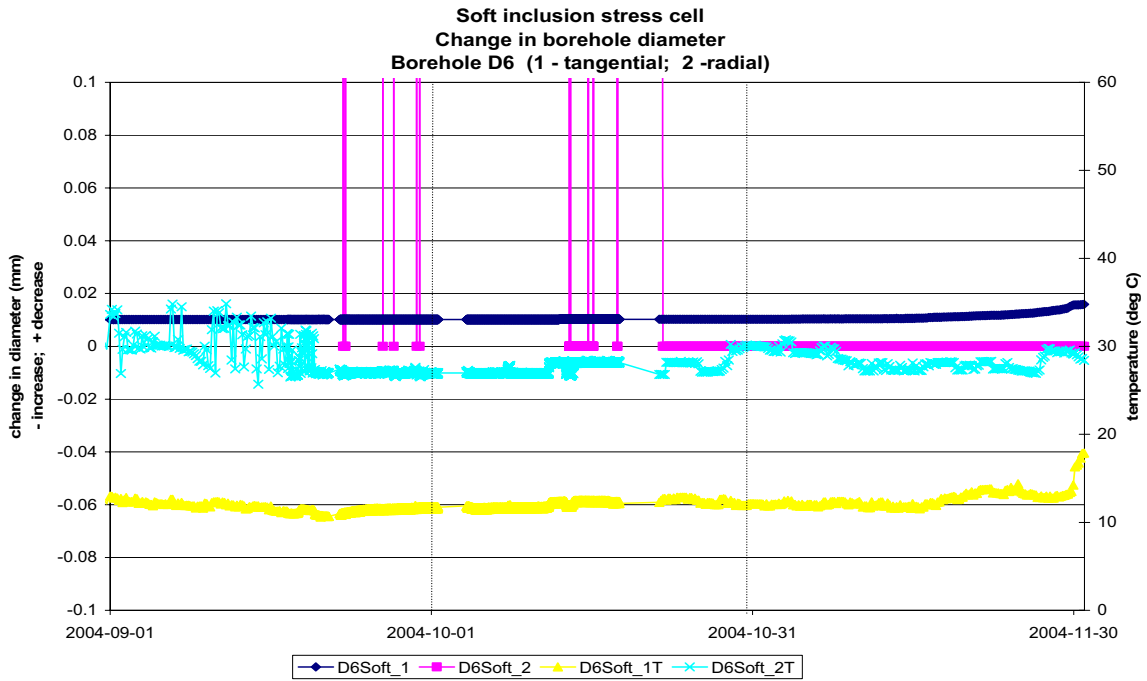

4.2.3 Deformation measurements in vertical primary boreholes

Vertical deformations adjacent to Deposition Hole 5
in Borehole E5

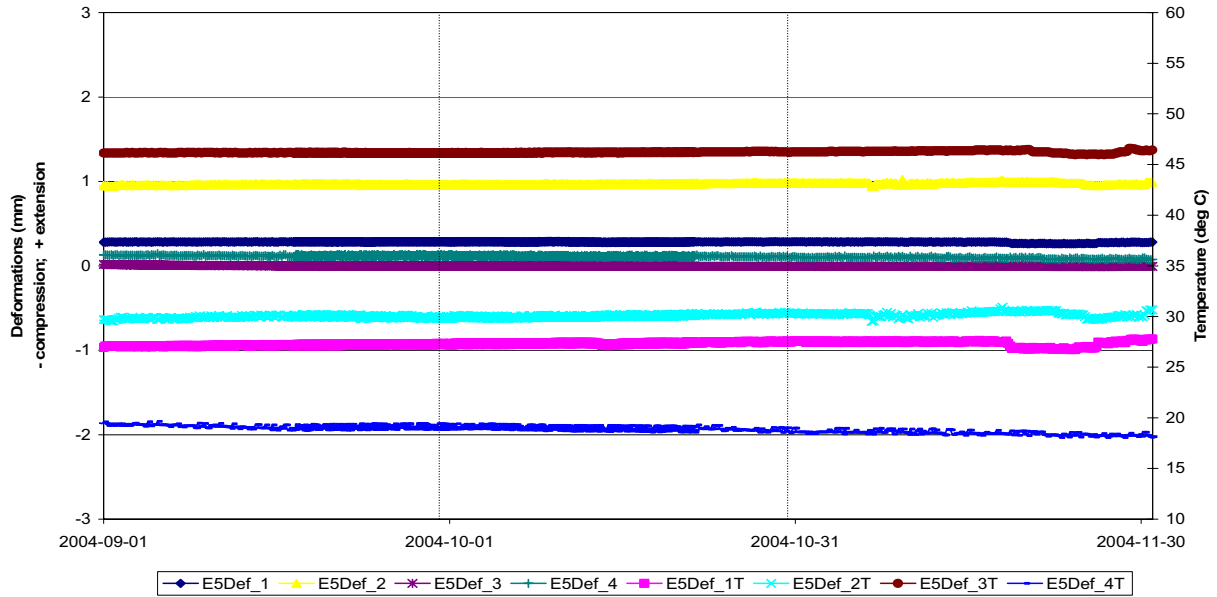

Vertical deformations adjacent to Deposition Hole 5
in Boreholes G5 and A5

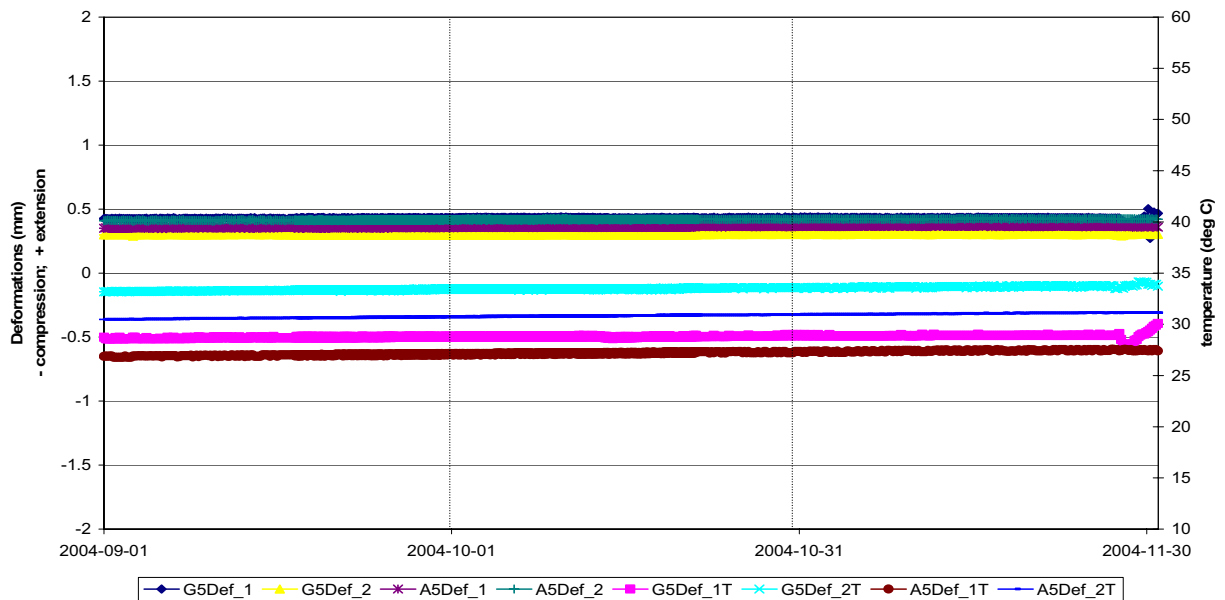

Vertical deformations adjacent to Deposition Hole 5
in borehole C5

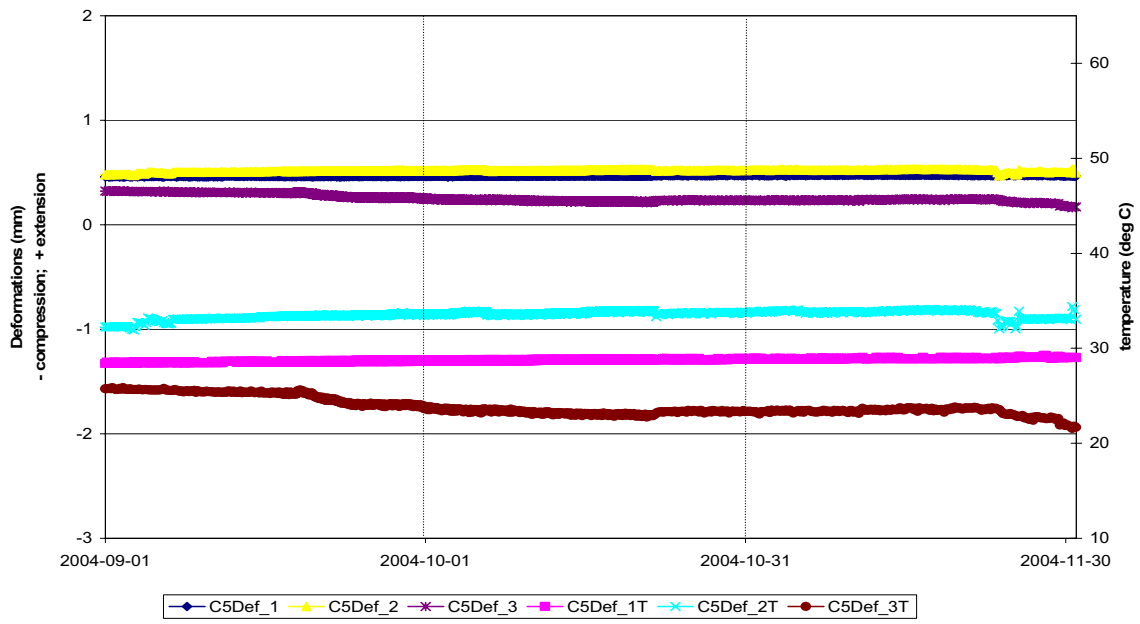

Vertical deformations adjacent to Deposition Hole 6
in borehole C6

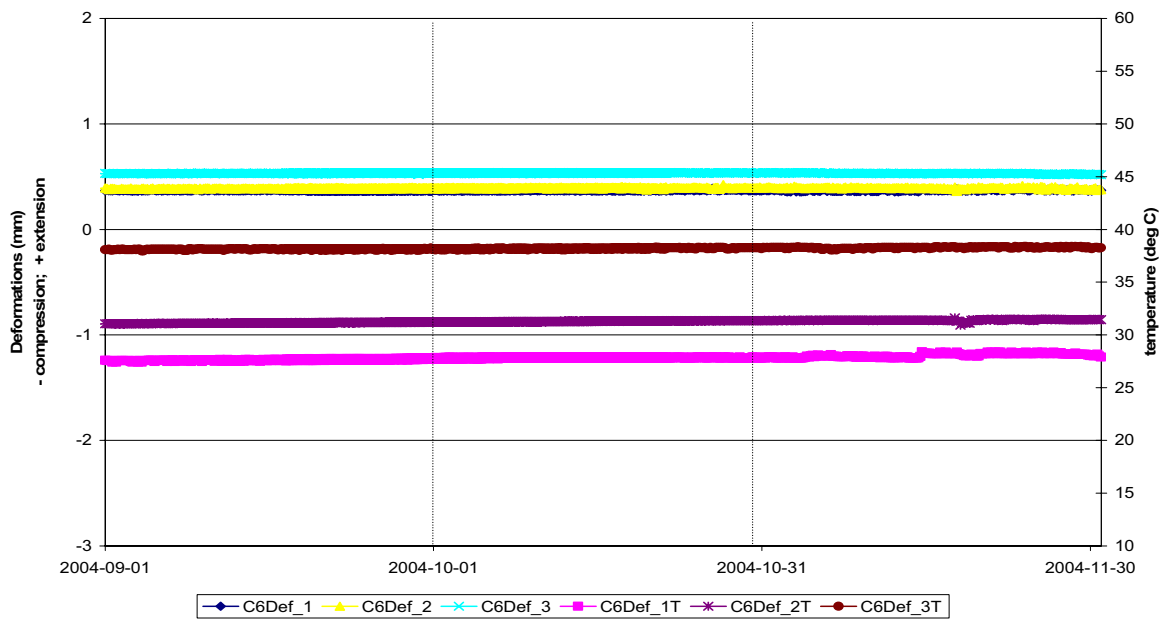

Vertical deformations adjacent to Deposition Hole 6
in borehole E6

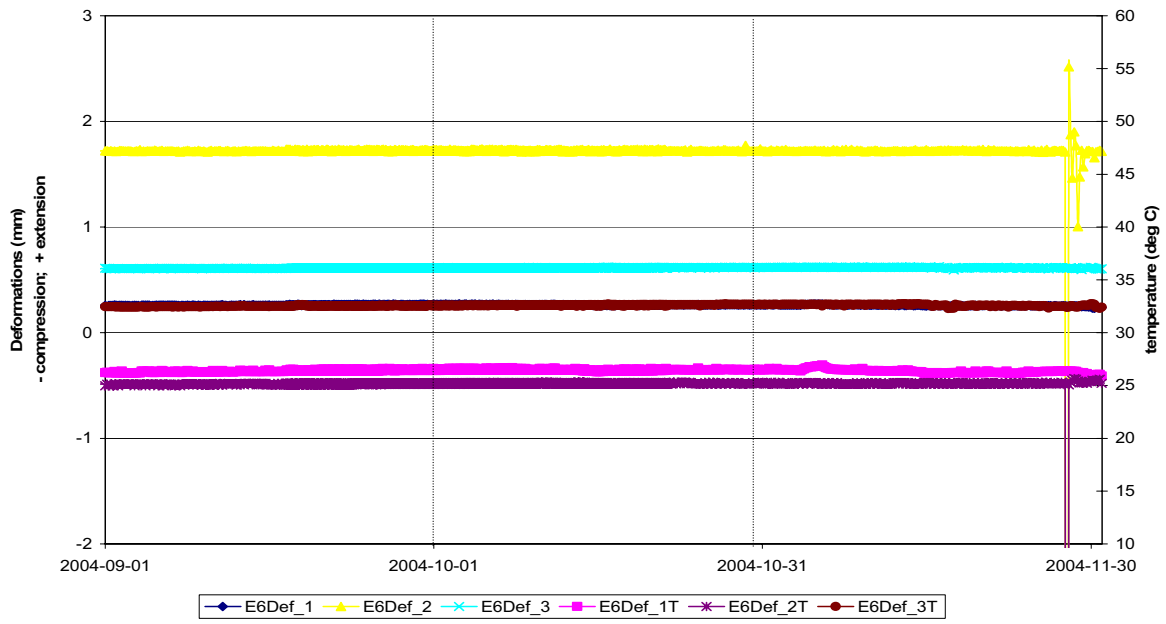

4.2.4 Strain measurements in vertical primary boreholes

Vertical strain adjacent to Deposition Hole 5

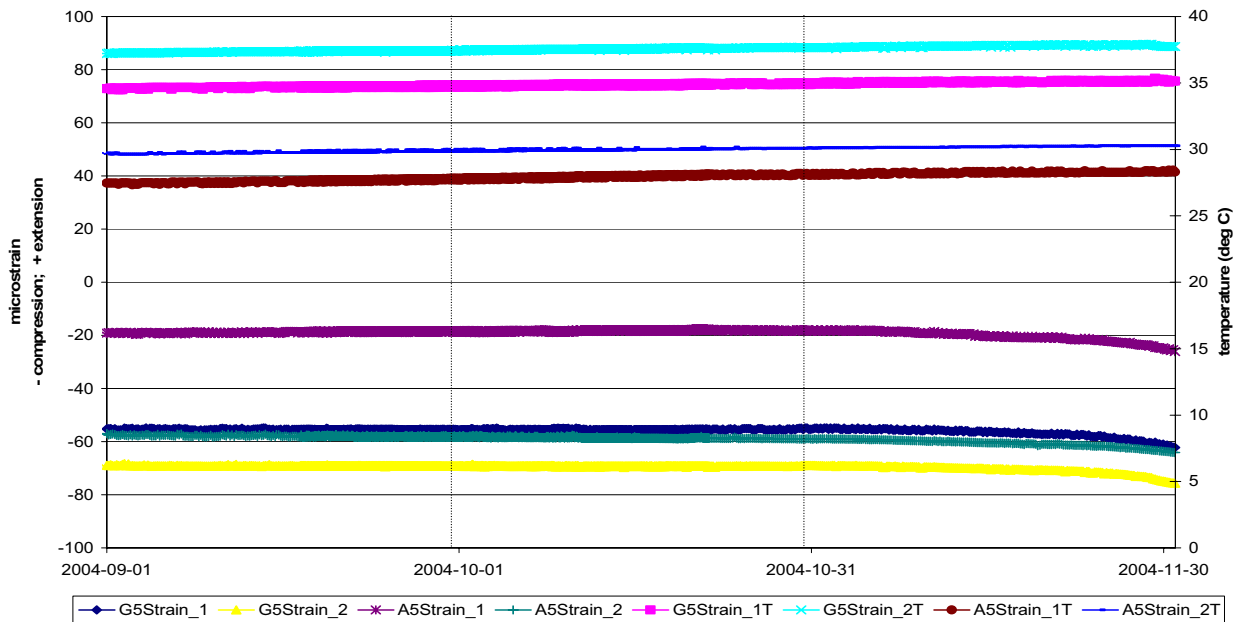

Vertical strain adjacent to Deposition Holes 5 and 6

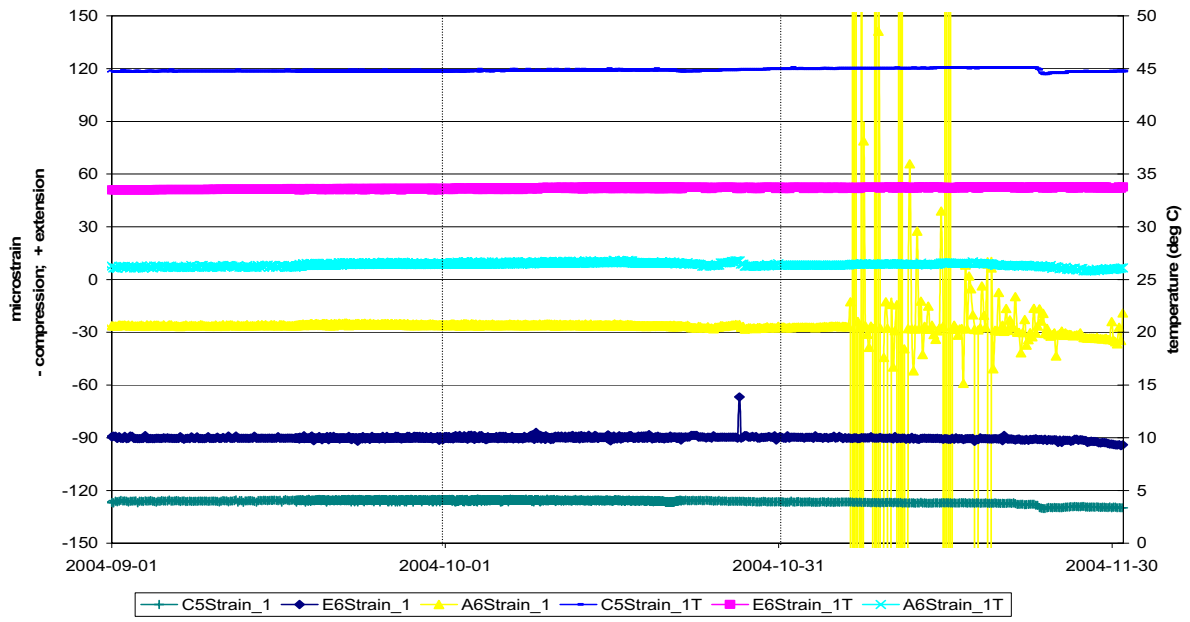

4.2.5 Deformation measurements in horizontal complementary boreholes

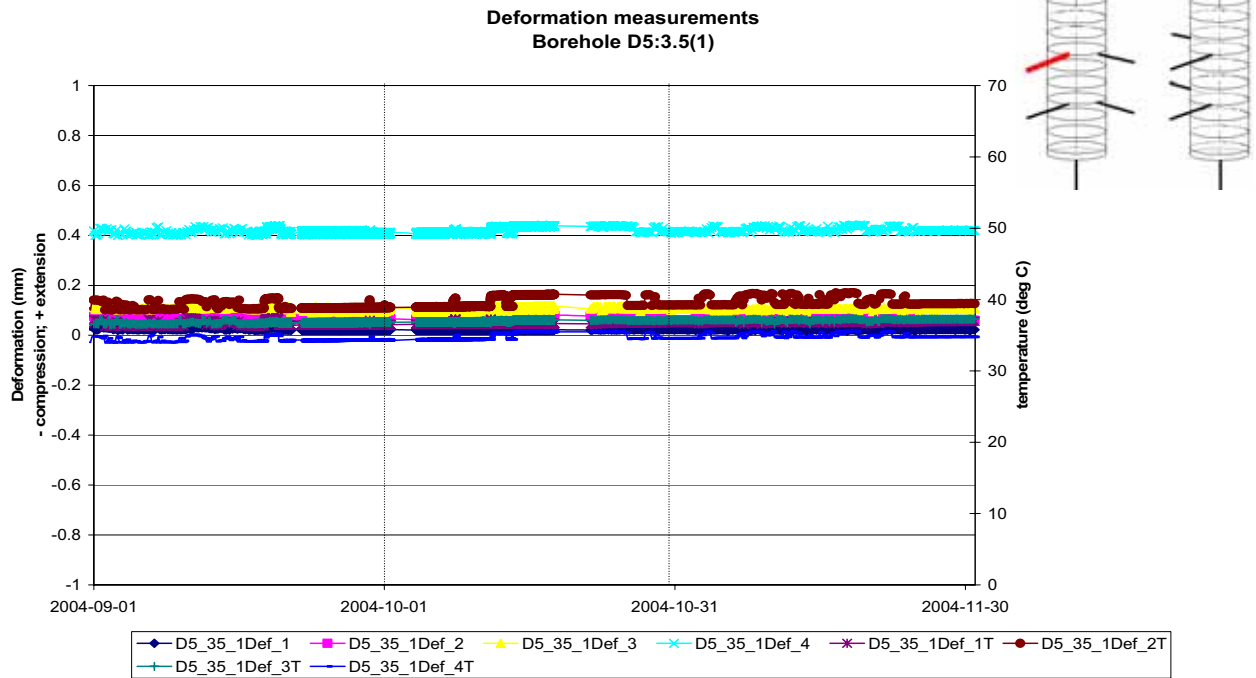

Deformation measurements
Borehole D5:3.5(2)

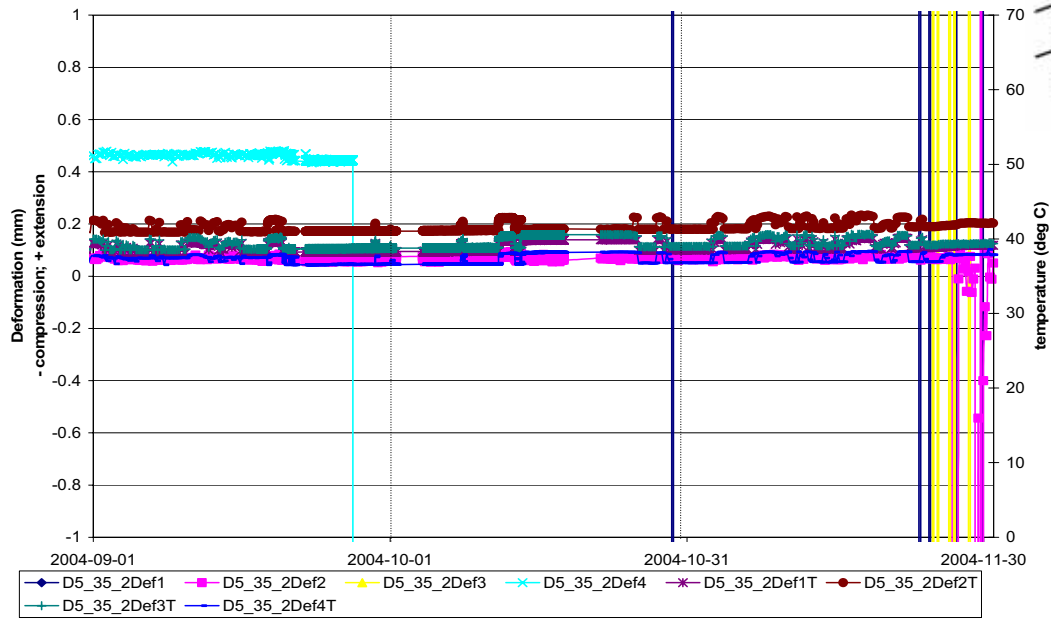

Deformation measurements
Borehole D5:6(1)

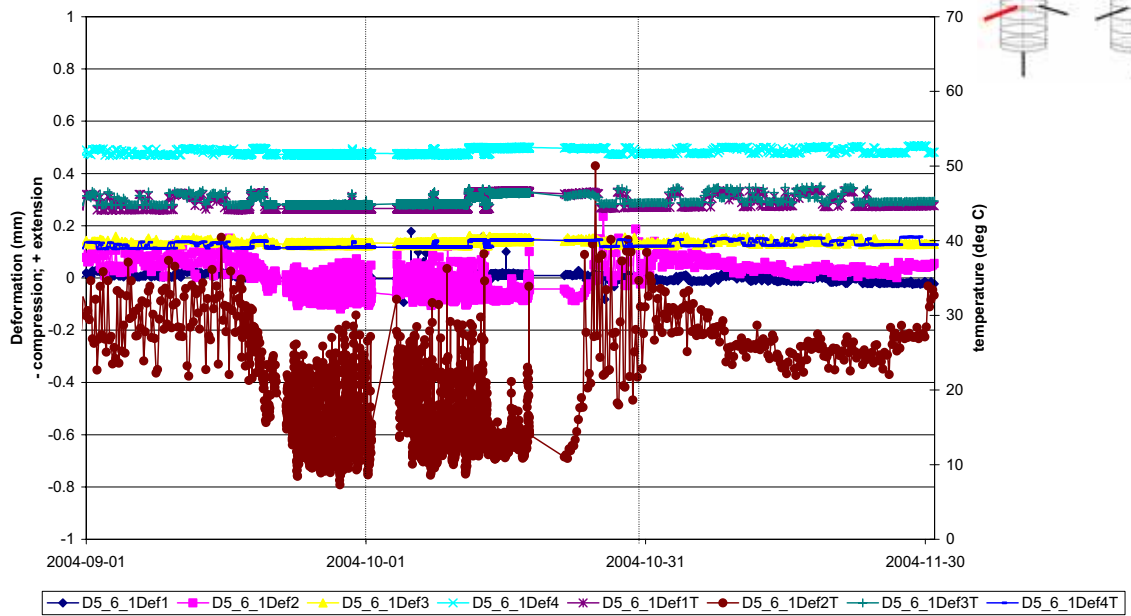

Deformation measurements
Borehole D5:6(2)

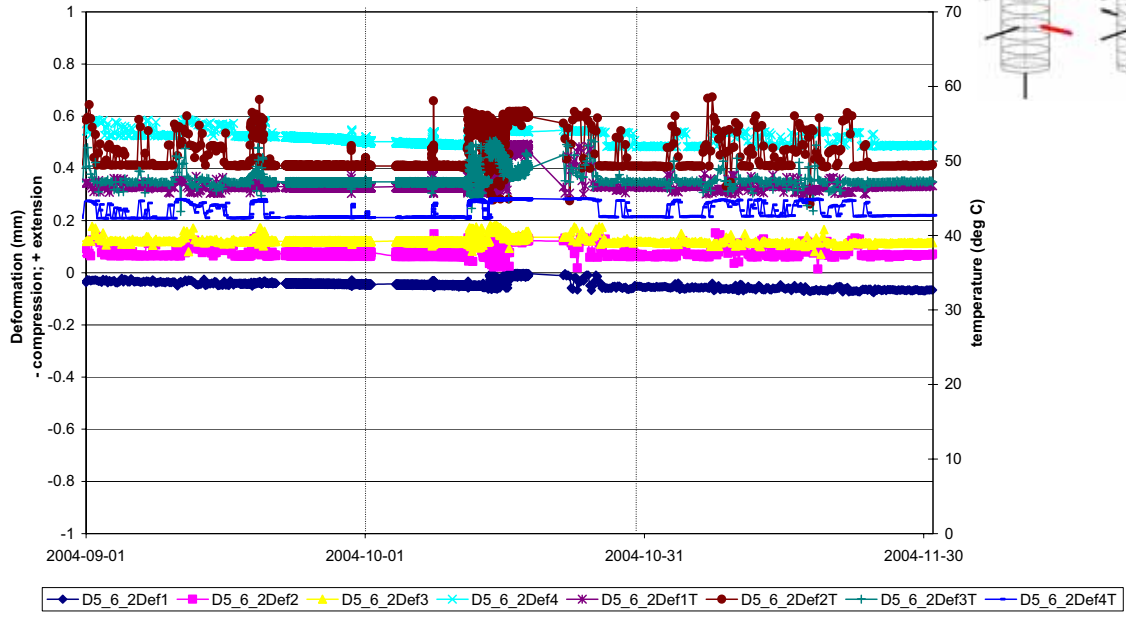

Deformation measurements
Borehole D6:3.5(1)

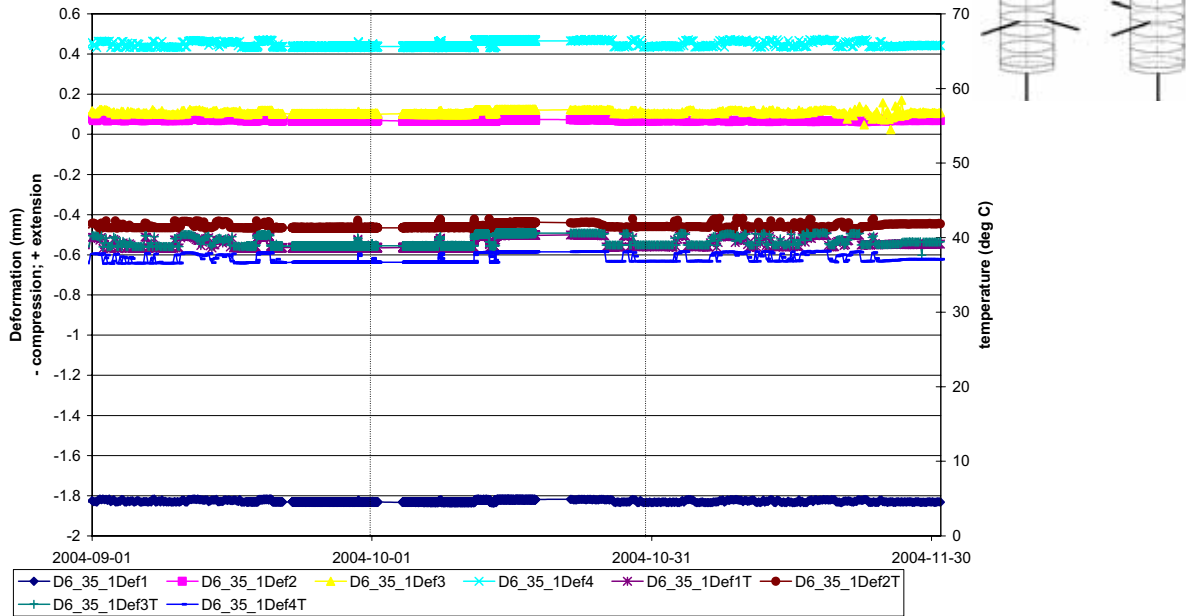

Deformation measurements
Borehole D6:3.5(2)

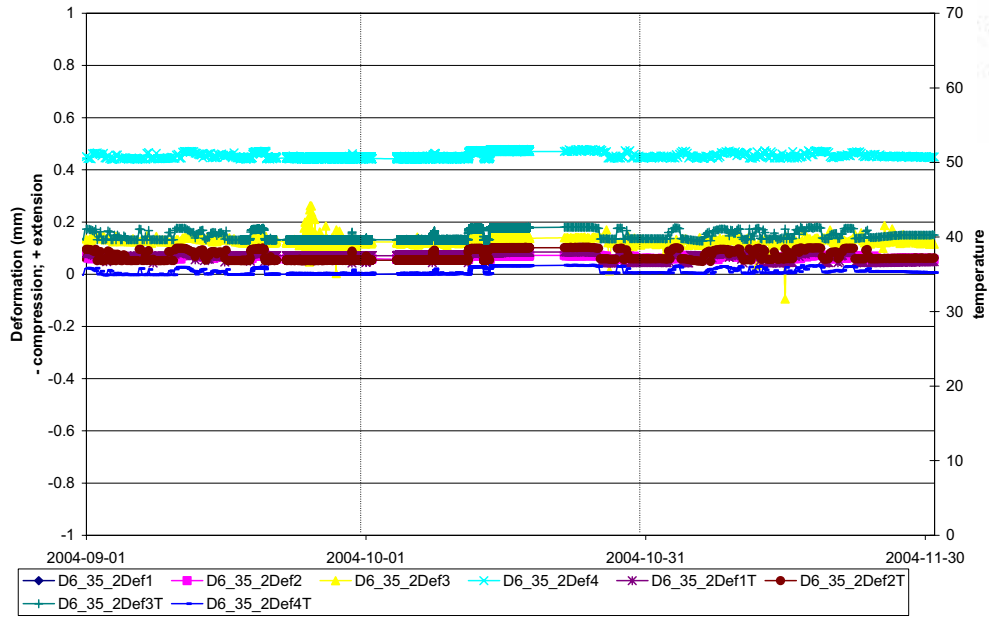

Deformation measurements
Borehole D6:3.5(2)

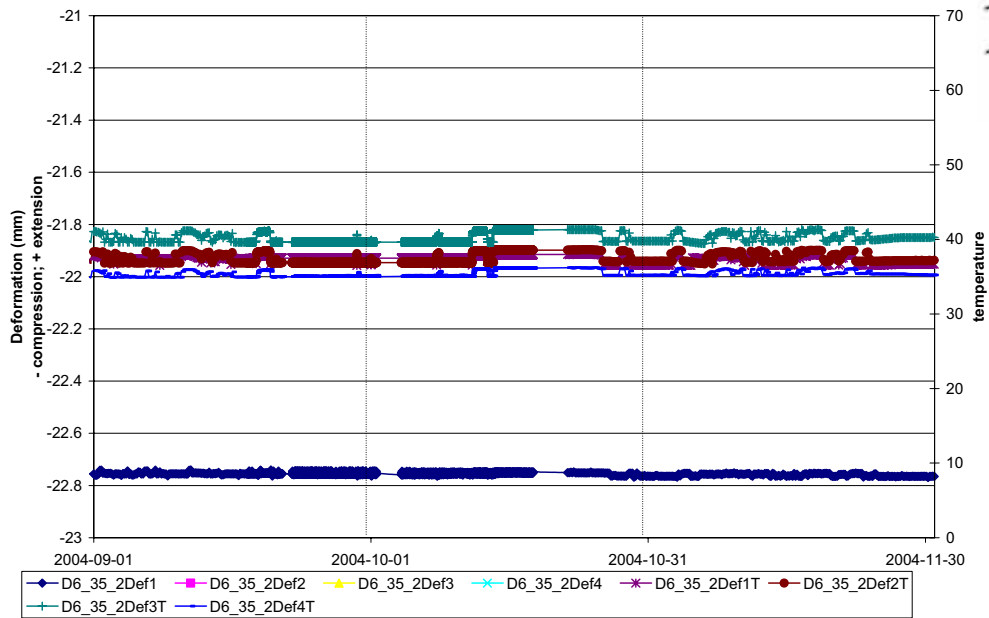

Deformation measurements
Borehole D6:6(1)

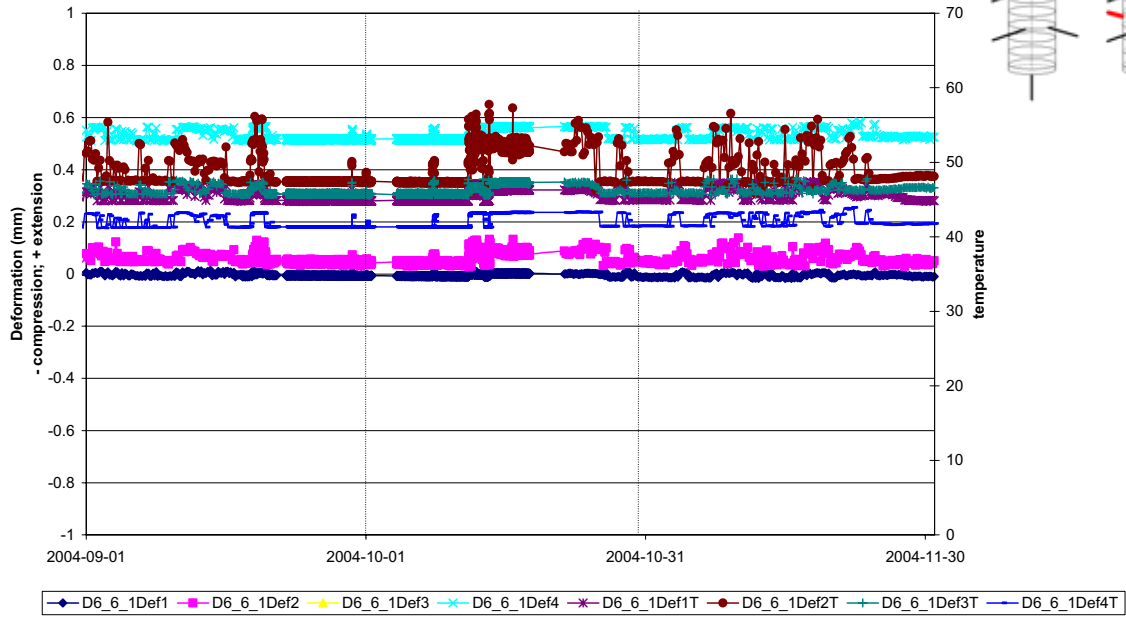

Deformation measurements
Borehole D6:6(2)

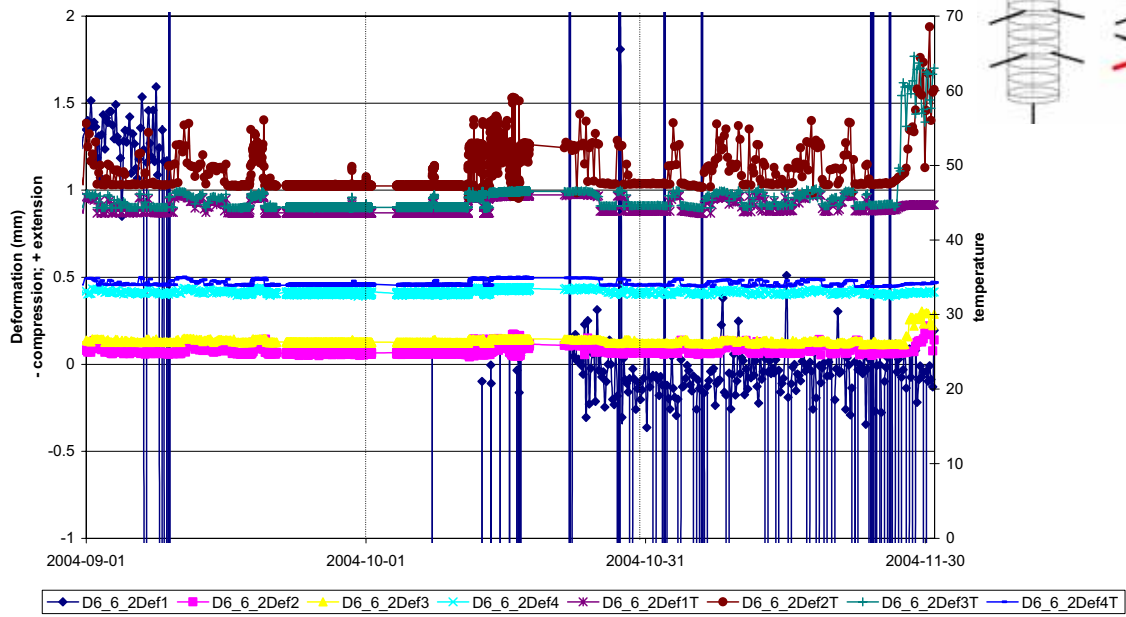

4.2.6 Strain measurements in complementary boreholes

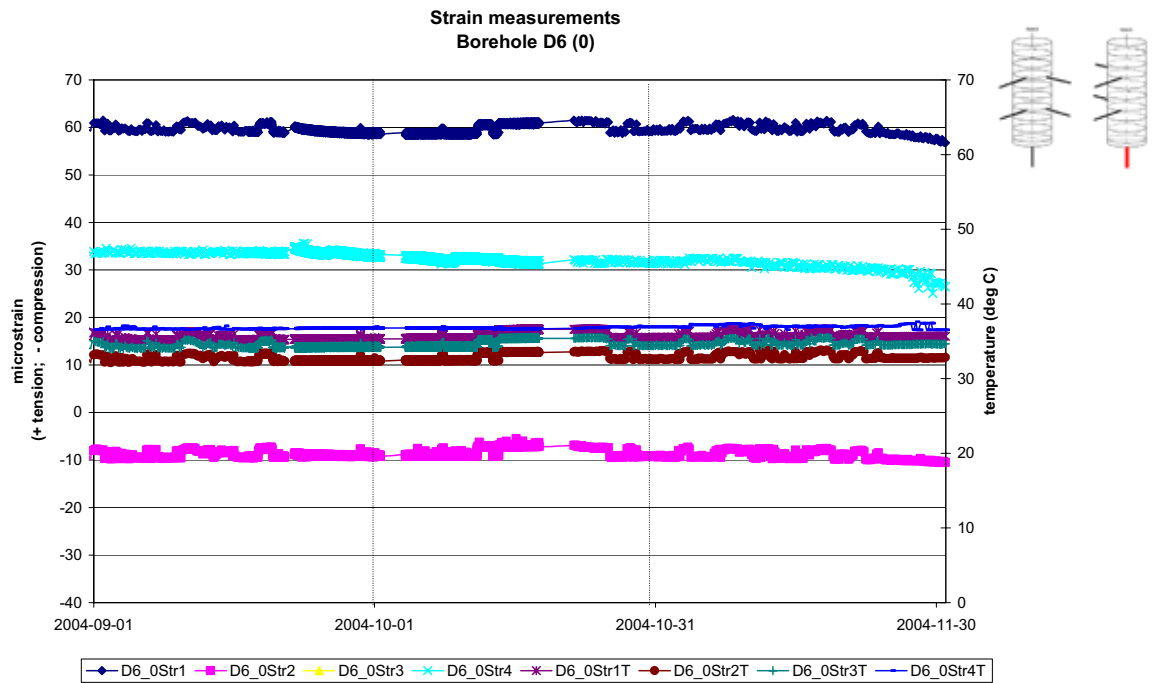
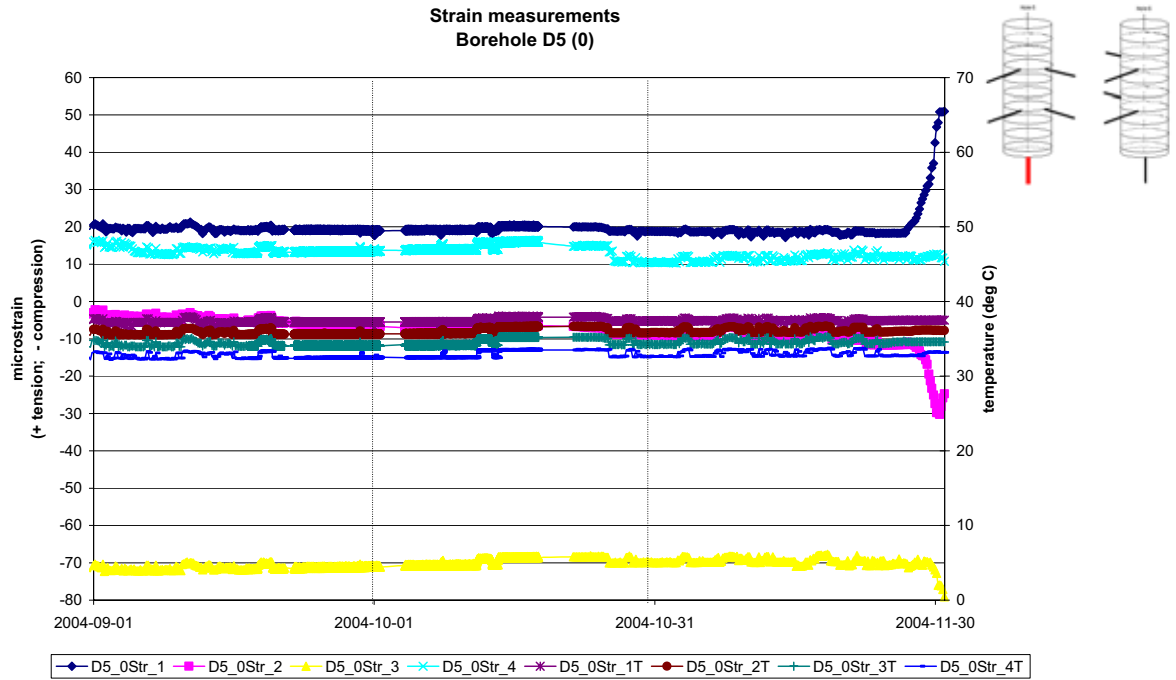

Strain measurements
Borehole D6 (0)

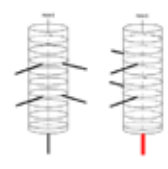
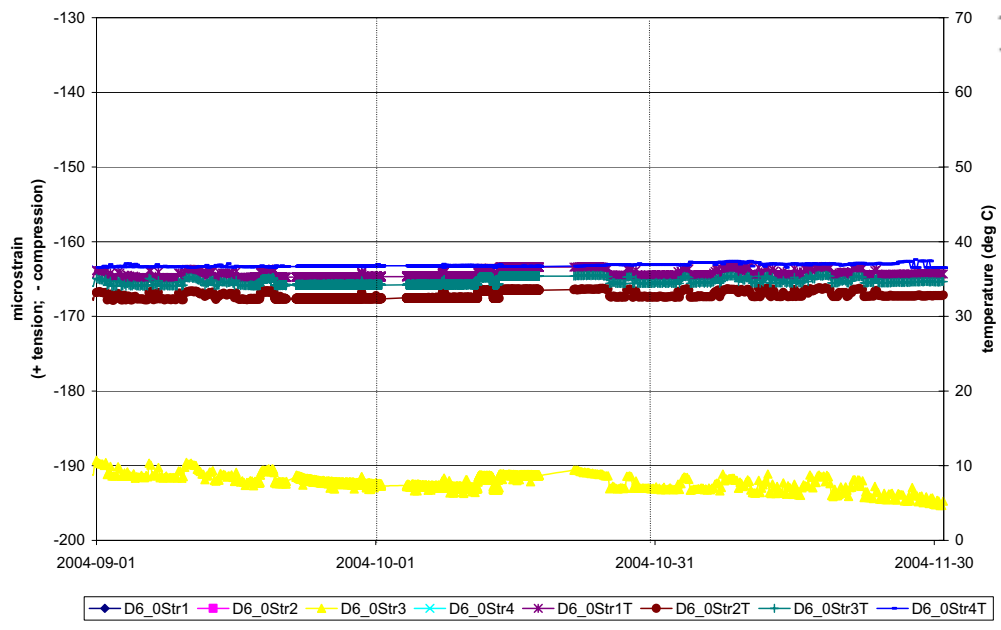

Appendix 11

Water pressure in the rock and flow measurements

Rhén I. and Forsmark T., SWECO VIAK AB

Period 2001-09-01 – 2004-12-01

Water pressure measurements in the rockmass

Introduction

The hydraulic properties of the rock, geometry of tunnels and deposition holes, water pressure far away from the tunnels and the hydro-mechanical properties of the backfill and buffer govern the saturation of the buffer and backfill. It is important to measure the water pressure in the rock for the interpretation of the measurements in the buffer and backfill and to sample data useful for the modelling of the saturation process.

A short summary of the instrumentation follows below. For more details see (*Rhén et al, 2001*).

Measurements in the boreholes

A large number of boreholes have been instrumented with one or several packers. In all packed-off sections, the water pressure will be measured. Each borehole section is connected to a tube of polyamide that via lead-through holes ends in the G-tunnel. All pressure transducers are placed in the G-tunnel to facilitate easy calibration and exchange of transducers that are out of order. The transducers were connected to the HMS system at Äspö Laboratory and it is a flexible system for changing the logging frequency. The maximum scan frequency is 1/second. During periods with no hydraulic tests, preliminary the logging (storing a value in the data base) frequency will be 2/hour with an automatic increase of the sampling frequency if the pressure change since last registration is larger than 2kPa. During hydraulic tests, the sampling frequency may be up to 1 logging every 3rd second (maximum logging rate possible).

Instrumentation with bentonite packers in Section I

Section I will be in operation for a long time, possibly up to 20 years, and there will be no access to the instruments in the boreholes for a long period. It was decided to develop a new type of packer that was not dependent of an external pressure to seal-off the borehole sections. These packers were made of compacted bentonite with rubber coverage. For chemical reasons the bentonite is not allowed to be in contact with the surrounding water in the rock mass and therefore the packers have a cover made of polyurethane (PUR-rubber). This rubber also protected the packers against unwanted wetting during transport and installation. After installing all packers in a borehole, the compacted bentonite was wetted to make it swell and expanded against the borehole wall. This packer system was used in 14 boreholes with a length between 12 and 50 meters in the tunnel floor and the walls, see (*Rhén et al, 2001*).

Due to the expected high temperature near the deposition holes two boreholes (KA3574A and KA3576A) were equipped with stainless steel pipes instead of polyamide tubes.

In some sections used for circulation or hydrochemistry sampling purposes in Section I, a dummy was installed to reduce the water-filled volume of the section. Depending on the purpose the dummies were made either by high-density polyethylene (circulation sections) or PEEK (hydrochemistry sections) material. The dummy consists of two parts, to be positioned around the centre rod.

The packers were inserted into the borehole with Ø 20 mm massive stainless steel rods. A special designed manual-hoisting rig was used to insert the equipment into the boreholes. When the packers were at their correct position the equipment was attached to a locking device mounted on the tunnel wall at the borehole collar. Before insertion, the equipment was cleaned with a cleaner delivering hot steam (100 °C) at high pressure.

The instrument configuration for the boreholes provided with bentonite packers is summarised in Table 1-1 and illustrated in Figures 1-1 and 1-2.

Table 1 Instrumentation configuration in Section I. “Lead-through”: pipes between the packers.

Borehole:sec	Sec. length (m)	Type of section	Type of dummy	Packer length	Lead-through (no:diameter:type)
KA3563G:1	15 – 30.01	P		2 m	1:6/4:PA
KA3563G:2	10 – 13	P		2 m	2:6/4:PA
KA3563G:3	4 – 8	P		1 m	3:6/4:PA
KA3563G:4	1.5 – 3	P, C	HD	1 m	6:6/4:PA
KA3566G01:1	23.5 – 30.01	P		2 m	1:6/4:PA
KA3566G01:2	20 – 21.5	P, C	HD	2 m	4:6/4:PA
KA3566G01:3	12 – 18	P		2 m	5:6/4:PA
KA3566G01:4	7.3 – 10	P		1 m	6:6/4:PA
KA3566G01:5	1.5 – 6.3	P, F		1 m	8:6/4:PA
KA3566G02:1	19 – 30.1	P		1 m	1:6/4:PA
KA3566G02:2	16 – 18	P, C	HD	2 m	4:6/4:PA
KA3566G02:3	12 – 14	P		1 m	5:6/4:PA
KA3566G02:4	8 – 11	P		2 m	6:6/4:PA
KA3566G02:5	1.3 – 6	P, F		1 m	8:6/4:PA
KA3572G01:1	7.3 – 12.03	P		2 m	1:6/4:PA
KA3572G01:2	2.7 – 5.3	P, C	HD	2 m	4:6/4:PA
KA3573A:1	26 – 40.07	P		2 m	1:6/4:PA
KA3573A:2	21 – 24	P, F		2 m	3:6/4:PA
KA3573A:3	14.5 – 19	P		2 m	4:6/4:PA
KA3573A:4	10.5 – 12.5	P, F		2 m	6:6/4:PA
KA3573A:5	1.3 – 8.5	P		1 m	7:6/4:PA
KA3574G01:1	8 – 12.03	P		1 m	1:6/4:ST
KA3574G01:2	5.1 – 7	P		1 m	2:6/4:ST
KA3574G01:3	1.8 – 4.1	P, C	HD	1 m	5:6/4:ST
KA3576G01:1	8 – 12.01	P		2 m	1:6/4:ST
KA3576G01:2	4 – 6	P, HC	PE	1 m	2:6/4:ST, 1:1/8"/2:PE
KA3576G01:3	1.3 – 3	P		1 m	3:6/4:ST, 1:1/8"/2:PE

Borehole:sec	Sec. length (m)	Type of section	Type of dummy	Packer length	Lead-through (no:diameter:type)
KA3578G01:1	6.5 – 12.58	P		1 m	1:6/4:PA
KA3578G01:2	4.3 – 5.5	P, HC	PE	2 m	2:6/4:PA, 1:1/8"/2:PE
KA3579G:1	14.7 – 22.65	P		1 m	1:6/4:PA
KA3579G:2	12.5 – 13.7	P		1 m	2:6/4:PA
KA3579G:3	2.3 – 11.5	P		2 m	3:6/4:PA
KA3584G01:1	7 – 12	P		2 m	1:6/4:PA
KA3584G01:2	1.3 – 5	P		1 m	2:6/4:PA
KA3590G01:1	16 – 30	P		1 m	1:6/4:PA
KA3590G01:2	7 – 15	P, F, F		1 m	4:6/4:PA
KA3590G01:3	1.3 – 6	P, HC		1 m	5:6/4:PA, 1:1/8"/2:PE
KA3590G02:1	25.5 – 30.01	P, F		2 m	2:6/4:PA
KA3590G02:2	15.2 – 23.5	P		2 m	3:6/4:PA
KA3590G02:3	11.9 – 13.2	P, HC	PE	2 m	4:6/4:PA, 1:1/8"/2:PE
KA3590G02:4	1.3 – 9.9	P		1 m	5:6/4:PA, 1:1/8"/2:PE
KA3593G:1	25.2 – 30.02	P		1 m	1:6/4:PA
KA3593G:2	23.5 – 24.2	P, HC	PE	1 m	2:6/4:PA, 1:1/8"/2:PE
KA3593G:3	9 – 22.5	P		2 m	3:6/4:PA, 1:1/8"/2:PE
KA3593G:4	3 – 7	P, F		2 m	5:6/4:PA, 1:1/8"/2:PE
KA3600F:1	43 – 50.1	P		1 m	1:6/4:PA
KA3600F:2	40.5 – 42	P, HC	PE	1 m	2:6/4:PA, 1:1/8"/2:PE
KA3600F:3	20 – 39.5	P		2 m	3:6/4:PA, 1:1/8"/2:PE
KA3600F:4	1.3 – 18	P		1 m	4:6/4:PA, 1:1/8"/2:PE
KA3510A:1	125 – 150	P		1 m	1:6/4:PA
KA3510A:2	110 - 124	P, F		1 m	3:6/4:PA
KA3510A:3	75 - 109	P		1 m	4:6/4:PA
KA3510A:4	51 - 74	P		1 m	5:6/4:PA
KA3510A:5	4.5 - 50	P		1 m	6:6/4:PA
KG0021A01:1	42.5 – 48.82	P, HC		1 m	1:6/4:ST, 1:1/8"/2:PE
KG0021A01:2	37 – 41.5	P		1 m	2:6/4:PA, 1:1/8"/2:PE
KG0021A01:3	35 - 36	P, C	HD	1 m	5:6/4:PA, 1:1/8"/2:PE
KG0021A01:4	19 - 34	P		1 m	6:6/4:PA, 1:1/8"/2:PE
KG0021A01:5	5 - 18	P		1 m	7:6/4:PA, 1:1/8"/2:PE
KG0048A01:1	49 – 54.69	P, HC		1 m	1:6/4:ST, 1:1/8"/2:PE
KG0048A01:2	34.8 – 48	P		1 m	2:6/4:PA, 1:1/8"/2:PE
KG0048A01:3	32.8 – 33.8	P, C	HD	1 m	5:6/4:PA, 1:1/8"/2:PE
KG0048A01:4	13 – 31.8	P		1 m	6:6/4:PA, 1:1/8"/2:PE
KG0048A01:5	5 - 12	P		1 m	7:6/4:PA, 1:1/8"/2:PE

Type of section:

P Pressure measurement
C Circulation possible
HC Hydrochemistry sampling
F Flow

Materials:

PA Polyamide
ST Steel
PE PEEK
HD HD1000 (High Density Polyethylene)

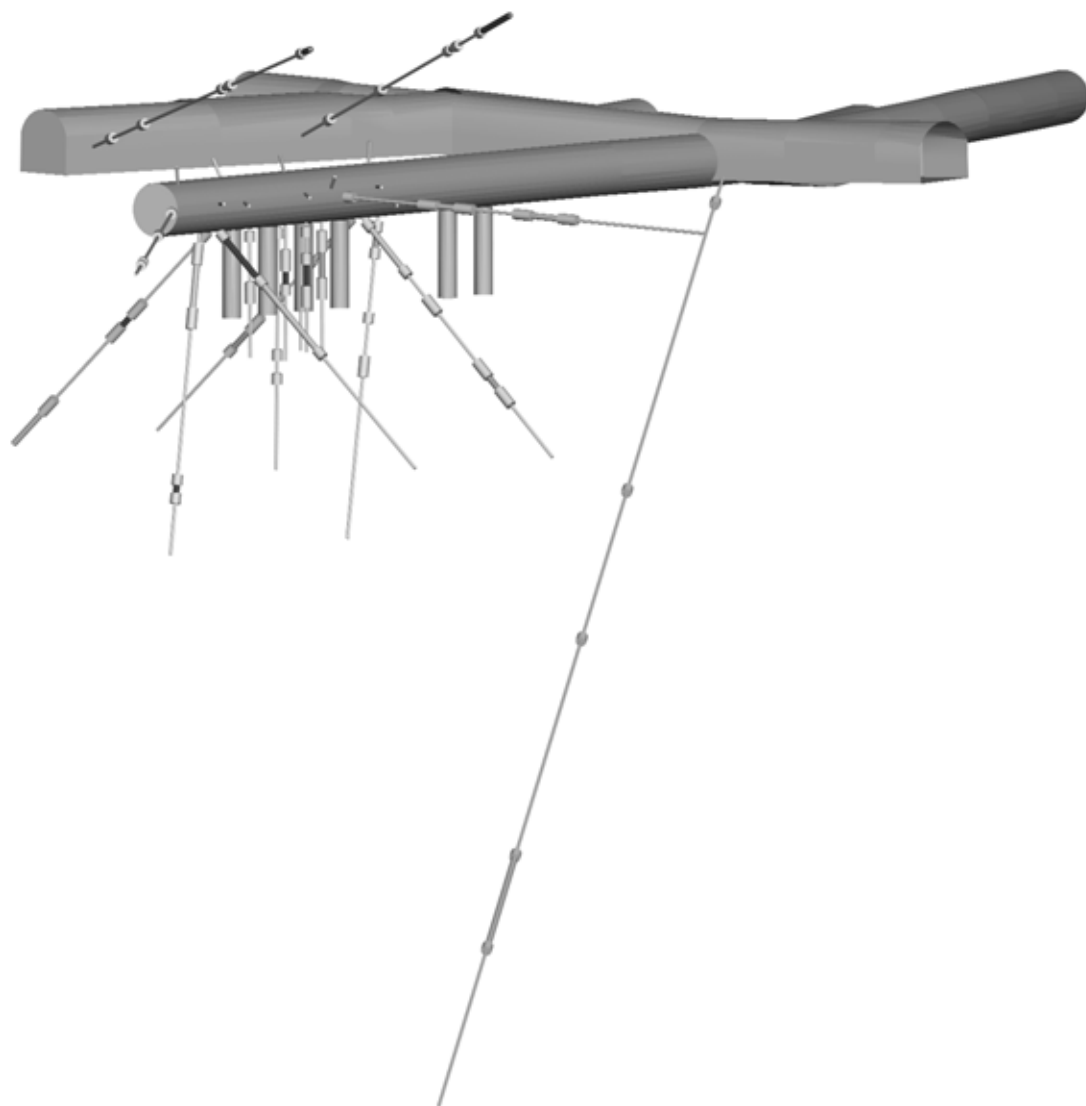

Figure 1. View of the drilled core holes in the Prototype Repository Section I. The length from the I-tunnel to the end of the TBM-tunnel is 90 m. The diameter of the TBM tunnel is 5m and the diameter of the deposition holes is 1.75 m. The depth of the deposition holes is 8.37 m in the centre and 8.15 m along the deposition hole wall. The diameter of the core holes is 76 mm except for the short core holes in the roof of the TBM tunnel that have a diameter of 56 mm. The monitoring boreholes used in the presentation in this report are located in the inner part of the tunnel surrounding the area with the four innermost canister holes. Also included are two holes drilled from the G-tunnel and the long hole KA3510A drilled from the main tunnel.

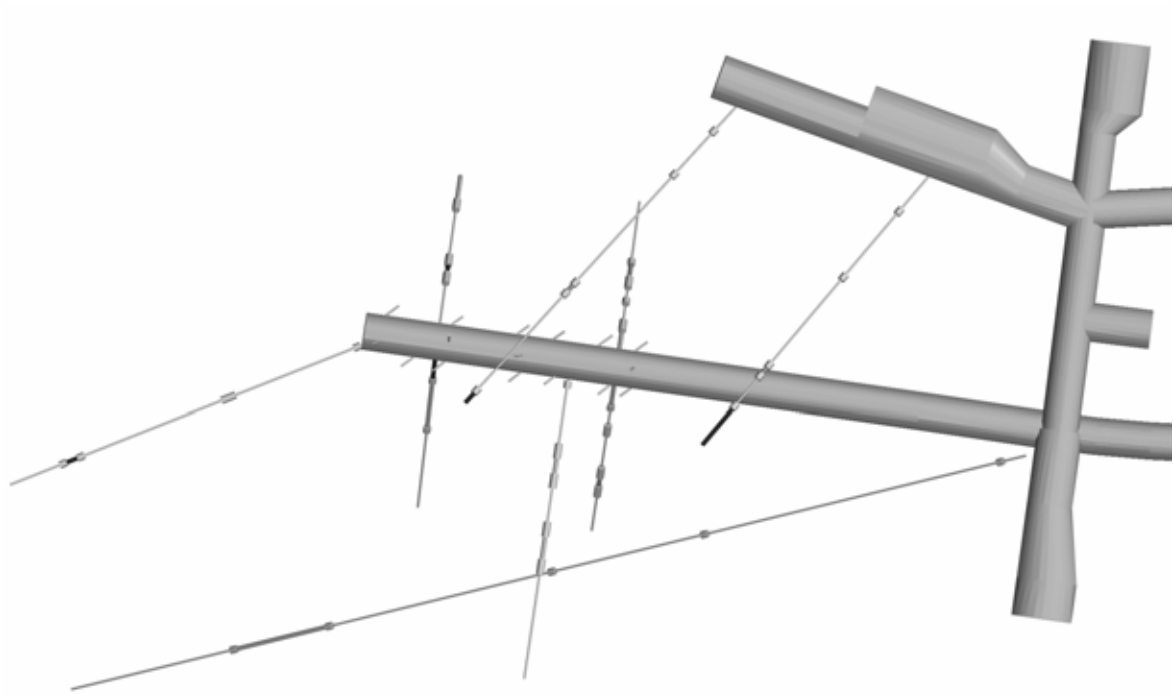

Figure 2. Overview of Sektion I in Prototype Repository

Instrumentation with hydraulic packers in Section II

Fifteen boreholes were equipped with hydraulically expanded packers of one meters length to seal off at most five sections in one borehole. In ten of these boreholes one section also were instrumented with hydro-mechanical equipment adapted to measure small deformations in the solid rock and over selected fractures. Another borehole in the G-tunnel was instrumented with HM equipment as a reference. The borehole was drilled in the north tunnel wall and is not expected to be influenced by the stress changes around the Prototype tunnel.

Table 2 Instrumentation configuration in Section II. “Lead-through”: pipes between the packers.

Borehole:sec	Sec. length (m)	Type of section	Tubes/pipes (no:diameter:type)
KA3539G:1	18.6 – 30	P	1:4/2:PA, 1:6/4:PA
KA3539G:2	15.85 – 17.6	P, HM, C	2:4/2:PA, 3:6/4:PA, 3:4/2:ST, 2:8/6:ST
KA3539G:3	10 – 14.85	P, F	3:4/2:PA, 4:6/4:PA, 3:4/2:ST, 2:8/6:ST
KA3539G:4	4 – 9	P	4:4/2:PA, 4:6/4:PA, 3:4/2:ST, 2:8/6:ST
KA3542G01:1	27 – 30	P	1:4/2:PA, 1:6/4:PA
KA3542G01:2	21.3 – 26	P	2:4/2:PA, 1:6/4:PA
KA3542G01:3	18.6 – 20.3	P, HM,C	3:4/2:PA, 3:6/4:PA, 3:4/2:ST, 2:8/6:ST
KA3542G01:4	10.5 – 17.6	P	4:4/2:PA, 3:6/4:PA, 3:4/2:ST, 2:8/6:ST
KA3542G01:5	3.5 – 9.5	P	5:4/2:PA, 3:6/4:PA, 3:4/2:ST, 2:8/6:ST
KA3542G02:1	28.2 – 30.01	P	1:4/2:PA, 1:6/4:PA
KA3542G02:2	25.6 – 27.2	P, HM, C	2:4/2:PA, 3:6/4:PA, 3:4/2:ST, 2:8/6:ST
KA3542G02:3	21.5 – 24.6	P	3:4/2:PA, 3:6/4:PA, 3:4/2:ST, 2:8/6:ST
KA3542G02:4	9 – 20.5	P	4:4/2:PA, 3:6/4:PA, 3:4/2:ST, 2:8/6:ST
KA3542G02:5	2 – 8	P, F	5:4/2:PA, 4:6/4:PA, 3:4/2:ST, 2:8/6:ST
KA3544G01:1	11.65 – 12	P	1:4/2:ST, 1:6/4:ST
KA3544G01:2	8.9 – 10.65	P, HM, C	5:4/2:ST, 3:6/4:ST, 2:8/6:ST
KA3544G01:3	3.5 – 7.9	P	6:4/2:ST, 3:6/4:ST, 2:8/6:ST
KA3546G01:1	9.3 – 12	P	1:4/2:ST, 1:6/4:ST
KA3546G01:2	6.75 – 8.3	P, HM, C	5:4/2:ST, 3:6/4:ST, 2:8/6:ST
KA3546G01:3	1.5 – 5.75	P	6:4/2:ST, 3:6/4:ST, 2:8/6:ST
KA3548A01:1	21.5 – 30	P	1:4/2:PA, 1:6/4:PA
KA3548A01:2	11.75 – 20.5	P, F	2:4/2:PA, 2:6/4:PA
KA3548A01:3	8.8 – 10.75	P, HM, C	3:4/2:PA, 4:6/4:PA, 3:4/2:ST, 2:8/6:ST
KA3548A01:4	3 – 7.8	P	4:4/2:PA, 4:6/4:PA, 3:4/2:ST, 2:8/6:ST
KA3548G01:1	6-12	P	2:6/4:PA
KA3548G01:2	2-5	P	3:6/4:PA
KA3550G01:1	8.3 – 12.03	P	1:4/2:ST, 1:6/4:ST
KA3550G01:2	5.2 – 7.3	P, HM, C	5:4/2:ST, 3:6/4:ST, 2:8/6:ST
KA3550G01:3	1.8 – 4.2	P	6:4/2:ST, 3:6/4:ST, 2:8/6:ST
KA3550G05:1	1.5 – 3	P	1:4/2:ST, 1:6/4:ST
KA3551G05:1	1.5 – 3.1	P	1:4/2:ST, 1:6/4:ST
KA3552G01:1	7.05 – 12	P	1:4/2:ST, 1:6/4:ST
KA3552G01:2	4.35 – 6.05	P, HM, C	5:4/2:ST, 3:6/4:ST, 2:8/6:ST
KA3552G01:3	1.5 – 3.35	P	6:4/2:ST, 3:6/4:ST, 2:8/6:ST
KA3554G01:1	25.15 – 30.01	P	1:4/2:PA, 1:6/4:PA
KA3554G01:2	22.6 – 24.15	P, HM, C	2:4/2:PA, 3:6/4:PA, 3:4/2:ST, 2:8/6:ST
KA3554G01:3	14 – 21.6	P	3:4/2:PA, 3:6/4:PA, 3:4/2:ST, 2:8/6:ST
KA3554G01:4	5 – 13	P	4:4/2:PA, 3:6/4:PA, 3:4/2:ST, 2:8/6:ST
KA3554G01:5	1.5 – 4	P	5:4/2:PA, 3:6/4:PA, 3:4/2:ST, 2:8/6:ST

Borehole:sec	Sec. length (m)	Type of section	Tubes/pipes (no:diameter:type)
KA3554G02:1	22 – 30.01	P	1:4/2:PA, 1:6/4:PA
KA3554G02:2	15.9 – 21	P	2:4/2:PA, 1:6/4:PA
KA3554G02:3	13.2 – 14.9	P	3:4/2:PA, 1:6/4:PA
KA3554G02:4	10.5 – 12.2	P, HM, C	4:4/2:PA, 3:6/4:PA, 3:4/2:ST, 2:8/6:ST
KA3554G02:5	1.5 – 9.5	P	5:4/2:PA, 3:6/4:PA, 3:4/2:ST, 2:8/6:ST
KA3557G:1	15 – 30.04	P	1:4/2:PA, 1:6/4:PA
KA3557G:2	1.5 – 14	P	2:4/2:PA, 1:6/4:PA
KG0010B01:1	2.8 – 4.35	HM	3:4/2:ST, 2:8/6:ST

Type of section:

P Pressure measurement
 C Circulation possible
 HM Hydro-mechanical measurements

Materials:

PA Polyamide tube
 ST Stainless steel pipe
 F Flow

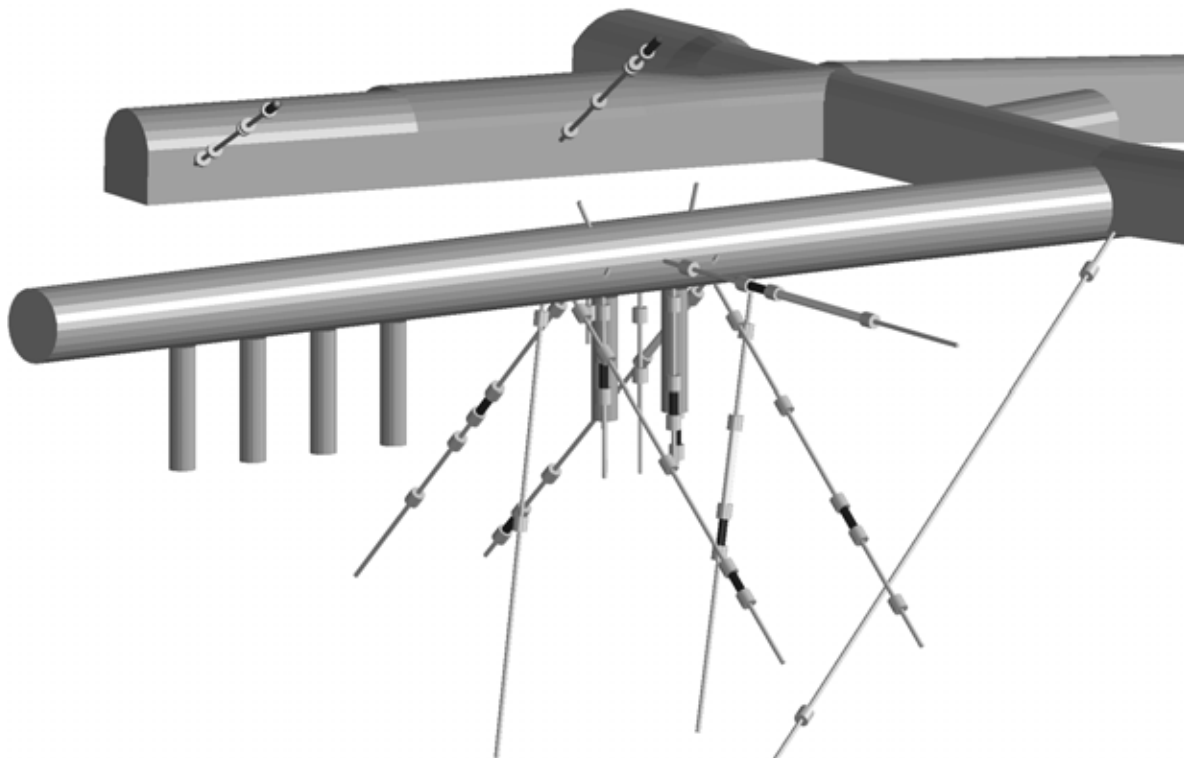

Figure 3 View of the drilled core holes in the Prototype Repository Section II. The length from the I-tunnel to the end of the TBM-tunnel is 90 m. The diameter of the TBM tunnel is 5 m and the diameter of the deposition holes is 1.75 m. The depth of the deposition holes is 8.37 m in the centre and 8.15 m along the deposition hole wall. The diameter of the core holes is 76 mm except for the short core holes in the roof of the TBM tunnel that have a diameter of 56 mm. The monitoring boreholes used in the presentation in this report are located in the inner part of the tunnel surrounding the area with the four innermost canister holes. Also included are two holes drilled from the G-tunnel and the long hole KA3510A drilled from the main tunnel.

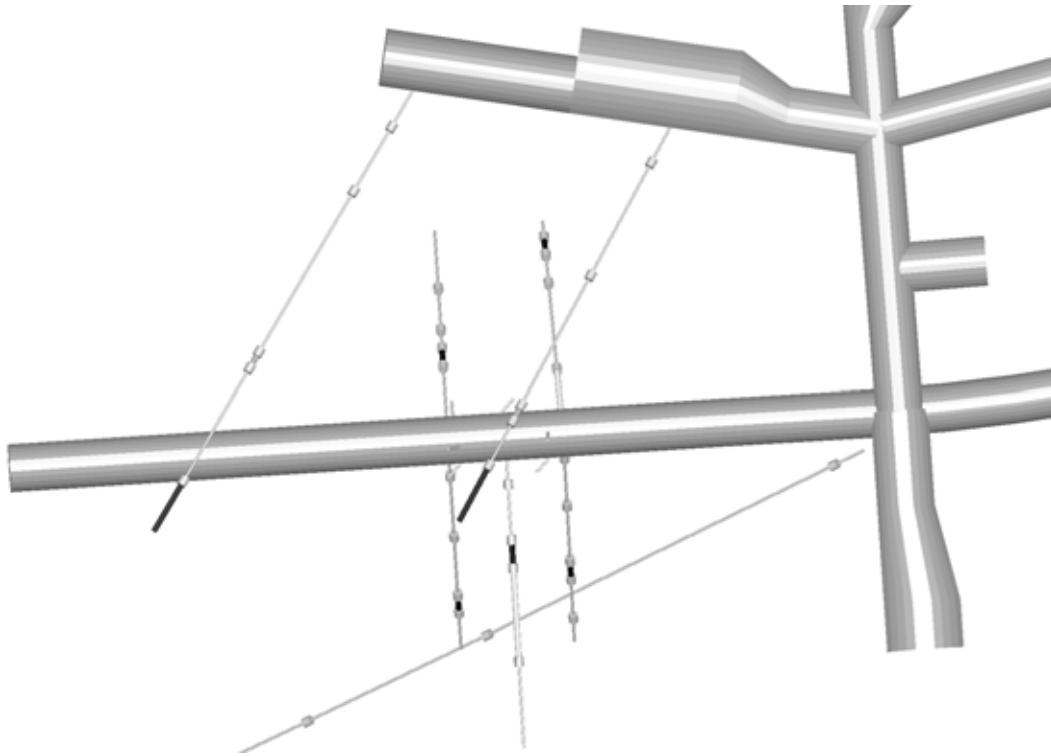

Figure 4 Overview of Sektion II in Prototype Repository

Instrumentation with mechanical packers

Twenty-two short boreholes (2 m) in the tunnel roof and walls were equipped with mechanical packers, see Table 2. After insertion into the hole, the pulling of a nut on the centre pipe expanded the packer. Since these holes were directed upwards, the de-airation required an extra lead-through connected to a tube ending in the innermost part of the borehole. The de-airation was made during the backfilling and in boreholes with very little flow the de-airation was made by filling water through the outer tube.

Table 2 Boreholes instrumented with mechanical packers (“Inclination”: inclination of the borehole.).

Borehole	Borehole length (m)	Inclination (°)
KA3543A01	2.06	-0.8
KA3543I01	2.06	70.5
KA3548D01	2.06	2.7
KA3552A01	2.06	-2.8
KA3552H01	2.1	58.2
KA3553B01	2.02	-37.7
KA3563A01	2.06	-7.7
KA3563D01	approx. 2	2.8
KA3563I01	2.15	73
KA3566C01	2.1	3.5
KA3568D01	2.3	-2.3
KA3573C01	2.05	34.9
KA3574D01	2.05	12.6
KA3578C01	2.09	-5.4
KA3578H01	1.9	59.1
KA3579D01	2	-1
KA3588C01	2.04	-4
KA3588D01	1.9	-1.8
KA3588I01	1.96	65.6
KA3592C01	2.1	4.4
KA3597D01	2.22	3.1
KA3597H01	2.06	55.1

Calibration intervals

Recalibration of pressure transducers are made a couple of times every year. In Table 3 the calibration dates this far are shown

Table 3 Calibration dates

Calibration dates
2002-01-04
2002-04-12
2002-08-15
2002-12-16
2003-04-03
2003-08-13 – 2003-08-18
2003-12-10 – 2003-12-11
2004-04-06 – 2004-04-08
2004-08-05 – 2004-08-06

Pressure measurements

In this section pressure measurements of all monitored holes in the Prototype repository is shown in plots below. The pressure values plotted are daily mean values. The definition of day 0 is the day the heating of canister 1 started, i.e. 2001-09-17. In Table 4 the dates of the starting of the heaters in all canisters are presented.

Table 4 Starting of heaters in canisters

Canister deposition hole	in	Date
1 (DA3587G)		2001-09-17
2 (DA3581G)		2001-09-24
3 (DA3575G)		2001-11-10
4 (DA3569G)		2001-11-24
5 (DA3551G)		2003-05-08
6 (DA3545G)		2003-05-23

The position of pressure measurement is indicated for all observation sections.

In general sections close to the prototype rock wall indicate lower pressure head than further away from the prototype.

In the longer holes the section closest to the wall have a lower head than sections deeper into the rockmass.

A pressure drop 2002-05-07 for most of the observation sections are shown in the plots. The most major pressure change happens in the lowest section of KA3566G02 (approx. 70 m) but are also clearly visible for section 2-4 of the same borehole. The pressure recovered during the evening of 2002-12-02. The cause for the pressure change is unknown.

Several sections have had a slight decreasing trend since the summer of 2002. This trend have in most cases been discontinued after 2004-11-01.

The instrumentation of boreholes in Section II started 2002-11-06 and continued until the beginning of December 2002. Several sections indicate a pressure drop around 2002-11-11 which probably is caused by the installation work.

The sections of KA3510A show a drop of pressure during the the first week of December 2002. The pressure is quickly re-established. Probably the cause for this was the on-going monitoring work in Section II.

During the period 2003-05-08 until 2003-05-15 a total of 19 hydraulic tests were done in several of the boreholes in Section I and II. The tests caused groundwater pressure interference in the whole of the prototype repository area. Since the tests were mostly short-time tests it is only shown in some of the borehole section plots.

During the summer 2003 (2003-07-13 to 2003-08-05) no pressure data was recorded. In some of the long boreholes inclined to the south of the prototype show a pressure drop in mid-August.

The packers in KA3550G01 were deflated 2003-08-18 and has not been possible to re-inflate again. The reason is probably a tube leakage.

Hydraulic single hole tests were done in nine boreholes during 2003-10-21 – 10-23. The tests caused groundwater pressure interference in the whole of the prototype repository area. Since the tests were mostly short-time tests it is only shown in some of the borehole section plots.

The packers in five boreholes were deflated around Oct 30 – Nov 1, 2003. This was probably generated by a tube leakage which in its turn emptied the water in the pressure vessel and finally emptied the gas tube connected to it. The boreholes whose packers were deflated were KA3542G01, KA3542G02, KA3544G01 and KA3548A01. It was possible to inflate the packers in three of the four boreholes on 2003-11-10. It was not possible to restore the status of KA3544G01. This pressure drop is observed in several other borehole observation sections.

Hydraulic single hole tests were done in eight boreholes during 2004-02-02 – 02-04. The tests caused groundwater pressure interference in the whole of the prototype repository area. Since the tests were mostly short-time tests it is only shown in some of the borehole section plots.

A pressure drop of around 700 kPa in KA3566G01:4 is observed 2004-02-25. It remained so for some weeks before recovering, but dropped again in May and remains that way at the end of the month. This pattern was observed in this section during the spring 2003. The following investigation showed a faulty data-scan coupling (corrosion) which were replaced 2004-08-10.

Hydraulic single hole tests were done in eight boreholes during 2004-08-11 – 08-18. The tests caused groundwater pressure interference in the whole of the prototype repository area. Since the tests were mostly short-time tests it is only shown in some of the borehole section plots.

Drainage of Section I

The drainage system in Section I was shut down 2004-11-01. It have resulted in a major pressure increase in most borehole sections close to the prototype tunnel. The pressure have increased since the closing-down date.

The drained water amount have been approximately 2.5 L/min. The flowrate of weir MG0004G decreases accordingly with the same order of magnitude after November 1.

Packer functionality status in Section II

The packers are of the type PU53 or PU72. All packers have an inflation length of one meter and the minimum and maximum packer expansion pressure is 6.5 bar and 65 bar respectively. They are expanded by means of water, pressurised by nitrogen gas in a pressure vessel. A regulator controls the magnitude of the inflation pressure. The stainless steel pressure vessel is connected to the packers by a high-pressure 6/4-mm polyamide tube, type Tecalan. A check valve unit with a manometer is mounted on the packer inflation line. In order to avoid accidental deflation the check valve unit also includes a stop valve.

In the table below are listed the borehole packers that have ceased to function for some reason.

Table 5 Packer functionality status in Section II

Packer tube label	Borehole	Status 2004-12-01	Date of earlier inflation pressure failure	Date of re-inflation pressure
XRA1100	KA3539G	OK		
XRA1200	KA3542G01	OK	2003-10-30	2003-11-10
XRA1300	KA3542G02	OK	2003-10-30	2003-11-10
XRA1600	KA3544G01	Not functioning due to tube leakage	2003-10-30	-
XRA1700	KA3546G01	OK		
XRA1800	KA3548A01	OK	2003-10-30	2003-11-10
XRA2000	KA3548G01	OK		
XRA2100	KA3550G01	Not functioning due to tube leakage	2003-08-18	-
XRA2200	KA3550G05	OK		
XRA2300	KA3551G05	OK		
XRA2500	KA3552G01	OK		
XRA2800	KA3554G01	OK		
XRA2900	KA3554G02	OK		
XRA3000	KA3557G	OK		

Deformation measurements in Section II

Deformation measurements of fractures in borehole sections with Hydro-Mechanical anchors in Section II are on-going but no results are available yet.

Flow measurements

Earlier estimations and measurements of inleaking ground water amounts to the tunnel system are presented in (*Forsmark T, Rhén I, 2001*) and (*Rhén I, Forsmark T, 2001*).

Data from six flow weirs are presented in this data report.

A weir at the tunnel G opening measures the inleaking amounts from this tunnel. The weir is named MG0004G. The pumped water amounts from Section I mentioned above was prior to to November 1, 2004 included in the rates from this weir station which is clearly shown in the diagram below.

The weir MF0061G halfway down tunnel F measures the inleaking amounts from the north part of tunnel J (J+) and the first half of tunnel F, see plot of this weir. Early in the presented period, autumn 2001, inleaking water from tunnel G was led to tunnel F and weir MF0061G thereby to some extent explaining the high flowrate during that period.

The weir MA3426G measures the flow rates from the south part of tunnel J, tunnel I and tunnel A chainage 3426 – 3600 m.

In December 2003 three new flow measurement weirs were constructed in the A-tunnel outside Section II plug. They are called MA3515G, MA3525G and MA3535G. Continuous measurement is done since the spring of 2004. Manual measurements done in December 2003 show a flowrate for MA3515G of 0.175 – 0.19 L/min, for MA3525G of 1.15 – 1.25 L/min and for MA3535G of 0.38 – 0.45 L/min. The increase of flow during October 2004 was caused by yet unknown causes, but it is believed that the final grouting that was done around Plug 2 October 8, 2004 is the cause to it. The flowrates have now decreased once again.

Two weirs are currently (December 2004) being constructed outside niches I and J. They will be included in the continuously measurement program when finalized.

Water sampling

Water sampling for chemical analysis have been done at several occasions, see Table 6. Each one of them may have an short-lived effect on the hydrostatic pressure in the rockmass. In some cases the flowing of a section continued for several days and the following pressure response is clearly shown in the subsequent plot.

Table 6 Water sampling dates in boreholes close to the Prototype Repository. Start and stop of times are for the flowing of the section.

Borehole	Start date/time	Stop date/time	Secup	Seclow	Section number
KA3600F	2001-10-15 10:30:00	2001-10-15 10:45:00	40.50	42.00	2
KA3600F	2001-10-15 10:45:00	2001-10-15 11:15:00	43.00	50.10	1
KA3573A	2002-09-24 10:30:00	2002-09-24 11:00:00	26.00	40.07	1
KA3573A	2002-09-24 11:40:00	2002-09-24 13:40:00	21.00	24.00	2
KA3600F	2002-09-25 11:00:00	2002-09-25 13:40:00	40.50	42.00	2
KA3600F	2002-09-25 11:25:00	2002-09-25 11:44:00	43.00	50.01	1
KA3510A	2002-12-12 08:30:00	2002-12-12 08:50:00	4.50	50.00	5
KA3510A	2002-12-12 08:30:00	2002-12-12 08:52:00	110.00	124.00	2
KA3510A	2002-12-12 10:30:00	2002-12-12 11:04:00	75.00	109.00	3
KA3539G	2003-05-23 09:48:00	2003-05-23 09:53:00	15.85	17.60	2
KA3542G01	2003-06-02 09:28:00	2003-06-02 09:54:00	18.60	20.30	3
KA3548A01	2003-06-02 09:57:00	2003-06-02 10:15:00	8.80	10.75	3
KG0048A01	2003-06-03 10:06:00	2003-06-03 10:12:00	32.80	33.80	3
KA3554G01	2003-06-03 10:31:00	2003-06-03 10:38:00	22.60	24.15	2
KA3542G02	2003-06-04 11:09:00	2003-06-04 12:49:00	25.60	27.20	2
KA3566G02	2003-06-04 12:30:00	2003-06-04 17:30:00	16.00	18.00	2
KG0021A01	2003-06-30 11:03:00	2003-06-30 11:09:00	35.00	36.00	3
KA3554G02	2003-06-30 15:23:00	2003-06-30 21:40:00	10.50	12.20	4
KA3600F	2003-07-03 13:51:00	2003-07-03 13:53:00	40.50	42.00	2
KA3572G01	2003-08-11 15:28:00	2003-08-28 15:00:00	2.70	5.30	2
KG0021A01	2003-09-18 09:40:00	2003-09-18 09:55:00	35.00	36.00	3
KG0048A01	2003-09-18 09:45:00	2003-09-18 09:55:00	32.80	33.80	3
KA3542G01	2003-09-24 09:15:00	2003-09-24 09:30:00	18.60	20.30	3

Borehole	Start date/time	Stop date/time	Secup	Seclow	Section number
KA3539G	2003-09-24 09:20:00	2003-09-24 09:35:00	15.85	17.60	2
KA3548A01	2003-09-24 09:30:00	2003-09-24 10:00:00	8.80	10.75	3
KA3554G01	2003-09-24 09:30:00	2003-09-24 10:00:00	22.60	24.15	2
KA3573A	2003-09-25 09:00:00	2003-09-25 10:00:00	26.00	40.07	1
KA3600F	2003-09-25 09:00:00	2003-09-25 09:45:00	43.00	50.10	1
KA3600F	2003-09-25 09:30:00	2003-09-25 10:00:00	40.50	42.00	2
KA3542G02	2003-09-26 11:20:00	2003-09-26 11:35:00	2.00	8.00	5
KA3573A	2003-09-29 10:20:00	2003-09-29 10:40:00	21.00	24.00	2
KA3566G02	2003-09-29 11:00:00	2003-09-29 13:50:00	16.00	18.00	2
KA3590G01	2003-09-30 09:00:00	2003-09-30 12:45:00	16.00	30.00	2
KA3539G	2004-02-16 10:50:00	2004-03-22 11:26:00	15.85	17.60	2
KA3548A01	2004-02-16 12:13:00	2004-02-16 12:31:00	8.80	10.75	3
KA3600F	2004-02-17 09:55:00	2004-02-17 10:11:00	40.50	42.00	2
KG0021A01	2004-02-17 10:27:00	2004-02-17 10:43:00	35.00	36.00	3
KA3539G	2004-02-17 11:30:00	2004-02-17 11:31:00	15.85	17.60	2
KG0048A01	2004-03-02 09:24:00	2004-03-02 09:40:00	32.80	33.80	3
KA3554G01	2004-03-02 10:04:00	2004-03-02 10:17:00	22.60	24.15	2
KA3542G02	2004-03-02 10:22:00	2004-03-02 13:15:00	2.80	8.00	5
KA3590G01	2004-03-03 21:36:00	2004-03-03 21:36:00	7.00	15.00	2
KA3572G01	2004-04-02 10:35:00	2004-04-07 10:15:00	2.70	5.30	2
KA3573A	2004-09-22 09:15:00	2004-09-22 09:50:00	26.00	40.07	1
KA3600F	2004-09-22 09:15:00	2004-09-22 10:00:00	43.00	50.10	1
KA3573A	2004-09-22 09:30:00	2004-09-22 10:00:00	21.00	24.00	2
KA3600F	2004-09-22 09:30:00	2004-09-22 09:40:00	40.50	42.00	2
KA3542G01	2004-11-09 09:30:00	2004-11-09 10:10:00	18.60	20.30	3
KA3554G02	2004-11-19 08:30:00	2004-11-22 16:50:00	10.50	12.20	4
KA3566G02	2004-11-19 08:30:00	2004-11-22 09:53:00	16.00	18.00	2

References

Forsmark T, Rhén I, 2001. Äspö HRL – Prototype repository. Hydrogeology - Injection test campaign 2. flow measurement of DA3575G01, groundwater salinity, ground water leakage into G-, I- and J-tunnels. SKB IPR-01-31.

Rhén I, Forsmark T, Torin L, 2001. Äspö HRL – Prototype repository. Hydrogeological, hydrochemical and temperature measurements in boreholes during the operation phase of the prototype repository. Tunnel section I. SKB IPR-01-32.

Rhén I, Forsmark T, Magnusson J, Alm P, 2003. Äspö HRL – Prototype repository. Hydrogeological, hydrochemical, hydromechanical and temperature measurements in boreholes during the operation phase of the prototype repository. Tunnel section II. SKB IPR-03-22.

Rhén I, Forsmark T, 2001. Äspö HRL – Prototype repository. Hydrogeology, Summary report of investigations before the operation phase. SKB IPR-01-65.

KA3510A PRESSURE HEAD

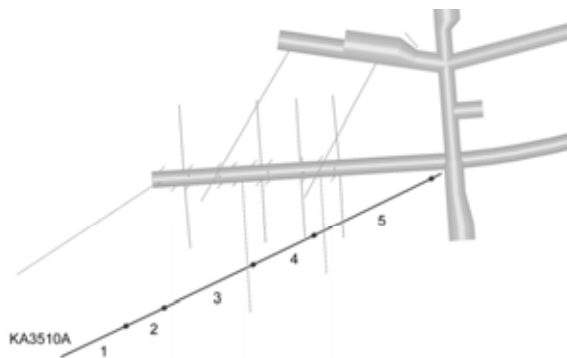
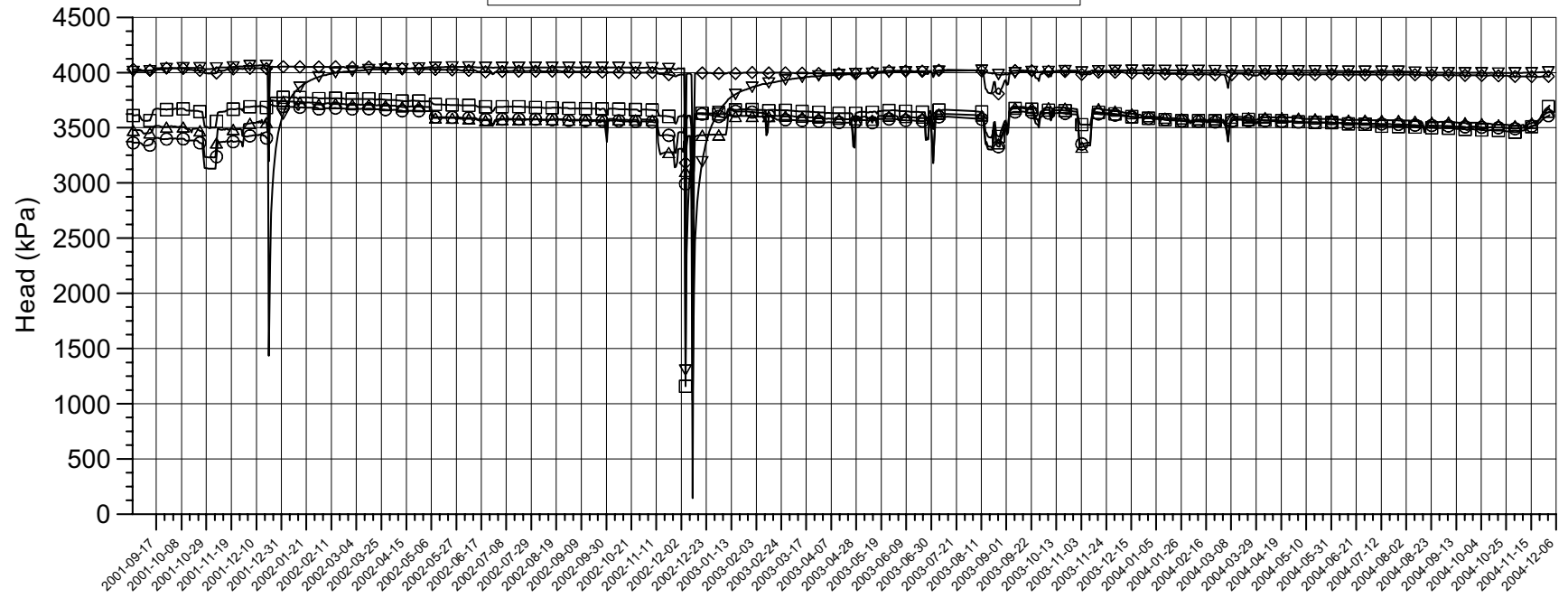

Events

- Start backfilling of section I 2001-09-03
- Stop backfilling of section I 2001-11-20
- Casting of inner plug finalized 2001-12-19
- Start backfilling of section II 2003-04-29
- Stop backfilling of section II 2003-06-27
- Casting of outer plug finalized 2003-09-11

Borehole sections

- ▽—▽ A:1 125 m - 150 m
- ◇—◇ A:2 110 m - 124 m
- A:3 75 m - 109 m
- A:4 51 m - 74 m
- △—△ A:5 4.5 m - 50 m

P_KA3510A.GRF 2004-12-01

KA3539G PRESSURE HEAD

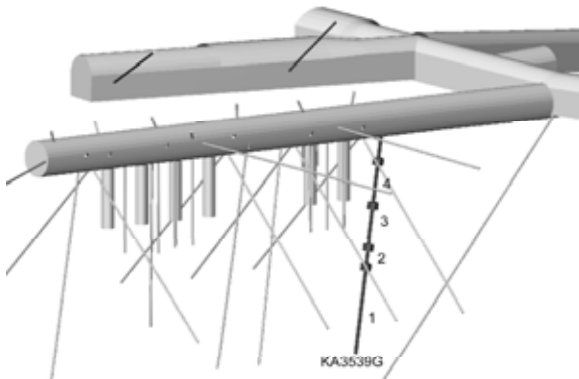
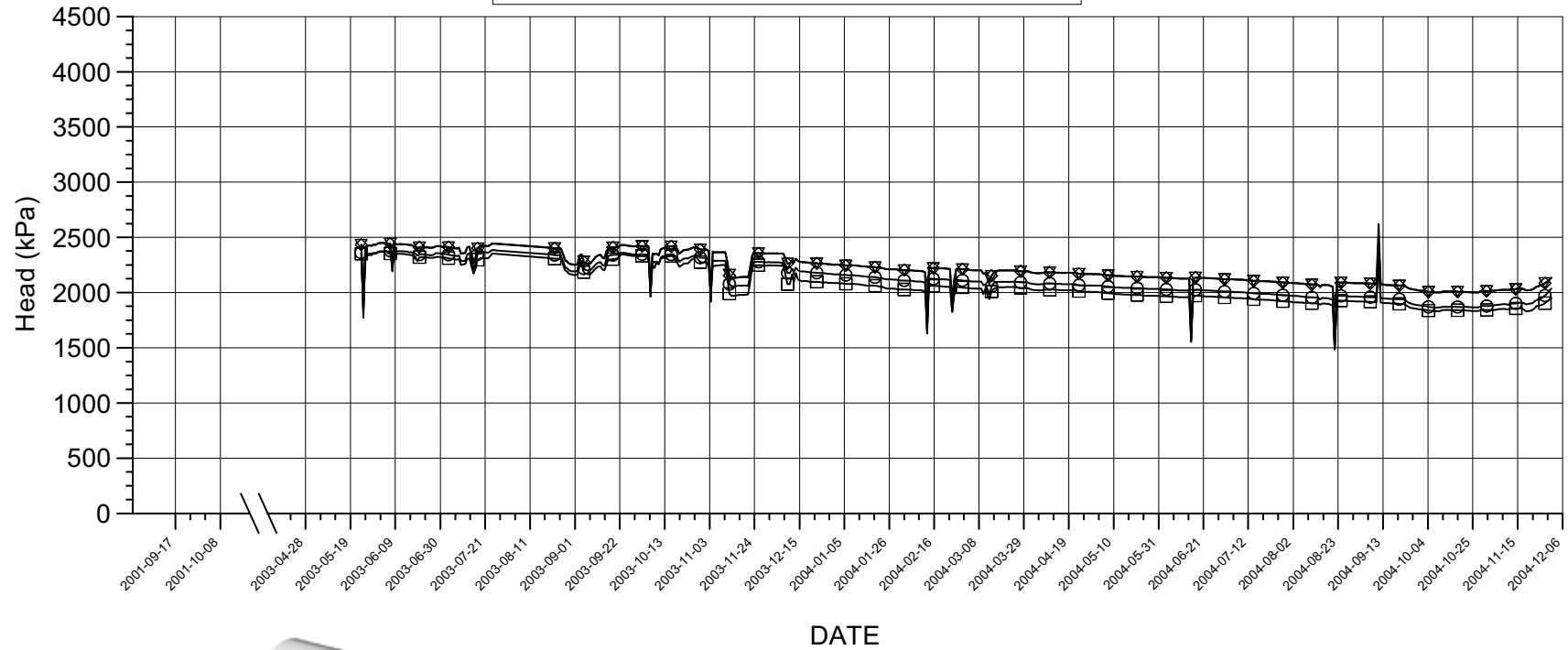

Events

- Start backfilling of section I 2001-09-03
- Stop backfilling of section I 2001-11-20
- Casting of inner plug finalized 2001-12-19
- Start backfilling of section II 2003-04-29
- Stop backfilling of section II 2003-06-27
- Casting of outer plug finalized 2003-09-11

Borehole sections

- ▽ G:1 18.6 m - 30 m
- ◇ G:2 15.85 m - 17.6 m
- G:3 10 m - 14.85 m
- G:4 4 m - 9 m

P_KA3539G.GRF 2004-12-01

KA3542G01 PRESSURE HEAD

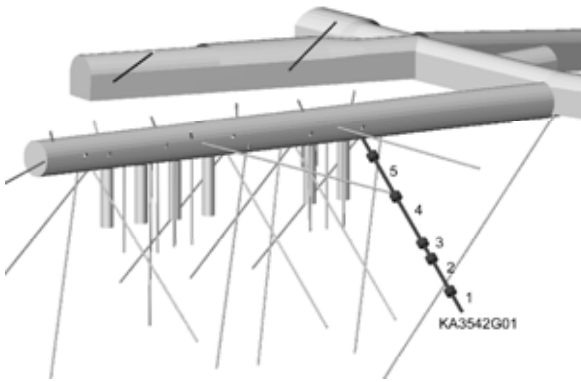
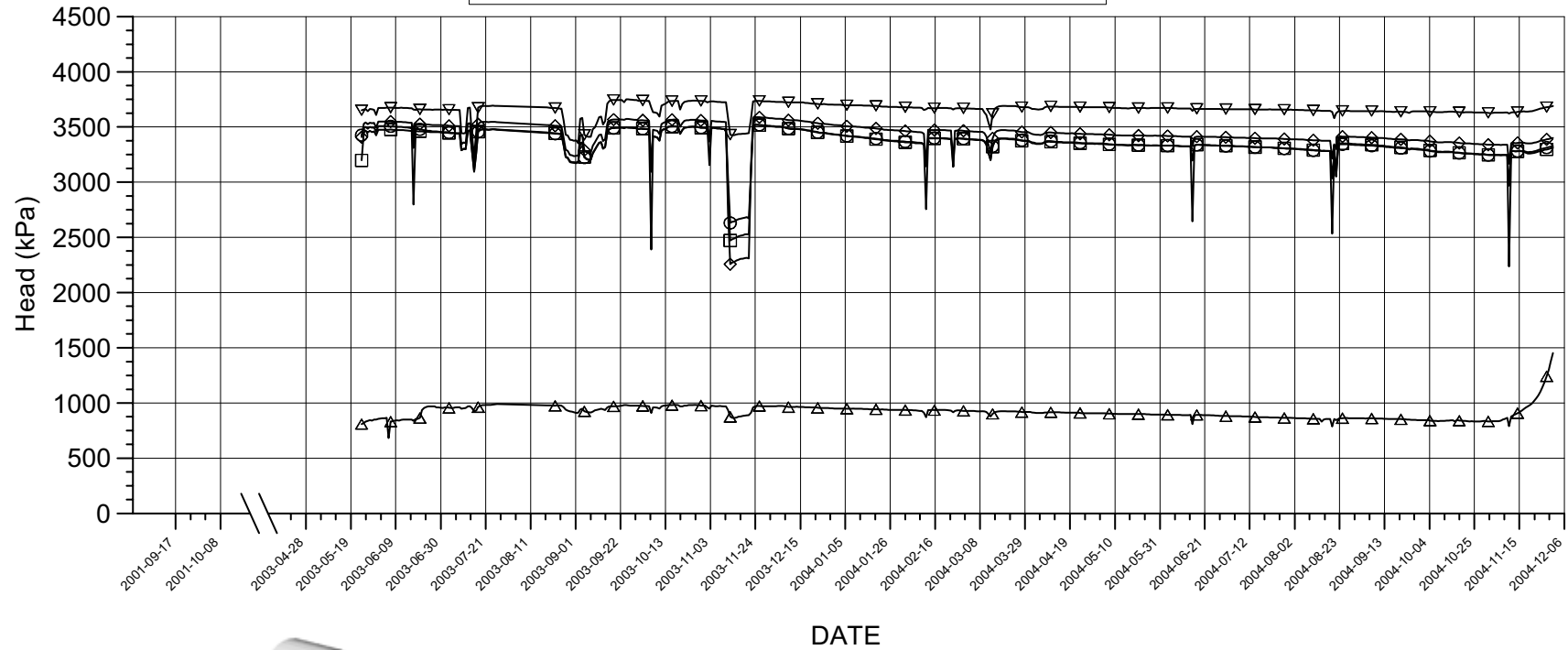

Events

- Start backfilling of section I 2001-09-03
- Stop backfilling of section I 2001-11-20
- Casting of inner plug finalized 2001-12-19
- Start backfilling of section II 2003-04-29
- Stop backfilling of section II 2003-06-27
- Casting of outer plug finalized 2003-09-11

Borehole sections

- ▽ G01:1 27 m - 30 m
- ◇ G01:2 21.3 m - 26 m
- G01:3 18.6 m - 20.3 m
- G01:4 10.5 m - 17.6 m
- △ G01:5 3.5 m - 9.5 m

P_KA3542G01.GRF 2004-12-01

KA3542G02 PRESSURE HEAD

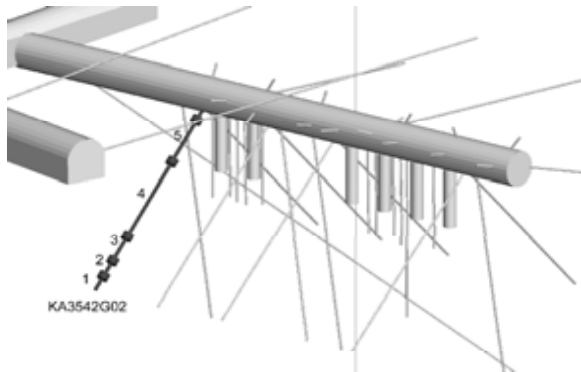
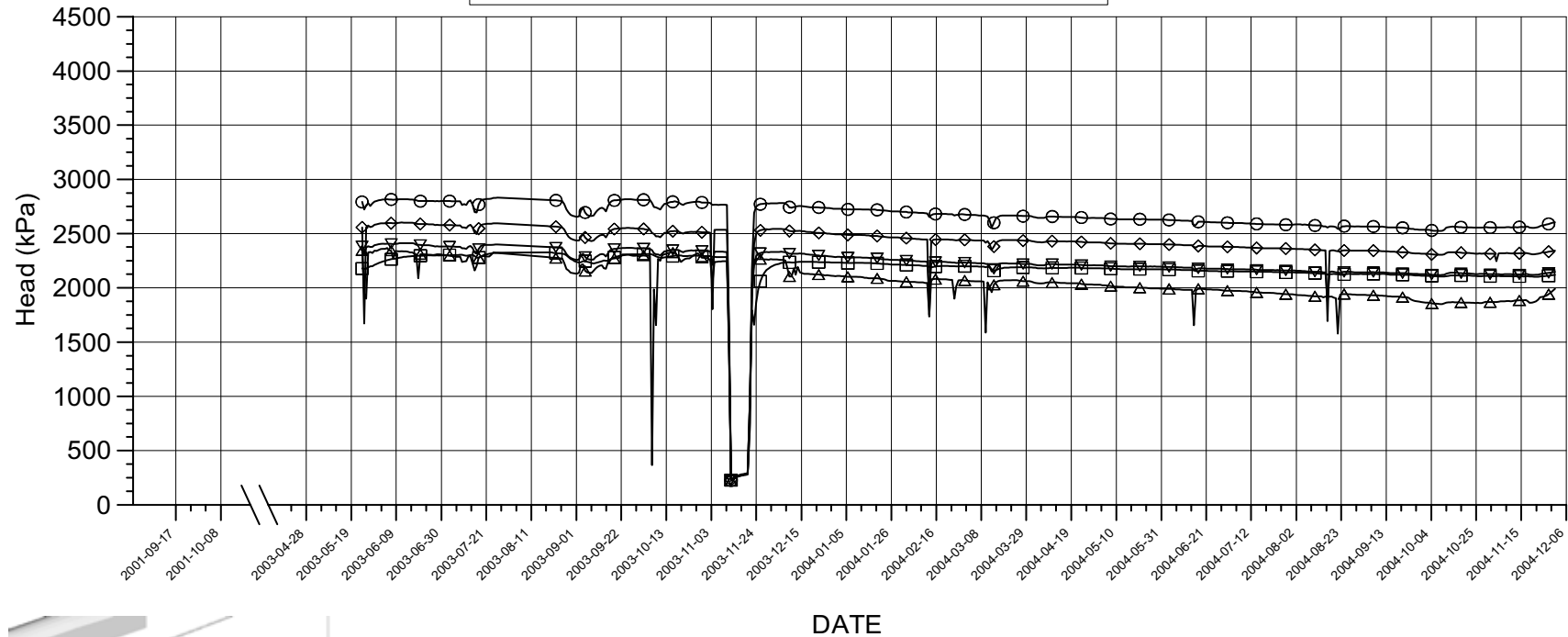

Events

- Start backfilling of section I 2001-09-03
- Stop backfilling of section I 2001-11-20
- Casting of inner plug finalized 2001-12-19
- Start backfilling of section II 2003-04-29
- Stop backfilling of section II 2003-06-27
- Casting of outer plug finalized 2003-09-11

Borehole sections

- ▽ — ▽ G02:1 28.2 m - 30.01 m
- ◇ — ◇ G02:2 25.6 m - 27.2 m
- — □ G02:3 21.5 m - 24.6 m
- — ○ G02:4 9 m - 20.5 m
- △ — △ G02:5 2 m - 8 m

P_KA3542G02.GRF 2004-12-01

KA3543A01, KA3543I01, KA3548D01 PRESSURE HEAD

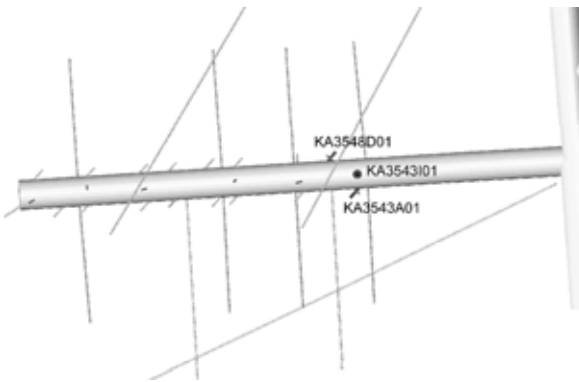
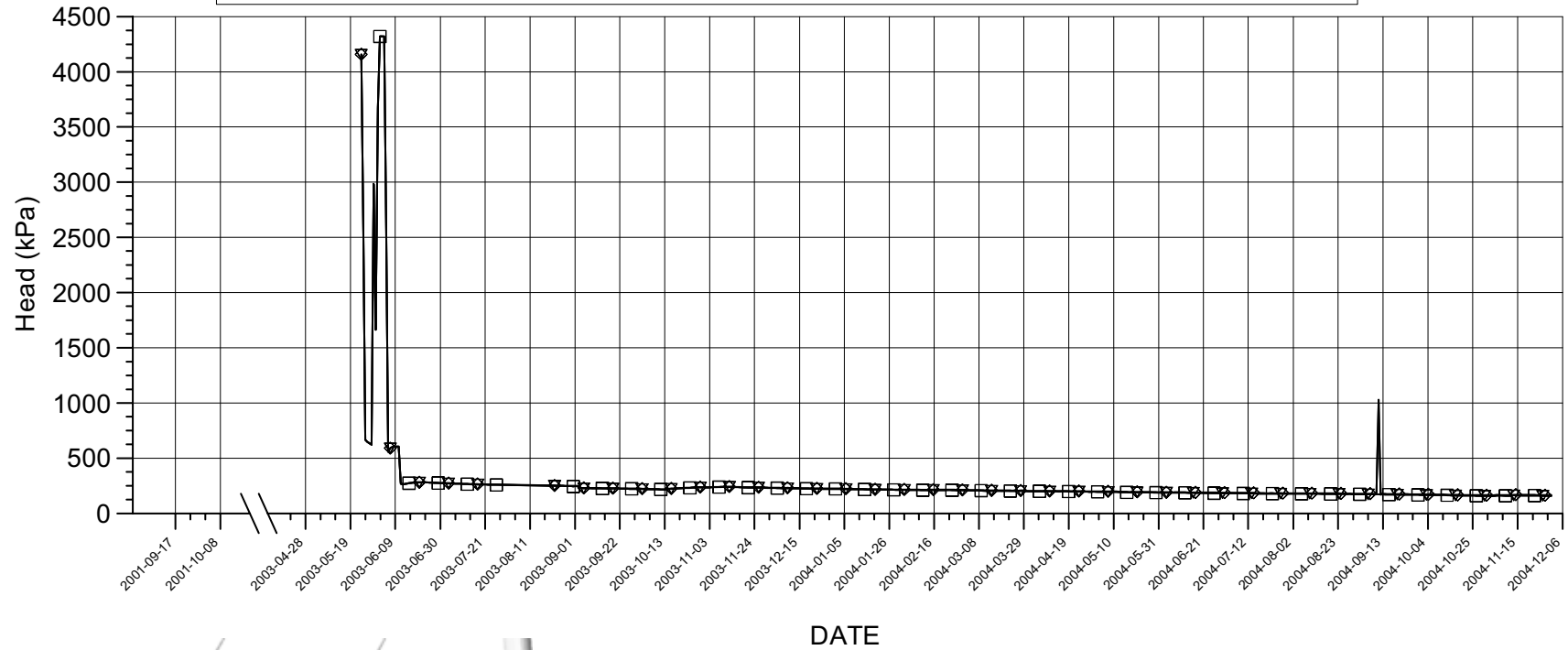

Events

- Start backfilling of section I 2001-09-03
- Stop backfilling of section I 2001-11-20
- Casting of inner plug finalized 2001-12-19
- Start backfilling of section II 2003-04-29
- Stop backfilling of section II 2003-06-27
- Casting of outer plug finalized 2003-09-11

Borehole sections

- ▽ — ▽ KA3543A01:1 0.65 m - 2 m
- ◇ — ◇ KA3543I01:1 0.65 m - 2 m
- — □ KA3548D01:1 0.65 m - 2 m

P_KA3543A01-P_KA3548D01.GRF 2004-12-01

KA3544G01 PRESSURE HEAD

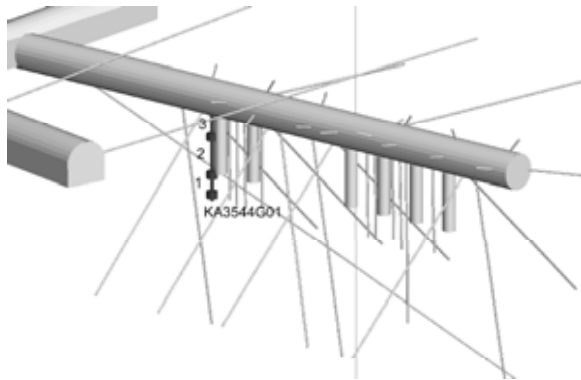
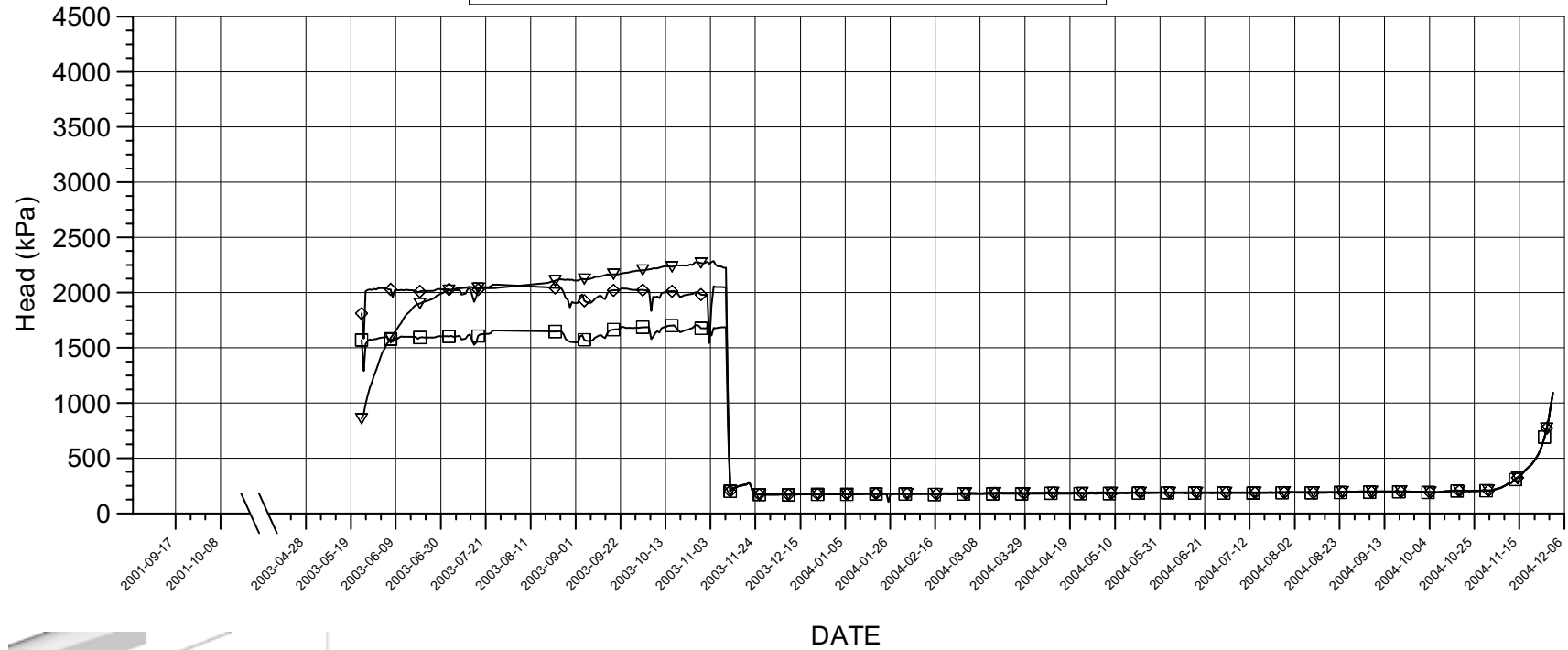

Events

- Start backfilling of section I 2001-09-03
- Stop backfilling of section I 2001-11-20
- Casting of inner plug finalized 2001-12-19
- Start backfilling of section II 2003-04-29
- Stop backfilling of section II 2003-06-27
- Casting of outer plug finalized 2003-09-11

Borehole sections

- ▽ — ▽ G01:1 11.65 m - 12 m
- ◇ — ◇ G01:2 8.9 m - 10.65 m
- — □ G01:3 3.5 m - 7.9 m

P_KA3544G01.GRF 2004-12-01

KA3546G01 PRESSURE HEAD

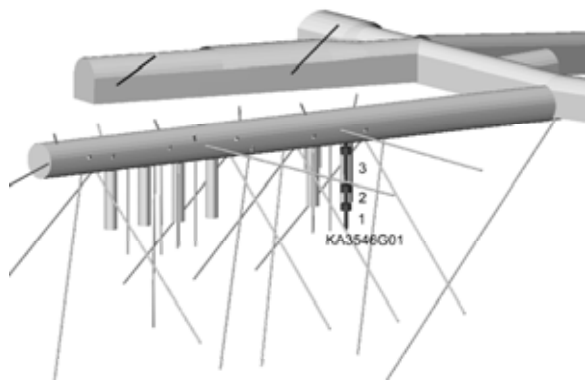
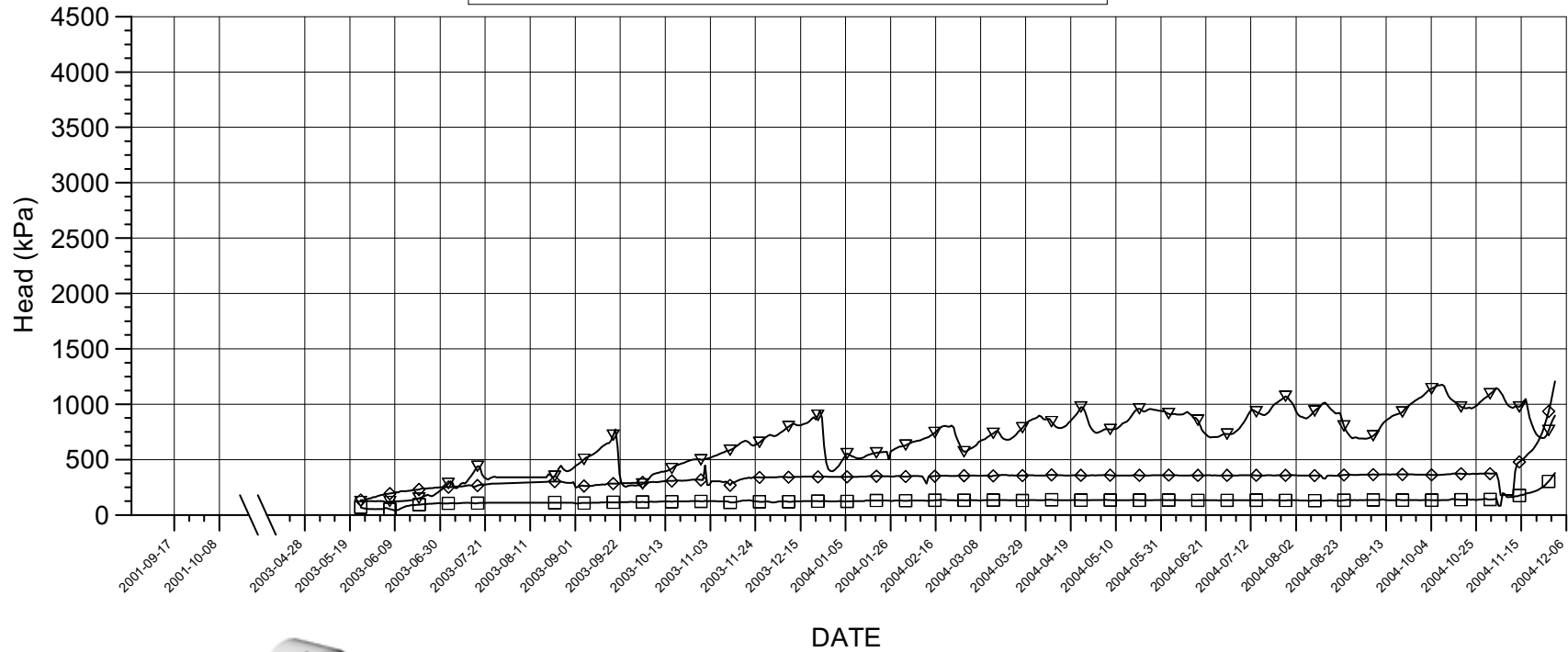

Events

- Start backfilling of section I 2001-09-03
- Stop backfilling of section I 2001-11-20
- Casting of inner plug finalized 2001-12-19
- Start backfilling of section II 2003-04-29
- Stop backfilling of section II 2003-06-27
- Casting of outer plug finalized 2003-09-11

Borehole sections

- ▽ G01:1 9.3 m - 12 m
- ◇ G01:2 6.75 m - 8.3 m
- G01:3 1.5 m - 5.75 m

KA3548A01 PRESSURE HEAD

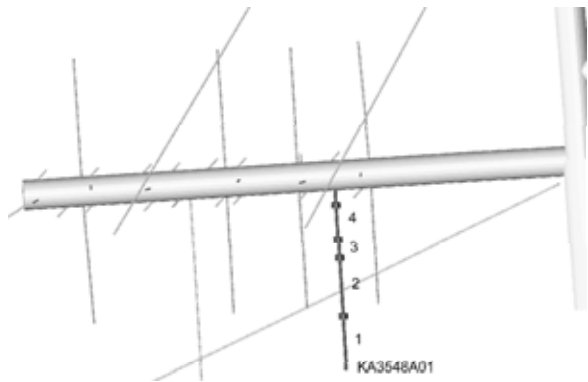
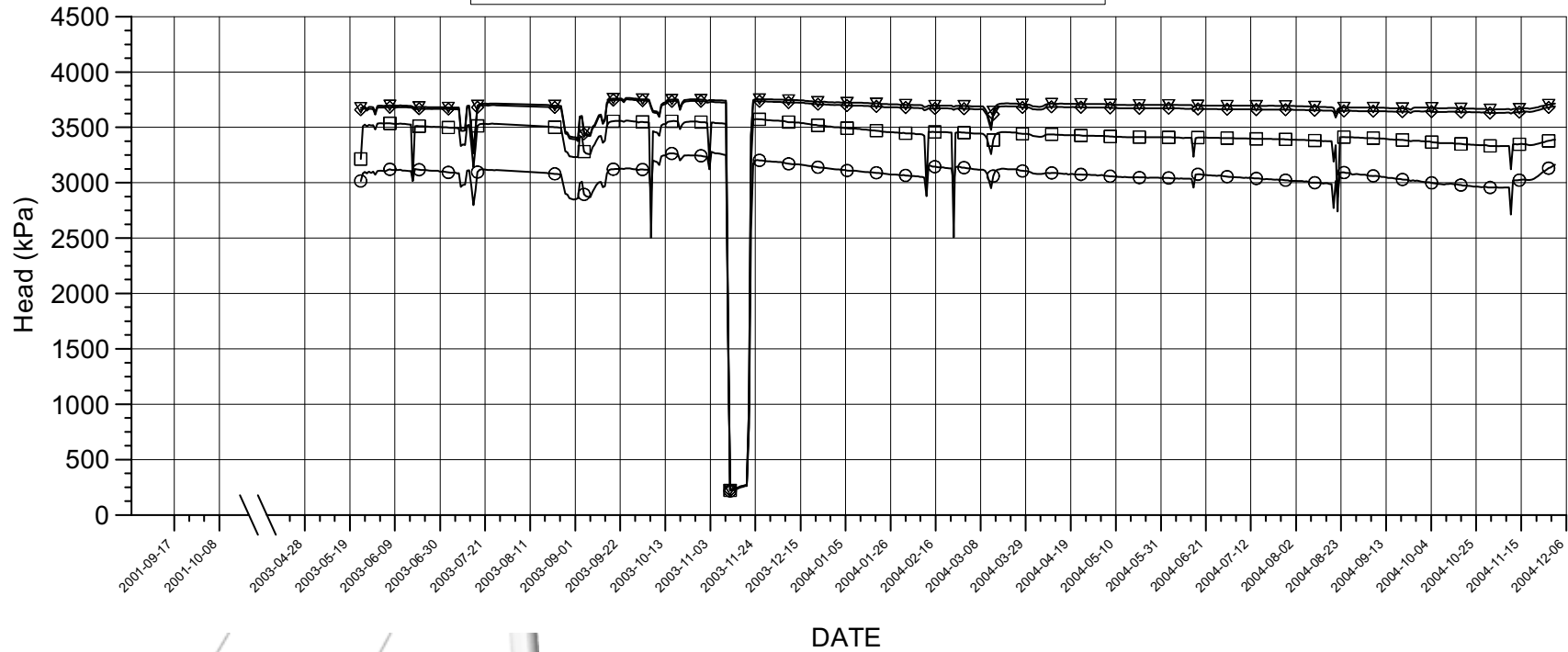

Events

- Start backfilling of section I 2001-09-03
- Stop backfilling of section I 2001-11-20
- Casting of inner plug finalized 2001-12-19
- Start backfilling of section II 2003-04-29
- Stop backfilling of section II 2003-06-27
- Casting of outer plug finalized 2003-09-11

Borehole sections

- ▽ A01:1 21.5 m - 30 m
- ◇ A01:2 11.75 m - 20.5 m
- A01:3 8.8 m - 10.75 m
- A01:4 3 m - 7.8 m

P_KA3548A01.GRF 2004-12-01

KA3548G01 PRESSURE HEAD

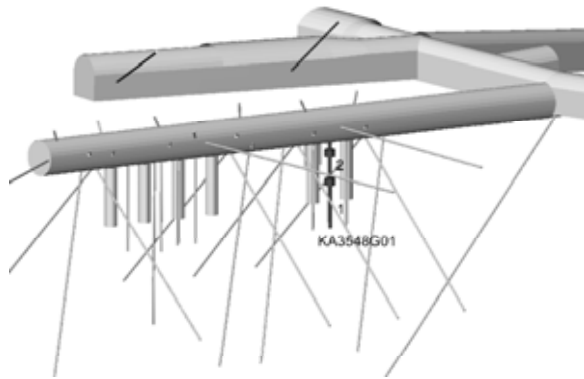
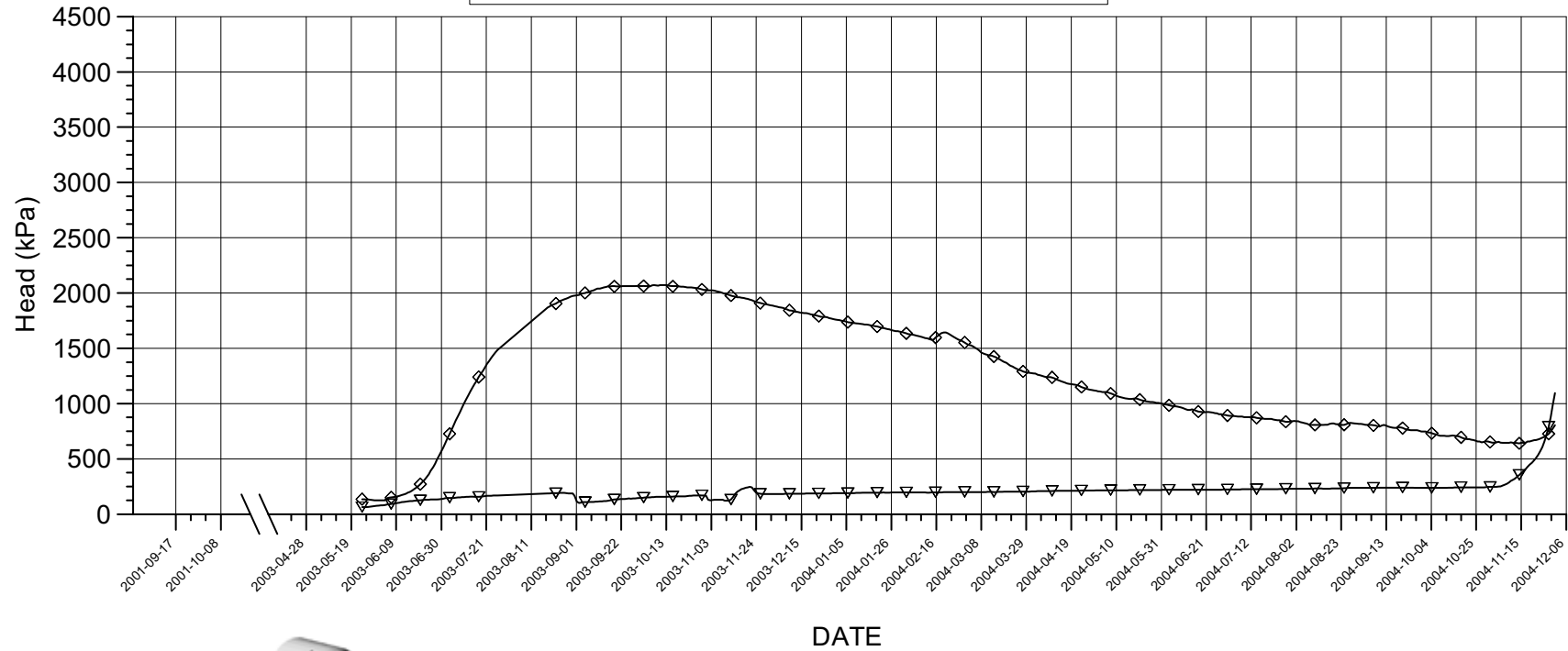

Events

- Start backfilling of section I 2001-09-03
- Stop backfilling of section I 2001-11-20
- Casting of inner plug finalized 2001-12-19
- Start backfilling of section II 2003-04-29
- Stop backfilling of section II 2003-06-27
- Casting of outer plug finalized 2003-09-11

Borehole sections

- ▽ G01:1 6 m - 12 m
- ◇ G01:2 2 m - 5 m

P_KA3548G01.GRF 2004-12-01

KA3550G01 PRESSURE HEAD

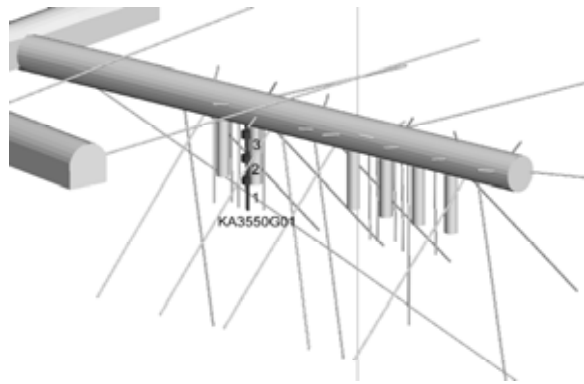
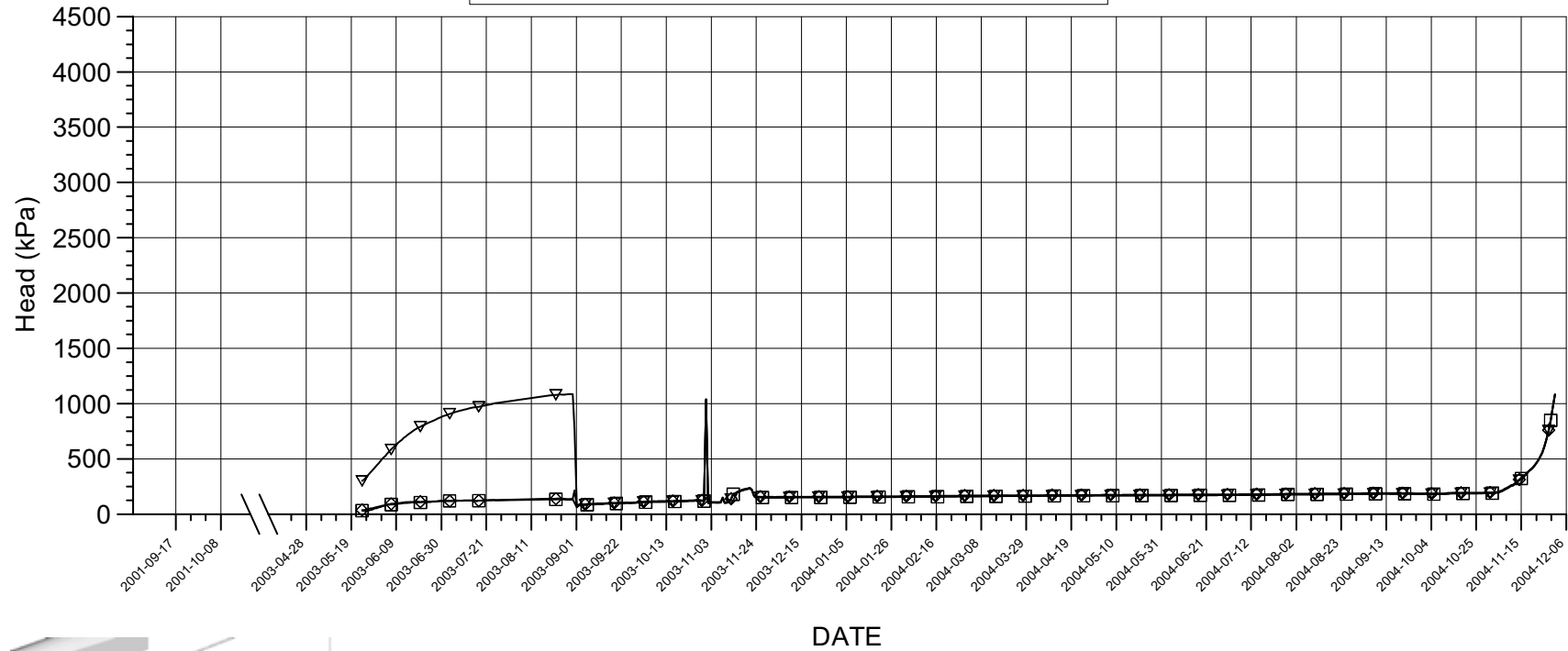

Events

- Start backfilling of section I 2001-09-03
- Stop backfilling of section I 2001-11-20
- Casting of inner plug finalized 2001-12-19
- Start backfilling of section II 2003-04-29
- Stop backfilling of section II 2003-06-27
- Casting of outer plug finalized 2003-09-11

Borehole sections

- ▽ G01:1 8.3 m - 12.03 m
- ◇ G01:2 5.2 m - 7.3 m
- G01:3 1.8 m - 4.2 m

P_KA3550G01.GRF 2004-12-01

KA3550G05, KA3551G05 PRESSURE HEAD

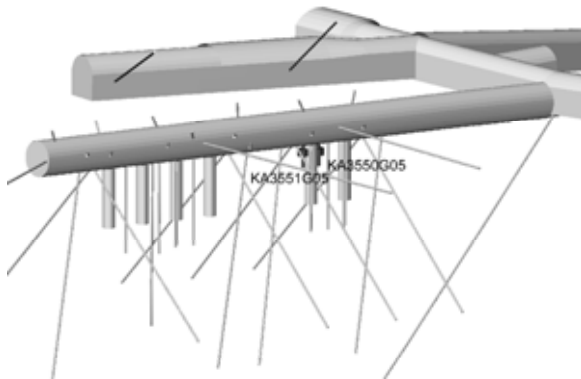
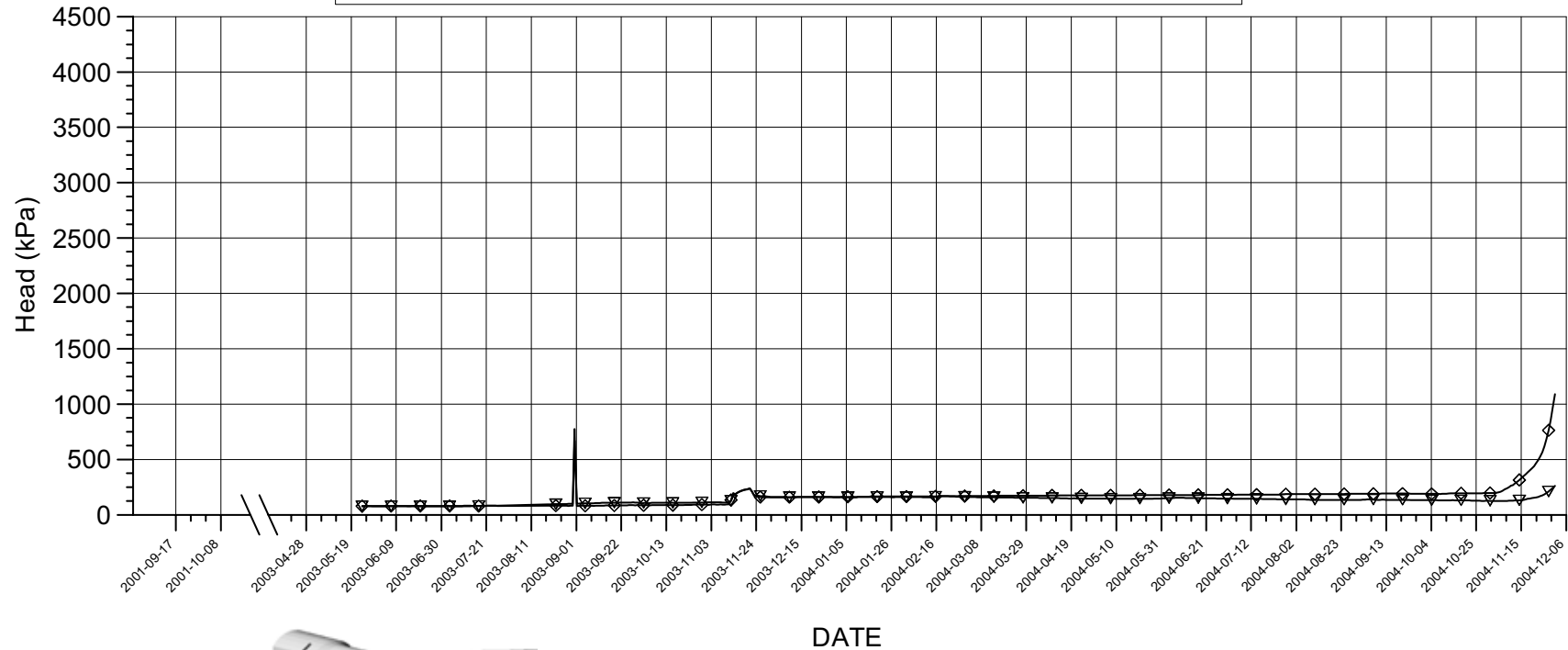

Events

Start backfilling of section I 2001-09-03
 Stop backfilling of section I 2001-11-20
 Casting of inner plug finalized 2001-12-19
 Start backfilling of section II 2003-04-29
 Stop backfilling of section II 2003-06-27
 Casting of outer plug finalized 2003-09-11

Borehole sections

▼ KA3550G05:1 1.5 m - 3 m
 ◆ KA3551G05:1 1.5 m - 3.1 m

KA3552A01, KA3552H01, KA3553B01 PRESSURE HEAD

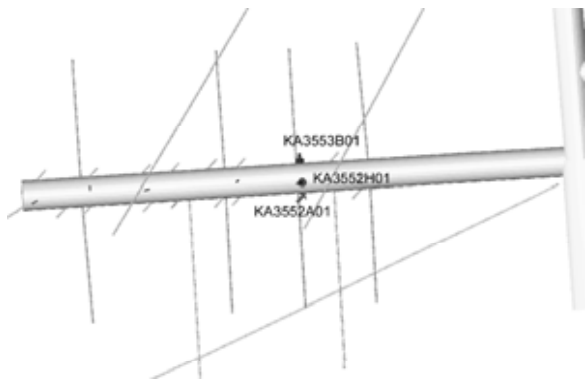
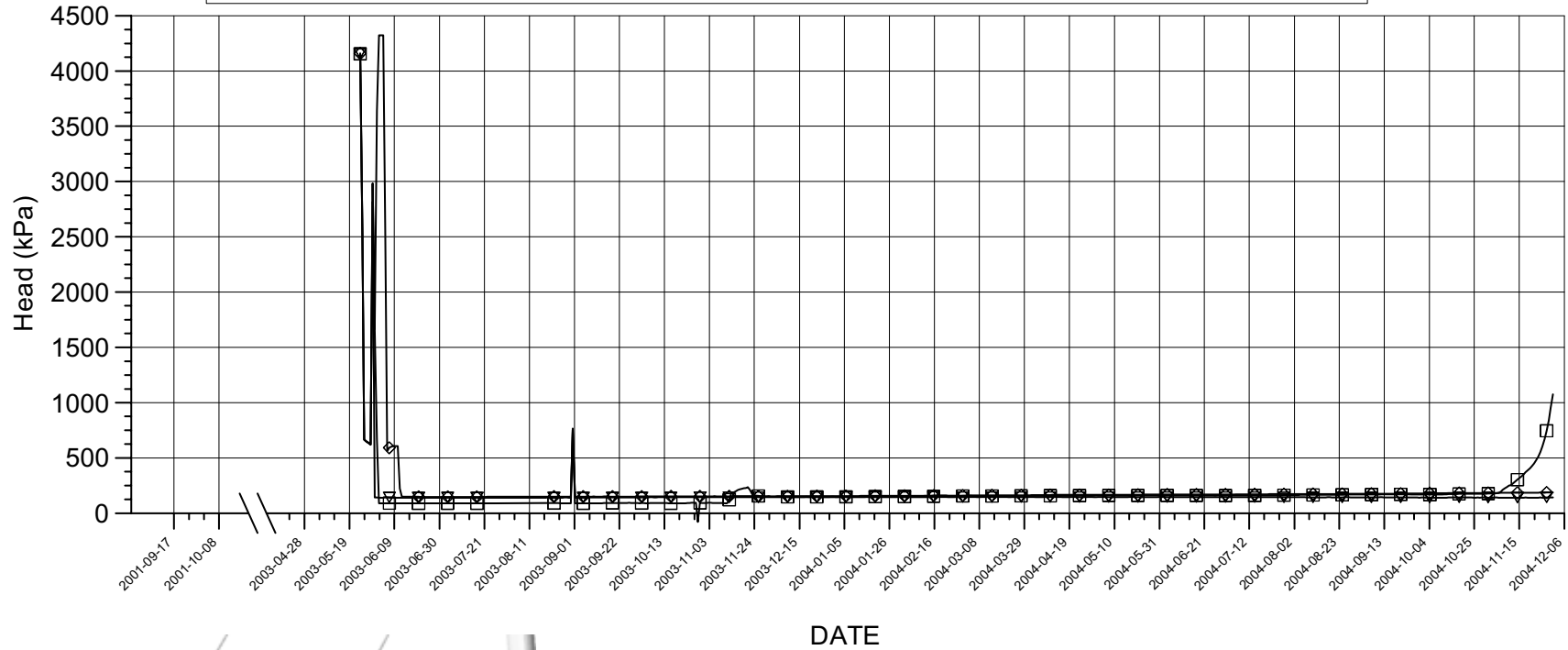

Events

- Start backfilling of section I 2001-09-03
- Stop backfilling of section I 2001-11-20
- Casting of inner plug finalized 2001-12-19
- Start backfilling of section II 2003-04-29
- Stop backfilling of section II 2003-06-27
- Casting of outer plug finalized 2003-09-11

Borehole sections

- ▽ KA3552A01:1 0.65 m - 2 m
- ◇ KA3552H01:1 0.65 m - 2 m
- KA3553B01:1 0.65 m - 2 m

KA3552G01 PRESSURE HEAD

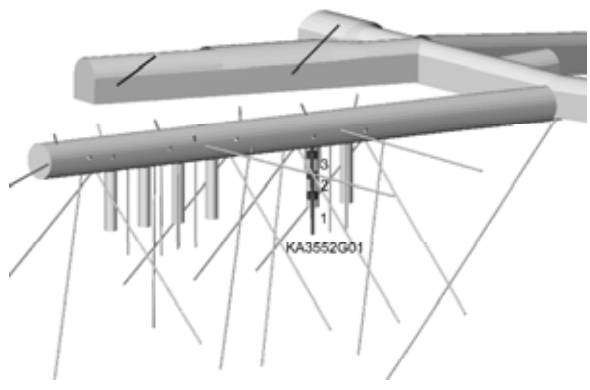
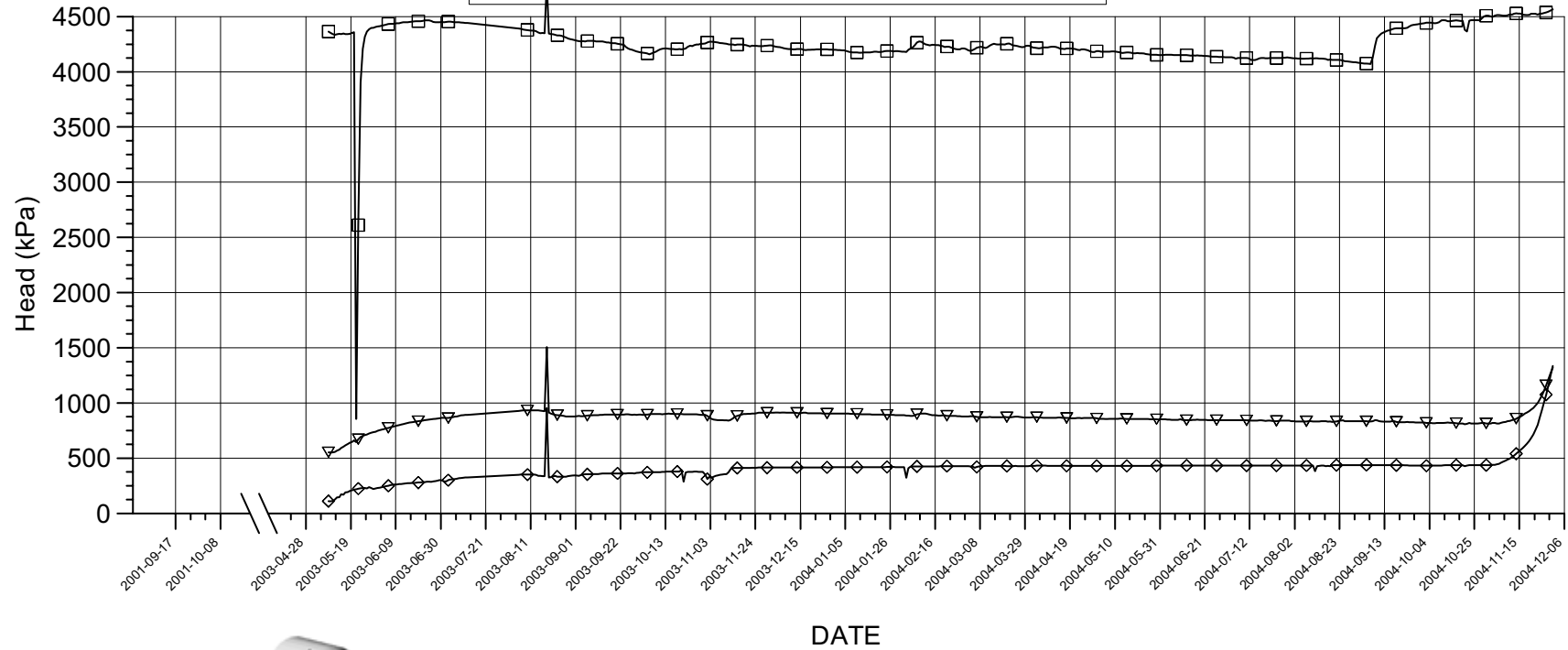

Events

- Start backfilling of section I 2001-09-03
- Stop backfilling of section I 2001-11-20
- Casting of inner plug finalized 2001-12-19
- Start backfilling of section II 2003-04-29
- Stop backfilling of section II 2003-06-27
- Casting of outer plug finalized 2003-09-11

Borehole sections

- ▽ — ▽ G01:1 7.05 m - 12 m
- ◇ — ◇ G01:2 4.35 m - 6.05 m
- — □ G01:3 1.5 m - 3.35 m

KA3554G01 PRESSURE HEAD

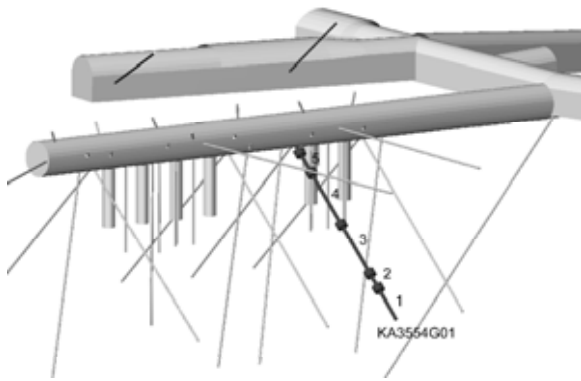
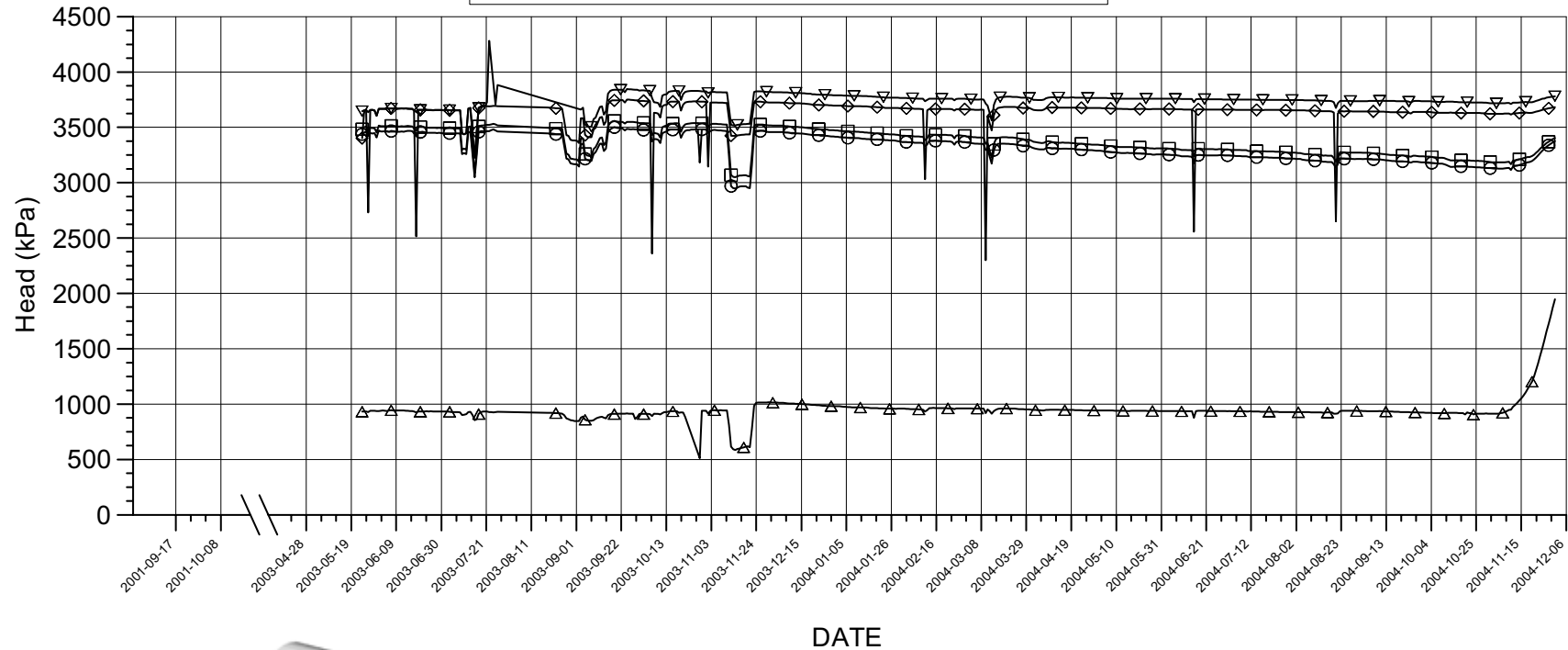

Events

- Start backfilling of section I 2001-09-03
- Stop backfilling of section I 2001-11-20
- Casting of inner plug finalized 2001-12-19
- Start backfilling of section II 2003-04-29
- Stop backfilling of section II 2003-06-27
- Casting of outer plug finalized 2003-09-11

Borehole sections

- ▽ G01:1 25.15 m - 30.01 m
- ◇ G01:2 22.6 m - 24.15 m
- G01:3 14 m - 21.6 m
- G01:4 5 m - 13 m
- △ G01:5 1.5 m - 4 m

P_KA3554G01.GRF 2004-12-01

KA3554G02 PRESSURE HEAD

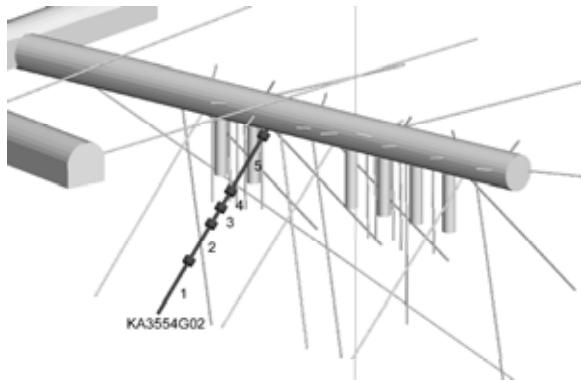
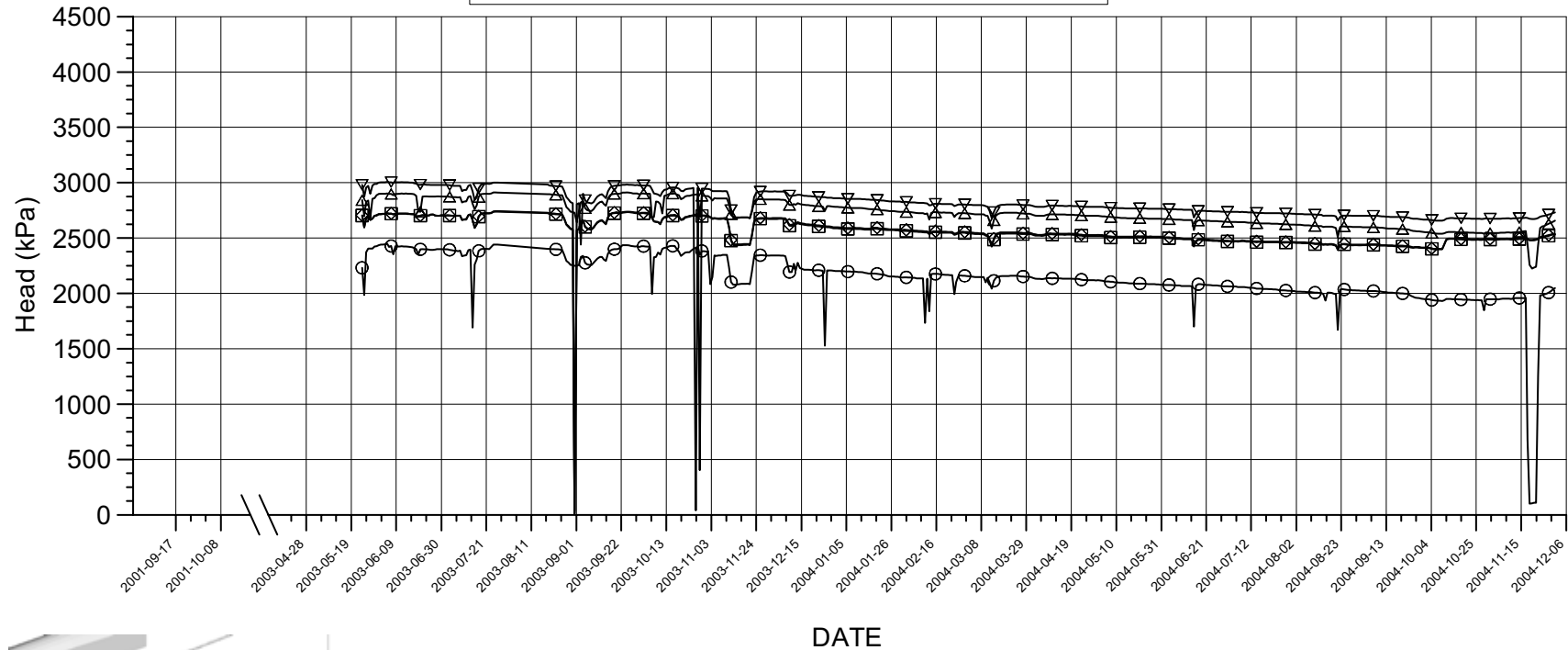

Events

Start backfilling of section I 2001-09-03
 Stop backfilling of section I 2001-11-20
 Casting of inner plug finalized 2001-12-19
 Start backfilling of section II 2003-04-29
 Stop backfilling of section II 2003-06-27
 Casting of outer plug finalized 2003-09-11

Borehole sections

▽ — ▽ G02:1 22 m - 30.01 m
 ◇ — ◇ G02:2 15.9 m - 21 m
 ◻ — ◻ G02:3 13.2 m - 14.9 m
 ○ — ○ G02:4 10.5 m - 12.2 m
 ▲ — ▲ G02:5 1.5 m - 9.5 m

P_KA3554G02.GRF 2004-12-01

KA3557G PRESSURE HEAD

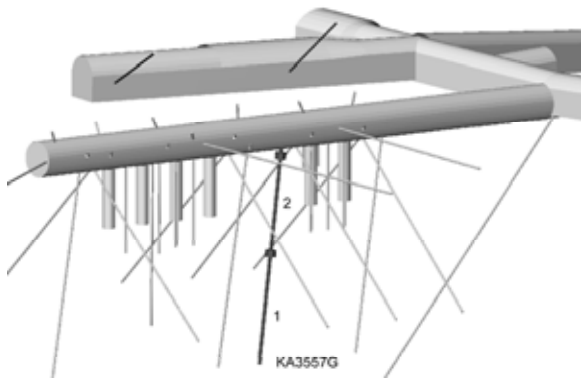
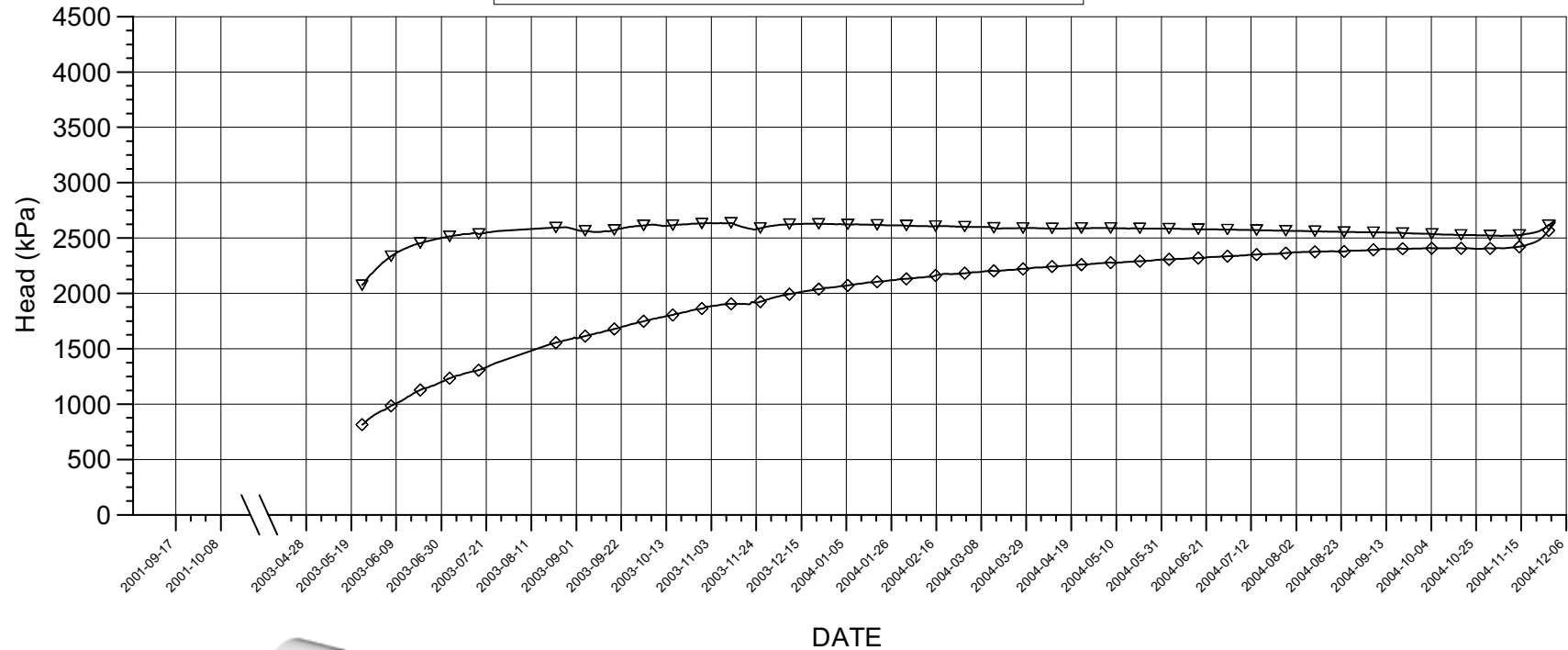

Events

- Start backfilling of section I 2001-09-03
- Stop backfilling of section I 2001-11-20
- Casting of inner plug finalized 2001-12-19
- Start backfilling of section II 2003-04-29
- Stop backfilling of section II 2003-06-27
- Casting of outer plug finalized 2003-09-11

Borehole sections

- ▽ G:1 15 m - 30.04 m
- ◇ G:2 1.5 m - 14 m

P_KA3557G.GRF 2004-12-01

KA3563G PRESSURE HEAD

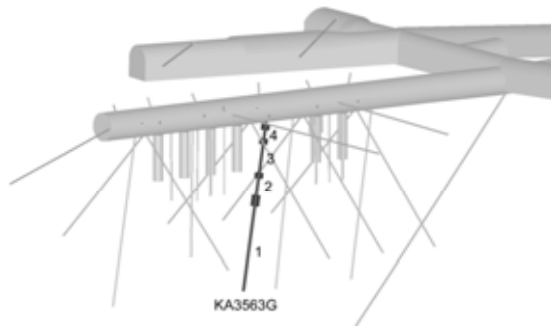
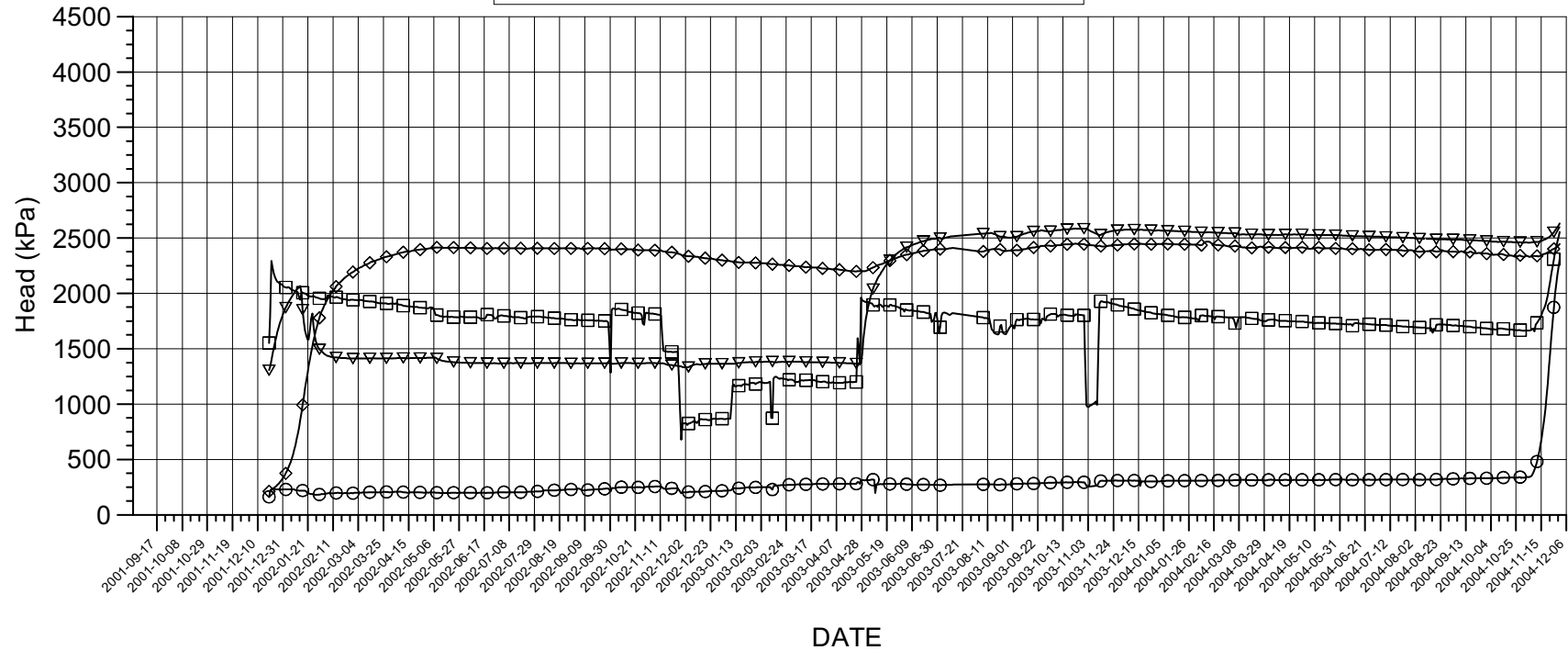

Events

- Start backfilling of section I 2001-09-03
- Stop backfilling of section I 2001-11-20
- Casting of inner plug finalized 2001-12-19
- Start backfilling of section II 2003-04-29
- Stop backfilling of section II 2003-06-27
- Casting of outer plug finalized 2003-09-11

Borehole sections

- ▽ — ▽ G:1 15 m - 30 m
- ◇ — ◇ G:2 10 m - 13 m
- — □ G:3 4 m - 8 m
- — ○ G:4 1.5 m - 3 m

P_KA3563G.GRF 2004-12-01

KA3563A01, KA3563D01, KA3563I01 PRESSURE HEAD

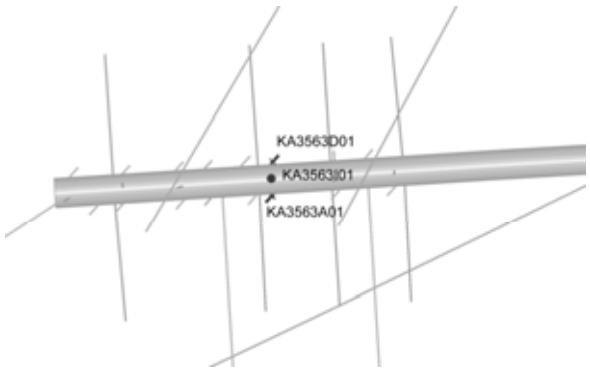
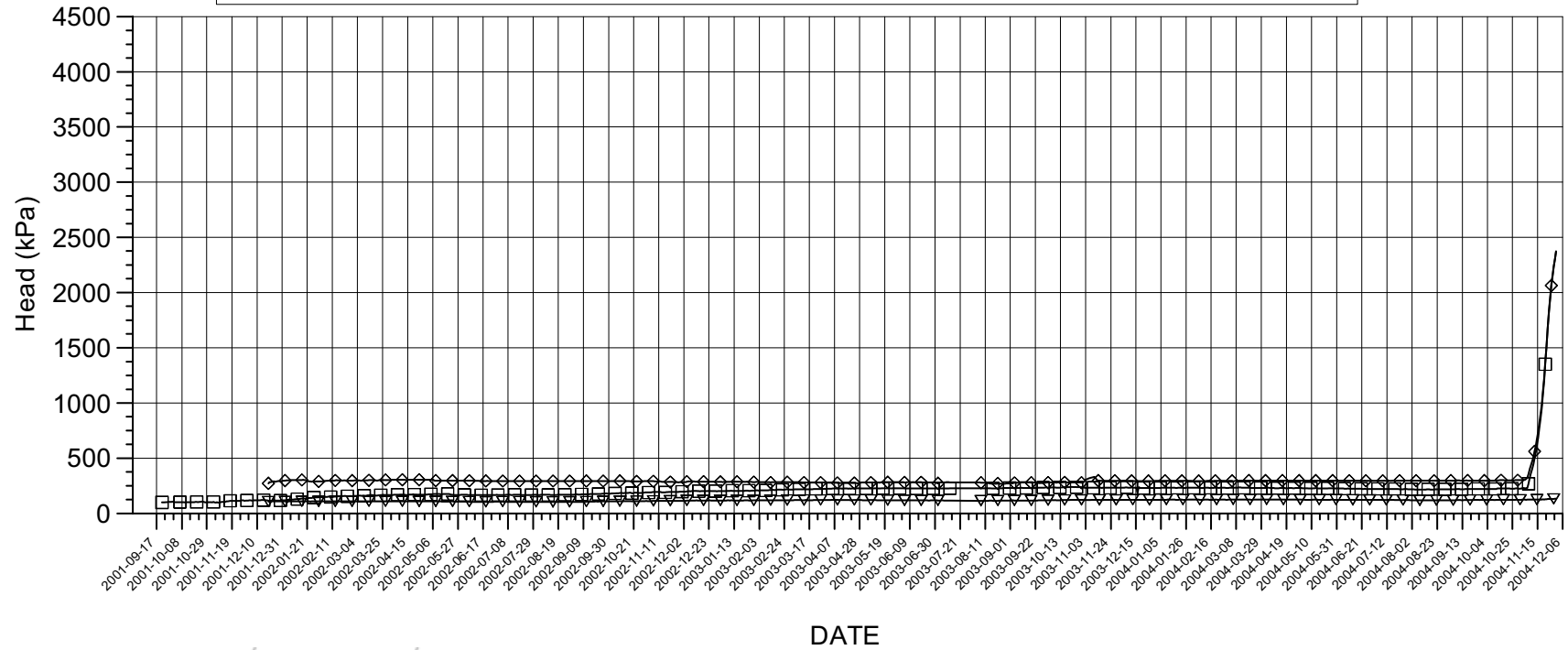

Events

- Start backfilling of section I 2001-09-03
- Stop backfilling of section I 2001-11-20
- Casting of inner plug finalized 2001-12-19
- Start backfilling of section II 2003-04-29
- Stop backfilling of section II 2003-06-27
- Casting of outer plug finalized 2003-09-11

Borehole sections

- ▽ KA3563A01:1 0.65 m - 2 m
- ◇ KA3563D01:1 0.65 m - 2 m
- KA3563I01:1 0.65 m - 2 m

KA3566G01 PRESSURE HEAD

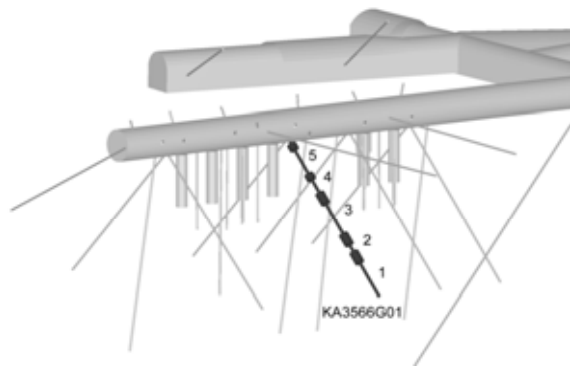
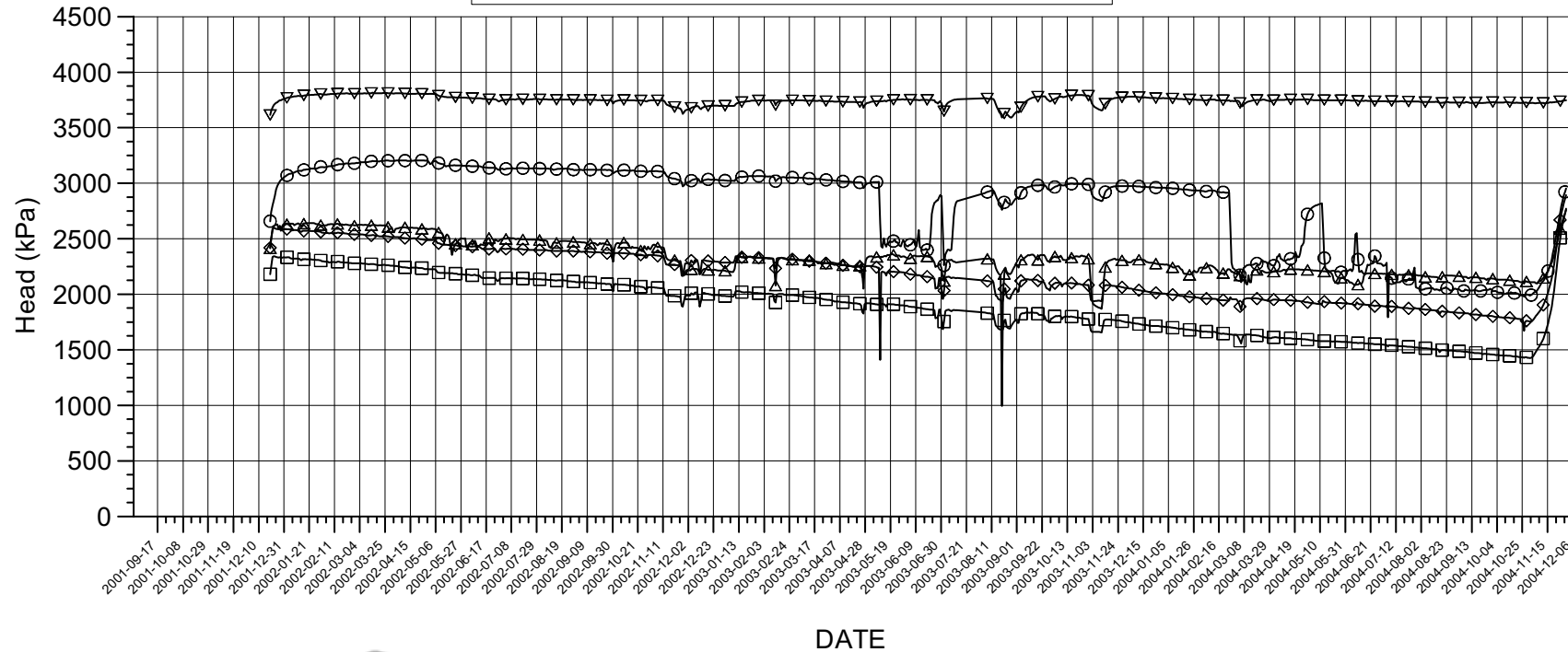

Events

- Start backfilling of section I 2001-09-03
- Stop backfilling of section I 2001-11-20
- Casting of inner plug finalized 2001-12-19
- Start backfilling of section II 2003-04-29
- Stop backfilling of section II 2003-06-27
- Casting of outer plug finalized 2003-09-11

Borehole sections

- ▽ — ▽ G01:1 23.5 m - 30 m
- ◇ — ◇ G01:2 20 m - 21.5 m
- — □ G01:3 12 m - 18 m
- — ○ G01:4 7.3 m - 10 m
- △ — △ G01:5 1.5 m - 6.3 m

P_KA3566G01.GRF 2004-12-01

KA3566G02 PRESSURE HEAD

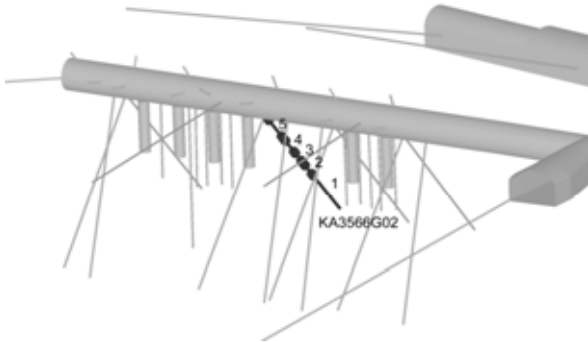
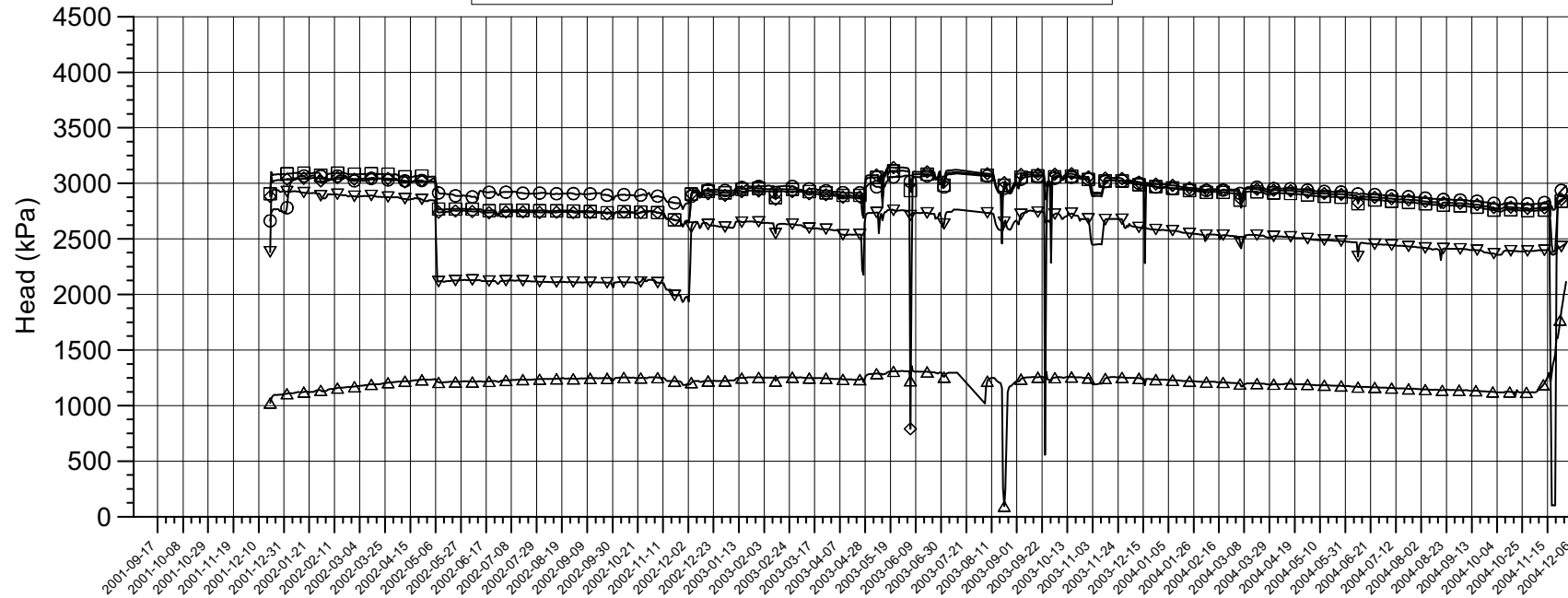

Events

- Start backfilling of section I 2001-09-03
- Stop backfilling of section I 2001-11-20
- Casting of inner plug finalized 2001-12-19
- Start backfilling of section II 2003-04-29
- Stop backfilling of section II 2003-06-27
- Casting of outer plug finalized 2003-09-11

Borehole sections

- ▽ — ▽ G02:1 19 m - 30 m
- ◇ — ◇ G02:2 16 m - 18 m
- — □ G02:3 12 m - 14 m
- — ○ G02:4 8 m - 11 m
- △ — △ G02:5 1.5 m - 6 m

KA3566C01, KA3568D01, KA3573C01, KA3574D01 PRESSURE HEAD

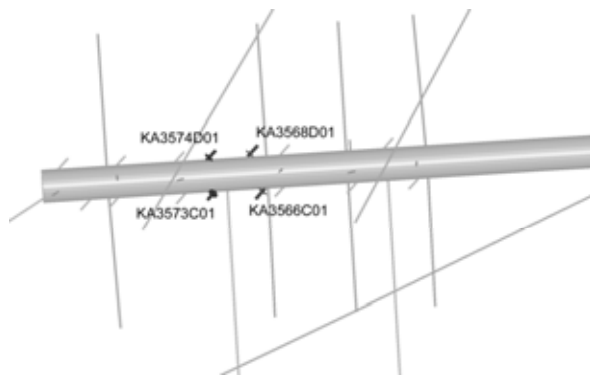
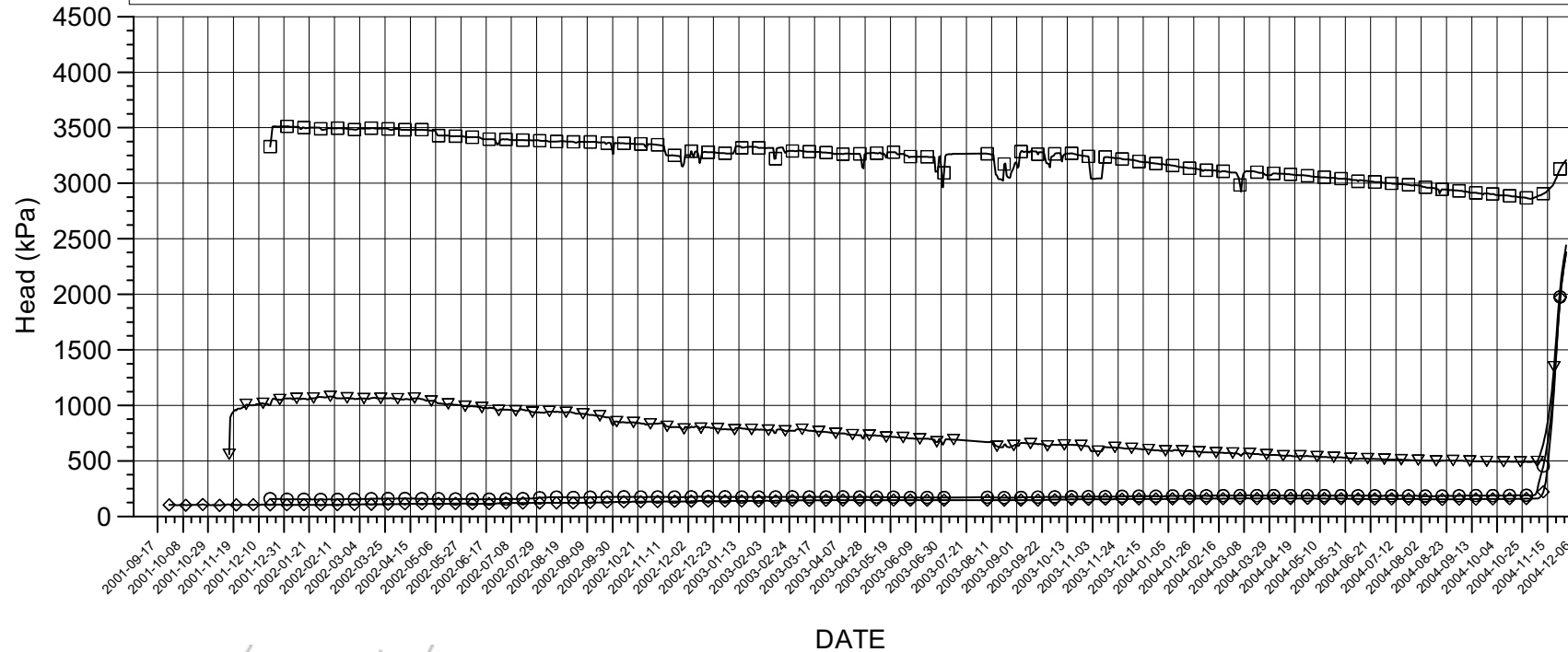

Events

- Start backfilling of section I 2001-09-03
- Stop backfilling of section I 2001-11-20
- Casting of inner plug finalized 2001-12-19
- Start backfilling of section II 2003-04-29
- Stop backfilling of section II 2003-06-27
- Casting of outer plug finalized 2003-09-11

Borehole sections

- ▽—▽ KA3566C01:1 0.65 m - 2 m
- ◇—◇ KA3568D01:1 0.65 m - 2 m
- KA3573C01:1 0.65 m - 2 m
- KA3574D01:1 0.65 m - 2 m

KA3572G01 PRESSURE HEAD

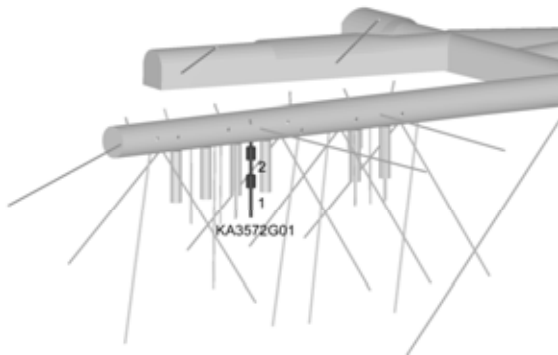
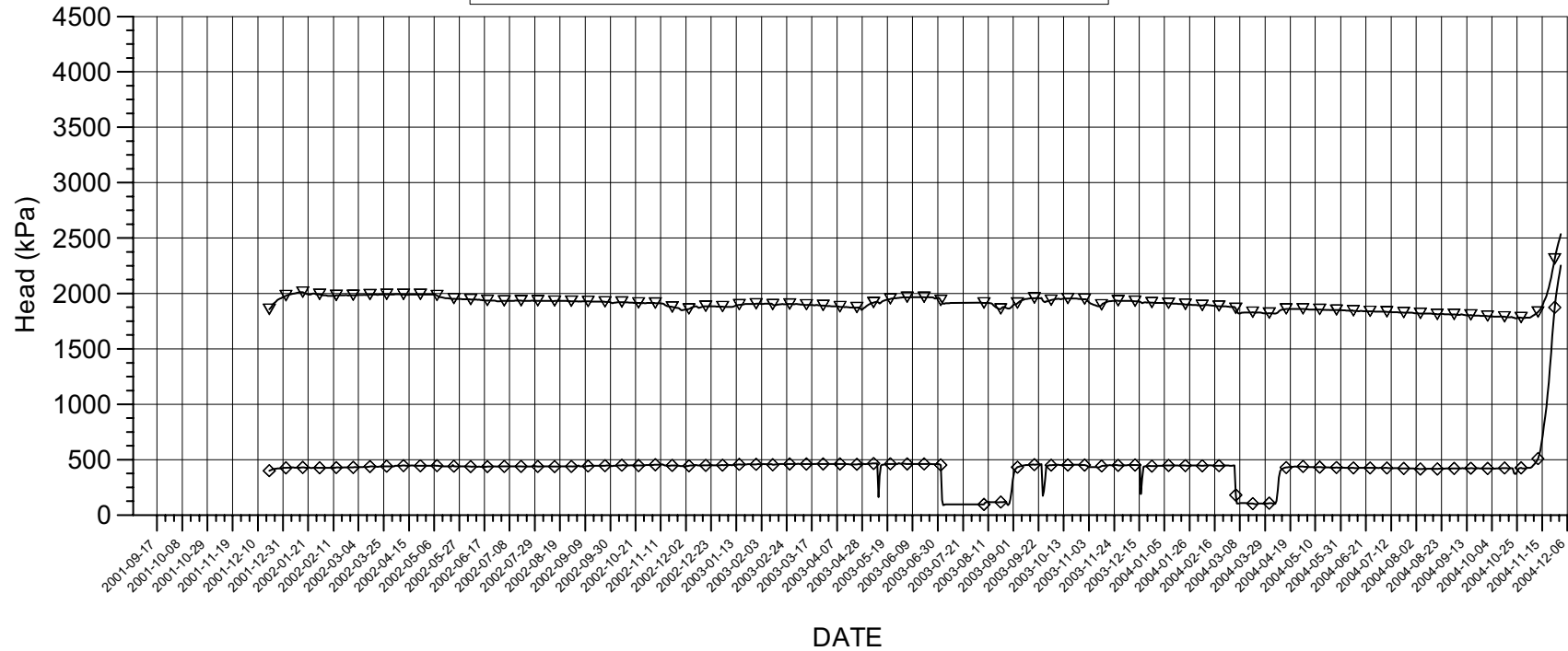

Events

- Start backfilling of section I 2001-09-03
- Stop backfilling of section I 2001-11-20
- Casting of inner plug finalized 2001-12-19
- Start backfilling of section II 2003-04-29
- Stop backfilling of section II 2003-06-27
- Casting of outer plug finalized 2003-09-11

Borehole sections

- ▽ G01:1 7.3 m - 12.0 m
- ◇ G01:2 2.7 m - 5.3 m

P_KA3572G01.GRF 2004-12-01

KA3573A PRESSURE HEAD

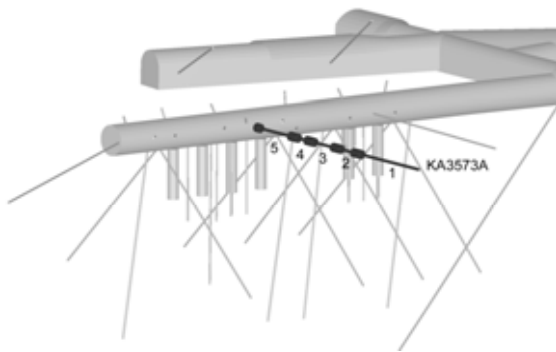
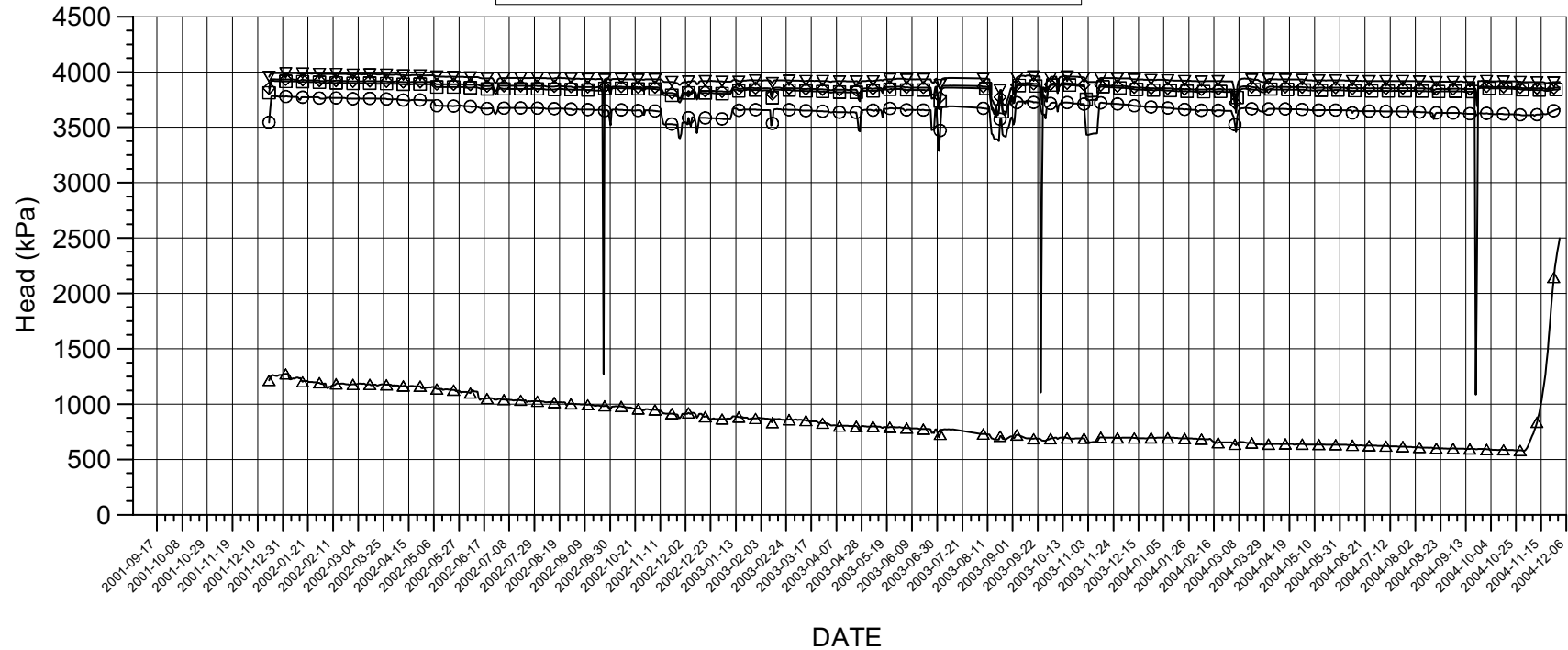

Events

- Start backfilling of section I 2001-09-03
- Stop backfilling of section I 2001-11-20
- Casting of inner plug finalized 2001-12-19
- Start backfilling of section II 2003-04-29
- Stop backfilling of section II 2003-06-27
- Casting of outer plug finalized 2003-09-11

Borehole sections

- ▽ — ▽ A:1 26 m - 40.1 m
- ◇ — ◇ A:2 21 m - 24 m
- ◻ — ◻ A:3 14.5 m - 19 m
- ⊖ — ⊖ A:4 10.5 m - 12.5 m
- △ — △ A:5 3.4 m - 8.5 m

P_KA3573A.GRF 2004-12-01

KA3574G01 PRESSURE HEAD

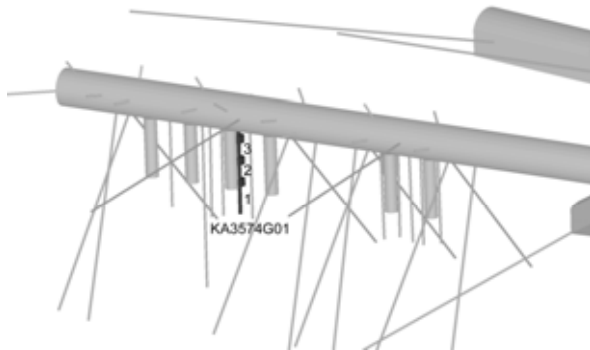
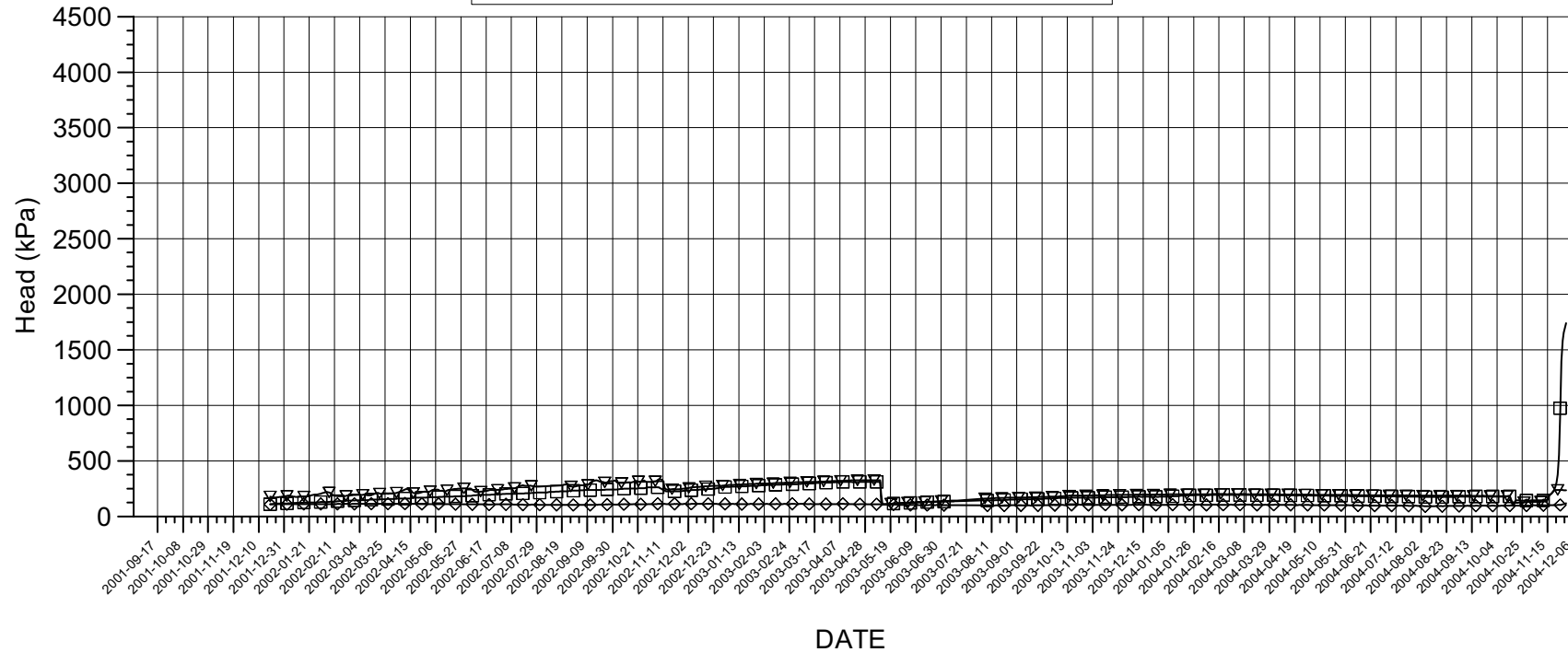

Events

- Start backfilling of section I 2001-09-03
- Stop backfilling of section I 2001-11-20
- Casting of inner plug finalized 2001-12-19
- Start backfilling of section II 2003-04-29
- Stop backfilling of section II 2003-06-27
- Casting of outer plug finalized 2003-09-11

Borehole sections

- ▽ — ▽ G01:1 8 m - 12 m
- ◇ — ◇ G01:2 5.1 m - 7 m
- — □ G01:3 1.8 m - 4.1 m

P_KA3574G01.GRF 2004-12-01

KA3576G01 PRESSURE HEAD

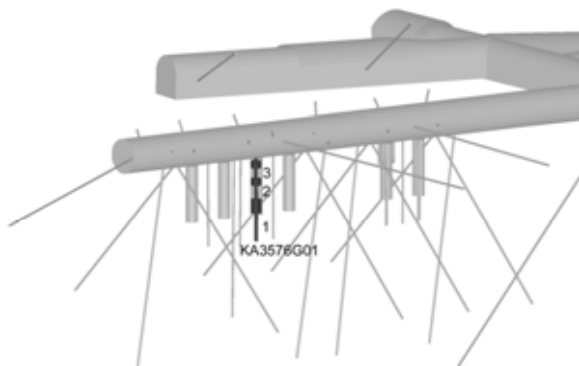
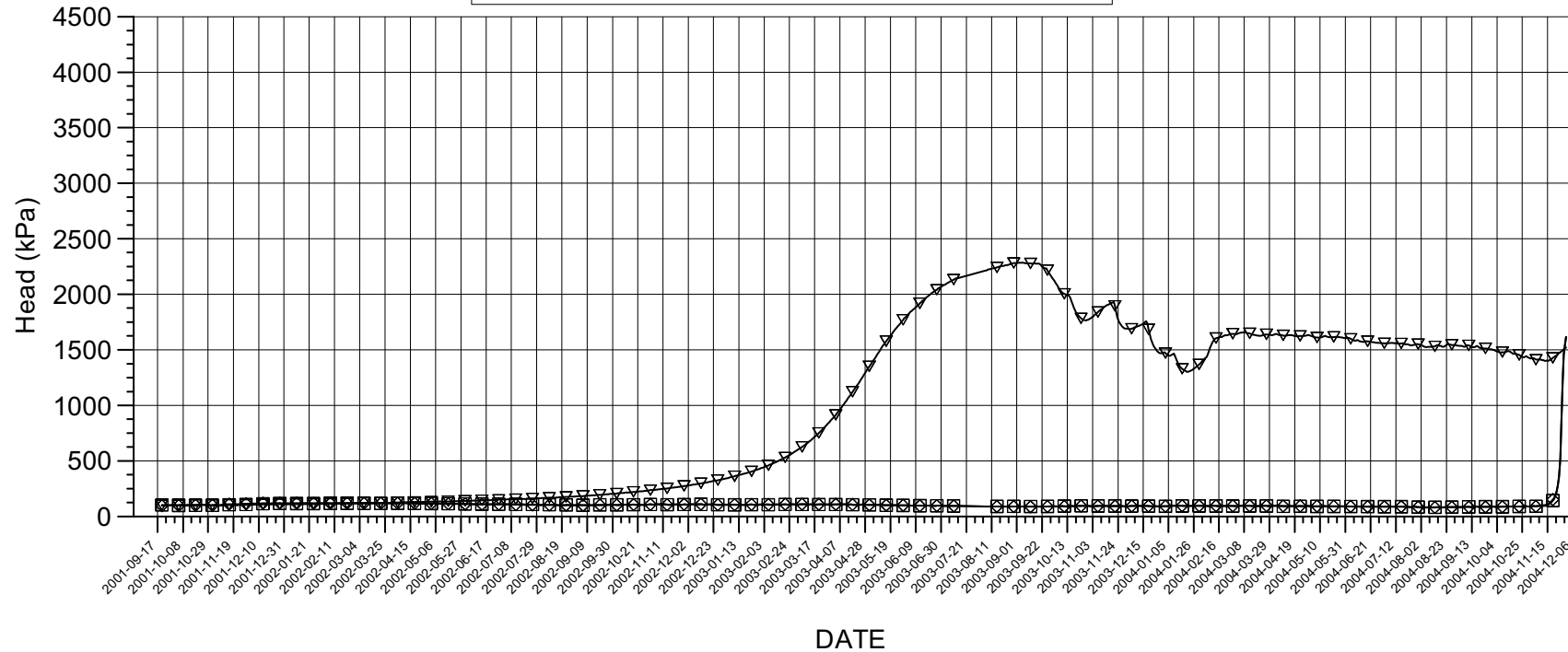

Events

- Start backfilling of section I 2001-09-03
- Stop backfilling of section I 2001-11-20
- Casting of inner plug finalized 2001-12-19
- Start backfilling of section II 2003-04-29
- Stop backfilling of section II 2003-06-27
- Casting of outer plug finalized 2003-09-11

Borehole sections

- ▽ G01:1 7.9 m - 12 m
- ◇ G01:2 3.9 m - 5.9 m
- G01:3 1.4 m - 2.9 m

KA3578G01 PRESSURE HEAD

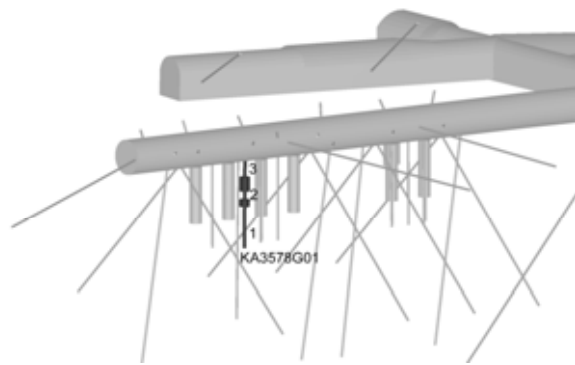
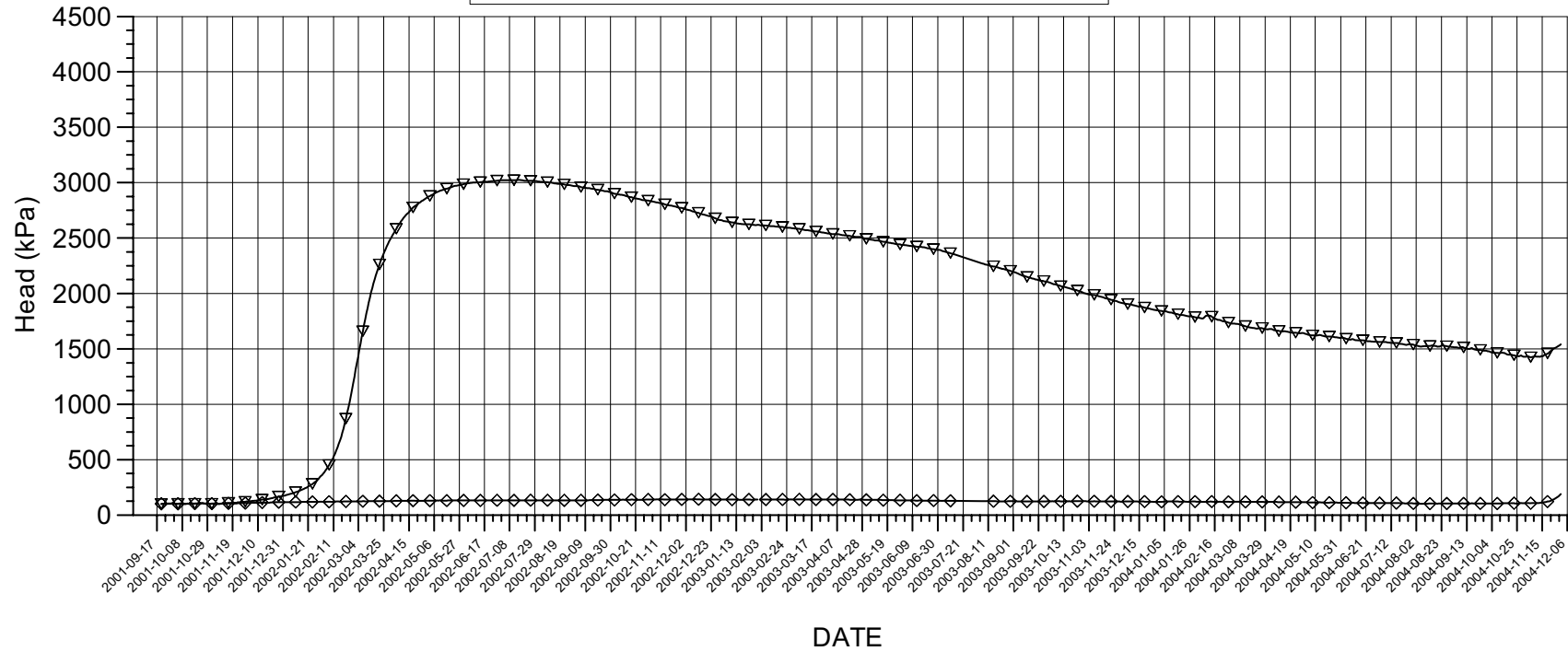

Events

- Start backfilling of section I 2001-09-03
- Stop backfilling of section I 2001-11-20
- Casting of inner plug finalized 2001-12-19
- Start backfilling of section II 2003-04-29
- Stop backfilling of section II 2003-06-27
- Casting of outer plug finalized 2003-09-11

Borehole sections

- ▽ — ▽ G01:1 6.5 m - 12.6 m
- ◇ — ◇ G01:2 4.3 m - 5.5 m

P_KA3578G01.GRF 2004-12-01

KA3578C01, KA3578H01, KA3579D01 PRESSURE HEAD

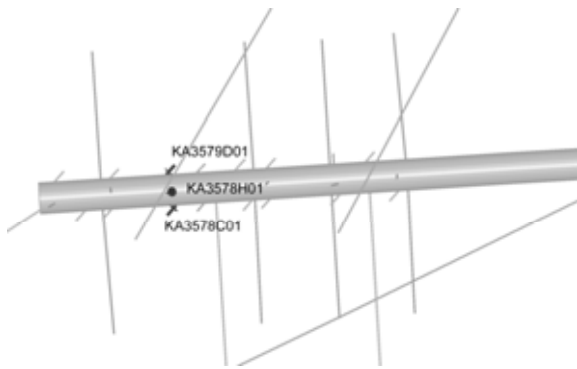
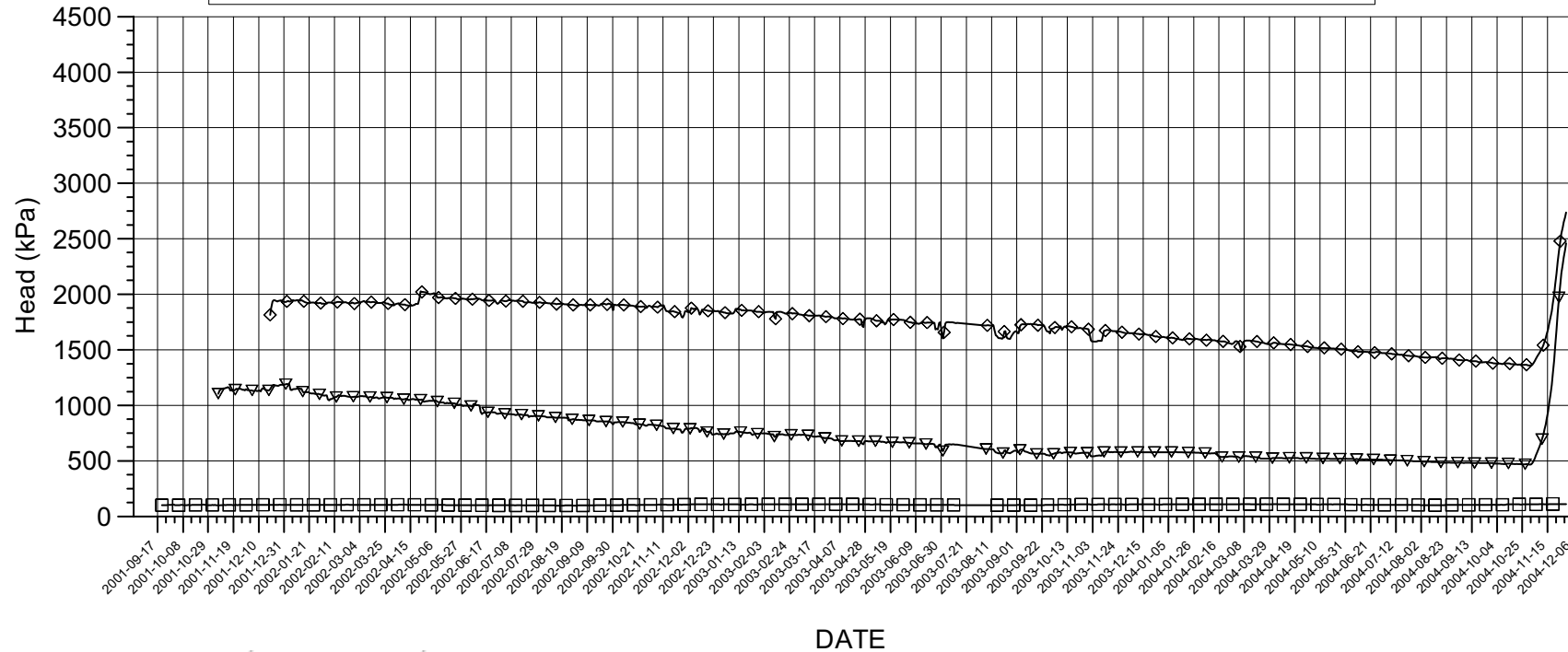

Events

- Start backfilling of section I 2001-09-03
- Stop backfilling of section I 2001-11-20
- Casting of inner plug finalized 2001-12-19
- Start backfilling of section II 2003-04-29
- Stop backfilling of section II 2003-06-27
- Casting of outer plug finalized 2003-09-11

Borehole sections

- ▽ KA3578C01:1 0.65 m - 2 m
- ◇ KA3578H01:1 0.65 m - 2 m
- KA3579D01:1 0.65 m - 2 m

KA3579G PRESSURE HEAD

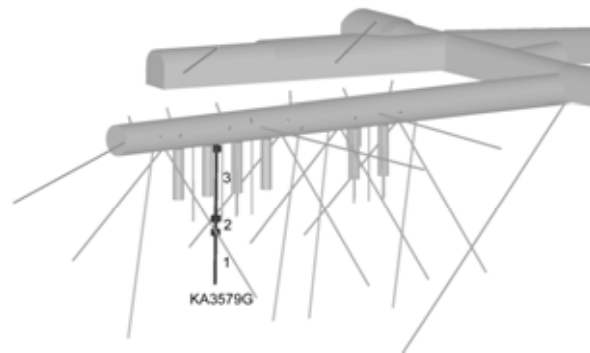
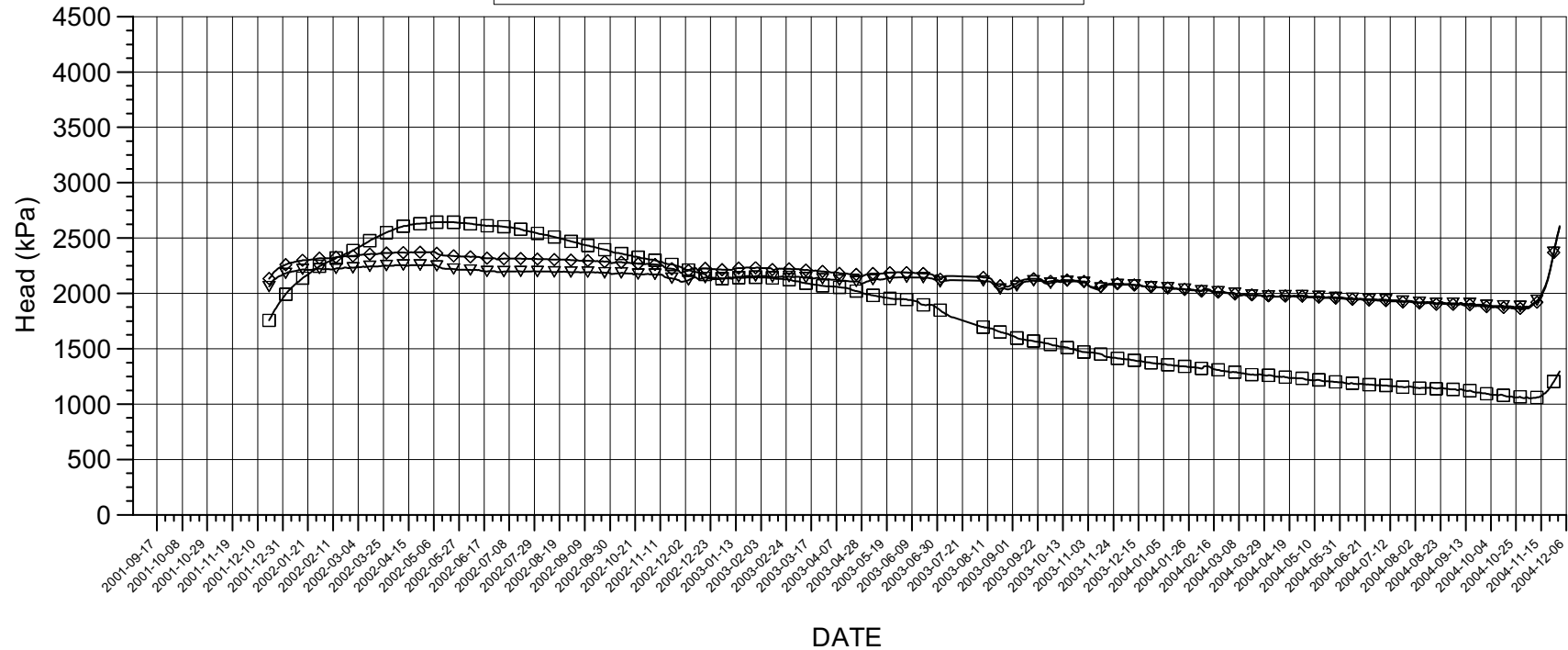

Events

Start backfilling of section I 2001-09-03
 Stop backfilling of section I 2001-11-20
 Casting of inner plug finalized 2001-12-19
 Start backfilling of section II 2003-04-29
 Stop backfilling of section II 2003-06-27
 Casting of outer plug finalized 2003-09-11

Borehole sections

▽———▽ G:1 14.7 m - 22.7 m
 ◇———◇ G:2 12.5 m - 13.7 m
 □———□ G:3 2.5 m - 11.5 m

P_KA3579G.GRF 2004-12-01

KA3584G01 PRESSURE HEAD

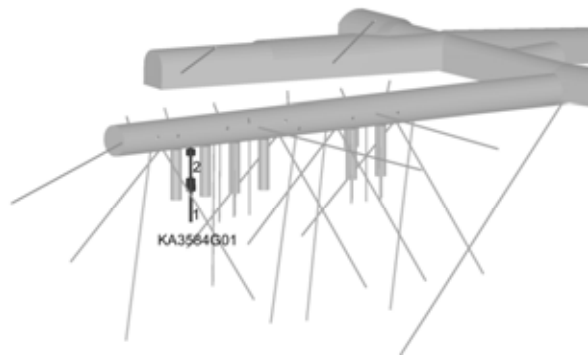
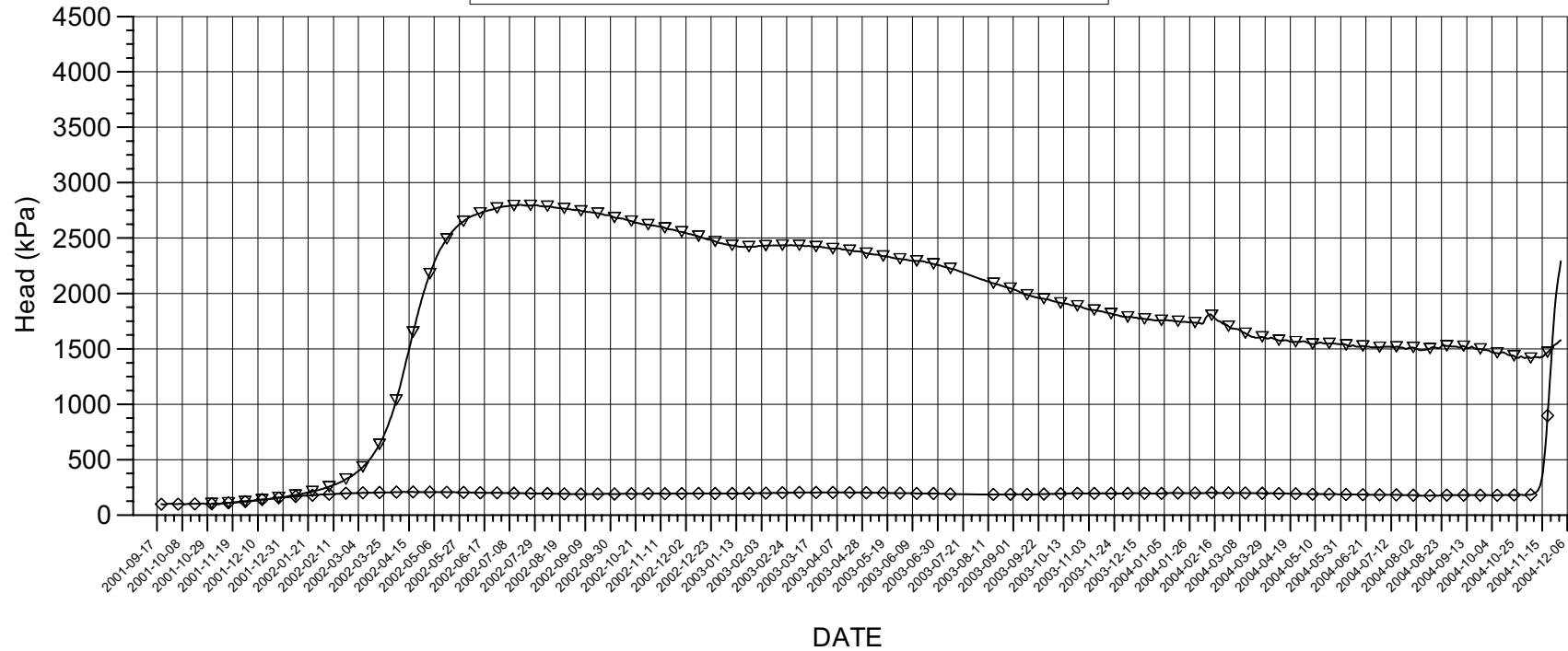

Events

- Start backfilling of section I 2001-09-03
- Stop backfilling of section I 2001-11-20
- Casting of inner plug finalized 2001-12-19
- Start backfilling of section II 2003-04-29
- Stop backfilling of section II 2003-06-27
- Casting of outer plug finalized 2003-09-11

Borehole sections

- ▽ — ▽ G01:1 7 m - 12 m
- ◇ — ◇ G01:2 1.4 m - 5 m

KA3588C01, KA3588D01, KA3588I01 PRESSURE HEAD

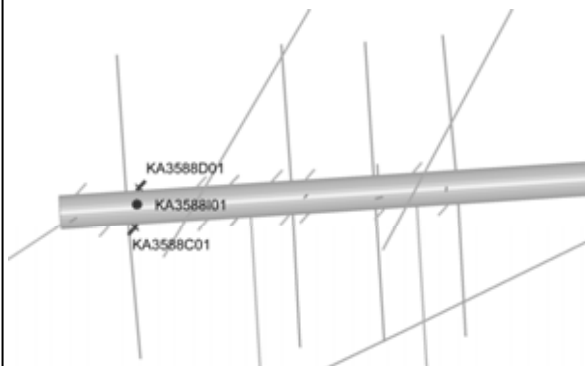
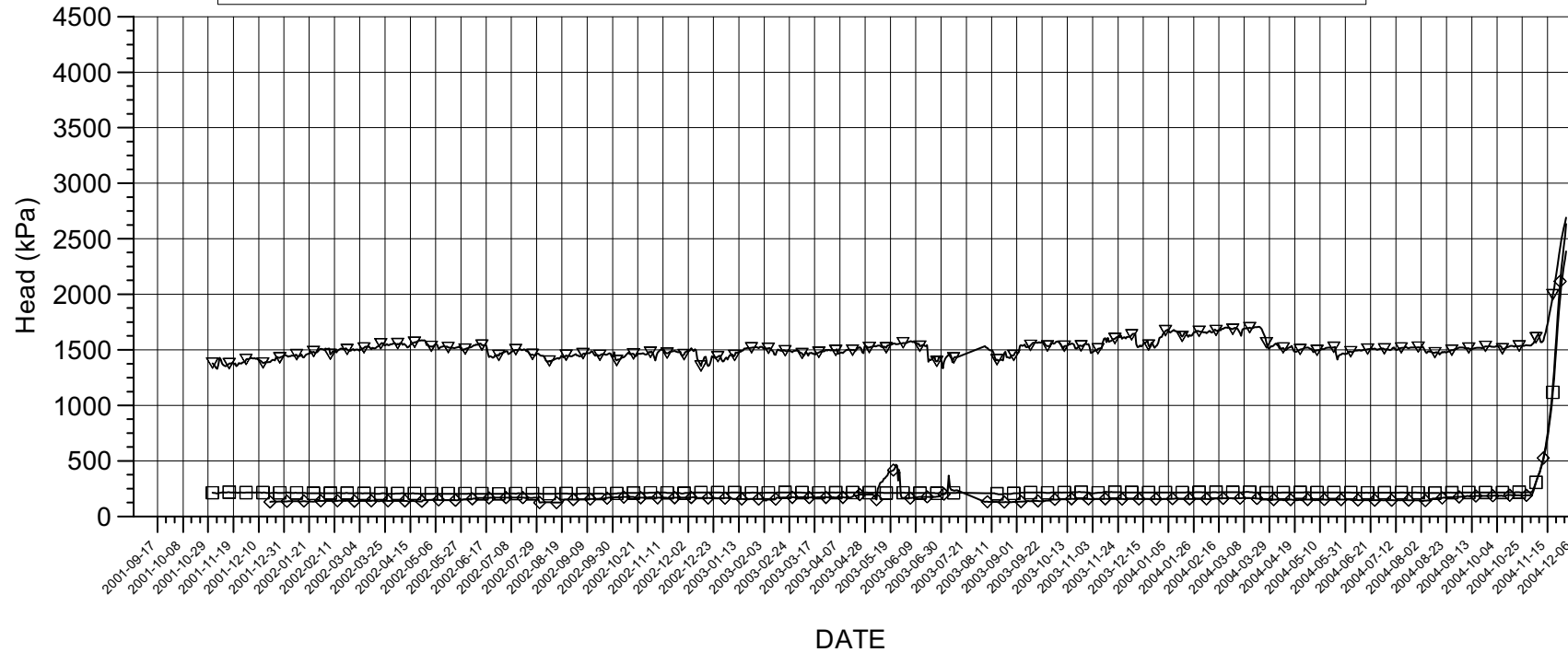

Events

- Start backfilling of section I 2001-09-03
- Stop backfilling of section I 2001-11-20
- Casting of inner plug finalized 2001-12-19
- Start backfilling of section II 2003-04-29
- Stop backfilling of section II 2003-06-27
- Casting of outer plug finalized 2003-09-11

Borehole sections

- ▽ KA3588C01:1 0.65 m - 2 m
- ◇ KA3588D01:1 0.65 m - 2 m
- KA3588I01:1 0.65 m - 2 m

KA3590G01 PRESSURE HEAD

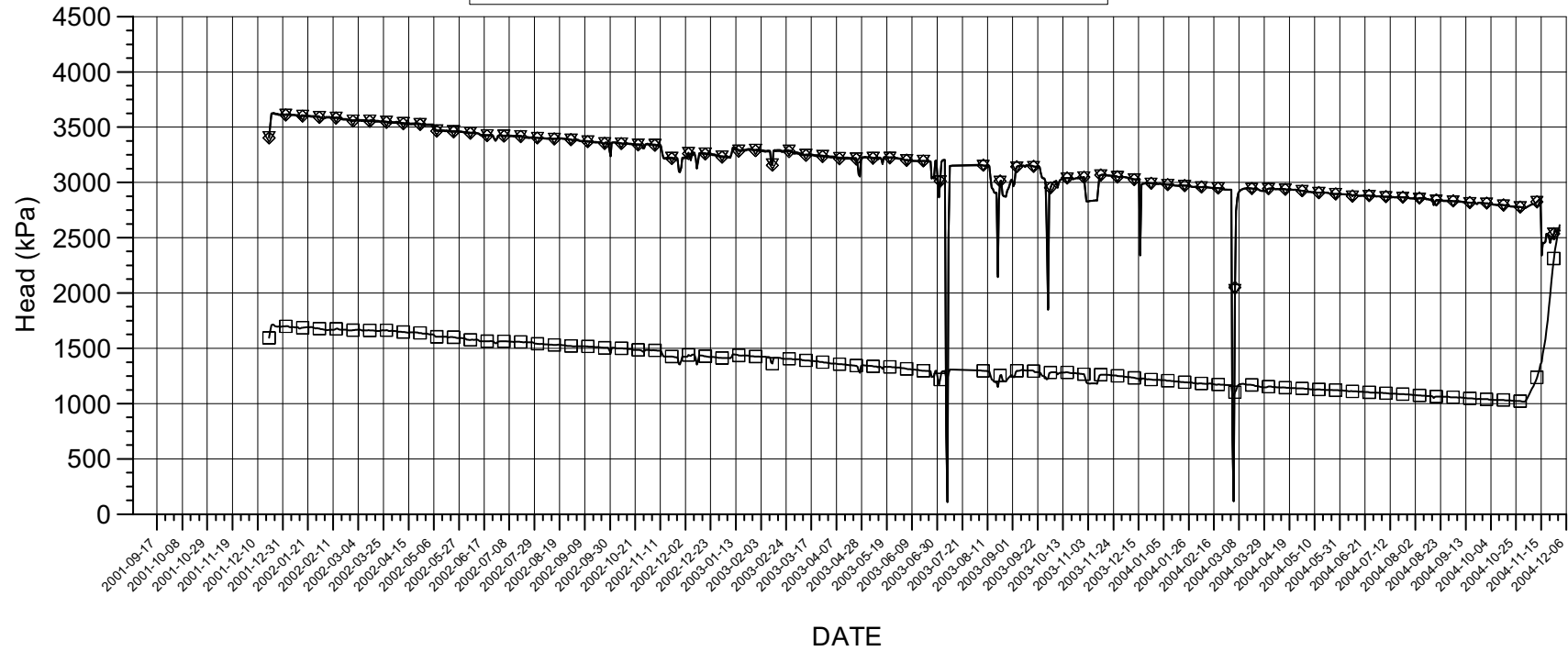

Events

- Start backfilling of section I 2001-09-03
- Stop backfilling of section I 2001-11-20
- Casting of inner plug finalized 2001-12-19
- Start backfilling of section II 2003-04-29
- Stop backfilling of section II 2003-06-27
- Casting of outer plug finalized 2003-09-11

Borehole sections

- ▽ — ▽ G01:1 16 m - 30 m
- ◇ — ◇ G01:2 7 m - 15 m
- — □ G01:3 1.5 m - 6 m

P_KA3590G01.GRF 2004-12-01

KA3590G02 PRESSURE HEAD

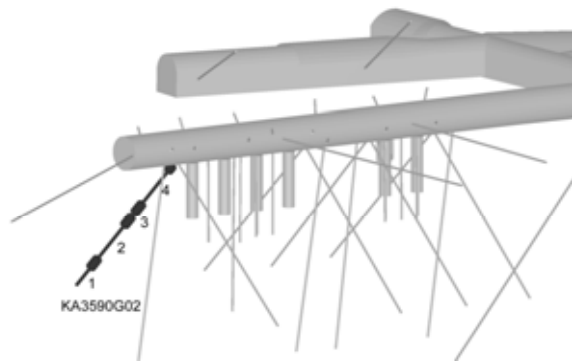
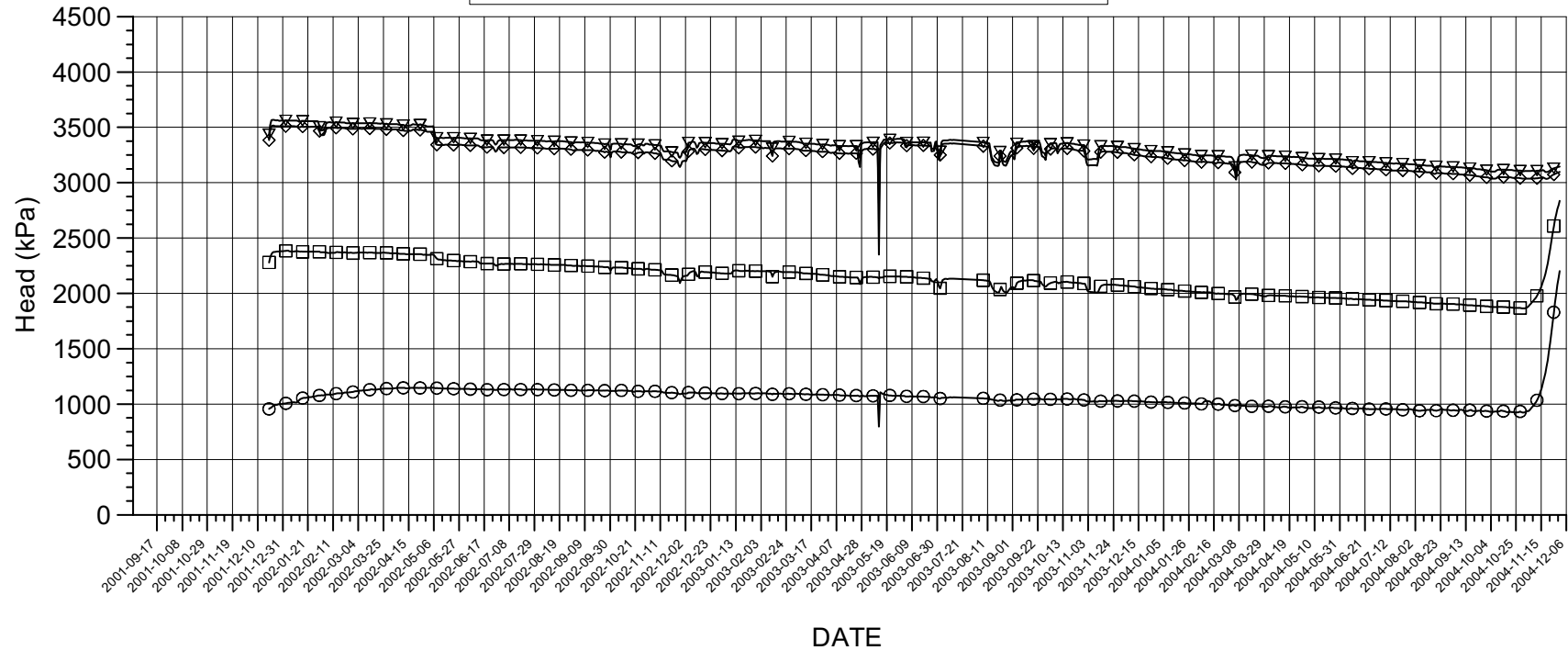

Events

- Start backfilling of section I 2001-09-03
- Stop backfilling of section I 2001-11-20
- Casting of inner plug finalized 2001-12-19
- Start backfilling of section II 2003-04-29
- Stop backfilling of section II 2003-06-27
- Casting of outer plug finalized 2003-09-11

Borehole sections

- ▽ — ▽ G02:1 25.65 m - 30 m
- ◇ — ◇ G02:2 15.35 m - 23.65 m
- — □ G02:3 12.05 m - 13.35 m
- — ○ G02:4 1.65 m - 10.05 m

P_KA3590G02.GRF 2004-12-01

KA3593G PRESSURE HEAD

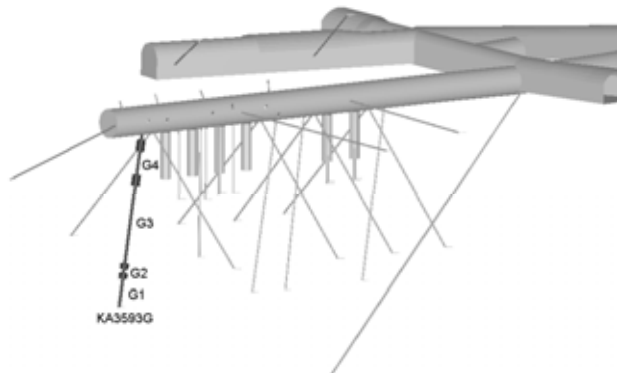
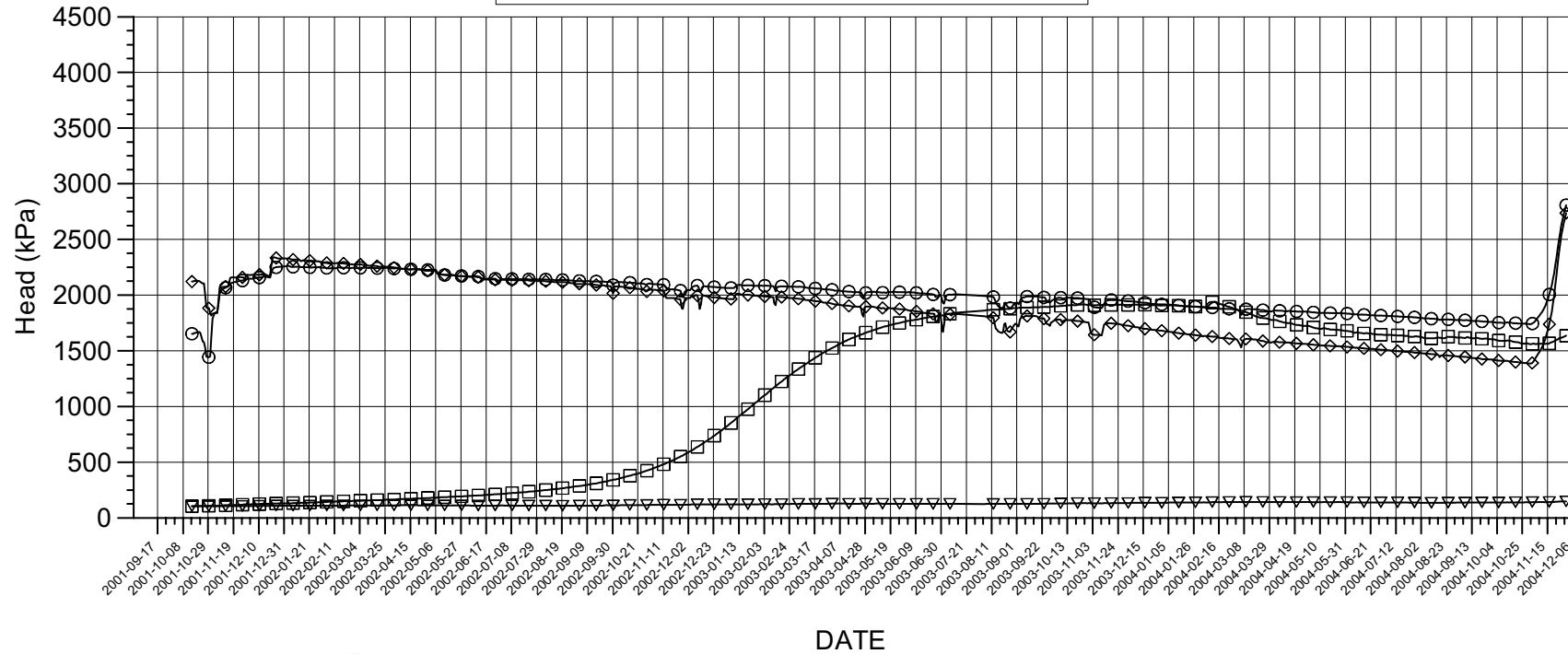

Events

- Start backfilling of section I 2001-09-03
- Stop backfilling of section I 2001-11-20
- Casting of inner plug finalized 2001-12-19
- Start backfilling of section II 2003-04-29
- Stop backfilling of section II 2003-06-27
- Casting of outer plug finalized 2003-09-11

Borehole sections

- ▽ G:1 25.2 m - 30 m
- ◇ G:2 23.5 m - 24.2 m
- G:3 9 m - 22.5 m
- G:4 3 m - 7 m

P_KA3593G.GRF 2004-12-01

KA3592C01, KA3597D01, KA3597H01 PRESSURE HEAD

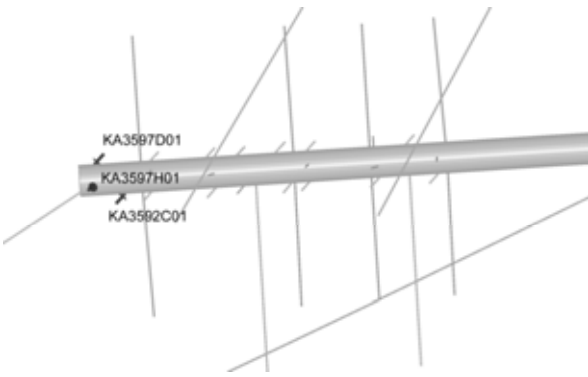
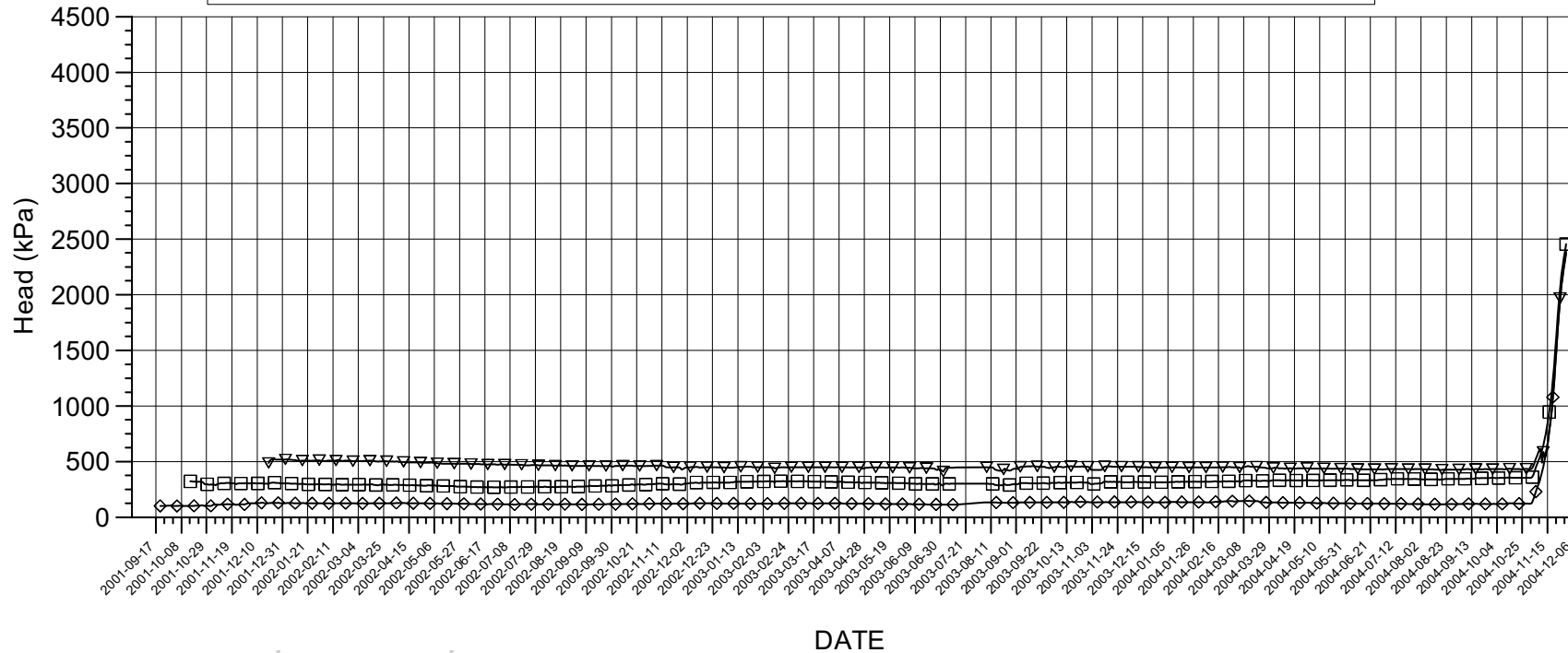

Events

- Start backfilling of section I 2001-09-03
- Stop backfilling of section I 2001-11-20
- Casting of inner plug finalized 2001-12-19
- Start backfilling of section II 2003-04-29
- Stop backfilling of section II 2003-06-27
- Casting of outer plug finalized 2003-09-11

Borehole sections

- ▽—▽ KA3592C01:1 0.65 m - 2 m
- ◇—◇ KA3597D01:1 0.65 m - 2 m
- KA3597H01:1 0.65 m - 2 m

KA3600F PRESSURE HEAD

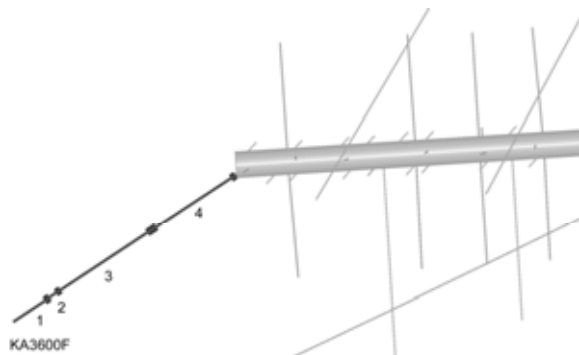
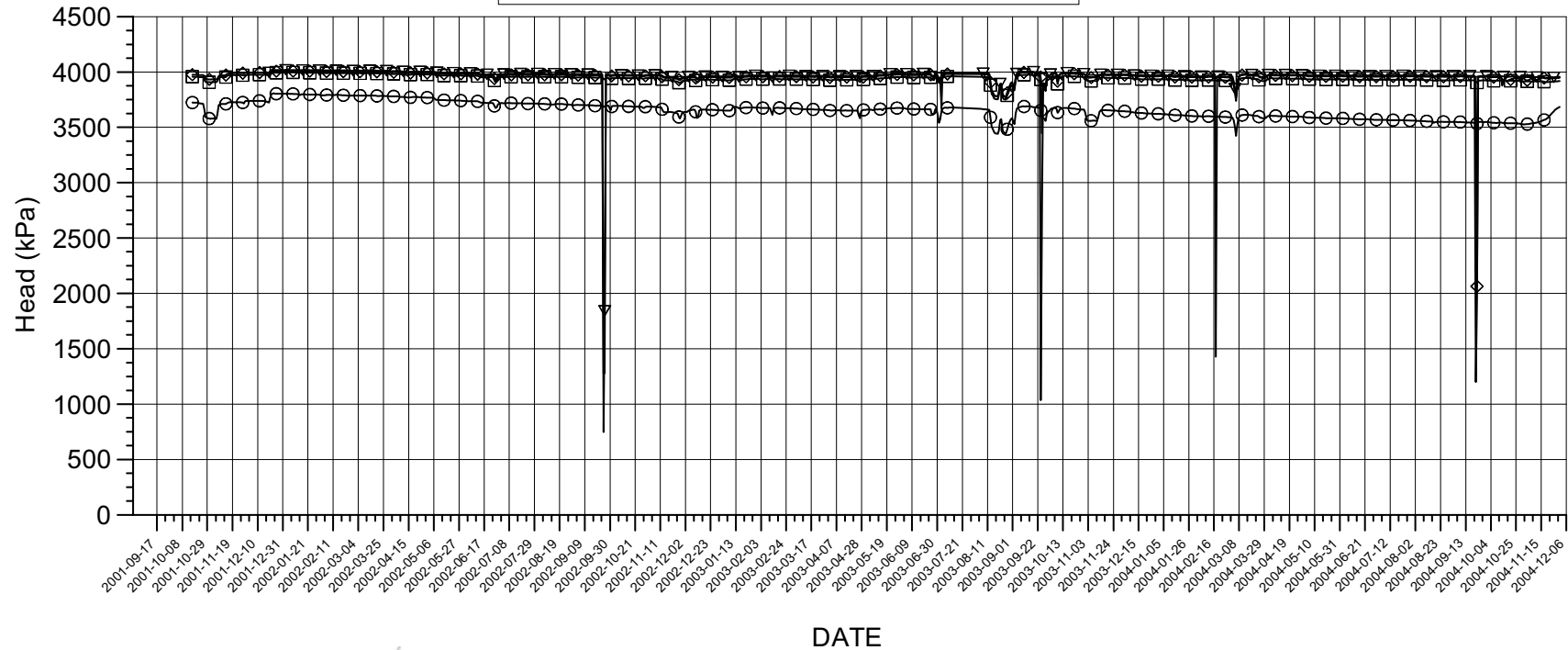

Events

- Start backfilling of section I 2001-09-03
- Stop backfilling of section I 2001-11-20
- Casting of inner plug finalized 2001-12-19
- Start backfilling of section II 2003-04-29
- Stop backfilling of section II 2003-06-27
- Casting of outer plug finalized 2003-09-11

Borehole sections

- ▽ — ▽ F:1 43 m - 50.1 m
- ◇ — ◇ F:2 40.5 m - 42 m
- — □ F:3 20 m - 39.5 m
- — ○ F:4 3.4 m - 18 m

P_KA3600F.GRF 2004-12-01

KG0021A01 PRESSURE HEAD

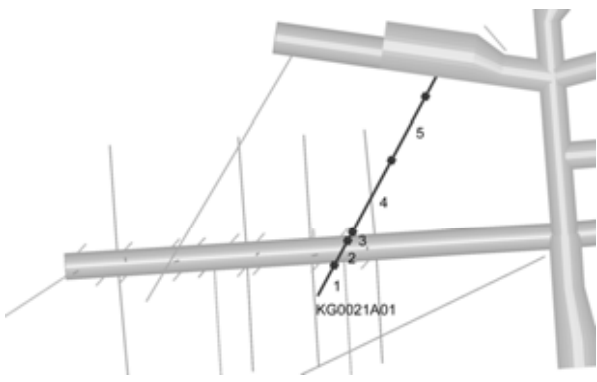
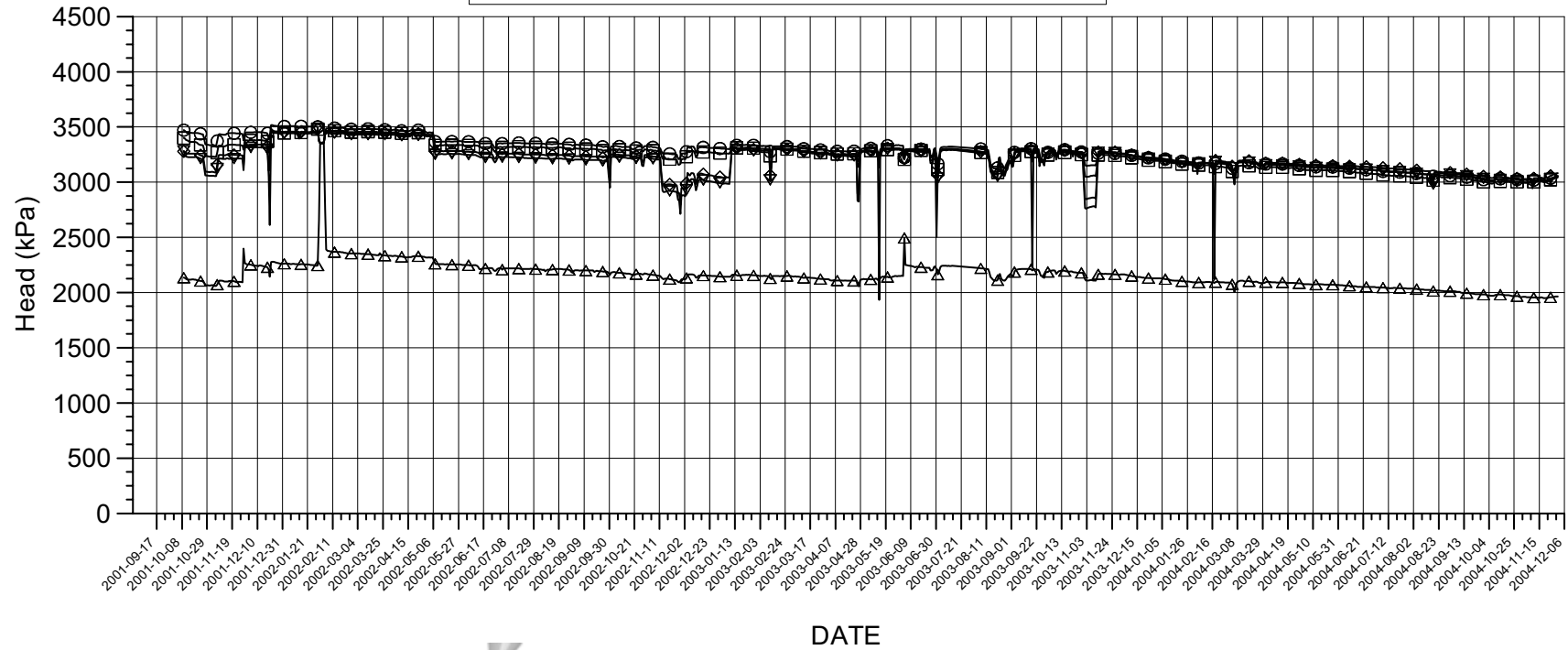

- Events**
- Start backfilling of section I 2001-09-03
 - Stop backfilling of section I 2001-11-20
 - Casting of inner plug finalized 2001-12-19
 - Start backfilling of section II 2003-04-29
 - Stop backfilling of section II 2003-06-27
 - Casting of outer plug finalized 2003-09-11

- Borehole sections**
- ▽ A01:1 42.5 m - 48.82 m
 - ◇ A01:2 37 m - 41.5 m
 - A01:3 35 m - 36 m
 - A01:4 19 m - 34 m
 - △ A01:5 5 m - 18 m

KG0048A01 PRESSURE HEAD

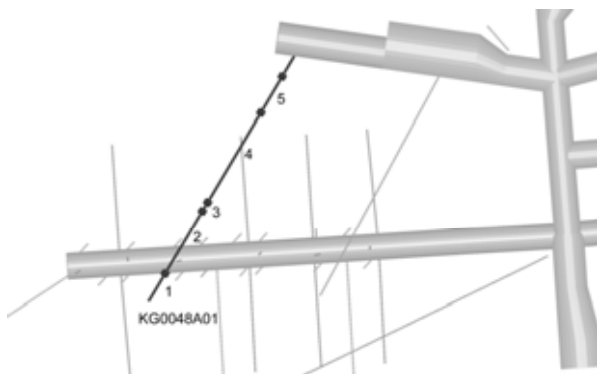
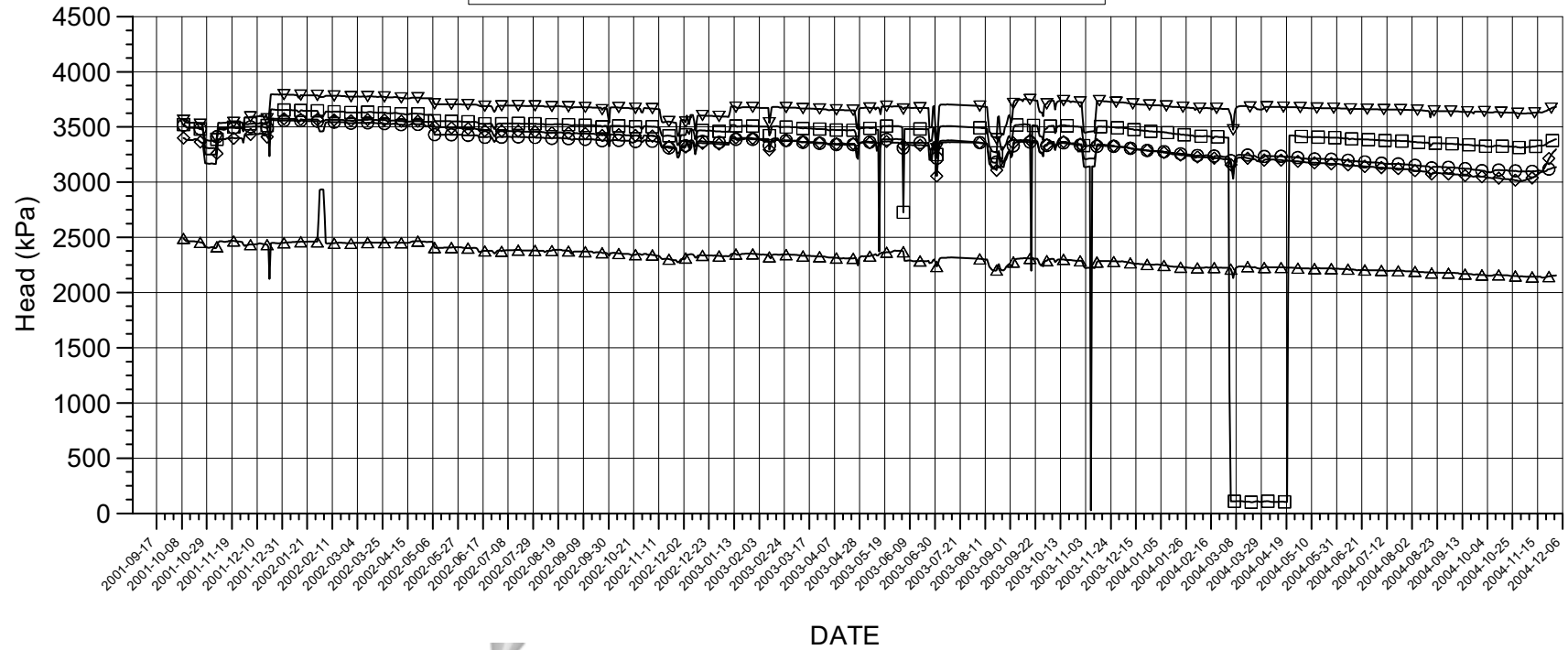

Events

- Start backfilling of section I 2001-09-03
- Stop backfilling of section I 2001-11-20
- Casting of inner plug finalized 2001-12-19
- Start backfilling of section II 2003-04-29
- Stop backfilling of section II 2003-06-27
- Casting of outer plug finalized 2003-09-11

Borehole sections

- ▽ — ▽ A01:1 49 m - 54.69 m
- ◇ — ◇ A01:2 34.8 m - 48 m
- — □ A01:3 32.8 m - 33.8 m
- — ○ A01:4 13 m - 31.8 m
- △ — △ A01:5 5 m - 12 m

P_KG0048A01.GRF 2004-12-01

MA3515G WEIR FLOW

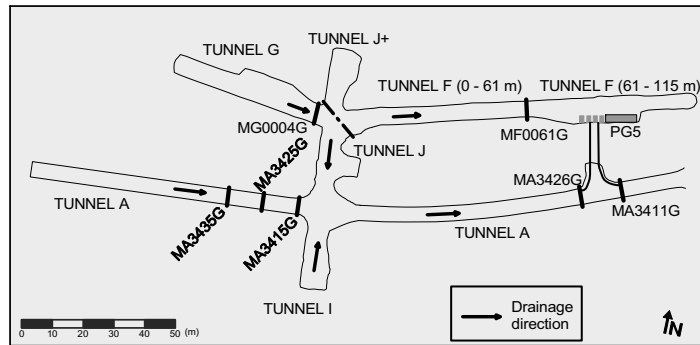
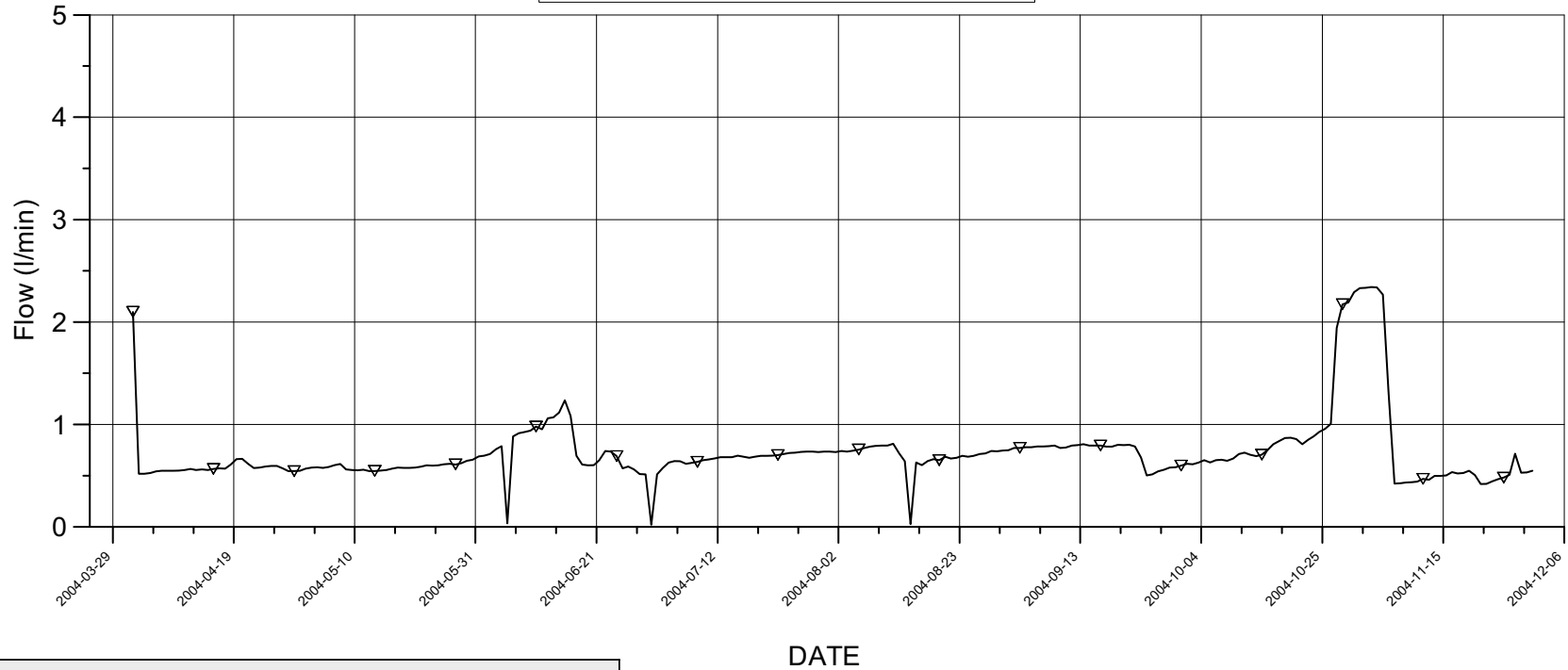

Events

- Start backfilling of section I 2001-09-03
- Stop backfilling of section I 2001-11-20
- Casting of inner plug finalized 2001-12-19
- Start backfilling of section II 2003-04-29
- Stop backfilling of section II 2003-06-27
- Casting of outer plug finalized 2003-09-11

▽ — ▽ WEIR MA3515G

MA3525G WEIR FLOW

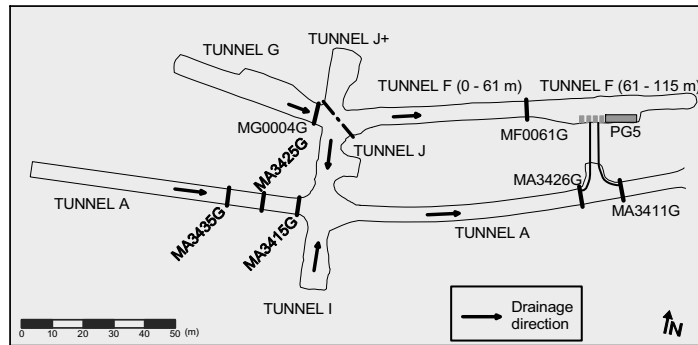
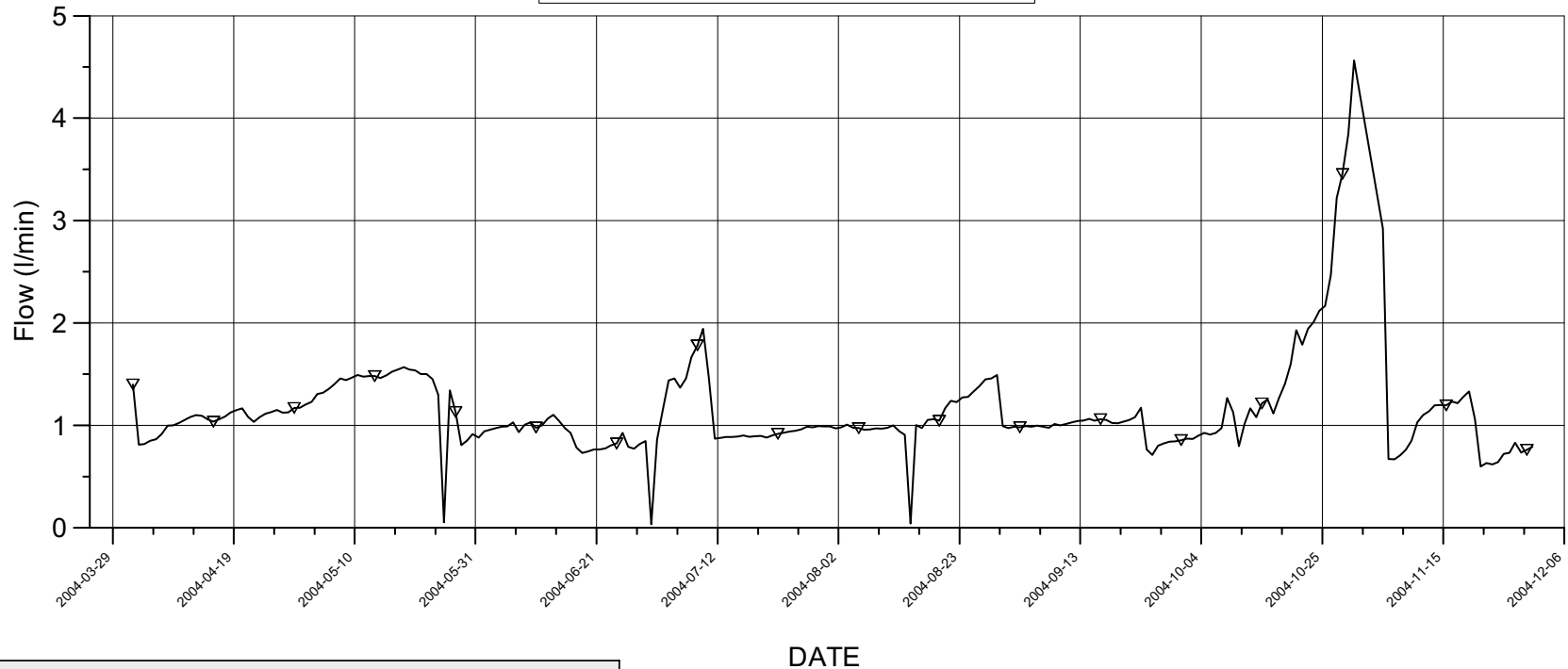

Events

- Start backfilling of section I 2001-09-03
- Stop backfilling of section I 2001-11-20
- Casting of inner plug finalized 2001-12-19
- Start backfilling of section II 2003-04-29
- Stop backfilling of section II 2003-06-27
- Casting of outer plug finalized 2003-09-11

▽ — ▽ WEIR MA3525G

MA3535G WEIR FLOW

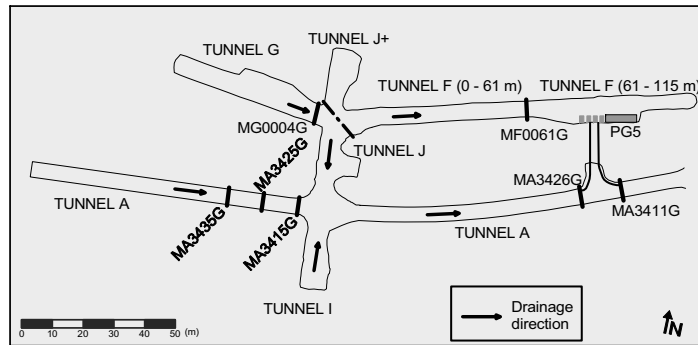
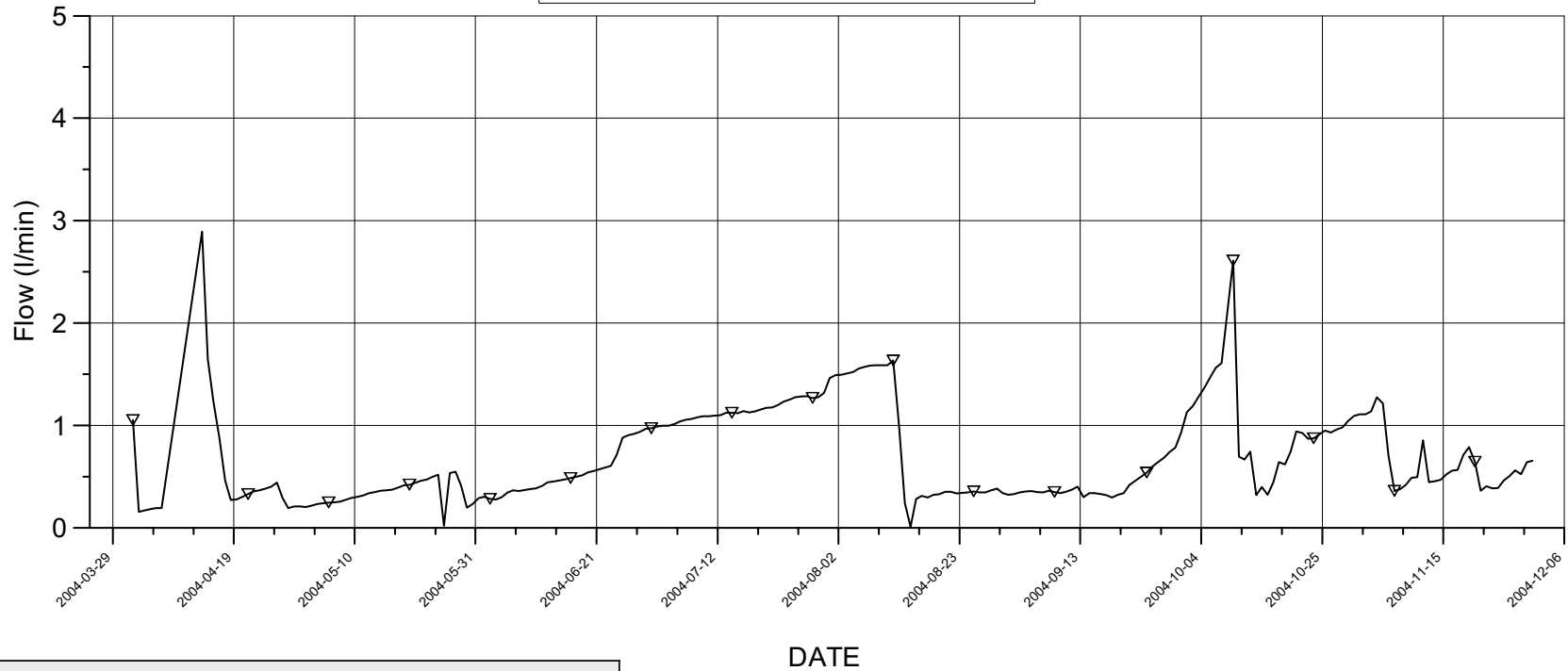

Events

- Start backfilling of section I 2001-09-03
- Stop backfilling of section I 2001-11-20
- Casting of inner plug finalized 2001-12-19
- Start backfilling of section II 2003-04-29
- Stop backfilling of section II 2003-06-27
- Casting of outer plug finalized 2003-09-11

▽ — ▽ WEIR MA3535G

MG0004G WEIR FLOW

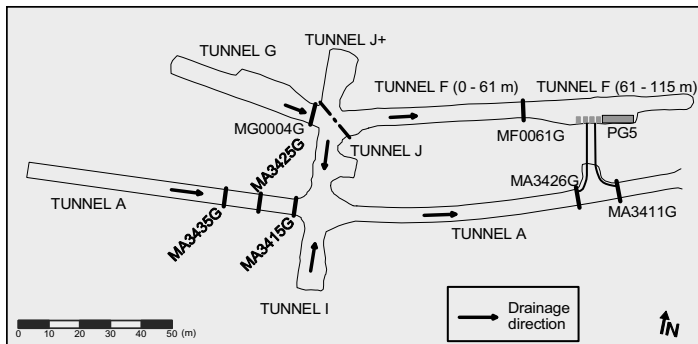
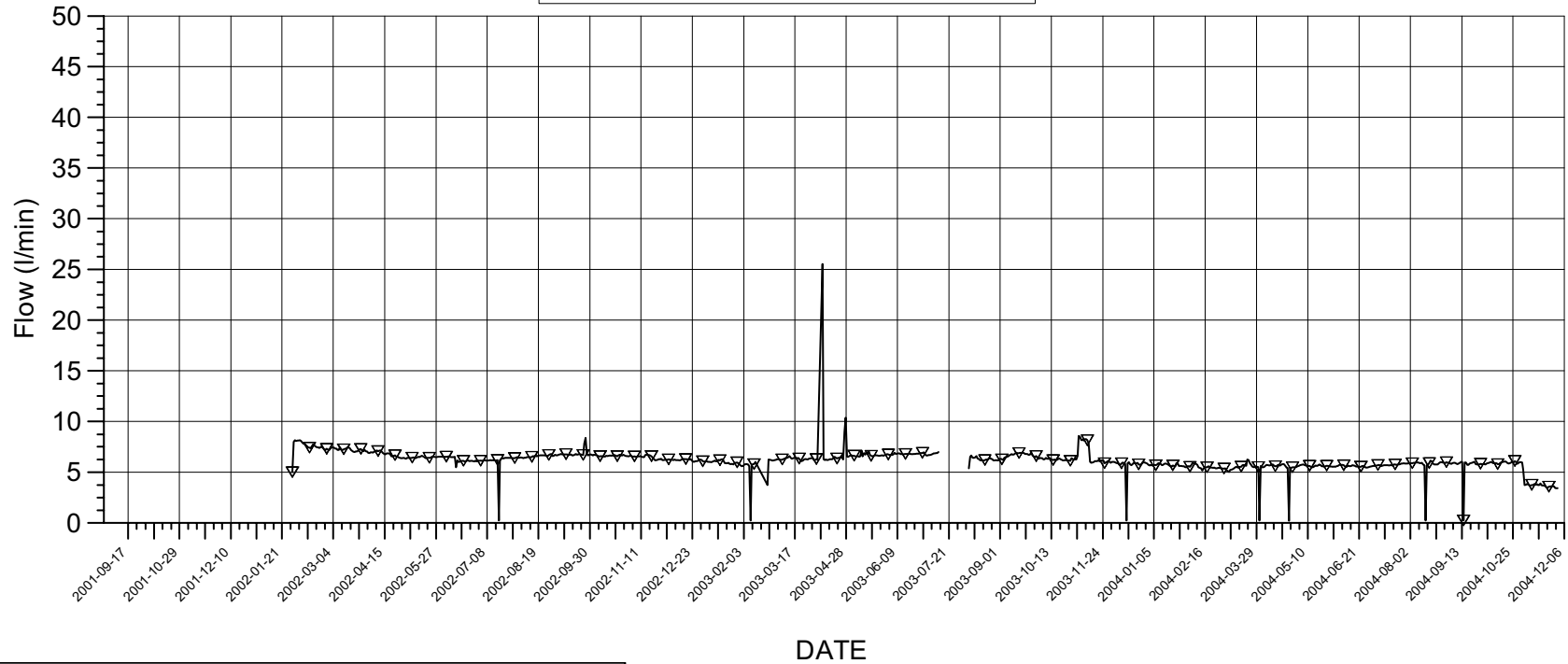

Events

- Start backfilling of section I 2001-09-03
- Stop backfilling of section I 2001-11-20
- Casting of inner plug finalized 2001-12-19
- Start backfilling of section II 2003-04-29
- Stop backfilling of section II 2003-06-27
- Casting of outer plug finalized 2003-09-11

WEIR MG0004G

MF0061G WEIR FLOW

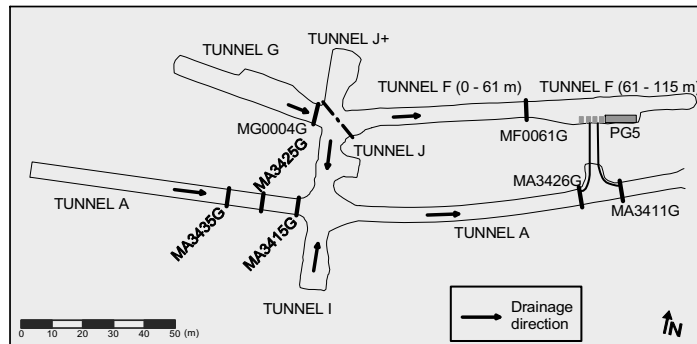
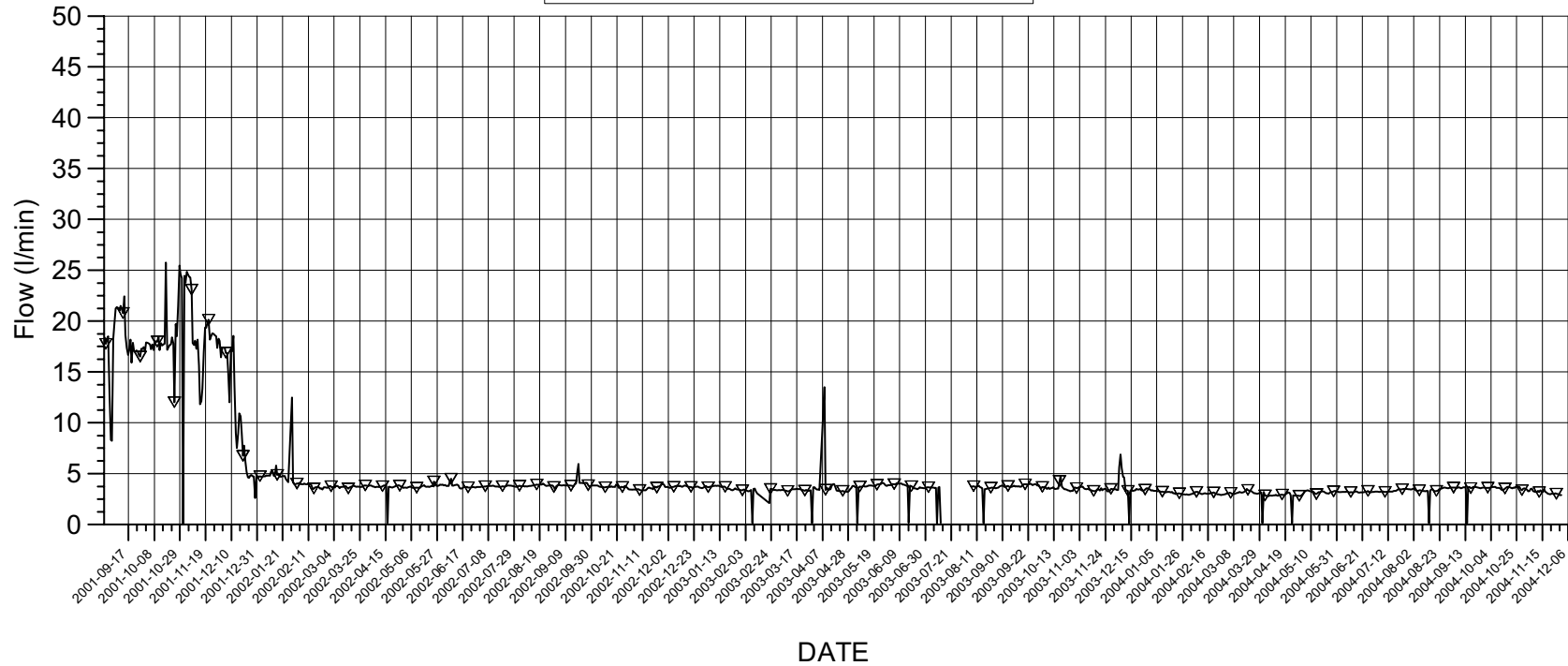

Events

- Start backfilling of section I 2001-09-03
- Stop backfilling of section I 2001-11-20
- Casting of inner plug finalized 2001-12-19
- Start backfilling of section II 2003-04-29
- Stop backfilling of section II 2003-06-27
- Casting of outer plug finalized 2003-09-11

▽ WEIR MF0061G

MA3426G WEIR FLOW

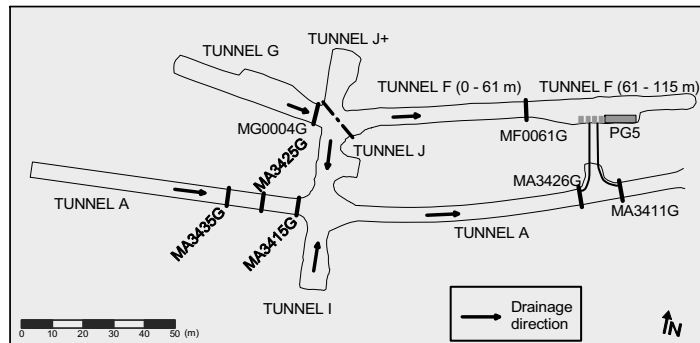
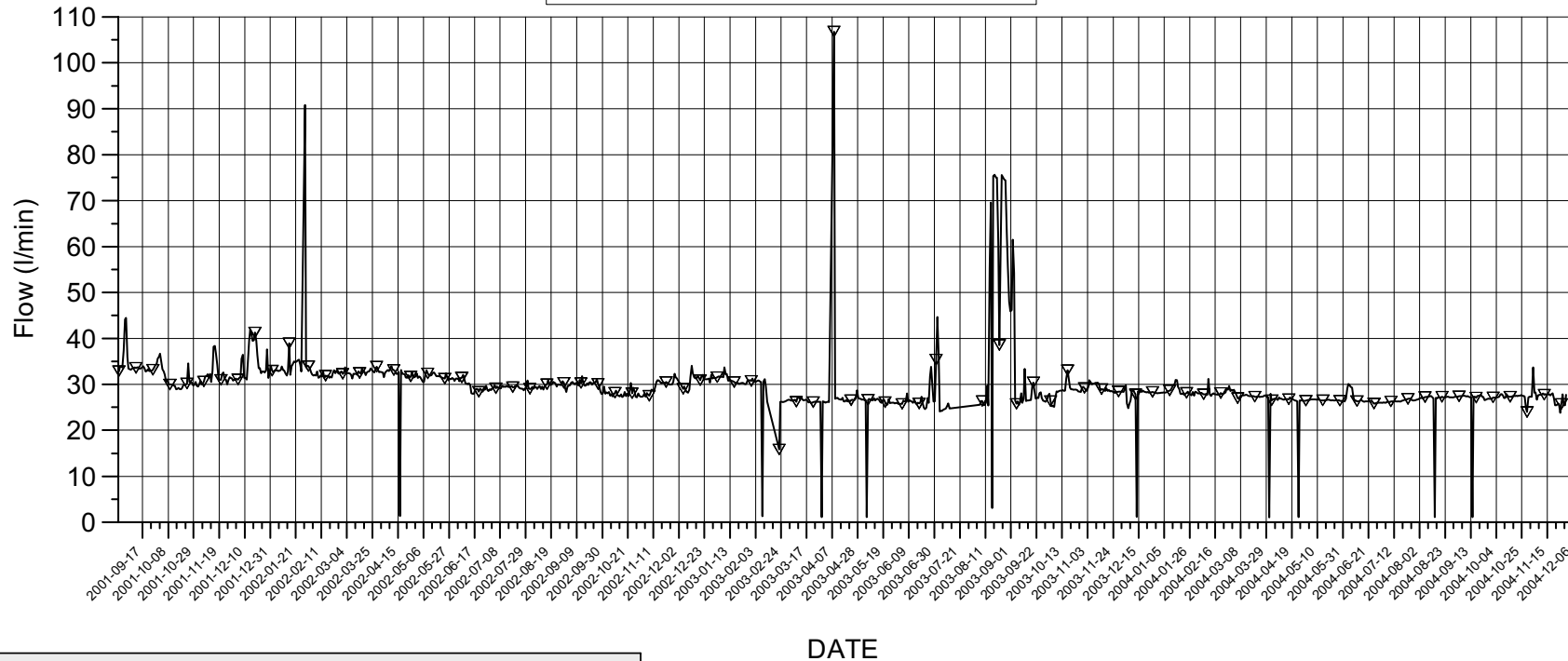

Events

- Start backfilling of section I 2001-09-03
- Stop backfilling of section I 2001-11-20
- Casting of inner plug finalized 2001-12-19
- Start backfilling of section II 2003-04-29
- Stop backfilling of section II 2003-06-27
- Casting of outer plug finalized 2003-09-11



Quick guide

Transducers in the backfill

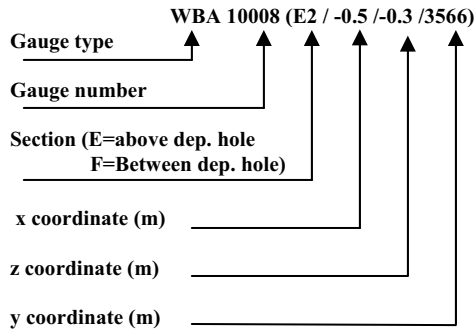

Transducers in dep. holes 1, 3,5 and 6 and in the rock

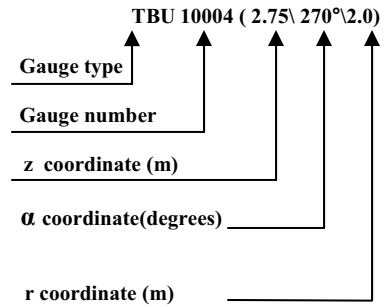

Coordinate system in backfill

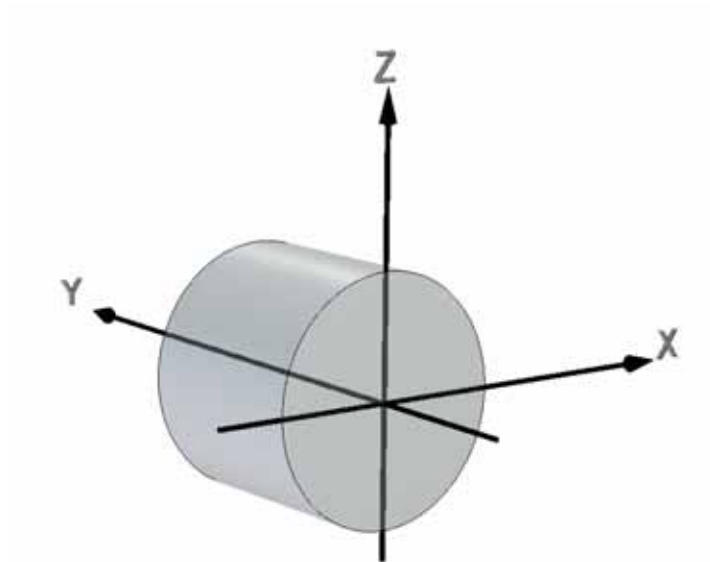

Coordinate system in dep. holes

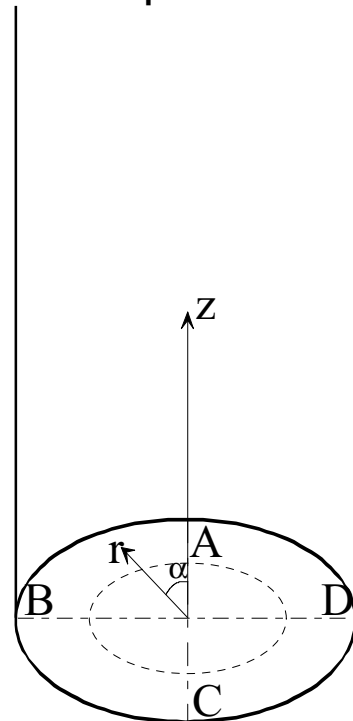

End of tunnel at Y =3599.8 m
 Center dep.hole 1.at Y =3587 m
 Center dep.hole 2 at Y =3581 m
 Center dep.hole 3 at Y =3575 m
 Center dep.hole 4 at Y =3569 m
 Inner plug surface at Y=3561.4 m
 Center dep.hole 5 at Y =3551 m
 Center dep.hole 6 at Y =3545 m
 Outer plug surface at Y=3538.6 m
 Tunnel radius Z=X =2.5 m

Tunnel direction C-A
 Bottom of hole Z=0
 Bottom of canister Z=0.5
 Top of canister Z=5.400
 Upper buffer surface Z=7.125
 Dep. hole radius r=0.875
 Canister radius r=0.525