



BACKGROUND REPORT TO
RD&D-PROGRAMME 92

Treatment and final disposal of nuclear waste

Detailed R&D-Programme 1993–1998

September 1992

SVENSK KÄRNBRÄNSLEHANTERING AB

SWEDISH NUCLEAR FUEL AND WASTE MANAGEMENT CO

BOX 5864 S-102 48 STOCKHOLM

TEL 08-665 28 00 TELEX 13108 SKB TELEFAX 08-661 57 19

BACKGROUND REPORT TO
RD&D-PROGRAMME 92

**Treatment and final disposal of
nuclear waste**

Detailed R&D-Programme 1993–1998

September 1992

FOREWORD

The Act on Nuclear Activities (SFS 1984:3) prescribes in Section 12 that a programme shall be prepared for the comprehensive research and development and other measures that are required to safely handle and finally dispose of the radioactive waste from the nuclear power plants. The responsibility lies primarily with the owners of the nuclear power plants. These owners have commissioned SKB to prepare the prescribed programme. According to Section 25 of the Ordinance on Nuclear Activities (SFS 1984:14), this programme shall be submitted to the National Board for Spent Nuclear Fuel in the month of September every third year.

The purpose of this third programme is to fulfil the above obligations.

The programme is presented in one main report and three background reports. The programme is called RD&D-Programme 92, where RD&D stands for Research, Development and Demonstration. The reason for the change of name compared to previous R&D programmes is to underscore the fact that, starting with the work at the Äspö Hard Rock Laboratory and the plans presented in this programme, the emphasis of the programme has been shifted towards demonstrating different parts of the selected disposal system. The main report describes the programme in its entirety. This background report provides a more detailed account of the R&D work during the period 1993–1998, except for the Äspö Hard Rock Laboratory. The activities there are described in a special background report. Another background report deals with Siting of a deep repository.

Stockholm, September 1992

SWEDISH NUCLEAR FUEL AND WASTE
MANAGEMENT COMPANY

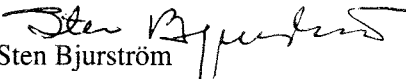
Sten Bjurström
Managing Director

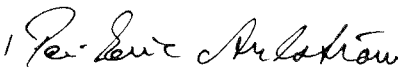
Per-Eric Ahlström
Research Director

CONTENTS

	Page	
1	INTRODUCTORY OVERVIEW	9
1.1	REQUIREMENTS AND GOALS	9
1.2	THE SITUATION TODAY	9
1.3	GENERAL PLAN FOR FURTHER WORK	11
1.4	SITING	15
1.5	PLANNED SYSTEM FOR ENCAPSULATION AND DEEP DISPOSAL OF SPENT NUCLEAR FUEL	16
1.6	OUTLINE OF THE RD&D-PROGRAMME	17
1.7	OUTLINE OF THE BACKGROUND REPORT	17
2	SAFETY ASSESSMENTS	19
2.1	GENERAL	19
2.2	GOALS	20
2.2.1	SKB's timeschedule and the need for safety assessments	20
2.2.2	Goals for the period 1993–1998	22
2.3	PRESENT-DAY STATE OF KNOWLEDGE	22
2.3.1	Overview	22
2.3.2	Scenarios	26
2.3.3	Modelling of transport in the near field	27
2.3.4	Modelling of transport in the far field	29
2.3.5	Modelling of dispersal in the biosphere	30
2.4	PROGRAMME 1993–1998	30
2.4.1	Performance and safety assessments	30
2.4.2	Scenarios	31
2.4.3	Near field	31
2.4.4	Far field	32
2.4.5	Performance and safety assessments	33
3	SPENT NUCLEAR FUEL	35
3.1	PRESENT-DAY STATE OF KNOWLEDGE	35
3.1.1	Corrosion of high-level spent nuclear fuel	35
3.1.2	Other components in the near field	43
3.1.3	Models	44
3.1.4	Natural analogues	45
3.2	GOALS FOR THE PERIOD 1993–1998	45
3.3	PROGRAMME 1993–1998	45
3.3.1	Characterization of spent nuclear fuel	46
3.3.2	Radiolysis	47
3.3.3	Corrosion of high-level fuel	47
3.3.4	Model development	47
3.3.5	Natural analogues	48

	Page
4	CANISTER 49
4.1	PRESENT-DAY STATE OF KNOWLEDGE 49
4.1.1	Alternative canister materials 49
4.1.2	Corrosion – copper 50
4.1.3	Mechanical aspects 52
4.1.4	SKB’s conclusions 55
4.2	GOAL OF THE ACTIVITIES 55
4.3	PROGRAMME 1993–1998 55
4.3.1	Corrosion 55
4.3.2	Alternative designs – lead filling 56
4.3.3	Welding of copper 56
4.3.4	Fill material 56
4.3.5	Post-fabrication inspection – NDT 57
5	BUFFER AND BACKFILL 59
5.1	BACKGROUND 59
5.2	GOALS OF RD&D ACTIVITIES 1993–1998 59
5.3	PRESENT-DAY STATE OF KNOWLEDGE 59
5.4	PROGRAMME 1993–1998 63
6	GEOSCIENCE 65
6.1	INTRODUCTION 65
6.1.1	The role of the rock in the deep repository 65
6.1.2	The principle for investigations in crystalline rock 66
6.1.3	Scope and coordination of the geoscientific activities 67
6.1.4	Overall goals of the geoscientific programme 68
6.2	GROUNDWATER MOVEMENTS – CONCEPTUAL MODELLING 68
6.2.1	Goals of the activities 1993–1998 68
6.2.2	State of knowledge 69
6.2.3	Programme 1993–1998 70
6.3	STABILITY OF THE BEDROCK 73
6.3.1	Goals of the activities 1993–1998 73
6.3.2	State of knowledge 73
6.3.3	Programme 1993–1998 78
6.4	GEOHYDROLOGICAL AND ROCK- MECHANICAL CALCULATION MODELS 79
6.4.1	Goals of the activities 1993–1998 79
6.4.2	State of knowledge 80
6.4.3	Programme 1993–1998 82
6.5	ALTERNATIVE FINAL DISPOSAL METHODS 83
7	CHEMISTRY 85
7.1	GROUNDWATER AND GEOCHEMISTRY 85
7.1.1	Goals of the activities 85
7.1.2	Present-day state of knowledge 85
7.1.3	Programme 1993–1998 90

	Page
7.2	RADIONUCLIDE CHEMISTRY 93
7.2.1	Goals of the activities 93
7.2.2	Present-day state of knowledge – Results 93
7.2.3	Programme 1993–1998 99
7.3	VALIDATION OF PROCESSES IN TRANSPORT MODELS AND RADIONUCLIDE MIGRATION 100
7.3.1	Goal of the activities 100
7.3.2	Present-day state of knowledge 100
7.3.3	Research programme 1993–1998 104
7.4	MISCELLANEOUS 107
7.4.1	The fracture zone project 107
7.4.2	Chemical toxicity 107
8	NATURAL ANALOGUES 109
8.1	POÇOS DE CALDAS 109
8.1.1	The geology of the area 110
8.1.2	Groundwater chemistry 115
8.1.3	Radionuclides and trace metals 116
8.1.4	The redox front 117
8.1.5	Co-precipitation 118
8.1.6	Plutonium 118
8.1.7	Colloids 119
8.1.8	Hydrothermal transport 120
8.2	THE CIGAR LAKE PROJECT 120
8.3	THE OKLO PROJECT 122
8.4	MISCELLANEOUS 123
9	METHODS AND INSTRUMENTS 125
9.1	GOALS OF THE ACTIVITIES 125
9.2	PRESENT-DAY STATE OF KNOWLEDGE 125
9.2.1	Measurement methods and instruments for investigations from the ground surface 126
9.2.2	Measurement methods and instruments for investigations in boreholes from the ground surface 127
9.2.3	Measurement methods and instruments for investigations from tunnels and shafts 130
9.3	PROGRAMME 1993–1998 133
9.3.1	Measurement methods and instruments for investigations from the ground surface and in boreholes from the ground surface 133
9.3.2	Measurement methods and instruments for investigations from tunnels and shafts 135
10	BIOSPHERE STUDIES 137
10.1	GENERAL 137
10.2	GOALS 137

	Page
10.3	PRESENT-DAY STATE OF KNOWLEDGE 138
10.3.1	Transport from groundwater in rock to a local ecosystem via different local recipients such as sediment, soil, water etc. 138
10.3.2	Transport, dilution, accumulation and deposition in local, regional and global ecological systems 139
10.3.3	Studies of Chernobyl fallout 140
10.3.4	Transport to man through production and distribution of food 140
10.3.5	Uptake in the human body depending on dietary habits and uptake fractions 141
10.3.6	Calculation of individual doses and collective doses and comparison with natural conditions 141
10.3.7	Site-specific study of the Äspö area 141
10.3.8	Mathematical and conceptual modelling of dispersal in the biosphere 141
10.3.9	Other research on the biosphere 142
10.4	PROGRAMME 1993–1998 142
10.4.1	Wells 142
10.4.2	Transport through sediment and soil 142
10.4.3	Changes in the biosphere 142
10.4.4	Natural analogues 143
10.4.5	Transport pathways in the biosphere 143
10.4.6	Models and data 143
10.4.7	Site-specific studies 144
10.4.8	Acceptance criteria 144
11	TECHNOLOGY FOR DEEP DISPOSAL 145
11.1	GENERAL 145
11.2	GOAL OF THE ACTIVITIES 1993–1998 145
11.3	PRESENT-DAY STATE OF KNOWLEDGE 145
11.3.1	Deep disposal system 145
11.3.2	Preferred repository design 147
11.3.3	Technology for excavation and deposition 149
11.4	PROGRAMME 1993–1998 153
12	OTHER WASTE 155
12.1	BACKGROUND 155
12.2	WASTE COMPOSITION 155
12.2.1	Waste from research activities at Studsvik 155
12.2.2	Core components and reactor internals 156
12.2.3	Waste from the encapsulation station 156
12.3	FINAL DISPOSAL 156
12.4	GOALS OF THE ACTIVITIES 1993–1998 157
12.5	PROGRAMME FOR 1993–1998 158
	REFERENCES 159

1 INTRODUCTORY OVERVIEW

This chapter is an abbreviated version of the introductory overview given in chapter 1 of the main report. The chapter concludes with a section that presents an outline of this background report.

1.1 REQUIREMENTS AND GOALS

The goal of radioactive waste management in Sweden is to dispose of all radioactive waste products generated at the Swedish nuclear power plants in a safe manner. Furthermore, all other radioactive waste that arises in Sweden shall be safely disposed of.

The Act on Nuclear Activities requires that the owners of the Swedish nuclear power plants adopt the measures that are needed to achieve this goal. The owners of the Swedish nuclear power plants have commissioned the Swedish Nuclear Fuel and Waste Management Company (SKB) to implement the measures that are needed.

1.2 THE SITUATION TODAY

The Swedish system for the management of radioactive waste, see Figure 1-1, is described in detail in the annual report on the costs of waste management – PLAN 92 /1-1/. Essential parts of the waste management system are already in operation. These include the central interim storage facility for spent nuclear fuel, CLAB, the final repository for radioactive operational waste, SFR, and the transportation system. The parts that have not yet been finalized are an encapsulation plant for spent nuclear fuel etc. and a final repository for long-lived waste, particularly spent nuclear fuel.

The existing system has been developed and built up systematically on the basis of proposals put forth in the mid-1970s and the research and development work initiated with the KBS Project during the latter half of the 1970s.

Proposals and alternative options have since been reviewed and studied by both regulatory authorities and the nuclear power industry in extensive R&D projects during the 1980s. This means that the important issues relating to encapsulation and final disposal of spent nuclear fuel in Swedish bedrock have been thoroughly elucidated.

Similar studies have been and are being carried out in most countries with significant nuclear power programmes. Owing to the stringent requirements introduced in the so-called Stipulation Act in 1977, the work in Sweden got under way with great determination and ample resources. This has given the Swedish activities an internationally recognized position and led to broad international cooperation. The interest from other countries is due not to the fact that conditions for final disposal are better in Sweden, but to the systematic way the work has been done and reported on, and the quality of the facilities that have already been built.

The work that has been carried out during a period of about fifteen years in Sweden, and equivalent work in other countries, has led to broad agreement among the international experts that methods exist for implementing final disposal of high-level waste and spent nuclear fuel and that methods also exist for demonstrating the

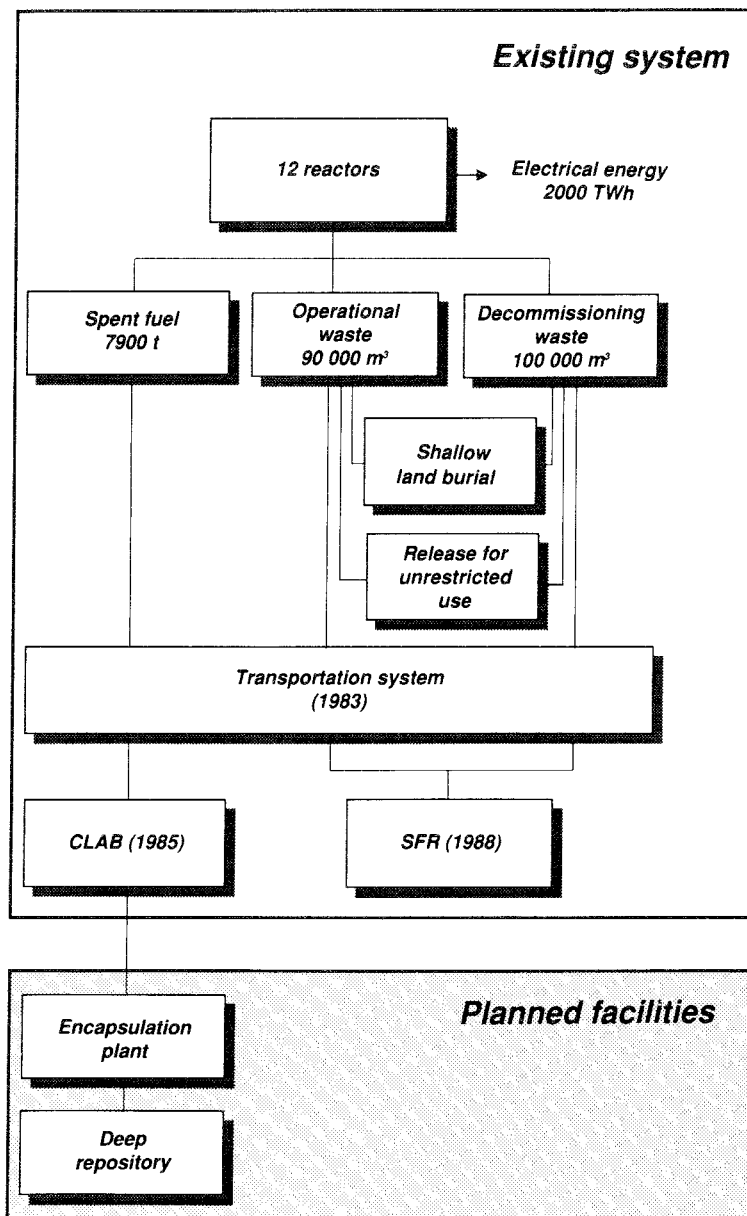

Figure 1-1. The Swedish waste management system.

long-term safety of such disposal. Clear expressions of this agreement include, for example, the approval of the KBS 3 report /1-2/ in Sweden and of similar studies in Finland /1-3/ and Switzerland /1-4/. The “collective opinions” expressed by international expert groups within the OECD/NEA, the IAEA and the EC are also worth mentioning /1-5,6/. An important conclusion in the most recent of these collective opinions is that further efforts should be focused on gathering and evaluation of data from proposed final repository sites.

After having examined safety, technical feasibility and other aspects for a number of different alternatives, work in Sweden has now reached a point where it has to be concentrated to a main line.

The principle of final disposal is that it shall be arranged so that the waste is kept isolated in a safe manner during the time that the waste has a higher radiotoxicity than

is otherwise found in nature. Spent nuclear fuel contains large quantities of radioactive materials. Most of these will have decayed after a few hundred years. After a thousand years, all that will remain, besides uranium and its daughter products, is a few long-lived radionuclides, such as plutonium, with a very long decay time. After 100,000 years, the radiotoxicity of the fuel will have declined to a level equivalent to that in uranium ores.

To bring about the desired long-term isolation, a final repository for spent nuclear fuel is designed according to the multi-barrier principle. The spent fuel consists primarily of uranium dioxide, a ceramic material that has low solubility in groundwater. The most important long-lived radionuclides – which are formed in conjunction with irradiation in the reactor, e.g. plutonium – are embedded in the ceramic material and are likewise low-soluble in water. The fuel is enclosed in a canister with good mechanical strength and made of a material with a long corrosion life. The canisters are placed in specially arranged chambers in the rock and surrounded with a buffer material. The materials in the engineered barriers have documented long-term stability and the repository only affects the natural conditions in the rock slightly.

The safety assessments have shown that excellent conditions exist for designing the near field in the repository so that the radioactive materials are kept isolated for more than one million years. Moreover, the rock has a great capacity to sorb the radionuclides that dominate the radiotoxicity of the fuel and thereby constitutes an additional barrier.

The SKB 91 safety assessment /1-7/, which SKB carried out during 1989-1992, shows that the requirements on the properties of the bedrock are limited. "...SKB 91 shows that a repository constructed deep down in Swedish crystalline basement rock with engineered barriers possessing long-term stability fulfils the safety requirements proposed by the authorities with ample margin. The safety of such a repository is only slightly dependent on the ability of the surrounding rock to retard and sorb leaking radioactive materials. The primary function of the rock is to provide stable mechanical and chemical conditions over a long period of time so that the long-term performance of the engineered barriers is not jeopardized". The studies and investigations that have been conducted of the bedrock in Sweden during the past 15-year period show that these properties exist at many places and that there are thus many sites possessing the necessary geological and technical prerequisites for constructing a safe repository.

Present-day knowledge is sufficient for selecting a preferred system design, for designating candidate sites for siting a repository, for characterizing these sites and for adapting the repository to local conditions.

1.3 GENERAL PLAN FOR FURTHER WORK

SKB's previous plan for siting and building a repository for spent nuclear fuel entailed that after pre-investigations at three sites and detailed characterization at two during the 1990s, a decision would be taken a few years into the 21st century to build a repository for about 8,000 tonnes of fuel at one of the sites. During the circulation of R&D-Programme 89 for comment and review /1-8/, a proposal from SKN was discussed to the effect that a demonstration-scale repository should first be built, for example 5-10% of the full-scale repository. In its decision concerning R&D-Programme 89 /1-9/, the Government asserted "*...that one of the premises for further research and development activities should be that a final repository for nuclear waste and spent nuclear fuel shall be able to be put into operation gradually with checkpoints and opportunities for adjustments. In the next R&D programme under*

the Act on Nuclear Activities, SKB should explore the possibilities of including a demonstration-scale final repository as a step in the work of designing a final repository.”

In the planning of the 1992 RD&D-programme, SKB considered this possibility of building and commissioning the repository in stages. The result is that SKB finds that a demonstration phase has considerable advantages. The present programme thereby calls for completion of the research, development and demonstration work by first building the final repository as a deep repository for demonstration deposition of spent nuclear fuel. When the demonstration deposition has been completed, the results will be evaluated before a decision is made whether or not to expand the facility to accommodate all the waste. This plan also makes it possible to consider whether the deposited waste should be retrieved for alternative treatment. The latter option means that it must be possible to retrieve deposited fuel during the period the facility is being operated for demonstration purposes. The siting process is only affected to a limited extent by whether the planning applies to a deep repository for demonstration deposition or to a complete deep repository. The requirements on background information from SKB in the different phases (pre-investigation, detailed characterization, construction of repository) are essentially the same.

The most important reason for SKB’s plan to build a repository for demonstration deposition is that this makes it possible to demonstrate the following, without the necessity of making what are sometimes described and perceived as definite decisions:

- the siting process with all its technical, administrative and political decisions,
- the process and the methods for step-by-step investigation and characterization of the deep repository site,
- system design and construction,
- full-scale encapsulation of spent nuclear fuel,
- the handling chain of spent nuclear fuel from CLAB to deposition in the repository,
- the operation of a deep repository,
- the licensing of handling, encapsulation and deep disposal, including the assessment of long-term safety,
- (retrievability of the waste packages).

Beyond this it is also possible to study the condition of the barriers a given shorter or longer time after deposition. This is, however, something that preferably can and should be investigated with non-radioactive material in the Äspö Hard Rock Laboratory, which is under construction at Simpevarp approximately 20 km north of Oskarshamn.

The long-term safety of the final repository cannot be demonstrated through field tests. Allowability in this respect must always be based on a technical-scientific assessment of the performance of the repository over a long period of time. However, the background information that is gathered in conjunction with the construction of the deep repository for demonstration deposition allows a safety assessment to be performed based on site-specific “full-scale” data.

The reason SKB is planning a demonstration deposition is not doubt as to the feasibility and safety of the deep disposal scheme. The plan should be viewed as an expression of an awareness of and respect for the fact that the solution of the nuclear waste problem arrived at by the R&D work needs to be demonstrated concretely to concerned people in society far beyond the circle of experts for confidence-building

purposes. It is SKB's opinion that a demonstration deposition of spent nuclear fuel with full freedom of choice for the future is a good way to enlist broad support for the method of disposing of the nuclear waste.

The planned demonstration deposition also means that the present-day generation is deciding for a span of time that roughly corresponds to its own active time, leaving it up to the next generation to make its own decision with as much background information as possible.

The work up until all nuclear waste in Sweden has been deposited in a closed deep repository is therefore planned to be carried out in two main phases: Demonstration deposition and final disposal. In all the work extends over a period of more than 60 years. The decision to take the step to final disposal will not be taken until after demonstration deposition has been completed, the results evaluated and other alternatives considered. These decisions lie beyond the year 2010. The plans that are discussed in this programme have to do with the activities that are required to site and build the facilities that are needed for a demonstration deposition. It is SKB's judgement that the deep repository will later be expanded to full scale. However, it is not meaningful to discuss at this point in time the details of how this will be done.

Figure 1-2 shows a timeschedule for the facilities that are needed to dispose of the long-lived radioactive waste. The following additional units will, as is shown by Figure 1-2, be needed for a demonstration deposition of spent nuclear fuel:

- Encapsulation plant for spent nuclear fuel, including a buffer store for the encapsulated fuel. The buffer store shall be able to be expanded so that it can be used as an interim storage facility if the demonstration deposition is interrupted and the canisters are retrieved.
- Deep repository for encapsulated spent nuclear fuel.
- Transportation system between CLAB and the encapsulation plant for spent nuclear fuel and between the latter and the site of the deep repository.

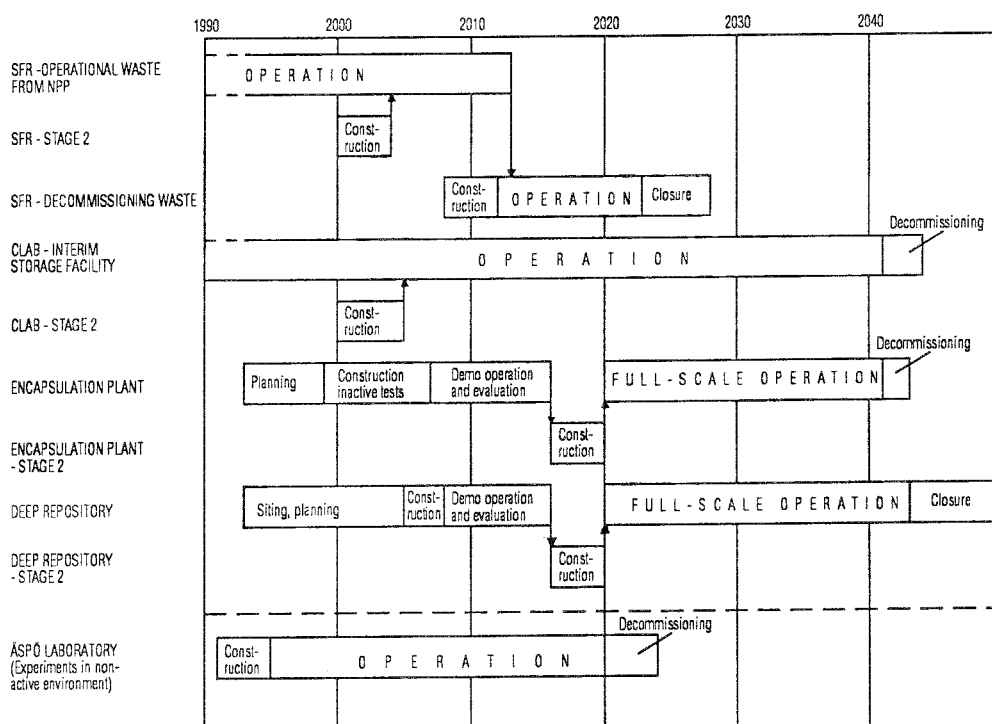

Figure 1-2. Approximate timeschedule – facilities for management of the waste products of nuclear power.

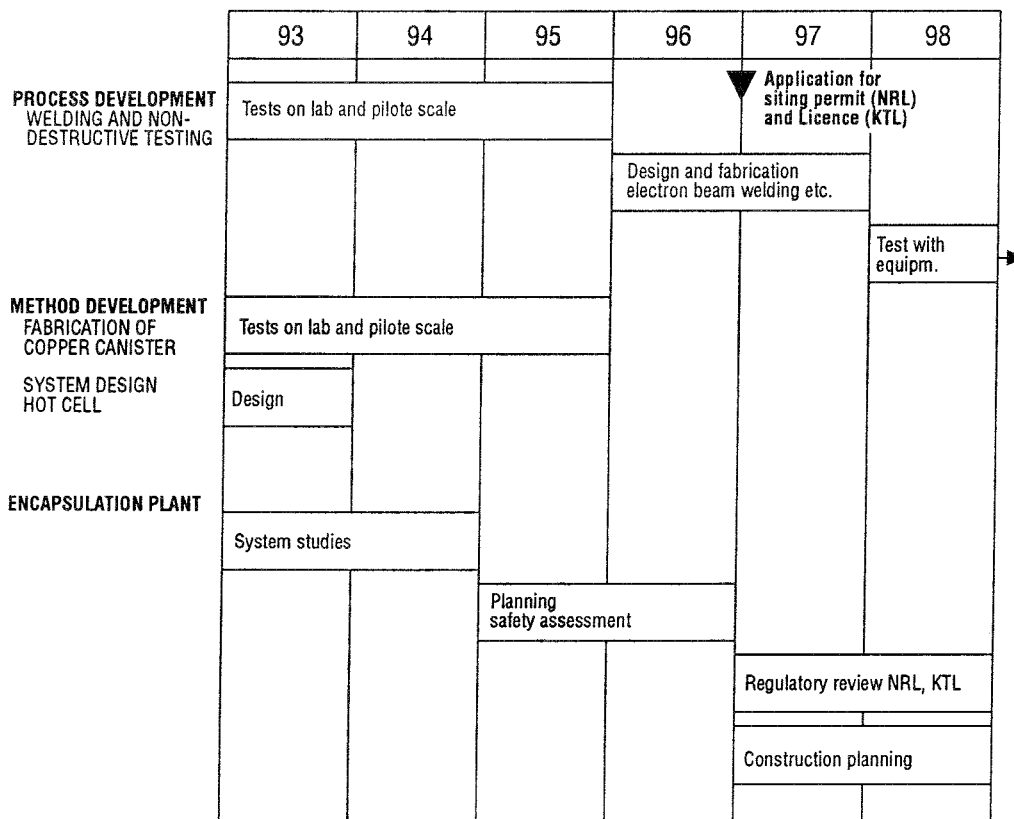

Figure 1-3. Timeschedule for encapsulation plant for spent fuel 1993–1998.

NRL = Act /1-20/ Concerning the Management of Natural Resources.

KTL = Act on Nuclear Activities

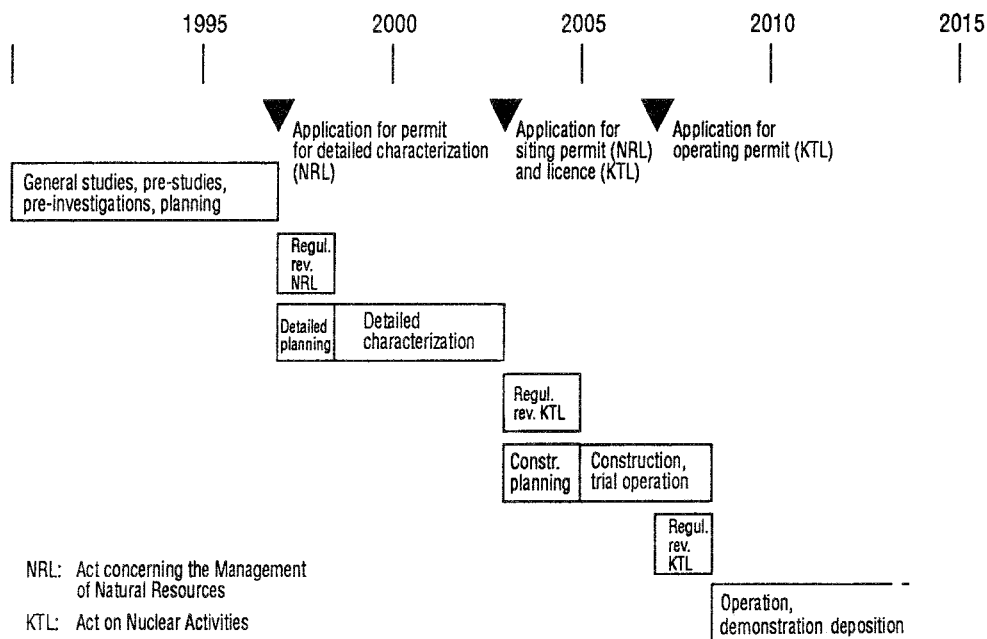

Figure 1-4. Example of timeschedule for the deep repository up to the completion of demonstration deposition. The schedule gives the earliest possible completion dates.

Figure 1-3 shows a timeschedule for the encapsulation station and Figure 1-4 for the deep repository up to the completion of demonstration deposition.

In principle, the interim storage period of 40 years can be retained for further planning even with the timeschedule for demonstration assumed here. SKB believes that the demonstration can be completed within about 20 years. Thus, as is evident from Figure 1-2, it is possible to follow this up with final disposal of the remaining fuel and waste immediately after 2020 if the decision to do so is made in about 20 years.

1.4 SITING

For the encapsulation of spent nuclear fuel, SKB plans to expand the central interim storage facility for spent fuel (CLAB) at the Oskarshamn Nuclear Power Station. The spent fuel is already being stored at CLAB, and SKB believes that expansion of CLAB with an encapsulation plant for spent fuel has clear advantages in terms of logistics, resource utilization and environmental impact. If special reasons emerge during the course of the work in favour of encapsulating at the deep repository instead, SKB will of course also consider the question of alternative siting of the encapsulation plant.

Siting and construction of a deep repository is planned to take place in stages during the 1990s and a few years into the 21st century. According to the estimates that can be made now of the time required to take decisions, carry out necessary inquiries and investigations and obtain necessary permits, demonstration deposition could be begun in about 15 years at the earliest.

The selection of candidate sites for the deep repository will be based on the fundamental requirements that must be made on a deep repository site from safety-related, technical, societal and legal viewpoints. It must be demonstrated for the selected site and selected repository system that the safety requirements imposed by the authorities are met. It must be possible to build the repository and carry out deposition in the intended manner. The siting process, the investigations and the construction work shall be carried out so that all relevant legal and planning-related requirements are met. And last, but not least, it shall be possible to carry out the project in harmony with the municipality and the local population.

An important point of departure for the planning of the siting process is the Government's decision regarding R&D-Programme 89 /1-9/. It states the following: *"The Government notes that SKB's choice of sites for a final repository will be reviewed by different authorities in connection with SKB's application for permission to carry out detailed characterization of two such sites under the Act (1987:12) Concerning the Management of Natural Resources etc., the Environment Protection Act (1969:387) and the Planning and Building Act (1987:383)."* Furthermore, the Government underscored the fact that SKB should, during the course of the siting work, furnish information to concerned national authorities, county administrations and municipalities.

Based on these guidelines, the work of siting and construction of the deep repository is planned to proceed in the following stages, see Figure 1-4:

Stage 1: General studies. Analysis of siting factors. Possible pre-studies of presumptive candidate sites. Selection of candidate sites. Pre-investigations at a couple of sites, including preliminary design. Technical and socio-economic studies. Evaluation of the results. NRL application for detailed characterization including an environmental impact statement with an initial safety assessment.

Stage 2: Detailed characterization including excavation of necessary shafts and tunnels to planned repository depth. Evaluation of the results. Safety report. Environmental impact statement. Detailed design. Application for siting permit and licence (NRL, KTL).

Stage 3: Construction and installation of equipment for handling/deposition. Final safety report. Application for operating permit (KTL).

Stage 4: Commissioning. Demonstration deposition.

1.5 PLANNED SYSTEM FOR ENCAPSULATION AND DEEP DISPOSAL OF SPENT NUCLEAR FUEL

During the period 1986–1992, SKB has studied different alternative designs of a deep repository for final disposal of spent fuel /1-10, 1-11, 1-12/.

The conclusion of the studies is that the continued work on designing a deep repository for demonstration deposition should be concentrated on one alternative. In this way the desired concentration and goal orientation is achieved in the development and planning work.

Of the canister alternatives studied, the composite canister holding 12 BWR assemblies is chosen as the main alternative for the continued work, see Figure 1-5. This canister consists of a steel container, which provides mechanical protection, sur-

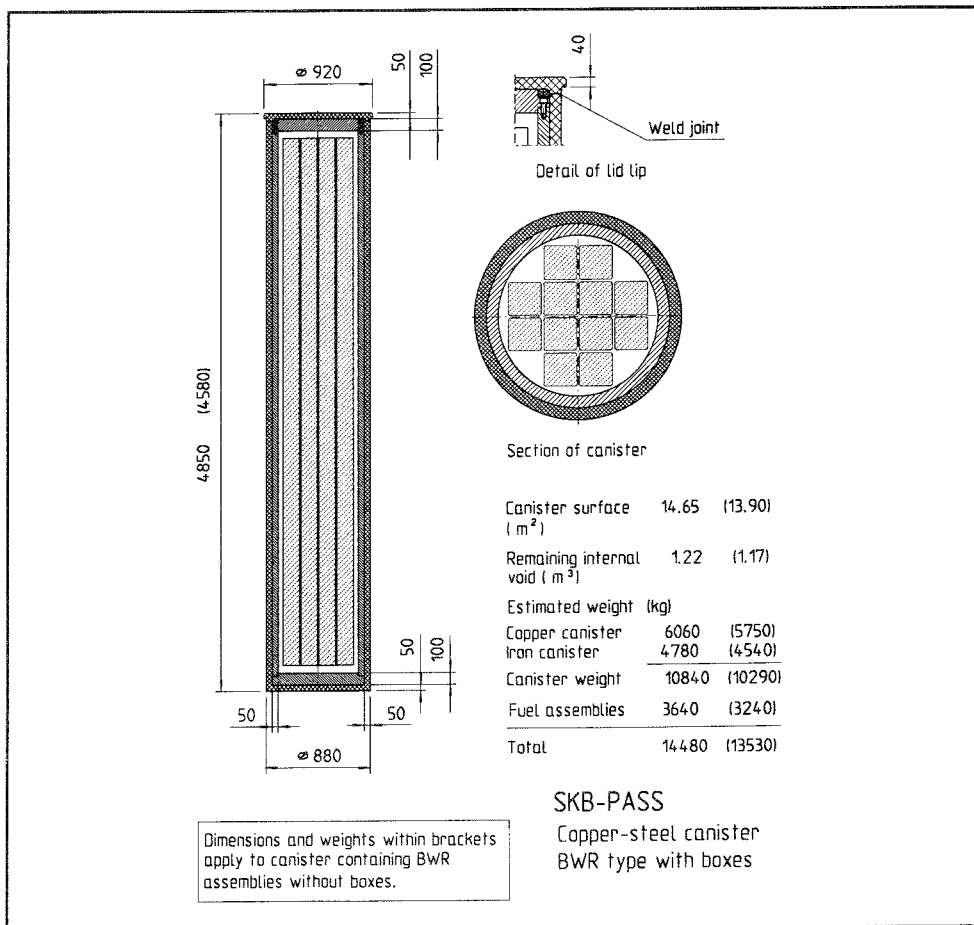

Figure 1-5. Composite canister.

rounded by a copper container, which provides long-lasting corrosion protection. Since the canister is a vital barrier, some additional development should be conducted for the alternative of a lead-filled copper canister as a reserve alternative to the composite canister.

Of the studied repository designs, the KBS-3 design is kept as the main alternative for further work. In connection with adaptation to local conditions on the selected site, this design can be further optimized, whereby technically closely-related variants of the design can be given further consideration.

1.6 OUTLINE OF THE RD&D-PROGRAMME

Two main activities are required in the development work in order to carry out a demonstration deposition of spent nuclear fuel in a deep repository: encapsulation and deep disposal. Safety assessments and supportive research and development are also required.

The encapsulation work entails final selection and testing of methods for fabrication, sealing and quality inspection of canisters, as well as design, construction, licensing, installation, trial operation and operation of a facility for encapsulation. The work of deep disposal entails siting, design, construction, licensing, installation, trial operation and operation of a facility and equipment for demonstration deposition in a deep repository.

The supportive R&D work entails further development of methods, models and data within the areas of spent fuel properties, geoscience, chemistry, materials and biosphere aimed at

- further refining the knowledge base and skills in modelling of processes that are important for the performance of the repository in order to better be able to quantify uncertainties and safety margins,
- following up of international developments in relevant fields.

The research is planned so that a continuity is obtained in the work and an updating of the knowledge base and analysis methods is done in good time before major assessments of performance or safety. Much of the supportive RD&D work will be concentrated to the Äspö Hard Rock Laboratory. Another important support for further development of the safety assessment is further studies of spent fuel properties and natural analogues.

Besides work that comprises direct support for the main line – deep repository for demonstration deposition – some follow-up of alternative methods and systems for disposing of spent fuel is planned so that knowledge of these will be retained and further refined. In this way a basis will be created for the future evaluation of such systems in comparison with what is being demonstrated in Sweden. In addition, work is planned on other long-lived waste as well as for SFR and for decommissioning of nuclear power plants.

An important part of the RD&D-programme is international cooperation, which is extensive and takes place in several different forms.

1.7 OUTLINE OF THE BACKGROUND REPORT

The present background report to RD&D-Programme 92 “Detailed R&D-Programme 1993–1988” gives a detailed description of the state-of-the-art and future plans for safety assessments and supportive research. The technical development that is re-

quired for the construction of the encapsulation station and the deep repository for demonstration deposition is also described. References to specific background material are also given in the text. In addition, an account of the situation within SKB's different fields of activity is given in the 1991 Annual Report /1-13/.

Chapter 2 describes the need for performance and safety assessments occasioned by the above plans for activities. Methods and models for the assessments are discussed, and the programme for the further development work deemed necessary during the coming 6-year period is presented.

Against the background of the timeschedule for safety reports etc., an account is given of the state-of-the-art, goals and planned work during the period with regard to the engineered barriers

- spent nuclear fuel in chapter 3,
- canister material in chapter 4, and
- buffer and backfill material in chapter 5.

State-of-the-art, goals and planned work within the geosciences for

- groundwater movements,
- bedrock stability and
- geohydrological and rock mechanical calculation models

are presented in chapter 6. Since many experiments and studies in the field have been concentrated to the Äspö Hard Rock Laboratory, frequent cross-references are provided in this chapter to a separate background report on the Äspö programme /1-14/.

Chapter 7 describes the situation within the chemistry programme, with separate sections on

- groundwater and geochemistry,
- radionuclide chemistry and
- validation of processes in transport models and radionuclide migration.

Within the chemistry programme as well, a large portion of the field activities are being conducted in the Äspö Hard Rock Laboratory.

The study of such natural conditions as constitute analogues in certain respects to important chemical sorption and transport processes in a deep repository is presented in chapter 8 – Natural Analogues. The state-of-the-art and activities aimed at further refining field instruments and measurement methodology within geology, geohydrology and groundwater chemistry are presented in chapter 9.

The state of knowledge concerning radionuclide transport in the biosphere and modelling of the same, as well as resulting doses to man, are described in chapter 10. Chapter 11 describes R&D efforts associated with the development of technology that is required for repository construction, excavation of tunnels, deposition of waste and possibly necessary retrieval of canisters, as well as backfilling and sealing of the repository. See also the special background report for the siting project /1-15/.

The report concludes with chapter 12, which describes the work for so-called "other waste", i.e. waste from the research activities in Studsvik, core components and reactor internals and waste from operation and decommissioning of the encapsulation plant.

The plans within the field of decommissioning of nuclear facilities and management and disposal of this waste have been described in chapter 15 of the main report. Since these activities will not be carried out until after 2010, they are not dealt with in this report.

2 SAFETY ASSESSMENTS

2.1 GENERAL

Nuclear activities must be carried out in an acceptable manner with respect to safety and radiation protection. Safety is judged with the aid of performance and safety assessments. The performance assessments comprise studies of sub-systems and their chemical or physical interaction in their environment. External and internal environmental conditions under which performance or safety is to be evaluated are elucidated in scenario analyses. Scenario analyses and performance assessments comprise parts of the total safety assessment. The results shall be expressed in terms that agree with acceptance criteria established by the authorities.

For radioactive waste, the safety of the scheme must be demonstrated for both an active handling phase – operating safety, including e.g. conditioning, storage, transportation and deposition of the waste – and a passive post-closure phase after the final repository has been sealed – long-term safety.

Methods and routines for safety assessment of systems in active operation have been developed, and are still being refined, within the nuclear power industry. They have previously been employed in connection with the licensing of the transportation system, CLAB and SFR.

The link between operating safety and long-term safety consists of the quality of the engineered barriers and of the probability and scope of possible undetected fabrication defects.

Assessments of long-term safety have different purposes during different phases of the development of a final repository. In an initial phase, the performance of the sub systems of the repository is evaluated in order to create understanding and to provide a basis for design studies. The uncertainty in the knowledge base for essential functions gives priorities for research and development. In a later phase an attempt is made to achieve a balance between the safety barriers, i.e. the system must be balanced with respect to function and cost at an acceptable safety level. The assessments are then a tool for alternative comparisons and for evaluating the design or execution of the repository or its barriers. Finally, in the licensing phase it must be demonstrated in a formal manner that the system satisfies society's demands on safety.

An integrated safety assessment is an important tool for clarifying the composite safety effect of the different barriers and for evaluating the need for additional measures.

The assessments of both operating and long-term safety provide some of the background material for SKB's decisions and choices, for the regulatory authorities' assessment of the progress in SKB's R&D work and for the regulatory authorities' rulings on permit applications.

As is evident from chapter 1, SKB's programme is currently in a phase where the fundamental studies of feasibility and safety have been concluded. The review of different alternatives for disposal has led to a narrowing of the focus of the work on a preferred design of canisters and repository. Methods for site characterization and safety assessment have been developed so that they can provide a basis for evaluating the safety of repository sites and for deciding how the repository should be configured

in the bedrock in order to take effective advantage of the site's natural safety features. The recently completed safety assessment SKB 91 /2-1/ showed that the properties that must exist in the rock on a candidate site to ensure long-term safety do not differ significantly from those that normally exist in the crystalline basement rock.

The need for coming safety and performance assessments is presented below, along with the questions that need to be answered in various phases of the planned development. On this basis, the goals of the activities within the area of safety assessment are presented for the next 6 years. Subsequently, the state-of-the-art is examined for scenarios, for modelling in the near field, far field and biosphere, and for acceptance criteria. The chapter is concluded with a presentation of the programme under the same headings.

2.2 GOALS

2.2.1 SKB's timeschedule and the need for safety assessments

SKB's timeschedule, see chapter 1, calls for the siting of a deep repository for demonstration disposal to commence in 1993 at the earliest. The goal is to be able to submit an application for a permit for underground detailed characterization in around 1997. An application for a siting permit (NRL) and a licence (KTL) for the deep repository will be submitted in around 2003, and an application for an operating permit for demonstration deposition will be submitted in around 2007.

In parallel with this, supplementary development will be carried out, along with planning, design and construction of an encapsulation station for spent nuclear fuel with the capacity to fabricate the canisters needed for the demonstration deposition. An application for a siting permit and an environmental licence for this facility is planned to be submitted in around 1997.

The different permit and licence applications will pertain to facilities with a size and capacity that correspond to the needs of demonstration deposition. The safety assessment will also give an account of safety in connection with expansion to full size and capacity.

Pre-investigations of candidate sites

A pre-investigation of a candidate site for the deep repository aims at determining conditions and properties in the bedrock of importance for constructability, safety, emplacement of the repository and planning of possible continued detailed geological characterization.

Modelling of performance and safety during this phase is planned to be carried out step-by-step in close connection with the site characterization. The model calculations shall gradually provide a basis for

- identifying elements in the bedrock that are of special safety-related interest – for example dominant flow paths for groundwater or discharge areas – for further characterization,
- emplacing the repository and other facility sections within the studied area in an optimal manner from the viewpoint of safety,
- determining how data that emerges gradually during the pre-investigations influences the picture of the area,

- evaluating the importance of the uncertainty in the data and interpretations for safety and constructability,
- compiling an initial safety assessment of a final repository on the site.

A general regional geohydrological modelling is foreseen in an early phase of the site studies as a basis for a delimitation of the pre-investigation area. When the orientation of the fracture zones has been mapped and a number of boreholes have been drilled in the most interesting rock blocks, a modelling will be conducted to identify the principal flow paths as a basis for a repository layout and the continued drilling programme. In parallel with the investigations, a number of modellings will be performed where previous data are supplemented/replaced with site-specific data. Light will be shed on the importance of any differing interpretations of the extent of the zones, etc. Towards the end of the period, i.e. 1996, an integrated safety assessment will be performed with the relevant waste inventory, near field, suitable situation and configuration of the repository as well as relevant biosphere conditions on the candidate sites.

It shall be possible to adapt the pre-investigation programme to data and modelling results obtained. Judgements of how sensitive the performance of the site is to uncertainties in the data may occasion supplementary investigations.

The need for a gradually more detailed geohydrological modelling from 1993 to 1995 and completed site-specific safety assessments in 1996 will define time frames for the further refinement of analysis models and analysis methods discussed in section 2.4 below.

Detailed site characterization

A permit under NRL for detailed characterization is expected to be ready by around 1998. The detailed characterization is expected to describe the bedrock at repository depth at a level of detail that permits a much more detailed modelling of the geological conditions in the canisters' near fields, and of the effect of the tunnel system and the excavation work on the flow of water in the rock. This in turn provides the premises for an evaluation of the need for reserve spaces for the repository and of the need for plugging in access ramps, tunnels and shafts, and of potential positions for the plugs.

The necessary further development of data and methods for analyzing these factors must be initiated during the coming six-year period in order to be able to be applied in a new integrated safety assessment just before the year 2000. This assessment will be based on data from the characterized site, as well as on construction and deposition procedures defined in conjunction with the planning and designing of the deep repository for demonstration deposition.

Encapsulation station

Pre-studies for an encapsulation station will be commenced in 1993 and will be aimed at having an application for a siting permit and an environmental licence ready in 1997. The safety studies will be conducted as an integral part of system design and production of design documentation. An account of safety will be furnished in the form of a preliminary safety report dealing with the operating safety of the encapsulation process and the quality that can be achieved in fabrication and inspections. A final safety report on encapsulation shall be ready for submission together with the application for an operating permit for the facility, i.e. in about 2007.

The quality of the encapsulation process is one of the factors considered in the preliminary assessment of the performance of the near field in the safety assessments for the candidate sites.

2.2.2 Goals for the period 1993–1998

The goals of measures within the field of performance and safety assessment are as follows:

- during the pre-investigation phase of candidate sites, i.e. during the period 1993–1996:
 - to carry out analyses and evaluations of conditions of importance for constructability and the performance of the site as a protective barrier as a basis for continued site characterization and emplacement of the repository;
 - to carry out safety assessments during 1996 for site-adapted final repository facilities on two candidate sites, to a quality standard that is required for permit application under NRL for the detailed geological site characterizations;
 - to evaluate during the period the need for further method development in preparation for future performance and safety assessments in accordance with SKB's general timeschedules, and to begin this method development.
- during the planning and design of the encapsulation plant, and during the siting and design of the deep repository for demonstration deposition, i.e. up to about 1998:
 - to carry out an initial safety review of the encapsulation process in connection with the system studies;
 - to broaden and augment this to a level of detail required for an application for a licence under KTL for the encapsulation plant by 1997;
 - to carry out a safety assessment of transportation, handling and deposition of the spent nuclear fuel and other waste (including possible retrieval and subsequent storage) by 1996, coordinated with the studies for the encapsulation plant and the pre-investigations on the candidate sites.

After the ensuing 6-year period, safety reports for the deep repository shall comprise a basis for planned applications for a siting permit and an environmental licence in about 2003 and a permit for operation of the encapsulation plant and the deep repository in about 2008.

Planning and design of the repository for other long-lived waste will not begin until after demonstration deposition has commenced, i.e. not until after 2010.

Performance and safety studies on the candidate sites are conducted as integral parts of the site characterization. Similar studies for encapsulation are conducted as integral parts of system design and planning/design of the encapsulation station.

2.3 PRESENT-DAY STATE OF KNOWLEDGE

2.3.1 Overview

General

A safe handling and disposal of the nuclear waste aims at protecting man and the environment from harmful effects, both now and in the future, regardless of national boundaries. Safety assessments, as well as assessments of the long-term performance of individual safety barriers, shall shed light on the capacity of the repository to retain radionuclides to such a degree that the safety requirements of society are met.

Methods for performing long-term safety assessments for radioactive waste have been developed over a period of nearly two decades and applied in a number of large summarizing reports. The method development has been tailored to the needs of the national and international programmes for management of wastes from nuclear energy production.

Through the years, the analysis methods have been applied, and further refined, in a large number of integrated safety assessments in Sweden and other countries. Among the assessments of final disposal of long-lived waste that have been done in recent years, the following can be mentioned: KBS-3 /2-2/, Project 90 /2-3/ and SKB 91 /2-1/ in Sweden and Projekt Gewähr /2-4/ in Switzerland for repositories in crystalline bedrock. Other assessments were carried out in the PAGIS project within the EC /2-5/ encompassing salt, clay, shale and granite, at the Waste Isolation Pilot Plant in the USA for salt /2-6/ and at Yucca Mountain by the USDOE for tuff /2-7/. Furthermore, an international study has been conducted under the auspices of the OECD/NEA of the feasibility of disposing of high-level radioactive waste into the seabed /2-8/. A safety assessment of the Canadian design of a final repository for spent nuclear fuel is currently in progress, as are updates of previous assessments of disposal schemes for spent nuclear fuel in Finland and reprocessed waste in Switzerland.

Assessments for low- and intermediate-level waste (LLW and ILW) in rock have been performed and approved by the regulatory authorities for SFR in Sweden /2-9/ and for VLJ in Finland /2-10/. The safety assessments for the Konrad Mine in Germany are under review. Beyond these, a number of studies have been conducted in different countries regarding shallow ground disposal of radioactive waste.

An overview of the field of performance and safety assessments in general, with a special elucidation of certain essential areas in particular, is given below. The need for model-specific further refinement is discussed in section 2.3.2 and following.

Collective opinion

In 1990 the OECD Nuclear Energy Agency reviewed available methods for assessing the safety of systems for final disposal of radioactive waste and experience from the application of such methods to different disposal principles and in different geological environments /2-11/. A collective opinion was issued by the OECD/NEA's Radioactive Waste Management Committee and the IAEA's International Radioactive Waste Management Committee /2-12/.

To begin with, they pointed out that a correct and adequate understanding of proposed repository systems is a prerequisite for being able to conduct meaningful assessments, and noted that an important task for the future is to obtain and analyze site-specific data from proposed repository sites. They further observed that significant progress has been made in our ability to conduct safety assessments, that quantitative judgements will also contain elements of qualitative judgements, and that a further refinement of the assessment methods can and will take place as a consequence of ongoing research.

With this in mind, the two committees confirmed

- that safety assessment methods are available today to evaluate adequately the potential long-term radiological impacts of a carefully designed radioactive waste disposal system on humans and the environment, and
- that appropriate use of safety assessment methods, coupled with sufficient information from the proposed disposal sites, can provide the technical basis to decide

whether specific disposal systems would offer to society a satisfactory level of safety for both current and future generations.

This collective opinion was also supported by the CEC Experts for the Community Plan of Action in the Field of Radioactive Waste Management.

SKB 91

In 1992, SKB published a safety assessment, SKB 91 /2-1/, for the purpose of, firstly, clarifying the safety-related importance of the bedrock on the disposal site, and secondly, establishing a practical methodology for the safety-related evaluation of candidate sites. The material consists largely of an account of the present-day state of knowledge.

Methodological innovations in this assessment, compared with previous Swedish assessments, are the ability to systematically utilize both generic and site-specific data, the ability to take into account the extent of the repository in space and the fact that the modelling of the groundwater's flow in the bedrock is done taking into account the uncertainty entailed by the natural variability in the properties of the rock.

The SKB 91 safety assessment shows that a repository excavated deep down in the crystalline basement and with long-term-stable engineered barriers satisfies the safety requirements proposed by the authorities with ample margin. The safety of such a repository is dependent only to a small extent on the capacity of the host rock to retard and sorb leaking radionuclides. The primary function of the rock is to provide stable mechanical and chemical conditions over a long period of time so that the long-term function of the engineered barriers is not jeopardized.

SKB 91 has shown that the safety-related demands that must be made on a site where a final repository is to be built are such that they are probably satisfied on most sites SKB has investigated in Sweden. The assessments also show that there are a number of factors that can be crucial for how well the bedrock serves as an extra safety barrier. Examples of such factors are the presence and location of flat-lying structures and their hydraulic conductivity.

SKB 91 offers an example of how performance and safety assessments can be used to shed light on the importance of different geological structures in a potential repository area and to clarify factors that are essential from a safety viewpoint. The methodology can be utilized in a siting process to configure the repository so that the rock's capacity to contribute to the safety of the repository is utilized in an effective way. This, however, requires access to site-specific data which can be updated continuously as the safety assessments progress.

Uncertainties

Assessments of the safety of a final repository for spent nuclear fuel have achieved a high degree of refinement, realism and richness of detail in their description of the processes and in their modelling. Nevertheless, the assessments are still hampered by uncertainties of a qualitative, conceptual nature as well as of a quantitative, numerical nature. Internationally, attempts are being made to categorize the uncertainties into scenario uncertainties, uncertainties in the conceptual models, parameter uncertainties, etc., in order to facilitate their handling. The borderlines between the categories are fluid, however. All uncertainties ultimately derive from the knowledge gaps that still exist.

In SKB 91, SKB describes a number of ways to deal with uncertainties by means of quantitative uncertainty analysis. An important factor is judged to be the uncertainty in the large-scale hydrology that is caused by the spatial variability of the hydraulic conductivity in combination with the fact that the conductivity is measured only in a limited number of points. This variability is so great that the use of mean values cannot be considered justified. A stochastic continuum model was used for the groundwater flow in SKB 91 in order to quantify these uncertainties. The emplacement of the fraction of canisters that has been assumed to be initially defective has also been dealt with probabilistically in order to quantify the resultant uncertainty.

The importance of uncertainties related to the properties of the site and geologically based judgements of the locations and properties of structures was dealt with in SKB 91 by means of a comprehensive sensitivity analysis within the framework of the variations of the properties of the site that were studied. Redox conditions in the near field, uncertainties in transport parameters, uncertainties in future hydrological conditions in conjunction with glaciation and permafrost, uncertainties in salinity conditions etc. were studied with the aid of sensitivity analyses.

Quality assurance

A formal system for the organization of data and models used in the assessment was tested in conjunction with SKB 91. The emphasis was on documentation of input data and traceability. The test yielded experience of value for future assessments.

Acceptance criteria

Since the end of the 1980s, SKI and SSI have, together with other Nordic nuclear safety authorities, worked to prepare a joint document on principles and acceptance criteria for the long-term final disposal of high-level radioactive waste. The document is intended as a recommendation that can serve as a basis for national regulations. SKB has been given an opportunity to follow the work and comment it.

In SKB 91, these Nordic principles have been utilized to relate the results of the assessments to acceptance criteria. SKB assumes that this work will continue so that the safety requirements will have been adopted before the siting work enters a formalized licensing phase.

Operating safety

For radioactive waste, the safety of the nuclear activities must be demonstrated for both an active handling phase – operating safety, including e.g. conditioning, storage, transportation and deposition of the waste – and a passive post-closure phase after the final repository has been sealed – long-term safety.

The methods and routines for safety assessment of systems in active operation that have been developed within the nuclear power industry are well refined and tested. They have previously been employed in connection with the licensing of nuclear power stations, the transportation system, CLAB and SFR and are deemed adequate for the assessments for a licensing review of the handling of radioactive waste according to the planned system design.

A body of technical experience exists from previously safety-reviewed nuclear installations. This will provide good guidance for most of the handling and the measures that are adopted in the encapsulation plant, in the transportation system and in connection with the demonstration deposition in the deep repository. A number of

operations are, however, untried, and development activities have been planned as a support for their design and planning. The development activities concern:

- Electron beam welding of the canister's copper shell.
- Selection of material for possible post-filling of the canister.
- Fabrication inspection and non-destructive testing.
- Excavation of deposition positions, emplacement of canisters and post-emplacment inspection.
- Backfilling of tunnels.

The assessment of operating safety in the deep repository will also include the handling procedures required for a possible retrieval and interim storage of the waste deposited during the demonstration phase.

Certain development activities for alternative handling methods will be conducted in parallel with the planning of the preferred system design. The thrust and scope of these activities are described in connection with the relevant subject area in this background report.

The link between operating safety and long-term safety consists of the quality obtained for the engineered barriers or the probability and extent of possible undetected fabrication defects.

Other long-lived waste

Some waste forms are not intended to be disposed of in the repository for spent nuclear fuel. Examples are certain parts of the reactor core such as fuel boxes, control rods, start neutron sources etc. Other waste types may originate from industry and hospitals.

Safety assessments for the final disposal of these wastes and facilities can be based to some extent on models and methodology developed for the repository for spent nuclear fuel or SFR. Depending on the waste type and conditioning, however, further development may be needed, especially with regard to scenarios and models for chemical speciation and nuclide transport.

A systematic review of different waste forms and how they are to be distributed between different repositories will be carried out during the coming 3-year period.

2.3.2 Scenarios

To be able to judge how future changes of a repository's external and internal environment will affect safety, all relevant combinations of possible changes must be examined and ranked in order of priority. Since the number of processes and events that could affect a repository in the future is very large, a systematic methodology must be developed to enable an overall picture to be gained and scenarios to be ranked (screened).

A joint project between SKI and SKB started in 1988 to explore possible means to systematically process information on the repository system's fundamental features, future "sudden" events and processes occurring in the system (Features, Events and Processes, FEPs), and to develop and screen relevant scenarios /2-13/. The project, which also made use of foreign expertise for certain tasks, resulted in the creation of a database for a number of FEPs (about 150). The process of creating relevant scenarios in the final phase of the project proved to be dependent on a considerable measure of "expert judgement".

An important question in scenario analysis for a repository is how it can be demonstrated that no phenomena or environmental factors of importance for the safety of the repository have been overlooked. To obtain the best possible comprehensiveness in the assessment, the background material for the choice of scenarios must be continuously updated. Broad international collaboration within the field of scenario analysis will be of great value in staying abreast of new approaches and ideas, and in order to arrive at a consensus on the proposed scenarios and the methodology that has been used in developing them.

A number of scenarios were dealt with in SKB 91:

- The importance for safety of changed data for different site-specific geological conditions (Features) has been examined.
- A general description of a glaciation scenario has been compiled together with TVO in Finland /2-14/ and its importance for groundwater flows and differential rock movements has been discussed.
- The importance of colloids and complexing agents for transport with the groundwater has been defined.
- The importance of different assumptions concerning future acidification for the safety of the deep repository has been examined.

The OECD/NEA has proposed that an international database for FEPs should be set up. SKB intends to participate in and support this work during the programme period.

2.3.3 Modelling of transport in the near field

The state of knowledge within near-field modelling is evident from the safety and performance assessments presented in SKB 91 and PASS /2-1, 2-15/. A summary is given below.

The calculations of nuclide transport in the near field in SKB 91 were carried out for the most part with the integrated near-field code Tullgarn /2-16/. Tullgarn is a further development of the PROPER sub-model NEAR21 /2-17/. The processes taken into account by the model are:

- Radioactive chain decay.
- Three canister penetration mechanisms:
 - initial defect,
 - build-up of internal helium pressure,
 - corrosion.
- Fuel dissolution. Matrix dissolution is calculated according to the model for fuel corrosion presented in section 3.2.3 with an effective G value expressed as the number of transformed UO₂ molecules per 100 eV, calculated for the total α -activity.
- The transport calculations are performed with a coupled resistance network /2-18/, where the transport resistances in the near field are described as coupled resistors, see Figure 2-1.

Tullgarn calculates the steady-state outward transport of radionuclides from the fuel surface through a hole in the canister, where R3 is the transport resistance offered by the limited area of the hole and R2 is the diffusion resistance in the hole, via diffusion through the buffer (R4) to a fracture in the rock (R6) or axial diffusion (R7) to the disturbed zone (R8). The code can also calculate diffusion through the rock matrix if the fracture should be sealed with bentonite (R5). The leakage of the gap and grain boundary inventory is modelled differently depending on the type of canister defect. If the canister has an initial defect, the gap and grain boundary inventory is dissolved

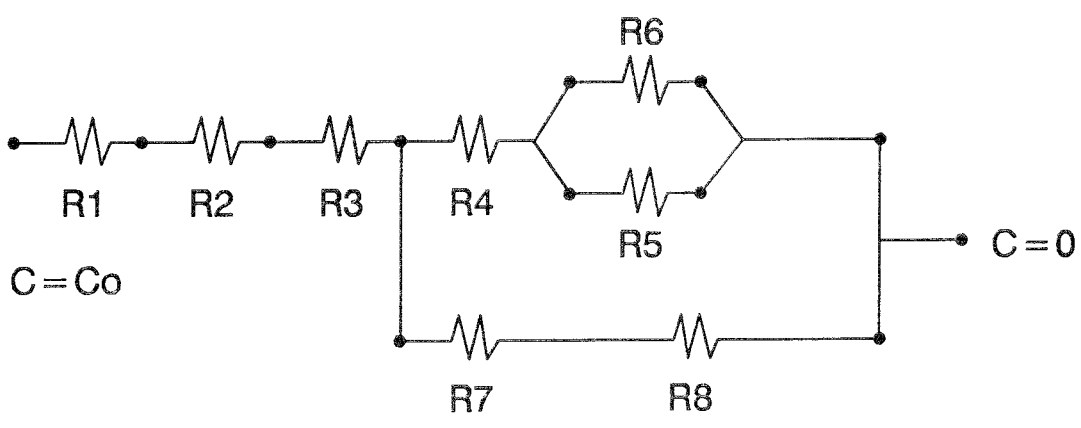
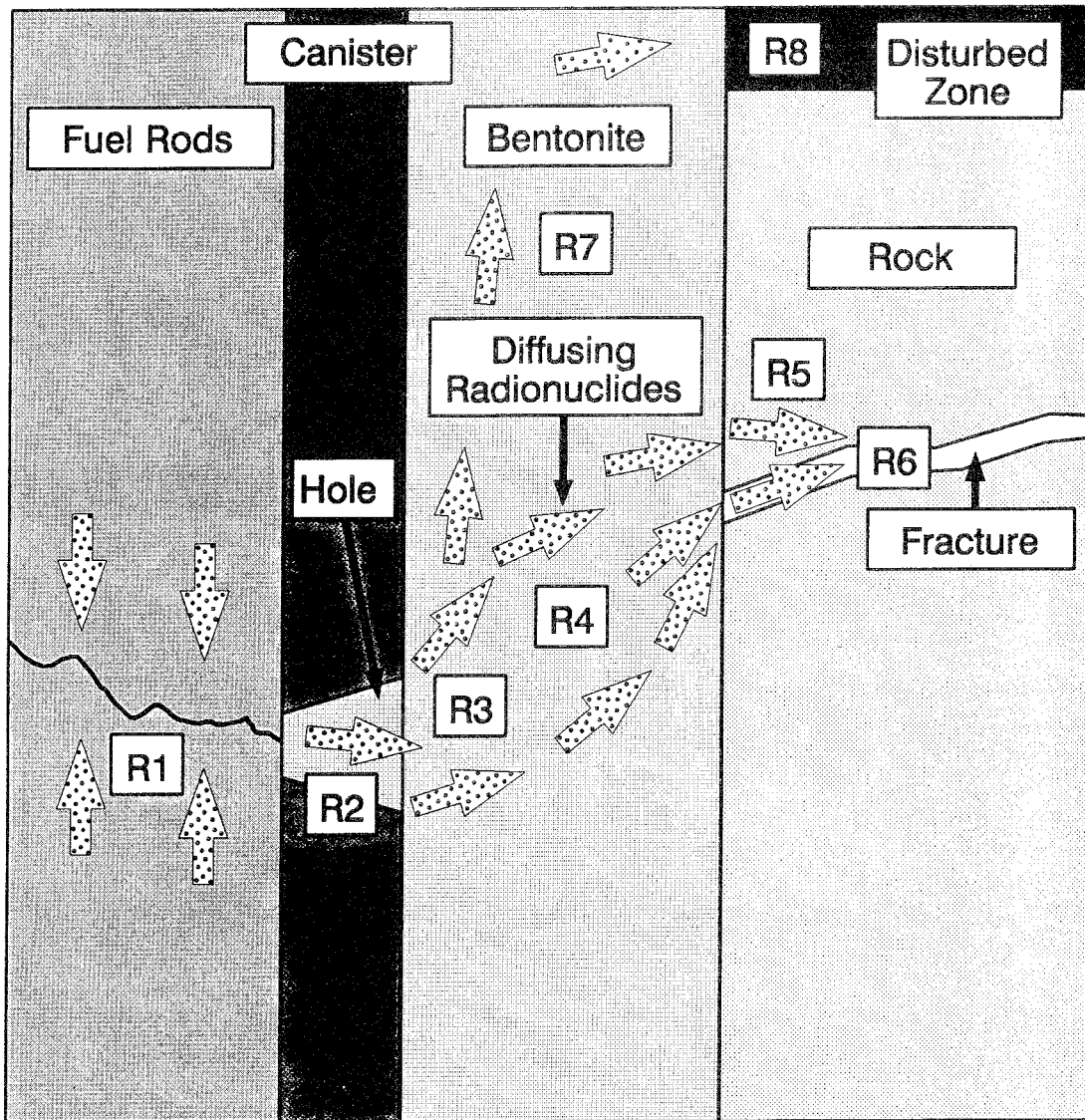

Figure 2-1. Resistance network model for radionuclide transport in the near field. R1, R2 and R5 have been neglected in the calculations for the initially defective canister. In other cases, R3 has also been neglected.

in the canister's void volume and then released with the calculated Q_{eq} . In cases where the canister's transport resistance is neglected (corrosion or pressure damage), the inventory is dissolved in the buffer's volume and is then released with Q_{eq} (in this case the transport resistance in the hole is neglected). The transport resistance inside the canister is neglected entirely for the present.

Tullgarn does not take into account the transient phase of the outward diffusion of radionuclides after canister penetration, which can give pessimistic results for certain nuclides. In order to shed light on the importance of the transient diffusion, a simplified near-field calculation was performed in SKB 91 with TRUCHN, an integrated finite difference code developed from the heat transport code TRUMP /2-19/. The results /2-20/ show that the transient period is very important for the nuclides that sorb strongly in the bentonite (e.g. the actinides).

To take into account the transient diffusion, development of a compartment model /2-21/ is currently under way. This model divides the complex geometry of the near field into a number of compartments. Each compartment is characterized by its volume (capacity) and a number of transfer flows to and from other compartments. The model has been tested with Pu-239 as an example. Work on verification of the code is currently in progress. The plans are to use the compartment model as a complement to Tullgarn.

Development of a computer program that can model coupled geochemistry/transport and handle sharp reaction fronts is in progress /2-22/. The model has been tested on the redox front in Poços de Caldas. The development work is expected to be finished during 1992.

Geochemical modelling

The geochemical computer program that is most general is the EQ3/6 package, designed by Wolery /2-23/. This program is ready to be used and is implemented on SKB computers. It has been used with success on a number of occasions to simulate both field and laboratory tests. EQ3/6 has also been used to carry out the radionuclide solubility calculations in SKB 91 /2-24/.

To strengthen confidence in the geochemical modelling, validation of selected important parts of the geochemical database has been pursued for a number of years. The results are validated databases for uranium /2-25/, plutonium /2-26/ and technetium (the report for the latter is not yet published).

2.3.4 Modelling of transport in the far field

A review of the state of knowledge for groundwater modelling is provided in section 6.2. Many aspects of radionuclide transport in fractured rock are also dealt with in the chemistry section, chapter 7. Chemical data are presented in section 7.2 and processes in section 7.3. It is the task of the safety assessment to tie together the models for different essential processes into calculation models for transport in the far field. These models shall be sufficiently detailed to take into account all important phenomena that control what happens in the far field, but at the same time sufficiently simplified so that total system analyses for the final repository can be carried out.

A detailed account of most of the calculation models used by SKB for groundwater movements and radionuclide transport is provided in chapter 8 of the SKB 91 report /2-1/. Different conceptual models and strategy for modelling of transport in the far field are discussed there. The following section therefore provides only a brief

summary of the models used, together with some supplementary information on the models not utilized in SKB 91.

One of the demands on the calculation model to be used in SKB 91 was that it should be possible to take into account the spatial variability in the hydraulic properties of the rock. Modelling was therefore done with a stochastic continuum model, HYDRA-STAR /2-27/. Using the Monte Carlo technique, realizations of the conductivity and potential fields were generated conditional upon measured borehole data. Furthermore, a deterministic continuum model, NAMMU, was used for large-scale modelling of the groundwater's movements and for generation of boundary conditions for HYDRASTAR /2-28/.

Furthermore, the calculation program PHOENICS was used for modelling of the coupled problem with salt transport and groundwater flow /2-29/. PHOENICS has also been used for a number of analyses within the Äspö project.

It was not deemed possible in SKB 91 to use a "discrete fracture" model for simulations of the groundwater flow in a block on the order of 25 km³ conditional upon the local fracture patterns around each measurement section. The method as such and its application are discussed in section 6.4.2. FRACMAN/MAFIC /2-30, 2-31/ has been used for the modelling that has been done.

Observations in rock of the channelling of the water flow and rapid transport pathways have also led to the development of special channelling models for simplified calculation of nuclide transport, e.g. in the safety assessment for SFR.

Mixing between channels can be foreseen for large-scale calculations, and for this purpose a stochastic model consisting of a network of channels has also been developed /2-32/. Thus, it is the water-conducting channels and not the fractures in the rock that constitute the basis for the model.

2.3.5 Modelling of dispersal in the biosphere

Dispersal in the biosphere is affected by a large number of processes and changeable data. The modelling is therefore handled with very general compartment models, coupled to multiplicative models for uptake in biota and dose calculation /2-33/.

SKB has almost exclusively used the program code BIOPATH in combination with the program system PRISM for uncertainty analysis. These codes have been compared with others in the international studies BIOMOVs /2-34/, VAMP /2-35 and PSAC /2-36/ and found to be reliable.

A truly realistic biosphere model is difficult to achieve. The conceptual models that have been used are encumbered with both uncertainty and variation in input data /2-37/. The structure varies with time and can furthermore be difficult to predict. A number of schematic biospheres have been defined in SKB 91 /2-1, 2-38/. The uncertainties in resulting dose conversion factors that are dependent on the variability in input data have been described for a central case.

2.4 PROGRAMME 1993–1998

2.4.1 Performance and safety assessments

According to the goal description, a number of performance and safety assessments will have to be carried out in connection with planned pre-investigations and facility planning and design.

In the SKB 91 safety assessment, models for source term, barrier functions, ground-water transport, nuclide dispersal and dose were coupled together into a total safety assessment. Experience from the performance of this assessment, and the quality control associated with the assessment, are under evaluation and will provide a basis for the further refinement of applied procedures and methods. This further refinement will be carried out with a view towards the need for the future modelling of performance and safety in conjunction with the characterization of candidate sites.

The work planned for the further refinement of methods and models is described under the headings

- scenarios,
- near field,
- far field, and
- performance and safety assessments.

Modelling efforts within the biosphere are presented in chapter 10.

2.4.2 Scenarios

During the period 1993–1998, SKB will further refine the method for systematization of scenario development that was initiated through the SKI/SKB project. The work on augmenting and updating the database and creation of visual diagrams and links between different processes and events has already begun. This work will continue in cooperation with modellers and experts within different subject areas to initiate augmentation of the models that are used in the calculations within the safety assessment.

Certain possible future events falling into the category of human intrusion have already been pointed out as being of such importance that they should be dealt with separately. The OECD/NEA has appointed a working group that is working with these questions from an international perspective. SKB is participating in this working group.

Certain FEPs will be heavily dependent on the quality control and fabrication methodology that will be used for the different parts of the repository. These FEPs need to be looked over at the point when the system's layout, material selection, construction sequence etc. are finally settled on.

2.4.3 Near field

Models for radionuclide inventory and residual heat

The radionuclide inventory and the residual heat can be calculated with sufficient accuracy with the aid of currently available models and databases. No efforts are planned during the period.

Models for nuclide transport

The models that are used for radionuclide transport in the near field in SKB 91 meet the demands that can be made on safety assessments that are to be carried out within the program period. Very little additional work is needed within this area.

Thermodynamic equilibrium models and data

The EQ3/6 code has the functions that are required of an equilibrium model and no additional work is necessary within this area. Additional compilations of thermody-

dynamic data are not necessary for SKB's purposes. It is, however, important to verify and validate data essential to the safety assessment (especially radionuclide solubilities). This will be carried out for the most part during the chemistry programme, see chapter 7.

Canister performance

In view of the fact that the composite canister constitute's SKB's preferred canister, the performance and safety of this canister will be reviewed and reported on during 1993.

Furthermore, the new canister design with steel requires further studies of gas build-up and migration as well as studies of the mechanical effects of corrosion products. A renewed review of the criticality risks during the long-term containment will also be performed.

In the lead-filled canister, the barrier function of the lead has been neglected. Since it can have a very large influence, especially in the event of initial canister defect, additional studies are planned to be conducted.

In 1996, a renewed performance assessment of the near field will be done in the safety assessment that is prepared for the NRL application for permission to commence detailed characterization. The choices of materials and methods for fabrication and inspection that are defined in connection with planning and design etc. of the encapsulation plant and the deep repository will also be taken into account here.

Chemical processes in the near field:

Bentonite chemistry. The bentonite clay and its impurities will affect the groundwater composition nearest the canister. This primarily affects the solubilities of the radionuclides. Development of a model that quantitatively calculates these effects has been commenced.

Cement in the final repository. It may be necessary to use large quantities of cement to seal fracture zones in the rock. This can lead to elevated pH values over relatively long periods of time. The effect of this pH increase will be studied.

Other waste

Only limited efforts have been devoted to studies of the disposal of long-lived Studsvik waste and core components since KBS-3. A systematic review of these waste types will be made. The necessary adaptation/development of models for safety assessment of facilities and long-term performance will be initiated.

2.4.4 Far field

The further refinement of models for transport in the far field will be oriented towards the goal of being able to carry out performance assessments on the candidate sites and an integrated safety assessment in 1996. Arriving at this goal will require follow-up assessments to SKB 91, further refinement of various model concepts, and verification and validation of the calculation models that are intended to be used in the future. A large part of these activities will be coupled during the period to the international task force for groundwater movements and nuclide transport in fractured rock within the Äspö project. INTRAVAL is also an important forum for questions surrounding validation.

The general FEM program for groundwater flow and nuclide transport calculations, NAMMU, should be able to be used for large-scale studies in the future as well. A new version will be available shortly, entailing simplifications in pre- and post-processing, faster numerical solvers, inclusion of a special borehole model, the possibility of sensitivity analysis and improved documentation.

The method that has been used in SKB 91 for stochastic continuum modelling of groundwater movements will be further refined. The calculation programs HYDRASTAR and INFERENS will be improved, among other things with regard to documentation, presentation of results and user-friendliness. HYDRASTAR has been specially developed for the needs of SKB 91 and needs to be generalized. The large quantity of data for the statistical analysis consisted in SKB 91 of data from water injection tests in individual boreholes on different scales. At e.g. Äspö, a large number of interference tests have been carried out which must be able to be used. It is foreseen that this development will be able to be conducted during 1993.

A methodical application of HYDRASTAR to a new area will be implemented in connection with the characterization of the candidate sites. Information in the form of field data will be introduced via the modelling as it becomes available. The initially generic analysis will hereby become more and more site-specific as time goes on.

New geostatistical methods will be tried as a direct follow-up of SKB 91. The statistical model optimization of data from the Finnsjön area that was presented in /2-39/ can be augmented during 1993 with new approaches. Furthermore, an alternative non-parametric method /2-40/ will be tested with available data during 1993. This method does not require that the conductivity field follow a certain distribution. Moreover, it is possible for so-called "soft data" to be introduced via the modelling.

Within the framework of conditional simulation with HYDRASTAR, two different ways can be identified for generating basic data in the form of hydraulic conductivity in boreholes on different scales:

- values based on water injection tests in single boreholes analyzed assuming a continuum;
- block conductivities derived from fracture statistics and pumping tests with the aid of a discrete fracture model.

The first method has been utilized in SKB 91, while the second will be tried during the next few years. The coupling between the model approaches is described in /2-41/.

Note thus that HYDRASTAR is regarded as a tool for stochastic continuum modelling of groundwater movements and that different statistical base models can be tried within this framework.

In parallel with the above-described programme for modelling of the far field, the so-called "channel network model" will be developed. The postulate can be viewed as a further refinement of the more extreme channel model for calculation of radionuclide transport, where the rock is considered to consist of a few water-conducting channels without any intermixing. The new model is intended for calculations on a regional scale where mixing between channels can be expected. Application with borehole data is foreseen during the coming years.

2.4.5 Performance and safety assessments

The schedule for siting of a deep repository for demonstration deposition entails the following analysis work during the period 1993–1998:

- Efforts associated with geological pre-investigations on a first candidate site:
 - A general regional hydrogeological modelling in support of the regional characterization of the repository area.
 - Modelling, within the framework of the siting investigation phase, of, among other things, pathlines for groundwater as a basis for emplacement of a hypothetical repository on the candidate site.
 - During the pre-investigation's phases for fundamental and supplementary investigations, continuous evaluation will be made of the candidate site's hydrogeological conditions with the aid of the analysis models.
 - A safety assessment for a hypothetical repository on the candidate site will be prepared as part of the basis for the evaluation of the candidate site.
- A parallel effort with the same modelling tools will be undertaken for a second candidate site with a delay of about six months.
- Processing of the above material to a performance and safety assessment during 1996, which will be submitted in support of an application for a permit for detailed geological investigations on one of the sites. The safety assessment also comprises part of the background material for the updating of the environmental impact statement which is due by the same time.
- Safety evaluation and compilation of safety reports for encapsulation, transportation and deposition of the waste will be done in connection with the planning and design of the encapsulation plant and the deep repository. The quality of the engineered barriers and the consequences of possible accidents constitute links to the assessment of long-term radiological safety.

3 SPENT NUCLEAR FUEL

3.1 PRESENT-DAY STATE OF KNOWLEDGE

Direct disposal of spent nuclear fuel became an issue during the 1970s, and research and development work aiming at direct disposal is being conducted in several countries. Sweden, Canada and the USA have been leaders for more than a decade when it comes to studies of the stability of spent nuclear fuel in a repository environment. A summary of the research results up to 1988 has been made by Johnson and Shoesmith /3-1/, and this overview article is still the most up-to-date on the subject.

The first Swedish study of the durability of spent fuel in water was done in 1977, as a part of the KBS-2 project, but the programme took on its present-day scope in 1982. An overview of the results and data that have emerged within SKB's programme in recent years is provided in /3-2/, where they are compared with the database that has been collected during the past ten years. This chapter provides a brief situation description regarding the investigations of the influence of irradiation history, groundwater chemistry and redox potential on the durability of the fuel. Experiments with fuel exposed to groundwater under realistic repository conditions have also been initiated.

Beyond investigations of spent fuel and unirradiated UO_2 , a programme for studies of natural weathering products of uraninite has also been under way for several years.

3.1.1 Corrosion of high-level spent nuclear fuel

Oxidizing conditions

Actinides

Data on the concentrations of uranium and plutonium exposed in groundwater (bicarbonate content: $2 \cdot 10^{-3}$ mol/l) are available for cumulative contact times of over seven years. For uranium, it can be seen that during the first few weeks of contact the uranium concentrations in the water rise to an average of $4 \cdot 10^{-6}$ mol/l and remain at this level for 500 days, see Figure 3-1. Subsequently, the concentration rises slowly, and after 2000 days the mean value is $2 \cdot 10^{-5}$ mol/l, but with a larger spread between the measured values than for shorter exposure times. For the sake of comparison, data for unirradiated UO_2 are also shown in Figure 3-1. Unirradiated fuel reaches the higher concentration faster than irradiated fuel. On the basis of data available now, it is not possible to determine whether the uranium concentrations will stabilize at the slightly higher level, or if the increase will continue.

The plutonium concentration in groundwater quickly reaches a constant value. After short exposure times the concentrations are relatively high, with a spread of between 10^{-9} and 10^{-8} mol/l. At longer contact times the concentrations in solution decline and appear to stabilize at a level just under 10^{-9} mol/l, see Figure 3-2. The high-burnup fuel contains approximately 1% plutonium. With a congruent release, the plutonium concentration in solution should be 100 times higher than has been measured. Comparisons with experiments with other fuel types show that the concentration of plutonium in solution is independent of the fraction of plutonium in the fuel. Both extremely low-burnup fuel and breeder reactor fuel have comparable plutonium concentrations in groundwater, despite the fact that the low-burnup fuel only has

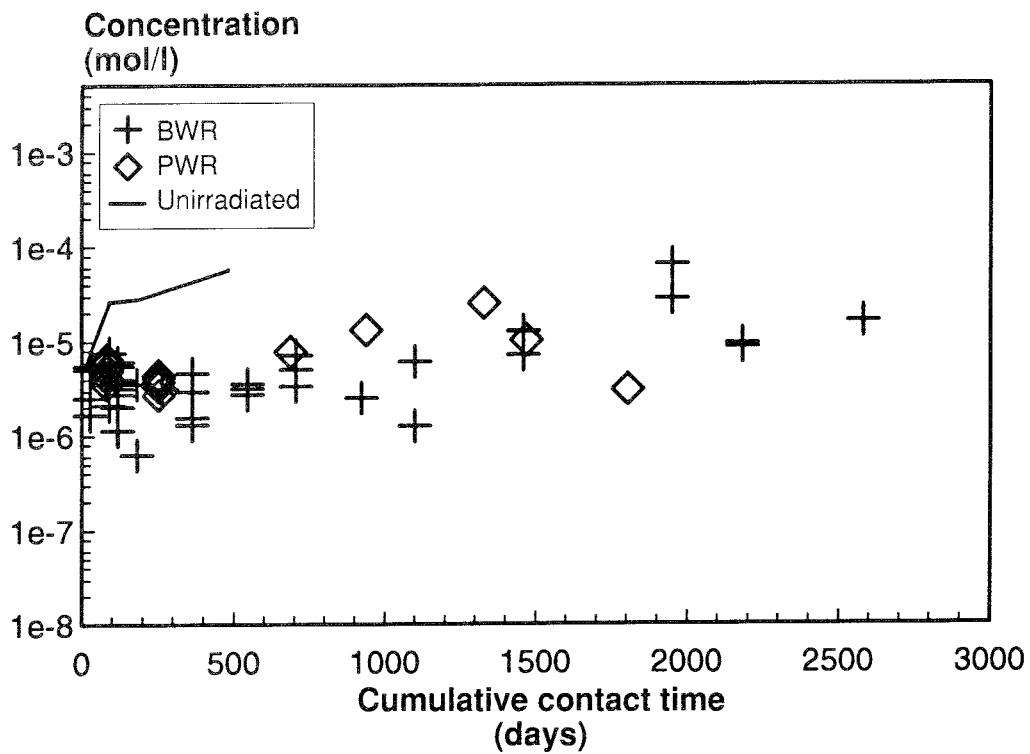

Figure 3-1. Uranium concentrations in synthetic groundwater as a function of cumulative contact time (oxidizing conditions).

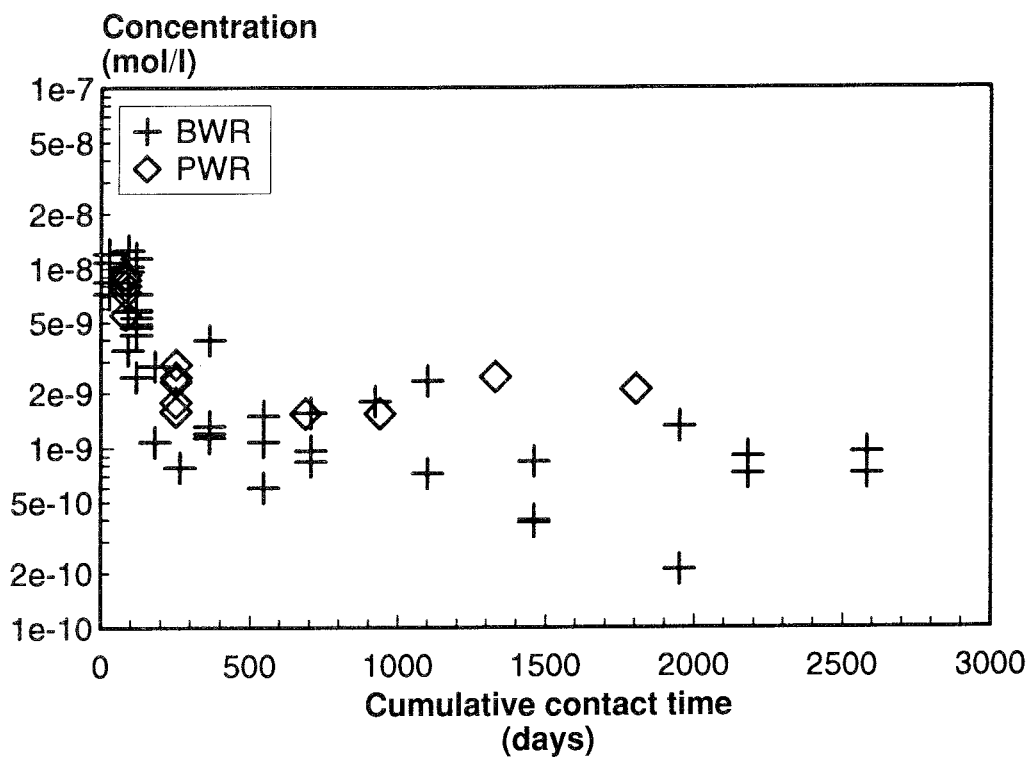

Figure 3-2. Plutonium concentrations in synthetic groundwater as a function of cumulative contact time (oxidizing conditions).

about 1% of the plutonium content in light water reactor fuel and the breeder reactor fuel consists of 20% PuO₂.

In deionized water, the uranium concentration is very low and often below the analytical detection limit. This corresponds to concentrations under 10⁻⁷ mol/l. The situation for plutonium is reversed. The concentrations rise to slightly more than 10⁻⁸ mol/l. This is more than ten times the quantity of plutonium that corresponds to the quantity of dissolved uranium. Thus, under oxidizing conditions the leaching of radionuclides is not limited by the dissolution of uranium.

Solubility control

The results indicate some form of solubility control for the release of actinides. If calculations are performed with thermodynamic equilibrium codes, however, a not quite acceptable agreement is obtained between experiments and calculations if it is assumed that the system is in equilibrium with the ambient air. The plutonium solubilities are not redox-sensitive to variations in redox potential within the range that may be relevant for the experiments, but the calculations predict a uranium concentration 10 times the measured one. One possible explanation for the discrepancy may be the fact that the redox conditions during the experiments are not controlled by the oxygen concentration in the system, but by a U(IV)/U(VI) buffering.

The discrepancy between experiments and calculations is even more striking if neptunium is included in the comparison /3-3, 3-4/. If the neptunium concentration is solubility-limited, the solid phase must be an Np(IV) phase. If Np(V) controlled the solubility, the neptunium concentration would be several orders of magnitude greater than has been measured in the experiments. Very few data are available for Np, and the possibility that the neptunium concentration is controlled by the fuel dissolution and is not solubility-limited cannot be ruled out at this point.

Fission products

Experimental data indicate that the release of the actinides is solubility-limited. Measurements of their concentrations in the leaching solution can therefore not provide any direct information on the processes that control the fuel dissolution. It would be valuable to be able to measure the release of one or more fission products, as a measure of the rate of fuel corrosion. For this to be possible, these fission products must be homogeneously distributed in the fuel and their solubility in groundwater must be sufficiently high. An obvious choice would have been one of the rare earth metals, which are formed in the fuel with a high yield and which form a solid solution with the uranium dioxide matrix. Unfortunately, the release of these fission products is solubility-limited in the same way as the actinides. There are still uncertainties concerning which fission product reflects the fuel alteration. For the time being, the leaching of strontium is regarded as a measure of fuel alteration, despite certain objections that can be raised to this.

Examples of different leaching behaviours can be found for the fission products caesium, strontium and technetium. Caesium and even iodine migrate to some extent (typically about 1%) to the surface of the fuel and the gap between the fuel and the fuel cladding tube during reactor operation. This fraction is released quickly when the fuel comes into contact with water, see Figure 3-3, giving high initial leach rates. Subsequently the leach rate declines with time and appears to remain constant after several hundred days at 10⁻⁶ d⁻¹.

Equivalent data for strontium are shown in Figure 3-4. Here the leach rate is constant during the first weeks and then declines with time, in a manner similar to caesium. The strontium values are, however, always lower than the equivalent caesium values.

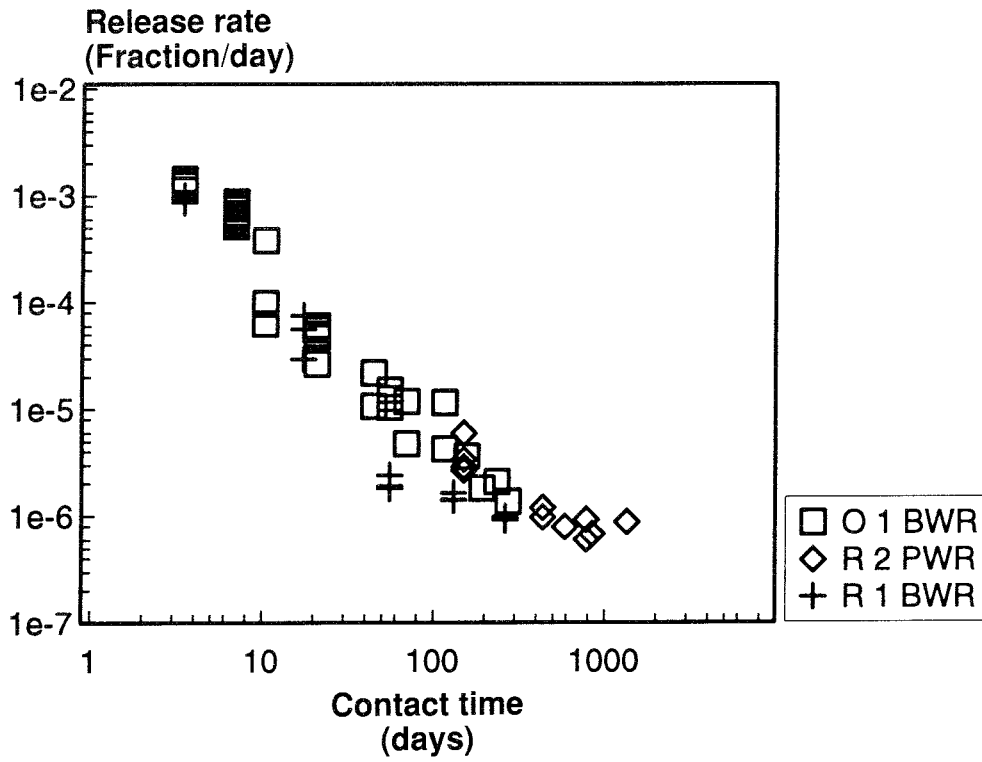

Figure 3-3. Release rate for ^{137}Cs under oxidizing conditions.

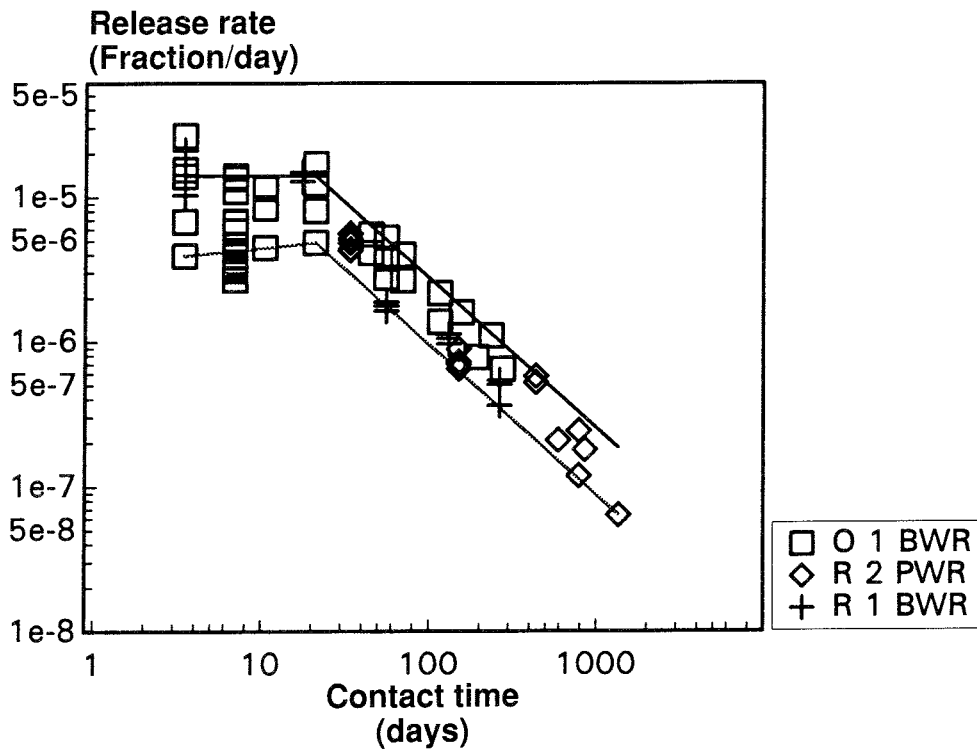

Figure 3-4. Release rate for ^{90}Sr under oxidizing conditions.

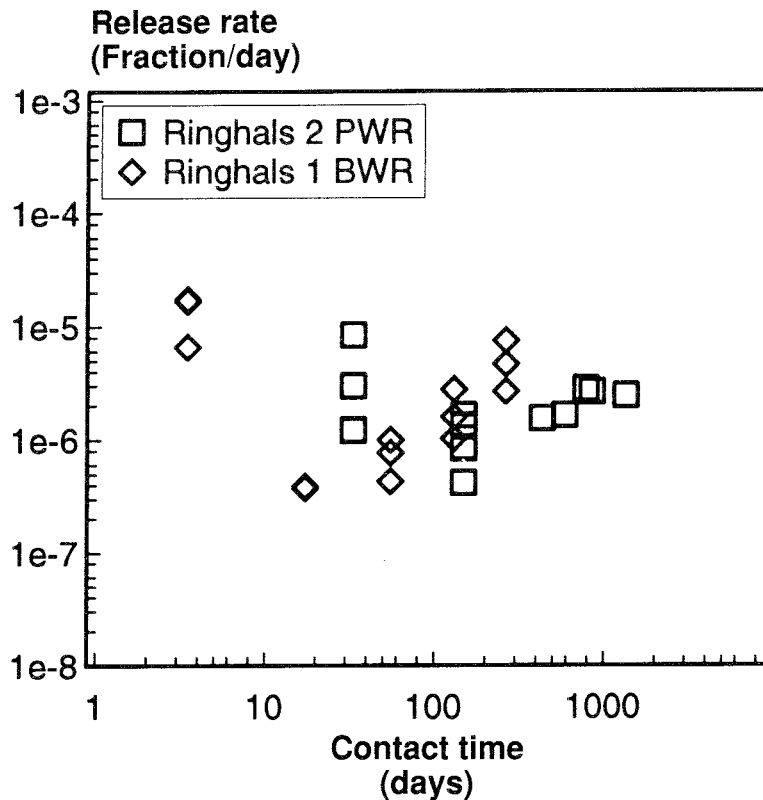

Figure 3-5. Release rate for ^{99}Tc under oxidizing conditions.

After five years the leach rate has declined to 10^{-7} d^{-1} and data indicate that the rate is still declining with time. It has not yet been completely clarified whether the strontium leaching after longer contact times represents local corrosion in areas that are enriched in strontium or whether it is a measure of the UO_2 dissolution. If the latter should prove to be the case, the higher caesium leaching may come from corrosion in grain boundaries, where caesium has been enriched. Such enrichments have been observed by microprobe analyses [3-5]. Corresponding enrichments of strontium have not been demonstrated, but cannot be entirely ruled out due to uncertainties in the strontium analyses.

Technetium data for oxidizing conditions are shown in Figure 3-5. The spread in the data is greater than for caesium and strontium, but it is quite clear that the technetium leaching follows a different pattern. The leach rate for technetium is independent of the contact times and lies between 10^{-5} and 10^{-6} d^{-1} . After a few years, technetium is leached faster than both caesium and strontium. Compared with these elements, it is well known that technetium occurs in fission gas bubbles in the grain boundaries and as metallic inclusions together with Mo, Ru, Rh and Pd. The release of technetium is probably controlled solely through oxidation and dissolution of these inclusions.

Reducing conditions

Deep groundwaters are reducing. While it is difficult to create and maintain reducing conditions in a hot-cell environment, a number of experiments have been conducted under both reducing and anoxic conditions. In these experiments the concentrations of actinides have been close to or below the detection limits. For uranium the concentra-

tions have been below 10^{-7} mol/l, while other actinides have not been able to be detected.

The change in redox conditions is of crucial importance for the technetium concentrations in solution, while it only affects the leaching of caesium and strontium to a lesser extent. The mean concentration of technetium under reducing conditions is $6 \cdot 10^{-9}$ mol/l, which is comparable to the solubility of TcO_2 ($3 \cdot 10^{-8}$ mol/l).

The first pulse of released caesium is independent of the redox conditions, since it consists of easily soluble species. For strontium there is a more pronounced difference between oxidizing and anoxic conditions during the first contacts, with a faster decrease of the leach rate under anoxic conditions. After about a year, however, the differences in strontium leaching under oxidizing and anoxic conditions are very small [3-2]. When low redox potentials are reached with hydrogen in the presence of a palladium catalyst, the strontium leach rate is roughly one-tenth of the rate under oxidizing conditions.

Corrosion zones

Under the expected conditions in the repository, with low redox potentials, UO_2 will be stable and uranium solubility very low. The release of most radionuclides from the fuel would then depend solely on the solubility of the uranium. This situation could be disturbed by the oxidants that are produced by radiolysis of the water. For while radiolysis produces equivalent amounts of reducing and oxidizing species, the low reactivity of the reducing species could lead to local oxidizing conditions near the surface of the fuel. In order to correctly interpret the results obtained from analyses of aqueous solutions that have been in contact with the fuel, it is also necessary to know from where in the fuel the radionuclides have been released.

Studies with this purpose have been conducted since 1985, when long-term exposures of BWR fuel in four different bicarbonate solutions were started. Evaluation of these samples has begun, and in parallel with the analyses of the exposed samples reference samples have also been examined. Figure 3-6 shows the variation in a fuel pellet, in the radial direction, of porosity, alpha-activity and burnup measured as Nd/U ratios in the fuel. Porosity and alpha-activity increase steeply towards the periphery of the fuel pellet. Due to this combination of increased porosity and local alpha dose, the pellet periphery constitutes a zone where increased corrosion attack can be expected.

Figure 3-7 shows electron micrographs of the periphery of a non-corroded fuel fragment and of two fuel fragments from the same zone that have been in contact with groundwater for 1 427 days and with deionized water for 1 521 days, respectively. The pictures clearly show a corrosion attack in the peripheral zone which has resulted in a clear increase in porosity. The fuel that has been in contact with deionized water also exhibits crystals of a UO_3 hydrate on the fuel surface. The same type of corrosion could not be documented on fuel surfaces further away from the peripheral zone, but these areas exhibited indications of intergranular corrosion in conjunction with sample preparation. Further investigations of this kind are needed to achieve a better understanding of the mechanisms behind fuel corrosion and the release of radionuclides.

Effects of burnup and linear heat load

There are still a number of questions surrounding fuel corrosion that have not been completely explored: (a) is the ^{90}Sr release a measure of fuel corrosion? (b) is the decrease by only a factor of 10 or so of the ^{90}Sr release under reducing conditions

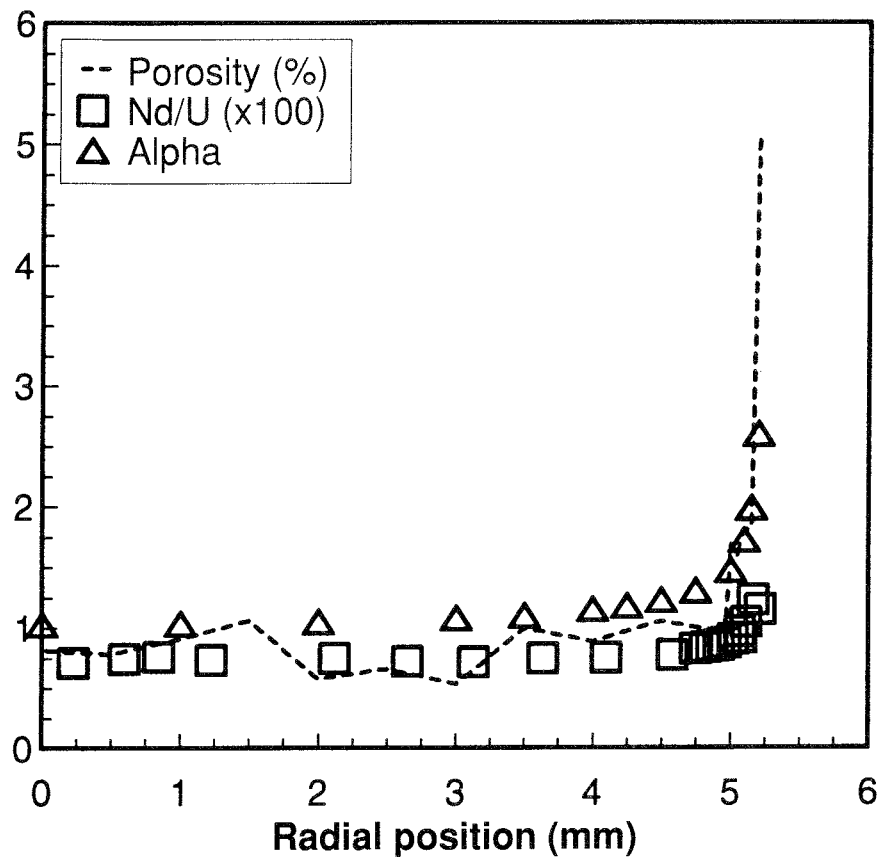

Figure 3-6. Radial variation of fuel porosity, burnup and alpha-activity in the reference fuel (BWR) from Oskarshamn-1.

caused by radiolysis or by redox-independent processes? (c) if the radiolysis effects are of importance, what is the relationship between dose and corrosion? (d) are the corrosion attacks proportional to the fuel's exposed area or do other factors dominate?

It is inevitable that the experimental observations may be dominated by transient phenomena which are of no importance in the long-term perspective. It is therefore important to obtain a good understanding of these phenomena so that the models that will be used for safety analyses describe relevant scenarios. A part of this effort is an ongoing series of experiments aimed at defining and quantifying the importance of burnup and power density (Kw per metre of rod length) for the migration of the radionuclides in the fuel and, later, for the release of radionuclides when the fuel comes into contact with water.

A number of experiments with this purpose are being conducted, such as leaching of fuel that has been exposed to high power densities in a test reactor after discharge from the power reactor and investigations of isotope exchange processes between solid phase and uranium-saturated solutions. Only preliminary results are as yet available from these investigations. Results are, however, available from the first year's corrosion tests of a segment rod with varying burnup along the length of the rod (21 to 49 MWd/kg U). The cumulative release of ^{137}Cs and ^{90}Sr is shown in Figures 3-8 and 3-9, respectively. Both caesium and strontium exhibit a correlation between release and burnup with increasing leaching up to about 40 MWd/kg U, after which leaching declines at higher burnups. At low burnups the release of caesium is less, as expected, but also slower. This indicates that the availability of water is of import-

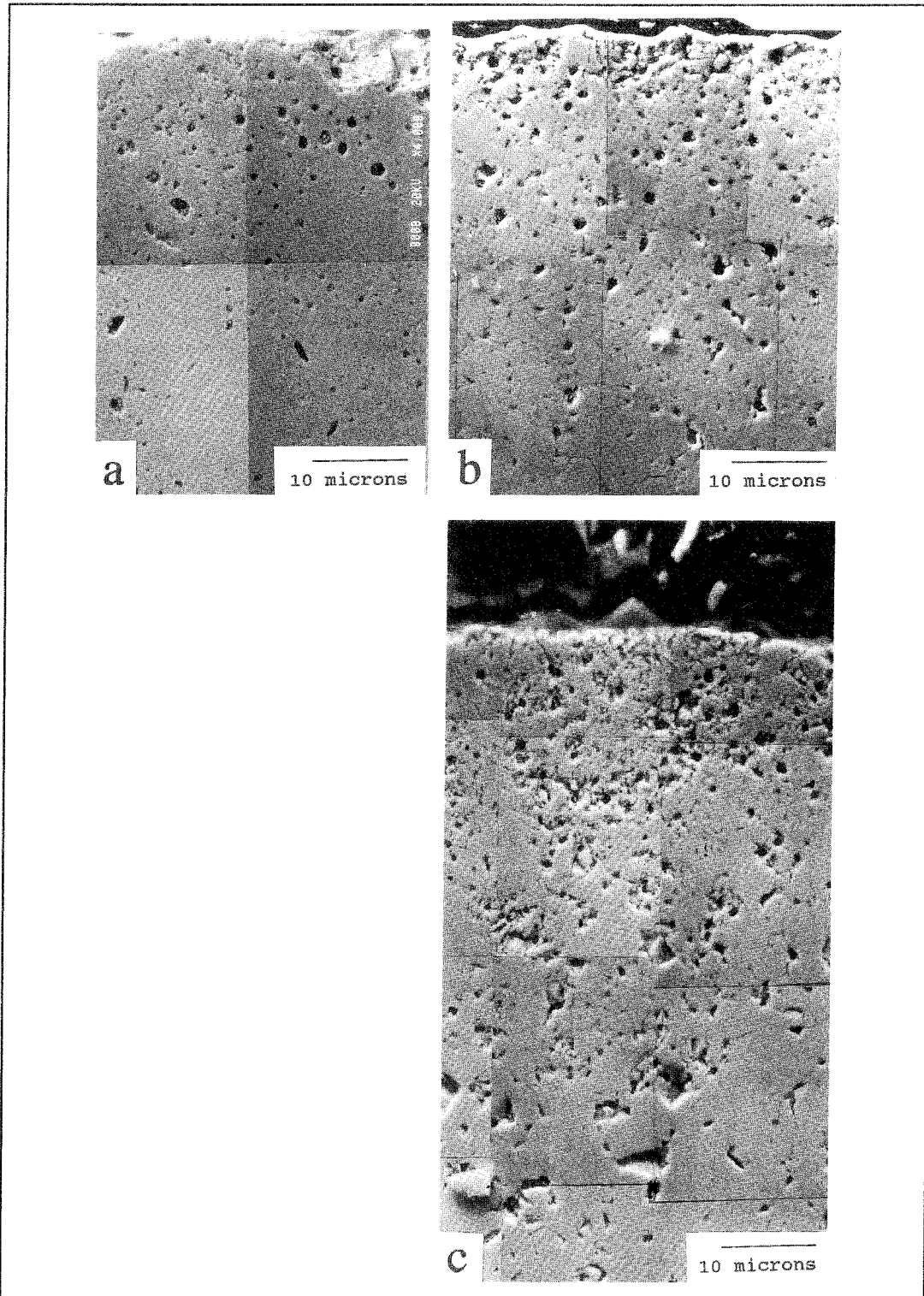

Figure 3-7. Photomosaic from the fuel periphery of (a) non-corroded fuel, (b) fuel that has been in contact with synthetic groundwater for 1 427 days and (c) fuel that has been in contact with deionized water for 1 521 days.

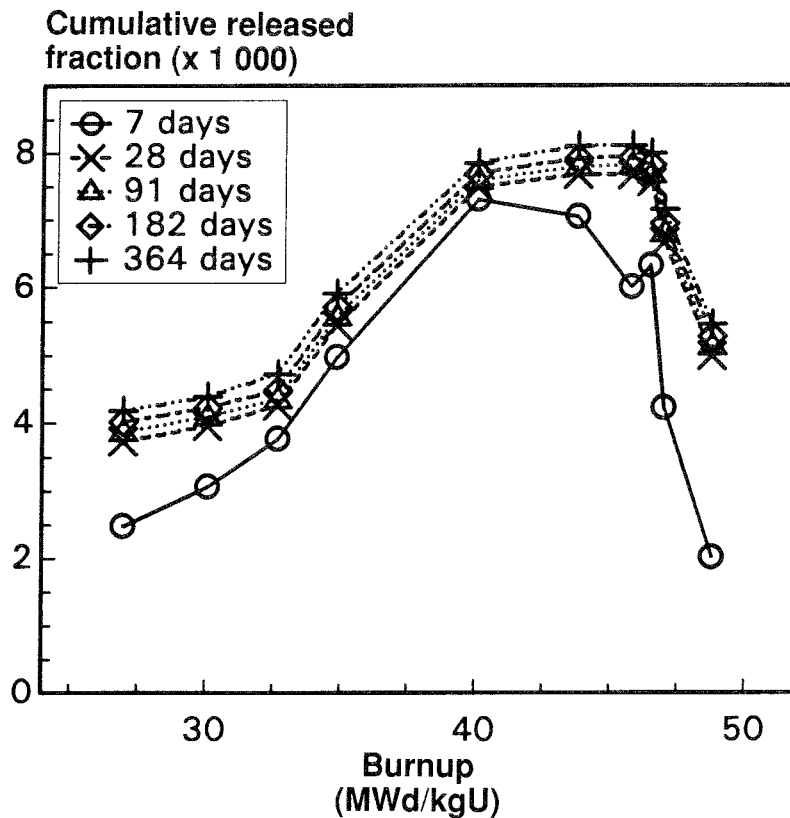

Figure 3-8. Cumulative released fraction of ^{137}Cs as a function of burnup (ground-water: oxidizing conditions).

ance. The unexpected decline at higher burnups, where both fuel porosity and radiolysis effects are greatest, must, however, be due to other burnup-related effects. Hopefully, the continued investigations will provide a basis for a more satisfactory evaluation.

3.1.2 Other components in the near field

The results of a preliminary investigation of the influence of bentonite on fuel corrosion were reported in 1988 /3-6/. This study was conducted in a dilute bentonite slurry for the primary purpose of investigating whether sorption on the bentonite particles could lead to an increase in fuel corrosion. No such effects could be observed under oxidizing conditions. A series of experiments that simulate the conditions in a final repository in a more realistic manner was also started during the latter half of the 1980s. In these experiments, spent fuel was leached in contact with compacted bentonite under anaerobic conditions. Steel and copper were also present in some of the experiments. A preliminary evaluation of contact times of up to one year has been done /3-7/ and the final analysis of exposures of up to five years is in progress, but no data can yet be reported. The results after one year show an expected high mobility for caesium. Approximately 1% of the caesium inventory has been released after only 100 days. This is in complete agreement with what has been observed in previous leach tests. The apparent diffusivity in the bentonite was found to be $5 \cdot 10^{-13} \text{ m}^2/\text{s}$.

The release of technetium proved to be low. Only about 0.006% of the inventory had been released after 100 days. This is comparable to what had been observed under

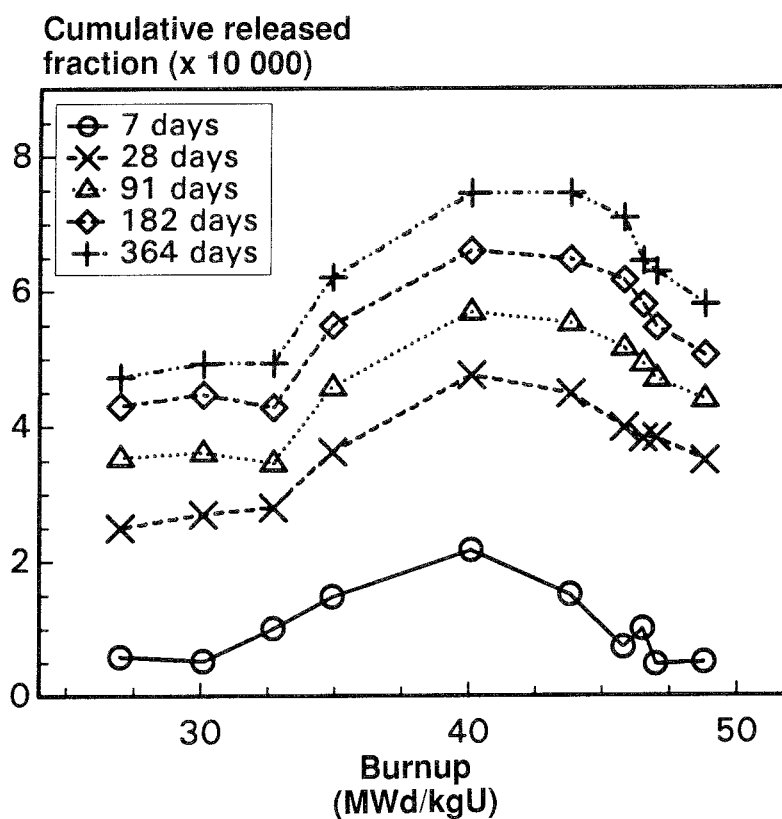

Figure 3-9. Cumulative released fraction of ^{90}Sr as a function of burnup (ground-water: oxidizing conditions).

anaerobic conditions. Under oxidizing conditions in leach experiments, the fraction is higher by a factor of one thousand. The measured diffusivity also indicates that technetium is present as Tc(IV).

The actinides proved to have very low mobility. After one year plutonium had diffused less than a half a millimetre from the fuel surface. This low mobility indicates that plutonium is present as Pu(IV). Evaluations of the five-year samples will be performed during 1992/93.

3.1.3 Models

Deep groundwaters are reducing. Under such conditions uranium dioxide is stable and has a very low solubility. The release of radionuclides from the fuel matrix would be limited by the solubility of uranium in groundwater. As a result of radiolytic decomposition of the water, however, oxidizing and reducing species are created. Oxidants are the more reactive and could cause an oxidation of the fuel surface.

In SKB 91, a model for fuel corrosion was used which assumed oxidative dissolution caused by oxidants produced by alpha-radiolysis of water. The oxidation rate was assumed to be proportional to the alpha dose rate. The strontium release under oxidizing conditions after several years' exposure was used as a very conservative upper limit for the oxidation rate /3-8/.

Even if the model sets an upper limit for fuel alteration and the release of radionuclides, however, several uncertainties remain. It has not been conclusively shown that

the strontium leach rate is a measure of the fuel oxidation rate. If strontium that has segregated in the fuel contributes towards the leach rate, the oxidation rate may be much lower than has been assumed. Nor has it been established what effect the radiolytically produced oxidants have on the UO₂ matrix. It may be much lower than has been assumed in SKB 91. Certain data indicate that it is so low that a model for oxidative dissolution is not applicable /3-9/.

3.1.4 Natural analogues

Studies of alteration processes in natural uraninite deposits have been conducted since 1988 /see e.g. 3-10, 3-11, 3-12/. Experimental studies can provide good information on corrosion processes and mechanisms, but can naturally not show how the uranium dioxide-groundwater system evolves over long periods of time. These long-term effects can be elucidated by studies of alteration processes in natural uraninite deposits under mildly oxidizing and reducing conditions.

It is, however, important to observe that there is a difference between natural UO_{2+x} (uraninite) and irradiated fuel. Natural uraninites, for example, often contain radiogenic lead, which can be of importance for the alteration processes. Moreover, solubility calculations with geochemical models assume thermodynamic equilibrium. This does not have to be the case. In laboratory investigations in particular, meta-stable corrosion products are formed. Similar meta-stable phases also occur in nature and they play an important role for the formation of the phases which, in a longer time perspective, control uranium solubility.

Under oxidizing conditions, such as at Shinkolobwe in Zaire, uraninite has been converted to a large number of secondary minerals. The formation of uranyl oxide hydrates is kinetically favoured, but in silicon-containing water these compounds are transformed into more stable uranyl silicates. The composition of uranyl oxide hydrates primarily reflects the composition of the original uraninite, while the uranyl silicates normally reflect the composition of the groundwater they were formed in contact with /3-12/.

In order to be able to use natural uranium deposits as natural analogues for spent nuclear fuel, it is therefore important that the original uraninite is characterized well and that the importance of the solid phases that are formed in different geochemical environments is understood.

3.2 GOALS FOR THE PERIOD 1993–1998

Present-day knowledge and data can be utilized to determine an upper limit for the release of the radionuclides from spent nuclear fuel. The fuel studies are continuing with the following goals:

- progressive refinement of our understanding of the release of radionuclides from spent fuel and progressive refinement of the models for the safety assessment in 1996,
- development of a realistic model for radionuclide release from the fuel by the beginning of the next century in time for the application for a siting permit and an environmental licence for the deep repository.

3.3 PROGRAMME 1993–1998

The main factors that influence the corrosion of spent nuclear fuel and the release of radionuclides in the groundwater are:

- 1) The fuel's irradiation history, which affects the microstructure of the fuel and is of great importance for the segregation of radionuclides to cracks in the fuel pellet and to grain boundaries.
- 2) The redox potential and the influence of alpha-radiolysis on the redox conditions in the near field.
- 3) The water chemistry, especially in the presence of other components in the near field.
- 4) The solubility of the actinides and the fission products.

Knowledge gaps still exist within these areas. The most significant ones exist within the following areas:

- The distribution of fission products and actinides at the grain boundaries and in the matrix in the fuel. A grain boundary inventory can be released faster and with somewhat different mechanisms than matrix-bound radionuclides.
- The influence of radiolysis, mainly alpha-radiolysis, on the redox conditions nearest the fuel in an otherwise oxygen-free environment.
- Thermodynamic data for certain elements, such as Pu and Np. This applies to both species in solution and any solubility-limited solid phases.

During the preceding three-year period, the emphasis in the work has been shifted from relatively large series of leach experiments on BWR and PWR fuel to experiments where more specific questions are being studied. At present only a few of the experiments from the previous test series with BWR and PWR fuel are continuing with long-term exposures.

The large ongoing experiment series are aimed at examining the effect of burnup and linear heat load on fuel corrosion.

3.3.1 Characterization of spent nuclear fuel

The release of fission products and actinides from the fuel takes place from three different sources. During operation, Cs and I have been released from the fuel matrix and are readily accessible for leaching in the fuel-clad gap and in cracks in the fuel. Other fission products, such as Pd, Tc, Ru, Rh and Mo, may have formed separate phases in the fuel. Material segregated in this way can be released faster and via other mechanisms than the radionuclides that are trapped in the UO₂ matrix. It is therefore important that the spent fuel be characterized with respect to the distribution of fission products and actinides. This information is of great importance for the work on development of predictive models.

A standard method for characterization of spent fuel has been developed during the most recent period. It is being used to systematically explore the specific characteristics of the fuel that can be expected to be of importance for fuel corrosion. These can then be compared with the results from similar characterization of fuel that has been in contact with water in order to identify zones with corrosion attack. This work is complicated and time-consuming, but necessary, in order to obtain the knowledge on the kinetics and mechanisms of corrosion that is required to model the process.

This area has high priority, and research efforts are planned to be pursued on the same level as during the preceding period. The chief techniques will be optical microscopy, electron microscopy and microprobe analysis. The intention is to determine the local concentrations of the fission products strontium, molybdenum, caesium and xenon in

order to provide a picture of their migration in the fuel during operation, and of neodymium in order to obtain a measure of local burnup.

3.3.2 Radiolysis

The naturally reducing conditions in deep groundwaters can be disturbed by the radiation field around the fuel. The experimental data that are available show that radicals that are formed during gamma-radiolysis of water can cause oxidation of UO_2 . After about 1000 years, however, the gamma and beta fields will have decayed to a nearly negligible level compared with the alpha field, which decays only slowly with time. Oxidants produced by radiolysis could cause an oxidative alteration of the fuel, followed by a release of radionuclides. In other words, it may be reasonable to assume that the conditions on and near the fuel surface are oxidizing, but the magnitude of the radiolytic effect is not known.

Investigations of radiolytic oxidation of fuel in oxygen-free systems will be carried out during the period. Some of these experiments will be conducted within the framework of an ongoing cooperative project with AECL, Canada. In order to be able to carry this out, the capacity for chemical analysis of leaching solutions has been substantially improved during the preceding period.

3.3.3 Corrosion of high-level fuel

The corrosion studies with PWR and BWR fuel will continue during the next few years, but with fewer and more specific experiments. Analysis efforts will also be broadened with each experiment, as a result of the improved analysis potential. The emphasis in the experimental programme will be on exposures in anaerobic and reducing groundwaters. Furthermore, experiments will be conducted at elevated temperature. The purpose of the investigations is to determine the rate of fuel corrosion after uranium saturation has set in as a function of redox conditions, groundwater chemistry, fuel burnup and linear heat load. Together with the results from the specific radiolysis studies, this is expected to provide the information on radiolytic oxidation that is needed for the continued model development.

3.3.4 Model development

The purpose of model development is to obtain a predictive model for the corrosion of spent nuclear fuel over long periods of time. Such a prediction is only meaningful if the dissolution mechanisms in the short and in the long time perspective are known and quantified.

In SKB 91, a model for fuel corrosion was used which assumed oxidative dissolution caused by oxidants produced by alpha-radiolysis of water. The strontium release under oxidizing conditions was used as a very conservative upper limit for the oxidation rate. However, it has not been conclusively shown that the strontium leach rate is a measure of the fuel oxidation rate. If strontium segregates in the fuel, the oxidation rate may be much lower than has been assumed. Nor has it been established what effect the radiolytically produced oxidants have on the UO_2 matrix. Certain data indicate that it is so low that a model for oxidative dissolution, which has been used in SKB 91, is not applicable other than in an initial phase.

For the time being, the work will be predicated on the assumption that fuel dissolution can be oxidative and controlled by radiolysis. This means that a kinetic model must be used, at least during an earlier phase of fuel dissolution. In a longer perspective, when

the alpha activity has decayed, fuel dissolution can be described with the aid of a solubility limitation model.

3.3.5 Natural analogues

The work during the period will be focused on increasing our understanding of the structure and crystal chemistry of the uranium oxides and of the alteration sequence of the U(VI) compounds. This includes obtaining some of the base data required to identify corrosion products and to model the corrosion of spent fuel.

Data will become available from several natural analogue projects. Comparisons between identified secondary uranium phases and the alteration sequence of the uranium compounds from the different localities can provide information on what general conclusions can be drawn. It is also important to be able to relate any differences to variations in the original uraninite and to variations in the geochemical environment.

4 CANISTER

4.1 PRESENT-DAY STATE OF KNOWLEDGE

4.1.1 Alternative canister materials

Copper has been the reference alternative for the canister material since the KBS-2 project at the end of the 1970s. The choice of copper was primarily based on copper's immunity to corrosion in oxygen-free water. An initial assessment of the corrosion resistance of copper was made in 1978 /4-1/. This was later augmented in 1983 prior to publication of the KBS-3 report /4-2/. The conclusions of both these studies was that a copper canister will have a very long life under repository conditions.

Certain uncertainties remained for local corrosion, however, mainly pitting and stress corrosion cracking (SCC). Of these two corrosion types, pitting on copper under both oxidizing and reducing conditions has received the greatest attention, and the state of knowledge as of 1992 is presented in /4-3/.

Since the KBS-3 report, alternative canister materials have also been studied, both through SKB's own efforts and through follow-up of research and development work conducted by other organizations. Several of these canister materials have been found to have very good corrosion resistance, such as Al_2O_3 and titanium.

For the ceramic materials, delayed failure was early identified as a possible and difficult-to-foresee failure mechanism. Delayed failure is caused by slow crack growth from initial defects.

Several attempts to estimate the rate of crack growth in a ceramic canister have been made, above all in Sweden and Switzerland. Tested Al_2O_3 materials proved to have estimated lives that vary by many orders of magnitude (see e.g. /4-4, 4-5/). The differences are probably due to differences in grain size, impurities, sintering procedures etc. The measurements were made on small test specimens, but it is well known that bodies with larger volumes and surface areas have shorter lives. Moreover, in order to be able to judge the service life of a full-sized canister, it is necessary to know the distribution of stresses in the canister walls, which requires full-scale tests. In view of the very great uncertainties in obtained experimental results, determining a minimum service life for a ceramic canister with certainty would appear to be tricky.

The risk of delayed failure exists for titanium as well due to hydrogen embrittlement, but crevice corrosion is also possible in chloride-containing water. Titanium comprises the main alternative in Canada, where a great deal of effort has been devoted to determining the risks of delayed failure. The probability has been shown to be very low, even though it cannot be neglected entirely /4-6/. Compared to copper, however, titanium does not appear to offer any clear advantages as a canister material in Sweden.

Steel as a canister material has been studied by SKB since 1986. Steel, being a well-known engineering material, has many advantages from a fabrication point of view, but will inevitably lead to a short-lived canister. Moreover, steel in a repository environment will lead to hydrogen gas production.

Copper is a material that lends the canister a very long life from the corrosion viewpoint. Copper has therefore been chosen as the canister material for all research and development work from now on.

4.1.2 Corrosion – copper

Sulphide corrosion

Under reducing conditions, copper is immune to corrosion in pure water, as is evident from the Pourbaix diagram in Figure 4-1. The stability range of copper is influenced strongly by the chemical composition of the system and it is therefore necessary to identify the components that could influence the thermodynamic stability of copper. It is well-known that the presence of sulphur markedly reduces the stability range of copper, see Figure 4-2.

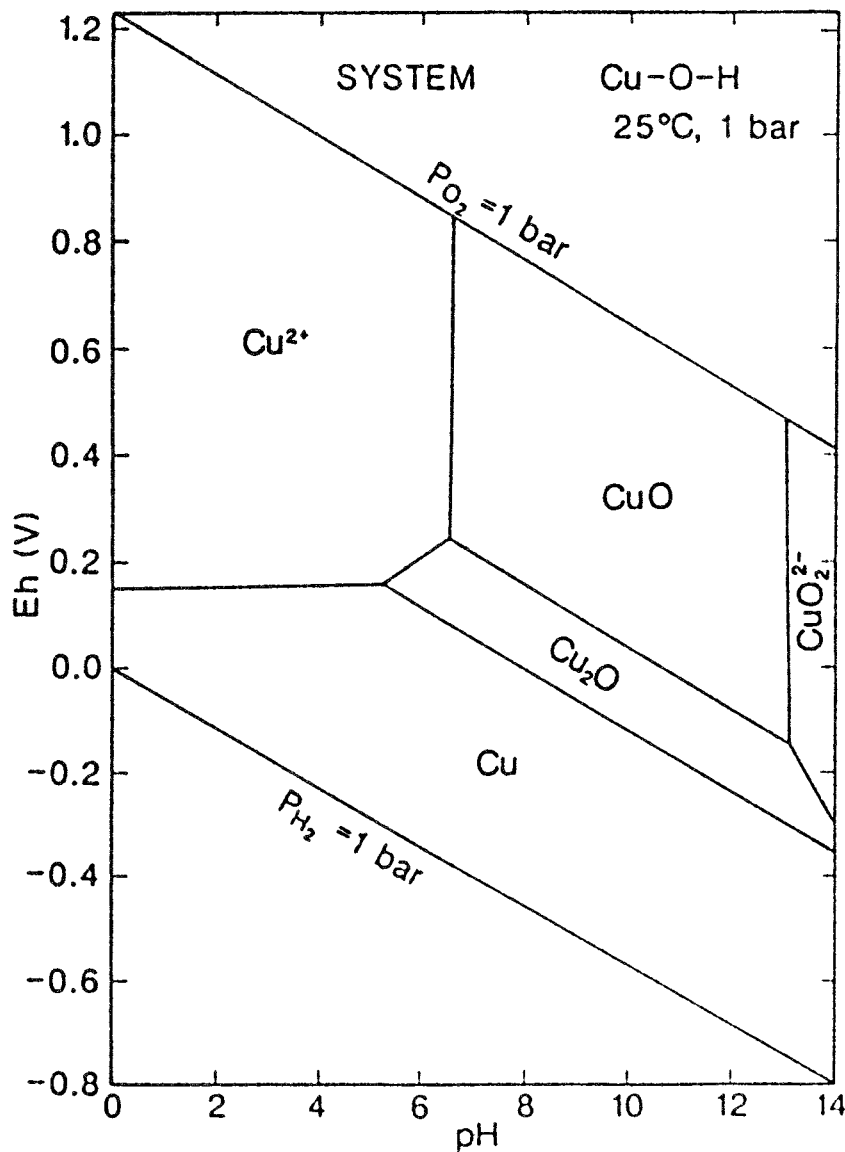

Figure 4-1. Potential pH diagram for the copper/water system (from /4-7/).

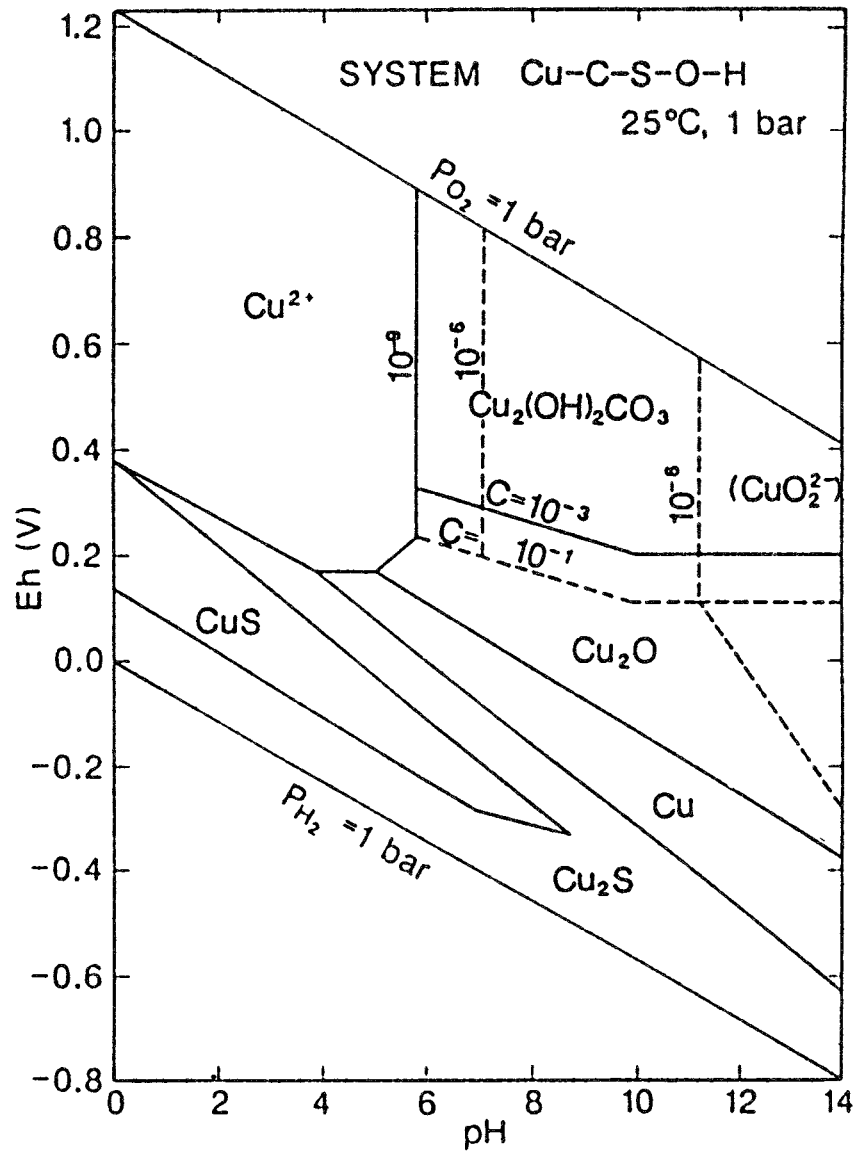
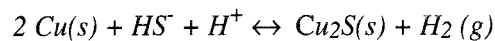
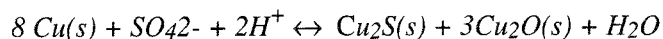

Figure 4-2. Potential pH diagram for the copper/sulphur/carbon/water system (from /4-7/).

Copper can be oxidized by water in the presence of chemical substances which stabilize Cu(I) and Cu(II). As is evident from Figure 4-2, sulphide is such a substance according to the reaction:



Copper can also be oxidized by water in the presence of high concentrations of sulphate. Direct oxidation according to the reaction:



is not possible in natural waters, but in the presence of additional electron donors, oxidation of copper is theoretically possible:

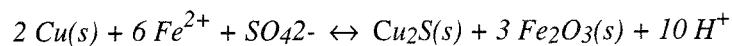

The research that has been conducted since KBS-3 has not revealed any reason to revise previous conclusions in any essential respect. The renewed analysis shows that it has not been possible to identify any pure copper processes that could lead to canister penetration /4-3/. A renewed investigation of the possibilities of inorganic reduction of sulphate to sulphide has confirmed the earlier conclusions that this process can be ruled out in the repository environment /4-8/. More recent investigations have also shown that organic reduction, which is limited by the availability of organic matter in the buffer and groundwater, does not constitute a threat to the integrity of the canister even if untreated natural bentonite is used as the buffer material /4-3/.

Pitting in connection with sulphide corrosion under reducing conditions is a highly unlikely process. The mechanisms which control the corrosion process are more liable to lead to an evening-out of the corrosion attack than the formation of pits. A non-homogeneous distribution of corrodants in the buffer or a non-homogeneous supply of corrodants from the groundwater could, however, lead to uneven general corrosion of the copper surface. However, due to the limited availability of corrodants, corrosion of this type would not appreciably reduce the life of the canister.

Oxygen corrosion

The amount of oxygen that could be trapped in the repository in connection with sealing does not lead to corrosion of any significance. During the period of time when oxygen remains in the repository, however, the necessary conditions for pitting exist. However, due to reactions between oxygen and pyrite in the bentonite, the mildly oxidizing conditions that can sustain pitting are limited to a duration of a few hundred years. Model development for pitting under mildly oxidizing conditions has been initiated and the results obtained show that for these periods of time, pitting does not pose a threat to the integrity of the canister /4-9/. Further development of the model will be pursued during the next few years.

Stress corrosion cracking

The KBS-3 inquiry showed that stress corrosion cracking (SCC) is a highly unlikely process in the repository environment. This judgement remains valid, but SCC will be further investigated when the canister design is more precisely defined and when the stress conditions in the canister under different scenarios become better known.

4.1.3 Mechanical aspects

During the last two years, questions pertaining to the mechanical integrity of the canister have been studied more closely by a group of five Swedish experts from industry and the academic world /4-10/. The questions investigated have mainly had to do with the creep ductility of different copper grades, residual stresses in canisters after sealing and the effects on a copper canister of a rock displacement. Three different canister alternatives have been studied:

- Composite canister with outer copper shell over an inner supporting steel cylinder.
- Lead-filled copper canister.
- Hot isostatically pressed (HIP) copper canister.

These canister alternatives are illustrated in Figure 4-3.

Creep ductility

During the past few years a major programme for studies of the creep properties of copper has been carried out. During the course of the work it has been found that pure

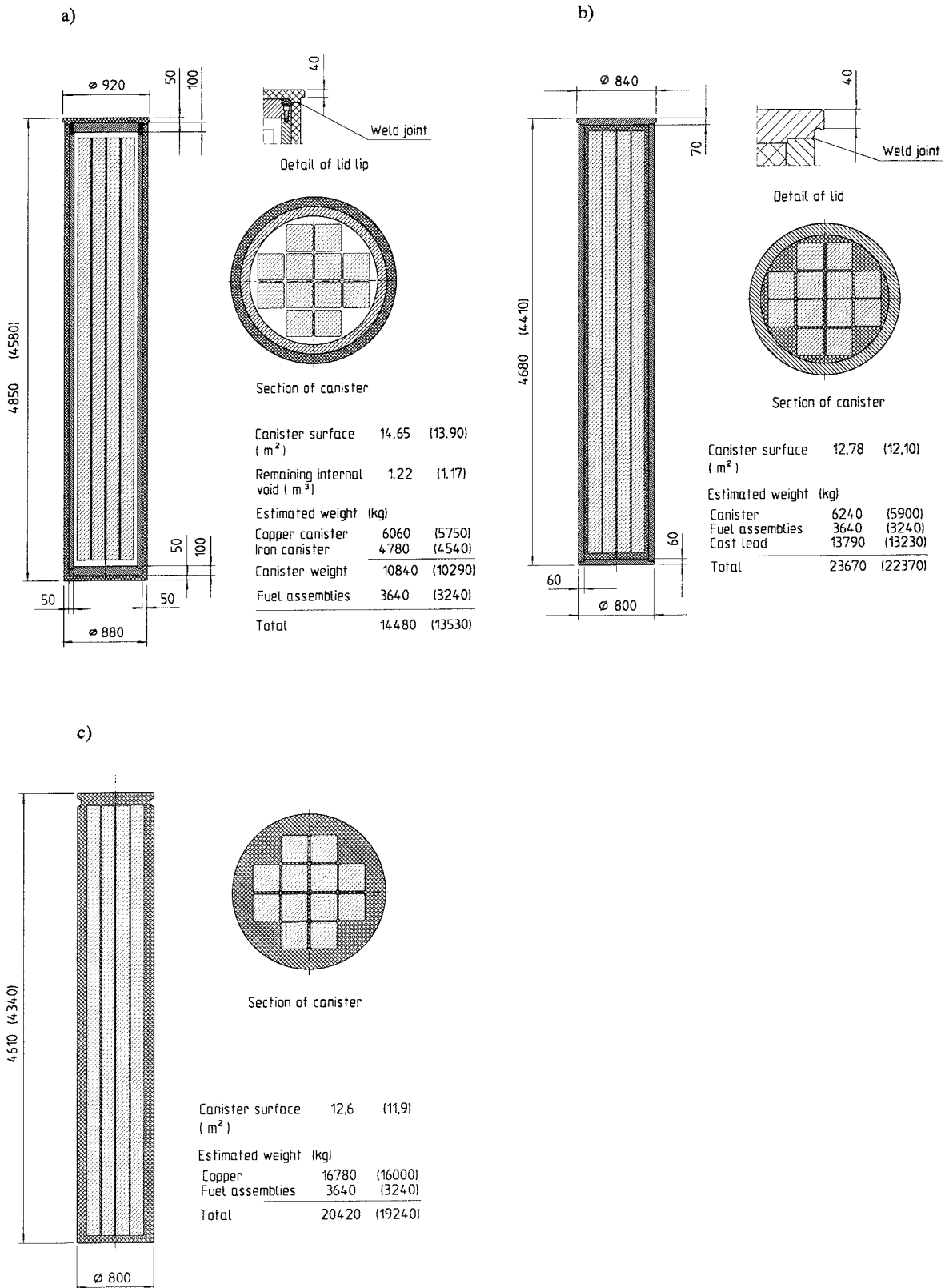

Figure 4-3. a) composite canister copper/steel
 b) lead-filled copper canister
 c) HIP canister.

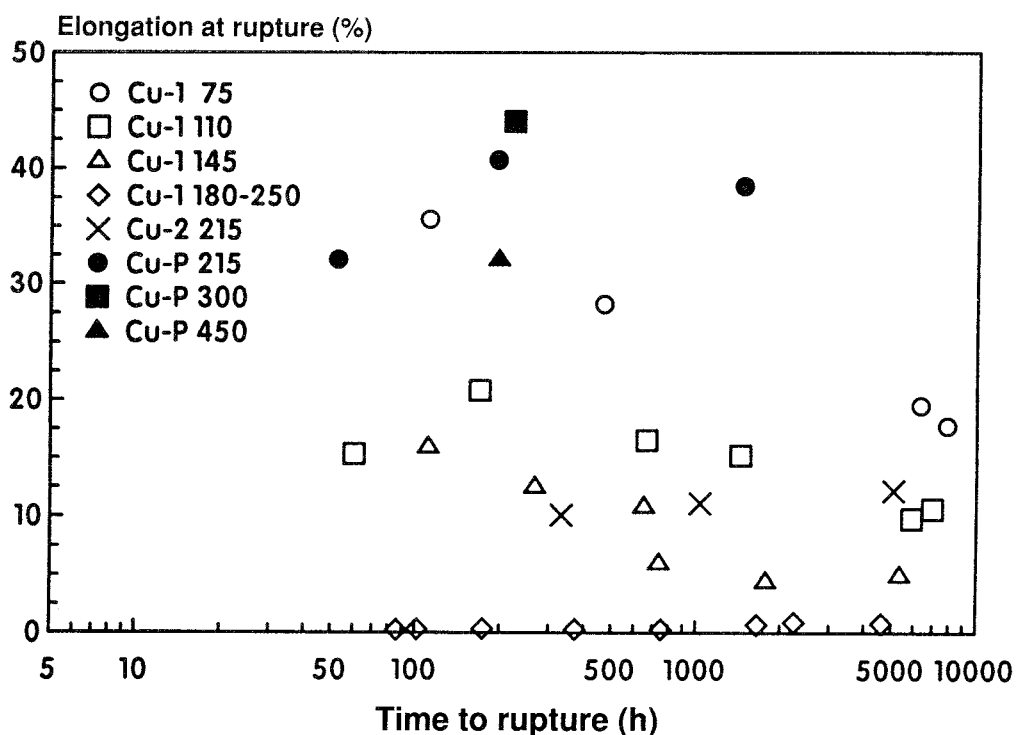

Figure 4-4. Elongation at rupture as a function of rupture time for two types of pure oxygen-free copper (Cu-1 and Cu-2) and for an oxygen-free copper micro-alloyed (50 ppm) with phosphorus (Cu-P) (from /4-11/).

oxygen-free copper has unacceptably low creep ductility at elevated temperatures. As is evident from Figure 4-4, the creep ductility of pure oxygen-free copper decreases to below 1% in the temperature range 180 to 245°C, while for phosphorus-containing oxygen-free copper it remains at a satisfactory level. In view of these results, the expert group judges pure oxygen-free copper to be an unsuitable material grade, at the same time as it recommends continued creep tests and creep relaxation tests to further verify the material properties of the copper grades that do not exhibit reduced creep ductility.

Residual stresses after fabrication

Residual stresses after sealing of the canisters have been calculated for both welded copper/steel canisters and for HIP canisters. When the canisters are sealed by welding, the maximum stress will lie in the range 70 MPa to 100 MPa, depending on the gap between the outer copper shell and the inner steel cylinder. The stresses are concentrated in the weld zone. For HIP canisters, the corresponding maximum value is about 90 MPa, but with a residual stress of about 50 MPa along the entire canister surface. In both of these cases, a considerable portion of the stresses will quickly relax due to creep deformation. The residual stresses for lead-filled canisters are deemed to be on comparable magnitude.

The stress levels for all canister alternatives studied are so low that there is no risk of creep fracture if the phosphorus-containing copper grade is used.

Rock movements

Model calculations show that rock movements of up to 10 cm will not constitute any threat to the integrity of the canisters.

Recommendations

The collective judgement of the expert group was that the copper/steel canister was the most advantageous alternative from a mechanical viewpoint. The group also identified questions which require further elucidation through research and development during the next few years. These questions are dealt with below.

4.1.4 SKB's conclusions

The work that has been carried out up to 1992 has shown that copper is a well-suited canister material not only from a corrosion viewpoint but also with regard to other material properties. A composite canister with an outer copper shell over a supporting steel canister has been judged to be the most advantageous alternative from the mechanical viewpoint. Furthermore, the results of the PASS project have shown that this alternative is preferable from other viewpoints as well [4-12]. The composite canister has therefore been chosen for encapsulation of spent nuclear fuel. The lead filling technique will be further investigated as a second-choice alternative.

4.2 GOAL OF THE ACTIVITIES

The goal of the canister material studies during the period 1993-1998 will be to determine which copper grade is to be used and to develop welding technology, fabrication technology and methods for non-destructive testing so that full-scale canister fabrication is possible around the year 2000.

4.3 PROGRAMME 1993-1998

Research and development efforts will be focused on:

- completing the studies within the field of corrosion concerning:
 - the premises for stress corrosion cracking of copper,
 - corrosion and radiolytically induced stress corrosion cracking on the inside of the steel canister,
 - local corrosion in an oxygen environment.
- selecting a suitable copper grade with respect to creep deformation and creep failure as well as weldability by 1996;
- development of fabrication technology, welding technology and methods for non-destructive testing.

4.3.1 Corrosion

The corrosion properties of copper have been relatively well investigated and will require only minor research efforts during the coming years. Some questions surrounding local corrosion on the copper canister under mildly oxidizing conditions may need to be explored further, but since oxidizing conditions are only expected to prevail in the repository for a short time after deposition and sealing, these studies will not be given high priority. In addition to these activities, the premises for stress corrosion cracking on copper will require further elucidation.

There is also a certain risk of corrosion on the inside of the steel canister. With the limited quantity of corrodants that could conceivably be enclosed inside the canister, this does not constitute a problem if the risk of stress corrosion cracking can be neglected. Species that can induce stress corrosion cracking could, however, be

formed by radiolysis of humid air inside the canister. This risk is eliminated in a dry inert atmosphere.

The consequences of corrosion on the internal steel parts after penetration of the outer copper shell have not yet been completely explored. This applies above all to pressure build-up caused by the growth of corrosion products and the consequences of hydrogen gas production in the repository. Furthermore, the risks of radiolytically induced stress corrosion cracking on the inside of the steel canister must be further studied.

4.3.2 Alternative designs – lead filling

As mentioned above, a lead-filled copper canister is a second-choice alternative to the composite canister. From the viewpoint of corrosion, this canister is naturally equivalent to the composite canister up until penetration of the copper shell.

Remaining uncertainties mainly have to do with the fabrication technology. The most important questions concern the technology of filling a full-sized canister with lead and control of the solidification process for the lead. This will be studied by modelling the lead casting process and by means of practical tests on a model scale.

Beyond this, the problems surrounding sealing by electron beam welding must also be explored. Of particular importance are the temperature conditions around the weld zone and in the upper part of the lead fill, where there is a risk of remelting of the lead.

4.3.3 Welding of copper

At present, electron beam welding is the most interesting alternative, with friction welding as a second-choice alternative. The development work on electron beam welding over the past few years has mainly been focused on developing systems for welding without a vacuum. This work has been conducted by SKB within an international cooperative project. The technology is now available, and the method will be tried out for welding of thick copper sections during the coming year.

The application of both methods for electron beam welding – in a vacuum chamber and under atmospheric pressure – is currently being explored. The latter method provides much greater flexibility, but cannot handle the same metal thicknesses as conventional electron beam welding. The results of the development work during the next two years will be crucial for the final choice of method, which should be able to be made by not later than 1995.

The development of welding technology for a full-sized copper canister will be given high priority during the period. The development work will then be concentrated on welding of full-sized prototype canisters.

4.3.4 Fill material

After filling with fuel, the composite canister has a void volume of about 1 m³. The risk of criticality for certain canisters, if they should be filled with water after canister failure, cannot be ruled out at the present time. For this and other reasons it may prove desirable to reduce the void volume by post-filling with a particulate material. The material may either be relatively inert, such as quartz sand or glass beads, or it may be chemically or nucleophysically active.

Further studies are planned before it is determined whether a solid fill material is to be used and, if so, which material is preferable.

4.3.5 Post-fabrication inspection – NDT

All steps in fabrication, forming and sealing of the canister must be checked and documented. For the steps prior to packing of the spent fuel and sealing, this can be done using conventional methods, although specific refinements may be required. A methodology and technology for inspection of the sealing weld will have to be developed, however. This may also entail inspection of the microstructure of the copper material and the design of the weld.

This development work is being given high priority and must be carried out in close collaboration with development of the weld technology. Previous studies have shown that ultrasonic testing is a feasible method, but the technology must be optimized for copper and for detection of weld defects that are typical for electron beam welding. An alternative, or complementary, method may be X-ray tomography. Development work will also be aimed at evaluating the potential of this method for inspection of the sealing weld on the canister.

5 BUFFER AND BACKFILL

5.1 BACKGROUND

The primary function of the engineered barrier constituted by the bentonite buffer around the canister is to limit groundwater transport in the near field and to provide chemical and mechanical protection for the canisters.

Mixtures of bentonite and sand are intended to be used for backfilling of excavated tunnels, rock caverns for service, etc. as well as channels of access from the surface, whereby its primary function is to limit the possibility of radionuclides to migrating along these channels.

5.2 GOALS OF RD&D ACTIVITIES 1993–1998

The choice of quality and composition of the buffer and backfill materials should be able to be made around 1995. The choice will serve as a basis for the 1996 safety assessments of the two candidate sites and for design and planning of the deep repository. During the period 1993–1995, summaries shall be made of

- knowledge of the properties of bentonite,
- methods for determining these properties, and
- calculation models for describing the homogenization of the buffer and long-term buffer performance.

The research on material parameters will then be scaled down and focused primarily on studies of natural analogues for validation of the models. When it comes to the physical models – rheology etc. – validation will be done both on a laboratory scale and through field tests in the Äspö Hard Rock Laboratory. The latter will dominate and the results obtained will be used for continuous updating of the material models. In parallel with this, a development/adaptation of technology needed for excavation of canister positions, deposition of canisters, backfilling etc. will be carried out, see chapter 11.

5.3 PRESENT-DAY STATE OF KNOWLEDGE

General

It was stated in R&D-Programme 89 that special efforts would be made during the period 1990–1995 to develop a general rheological/thermomechanical model and to develop material models that relate the microstructure of bentonite buffer and clay/sand mixtures to water flow, diffusion and thermal conductivity. It was further stated that the programme was aimed at deepening knowledge concerning the interaction of the buffer or backfill with the host rock. The efforts were particularly aimed at the character of the “disturbed zone” and at the possibility of creating stagnant groundwater regimes or diverting groundwater flows.

The need to be able to effectively compact backfills of clay/sand materials was also noted in the programme.

In summary, the following main areas were specified in R&D-Programme 89. They are dealt with in this account.

- Temperature-induced degradation processes in bentonite, alteration of smectite minerals and cementation.
- Development of a general material model that describes the mechanical, rheological, thermal and water-transporting properties of bentonite materials and clay/sand mixtures.
- Clarification of the importance of the microstructure for transport processes such as water flow, ion diffusion and thermal conductivity.
- Description of near-field rock, especially the “disturbed zone”, and investigation of possible ways to influence its conductivity.
- Modelling of interaction between near-field rock and buffers or backfill.
- Material and technology for backfilling of shafts and tunnels.

Degradation processes in bentonite

During the years 1989–1991, when the chemical resistance of the bentonite materials were investigated in a comprehensive study in the Stripa Project, attention was focused on two degradation processes that were known previously but could now be quantified /5-1/.

One is the cyclical “evaporation/condensation” process connected with water saturation of bentonite exposed to a temperature gradient that was identified in the Buffer Mass Test at Stripa. In the case of groundwater with a high salinity, this could lead to salt enrichment near the canisters.

The other is the process of silica release connected with temperature-induced dissolution of smectite mineral that was examined in laboratory tests. This silica, which precipitates in connection with cooling, condenses in such a manner that it can give rise to significant cementation and thereby affect the plasticity and swellability of the clay in a practically meaningful manner. Extensive investigations of montmorillonite (the most common smectite mineral) under hydrothermal conditions and with different kinds of pore water have shown that the changes mainly concern the microstructural particle arrangement. The waters used have been distilled water, strongly brackish water of the Forsmark type, i.e. with Ca as the dominant cation, and seawater diluted 1:3. The temperature has been up to 200°C and the treatment time up to nearly one year.

Two opposing processes take place: a) a partial dehydration that entails a reduction of the number of interlamellar hydrate layers, accompanied by an increase of the interlamellar space between the quasicrystals of “lamellar stacks”, and b) a thermally induced disintegration of these stacks resulting in a microstructural homogenization. The results show that the physical properties are largely retained by both Na and Ca bentonite at densities in excess of about 1.8 g/cm³.

A structural transformation to non-expansive minerals (called 10 Å minerals) can take place either through a permanent collapse as a consequence of complete dehydration of the lamellar stacks, or through transformation of the lamellar stacks to mixed-layer montmorillonite flakes and flakes of hydrous mica (illite) and neoformation of hydrous mica in the voids between the lamellar stacks.

The first-named phenomenon, dehydration of the lamellar stacks, is only of practical importance at temperatures above around 130°C. The investigations also verify the previously adopted model for the alteration of montmorillonite, which means that it is access to potassium in free form that is the determinant, at least at temperatures above 60-70°C. At temperatures higher than about 130°C there is a more powerful impact, particularly on Na montmorillonite, probably as a consequence of a transformation from montmorillonite to beidellite (an aluminium-rich smectite mineral), which spon-

taneously – independently of temperature – is converted to hydrous mica in the presence of free potassium.

The implications of the research of the past few years can be summarized as follows:

- At temperatures in the range 70-130°C, the primary degradation mechanism is a dissolution of the montmorillonite component with the release of Si and Al, resulting in the neoformation of hydrous mica at a pace determined by the in-transport of potassium. Released silicon and aluminium that are not bound up by such neoformation are precipitated at cooling and give rise to cementation.
- At temperatures above 130°C, the quantity of dissolved silica and aluminium increases. An excess of silica is obtained as a consequence of the transition to beidellite. This excess leads to precipitation of cementing silica, primarily in amorphous form.
- The kinetics of the dissolution of the smectite is primarily determined by the concentration of silica in the pore water in the clay and in the fracture water in the surrounding rock, as well as by the rate at which neoformation of hydrous mica takes place, in other words the process that binds silica. Ultimately, when the temperature has fallen to its original level, a smaller quantity of smectite is dissolved and the quantity of released silica per unit time can be the controlling factor for the rate of neoformation, even with rapid in-transport of potassium. The temperature gradient in the bentonite surrounding the canisters becomes the controlling factor for the scope of the cementation due to precipitation of silica.

General material model

The purpose of the development of a general material model that describes mechanical, rheological, thermal and water transporting properties is to make it possible to describe the entire physical course of events in the highly compacted bentonite that surrounds the canisters /5-2/. The purpose is to be able to predict with reasonable accuracy, with the aid of calculation programs (type ABAQUS), all processes from the original state with the saturated or unsaturated bentonite subjected to a transient temperature gradient which can lead to redistribution of the original water content, via the phase with water uptake, swelling and homogenization, to the end stage with a possible cementation and gradual transformation of the smectite mass to hydrous mica. The model shall also make it possible to describe the stress situation in the bentonite and the canisters as a consequence of tectonically or thermally induced displacements along flat-lying fracture planes in the rock. At the present time, the mechanical processes can be described to some extent, while those that have to do with the maturation process remain to be modelled.

Microstructure and transport processes

A general microstructural model (GMM) for smectite clays was developed during 1989–1992 for qualitative and quantitative determination of hydraulic conductivity as a function of density, electrolyte content and type of electrolyte /5-3/. The model, which also provides information on temperature impact and a semi-quantitative picture of the dependence of swelling pressure on density, provides an explanation for the differing properties of Na and Ca bentonite.

Interaction between near-field rock and buffer after backfilling

The experimental determination of the character and permeability of the near-field rock in the last phase of the Stripa Project confirms a previously outlined general

model for how the hydraulic conductivity of the near-field rock is affected by blasting and stress redistribution. Field tests at Stripa have provided an indication of how and to what extent sealing can be accomplished by grouting with bentonite- or cement-based materials. In an earlier phase, a practical case involving sealing of a slot around a shaft was carried out successfully, and a combination of these methods is judged to offer the best means for effectively shutting off the water flow in the axial direction.

Backfilling of shafts and tunnels

Shafts and tunnels should not leave behind highly conductive connections between the biosphere and the canisters. Backfilling must be done regardless of the detailed design of the repository system.

The backfilling requirement is determined by local conditions as regards the permeability of the rock, fracture orientation, hydraulic gradient and adjacent water-conducting conduits, as well as the need for and chances of achieving effective local plugging. Large parts of the backfill can consist of highly compacted moraine clay, relatively bentonite-poor mixtures of materials of glacial origin, or crushed rock.

Material characterization

Special attention has been devoted to quality assurance for buffers and backfills ever since the mid-1980s, when the choice of bentonite material led to the definition of necessary properties in about 7 000 tonnes of bentonite material of Sardinian origin for isolation of the concrete silo in SFR /5-4/.

In order to obtain a basis for comparison between different bentonite materials and a standard against which to test whether offered or delivered material is acceptable, a method for characterization has been developed and tested. It comprises the following testing steps:

- Chemical analysis
- Mineralogical analysis (XRD)
- Swellability (XRD, EG)
- Cation exchange capacity
- Microstructural study
- Grain size distribution
- Hydraulic conductivity
- Swelling pressure and swelling capacity
- Liquid limit
- Creep properties
- Thermal conductivity

Summary of research results

Transport properties

The transport properties of the highly compacted bentonite in terms of hydraulic and thermal conductivity are known today to be a function of mineral content, density, temperature and chemical pore water composition. They can be described by a general microstructural model that will be further refined to describe ion diffusion transport and the influence of mineral alteration as well. A model for chemically induced alteration to non-expanding minerals (hydrous mica), taking into account related cementation processes, has been formulated and will be used in both future

laboratory tests with artificial conversion of montmorillonite-rich bentonite and on some well-defined geological examples.

Mechanical properties of the engineered barrier

The rheological properties of highly compacted bentonite as a function of mineral content, density, temperature and chemical pore water composition are partially understood today, and functioning preliminary material models and calculation techniques exist. Deeper knowledge will provide the basis for formulating a more complete material model which will make it possible to predict the entire sequence of changes undergone by canister-embedding bentonite under the influence of temperature, pore water chemistry and tectonics.

5.4 PROGRAMME 1993–1998

General

During the years 1993–1995, the work will be concentrated on characterization of bentonite-based materials and development of models for prediction of the behaviour and performance of such materials in a final repository. During 1993–1998, large-scale tests in the Äspö Hard Rock Laboratory will be planned and commenced to demonstrate essential functions that have not been able to be fully tested at Stripa. Examples of tests to be conducted in the Äspö Hard Rock Laboratory are: electrolyte enrichment during the course of water saturation, spontaneous penetration in fractures, gas percolation and canister deformation. An important task is to study more thoroughly the physical and physical/chemical interaction between buffers and near-field rock.

Transport processes

Ion transport and changes of microstructure and mineral composition caused thereby are described phenomenologically and quantitatively with the aid of a refined version of the microstructural model. It yields information on how the mineral phase and the microstructural porosity are distributed in the clay matrix and also provides means for quantitative modelling of cation and anion diffusion as a function of density.

Mechanical processes

Material models and calculation technique for describing mechanical processes etc. will be developed during the period. A description of more complete and functioning models for material selection and calculation procedure will be included in a final document that will update the state of knowledge in 1995.

Material characterization

The characterization method that was employed during 1990 and 1991 to describe three commercial bentonite materials will be utilized for characterization of additional materials, including bentonite/sand mixtures, in order to broaden the base for establishing a standardized procedure for material selection and calculation procedure.

6 GEOSCIENCE

6.1 INTRODUCTION

6.1.1 The role of the rock in the deep repository

Geologically speaking, Sweden is situated within the Baltic Shield, which mainly consists of rock types which are more than 900 million years old. The dominant crystalline bedrock consists of granites and gneisses. The rock is an important precondition for the disposal of the spent nuclear fuel according to the principle that has been developed in Sweden. The purpose of the repository is, as mentioned previously, that the system of technical and natural geological barriers shall isolate the waste for a long enough period of time that the radioactive materials decay to natural background radiation levels. Direct radiation from the waste can be prevented by an intact crystalline rock block several metres thick. The only way in which waste deposited deep down in the rock can affect humans, animals and plants is therefore a transport of radionuclides from the repository with the groundwater in the rock to the biosphere. This transport can take place in the bedrock's fracture system. In general, the groundwater flux in fractured crystalline bedrock in Sweden is very low at deeper levels, and for this reason the repository is planned to be built about 500 m below the surface of the ground.

The geoscientific research at SKB is related to the crystalline bedrock and to the projected repository design. The research work is guided primarily by the need for input data for the long-term safety assessments that are being done. Furthermore, the geoscientific R&D work is supposed to be of benefit in solving the civil engineering problems that are associated with the construction of a deep repository.

The rock has a number of fundamental properties that are being exploited for the long-term performance and safety of the repository. These are:

- Mechanical protection.
- Chemically stable environment.
- Slow and stable groundwater flux.

These properties can be more or less coupled to each other through physical or chemical processes.

The rock provides long-lasting mechanical protection against external forces. A final repository in rock also provides good protection against changes in climate. Climatic changes can result in a changed biosphere with a considerably higher sea level, or alternatively can give rise to permafrost and formation of glaciers, with a lowering of the sea level as a result. The impact of such changes is minimized if a repository is placed in deep geological formations.

It is of fundamental importance for the safety of the repository that the chemical environment is stable. The reducing chemistry of the groundwater is of great importance for the life of the canister and for the slow dissolution of the fuel matrix. Groundwater chemistry is determined for the most part by the mineral composition of the rock, which is stable over long spans of time. The chemical environment of the rock is also important for how radionuclides can be transported. Here the interaction between nuclides and rock is of importance.

The low groundwater flux in the rock is of importance both for the durability of the barriers and for the slow transport of nuclides in the rock. The water flux is generally determined by the topography of the ground surface and by the permeability of the rock, which is in turn dependent on its fracture content. These factors are all very stable by their nature. For this reason, the groundwater flux around a repository will not change significantly with time.

For an assessment of the performance of the final repository, the components of the repository and their interaction must be described. Since it is difficult to clarify how this interaction takes place in a long perspective on a specific site by means of experiments, theoretical models are used. The extent to which the models can be verified is of fundamental importance for safety assessments. Large volumes of a heterogeneous medium have to be described. This description is often based on a large number of point data from boreholes, which are then generalized to different scales according to the specific problem to be analyzed. Data on the groundwater's local flux and its chemistry are needed to calculate canister life. More information is required to describe how nuclides are fixed and transported in the rock. It is an urgent task for the ongoing research on the bedrock to test the validity and limitations of different models.

6.1.2 The principle for investigations in crystalline rock

Historically, geoscience has been a descriptive science in which most interest has been devoted to the genesis and general properties of the geological formations. The emphasis on applied geoscience within the field of nuclear waste management imposes higher demands on quantification of processes and predictions of the future. The great heterogeneity of the rock means that generalizations cannot be made without the variability of different rock properties also being described. When it comes to the hydraulic conductivity of crystalline rocks, for example, the difference in mean values between different rock types is smaller than the variation within each rock type. Furthermore, the properties and their variation can depend on the scale on which a given problem is regarded.

In other words, it is important that investigations in rock be conducted incrementally (on different, increasing scales) and iteratively, resulting in a gradual knowledge build-up with increasingly detailed information. A statistical approach is required to a greater extent than before in order to describe the bedrock, see Figure 6-1.

The following scales are usually discussed for the function of a deep repository:

- Regional scale (1–10 km)
- Site scale (100–1000 m)
- Block scale (10–100 m)
- Detailed scale, near field (0–10 m)

On the regional scale, the repository is studied in its large-scale general context, for example with respect to isostatic uplift, tectonic stability and regional hydrological cycles.

On the site scale, the repository is studied as a whole with its impact on its surroundings. Flow and transport in far-field modelling are examples of important parts of a safety assessment for a repository.

The block scale describes differences in properties within the repository, while the near field is usually defined as the area nearest the waste. The near field is assumed to be affected by the waste itself or by the disturbance caused by the rock excavation and is dependent on the repository design.

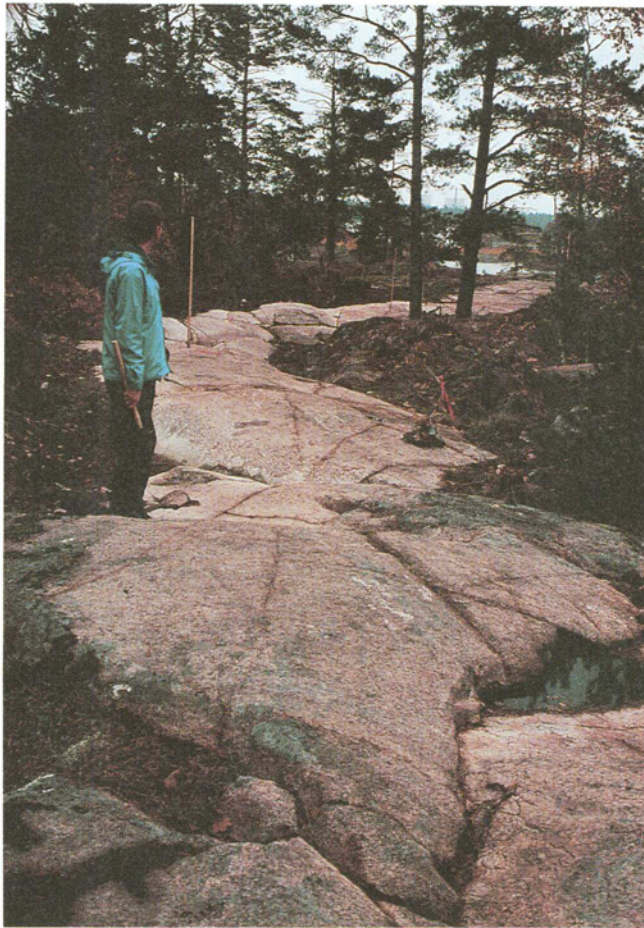

Figure 6-1. Geological and hydrogeological investigations were performed on different scales within the Äspö Project's pre-investigation phase. The picture illustrates the fracture mapping on outcrops that took place in cleaned and prepared trenches.

In summary, the principle of investigations in rock is a gradually increasing degree of detail in the following work sequence:

- Data collection, observations.
- Setting up of a conceptual model of the area with regard to structures, chemical and physical premises (conceptual model).
- Calculation phase.
- Analysis.

6.1.3 Scope and coordination of the geoscientific activities

The geoscientific programme at SKB embraces broad knowledge build-up within geology, geophysics, rock mechanics and geohydrology. The programme also includes method development and development of numerical computer models. A strong link exists to SKB's programme for instrument development, see chapter 9.

The activities and the projects within the geoscientific programme are often coordinated with other special areas, such as geochemistry and hydrochemistry. Furthermore, the work is integrated with the research activities that have been conducted or are being conducted within:

- The Stripa Project
- The Äspö Hard Rock Laboratory
- Project Alternative System Studies (PASS)
- Safety assessments (e.g. SKB 91)
- Natural analogues
- The siting programme

The above programmes and projects are described in separate chapters in the present RD&D programme or as separate background reports.

6.1.4 Overall goals of the geoscientific programme

The geoscientific research and development programme at SKB has the following general goal:

- to further refine knowledge of hydrogeological and rock-mechanical conditions in order to permit better quantification of uncertainties and margins in the rock's capability to isolate the waste, in preparation for the siting process.

Important subsidiary goals are thereby:

- to further refine models for calculation of groundwater in fractured rock, for water flows in conjunction with glaciation and deglaciation, for coupled phenomena such as temperature, rock stresses and hydraulic conductivity and for rock mechanics at a pace that is adjusted to the need for models in connection with assessments of the performance and long-term safety of the candidate sites.
- to see to it that suitable measurement technology is available for high-quality collection of such measurement data as are required to characterize the rock volume or volumes that will be investigated in preparation for the construction of SKB's deep repository for spent nuclear fuel.

State of knowledge, results obtained (1989-1992), future goals and programme for the RD&D activities pertaining to groundwater movements, rock stability, groundwater models and rock-mechanical models are presented in the following sections.

6.2 GROUNDWATER MOVEMENTS – CONCEPTUAL MODELLING

6.2.1 Goals of the activities 1993–1998

The main topic that will be treated within the framework of SKB's general geoscientific activities when it comes to groundwater hydraulics is regional conditions for flow and transport. Physical and certain chemical processes coupled to the geohydraulic system will also be dealt with. For nuclide transport and redox-related flow problems, see SKB's RD&D programme for chemistry (chapter 7) and natural analogues (chapter 8). Site-specific geoscientific RD&D with geohydrology and groundwater transport is being conducted at the Äspö Hard Rock Laboratory (see separate background report). Hydrogeological investigation methods are dealt with in chapter 9, "Methods and instruments".

The research and development work for the conceptual modelling is predicated on the following premises. The groundwater flow is chiefly laminar and can be described by Darcy's Law. The flow takes place for the most part in the bedrock's fracture system and the hydraulic driving forces at repository level are controlled by gradients in a

regional perspective. The permeability properties vary within wide limits and are dependent on groundwater chemistry, rock-mechanical conditions and temperature.

The goals of the RD&D programme for the period 1993–1998 are to:

- Further refine methods for description of the geometry and hydraulic properties of fractures.
- Further refine in-situ methods for determination and analysis of hydraulic properties in fractured rock.
- Investigate the large-scale dependence of the hydraulic properties on fracture mineralizations, rock stresses and former permafrost depths.
- Investigate and compile indirect signs of the groundwater's flow pattern in fractured rock for both model structuring and confirmation of models.
- Investigate risks of brief pressure changes in the groundwater reservoir at repository level due to earthquakes.
- Describe the premises for groundwater flow and transport at a deep repository in a regional perspective during the present-day climate situation.
- Describe the premises for groundwater flow and transport at a deep repository in a regional perspective during glaciation and deglaciation.
- Further refine theories for "non-reactive" flow transport in fractures and fracture systems.
- Compile and structure geostatic data used for safety assessment and constructability assessment.

6.2.2 State of knowledge

During the past decade, theoretical and experimental studies have contributed to a gradually increasing understanding of the heterogeneous flow process in the fractures in the rock. Use of geostatistical methods and fractal characterization of hydraulic conductivity, fracture lengths and fracture apertures as well as knowledge of two-phase flow and multi-porosity systems have increased. Geophysical methods have been developed into valuable complements to hydraulic tests, yielding better data for the model work /6-1/. Greater interest is being devoted to processes coupled to the groundwater flow, i.e. thermo-hydro-mechanical connections and hydrochemical dependencies. Several projects pursued by SKB during the past few years aimed at a better understanding of the flow process are commented on below. The reader is also referred to the annual reports and to the TR series of reports.

From several investigations that have studied flow gradients around a blasted tunnel, it seems as if the hydraulic conductivities decrease nearest the tunnel wall. At first the results were considered surprising, since increased permeabilities were expected to result from the blasting damage /6-2/. However, the phenomenon is now well-known and the explanation has been sought in stress redistributions and chemical precipitations. There was also another explanation, namely that the conductivity decrease could be a phase-boundary mechanism between air or another gas and water. The process would then be controlled by a two-phase flow. Preliminary theoretical calculations show that this may be the case /6-3/, but further research is needed. For the water-saturated state, however, conductivity increases can be expected, especially in the axial direction. Preliminary results for Stripa /6-4/ show this.

Better conceptual bases are desirable for groundwater and transport modelling in fractured rock. In Swedish crystalline bedrock, for example, red coloration of feldspar crystals is common in connection with fracture planes. The colour alteration could be one of several signs of possible flow paths for hydraulic models. Similarly, preliminary results indicate that the sorption possibilities are likely to be more developed in

the red-coloured volumes at greater depths. The red coloration there is caused by a hydrothermal process (influence of hot water solutions), whereby the plagioclase lattice has weathered. The samples often contain clay minerals. Further, susceptibility measurements show that magnetite has been transformed to haematite /6-5/.

When nuclear waste is placed in the rock, convection currents can be created in the groundwater reservoir due to the heat generated by the canisters. An interesting aspect of such thermally induced flow is whether a density-stratified groundwater can balance the flow system. For example, canisters can be placed in a saltwater environment overlain by a fresh water cushion. A modified Hele-Shaw cell has made it possible to study this phenomenon and set up analytical criteria for this hydraulic system on a laboratory scale /6-6/.

Conceptualization in connection with hydraulic modelling includes credible boundary conditions. The three-dimensional models are becoming increasingly common, which means that progressively more complicated flow geometries are being analyzed. The greatest practical interest in conjunction with groundwater modelling for a repository is being devoted to levels about 500 m below the ground surface. With reference to classical groundwater theory, a deep repository can be expected to be influenced in terms of flow by regional groundwater systems. The local topography in a repository area probably has very little to do with the flow regime at the actual repository level /6-7/. The flow at the deep repository is controlled more by regional than local gradients. If it were possible to measure vertical pressure variations at model boundaries to a depth of 1 km with good accuracy, more realistic regional flow descriptions would probably be obtained compared with flows based on topographical data.

In the long time perspective from which the safety of the repository must be assessed, climatic changes with ice-age scenarios must be taken into account. In connection with an ice age like the most recent one to have affected Sweden, the sea level would fall by on the order of 150 m. This means that different boundary conditions would prevail for the repository during the deglaciation process than those we can estimate for the present-day climate /6-8, 6-9, 6-10, 6-11/. A fundamental point of view has been worked out by SKB in cooperation with TVO in Finland. A regional modelling of the situation during a deglaciation must take into account not only the sea level, but also the extent of the permafrost, ice loads, dammed ice lakes, increased water pressures under the ice and meltwater production.

Certain standardized evaluation systems have been during the past decade for classification of the vulnerability of the groundwater reservoir and groundwater resources. This is primarily intended to reduce the risk of contamination of superficial groundwater accumulations. The classification system has now been further refined to permit a rough assessment of disposal sites for radioactive waste from the hydrogeological point of view. Since knowledge of different sites in an evaluation phase can vary with respect to the extent of completed mapping surveys and pre-investigations, it is essential that the uncertainty level for the hydrogeological parameters be weighed into the assessments /6-12/.

6.2.3 Programme 1993–1998

In order to meet the goals presented above, SKB will carry out the following programme with regard to the conceptual view of groundwater flow.

When the flow process is to be described in fractured rock, and then particularly in discrete fracture models, values are assigned to conductivity and kinematic porosity. These parameters are dependent on the fracture width, which is in turn dependent on

the stress state in the bedrock. The relationship between mechanical and equivalent hydraulic fracture width is unclear when hydro-mechanical calculations are performed. There is a need for a better understanding of the hydromechanical processes in the rock mass on both a general and a detailed scale. The geometries and hydraulic character of fractures and fracture intersections need to be studied. This will mainly be done by means of experiments on a laboratory scale. The research tasks include collection of input data for calculation models and development of measurement methods for fracture characterization and porosity.

Development of in-situ methods for determination of permeability and storage properties in fractured rock is continuing. Extensive work is being done mainly within activities for gas and oil prospecting. The analysis methodology has been improved through the Stripa and Äspö projects, particularly when it comes to interference tests. Similarly, there is a need to obtain a better understanding of the dependence of the in-situ methods on scale, the heterogeneity of the rock, the direction of the measurements, what rock volume is covered by the measurements etc. This investigation work is planned to be done in connection with the Äspö Hard Rock Laboratory and the programme for method and instrument development. Test pumpings and hydraulic test determinations of k values and kinematic porosities are of very great importance in connection with detailed characterization in the siting programme.

It is well known that the hydraulic properties of the fractures in the crystalline rock are related to the extent to which mineralizations occur in the fractures. The mineralizations reflect the rock's tectonic history. Similarly, the rock stress situation is assumed to influence conductivity. Another mechanism that could influence the general conductivity distribution at depth is the former extent of permafrost. Recurrent glaciations have entailed freezing and thawing of the water content of the fracture systems down to a depth of about 500 m. It is known from detailed characterization that ice formation with subsequent thawing has resulted in increased conductivity. The general dependence of the conductivity on these processes should be further investigated.

The conceptual view of the groundwater's turnover and flow paths can be based in part on indirect judgements. For example, high salt concentrations in the groundwater can be a sign of low water turnover. Similarly, the oxygen isotope ^{18}O can provide information on regional flow patterns in a long time perspective. Mineralizations in fracture systems and geochemical changes in and on fracture walls may be indications of presumptive flow paths. When hydraulic model structures are built up, it is important to take into account all these supplementary data, which provide a qualitative picture of the groundwater's flow pattern. There is a great need for compiling indirect hydraulic signs for both model structuring and model validation.

The stability of the repository in the face of seismic disturbances has previously been investigated in a number of studies. They show that it is not likely that the mechanical stability of the repository will be disrupted by earthquakes in Sweden with the repository design that has been chosen. In more earthquake-intensive areas of the globe, however, brief disturbances in the hydrological balance have been observed in connection with earthquakes. Depending on what rock movement takes place, either momentary hydraulic pressure falls or rises can be obtained. These momentary pressure changes should be investigated with respect to magnitude, direction, duration, tectonic processes and depth. Furthermore, the extent to which viscosity changes in the repository's bentonite buffer can be obtained in connection with a short-lived hydraulic pressure change should be taken into account.

In section 6.2.2 "State of knowledge" it was commented that the natural water flux at repository level is not necessarily controlled by the local flow gradients, but is more

likely controlled by regional topographic conditions. It is judged essential to further refine regional flow models that shed light on long-term transient changes. This is especially true for coastal repositories, where the transient flow changes can be affected by glaciation, deglaciation, land uplift and the salt/fresh water boundary, which in turn alter the boundary conditions of the calculation model. To obtain a better understanding of the water flux in a regional perspective and at depths down to 1 500 m, a hole to this depth is planned to be drilled in 1992 within the Laxemar area near the Simpevarp peninsula in the municipality of Oskarshamn. After concluded drilling, geophysical, hydrochemical, geochemical and hydraulic investigations will be performed in the hole.

The transport process for groundwater in the bedrock involves a large number of physical and chemical mechanisms. Substances that are transported can be affected by physical mechanisms such as filtration, hydrogeochemical mechanisms such as ion exchange (absorption-desorption), redox reactions, precipitation-dissolution and radiological and biological effects. These processes and related research requirements are dealt with in chapter 7. If the water transport takes place without the influence of these mechanisms, it is non-reactive and only involves non-sorbing substances. The non-reactive transport process includes advection (convection), molecular diffusion and kinematic dispersion. Advection takes place with the free water in the available kinematic flow porosity. For low-permeability media under water saturation, the international literature contains indications that the kinematic porosity is dependent on the hydraulic gradient, but the phenomenon has not been fully explored. Molecular diffusion entails that a substance is transported from areas with high concentrations to areas with low concentrations. Kinematic dispersion is a "mixing phenomenon" that is dependent on velocity differences for the flow in a fracture as well as velocity differences between different fractures. The flow is mixed through intersecting fractures, resulting in changes in the concentrations of the substances in time and space. It has been found that the classic dispersion equation only seems to be valid after long flow times and for great distances from the release point. The dispersion connected with instantaneous releases, for example, is probably controlled by time-dependent dispersion coefficients and not by any scale effect in space /6-15/. The channelling theory and matrix diffusion effects have generally increased our knowledge of the transport process /6-16/, but there is a need for theoretical and practically oriented further refinement. A better knowledge of the hydraulic heterogeneity and pore structure of the bedrock is thereby an important prerequisite for being able to predict both non-reactive and reactive transport.

In a safety and constructability assessment, a large number of hydrogeologically related parameters are included when the bedrock is described and modelled. Some of these parameters can be measured in the field, while others are measured in the laboratory or calculated. The safety assessment, such as SKB 91, is stochastic, and the properties of the rock mass are accordingly dealt with as statistical. Groundwater models often have – and rock-mechanical models are expected to be developed towards – a statistical orientation. In a siting process, the body of investigation data grows continuously and gradually improves our site-specific understanding of the repository's surroundings, i.e. the geobarrier. A systematic geostatistical treatment of data appears to be necessary, and it should apply to both field data and other experimental data which are used in judging safety and constructability. Statistical theories should be treated within the framework of "Geoscience", for example prediction methods and multivariate analysis. Furthermore, the statistical properties of different geodata should be compiled, which is included in safety assessment and constructability assessment. The above sub-programme has a bearing on the project

“Rock volume description” within the Äspö Hard Rock Laboratory and shall serve as a basis for data handling and analysis at the siting programme’s candidate sites.

6.3 STABILITY OF THE BEDROCK

6.3.1 Goals of the activities 1993–1998

Site-specific rock mechanics questions relating to a repository facility are mainly being dealt with within the Äspö project. More fundamental strength-related activities and tectonic assessments are included within the rest of SKB’s general geoscientific programme.

The overall purpose is to quantify and examine the consequences of earthquakes and glaciations with subsequent land uplift. For this reason, existing knowledge is being compiled and our understanding of the geodynamic processes in the Baltic Shield is being further refined.

The goals for the period 1993–1998 are to:

- Carry out a seismotectonic synopsis of the Baltic Shield.
- Carry out a pedagogical synopsis that shows the brittle tectonic history of the Baltic Shield with the load situations that have occurred.
- Study in detail and map isostatic uplift in different regions of Sweden.
- Carry out detailed studies of former shorelines in several regions of Sweden in order to clarify any postglacial tectonics.
- Increase our knowledge of the brittle tectonic fragmentation of the crystalline bedrock.
- Further refinement of dating methods of movements in fracture zones.
- Increase our understanding of the representativeness of rock stress measurements.

6.3.2 State of knowledge

General about tectonics and seismic activity

Tectonics is a collective term for the deformation of the earth’s crust and the structural forms that occur as a result. The term covers deformational and structural forms from the millimetre to the kilometre scale.

A brief resumé of the studies conducted at SKB during the period 1989-1992 is provided here. See also SKB’s annual reports /6-13, 6-14/ and reports in the TR series.

It is essential to have an understanding of the brittle tectonic evolution of the Baltic Shield in order to be able to describe the fracture systems and previous movements in the Swedish bedrock. The stress situations that have arisen during continental drift, “the paleostress field”, can be roughly analyzed based on the presence of different types of hypoabyssal rocks, fracture sealings, fracture minerals etc. and related to different time periods. It is further possible based on isotope data to indicate former vertical loads from sedimentary strata that have eroded away. Successive glaciations have also affected the load situation in the Swedish crystalline basement. The Swedish bedrock has thus in all likelihood been subjected to forces in all directions. During the current tectonic regime, spreading from the Mid-Atlantic Ridge, there are therefore no signs that new fractures or zones will appear in the upper part of the crust in Sweden. If movements take place in the earth’s crust in Sweden, they will accordingly take place as reactivations in existing fracture zones or faults. A synopsis of the brittle

tectonics of southern Sweden is presented in /6-28/. Several other regional studies exhibit similar results with movement activation /6-29/, /6-30/, /6-31/.

Southeastern Sweden has a stable bedrock geology. A detailed fracture mapping of the Ordovician limestones on northern Öland has yielded an understanding of how common movements are and what their magnitudes have been. The movements in the limestone on Öland must have taken place more recently than 450 million years ago. 90% of all fractures show no movements. 10% of the fractures thus exhibit displacements, and the peak slip has been measured to be 5 cm /6-31/.

The seismic activity in the Baltic Shield is mainly controlled by the plate-tectonic processes and ongoing land uplift. The results of seismic measurements /6-43, 44, 45/ show that most of the stress that causes earthquakes has a compression direction of N60W, which is approximately perpendicular to the continental movement from the Mid-Atlantic Ridge. The globe-spanning database “World Stress Map Project” also shows relatively good agreement between the plate tectonics of the earth’s crust and the greatest horizontal principal stresses, i.e. compressions. Certain deviations occur in the stress field in the Baltic Shield, which can be explained as effects of the glaciation-uplift processes /6-46/.

If the deglaciation is relatively rapid, the earth’s crust is subjected to regional stress differences which can trigger movements in already existing weakness structures. The deglaciation phase following the most recent glaciation was significantly faster in northern Sweden than in the southern parts of the country. This is considered to be an important cause of the neotectonic and postglacial movements that have been interpreted in, for example, the Lansjärv area /6-46/.

Glaciation scenario

During 1990–1991, SKB and Teollisuuden Voima OY (TVO) in Finland carried out a joint inventory of the international state of knowledge regarding ice ages. The purpose was to describe when future ice ages can be expected and what changes in the geosphere occur in connection with them /6-8/, /6-32/, /6-33/.

At the beginning of this century, the Milutin Milankovitch put forth a theory that the variations in the Earth’s orbit around the sun and in the tilt of the Earth’s axis cause differences in the distribution of insolation (the amount of solar energy reaching the earth), which in turn cause glaciations. These astronomical fluctuations are cyclical with periods of 23 000, 41 000 and 100 000 years. By adding together the influence on insolation from all of these fluctuations, Milankovitch was able to distinguish extended periods of time with lower insolation, which he suggested could represent ice ages. In lieu of detailed data regarding the climatic variations of past ages, it was long impossible to either prove or disprove this theory.

During the past 20 years, however, a large quantity of detailed data have been collected which strongly support the Milankovitch theory. These data come, for example, from ice cores taken from the ice caps on Antarctica and Greenland, but it is above all from studies of drill cores taken from deep seabeds that a detailed and continuous description of climatic changes over hundreds of thousands of years has been obtained. By, for example, analyzing the oxygen isotope ratios in the shells of foraminifers in these drill cores, it has been shown that there have been regularly recurring ice ages during the past 750 000 years that conform perfectly to the Milankovitch cycles.

The cycles can therefore be used to predict when future ice ages will occur and how severe they will be. This assumes, however, that man does not alter the composition or circulation of the atmosphere in any decisive way. The greenhouse effect could be

one such change. However, many researchers believe that, viewed in a perspective of tens of thousands of years, this effect, if it exists, will only merely prolong the current warm period by a few hundred or thousand years. In a longer time perspective, the climatic fluctuations will presumably follow the Milankovitch cycles once again.

There are several climate models based on Milankovitch cycles, usually calibrated with known climatic data from previous glaciation periods. These models thus allow forecasts to be made of the future climate. For SKB/TVO's ice age scenario, we have chosen to use ACLIN and Imbrie & Imbrie's models /6-34/, /6-35/. Both of these models show that the warm period we have experienced since the most recent ice age has been unusually warm. The next time a similar warm period will occur will be in 120 000 years. A period with a temperate climate can, however, be expected in 75 000 years. Since this is the first time when man, after a long period of ice ages, will once again be able to settle in Scandinavia, this is also the time to which SKB/TVO's ice age scenario extends. The scenario describes climatic conditions for Scandinavia as a whole, and specifically for the Stockholm-Helsinki region. When future ice ages can be expected and the extents and thicknesses of the inland ice sheets during these periods are shown in Figure 6-2.

A further refinement of the dynamics in a future glaciation scenario has taken place with the development of a time-dependent model of the glaciation in Scandinavia. The model has been calibrated with our knowledge of the Weichsel glaciation and then with respect to moraine structures, soil thicknesses, erosion traces etc. /6-36/.

Based on future glaciation scenarios, the impact on a repository can be judged with different types of calculation models. To begin with, the stability within a repository area has been analyzed with respect to an ice load and simultaneous water pressures. A sensitivity study has also been carried out. The work has been exemplified with data from the Finnsjön study site. In summary, the results say that the movements will be taken up in already existing zones. The total peak relative movement in a zone within the area amounts in the normal case to about 0.05 m. If an extreme situation prevails with low in-situ stresses in the rock, the importance of the pore pressure would increase, resulting in a total movement of about 0.5 m. Current repository concepts within SKB assume that canisters will not be deposited in such zones /6-37, 6-38/.

Neotectonics, isostatic land uplift, postglacial movements

By "neotectonic movements" is meant displacements that have taken place or are taking place during the current tectonic regime, i.e. during the geological period when the Atlantic Ocean has existed (about 60 million years). Any movements after the most recent deglaciation are called postglacial.

The land uplift after the most recent glaciation has normally been studied in relation to sea level. It is, however, possible to study the total movement and distribution of the land uplift via the tilting and "rebound" of oblong lakes. By dating sedimentation levels at different depths, it is possible to analyze the general land uplift within a region. SKB has initiated studies on several sites in the country in order to obtain better knowledge of the distribution of the land uplift /6-39/. Based on Quaternary geological studies it is also possible to analyze any shoreline displacements, which could be a sign of postglacial movements. Such studies are being conducted in Värmland, the results of which are expected to be published in 1993.

During the period 1986–1988, SKB carried out a comprehensive geoscientific research programme in the Lansjärv area, which is situated approximately 150 km north of Luleå. The purpose of these investigations was primarily to try to map the extent and character of the presumed postglacial structures in this area. The results of these

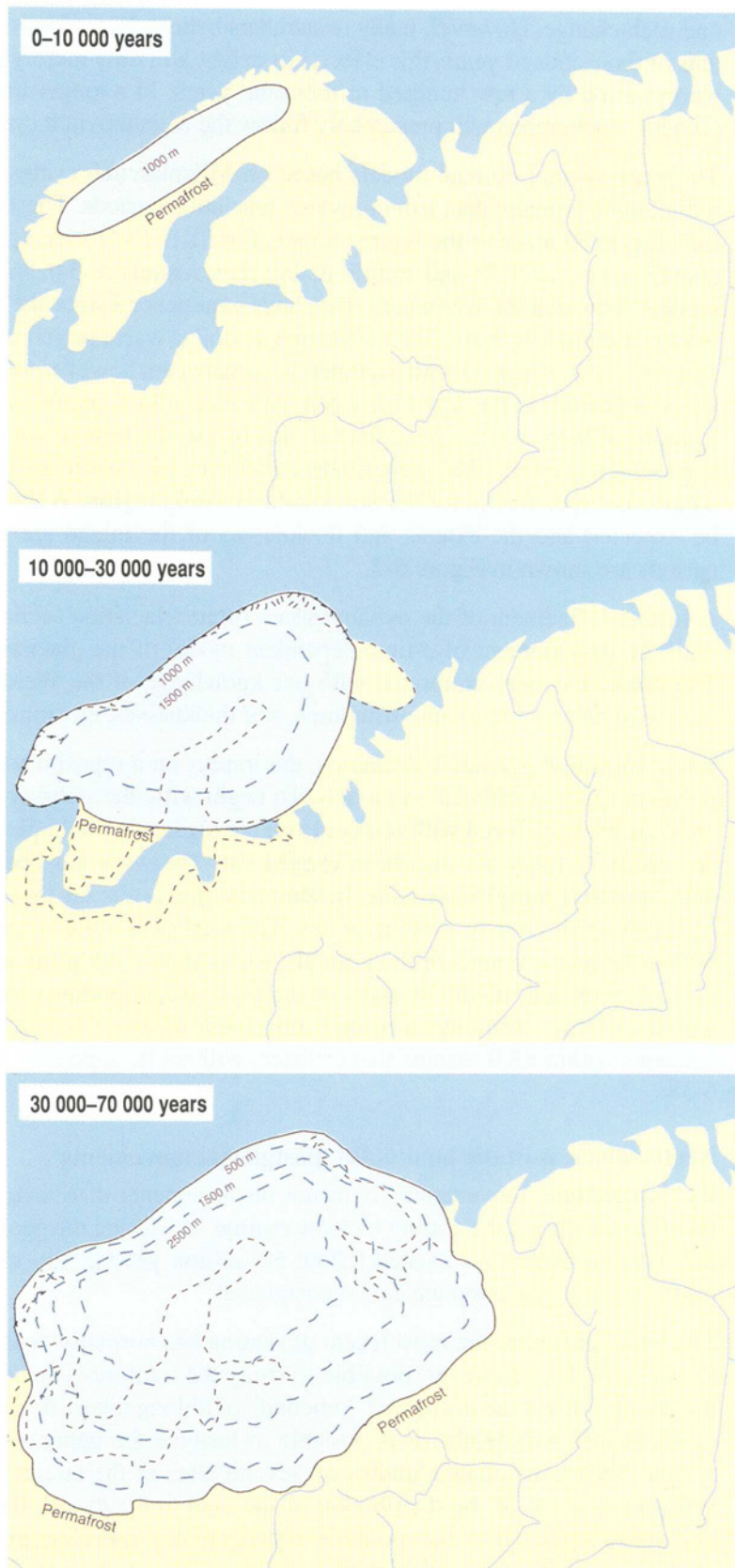

Figure 6-2. Extent of future inland ice sheets according to SKB/TVO's ice age scenario.



Figure 6-3. Field work for surveying of the Molberg Fault.

investigations were published in a summary report in 1989 /6-40/. During the summer of 1990, the field work was concentrated on the Molberg Fault, see Figure 6-3. After refraction seismic measurements, which located the fault, two wide parallel trenches were dug straight across the fault in order to permit detailed studies to be made of both rock and soil strata. Three cored holes were drilled to investigate the orientation of the fault and its character at depth. Mineralogical and geochemical investigations were performed on rock samples and drill cores in and near the fault. The structures in the Quaternary deposits were documented in detail. Instruments for deformation measurement of possible ongoing movements in the fault were installed in two percussion boreholes. Test pits were also dug within certain parts of the Lansjärv area during 1990 for the investigation of seismites, i.e. structures in the loose deposits that are presumed to have been formed in conjunction with earthquakes /6-41/.

In June 1991, SKB arranged an excursion with international participation in the Lansjärv area. The purpose of the excursion was primarily to present in the field the most important results of the Lansjärv investigations and to discuss problems pertaining to postglacial structures with international and Swedish experts.

The conclusions after the excursion are as follows:

- The postglacial faults are primarily reactivations of older dominant zones, but the presence of some new fractures cannot be ruled out.
- The causes of the postglacial movements are probably a combination of relatively rapid changes in the vertical loads (earthquakes associated with deglaciation) and horizontal compression from the Mid-Atlantic Ridge related to continental drift. Earthquakes and seismites are clear indications of temporary instability.
- Today there is no clear evidence that the postglacial faults are still active. These fault movements are probably caused by specific stresses in conjunction with glaciation and ice retreat and have little or no connection with the current stress situation in northern Sweden.

Tectonic analysis and interpretation methodology

The bedrock's structures on regional scales (km scale) are usually interpreted in satellite or aerial photographs. Topographical maps or measurements on the surfaces of rock outcrops are used for more detailed descriptions. Lineament studies and zone and fracture mappings are often supplemented with geophysical measurements. Historically speaking, the interpretation scale has probably influenced the conceptual picture of the rock's structures, i.e. results have been obtained that are excessively dependent on the scale with which the problem has been regarded. In recent years, increasing interest has been devoted to the use of the fractal concept to describe topographical reliefs and geological structures in nature /6-47/. Several studies suggest that similar brittle tectonic structures are found on different scales /6-22/. The fractal dimension is an indirect measure of how well fractures and zones with different directions and extents fill up the rock mass. In, for example, discrete fracture models for geohydraulic calculations, the fractal concept is used to describe the conductive network.

Since the most probable movements take place through reactivation of existing zones and fractures, it is essential to obtain a geological perspective on when the most recent stress redistributions have taken place within a repository site. In the field of tectonics, different techniques exist for dating the most recent movements of fracture zones. SKB has funded a comparative study where infilling material from a fracture zone at Äspö has been analyzed by means of different methods. The methods used were paleomagnetism, microstructural analysis, ESR (electron spin resistance) and the isotope techniques K-Ar, Rb-Sr. The methods exhibit relatively good agreement, but further development work appears to be necessary /6-48/.

6.3.3 Programme 1993–1998

The following programme for 1993–1998 is proposed to meet the goals formulated in 6.3.1.

A synopsis of the main load directions that have acted on the Baltic Shield during its historical brittle tectonic phase is planned during the coming research period. In a regional perspective, the directions of hypoabyssal rocks, former sediment indications, erosion traces, fracture mineralizations etc. will be dealt with. Furthermore, the recent plate-tectonic processes and glaciations will provide background material for such a synopsis. The overall purpose is to test the hypothesis that the Baltic Shield has been subjected to all conceivable stress directions. This would mean that new fractures are not likely to form in the upper part of the crust during the current tectonic regime. It is thereby essential to study how and why horizontal zones appear. Water-bearing horizontal zones can act as hydraulic barriers in the repository area. In conjunction with the development of this conceptual picture, large-scale rock-mechanical calculations will be carried out, whereby the loads will be varied in terms of size and direction.

A number of recent studies shed light on the very stable conditions that prevail in Sweden, compared to the rest of the world. There is nevertheless a need to compile different Nordic studies into a joint document where the risks of earthquakes are discussed and evaluated. TVO and SKB plan to cooperate in producing this synopsis (cf. the joint ice age scenario).

The more site-specific reactions to a glaciation at a repository site are being further studied. Activities with numerical modelling are described in the following section 6.4. But our conceptual understanding also needs to be further refined on the basis of TVO's and SKB's joint glaciation synopsis. Examples of subjects requiring further

study are the impact of the stress redistribution on the conductivity field, the effects of permafrost, freezing-out of saline water and transient load change during deglaciation. The mechanisms of isostatic land uplift will be further investigated through studies of sedimentation levels in a number of lakes, i.e. employing lake-tilting methodology. Other Quaternary geological studies will be made of possible shoreline displacements to determine whether postglacial movements have taken place. This work is currently being pursued in Värmland.

Independent observations around the world testify to the fact that fractures and fracture zones – on everything from a detailed scale to a regional perspective – occur with discrete directional concentrations. Some researchers make a classification into different orders of fractures/zones while others talk about continuous, scale-independent fragmentation processes. There is hereby a need to investigate whether the so-called fractal viewpoint facilitates interpretation and understanding of different rock structures.

A continued knowledge build-up should take place regarding the different methods that are used for dating the most recent movements in fracture zones. Besides different isotope techniques, ESR technique and paleomagnetic methods will be applied. The most suitable methods will then be used for detailed characterization within the siting programme.

It is essential to be acquainted with the stress situation in the bedrock at a repository in terms of how it affects repository performance and construction. The rock stress conditions also play an important role in the general tectonic understanding of a region. The following measurement principles are widely used:

- In-situ measurement in boreholes
- Focal plane analysis of earthquakes
- Breakout in boreholes
- Microseismic registration

The most common in-situ methods in Sweden are overcoring and hydraulic fracturing. In view of the conclusions that are often drawn from rock stress measurements, it is important to determine the uncertainties associated with each method, for example when it comes to volume representativeness and influence of microstructures. In addition to the method-oriented activities, there is a need for a better understanding for whether time-dependent or rock-type-dependent stress distributions occur. Furthermore, it is of interest to assess the regional influence of the Swedish mountains and to what extent the successive glaciations have created residual stress patterns that are significant.

6.4 GEOHYDROLOGICAL AND ROCK-MECHANICAL CALCULATION MODELS

6.4.1 Goals of the activities 1993–1998

Calculation models will be refined primarily within the framework of the activities at the Äspö Hard Rock Laboratory. Supplementary efforts will be pursued within SKB's general RD&D programme. As far as mathematical models within "Geoscience" are concerned, the goal of the RD&D programme for the period 1993-1998 is to:

- Further refine how the results from the volume representativeness and dimensionality of hydraulic tests are to be integrated into a model structure.

- Integrate and take into account general geological and geophysical information in the conductivity distribution for a site-specific stochastic groundwater modelling (indicator simulation).
- Develop a regional flow model for conditions during glaciation and deglaciation.
- Further refine models for convection modelling in fractured rock.
- Further refine rock-mechanical stochastic models and further refine the scale dependence within rock-mechanical model structures.
- Further refine coupled hydro-thermo-mechanical models.

6.4.2 State of knowledge

Mathematical models for groundwater flow and rock mechanics constitute important tools in the work with waste disposal. As the computing power of computers increases, numerical and stochastic models are being developed aside from empirical relationships and purely analytical equation solutions. A calculation model is used to

- increase the understanding of a scientific problem,
- analyze which parameters are essential for solving a calculation problem with given premises,
- make predictions in time and space.

The advantages of numerical models are that

- they are flexible and powerful,
- the calculation operations are correct,
- the results can be visualized simply and reported in good pedagogical form.

The bedrock is deterministic in its component parts, i.e. it exists and has measurable, predictable properties and structures on all scales. However, due to the complex structure and great variability of the bedrock, it is impossible to rely solely on observations of data in making a detailed quantitative description. Previous experience and knowledge and statistical processing of measurement data therefore bring a stochastic component into the description. These factors have led to the use of both deterministic and stochastic calculation models (and algorithms) in geoscientific contexts.

Chapter 2 deals with the integrated model chain for the near field and far field that is used in a safety assessment. The state of knowledge for flow and transport modelling (non-reactive) is commented on in more general terms below. Rock-mechanical modelling and solution of coupled problems is also commented on.

Groundwater modelling

SKB has contributed to the model development in various ways. In recent years efforts have been concentrated on the calculation tools needed in safety assessments (SKB 91), in the Äspö Hard Rock Laboratory and in the Stripa Project. Most model development will continue to take place in connection with the Äspö Project, see separate background report /6-17, 6-18/.

The most common approach used to date for describing groundwater flow in rock on a large scale has been to consider the bedrock as an **equivalent homogeneous porous medium**. The heterogeneity of the rock can be taken into account with this modelling technique by means of anisotropy in the conductivity tensor or by means of large-scale zones that are also handled as equivalent porous media.

Since we know from measurements that the properties of the bedrock are highly varying, the above model approach can be questioned. The variations in the rock can be handled with a statistical approach by describing the medium as a **heterogeneous**

porous medium. Here, for example, the hydraulic conductivities are regarded as random variables with a given distribution in space (stochastic continuum model).

Greater consideration is given to the site-specific structures in the rock in modelling with **discrete fracture networks**. On the basis of fracture measurements and the statistical distributions of the fractures, the model structure is built up with conductivity data /6-19/ (stochastic discrete fracture network model).

In order to take into account indirect qualitative hydrogeological data in the model structure, development work is under way with so-called **non-parametric indicator simulation**. Geological and geophysical data can thereby complement “hard” conductivity and porosity data in a systematic manner and give more realistic model outcomes /6-20/.

Most flow theories are based on the fact that the studied medium can be regarded as statistically homogeneous for a given scale. However, ongoing research shows that the heterogeneity often has a fractal appearance, i.e. it has a pattern that is independent of the observation scale. Furthermore, the flow dimensionality turns out not to be strictly 1-, 2- or 3-dimensional, but can be expressed as intermediate forms. **Fractal modelling of flow and transport** can be expected to become an increasingly common tool for analyzing and calculating complex geometries /6-21, 6-22/.

Rock-mechanical modelling

The calculation models for the mechanical properties of the rock, i.e. strength and deformation, can in principle be divided into two main groups:

- Continuum models
- Discontinuum models

The continuum models describe the rock as a uniform rock mass where the effects of discontinuities are included without being able to define them specially. Movements in the rock are described in these models by means of continuum mechanics, which means that it is difficult to take into account movements along discontinuities. The continuum models can be of a differential or integrated type. Finite element methods (FEM) and finite difference methods (FDM) are examples of differential methods, while boundary element methods (BEM) are examples of integral methods.

In discontinuum models the rock mass is described with a coupled model between the intact rock and discontinuities in the form of fractures and zones. These models can describe movements in the rock with deformation mechanisms for sliding along fracture planes, separation of fracture planes and rotation of rock blocks. Distinct element methods (DEM) simulate the rock mass as a discontinuum and can be used for calculating non-linear material behaviours and large deformations that can lead to collapse /6-23/.

Coupled models

A deep repository for radioactive waste can affect the rock mass via chemical reactions or via thermal, hydrological and mechanical processes. These processes have a mutual influence on each other to a greater or lesser extent. In recent years, interest has increased in developing so-called “coupled” models in order to enable the conditions in the near field in particular to be described with greater realism /6-24, 6-25/. Analytical calculation methods can very seldom be employed for the complex relationships that have to be described in the coupled processes /6-26/. The trend is towards the use of numerical methods, which require extensive verification. In the DECOVALEX project initiated by SKI (international cooperative project for the DEvelopment of COupled models and their VALidation against EXperiments in

nuclear waste isolation), development and verification of coupled thermo-hydro-mechanical models is taking place /6-27/.

6.4.3 Programme 1993–1998

To meet the goals set up for model development during the period 1993–1998, the following programme will be carried out within the framework of “Geoscience”.

The need for further development of in-situ determinations of conductivity and porosity was commented on in section 6.2.3. A better understanding of the volume representativeness and dimensionality of the injection tests is, for example, desirable. Such an understanding entails at the same time that the handling of input data in both stochastic continuum and discrete network modelling needs to be developed, since element size and discretization are affected in the model structure. An increased usage of interference tests in pre-investigations in the future can be predicted. Today the results of the interference test are coupled to discrete water-bearing structures, but there is also a need to see how these pumping results can be integrated in the stochastic simulation.

Preliminary results suggest a greater degree of realism if hydraulic (hard) input data are complemented with geoscientific (soft) information. This information can be of a geological and geophysical nature and represent larger or smaller rock volumes than the volumes related to conductivity and porosity data. The strict integration between hard and soft data needs to be further developed in so-called indicator simulation.

Besides regional groundwater modelling under today’s climatic situation, it is essential to shed light on the hydraulic conditions in connection with future glaciations and deglaciations. During the preceding three-year programme, a time-dependent glaciation model of Scandinavia was developed /6-11/ with a stochastic point of view for the coming 120 000 years. The model yields predictions for the boundary conditions at the ground surface in terms of vertical loads, shear stresses and groundwater formation. The boundary conditions apply to ice retreat and the permafrost situation. After this introductory work, the intention is to simulate regional future flow situations. This will be done initially along a northwesterly oriented traverse through southern Sweden. Important databases for this work will be, for example, available water chemistry at 500-1000 m depth, information in the well archive at SGU and the elevation database at the Central Office of the National Land Survey. The ultimate goal is that the model shall be able to take into account time-dependent groundwater formation, time-dependent seawater fluctuations, density and temperature changes in the groundwater, the effect of groundwater chemistry, influences of gas generation, influences of permafrost, influences of horizontal conductive zones and the dependence of conductivity on ice load.

High salinity in the groundwater indicates low water turnover. Due to heat evolution in the repository, however, convection flows may be obtained. Preliminary laboratory studies and model calculations show that a stability front can be achieved via the density differences in the groundwater. Thus, groundwater from a certain depth should not be able to reach the biosphere. Model tools that take greater account of the heterogeneity in the rock and the chemical variations in the groundwater need to be developed in order to enable the terms of the convection flows to be assessed.

A deterministic approach with relatively few input data from direct field measurements is primarily used within the rock-mechanical modelling technique. Compared with e.g. groundwater models, a stochastic approach is seldom used within rock mechanics. The consequences of changed premises in a rock-mechanical calculation problem are usually elucidated by sensitivity tests. SKB intends to follow particularly

closely the development of such rock-mechanical models where greater account is taken of scale dependence and statistical distribution of input parameters.

Development of modelling tools for the coupled physical processes in the bedrock is currently being pursued along a broad front. Laboratory work will be done in the Äspö Hard Rock Laboratory, while theoretical model development will take place within the framework of other RD&D activities. SKB will continue to be involved in the validation and verification of thermo-hydro-mechanical models, for example within the framework of the DECOVALEX project.

6.5 ALTERNATIVE FINAL DISPOSAL METHODS

The main thrust of the work on final disposal in all countries is disposal in rock at a depth of 300 to 1000 metres. Alternatives also attracting interest are seabed disposal and disposal in very deep boreholes. Both of these methods make retrievability and future corrective actions more difficult. Nevertheless, analyses conducted to date indicate a considerable potential for safe final disposal where the geological barrier alone provides sufficient isolation of the radioactive materials. Neither method is yet ripe for application or demonstration. The international studies have mainly concerned disposal at very great depths beneath the oceans. This requires an international consensus, and at present there is a strong movement to prohibit such disposal. Disposal in the crystalline bedrock beneath the Baltic Sea has also been discussed in Sweden. Deep-sea disposal is hardly a feasible option for Sweden.

Disposal in very deep boreholes requires further technical development, but above all greater knowledge (data) on the properties of the rock at depths of several km. Considerable research is being done in this field without any direct connection to nuclear waste disposal. The results can be of interest not only for deep-hole disposal but also for a general understanding of the geology of the rock on a regional scale. A limited follow-up by Sweden of the ongoing research in the field is therefore warranted. The work can be done in the form of, for example, doctoral theses at some institution of higher learning. The contacts that have been established in this field with Russian researchers are also of interest to maintain, since a considerable portion of the scientific work to date has been done in Russia.

7 CHEMISTRY

7.1 GROUNDWATER AND GEOCHEMISTRY

Classification of groundwater chemistry data and determination of the sorption properties of radionuclide analogues and the interaction between minerals and groundwater will continue during the coming period.

7.1.1 Goals of the activities

The goals of the research and development efforts within groundwater and geochemistry are to:

- further refine knowledge of the chemistry of groundwater and minerals, first and foremost for the processes and properties that are of importance for canister and buffer stability, fuel dissolution and radionuclide migration in the safety assessment,
- verify the geohydrological description of groundwater flow, both in a repository area and regionally,
- determine what chemical changes can be brought about by the repository and any water entering it.

7.1.2 Present-day state of knowledge

A large portion of the research work on groundwater and geochemical conditions is being carried out within the framework of the Äspö project. In addition, laboratory tests and evaluations are being carried out for the purpose of clarifying essential processes and their importance, for example available redox buffering capacity. Investigations and evaluations have been focused on the issues presented in R&D-Programme 89, and the results are reported here under the same headings.

Groundwater types

Saline and fresh water occur in the bedrock. These waters have different origins and/or different residence times. Saline water is encountered where stagnant conditions prevail or are assumed to have prevailed. The water is saline either due to a long residence time, which has given the water plenty of time to react with the rock, or due to the fact that seawater has at some time infiltrated the bedrock. Often both of these processes may have contributed.

Fresh water originates from rain and snow and is, in relation to the saline water, young (newly formed) groundwater. The fresh water is characterized by the fact that its properties are largely determined by reactions between dissolved carbon dioxide and calcite. When water penetrates down through the soil layer it absorbs carbon dioxide and becomes aggressive, especially towards easily soluble minerals such as calcite.

Saline water is encountered at different depths, depending on the site-specific hydrological conditions. At coastal sites the salt water boundary is close to the ground surface. The boundary between fresh and saline water is seldom sharp; rather, the salt content increases incrementally with depth. Saline water in SFR, Finnsjön and Äspö can derive in part from the Littorina Sea, which was a predecessor to the Baltic Sea, although some much older water may also be present.

The groundwater on Äspö can be roughly divided into four classes on the basis of the concentration of principal solutes /7-1/. Of these four classes, the first consists of fresh water while the others are saline. Typical compositions for the four classes are presented in Table 7-1.

Table 7-1. Character for the four classes that describe the groundwater on Äspö.

Class	Chloride mg/l	Bicarbonate mg/l	Sodium mg/l	Calcium mg/l
A	174 ± 92	338 ± 58	240 ± 13	32 ± 10
B	580 ± 70	213 ± 15	393 ± 32	98 ± 14
C	4171 ± 1694	58 ± 49	1392 ± 553	1080 ± 565
D	11001 ± 1434	11 ± 2	2776 ± 587	3826 ± 598

The fresh water cushion, type A water, on Äspö is shallow. Water samplings in 100 m deep percussion boreholes show that the water is already saline at depths of 40 to 50 m /7-2/.

Below the fresh water is a thin mixing layer where underlying saline water is mixed with the fresh water, type B. Salinity then increases linearly up to a chloride concentration of 12 000 mg/l at a depth of 1 000 metres /7-3/.

Down to a depth of about 500 metres, salinity increases to a level that is twice as high as the level in the Baltic Sea. During earlier phases of the evolution of the Baltic Sea, it is believed that the Littorina Sea had a salinity that was three times as high as the Baltic Sea's.

Below a depth of about 500 metres, the groundwater changes character, although salinity continues to increase steadily. Calcium content increases and surpasses sodium.

Salinity increases more or less linearly with depth, but large deviations occur in some sampling points. These are located in water-bearing zones and salinity is either higher or lower than the value associated with the depth, see Figure 7-1. These zones are either in recharge or discharge areas /7-1, 7-4/.

Groundwater's turnover time

The groundwater's turnover time can be described qualitatively by compiling a variety of different measurements and analyses. These include radioactive isotopes, such as tritium and carbon-14, stable isotopes, such as deuterium, oxygen-18 and sulphur-34, and principal components of the water and their mutual relationships. It is not possible to define an exact turnover time, since the water is mixed continuously along the flow paths and changes occur in inflow conditions as a result of glaciation, land uplift etc. Disturbances from drilling and investigations also affect dating.

Results from oxygen-18 determinations verify the division into groundwater classes that has been done on the basis of the principal components. The groundwater encountered in shallow sections exhibits a value that lies close to that found in precipitation today. It follows that this groundwater, classes A and B in Table 7-1, has been formed since Äspö rose up out of the sea, under temperature conditions similar to those that prevail today. This picture changes with depth, and the water's

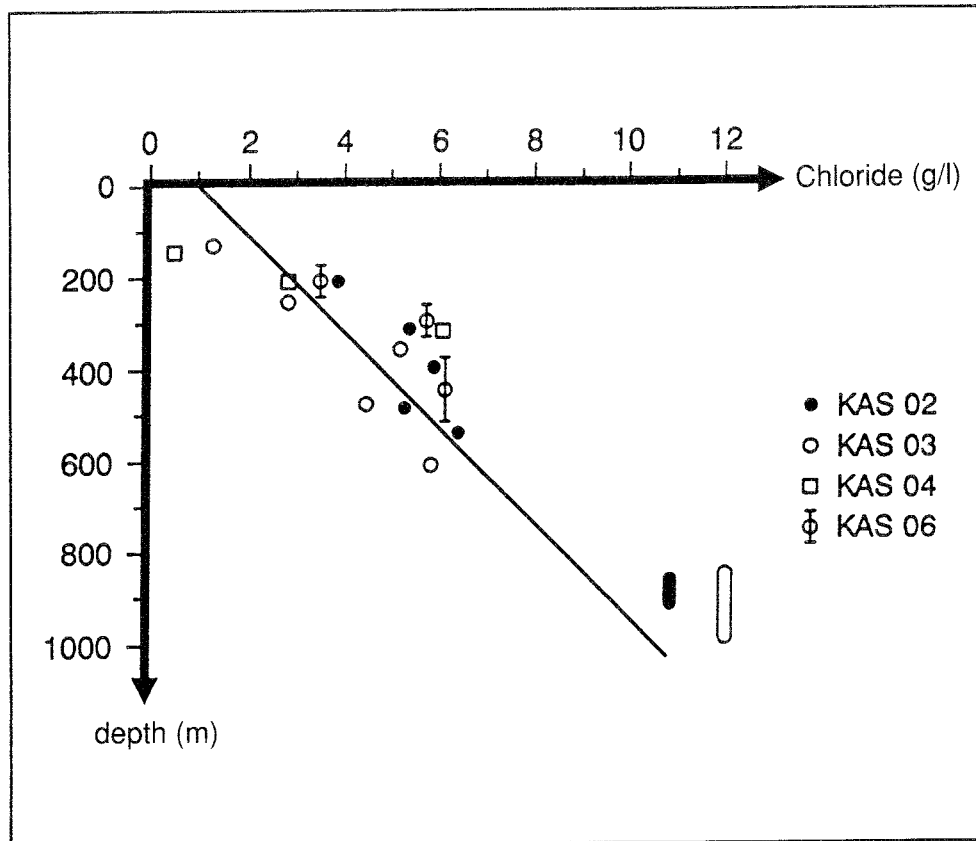

Figure 7-1. The chloride content (salinity) of the groundwater on Äspö as a function of depth. A deviation from the straight line indicates that the sampled interval is in contact with a recharge area (below the line) or a discharge area (above the line).

oxygen-18 value suggests that a saline (sea) water and a fresh water deriving from a colder climate have been mixed in different proportions, class C in Table 7-1. The water from the colder climate may consist of glacial meltwater that has been pressed deep down into the bedrock in conjunction with the retreat of the inland ice sheet and later pressed back by new infiltrating seawater. Due to its higher density, the seawater has descended below the fresh water. Since the salinity of this seawater is higher than that of the Baltic Sea, it must derive from the Littorina Sea and must have infiltrated the bedrock between 7 000 and 3 000 years ago.

At depths greater than about 500 m, a mixing between a glacial meltwater and the Littorina Sea water can no longer explain the oxygen-18 values, class D in Table 7-1. This water may thus be unaffected by ice retreat and the transgressions and regressions of the Baltic Sea that have taken place since the most recent ice age.

Carbon-14 datings done on Äspö water yield ages of 5 000 – 30 000 years [7-4], i.e. the values span the entire range of this dating technique. No waters of class D have been able to be analyzed due to the low carbonate content, but the analyses of class C water show that the turnover time based on oxygen-18 analyses largely agrees with the carbon-14 dating. There are, however, a number of processes that cause the carbon-14 dating to give a misleadingly high age. These processes are:

- dissolution of old calcite,
- exchange reaction between carbonate in the water and carbonate minerals in the rock (see carbon-14 in calcite),

- oxidation of abiotic methane to carbon dioxide.

Assuming that the estimate based on the oxygen-18 analysis is correct would then mean that the carbon-14 analyses show an age that is 3 times too high. This applies only for Äspö conditions, but may possibly also apply to other sites that have undergone a similar evolution. A similar comparison cannot be made on another site at this time, however.

Tritium analyses, in some cases with a very low detection limit (0.1 TU), show that the fraction of modern water in the deep groundwaters is very small. However, even at great depths, tritium sometimes occurs in a quantity corresponding to a per mill level (1 TU) for the fraction of modern water (infiltrated after the atmospheric hydrogen bomb tests begun in the early 1950s). This tritium content cannot be explained solely by reference to technical disturbances during drilling and sampling. A more likely explanation is that various activities, mainly drilling and pumping, have caused a large-scale water turnover that has brought surface water down to a much greater depth than it would otherwise have reached.

Redox conditions

Virtually all groundwater that has been sampled is oxygen-free and reducing. Bacterial and chemical processes have consumed the oxygen that was dissolved in the water when it infiltrated the ground surface. The concentrations of sulphide and iron constitute the available redox buffer in the water. This is relatively small, while the big redox buffer consists of the iron minerals present in the rock.

On the basis of all carefully checked measurements, mainly those performed down in boreholes, an empirical relationship between Eh and pH has been derived. This is based on data from 16 levels in 9 boreholes that have been investigated since 1984. The relationship $Eh = (260 - 60 \text{ pH}) \text{ mV}$ agrees well with values that can be theoretically calculated for commonly occurring minerals in the bedrock /7-5/. Thorough analysis of measurements performed shows that all can be explained by the concentration of divalent iron and the solubility of ferric hydroxide in the water /7-6/. The concentration of trivalent iron in the water is so low that it cannot be measured, but is instead calculated from the solubility of ferric hydroxide. The accuracy of the measurements is $\pm 25 \text{ mV}$ and the potential is determined by the reaction:

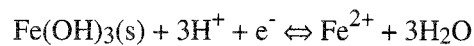

$$\text{This gives } Eh = (707 \pm 59) \text{ mV} - \ln_{10}(\text{RT/F})(3\text{pH} + \log[\text{Fe}^{2+}])$$

It is thus the iron system, even in those cases where the concentrations are low, that determines the electrode potential and the effective redox intensity in the groundwaters. The concentration of trivalent iron is dependent on the degree of crystallization (the age) of the ferric hydroxide. The solubility that can conversely be calculated from the Eh data lies in the interval that spans everything from fresh amorphous ferric hydroxide precipitation to crystalline goethite.

The available redox buffering capacity has been determined by measuring the penetration depth for oxygen that has been in contact with different rocks and mineral samples under 100 bar of pressure. Due to the fact that the oxygen pressure has been kept so high, the test has simulated the oxygen diffusion which takes place during a period of several hundred years of contact between oxygen-saturated water and the rock. The results show that the oxygen diffusion reaches very far into the stones /7-7/, 1 mm in mechanically cracked drill cores and up to 25 mm in natural fractures. The

difference is due to the fact that the natural fractures are surrounded by a larger quantity of microfissures than the average for the rock. Based on these measurements, the available redox buffering capacity can be calculated to be 18–620 mol/m of rock.

In the Äspö tunnel, a fracture zone has been selected for detailed investigation of the redox conditions adjacent to an underground facility. In the background report to RD&D-Programme 92 on the Äspö Hard Rock Laboratory there is a detailed description of the large-scale redox experiment and the continued redox investigations within the Äspö project. The bedrock and the fracture zone contain large quantities of divalent iron, mainly in the mineral phases biotite and chlorite. Due to the increased water flux caused by the facility, oxygenated water may be drawn down to the tunnel via the fracture zone. In this way, the dissolved oxygen will be reduced by reactions with reducing substances in the water and reducing minerals in the rock. Depending on the water composition and flow, different reactions will be most significant. At rapid flow rates, only reducing substances dissolved in the water will have time to react with the oxygen, while at slow flow rates the reducing minerals in the fracture wall will also have time to react.

Laboratory measurements are being performed in parallel with the field test to determine the weathering rate for biotite and chlorite. Finely pulverized mineral powder (75–125 µm) with a reaction surface area of 1–5 m²/g is exposed in a reactor to a water stream of 1–20 ml/h. The weathering rate for biotite at a neutral pH is 10⁻⁸ mol/m² per hour. If the mineral has been in contact with water prior to the test, the reaction rate is ten to a hundred times lower. The groundwater history experienced by the minerals is thus of great importance.

Fracture mineral/groundwater processes

Previous groundwater conditions can be traced in fracture minerals. Ferric hydroxide and calcite can be used to trace previous flow paths, even though low-temperature effects are easily drowned out by the huge alterations caused by previous hydrothermal conditions.

The distribution of uranium and rare-earth elements (REEs) between fracture minerals and groundwater has been investigated both on Äspö and in Klipperås /7-8, 7-9/. Table 7-2 shows the distribution factor calculated from data from the two sites. The table also shows the distribution constants (K_d) used in SKB 91. They are based on measurements performed at laboratories.

Table 7-2. Distribution constants for uranium and rare earth metals in Äspö, Klipperås and SKB 91.

Element	Distribution constants in m ³ /kg		
	Äspö	Klipperås	SKB 91 (K _d)
Sr	0.002 – 0.17	1 – 4	0.003
Rb	0.4 – 10	22 – 160	(0.003)
Ba	1 – 3	5 – 30	(0.003)
Cs	0.02 – 2	19 – 6030	0.03
Eu	48 – 1504	900 – 1400	0.2
U	0.05 – 240	10 – 97	2
Ce	47 – 3400	2900 – 6800	(0.2)
Sc	125 – 1902	2000 – 7600	(0.2)

Even though the SKB 91 constants are slightly conservative, they are close to the ones obtained from Äspö. The big difference between the constants from Äspö and Klipperås is due to the fact that the high salinity of the Äspö water is accompanied by a higher concentration of trace elements as well, including rare-earth elements. The fracture-filling minerals from both Klipperås and Äspö contain similar quantities of REEs and uranium.

Recharge areas are characterized by the fact that the shallowest fracture systems lack calcite coatings. The reason is that the carbon-dioxide-rich surface water dissolves the calcite as it penetrates down into the bedrock. In addition, an exchange takes place between carbonate in the calcite and carbonate in the penetrating groundwater. The effects of this can be seen in the oxygen-18 value in calcite in the uppermost parts of the rock. This is not the case with carbon-14, however. Two different studies have found a very low carbon-14 content in very superficial zones /7-10, 7-11/. It seems as if the exchange between the carbon atoms is very limited, while the oxygen exchange proceeds rapidly. If there is little exchange between old calcite in the fracture systems and penetrating dissolved carbonate, the process will also be of little importance for carbon-14 dating of the groundwater.

To further improve knowledge of the origin and evolution of the groundwater, the fraction of sulphur-34 in the water and in sulphide in fracture-filling minerals from Äspö has been investigated /7-12/. The results show that there are several different origins, namely marine, evaporitic (very old) and organic. In the shallow parts of the rock, the sulphate is of marine origin. In an intermediate stratum sulphate reduction and mixture takes place, while the deepest sulphate is of evaporitic origin. Both sulphide and sulphate data show that the sulphate reduction could have been brought about by bacteria.

An increasing degree of acidification will have far-reaching effects on surface water systems, but will not affect a deep repository. The acidification that derives exclusively from the combustion of fossil fuels does have a theoretical limit. The quantity of accessible combustible material is limited. If consumption should continue at the current rate, reserves will be exhausted in about 300 years /7-13/. The effects will remain in the atmosphere for another 500 years. What harmful impact the acid deposition has will depend entirely on what demands are made on flue gas cleaning. Without strict requirements, acid deposition over southern Sweden will be so heavy that the trees will die. After the trees have died, the undergrowth will also die, leaving the ground completely sterile and making all life impossible. In this case the rock will weather down to 150 m during the next 70 000 years, when the next big ice age is expected to arrive. In all other cases acidification is of little importance.

7.1.3 Programme 1993–1998

Classification of geohydrochemical data

A systematic classification of all geohydrochemical data in GEOTAB has recently been initiated. The goal is to group all data in quality and type classes. The quality classes are useful in mathematical model exercises, while the type classes are supposed to serve as a basis for explaining the origin and history of the water. The quality classification is being done jointly with TVO in Finland, who have collected geohydrochemical data from pre-investigations of five different sites.

Type classification has previously been done with data from Äspö, see section 7.1.2. A similar classification will be done for all GEOTAB data after all quality classification has been concluded. The purpose of the work is to simplify the evaluation of an investigated site and to subject all collected data to a uniform evaluation. These data

can then be used to analyze any regional flow pattern, see further under interpretation of mineral-groundwater interaction and mixing processes.

Statistical methods are used to a great extent to carry out the classification work. Multivariate analysis has proved useful for the type classification in particular /7-14/, but should also be used for the quality classification. In this way the subjective element in the assessments is smaller, which means that a higher degree of exactness can be achieved with respect to the uncertainty in the assessment.

Experience from the initial work shows that comparing data from different sites with each other is a delicate task. The work will therefore be pursued for an extended period of time and probably change direction during its duration.

Sorption properties of radionuclide analogues

The method of determining distribution constants for radionuclide analogues on the basis of their occurrence in fracture-filling minerals and water has been called into doubt. Foremost among the factors that contribute to this doubt is the question "How representative are the trace element concentrations in fracture-filling minerals for present-day groundwater composition?" Since the concentrations in fracture-filling minerals from Klipperås and Äspö were very similar despite the fact that the concentrations in the groundwater were very different, there is reason to suspect that the trace element concentrations in the fracture-filling minerals derive from conditions quite different from today's, for example hydrothermal.

The fracture-filling material from Äspö and Klipperås that has already been investigated will be further processed to determine how the trace elements are bound in the minerals. The mineral samples will be subjected to progressively more powerful leaching so that the fraction of dissolved radionuclide analogues can be successively determined. In this way it can be concluded which processes have retained different fractions in the minerals. To conclude these investigations, a traditional K_d determination will be carried out. This is done by exposing the minerals to a solution of the same substances that have previously been leached out. After these have achieved a distribution equilibrium between the aqueous phase and the mineral phase, a new distribution constant is determined, a "true K_d value".

In parallel, different isotope studies will be conducted for the purpose of improving our knowledge of the history of the water and the fracture-filling minerals. Among the methods most frequently discussed is the uranium series, strontium-86/87 and sulphur-34. These studies will to a large extent be carried out in the fracture zone in the Äspö tunnel where the large-scale redox experiment is being conducted. The work is a part of a planned collaboration between DOE and SKB within the framework of the Äspö project.

Interpretation of mineral-water interaction and mixing processes

Regional groundwater flow

Chemistry data from Äspö, Finnsjön and Stripa show that waters that have been sampled at a depth of several hundred metres have a very slow turnover. The fact that the waters are saline show that their average retention time is more than 5 000 years. In this time perspective, regional groundwater flows (if any) are also of importance. Available data shall be analyzed to clarify what importance any regional groundwater flows can have for a deep repository. Besides salinity, isotope data such as deuterium, tritium, carbon-14, oxygen-18 and possibly sulphur-34 can be used.

Acidification

Present-day acidification will not affect the deep repository. However, individual conductive channels could carry the acid water to depths lower than the acidification front. This phenomenon will be elucidated coupled to the hydromodel results in SKB 91.

Stagnant water

Groundwater that has been sampled in water-conducting fractures and zones always has the character of a mixture between many different origin types. That is why equilibrium modelling can only be applied with respect to the very fastest reactions, such as acid-base equilibria with calcite and dissolved carbonate, solubility of troilite and gypsum and redox reactions with divalent iron and ferric hydroxide.

Equipment that makes it possible to sample down to 10^{-11} m/s will be developed during the construction phase of the Äspö tunnel, see section 9.3.2. Besides the previously analyzed principal and redox components, the most essential trace elements will also be analyzed. Since the more stagnant water in the microfissure system in the rock probably has a longer residence time with a lower degree of mixing, this water can be expected to be different and more characterized by the local rock type than by the waters sampled in conductive fracture zones. Equilibrium modelling with these basic data may prove to be more warranted than it has been up to now.

Redox

The redox conditions in the groundwater and in surrounding minerals will be documented within ongoing and planned redox experiments, see section 4.7.3 in the background report to RD&D-Programme 92 concerning the Äspö Hard Rock Laboratory.

Eh measurements on groundwaters will continue even if the intensity value is not expected to lie outside the modelled interval, see section 7.1.2. The primary reason is that the Eh measurements are by far the most sensitive method for detecting the presence of oxygen. In the Äspö tunnel, the possibility cannot be excluded that individual points may carry surface water down so quickly that it has not had time to react with the reducing components in the groundwater and the rock.

Active efforts are planned to determine the available redox capacity in the rock. Supportive laboratory measurements have been and are being carried out, see under 7.1.2, to determine oxygen in-diffusion and weathering kinetics. With these as a base, similar work will be done in situ. There the experiment has already been performed by nature, which means that only analysis and interpretation remain to be done. Besides in-diffusion, weathering kinetics and travel time, it is necessary to determine the flow-wetted surface area, i.e. the area over which reactions between oxygen dissolved in the water and the minerals take place.

Site investigations

Groundwater and geochemistry form essential components of the geoscientific investigations of deep repository sites. The knowledge that has been gained will constitute a basis for planning and optimization of further work.

7.2 RADIONUCLIDE CHEMISTRY

7.2.1 Goals of the activities

The goals of the radionuclide chemistry investigations are to further refine the body of data by:

- measuring and compiling chemical base data for solubility and inorganic speciation of radionuclides in and outside the deep repository,
- determining concentrations, stability and mobility of radionuclides in the form of colloids, organic complexes and microbes,
- determining the retention of the radionuclides in rock and backfill material due to sorption, co-precipitation and diffusion,
- determining the influence of redox reactions, radiolysis and microbial processes.

International cooperation is of great importance for the first goal. A great deal of work lies behind the thermodynamic constants that are used to calculate solubility and speciation of radionuclides in the groundwater. One country would have to devote a disproportionately large amount of labour to accomplish this on its own. Independent measurements are therefore only made where knowledge gaps have been identified or higher accuracy is striven for.

International compilations of chemical data for radionuclides are particularly valuable, since this means that the chosen values have broad acceptance. To be used in the safety assessment, it is essential that chemical data be well-documented and, where necessary, quality-assured.

A great deal of progress has been made with regard to colloids, organic complexes and microbes. Good analyses of colloid particles, humic substances and microbes in the groundwater are now available. Laboratory studies are being conducted of radionuclide binding and transport with these aggregates. Attempts are also being made to develop models for complexation with humic substances and particle transport.

The third area furnishes the transport models with either relevant data or sub-models that describe the retention of radionuclides in rock and backfill material. It is also an essential part of demonstrating our understanding of the retention mechanisms and testing the stability of the constants used.

Radiolysis, redox reactions and microbial processes are of importance for the chemistry of the radionuclides and their changes in the near field. The fourth goal aims at identifying the reactions of this type that have taken place and are of importance for safety.

7.2.2 Present-day state of knowledge – Results

Solubility, speciation, co-precipitation and kinetics

Chemical equilibrium models are being used to an increasing extent to calculate solubility and speciation of radionuclides in groundwater. The thermodynamic constants that are needed for the calculations are collected in databases. Both in Sweden and elsewhere, measurements are being made to improve the accuracy of the important constants so that less conservative assumptions are possible. Where the constants are not well known, it is otherwise necessary to assume high solubilities of the radionuclides. It can also be necessary to assume that the dissolved radionuclide is present in such a form that it is highly mobile in rock and backfill material. Radionuclides of importance for safety with a relatively complicated chemistry are uranium,

thorium, neptunium, plutonium, americium, curium, protactinium, radium, technetium, nickel, niobium and tin.

The solubility of schoepite and uranium phosphate has been determined /7-15 and 7-16/. Experiments with uranium silicate are under way. The redox potential for uranyl to uranium(IV) has been determined /7-17/, and the constants for the formation of carbonate complexes of uranium and thorium have been measured by means of the potentiometric method /7-18 and 7-19/. A summary of this has been presented in the form of a PhD thesis by Bo Lagerman /7-20/. Other techniques have also been utilized. In cooperation with ISPRA in Varese, Italy, laser spectroscopy has been used to investigate uranium(VI)carbonate complexes /7-21/. Solution extraction with special equipment, AKUFVE-LISOL, has been used to determine carbonate and hydroxide complexes of thorium and uranium(IV). After successful pre-trials with thulium, experiments with thorium hydroxide complexes have also been completed. It was found that previous constants for the tri- and tetrahydroxide complexes were overestimated /7-22/.

Neptunium and plutonium have so far been investigated in cooperation with foreign institutions, e.g. CEA in France, which is well equipped to work with these elements. A selection and a testing of the thermodynamic constants for plutonium has been carried out for later use in the geochemistry code EQ3NR /7-23/. Good constants for neptunium and plutonium are of such importance for the safety assessment that we have also initiated our own measurements in specific problem areas.

Americium is relatively well-known, but the carbonate complexes may need to be further investigated. The solubilities of radium, curium and protactinium have so far not been needed for calculation of e.g. fuel dissolution.

The solubility of technetium dioxide has been measured in neutral and alkaline carbonate solutions, see Table 7-3 /7-24/. For the redox potentials that can be of relevance in conjunction with the leaching of fuel in a deep repository, the stable solid technetium phases are either technetium dioxide or metallic technetium. Other phases are not stable in neutral waters.

Table 7-3. Equilibrium constants for technetium(IV) in carbon-containing solutions /7-24/.

Equilibrium reactions	Equilibrium constants log K
$TcO_2 \cdot nH_2O = TcO(OH)_2(aq)$	-8.17 ± 0.05
$TcO_2 \cdot nH_2O + H_2O = TcO(OH)_3^- + H^+$	-19.06 ± 0.24
$TcO_2 \cdot nH_2O + CO_2(g) = Tc(OH)_2CO_3(aq)$	-7.08 ± 0.08
$TcO_2 \cdot nH_2O + CO_2(g) + H_2O = Tc(OH)_3CO_3^- + H^+$	-15.34 ± 0.07

The solubility of nickel in a deep repository is presumably limited by the formation of sulphide. The solubility of niobium oxide is fairly well-known. Thermodynamic data that describe the solubility of tin are uncertain. It is, however, doubtful whether tin isotopes are so essential for safety that more accurate determinations of tin chemistry are called for.

SKB has continuously supported the participation of Swedish experts in the international OECD/NEA project TDB. The objective of the project is to compile and quality-assure a database with thermodynamic constants for solubility and speciation of relevant radionuclides. Moreover, SKB is actively participating in the CEC-arranged project CHEMVAL, which is testing geochemical codes and improving associated databases.

Co-precipitation reduces the solubility of a radionuclide considerably and can lead to a fixing of the radionuclide to a mineral phase. Co-precipitation in conjunction with formation of calcite has been investigated /7-25/. Other conceivable processes that can cause co-precipitation are oxidation of metallic iron or ferrous ions and reduction of uranium(VI) ions. Due to difficulties with quantifying the co-precipitation process and guaranteeing the stability of the precipitation for a sufficiently long time, this has not yet been utilized more than marginally in the safety assessments. The formation of co-precipitates and their stability is being investigated in connection with the natural analogues of radionuclide disposal, see chapter 8.

It is important to show that the chemical reactions that participate in e.g. a solubility-limiting equilibrium actually take place. Redox reactions which are multi-electron processes or where solid phases are involved may be lacking in reversibility and cause inequilibrium. Laboratory tests /7-26 and 7-27/ as well as in-situ tests, see section 7.3, have been conducted to demonstrate that technetium actually is reduced in deep groundwaters. Reactions on the mineral surfaces have proved to be essential in this context.

Organic complexes, colloids and microbes

The natural content of dissolved organic substances has been sampled in several deep groundwaters from Finnsjön, Fjällveden, Forsmark, Gideå, Lansjärv, Stripa and Äspö /7-28/. The relative content of humic and fulvic acids and their chemical character does not vary much between the different sites /7-28, 7-29 and 7-30/. It is rather the depth that is of importance for the total concentration of organic substances and their composition. The fulvic acids in the deep groundwater have a carbon-14 age of between 1 000 and 10 000 years.

The fulvic acids constitute the dominant fraction of the humic substances. Complexation between fulvic acids and metal ions has been investigated /7-31 and 7-32/. Trivalent metal ions form strong complexes with fulvic acids. This has also been shown by direct analyses of the complex using spectroscopic methods /7-33/. It can be assumed that trivalent radionuclides such as americium will behave like fulvic complexes in the groundwater.

Particles and colloids are sampled regularly by filtration in conjunction with groundwater sampling. The quantity and composition of particulate matter is analyzed. It varies somewhat with the depth. The concentration of colloids is relatively low in deep groundwaters. Calcite particles are normal in samples from great depth. Ferric hydroxide, iron sulphides, quartz etc. are also present.

Migration tests have been conducted with goethite colloids in columns packed with quartz powder. Different concentrations of goethite colloids, different pHs and different water flows through the column have been tried. A marked dependence on the flow was noted. The tests were conducted at the Oak Ridge National Laboratory in the USA by Birgit Sätmark with support from the Chalmers University of Technology and SKB.

Sorption of technetium, strontium, caesium and promethium on colloids of silica, bentonite and finely ground granite has been measured as a function of pH and

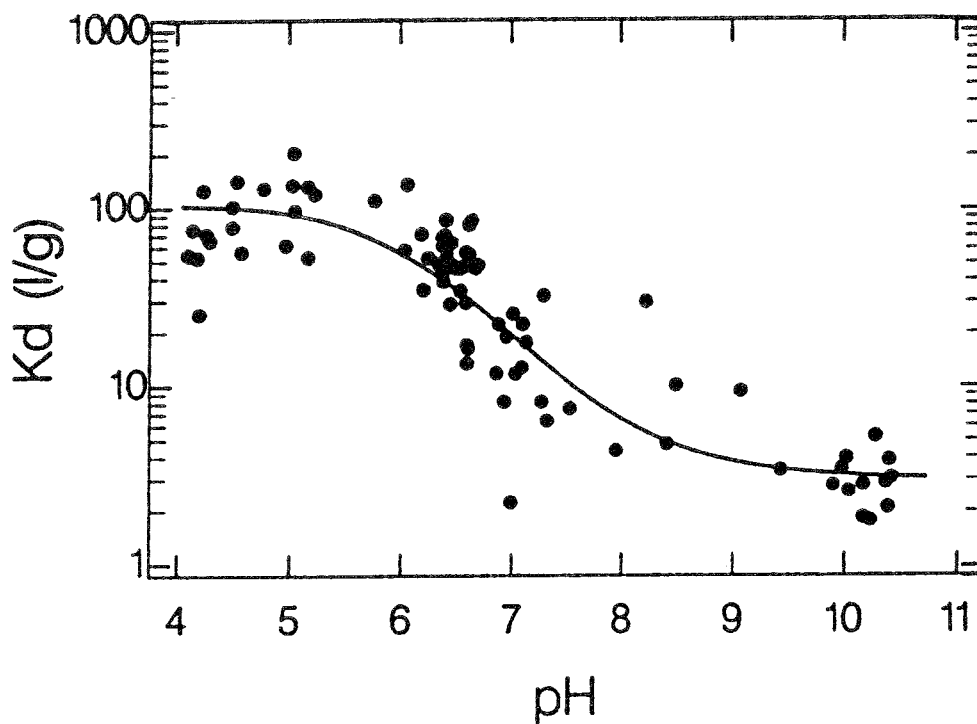

*Figure 7-2. Sorption of promethium, Pm^{3+} on the bacteria species *Shewanella putrefaciens* as a function of pH /7-39/.*

particle diameter /7-34/. The influence of pH, ionic strength and fulvic acids on the size distribution and surface charge of colloidal particles of quartz and ferric hydroxide has been investigated /7-35/.

Microbes have been analyzed in samples of deep groundwaters taken at Stripa and at Laxemar, Ävrö and Äspö /7-36, 7-37 and 7-38/. The concentration of bacteria is normally several hundred thousand per ml. Methane bacteria and sulphate reducers have been found /7-37/. It has been shown that the bacteria in the groundwater have a tendency to adhere to surfaces that come into contact with the groundwater /7-38 and 7-39/.

Experiments have been carried out with sorption of radionuclides on bacteria /7-39 and 7-40/. Uptake of promethium on the bacteria species *Shewanella* proved to be reversible and highly pH-dependent, see Figure 7-2. Promethium was used as a model for a trivalent strongly sorbing radionuclide.

The influence of colloids, microbes and natural organic substances on radionuclide transport was analyzed as a basis for SKB 91. The evaluation is based above all on the groundwater's content of these aggregates and how strongly they are bound to different radionuclides. The organic complexes will cause a reduction of the sorption coefficients K_d . The size of the reduction depends on the valence of the radionuclide ion and the concentration of humic substances in the groundwater. Colloidal particles as well as, to some extent, bacteria can also adsorb radionuclides. If the adsorption is reversible, this is of minor importance for radionuclide retention. If, on the other hand, the adsorption is irreversible, the situation is more problematical. In the worst case the particles could transport radionuclides with the speed of the water. The calculations show, however, that even in such a case not much is transported, since

the concentrations of colloidal particles in deep groundwaters are relatively low /7-41/.

The international working group COCO appointed by CEC is examining the importance of natural colloids and complexes for the transport of radionuclides from a repository. SKB is supporting the participation of Swedish experts in this group.

Sorption and diffusion

Sorption tests have been carried out with caesium, strontium and europium on granite, where the importance of in-diffusion in the rock's microfissures has been indicated /7-42/. Sorption tests with technetium under simulated natural reducing conditions show that technetium is sorbed as Tc(IV) and thereby has a high K_d value down in the rock. This result has been confirmed by observations in connection with in-situ tracer tests with technetium, see section 7.3.

An up-to-date compilation of sorption coefficients for safety-relevant radionuclides on rock minerals has been carried out /7-43/. Based on this compilation, a selection of K_d values has been made to be used in the transport calculations within the SKB 91 safety assessment /7-41/.

Fundamental experiments have been performed to test surface complexation as a model for the sorption of radionuclides on minerals. The primary purpose of the experiments is to increase our understanding of the processes that are involved in this sorption. A series of introductory tests has been carried out with adsorption of carbonate on the mineral goethite /7-44/. The experiments have continued with neptunium(V) /7-45/. It is worth noting that the sorption of neptunyl ions on goethite as well as haematite is significant, see Figure 7-3. Iron and iron compounds therefore have good barrier properties. Their foremost chemical merit is that they act as

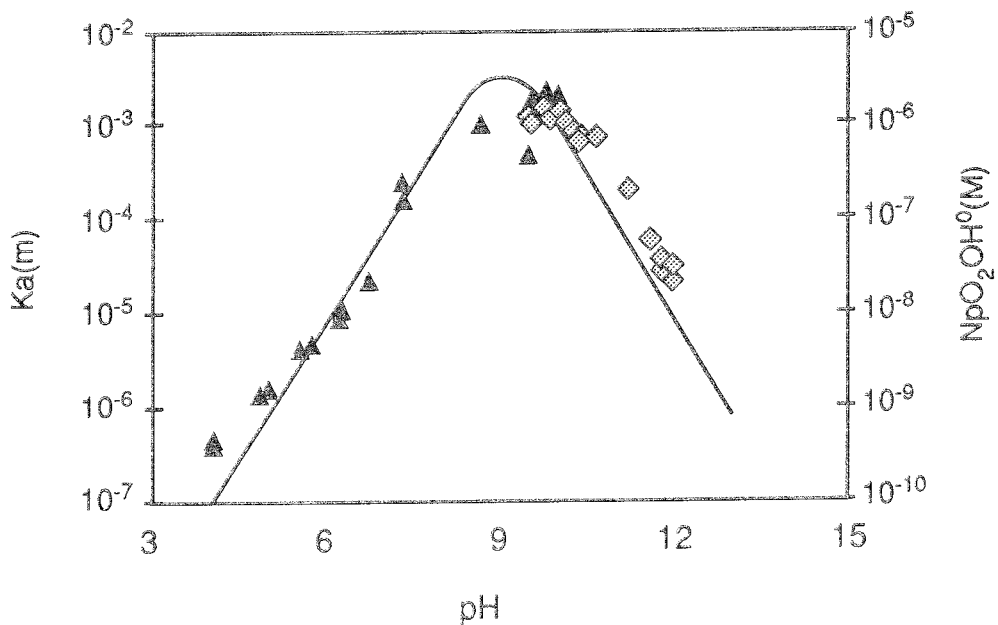

Figure 7-3. Measured sorption of neptunium (V) on haematite in two tests: ▲ and ◆ compared with estimated concentration of NpO_2OH (which is one of the dissolved Np(IV) species). The calculations were performed with EQ3 and the constants were taken from Allard et al., *Inorganica Chim. Acta* 94 (1984) pp. 205-221.

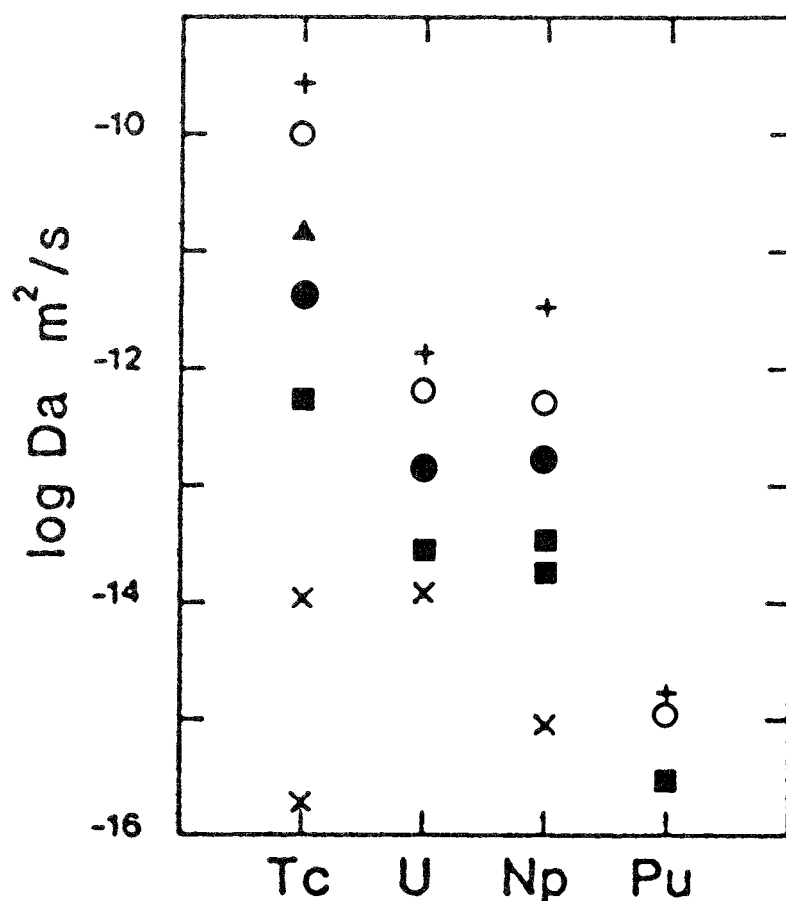

Figure 7-4. Measured diffusivity of radionuclides in pure compacted bentonite (O) and in bentonite with different additives: 1% Fe (X), 1% FeO (■), 1% Cu (●), 1% CuO (▲) and finally a mixture of 10% bentonite and 90% sand (+) /7-48/.

reducing agents in the near field, but they are also effective sorbents after they have been oxidized. The studies have been conducted in cooperation with the Los Alamos National Laboratory in the USA.

Diffusion tests have been performed with americium, plutonium, uranium, neptunium caesium, iodine and technetium in 90/10 mixtures of sand and bentonite (MX-80) /7-46/. Diffusivity Da is roughly an order of magnitude lower for the sand/bentonite mixture compared with pure bentonite. The properties of the radionuclide ion have a very great influence on diffusivity. The anions iodide and pertechnetate have diffusivities that are four orders of magnitude higher than those given by the trivalent cations. Plutonium (trivalent and tetravalent) diffuses immeasurably slowly.

Constants needed to calculate radionuclide diffusion in bentonite clay and granitic rock (Finnsjön) have been compiled to be used for the transport calculations for the SKB 91 safety assessment /7-47/.

Additives to bentonite have been tried to see whether this can further contribute to the retention of radionuclides in the buffer /7-48/. The additives that have been tried are iron, copper, ferrous oxide, cuprous oxide, vivianite (ferrous phosphate), magnetite and iron minerals that occur as fracture-filling minerals, see Figure 7-4. The tests were performed under oxygen-free conditions and the diffusivity Da of uranium, plutonium and technetium was measured. The greatest effects were obtained, not

unexpectedly, for iron and ferrous oxide. In other cases the reductions in diffusivity were small. The general conclusion can be drawn that iron and copper as canister materials and their corrosion products can contribute to the retention of released radionuclides by sorbing them. The value of an extra addition of these substances to the bentonite buffer is, however, dubious. Each substance added to the bentonite must be of such a nature that it does not jeopardize the other good properties of the bentonite, such as plasticity and swelling capacity.

Long-term tests with radionuclide diffusion in concrete have been carried out but not yet reported. The chemical composition of cement pore water has been examined and reported /7-49/.

7.2.3 Programme 1993–1998

Solubility, speciation, co-precipitation and kinetics

Some of the thermodynamic constants that describe solubility and speciation of actinides in deep groundwater need to be measured more exactly in order to avoid overly conservative assumptions in the safety assessment. Investigations of the solubility of neptunium(IV) and the formation of carbonate and hydroxide complexes for Np(IV) and Np(V) are therefore under way. Investigations of the solubility of plutonium (IV) as a function of Eh, pH and carbonate concentration have been initiated. Complexation data for americium(III) in carbonate-containing solutions may need to be examined to see whether additional experiments are necessary. Tests are also under way to determine the phosphate complexes of thorium(IV). Uranium(IV) should also be included in the phosphate experiments.

The importance of co-precipitation as a limiting factor for radionuclide migration and its use need to be further investigated. Ways in which co-precipitation can be utilized are also being investigated internationally. This is being done within the CEC project CHEMVAL, where SKB is also represented.

Tests are being conducted to show that neptunium is reduced under the geochemical conditions prevailing down in the rock.

Organic complexes, colloids and microbes

Sampling and analysis of the groundwater's content of these substances is still a very important part of the evaluation of their importance. Besides on sites such as Äspö, Laxemar etc., we also have an opportunity to take such samples in conjunction with studies of natural analogues in, for example, Poços de Caldas, Cigar Lake, Oklo etc. The latter is particularly valuable, since several of the elements that appear as radionuclides in the waste are also present.

Laboratory tests with radionuclides and humic substances will continue. All dissolved organic matter does not consist of humic and fulvic acids, however. There is a large fraction of other organic compounds that are hydrophilic but have less complex-binding capacity than humic and fulvic acids. It is urgent to characterize this component more accurately.

Additional laboratory tests will be conducted with colloids and radionuclides. Since the concentration of natural colloids in the natural groundwaters is low, these efforts are being concentrated on the colloids that are generated in the near field. The work also includes column experiments. Models for colloid transport and sorption on colloids will be tested to some extent.

It is essential to explore the importance of microbes. This includes not only their influence on release and migration of radionuclides, but also their ability to bring about geochemical changes. Sampling and experiments in connection with the Äspö Hard Rock Laboratory will also continue to be an important part of these investigations.

Sorption and diffusion

The surface complexation model for sorption of radionuclides on minerals will be tested further. The primary goal is to understand the sorption processes and predict what could affect them. Whether the K_d concept can be replaced with something better remains to be seen. To decide this it is of great interest to follow the efforts that are being made in other countries and in international projects such as CHEMVAL.

An essential factor for calculating retention due to sorption and diffusion in the microfissures in the rock is the surface area with which the radionuclides come into contact as they flow with the groundwater. It is urgent to obtain good measurements of this contact area.

Further tests with diffusion in backfill materials and concrete may be necessary. This will depend on the development of different concepts for disposal of radioactive waste and the compilation of diffusion measurements in concrete that has not yet been completed. The objectives of the concrete studies are being broadened to cover all types of long-lived waste, not just high-level. A sub-goal in this endeavour is to investigate the influence of the concrete on the surroundings and the waste and to determine the chemical and structural changes that will occur in the concrete with time, see also chapter 12.

7.3 VALIDATION OF PROCESSES IN TRANSPORT MODELS AND RADIONUCLIDE MIGRATION

7.3.1 Goal of the activities

The goal is to achieve a better understanding of, and validate, the models that are used to describe, release, retention and dispersal of radionuclides from a final repository.

Validation shall be accomplished by means of:

- laboratory tests
- tracer tests in situ
- study of natural analogues

7.3.2 Present-day state of knowledge

Radionuclide migration in general differs considerably from the transport of non-sorbing solutes. The transport of non-sorbing solutes is determined primarily by water flow and dispersion, see further section 7.2.3, while nuclide migration is controlled to a high degree by the chemical properties of the water and the nuclides. Although some radionuclides such as iodine-131 and carbon-14 do have low sorption when they occur as iodide and carbonate ions, respectively, not even these ions are completely non-sorbing. They are often dealt with in transport calculations as if they were. Figure 7-5 illustrates which methods can be used to determine groundwater transport and nuclide migration.

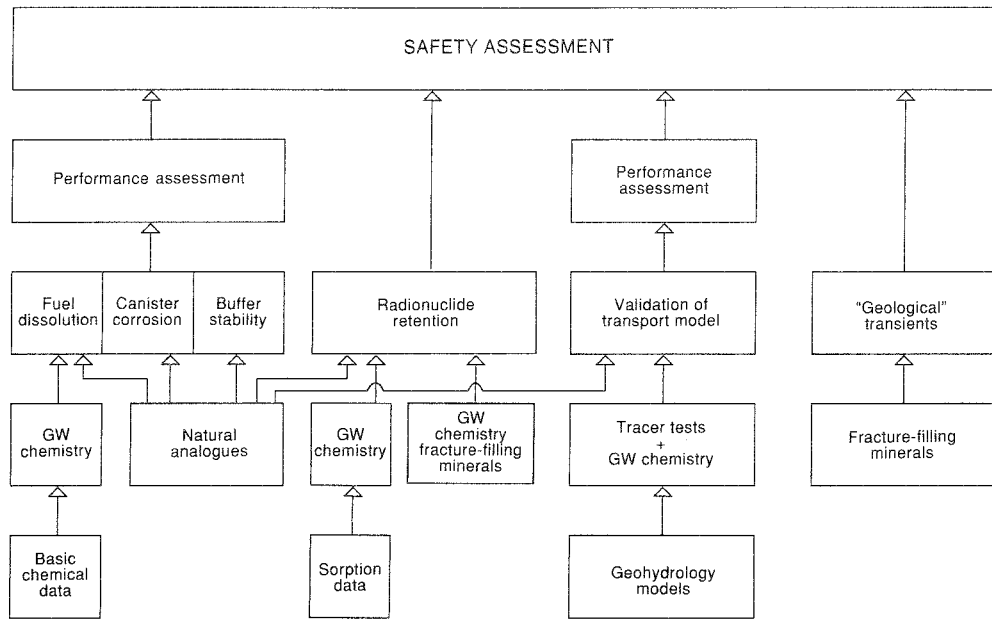

Figure 7-5. Illustration of how different kinds of data are used to model and validate transport.

Hydraulic data measured in boreholes serves as a basis for the models used to calculate groundwater flow. The models can be validated by means of tracer tests with non-sorbing tracers.

Nuclide migration is determined primarily by the chemical properties of the nuclides themselves and secondarily by the chemical nature of the groundwater and the minerals. Sorption of dissolved radionuclides delays their exit to the biosphere. Besides pure physical-chemical sorption on the mineral surfaces, diffusion into the rock matrix also occurs via the microfissures that connect the stagnant pore water with the outside flowing water.

The strength of the sorption is dependent on the nuclide's charge, hydrolysis and the presence of complexing agents. From this it follows that the groundwater's redox state, pH and content of complexing agents, such as fulvic and humic acids, are essential factors in describing the nuclide migration. Colloidal phases are also of importance where applicable. The difference in sorption strength between the redox states of the different radionuclides is much greater than the difference the can be caused by normal variations in groundwater composition and minerals.

Retarding processes such as sorption and matrix diffusion are dependent on how large a surface area is available for interaction with the rock. The presence of preferential flow paths can reduce the retention of dissolved radionuclides. Recent research has largely been focused on trying to characterize these flow paths.

INTRAVAL

SKI has initiated and led an international project called INTRAVAL. The purpose of the project is to obtain a better understanding of how different processes of importance for radionuclide transport can be described with mathematical models. This has been done by systematically utilizing information from laboratory tests, field tests and studies of natural analogues to try to validate different conceptual models and study the validation process. The tracer tests at Finnsjön and Stripa have constituted an

important part of the experiments used. INTRAVAL has also given modellers and experimentalists an opportunity to cooperate, leading to proposals for new types of tests capable of differentiating between processes such as channelling, matrix diffusion and dispersion. An important conclusion from the INTRAVAL study is that tests on different scales with different flows, concentrations etc. are necessary in order to be able to distinguish these processes.

The first phase of the project has been completed. INTRAVAL Phase 2 has now been started with a focus on the field tests, of which the Finnsjön and Stripa tests once again constitute important contributions. The work has so far shown that stochastic models can be useful for describing heterogeneities in crystalline bedrock, especially if the models can also make use of deterministic information on fracture zones.

Laboratory tests

Natural water-bearing fractures are selected and overcored. These drill cores can then be used for migration tests in the laboratory. The drilling is done so that the fracture is oriented along the axis of the drill core, if possible. The core is provided with a watertight casing and an inlet and an outlet at the ends. Such cores have been taken from Stripa, among other places. Recently, suitable drill cores were also selected from Äspö.

Two types of experiments are performed: migration tests with radionuclides and inactive tracers, and flow experiments. In the latter case, the stone is clamped so that the fracture can be compressed with different pressures.

Previous results of the laboratory tests with migration of radionuclides through a water-bearing fracture have been evaluated within the international INTRAVAL project.

Equipment in which different aspects of radionuclide migration can be tested is being developed for later use in chemically oriented in-situ tests.

Tracer tests

Tracer tests are the only method that permit the ability of the rock to transport and retard radionuclides to be determined on a large scale. Results of tracer tests are used to verify and validate different models for groundwater flow and transport and to develop new model concepts. Single-hole tracer tests, so-called dilution measurements, are used to measure the groundwater flow through sealed-off sections of boreholes, while cross-hole tests are used to determine transport parameters and connectivity between fractures and fracture zones.

Tracer tests have been carried out on different scales with partly different purposes. Large-scale tests have been performed at Finnsjön to study transport in high-conductivity fracture zones, which are expected to comprise the outer hydraulic boundaries of a repository. Tests in conjunction with the pre-investigations on Äspö have been performed to determine transport parameters and connectivity between fracture zones, while the smaller-scale tests at Stripa have been focused on the transport in local fracture zones and individual fractures. All of these tests show that the heterogeneity and connectivity of the rock between fractures and fracture zones is of great importance for radionuclide transport.

Stripa

A number of tracer tests have been carried out at Stripa within the framework of the international OECD/NEA project. The SCV (Site Characterization and Validation) project has been under way for five years, one of the main purposes of which has been

to develop methods for model validation. Predictions have hereby been made based on different concepts, and tracer tests have been used for verification/validation of the models. One of the tests consisted of a combined tracer test and radar measurement, where transport and flow distribution were studied in a local fracture zone before and after the mining of a drift. The tests were conducted by injecting a saline solution in a fracture zone, after which radar measurements were performed at different times. In this way the transport of the saline solution in the zone could be followed in different time increments. A tracer test was then carried out in the same fracture zone with a lower flow gradient. In this test, 12 different tracers were injected at 9 different points at a distance of 15–25 m from the drift. Both of these tests show that the disturbed zone that is formed around a drift is of great importance for transport in the near field around the drift and that the transport is concentrated to a few preferential flow paths.

The distribution of flow paths has also been studied on a smaller scale in an individual fracture. A series of hydraulic tests and tracer tests has been carried out along a fracture plane. The tests indicate that, on average, 25% or less of a fracture plane is open for flow and that the flow is distributed in channels with widths from millimetres up to decimetres, which in turn occur in clusters several decimetres in width.

Finnsjön

The large-scale tests in a high-conductivity flat-lying fracture zone at Finnsjön have been concluded. A series of interference tests, radially convergent tracer tests and dipole tests have constituted the foundation for a large modelling effort that is still under way within the framework of Phase two of the INTRAVAL project. The large quantity of background data available from Finnsjön has provided input data for modelling with many different concepts. Besides the porous continuum model with advection and dispersion alone, modelling with matrix diffusion, channelling and stochastic models has also been performed.

The tests at Finnsjön show that the heterogeneity is meaningful even on this large scale and that the transport velocity can vary considerably in different directions.

Äspö

The pre-investigations for the Äspö Hard Rock Laboratory have included tracer tests with non-sorbing tracers. The purpose has been to verify the conceptual model of the area, but also to determine transport parameters for different fracture zones. The test was therefore preceded by predictions of expected drawdowns and travel times.

A convergent large-scale test was carried out by pumping in a centrally situated borehole and adding tracers at six points in different zones at distances of 100–400 m from the pump hole. The test showed that the flow porosity (which is a measure of how large a portion of a geological unit, e.g. a fracture zone, is involved in the transport) varies considerably between different zones, despite the fact that the zones have roughly the same transmissivity. The test also shows that the connection between different zones is of great importance for the distribution of the transport in the rock mass. The test also confirms the conclusion from the Finnsjön tests that the transport properties in the fracture zone vary in different directions.

Single-hole tests in the form of dilution measurements are also being used in different phases of the construction for the purpose of studying changes in the groundwater flow and to verify numerical model predictions.

Tracers

In each tracer test that is performed, the choice of tracers is very important. Tracers that have proved to be very suitable for large-scale tests with fast travel times may be

unsuitable for tests in impervious rock with long contact times. A further complicating factor is that the tracers may remain in the rock for a very long time and therefore disturb future tests. This is particularly important in the Äspö Hard Rock Laboratory.

Natural analogues

Studies of natural analogues of release and transport of radionuclides were carried out in cooperation with the UK (UK DoE), Switzerland (NAGRA), the USA (US DOE) and Brazil. The project was started in May 1986 and concluded in March 1990. The Poços de Caldas project is described in chapter 8.

SKB has been participating together with AECL (Canada) and US DOE in the Cigar Lake project since 1989. This participation is for a three-year period to begin with.

SKB has also participated in a reconnaissance study of natural reactors in Gabon. This is included in the Oklo project, under the direction of French CEA with support from CEC. Both Cigar Lake and Oklo are dealt with in chapter 8.

Besides this direct participation in the analogue projects, supportive research is also being conducted, such as development of models for chemical transport, geochemical changes and radionuclide chemistry in the groundwater.

In-situ experiments

The Äspö Hard Rock Laboratory makes it possible to conduct experiments under the chemical conditions that prevail in the bedrock. Prior to the start of the Äspö project, a series of experiments were identified with the following goals:

- Test dissolution and migration of radionuclides in situ.
- Validate models and check constants used to describe the dissolution of radionuclides in groundwater, the influence of radiolysis, fuel corrosion, sorption on mineral surfaces, diffusion in the rock matrix, diffusion in backfill material, transport out of a defective canister and transport in an individual rock fracture.
- Specially test the influence of naturally reducing conditions on solubility and sorption of radionuclides.
- Test the ability of the groundwater to take up and transport radionuclides with natural colloids, humic substances and fulvic acids.
- Investigate the influence of bacteria on chemical conditions and radionuclide migration.
- Material testing and the chemical influence of grouting and backfill materials such as bentonite and cement.

Laboratory studies with this thrust have been under way for a ten-year period. The planned experiments are in some cases therefore more in the nature of demonstration than knowledge-gathering. They are nevertheless well warranted since it is virtually impossible to simulate conditions in the rock exactly in the laboratory.

7.3.3 Research programme 1993–1998

Laboratory tests

The experiments with radionuclide migration in water-bearing fractures in drill cores continue. The two different types of experiments, i.e. radionuclide tests and flow experiments, are being conducted in parallel.

Equipment for subsequent in-situ tests with radionuclides is being developed and will be tested in the laboratory. Increasing efforts in this field are foreseen.

Tracer tests

Non-sorbing tracers

Non-sorbing tracers are used to validate the groundwater flow modelling that has been based on hydraulic parameters. Tracer tests of this kind can in principle be performed on any scale, but must often be limited due to the fact that the travel times are very long, even if it is a question of short distances under forced conditions. This type of tracer test will therefore be focused on specific points aimed at confirming the presence of fast transport pathways. Despite the fact that the results may show that no tracer breakthrough has been detected, it may be of benefit to be able to show that the travel times have not been underestimated, see appendix A in the background report to RD&D-Programme 92 concerning the Äspö Hard Rock Laboratory /7-51/.

Radioactive non-sorbing tracers have been used in two large-scale field tests, one at Finnsjön (the dipole test) and the other on Äspö (LPT-2). In both cases, short-lived isotopes with half-lives varying from a few hours to two months were used. There are plans to use radioactive tracers on Äspö in the future, after the tunnelling work has been completed. The purpose will then be to validate water travel times for specific flow paths /7-51/.

Stable tracers can be used to determine the connectivity between e.g. different borehole sections and the tunnel during the actual construction phase. Similar tests have been conducted within the framework of the geohydrological investigations in the NE-1 fracture zone in the Äspö tunnel. The experience and the preliminary results obtained to date suggest that similar tests will be performed during the rest of the construction phase as well.

Natural tracers

In order for tracer tests to be utilized for the validation of transport models, the tests must be conducted over a very long period of time. Under natural undisturbed conditions, the naturally occurring tracers are therefore usable. Of the constituents dissolved in water, chloride, tritium, oxygen-18 and sulphur-34 seem to be the best. All of these have been utilized on Äspö to explain the origin and history of the groundwater, see section 7.1.2. The results, although detailed, are qualitative, since it is difficult to determine when in time a process started and how it has since developed, for example when the Äspö water became saline.

Tritium is the most useful natural tracer for large-scale validation of groundwater transport models with respect to rapid transport pathways. Groundwater is being sampled during the entire construction phase for tritium analysis. Since significant tritium levels indicate an admixture of modern water (younger than 35 years), points where such levels are obtained are a sign of a relatively fast flow path.

Within the framework of the geohydrochemical documentation work, a number of components are being analyzed that can be used in combination to interpret tritium data, including the aforementioned oxygen-18, carbon-14, sulphur-34 and principal components.

Sorbing tracers

Like the non-sorbing tracers, the sorbing tracers can be either stable or radioactive. The sorbing tracers are used primarily as a model for how radionuclides from a

leaking repository can be transported with the groundwater. Unlike the non-sorbing tracers, their transport is only slightly dependent on the groundwater flow. Far more important factors are, for example, the tendency of the tracers to adhere to mineral surfaces and the size of these surfaces.

Flow-wetted surface area is a measure of how large the reactive surface area is. The size of the flow-wetted surface area affects all interaction between the rock and the water. Within the framework of the already ongoing redox experiment, different attempts will be made to determine the flow-wetted surface area, see /7-51/. For the purpose of detailed characterization of the transport of caesium and strontium, these substances will be injected over a long time in a suitable fracture, which will later be excavated for analysis, see /7-51/.

Extremely weakly sorbing tracers can be used in tracer tests over distances of 1-10 metres. The results of these tests can be used to describe transport in the good rock's network of fissures (channel network), see further in /7-51/. In order to carry out these tests, it is first necessary to try out suitable tracers. Knowledge of extremely weakly sorbing tracers that can be used for this purpose is scanty. Plans exist to test possible cations in batch and column tests in the lab. These will precede the field tests.

In-situ experiments

To enable the experiments with radionuclides to be performed in-situ, a borehole instrument called CHEMLAB is being developed. The probe consists of two parts. One part is the geochemical probe that measures pH, Eh, conductivity etc. The other part is an automatic chemical laboratory where a number of different experiments can be performed. No water from the probe goes to the rock, which means that radionuclides can be used in the probe.

The development of the CHEMLAB probe has begun. The part of the probe where the tests are performed and samples are collected is being designed in cooperation with CEA of France. CHEMLAB is a further development of the French probe FORALAB. The part that measures water composition already exists (CHEMMAC). The equipment is expected to be ready to be put into use in 1994.

In the probe

A series of experiments has been proposed. The list is provisional so far, but it serves as guidance for the design of CHEMLAB, the procurement of peripheral equipment and the preparation of permits to handle small quantities of radionuclides.

In the chemistry laboratory

These experiments will supplement the experiments in the probe: a) repetition of the probe tests for the purpose of verification; b) analysis of colloids, microbes and humic and fulvic acids; and c) testing of the ability of these aggregates to take up and transport radionuclides.

Out in the fracture zone and the rock

Supplementary tests can also be performed out in the rock. The supplementary experiments will only be planned after the results from similar tests during the construction phase have become available (see the redox tests).

In-diffusion of sorbing nuclides in the micropores in the rock is tested by injecting sorbing inactive isotopes, e.g. inactive caesium and strontium, together with non-sorbing tracers in undisturbed parts of the rock.

Laboratory tests are performed in preparation for the experiments that are to be conducted in the probe and out in the fracture zone. In connection with the laboratory tests, test set-ups are developed that can be moved into the probe and connected to it. Planning and development have come the furthest with regard to diffusion tests, migration in rock fracture and radiolysis.

Both equipment tests and preparatory experiments will be carried out. New materials will be tested for use in the probe.

Natural analogues

A part of the Cigar Lake project is being concluded during 1992 and a report is being written. SKB's continued involvement in the project will be decided on the basis of the results. The research currently being done for the Oklo project with the support of SKB will be broadened somewhat towards the end of 1992.

SKB is following the Alligator Rivers project, ARAP, through participation in the INTRAVAL project where results from ARAP are being processed. Furthermore, SKB is participating as an observer in the analogue projects in Palmottu, Finland, and Maqarin, Jordan, which involve studies of a uranium mineralization in granite and in hyperalkaline groundwater.

Regarding natural analogues, see further chapter 8.

7.4 MISCELLANEOUS

7.4.1 The fracture zone project

Major fracture zones are of great importance for the emplacement of a deep repository. In order to facilitate the safety assessment, a projected repository is emplaced with a respect distance to the nearest major fracture zones. The purpose of the fracture zone project is to become acquainted with the (transport) properties of these zones so well that the respect distance can be optimized. If the retarding properties of the zones counteract a possible higher water flow rate there, the zones will not constitute a greater risk for the dispersal of the nuclides than the surrounding rock.

A flat-lying, strongly water-conducting zone at Finnsjön has been under investigation since 1984. The results have been compiled in a large number of reports and publications. The findings from the investigations have been used in SKB's other activities, for example on Äspö and in the SKB 91 assessment.

After the introductory phase of the investigations, it was found that the flat-lying zone comprises a boundary between saline and fresh water. Understanding the mechanisms underlying this then became an essential part of the continued work.

The investigations at Finnsjön have now been concluded. A final report on the fracture zone project will be prepared during the coming period. Since all results and interpretations have already been reported, the purpose of the final report is to summarize what has been done and refer to previous synopses.

7.4.2 Chemical toxicity

The essential research work deals with the radiological toxicity of the waste. It is because of this that different forms of isolating repositories must be built. It can, however, be noted that a small fraction of the radioactive material to be isolated would be classified as chemical waste if it were not radioactive.

An inventory has been made of the chemical elements present in a repository for spent nuclear fuel. Quantities and possible toxicity have been summarized /7-50/. The preparations for a final safety account also include describing chemical health hazards in a manner similar to what has been done for SFR. However, the inventory shows that the chemotoxic consequences of a final disposal of Swedish radioactive waste will be small or negligible.

8 NATURAL ANALOGUES

The safety assessment shall be valid for hundreds of thousands of years. It is not possible to conduct tests on that time scale, not even accelerated tests. Slow processes of importance for long-term safety could at worst escape observation. One way to circumvent this problem is to rely on physical laws, for example thermodynamic limitations. Another way is to make observations of natural phenomena where the conditions are similar and the time span for the course of events is comparable.

The latter approach is designated “studies of natural analogues of deep disposal of radioactive waste” and includes studies of both archeological finds and geological formations. According to a definition by the IAEA, natural analogues are “experiments in nature that are not controlled by man”.

8.1 POÇOS DE CALDAS

The objective of the Poços de Caldas project has been to study the processes that control release and transport of radionuclides with the groundwater flow. Two sites with high natural concentrations of radionuclides and radionuclide-like substances were chosen for this purpose: a thorium-lanthanide mineralization in Morro do Ferro and a uranium deposit in the Osamu Utsumi mine. Both sites are situated near the city of Poços de Caldas in Minas Gerais, Brazil. Both of the orebodies lie relatively close to the surface and in a zone of intensive weathering and groundwater flow.

The Poços de Caldas project was started in May 1986 and continued until March 1990. Participants in the project have been SKB, UK DoE (United Kingdom), NAGRA (Switzerland), US DOE (USA) and a number of Brazilian organizations such as the Federal University in Rio de Janeiro, the Catholic University in Rio de Janeiro, the Catholic University in São Paulo, CNEN and URANIO DO BRASIL. The project was directed and coordinated by SKB.

The results of the studies are presented in technical reports, lectures and publications /8-1 to 8-27/. All the results and their importance for the safety assessment are summarized in a technical report /8-28/. The conclusions can be roughly summarized in the following points:

- Uranium dioxide (uraninite, pitchblende) is stable under naturally reducing conditions. It is precipitated after reduction when hexavalent dissolved uranium gets out into the rock. The formation and dissolution of a pitchblende nodule takes place at a rate of a few centimetres per million years. Plutonium occurs naturally and is stable in the uranium nodules.
- The geochemical model that is used to describe the redox properties of the groundwater at repository depth is generally applicable and is verified by the measurements at lower pHs in Poços de Caldas.
- Predictive geochemical model calculations made by different groups show that the solubility of radionuclides and trace metals is usually overestimated. In other words, solubility can be calculated without any risk of underestimates. The speciation of radionuclides and trace metals, i.e. which complex ions are formed in the water, is more difficult to calculate with certainty.
- The propagation of the redox front and precipitation of uranium at the redox front could well be simulated with calculations models that couple reaction and trans-

port. The calculation results have led to a refinement of the models and, in one case, correction of the database.

- “Channelling” and “matrix diffusion” were verified by simulated model calculations of the shape of the surface of the redox front.
- Co-precipitation could be clearly observed at the redox front, but it was not possible to deal with this in models. This requires development of models.
- Colloids and dissolved organic matter are present in high concentrations in the superficial groundwaters in Poços de Caldas. Radionuclides and trace metals are adsorbed strongly by the colloidal particles, but no appreciable colloid transport takes place. The concentration and nature of colloids at depth resembles that found in Swedish groundwaters. The colloid-borne trace metals are in equilibrium with the deep groundwater.
- Microbes participate in the geochemical reactions.
- Magma intrusion in the uranium mineralization in Osamu Utsumi has caused hydrothermal transport of uranium. This could be simulated with model calculations, which showed that uranium solubility at high temperatures (300°C) is very poorly known. It was further found that low hydraulic conductivity in the rock is a good protection against negative effects of hydrothermal transport, i.e. dissolution of minerals and spent fuel.

The conclusions that have been directly used to support new safety assessments are, firstly, the confirmation of the iron mineral’s redox control, and secondly the finding that colloids do not contribute in any decisive way to the migration of radionuclides.

8.1.1 The geology of the area

Both Morro do Ferro and Osamu Utsumi are situated within a volcanic caldera with a diameter of 30 km, see Figure 8-1. It was formed 75 million years ago. The most common rock types within the caldera are nepheline syenites and phonolites rich in calcium. The rock types have relatively high contents of uranium, thorium and lanthanides. Local concentrations of these elements were later formed as a result of the hydrothermal activities in the area and orebodies were formed.

Today, the Poços de Caldas caldera is located 1500 m above sea level, which is about 500 m lower than the time after its formation. In 50 million years it has eroded at a rate of 6-7 m/Ma. The drainage pattern during this time has not changed very much. The weathering rate during the past 10 million years has been estimated at 12 m/Ma.

Morro do Ferro is a 140 m high hill with a diameter of roughly one kilometer, see Figure 8-2. Two creeks drain the hill. The orebody is about 150 m wide, 320 m long and extends between 30 and 100 m down from the ground surface. It is situated on one side of and fairly near the top of the hill and contains approximately 30 000 tonnes of thorium, 50 000 tonnes of lanthanides and some uranium, see Figure 8-3. The concentrations in the ore are 0.5 – 10 g of thorium and lanthanides and 20 – 60 mg of uranium per kg. Thorium occurs as grains of different minerals: thorianite, thorite, cerianite, cheralite and thorbastnaesite. Some of the thorium minerals contain lanthanides and uranium. Thorium and uranium also occur together with iron hydroxides or clay particles covered with iron hydroxides. Near the ground surface, cerium has been oxidized to Ce(IV) and is included in the mineral cerianite. Deeper down, trivalent lanthanides have formed secondary minerals such as neodymium lanthanite /8-25/.

Morro do Ferro is completely weathered down to a depth of 100 m and is also affected further down. The measured hydraulic conductivity in the weathered rock is 10^{-5} to 10^{-6} m/s, which is to be compared with 10^{-7} to 10^{-9} m/s in the surrounding phonolite.

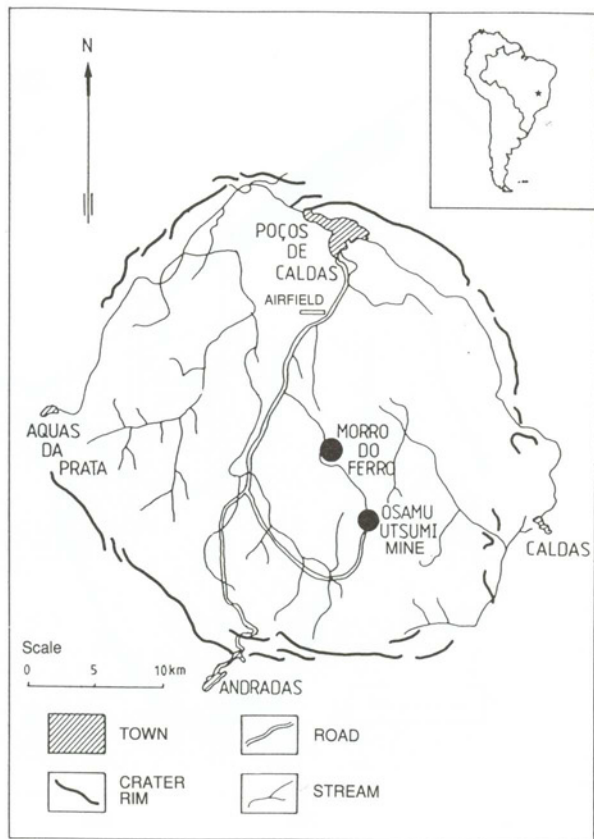

Figure 8-1. The study sites Osamu Utsumi and Morro do Ferro within the Poços de Caldas caldera.



Figure 8-2. Morro do Ferro.

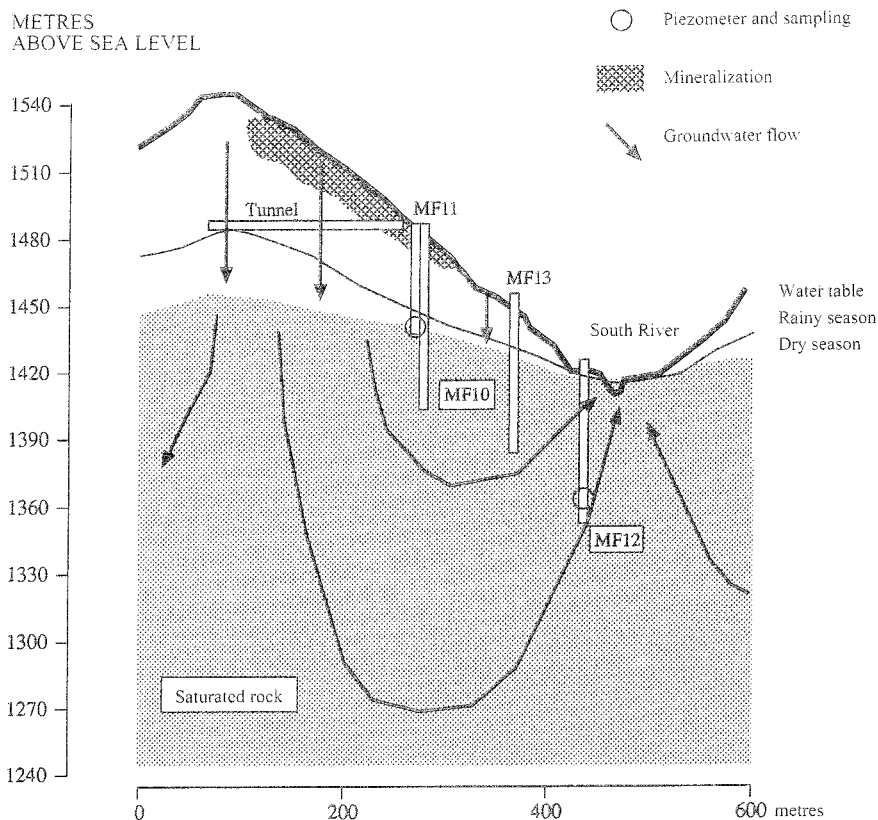

Figure 8-3. Profile through Morro do Ferro.

A redox front was encountered 36 m down in “fresh” phonolite, which in turn was found at 28 m in a vertical borehole at the foot of the hill. The groundwater table is located at least 80 m below the top of the hill.

The orebody was explored in the fifties and sixties, when a tunnel was driven in through the orebody. A total of four new vertical boreholes of between 40 and 75 m were drilled for measurements and samplings within the project.

The uranium mine of Osamu Utsumi has been in operation since 1975. It is an open-cast mine that covers two square kilometres, see Figure 8-4. The rock consists of hydrothermally altered phonolite and nepheline syenite. The hydrothermal alteration has been caused by magmatic intrusions that have left behind two large breccia pipes. Besides uranium there are also substantial quantities of thorium, lanthanides, molybdenum and zirconium.

The upper part of the rock is heavily weathered with the formation of laterite. Further down, oxidizing groundwater from the surface has caused the formation of a redox front, see Figure 8-5. It is clearly distinguishable as a colour change from yellowish-brown oxidized rock to greyish-blue rock as yet unaffected by oxygen. The uranium is enriched in the redox front, see Figure 8-6. Uranium occurs both as nodules of pitchblende and sorbed in iron hydroxides.

A number of mineral phases in the reduced phonolite are associated with thorium and rare earth metals: monazite, cheralite (most common), bastnaesite, crandallite, florencite, gorceixite and goyazite. Most rare earth metals show a tendency to be



Figure 8-4. The open-cast mine at Osamu Utsumi.

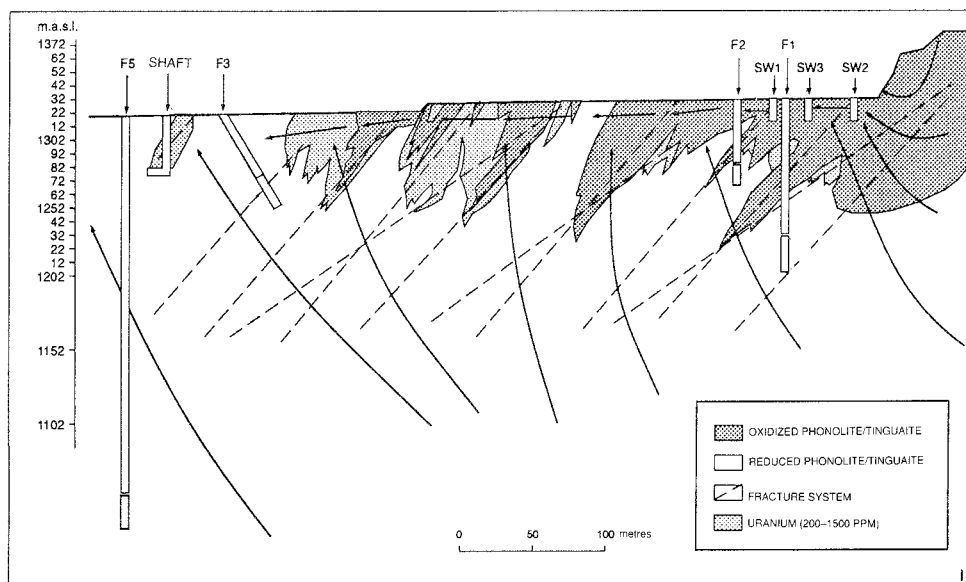

Figure 8-5. Geology and investigated boreholes in the Osamu Utsumi uranium mine.

Table 8-1. Representative groundwater analyses from the Osamu Utsumi uranium mine and Morro do Ferro. All concentrations in mg/l and Eh in mV.

	OSAMU UTSUMI		MORRO DO FERRO	
	F1	F2	F4	MF12
Code	[Select]	PC-GW-78	PC-GW-80	PC-GW-50
Date	870707	890320	890413	880614
T °C	22	21	24	21
pH (field/lab)	4.87/4.06	5.90/6.42	5.83/6.38	5.99/6.19
Eh	338	191	462	212
Alkalinity	2.0	10	23.5	22
Ca	0.47	2.65	7.88	8.48
Mg	0.07	0.07	0.46	0.70
Sr	0.043	0.009	0.20	0.346
Ba	0.125	0.13	0.12	
Na	0.20	0.2	0.63	0.84
K	12.7	13.5	11.8	11.2
Fe(II)	1.30	1.67	6.13	0.74
Fe(III)	1.33	1.70	6.27	0.79
Al		0.319	0.183	0.21
Mn	0.19	0.318	0.13	1.68
Zn	0.083	0.211	2.17	0.27
SO ₄	16	14	28	9.5
F	0.41	2.57	6.0	5.3
Cl	3.0			
Br	0.04			
SiO ₂	35	29	34	33.4



Figure 8-6. Phonolite from the Osamu Utsumi uranium mine in Poços de Caldas. The sharp boundary between oxidized rock (grayish-brown) and reducing (gray) can be seen. The black nodules on the reducing side are the uranium ore pitchblende.

leached out of the oxidized phonolite and be enriched in the reducing part near the front. The exceptions are Eu and Ce, which tend to be enriched in the oxidized portion.

Three shallow and five deep holes were drilled within the framework of the project. The deepest borehole went down to about 300 m. The boreholes were used for measurements and samplings. The measured hydraulic conductivity down in the rock lay between 10^{-5} and 10^{-8} m/s. The three-dimensional groundwater flow before and after the advent of the open-cast mine was simulated by model calculations. The mine, which is very extensive, naturally has an altered flow field compared with the situation when the ore was formed.

8.1.2 Groundwater chemistry

The groundwater in Morro do Ferro and Osamu Utsumi contains relatively little carbonate. Instead sulphate is common, and in Osamu Utsumi sulphate dominates over carbonate, see Table 8-1. Potassium is the most common cation, followed by calcium. The waters are relatively young and their total content of solutes is low.

The water's composition is explained by the relatively rapid infiltration of oxidizing meteoric waters. The bedrock, especially in the uranium mine, is rich in pyrite, which is oxidized by the infiltrating water to ferric hydroxide. At the same time, sulphate and hydrogen ions are formed. Potassium feldspar reacts with hydrogen ions and weathers to kaolinite at the same time as potassium is released. It is this reaction which takes

place in the redox front and which is mainly being studied in the uranium mine, but also in Morro do Ferro. The reactions lead to formation of iron hydroxide, kaolinite and a water with low Ph where potassium and sulphate are the dominant ionic species. These reactions could, after some initial difficulties, be simulated by geochemical modellings. The modellings were carried out to describe the propagation of the redox front as a function of time.

Accurate measurements of pH and redox potential were performed in the field. In a closed system, groundwater was pumped from water-bearing sections in the boreholes, which had been isolated with rubber packers, to measurement equipment on the surface. The same equipment has previously been used for geohydrochemical sampling on study sites in Sweden. The redox potential is much higher than in Swedish groundwaters. In some of the cases, this is due to the fact that oxygen is still present in the water. This is particularly true of sampling points near the ground surface. Since the water is oxygen-free, the redox potential is controlled by the concentration of divalent iron, which is high, pH and equilibrium with ferric hydroxide. These are the same conditions that have been found in Swedish groundwaters, but in Poços de Caldas the pH is lower, so the Eh is higher. The model that relates the measured values of Eh in deep groundwaters to pH and the concentration of divalent iron is important for deep disposal of radioactive waste. The measurements in Poços de Caldas verify the general validity of the model.

Analysis of tritium, deuterium and oxygen-18 confirms that the groundwater is meteoric and that the water flux is fast. Both the thorium-lanthanide mineralization and the uranium ore are exposed to high water flows and aggressive water chemistry compared with the conditions prevailing in a deep repository.

8.1.3 Radionuclides and trace metals

Computer programs for thermodynamic calculations are used to an ever-increasing extent to predict solubility and speciation of radionuclides from radioactive waste. To test the usefulness of such models, five different groups were engaged to calculate, without knowledge of the results, concentrations of different tracers in the groundwater. These groups use to some extent different databases with thermodynamic constants. The input values consisted of the measured water chemistry, except for the selected tracers, and the mineralogical compositions of the rock and the ores. The elements that were tested in the calculations were U, Th, Pb, V, Ni, Sn, Se, Sr, Ra, Mn, Al and Zn.

In general, calculated values that were comparable to the measured levels were obtained. As a rule, solubility was overestimated, which is preferable for the purpose of safety assessments. In only two cases was solubility underestimated: for Ni and Zn when iron-bearing minerals were assumed as solubility-limiting phases. If these minerals are to be used as solubility-limiting phases in any context, it is first necessary to show that they are formed. The best agreement between calculated and measured solubility was obtained for Th, Pb and Al.

The lower than calculated solubility may be due to the fact that solubility-limiting minerals are lacking in the database, e.g. goyazite for Sr, or to the fact that the constants are unnecessarily cautiously chosen, e.g. for U. Other possible reasons for low concentrations are co-precipitation and sorption on ferric hydroxide phases, or the fact that solubility equilibrium has not been achieved for all elements, despite long contact times and abundance as minerals.

8.1.4 The redox front

The redox front in Osamu Utsumi is very distinct and can be followed both in the open pit and in boreholes from the surface. The uranium ore is concentrated to the redox front, and the surface of the front has therefore been mapped in conjunction with the mining operations.

The geological and mineralogical changes around the redox front have been thoroughly studied within the analogue project. The reactions that form the front can be summarized in the following formulas:

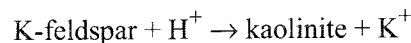
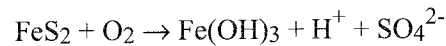

The front moves at a rate of about 10 m per million years. Uranium is enriched at the front and pitchblende precipitates as black nodules on the reducing side of the front, see Figure 8-6. These nodules are then dissolved when the front has advanced further and passed them. The formation and dissolution of the nodules takes place at a rate of a few centimetres per million years according to the isotope measurements. Uranium is also enriched by being taken up when the ferric hydroxide is formed.

Simple mass balance calculations have been carried out. If it is assumed that 100 mm of oxygenated water infiltrates per year and that the existing pyrite is completely oxidized, the rate of advance of the front is 25 m per million years, which comes fairly close to the measured rate of 10 m/Ma.

The redox front does not form an even, flat surface, but extends down along hydraulic conductors in the rock. The result is a "jagged" interface between already oxidized and still reducing rock. By positing advection and diffusion as transport processes for oxygen in the groundwater and assuming that the flow is concentrated to portions of open conductive vertical fractures, it was possible to simulate the appearance of the front by means of modellings. This demonstrates in a convincing manner the occurrence of transport phenomena such as "channelling" and "matrix diffusion".

The detailed geochemical modelling of the redox front has been carried out with the computer programs CHEQMATE and CHEMTARD. These calculation programs couple chemical equilibrium with transport. The sharp redox transition could be simulated in the calculations and the calculated rate of advance of the front agreed with the measured value. Difficulties in obtaining correct pH values in the first round of calculations occasioned an improvement of the database HATCHES, which is included in CHEQMATE /8-27/.

Another model was also tested. It was developed by Lichtner /8-29/ and describes the geochemical reactions with pseudokinetic rate expressions. The calculation method is fast and sharp redox fronts can be simulated without difficulty /8-26/, see Figure 8-7.

The reactions at the redox front and its movement were simulated with the coupled models. Transport of uranium and precipitation of uranium on the reducing side could also be simulated in the calculations. An attempt was made to simulate the fixing of uranium to ferric hydroxide phases on the oxidizing side with CHEMTARD, which can also include surface sorption. Autoradiography examinations show, however, that the mechanism is actually co-precipitation, which is not included in the models.

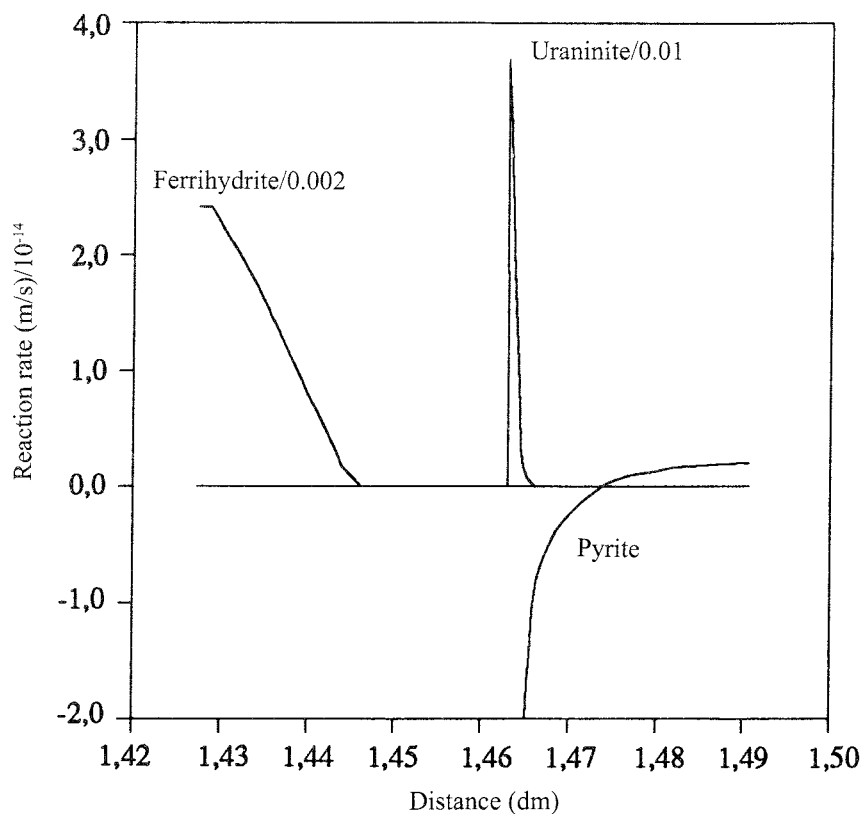

Figure 8-7. The calculated rate for formation of ferric hydroxide, precipitation of uranium dioxide and consumption/precipitation of pyrite across a redox front in Osamu Utsumi.

8.1.5 Co-precipitation

Besides uranium, several other elements are also enriched at the redox front. These include e.g. caesium, which is not itself affected by redox changes, see Figure 8-8. In several of these cases the mechanism is apparently co-precipitation. Not even uranium is enriched solely through reduction to pitchblende. Some of the uranium is taken up in the ferric hydroxide that is formed after the front has passed. At the time the project was evaluated there were no transport models that included co-precipitation. Data were also lacking that described the uptake of tracers in the mineral phases that had been formed. All in all, the effect had not been expected to be so pronounced.

Since co-precipitation is virtually irreversible, at least for the very long periods of time that would be required for the minerals to be altered or for diffusion in the solid material, it can be a valuable barrier in a deep repository for radioactive waste. Conceivable causes of co-precipitation in a deep repository include corrosion of encapsulation material, especially iron, precipitation of calcite, alteration of cement and reactions between cement and groundwater (to the extent that cement is used).

8.1.6 Plutonium

Plutonium is perhaps not something that is normally associated with natural deposits. Nevertheless, plutonium is present in uranium minerals, although in very low concentrations. It is formed there continuously through neutron capture in uranium. The concentration of plutonium measured in a centimetre-large nodule of pitchblende

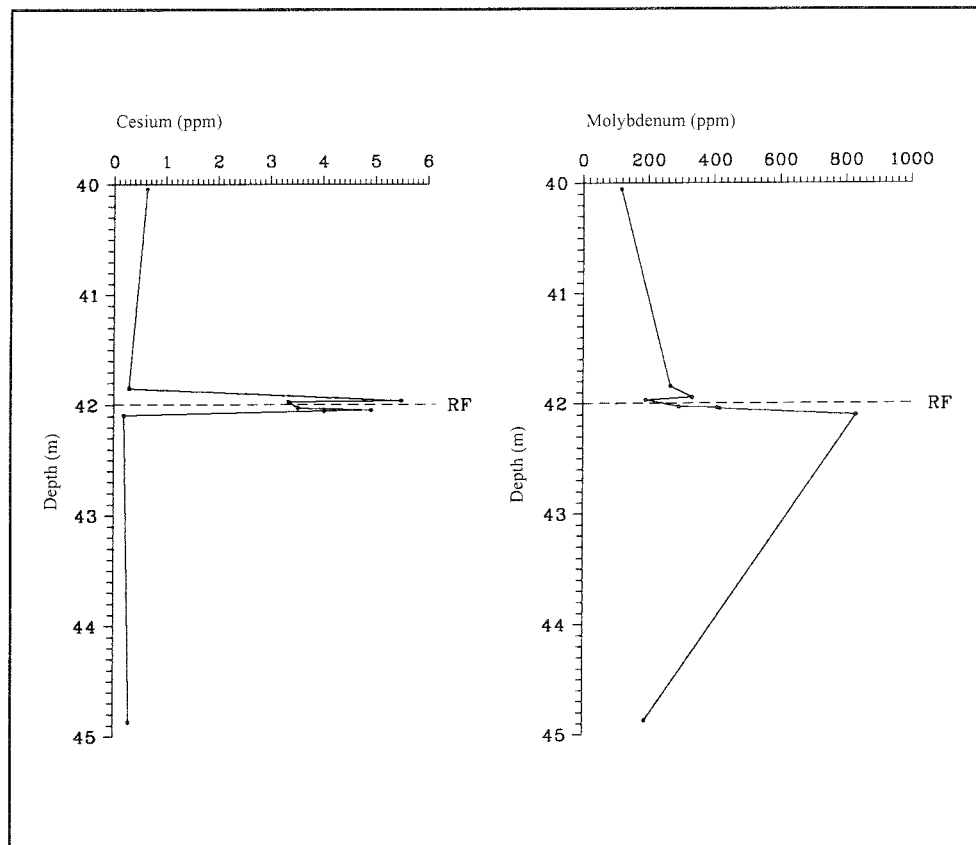

Figure 8-8. Concentration profiles of caesium and molybdenum across a redox front, RF, in Osamu Utsumi.

from Osamu Utsumi was $2.3 \pm 0.7 \times 10^8$ atoms per gramme. The concentration of plutonium produced in the nodule is dependent on the composition of the rock within a radius of 50 cm. Calculations show that the Pu/U ratio in the pitchblende nodule is in secular equilibrium. This indicates there has not been any appreciable fractionation of plutonium from uranium for at least 100 000 years.

8.1.7 Colloids

The prerequisites for colloid formation are very good in both Morro do Ferro and Osamu Utsumi. Weathering is intensive and the weathered rock is rich in clay minerals. The groundwater has a low content of dissolved salts, which gives high stability for e.g. clay colloids. The content of iron and silica is relatively high in the groundwater. Redox and pH changes occur along the flow paths of the groundwater and can give rise to local supersaturations of e.g. uranium. The groundwater flow is high, which also favours colloid transport.

There is plenty of particulate matter in the superficial groundwater at Poços de Caldas, but the concentrations in the deeper groundwater are low. In fact, the concentration of colloids in the groundwater at e.g. Morro do Ferro is not much different than the concentrations in Swedish groundwater, i.e. less than 1 mg/l. Iron hydroxides and humic substances dominate, while clay particles occur in relatively low concentrations. With the exception of the organic colloids, their composition is also similar to that encountered in Sweden.

There is no doubt that polyvalent metal ions such as thorium and lanthanides are actually taken up by the colloids in the groundwater. Accurate analyses of the relative concentrations of lanthanides and uranium isotopes show, however, that these elements have not been transported as particles from the ground surface, but are rather in equilibrium with the groundwater at the depth in question. In summary, it can be said that while it has been clearly demonstrated that colloids with thorium, lanthanides and uranium are formed, they are not transported to any appreciable extent.

8.1.8 Hydrothermal transport

At some time in the past, magma intruded into the uranium mineralization in Osamu Utsumi and caused a local heating, which in turn induced water flow and hydrothermal conditions. This process, which lasted for 20 000 years, led to a redistribution of uranium in the rock around the intrusion. The minerals have been analyzed and their impact on the rock has been studied in simulated laboratory tests.

The convection flow of groundwater and the cooling-off were calculated with a coupled model. It was found that the flow has been concentrated to the permeable breccia to which the intrusion has given rise. No less than 100 tonnes of hydrothermal solution has passed per cm² in the breccia.

The hydrothermal circulation has brought about a uranium concentration of 50 mg/kg in the rock. The temperature has been about 300°C. The transport of uranium in the rock could not be explained with literature data on uranium solubility. Good values were apparently lacking. Different determinations made at 330°C can, although they come from studies in the late '80s, differ by as much as 5 powers of ten in solubility! The impact of the hydrothermal circulation on uranium solubility had to be estimated instead from observations in the field. After calibration against the observations in Poços de Caldas and against laboratory tests, the hydrothermal transport model was applied to a hypothetical American repository. The maximum temperature in the repository was 200°C. The calculations showed that the hydrothermal changes would only be 0.1% of that observed in the uranium mine. The main reason for the relatively insignificant effect in a final repository is the much lower hydraulic conductivity in the surrounding rock. As a consequence of this, the circulation is more diffuse and not as concentrated as in Poços de Caldas.

8.2 THE CIGAR LAKE PROJECT

SKB is participating together with AECL and US DOE in a project to investigate the Cigar Lake mineralization as a natural analogue of a deep repository for spent fuel. The project is being managed by AECL, under the supervision of CLMC. SKB joined the project in April 1989 with the intention of participating for at least three years. That phase was concluded in April 1992. So far two annual reports have been published summarizing the results to date /8-30 and 8-31/.

The investigation programme is divided into the following parts:

- Rock mineralogy and chemistry.
- Uranium ore and nuclear reaction products.
- Hydrogeology.
- Hydrogeochemistry.
- Colloids.
- Organic geochemistry and microbiology.
- Radiolysis.
- Modelling.

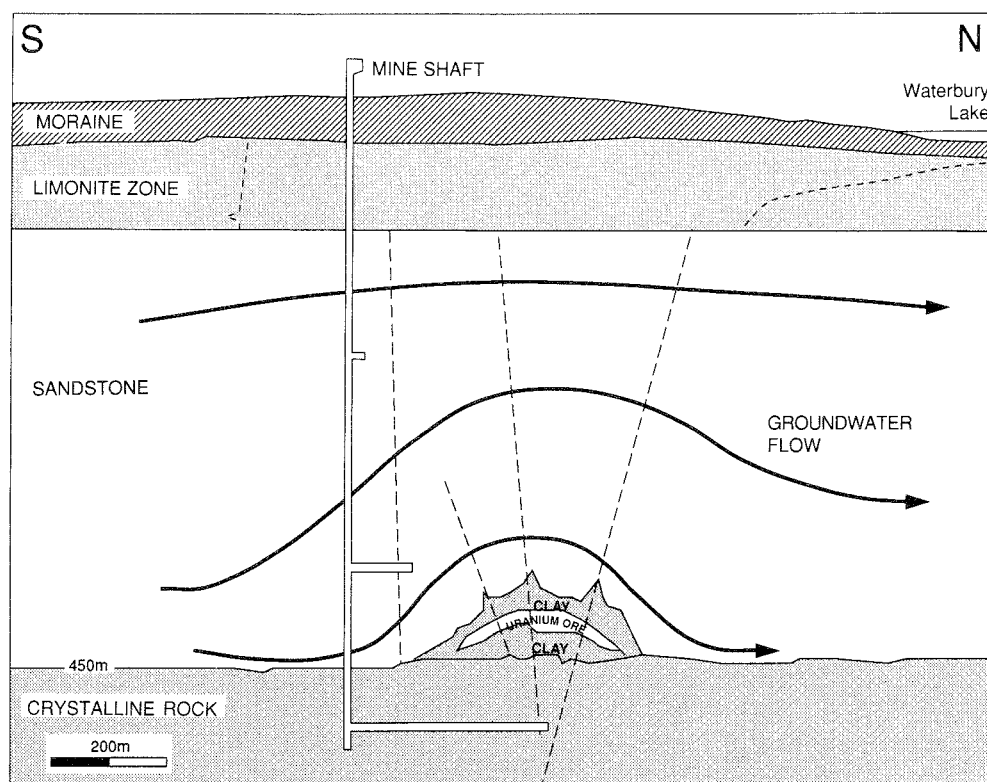

Figure 8-9. Profile across the orebody at Cigar Lake.

The uranium ore at Cigar Lake in northern Saskatchewan, Canada, is situated at a depth of 430 m, see Figure 8-9. The orebody is 2 km long, 25–100 m wide and 1–20 m deep. It is surrounded by a 5–30 m thick layer of illitic clay. The ore is situated on an old fracture zone in the underlying crystalline basement. The overlying rock consists of sandstone which is hydrothermally affected in the area around the orebody. It is an unusually concentrated mineralization. The average uranium concentration is 12% and concentrations above 55% occur.

The uranium ore and the surrounding clay were formed 1.3 billion years ago. It has been well isolated since then. There are no signs on the ground surface to indicate the presence of a large orebody beneath the sandstone.

A large exploratory borehole has been drilled. The Cigar Lake Mining Company, CLMC, has also sunk a shaft down to the ore.

Cigar Lake has not had any natural criticality such as occurred in Oklo in Africa. The nuclear reactions mentioned in the second point of the above investigation programme pertain to the production of isotopes due to spontaneous neutrons from uranium. This gives rise to ^3H , ^{14}C , ^{36}Cl , ^{99}Tc , ^{129}I and ^{239}Pu in measurable quantities. Thus, for example, the concentrations of tritium are often higher around the ore than in superficial groundwaters, see Figure 8-10. The tritium found near the ground surface comes from atmospheric nuclear weapons testing. The tritium found near the ore must have been formed there.

The radiolysis investigations are associated with the redox front observed in the clay around the ore. The oxidation of iron compounds in the clay may be caused by radiolysis.

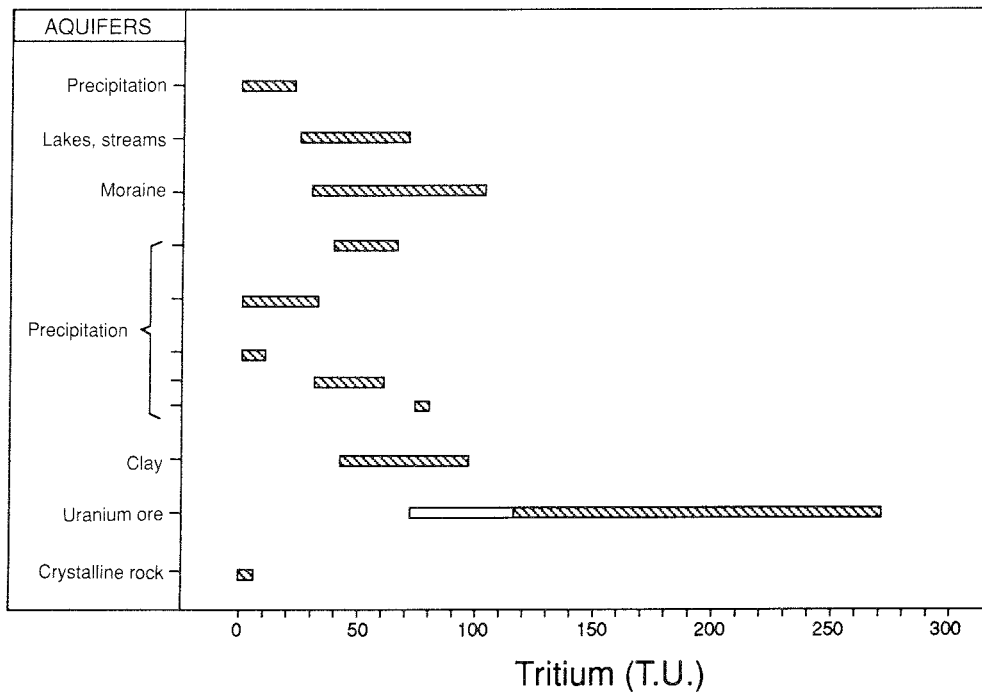

Figure 8-10. Tritium in groundwater from Cigar Lake.

The model calculations include both solubility of radionuclides and transport. The following types of models are being tested on measurement results from the investigations at Cigar lake:

- Geochemical models for solubility and speciation of trace elements, radionuclides and nuclear reaction products in the uranium ore.
- Models for radiolysis and fuel dissolution.
- Models for mass transport in the near field and the far field.
- Models for influence of colloids, natural organic substances and microbes on geochemistry and radionuclide migration.

The modelling work has been intensified as the conclusion of the ongoing phase of the project approaches.

8.3 THE OKLO PROJECT

The natural reactors at Oklo in Gabon, Africa, are being investigated as natural analogues of deep disposal of high-level waste. The project is being managed by CEA, France, with funding from CEC. The project is open to international participation, and besides SKB, organizations and institutions from Japan, the USA and Canada are also participating.

A number of reactor zones have been found in the uranium ore in the Oklo mine, see Figure 8-11, and in the adjacent Okelobondo. Oklo has an open-pit mine. Mining is continuing underground in Okelobondo. A typical reactor zone is several metres in diameter and several decimetres thick. Criticality started two billion years ago and lasted for around a hundred thousand years. The concentration of the uranium isotope ^{235}U was then nearly 3.7%, i.e. much higher than today /8-32/.



Figure 8-11. One of the reactor zones at Oklo.

During prospecting for new uranium deposits, a reactor zone was discovered in Bagombe, which is located about twenty kilometres from Oklo. This reactor zone is situated near the ground surface (10-30 m down) and is undisturbed, since it was encountered in a borehole. No mining operations have yet been conducted there. SKB participated in a reconnaissance study of the Bagombe reactor in 1991. It has now been decided to include a study of Bagombe in the Oklo project. So far SKB has also participated in sampling and analysis of water and minerals, as well as hydrogeological investigations.

8.4 MISCELLANEOUS

Besides the major projects described above, SKB is also participating in a number of smaller studies. Uranium ore in granite is being investigated at Palmottu in Finland. SKB is following this work as an observer.

The Alligator Rivers Analogue Project, ARAP, in Australia is a part of a study in the INTRAVAL project. SKB is following this work through its participation in INTRAVAL.

In Maqarin in Jordan, a hyperalkaline groundwater (pH 12.5) has been found that resembles concrete pore water in a number of respects, see Figure 8-12. Portlandite, $\text{Ca}(\text{OH})_2$, occurs naturally in Maqarin. It has been formed by combustion of bitumen

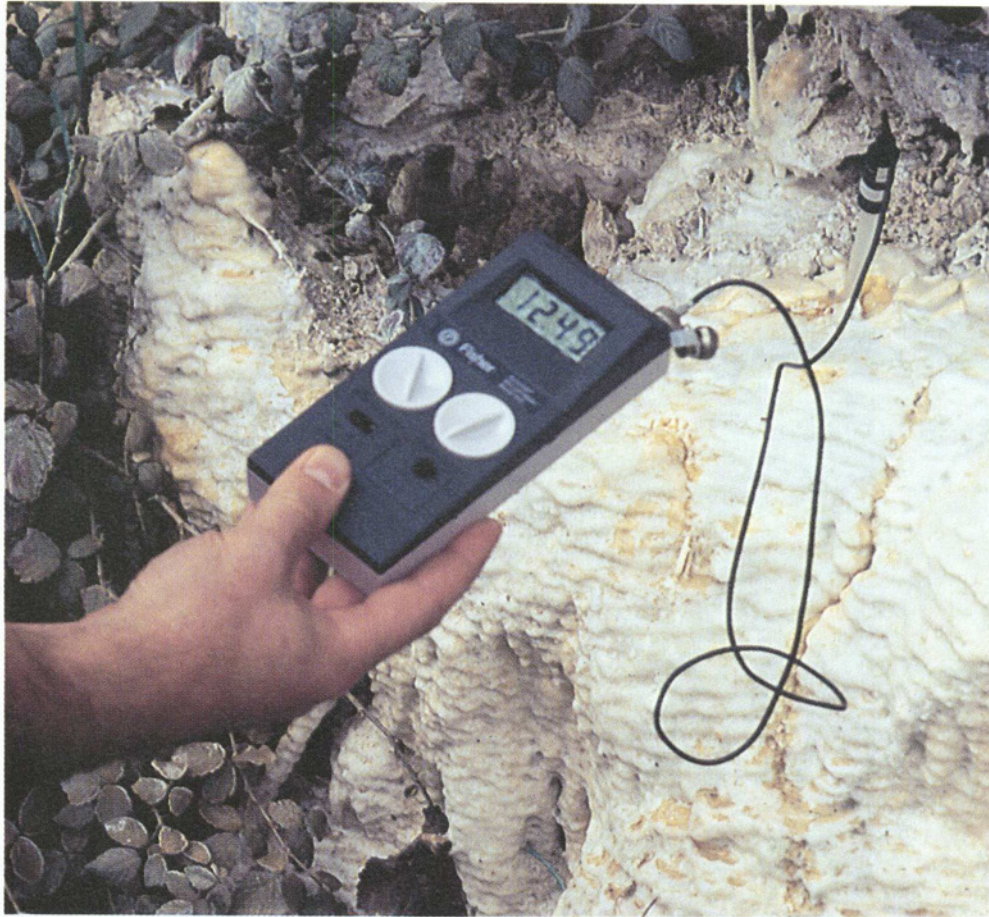

Figure 8-12. Measurement of pH in the hyperalkaline groundwater at Maqarin.

in the lime-containing marlstone. The autoignitions are caused by oxidation of pyrite in the presence of air. Together with NAGRA and NIREX, SKB is investigating the hyperalkaline groundwater and the minerals in Maqarin as an analogue of the use of concrete in a final repository. The properties and phenomena being studied include solubility and speciation of radionuclides at high pH /8-33/, stability of bitumen at high pH and formation and stability of mineral phases in concrete.

9 METHODS AND INSTRUMENTS

9.1 GOALS OF THE ACTIVITIES

By “methods and instruments” is meant in this chapter measurement methods for collection of geological, geohydrological, geophysical, geochemical and rock-mechanics data for characterization of a rock volume, as well as measurement instruments used for this data collection.

The main goal of Methods and Instruments is to ensure that suitable measurement methods and equipment are available in order to be able to collect, with high standards of quality and accuracy, the data required to characterize the rock volume(s) that will be investigated for the purpose of constructing SKB’s deep repository for long-lived radioactive waste. The purpose of the investigations is to describe the structure and properties of the rock, and to obtain data as a basis for assessment of the performance and safety of the deep repository and for constructability analysis and design/planning.

A subsidiary goal of Methods and Instruments is to see to it that suitable methods and equipment are available for SKB’s geoscientific research and for the investigations at the Äspö Hard Rock Laboratory.

Another subsidiary goal is to see to it that measurement methods and instruments/equipment are so well-documented with regard to technical design and use that a relevant assessment of the quality of the measurement data can be made.

To achieve these goals, existing measurement technology will be critically examined and improved or augmented where necessary, and new technology will be developed. While a large part of this method development takes place within the framework of other geoscientific activities, e.g. the Äspö Hard Rock Laboratory, instrument development is usually conducted in the form of special development projects.

9.2 PRESENT-DAY STATE OF KNOWLEDGE

Knowledge of the properties of the rock at the depths being considered for a deep repository for long-lived radioactive waste, 500 m or deeper, and of investigation technology for determining these properties is largely the result of the extensive geoscientific research activities conducted by SKB. Ever since 1977, SKB has been developing field investigation methods and equipment/instruments aimed at being able to conduct field measurements in a correct and rational manner with high quality of data. A detailed account of these field investigations was provided in the chapter on method and instrument development in SKB’s R&D-Programme 89 /9-1/.

Inasmuch as the geoscientific field research in recent years has mainly been concentrated to the Äspö Hard Rock Laboratory, experience from new and modified investigation technology has mainly been obtained when such new technology has been tried or used within the Äspö Hard Rock Laboratory. A relatively detailed account of the investigation logistics and all the measurement methods and instruments used during the pre-investigation phase of the Äspö Hard Rock Laboratory has been collected in a project report /9-2/.

The second and current phase of the Äspö Hard Rock Laboratory, the construction phase, comprises documentation work and other measurements from the tunnel, as

well as long-term observations of the groundwater situation, hydraulic and chemical, for the purpose of validating the models and predictions made of the Äspö rock volume, based on the pre-investigations.

The results of the validation of the predictions made will serve as a basis for “verifying pre-investigation methods, i.e. demonstrating that investigations on the ground surface and in boreholes provide sufficient data on essential safety-related properties of the rock at repository level” (stage goal 1 for the Äspö Hard Rock Laboratory) /9-3/.

The activities during the Äspö Hard Rock Laboratory’s construction phase and subsequent operating phase shall serve to “finalize detailed characterization methodology, i.e. refine and verify the methods and the technology needed for characterization of the rock in the detailed site characterization” (stage goal 2 for the Äspö Hard Rock Laboratory).

For documentation, measurements and long-term observations during the construction phase, it has largely been necessary to use other technology than that used during the pre-investigation phase, partly because a different type of measurement data is required and partly because much of the data are collected from tunnels. The work in tunnels also entails special requirements on coordination with the tunnelling work. These types of investigations during the construction phase have been going on for nearly 2 years, during which time both new measurement methods and new measurement instruments have been developed or modified and experience has been gained from their use. Due to the fact that the validation work is carried out in stages and no such stage has yet been concluded, with the exception of a limited exercise regarding parts of the access tunnel, it has not yet been possible to verify any pre-investigations methods.

Since the account of the state of knowledge within this field of technology was so thorough in the 1989 research programme, the description in this section is limited to what, during the intervening years, can be considered to have advanced the state of knowledge, or is worth noting for any other reason. This supplementary description is organized primarily under the same headings as R&D-Programme 89.

9.2.1 Measurement methods and instruments for investigations from the ground surface

Ground measurements have been performed in a limited scope during the past three years. On the other hand, the state of knowledge is already considered to be good regarding this type of measurement technology, with the exception of reflection seismics.

The use of seismic measurement methods for characterization of crystalline rock is still limited, with the exception of refraction seismics, which is widely used for superficial investigations. The reason is presumably that both measurement and interpretation techniques have been developed for sedimentary rock formations, whose stratified structures differ in all essential respects from the fracture structures in the crystalline rock.

SKB has tried reflection seismics on a couple of occasions to detect, by means of ground measurements, horizontal or subhorizontal fracture zones, which are practically impossible to detect by means of other methods. Both dynamite and vibrators have been used as a signal source on these occasions, but no satisfactory results have been obtained so far. The need for improved technology remains, since it is a great

advantage to have knowledge of horizontal zones before a resource-demanding drilling programme is begun.

9.2.2 Measurement methods and instruments for investigations in boreholes from the ground surface

Drilling

It is important that drilling be done in such a manner that it creates the right conditions for later being able to conduct borehole surveys of good quality, at the same time as data collection during the actual drilling process is often of great value as well. As was described in the previous research programme, SKB normally carries out core drilling nowadays using the telescope-type drilling technique, which means that contamination of the rock formation's fractures and groundwater by drill cuttings and drilling water is greatly reduced /9-2/.

Another principle for raising drilling water and drill cuttings to the surface is the use of reverse circulation drilling. It can be done either with or without a supply of water from the surface, but in both cases the mixture of cuttings and water is transported up inside the drill pipe, without contact with the borehole wall. SKB has developed the technology for use in core drilling without a supply of water from the surface. Formation water alone is used as flushing water. It is pumped up through the drill pipe by means of the airlift pumping method. The drilling technique, which has so far been used for 200 m drilling to a depth of 300 m, has the limitation that it is dependent on water-bearing fractures being penetrated at intervals of 50–70 m if the drilling capacity is to be comparable to that of conventional core drilling /9-3/. Insofar as no flushing water is added and no drill cuttings come into contact with the borehole wall, the method is unique in that it keeps contamination to an absolute minimum. This can be of interest in particular contexts when special requirements are made on water samples. One advantage in this context is that the method can be used under delimited borehole sections in conjunction with conventional core drilling.

When drilling through large fracture zones, it is often difficult to keep the boreholes stable for the subsequent measurements in the borehole. As long as the drilling machine is in position, the hole can always be cleaned, but after that instability poses a great risk that expensive measurement equipment will get stuck or that it will not be possible to complete measurements through and below the zone. Stabilizing grouting of the zone is a possibility, but is usually inappropriate as it makes hydraulic tests and water sampling impossible. A method for non-disturbing stabilization would be desirable here.

Mapping of drill core and borehole

Mapping of the drill core is done with the quality that is desirable for SKB's purposes. Recently the interpretation of the results of core mapping has been developed by integrating the processing of geophysical borehole data in this process.

Regarding determination of fracture orientation, it is not necessary to orient all fractures in a site investigation. It is sufficient to give absolute orientations to the fractures in a couple of strategically selected boreholes. This is usually done by combining core mapping with observations of the borehole wall. Borehole TV and acoustic televiewer are useful methods for this purpose. Recently SKB has developed a borehole TV that can be used down to a depth of 1000 m. However, more efficient image processing is needed in order to make fracture interpretation with the aid of borehole TV a standard method.

Exact determination of the borehole's position along its entire length, and determination of the exact position of different measurements in the boreholes, is necessary in order to be able to compare different measurements, to co-interpret data by means of e.g. multivariate analysis, and to provide accurate background data for detailed design of an underground facility. Improved accuracy within this area is desirable.

Geophysical measurements in boreholes

As far as geophysical borehole logging is concerned, methods are available that have been found to be suitable for SKB's site investigations /9-2/. Both instruments and processing and evaluation technology have been improved. Among other things, result plots can be obtained directly after the measurement.

Regarding the radar technique as a rock investigation method, it can be noted that its use has been considerably improved by the development of directional antennas /9-5/. Direction and distance to a detected structure can now be determined from measurements in only one borehole. Special antennas for measurements from the ground surface or in tunnels have also been developed. The special requirement for these antennas is to obtain a good signal coupling with the rock.

The unique ability of radar to "see" far out into the rock is, however, limited in rock with low resistivity, for example where the groundwater has high salinity. But even under conditions unfavourable for radar, it is the only method able to map structures in the rock in the relative vicinity of the borehole. The combination of flow meter logging and radar measurement with directional antennas offers a good means for determining the three-dimensional extent of water-bearing fractures.

The use of seismic borehole methods such as Vertical Seismic Profiling (VSP) and cross-hole seismics in crystalline rock has come much further, thanks to improvements made within the Stripa project and the work within the Finnish nuclear waste programme /9-6 and 9-7, respectively/. VSP measurements have been performed on one occasion within the Äspö project and the method is judged to be useful for large-scale mapping of fracture zones, including the previously mentioned horizontal zones, during the subsequent drilling phase of a site investigation. However, further experience is needed in order to be able to verify the applicability of the method.

Geohydrological measurements in boreholes

Numerous hydraulic measurements are performed to determine hydrological parameters and map the geometry of hydraulic structures during different phases of an investigation programme and for characterization on different scales /9-8/. The methods used – tests during drilling, test and cleanout pumping, flow meter logging, injection tests and transient interference tests – are well-proven and are described in SKB's previous research programme and in greater detail in the Äspö project's method report /9-1 and 9-2, respectively/.

Measurement of groundwater pressures or groundwater levels is usually done in several sections of a borehole, separated by packers, the purpose being to measure natural conditions and responses to pumpings or other disturbances. Groundwater pressure measurements are performed as long-term recordings, which has led SKB to develop technology that simultaneously permits other borehole measurements as well: water sampling, dilution measurements and tracer tests /9-2, 9-9/. Dilution measurements in this type of multi-packed borehole have been used to determine the natural groundwater flow as well as changes in the groundwater flow (if any) during pumping tests. Changes in the salinity of the groundwater are checked by means of installed conductivity sensors and by means of water samples.

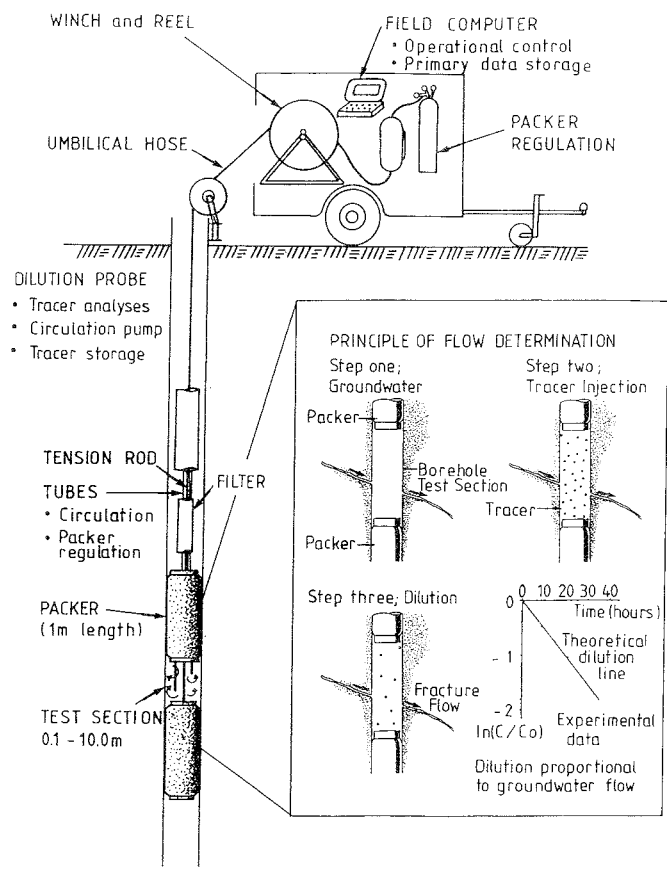

Figure 9-1. Measurement of groundwater flow using dilution method: measuring principle and measuring equipment used.

Measurements of very low groundwater flows require a special item of equipment, called a point dilution probe, with which the active test volume must be kept limited, see Figure 9-1. A point new dilution probe for 56 mm boreholes and depths of at least 1000 m is now ready following the completion of further development work.

Large-scale tracer tests have been carried out both within the Finnsjön project and the Äspö project, while tracer tests on a smaller scale have been performed within the Stripa project /9-9, 9-10, 9-11/. Within the Äspö project, radioactive, short-lived radionuclides were used in a radially convergent tracer test with injection from multi-packed borehole sections and detection of inflow levels in the pumping hole. Tracer tests with non-sorbing tracers provide information on flow porosity, while suitable field technology for determination of the flow-wetted surface area (an essential parameter for calculating the sorption of radionuclides) is not available. Tracer tests with sorbing nuclides are usually far too time-consuming for realistic field tests to be carried out, so laboratory tests are the main source of this information.

Injection of salt has been used in Stripa, in combination with radar measurements, to determine transport pathways in the rock volume /9-2/.

Hydrochemical measurements in boreholes

Methods for determining the chemistry of groundwater are also described in the previous research programme and in the Äspö project's method report /9-1 and 9-2, respectively/. The equipment belonging to SKB's mobile field laboratory has recently

undergone improvement of the pump and chemical probe. As far as the chemical probe is concerned, the probe computer and software have been replaced and a new electric-powered pump provides simpler technology and greater pump capacity than with the previous hydraulic-powered pump. Development of a new umbilical hose and surface equipment is currently under way.

Rock stress measurements

Like three years ago, there are two methods for rock stress measurements in deep boreholes, the overcoring method and hydraulic fracturing. While the former allows an absolute determination of the stress state in three dimensions, but is complicated to carry out, the second method is based on the assumption that the direction of the principal stress is parallel to the borehole (which is usually the case in stable bedrock areas with relatively flat topography), at the same time as these measurements can be performed in a more efficient manner. The methods can suitably be combined in an investigation programme, such as was the case in the Äspö project's pre-investigation phase, where several overcoring measurements were performed in a borehole (down to 450 m), supplemented by 38 determinations using the hydraulic fracturing method (down to 970 m) /9-2/.

9.2.3 Measurement methods and instruments for investigations from tunnels and shafts

Since the late autumn of 1990, with the underground construction of the Äspö Hard Rock Laboratory, most of SKB's geodata collection has come from investigations in tunnels /9-3/. The primary goal of the data collection to date is to serve as a basis for validation of the predictions which, based on the pre-investigations, preceded the project's construction phase. Since the tunnel construction is a large and resource-demanding undertaking, the main endeavour has been that all base investigations shall be carried out in accordance with a standard schedule for each tunnelling cycle, governing both construction and investigation. Only in the case of special investigations should it be necessary to interrupt the tunnelling work. So far more than 1.5 km of tunnel has been driven, and experience to date of this coordination of construction and investigation has been positive.

The methodology that has been tried out and is being used for the documentation work and other investigations from the tunnel is described in brief below. In particular as regards investigations in boreholes from the tunnel, the same – or a slightly modified – technology is used in many cases as for investigations in boreholes from the ground surface.

Technology for base documentation

By "base documentation" is meant here mapping and measurement of the tunnel wall or in regularly recurring probe boreholes /9-13/. Tunnel mapping is done immediately after each blasting round has been mucked out. Tunnel walls, tunnel roof and tunnel front are hereby mapped with respect to rock types, fractures and structures as well as water seepage. The mapping is done manually on drawings plotted from a 2-D CAD system. Immediately afterwards, the mapping is digitized and transferred to the CAD system. There is a need to streamline the mapping and digitization process, and the various options available are currently being examined.

Probe drilling is performed every 20 metres, with 20 m long holes directed slightly outward and upward. During this probe drilling, manual observations are made of drilling rate and the colour of the cuttings. Some kind of system for recording of drilling-related parameters will eventually be devised here.

Pressure build-up tests are performed in the probe holes in sections from 6 m to the bottom of the hole. Mechanically operated packers have been developed for this purpose, capable of sealing off both large water flows and high water pressures. Pressure transducers and dataloggers for data recording are connected to the packers. Data processing is then done by the Hydro Monitoring System, HMS, which is described below. The pressure picture in the probe holes is recorded during a given period of time, and some holes are selected to be included in the observation programme.

The results from the base documentation are reported for every 150 m tunnel section in the form of informative diagrams that serve as a basis for validation of the predictions made /9-14/.

Observation programme

The predictions also include how the groundwater situation around the tunnel will change, with regard to pressure and chemistry. An observation programme has therefore been drawn up and technology developed to enable these observations to be handled in an efficient manner. The aforementioned multi-packed boreholes from the ground surface are included in this monitoring programme, which has been gradually expanded by the incorporation of strategic boreholes in the tunnel into the programme as well. The water balance for the tunnel is also being studied by recording water flow in the piping systems into and out of the tunnel, seepage into tunnel sections by means of measuring dykes and moisture transport in and out via the ventilation air. The measuring dykes are designed to trap all water running into the tunnel floor, on and under the roadway, with special reference to obtaining good sealing of the fractured rock, and in road ditches. The water is conducted to a measuring dam, which is equipped with a Thompson weir, an arrangement that permits both manual reading and automatic pressure transducer registration of the water level.

The Hydro Monitoring System (HMS) is based on a computer network for the site office and the tunnel and with on-line radio communication with the dataloggers that record the groundwater pressures in the boreholes from the ground surface, see Figure 9-2 /9-15/. Furthermore, the system is linked to SKB's computer network, which means that the monitoring can be followed on-line not only from the site office but also from SKB's head office and by the consultants engaged for evaluation and analysis. The HMS software was developed to record all changes efficiently without overloading the system with data. Procedures for data security and for function and quality control are built into the system and observation programme. In summary, it can be said that the technology used for long-term observations meets the needs that exist for this type of site description.

Technology for special investigations from tunnels

For measurements or investigations that cannot be regarded as belonging to either the base documentation or the observation programme, the same measurement methods are usually used as for investigations from the ground surface, or variants of these methods. Hence, radar and seismic methods are used in a similar manner as described in previous sections, with the difference that in underground work measurements can sometimes be made directly from the tunnel instead of in special boreholes. The applicability of the methods for predictions of the quality of the rock mass (above all from the constructability point of view) ahead of the tunnel front has not yet been clarified.

Short holes are sometimes drilled for follow-up of observations made on the tunnel wall. These can be inspected with a borehole videoscope, which has proved to be

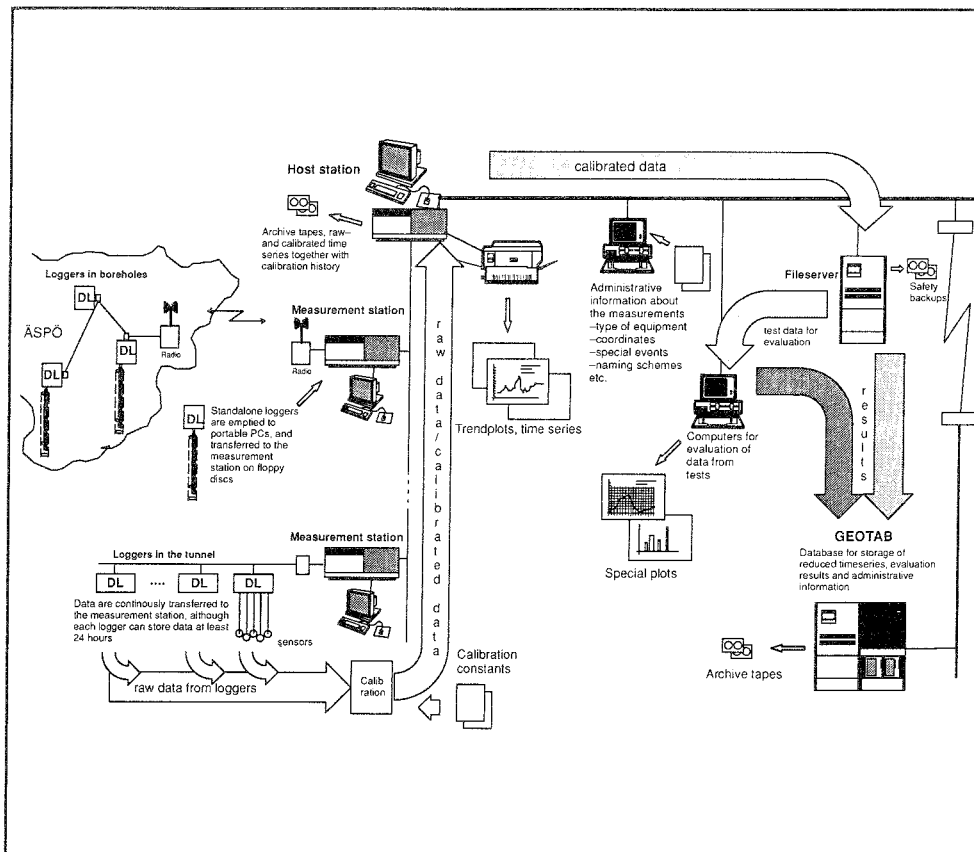

Figure 9-2. HMS system for monitoring of groundwater head around the Äspö laboratory.

excellent in certain contexts, for example in following up the dispersal of grout. Point flows from fractures “channelling” have also been able to be observed with this instrument, which has a range of about 20 m of borehole length.

For hydrological investigations, pressure build-up tests have been performed in packed-off sections of long holes, both during and after drilling. The equipment used resembles the equipment used from the ground surface, the difference being that the downhole equipment must be capable of withstanding much higher differential pressures. Due to the fact that fracture zones with high water flows (>1000 l/min) have been penetrated under high groundwater pressures (about 2000 kPa), it has been necessary to adopt special measures so as not to jeopardize safety in the tunnel. Among other things, the borehole mouths are provided with a form of valve arrangement if it is expected that such water-bearing zones will be penetrated. These technical arrangements should be applicable down to a depth of about 500 m with only minor modifications.

To enable measurements to be performed in strongly water-bearing boreholes, another kind of seal arrangement has been fitted at the borehole mouth. With this arrangement, which constricts rather than stops the water flow, flow meter loggings can for example be carried out in the boreholes.

Water sampling is somewhat simpler to carry out from tunnels than from the ground surface, since water normally flows out of the holes. Recordings of Eh and pH are done with the same flow cells (CHEMMAC) as those used in SKB’s mobile field

laboratories. Such flow cells placed in the Äspö Hard Rock Laboratory's tunnel will be connected to HMS, the monitoring system described above. To get at the more tightly bound water or water from very low-conductivity parts of the rock, special equipment must be developed. This work has been initiated.

Different kinds of experiments are being planned for the Äspö Hard Rock Laboratory's coming experimental phase. One group of experiments has to do with radionuclide dissolution in groundwater, and sorption and diffusion properties on mineral surfaces in the rock and in the backfill material. In the Äspö Hard Rock Laboratory these experiments are intended to be performed in-situ, in boreholes, which is considered necessary in order to be able to simulate natural conditions, among other things with regard to groundwater composition and retention of reducing conditions. For this purpose the development of a special borehole probe, CHEMLAB, has been commenced, see further section 9.3.2.

9.3 PROGRAMME 1993–1998

As is evident from the section "Present-day state of knowledge", SKB's long-lasting and in-depth work with field investigations, which has included the development of new instruments and measurement methods as needed, has led to the availability of suitable investigation technology for pre-investigations, with the exception of only a few areas where additional work is required. The Äspö Hard Rock Laboratory's construction phase will yield data that will permit validation of the predictions made on the basis of pre-investigations, enabling the pre-investigation methodology to be verified.

As far as underground surveys – which usually entail more detailed investigations – are concerned, a great deal of experience has also been gathered from SFR, Stripa and Äspö, but here the activities within the Äspö Hard Rock Laboratory during the coming years will also contribute considerable knowledge.

The activities that are planned within the area of methods and instruments for the years 1993–1998 are chiefly associated with site investigations for the Deep Repository and with the Äspö Hard Rock Laboratory. They reflect the gaps or limitations in technology know-how that were noted in section 9.2 above and are presented below in the same order as in section 9.2.

9.3.1 Measurement methods and instruments for investigations from the ground surface and in boreholes from the ground surface

Drilling

As was noted in section 9.2.1, it is often difficult to collect data from crushed zones. Sometimes (albeit seldom) the problem may be of such a magnitude that drilling cannot continue, but usually the problem consists of not being able to lower measurement equipment through the zone, either due to blockage or due to excessively great risks of getting stuck. In an attempt to overcome this problem, stability-improving technology will be studied and possibly tested. The goal is to stabilize the borehole without thereby making the walls of the borehole impervious, and preferably without even altering the hydraulic properties of the borehole.

Starting in the autumn of 1992, SKB will drill an approx. 1500 m deep hole in order to study groundwater chemistry and groundwater flux at this depth. Succeeding in this will probably require larger drilling machines than those that are usually used. It is important that this drilling be rigorously planned, which may entail some modifica-

tion or augmentation of the drilling technology. For the subsequent measurements in this hole as well, it is foreseen that certain modifications will be necessary, among other things in order to withstand the high water pressures.

Mapping of drill core and borehole

Better length readings are needed in order to get a geometrically correct picture of the borehole and the location of measurement points in the borehole. Especially for comparing different measurements or for multivariate analyses, it is essential that the measurement data being processed pertain to the same measurement point. Even with good accuracy of the length measurement in each measurement method, the error can be decisive. For some time SKB has explored different ways of rectifying this deficiency. These efforts will continue. Technology for making marks in the borehole wall and then detecting these marks with each set of measurement equipment for length calibration is one avenue that is being explored.

The borehole TV that has been developed for SKB for 1000 m depth will be further refined by the introduction of improved image processing to make it simpler to determine the orientation of fractures. A new direction meter for the camera probe will also be installed for this purpose (of the same performance as the meters used to determine borehole orientation). This should make it possible to carry out videofilm- ing and borehole orientation in one and the same borehole measurement.

Seismic methods and radar

Seismic methods and radar are, as previously mentioned, to be regarded as the only methods available for remote detection and location, from the ground surface or from a borehole, of fracture zones or other essential structures. The methods have slightly different applicability with respect to rock conditions. Thus, radar has a limited range in a low-resistivity environment, such as saline groundwater, while it is better able than seismic methods to indicate the directions of structures in detail.

Horizontal or subhorizontal fracture zones are of great importance for the ground- water flux around a deep repository /9-16/. It is therefore essential to be able to detect and locate such zones correctly, and it is especially advantageous that this be done at an early stage during the pre-investigations. The seismic methods reflection seismics and VSP – from the ground surface and from boreholes, respectively – are hereby potential methods that have been tried and will be tried further. For shallower depths in the rock, ground radar is a method that is potentially useful for this purpose.

Geohydrological measurements

As far as the hydraulic testing equipment is concerned – the mobile umbilical hose system and the pipe string equipment – high availability will be maintained by replacing old computer systems with new, modern measurement computers and software.

Hydrochemical measurements in boreholes

As mentioned in section 9.2.2, SKB's mobile field laboratory has been equipped with a new pump and a new chemical probe. At present the development of a new umbilical hose and surface equipment is under way, which together make the equip- ment more flexible and easy to handle.

9.3.2 Measurement methods and instruments for investigations from tunnels and shafts

Report on measurement methodology

As was done for measurement methodology and instruments used during the Äspö Hard Rock Laboratory's pre-investigations, a report concerning methodology and instruments for measurements and documentation work used underground will be compiled during 1993.

Technology for base documentation

As the base documentation of the Äspö tunnel proceeds in parallel with the excavation of the tunnel, the technology used for this documentation will be further refined and improved where necessary. Foreseen improvements include rationalization of tunnel mapping and digitization of mapping information for the CAD system. The feasibility of using plotting computers for mapping and/or using a total station (for direct position measurement of fractures etc.) or a bar code system is being explored.

A system for recording of drilling-related parameters will be developed for probe drilling. Correctly utilized, such information can be used for detection of zones and water-bearing fractures. In core drilling as well, such parameters can provide supplementary information. SKB is also following other investigations and tests within this area, including those being carried out under BeFo's auspices.

Observation system

Long-term observations of the groundwater are essential for both site characterization and recording of long-term changes, under both natural and disturbed conditions. Within the framework of the Äspö Hard Rock Laboratory, technology has been developed and tested that is both flexible and useful for different types of measurements, see section 9.2.2. The technology has been gradually enhanced to suit the different phases of the Äspö Hard Rock Laboratory so that an unbroken observation programme has been able to be sustained, except during periods when other activities have been carried out in the boreholes. The system is being expanded as new measurement points are incorporated in the observation programme and modified or revised as needed.

Technology for special investigations in tunnels

During the continuation of the Äspö Hard Rock Laboratory, tunnelling from the 330 m level, certain studies will be focused on describing the rock in detail and predicting and locating suitable volumes for different experiments or with different properties. It is hereby foreseen that studies will be made of how radar and seismic methods, as remote characterization methods, can best be used – for example, to predict the character of the rock ahead of the tunnel front, which is important with respect to constructability.

The sealing, or rather flow-constricting, arrangements utilized for flow meter logging in strongly water-bearing boreholes underground and at high pressures should be improved so that they can also handle conditions at a depth of 500 m.

Chemistry equipment

The water that is strongly bound in the small pores in the rock has such low mobility that it is judged to be more or less stagnant. Sampling is therefore complicated and time-consuming, but is considered very important in contributing towards obtaining a complete picture of the chemistry of the groundwater and will therefore be carried out within the Äspö Hard Rock Laboratory. High demands are made here on, among

other things, material properties so that the water samples will not be contaminated. Equipment for this purpose is in the process of being developed. It contains a packer system and a special type of flow cell for recording of Eh and pH.

CHEMLAB probe

As was noted in section 9.2.3, a group of experiments is being planned for the purpose of studying radionuclide dissolution in groundwater, and sorption and diffusion properties on mineral surfaces in the rock and in the backfill material. In order to be able to simulate natural conditions, for example as regards groundwater composition and reducing conditions, these experiments will be performed in-situ in the Äspö Hard Rock Laboratory.

The planning of these experiments includes development of a special borehole probe, CHEMLAB. It is being designed for use in 50–100 m long holes, drilled from suitable parts of the laboratory. The CHEMLAB probe will be a complex piece of equipment consisting of several interconnected probes, where, for example, migration tests will be conducted on real rock samples and with surrounding groundwater. An essential part of the development of this probe is selecting suitable materials to avoid sorption in the equipment itself. The highly resistant plastic product PEEK will be used in valves, chromatography pumps, tubes etc. The probe will also contain solution tanks, columns and fraction collectors. Since radioactive isotopes are also intended to be used in certain experiments, the probe is being designed so that handling aspects will not cause any problems from a radiological viewpoint.

CEA, France, has been contracted for the development of the CHEMLAB probe. CEA has extensive experience of similar borehole equipment, such as FORALAB. For the experiments in the Äspö Hard Rock Laboratory, SKB's CHEMMAC probe will be integrated with CHEMLAB for measurement of Eh and pH.

Other experiments

Special measurement technology and equipment for other experiments in the next phase of the Äspö project will also be needed. These needs will be clarified in connection with the planning of these experiments and can therefore not be specified here /9-3/.

10 BIOSPHERE STUDIES

10.1 GENERAL

The biosphere studies cover the chain of events from radionuclide transport in groundwater out of the rock to impact on man or other organisms. The goal of these studies is to be able to describe the consequences of a possible release of radioactive nuclides from a final repository.

The purpose of final disposal is to isolate the radioactive waste from the biosphere for such a long period of time that its radioactivity declines to a harmless level. If, however, the isolating barriers are for one reason or another disabled, radioactive materials can reach the biosphere sooner. In order to be able to assess the consequences of such abnormal eventualities, knowledge is needed of how radionuclides are dispersed in the biosphere, to what extent they are taken up in the human body, to what radiation dose they give rise and, finally, what effect this dose has. The length of time from deposition to breakthrough into the near field is estimated in the normal case with intact engineered barriers to be on the order of millions of years. In cases where the engineered barriers are for some reason disabled, the time to breakthrough can be on the order of thousands of years (hundreds in the most pessimistic scenarios). Added to this is the delay in the near and far field, so that only those radionuclides that have a very long half-life come under consideration for the biosphere analyses.

The biosphere is normally considered to include that part of the world to which man has access. However, this delimitation should not be taken too literally, for example when the dose to other organisms is studied. This includes the following processes and calculation steps of significance for the safety assessment:

- Transport from groundwater in rock to a local ecosystem via different local recipients such as sediment, soil, water etc.
- Transport, dilution, accumulation and deposition in local, regional and global ecosystems.
- Transport to human beings through e.g. production and distribution of food, and
- Uptake in the human body, depending on dietary habits and uptake fractions.
- Calculation of individual doses and collective doses and comparison with natural conditions.

10.2 GOALS

The overriding goal of SKB's studies of the behaviour of radionuclides in the biosphere is to be able to carry out the safety assessment's consequence calculations in a credible manner. Efforts are being concentrated on estimating the consequences of different release scenarios from SFL in a time perspective on the order of 10 000 years. Subsidiary goals in this process are:

- Try to quantify the uncertainties that stem from the fact that the biosphere is constantly changing.
- Improve the data on which the transport models rest.
- Validate the models by means of studies of analogue transport processes.

During the coming 6-year period, these studies will be focused to a high degree on the local conditions on the candidate sites.

10.3 PRESENT-DAY STATE OF KNOWLEDGE

10.3.1 Transport from groundwater in rock to a local ecosystem via different local recipients such as sediment, soil, water etc.

The transport between the groundwater in the rock and the more heterogeneous and biologically active media in the biosphere has been much less investigated than the corresponding transport in the near and far fields. Small differences in parameters can lead to releases in completely different recipients. A series of different physical and chemical processes are of importance for this transport:

- water flux,
- diffusion,
- sorption/desorption,
- advection (gas transport),
- resuspension,
- bioturbation (large and small animals),
- weathering (redox zone acidification),
- precipitation (redox zone),
- ion exchange.

A number of these processes are dependent on site-specific conditions such as:

- chemical and physical groundwater composition,
- redox conditions,
- soil and sediment properties in the discharge areas,
- hydraulic conditions.

Uncertainty is therefore unavoidably high in attempts to model this transport, especially if the properties of the site are not known.

Wells

Rock-drilled wells are a critical transport pathway from deep groundwater directly to environments in the vicinity of man. A well is sometimes regarded as a case of intrusion, but since wells are so common they can also be regarded as a result of normal human behaviour. Certain studies of the properties of wells have been made /10-1/ but difficulties remain in modelling their importance, since factors such as dilution, capacity, pattern of use and the total well lifetime vary within such wide limits.

Transport through sediment and soil

On their way to the surface, the groundwater and accompanying radionuclides will leave the reducing environment in the rock and pass into an oxidizing environment. For most of the chemical compounds in question, this transition is associated with a drastic change of solubility as well as a change of chemical form. The transition often takes place in sediment or soil, but can also take place directly in free water. In the box models used previously, these processes have been treated as a distribution transport, controlled by water flows and K_d values, and have been approximated with a number of transfer coefficients, based on K_d values. These K_d values vary widely depending on the type of soil/sediment. Furthermore, these parameters are of great importance for the outcome of the modellings. Some studies /10-2, 3/, however, show that further studies of this geosphere/biosphere interface are warranted.

A detailed investigation of discharge in lakes entitled "Nuclide transport in discharge areas" was initiated in 1987. In this study, sampling was performed in two lakes,

Hillesjön and Långhalsen in Södermanland, to examine how the chemistry and fauna of the bottom sediments in discharge areas differ from the rest of the bottom sediments. The project was concluded in 1991 /10-4/ with the main conclusion that the modellings that have been made of discharge areas have been correct on the relatively rough level of detail that has been used.

10.3.2 Transport, dilution, accumulation and deposition in local, regional and global ecological systems

Previous calculations have been carried out with available data on today's ecological systems. Similar models have been used for prediction and follow-up of the fallout from the Chernobyl accident, where it turned out that our knowledge of enrichment and transport was unexpectedly poor. The accuracy of predictions thousands of years ahead in time is naturally poor, even though margins of error of a factor of 100 are accepted /10-5/. Qualitative validation of models used for these time perspectives is impossible, since the scenario changes with time in an unknown fashion.

Potential concentration effects

Normally, transport in the ecosystems entails a large dilution of nuclides. Some enrichment occurs, but in most cases the cycle time is short, i.e. the enrichment ceases after a year or so and is not significant if a ten-year period is studied. Enrichment in biota (shrimp-perch-pike) is taken into account in the transfer factors used. A few rather special cases may lead to concentration of radionuclides over a longer period of time (a thousand years), after which they can be released during a relatively short period (ten years) and give rise to relatively high concentrations. A naturally occurring example of this is the accumulation of transuranics at the bottom of peat bogs /10-6/, which can result in high concentrations being released when the peat is cut. Combustion can also give rise to high concentrations in wood ash /10-7/ and in ash from peat combustion /10-8/.

Evolution of the biosphere

Any activity release from a final repository will probably take place so far ahead in time and over such a long span of time that considerable changes can be expected to occur in the properties of the biosphere before and during the release process. This means that analyses of the consequences of a release will entail large uncertainties.

The greatest uncertainty factor in the biosphere is associated with the natural evolution of the ecosystems during the periods of time considered realistic /10-9/. Examples of processes in a shorter time perspective are:

- eutrophication of lakes and cultivation of the old sediments (also due to post-glacial land uplift),
- erosion of soils by wind and water,
- disturbance of sediment layering in lakes and waterways.

In a slightly longer perspective, climatic changes and glaciation must also be included in the picture. The biosphere then undergoes a very radical change and can re-emerge in a large number of ways. The question can then be asked how meaningful it is to make dose estimates. Geological studies are nevertheless being carried out and can provide a qualitative picture.

Mankind exploits the ecosystems for purposes such as food production and manipulates these systems to increase their yield. This can also be said to constitute a kind of evolution. Today's situation exhibits a large number of examples of this kind of anthropogenic environmental change /10-10/. This impact can be of great importance

for the consequences of a postulated release, especially if such phenomena as urbanization, large-scale hydroponics, dam construction or the greenhouse effect are included in the picture /10-11/. An inventory of reasonable events of this nature has been discussed in connection with SKB/SKI's joint scenario definition work /10-12/.

SKB has studied the process whereby the bottom sediment of the lakes is gradually transformed into farmland. A collection and processing of data for Lake Trobbofjärden in Södermanland has been carried out /10-13, 14, 15/ covering water flow, sedimentation rate, interstitial water characteristics, water quality during different phases etc. Modelling and variation analysis /10-16, 17/ showed that the individual doses for certain nuclides increased by several orders of magnitude when the lake sediment was used as farmland. For other nuclides, the doses decreased by a power of ten or so. The greatest source of uncertainty is the rate of exchange in the lake's water and sediments. However, this scenario gives lower doses than when a well is assumed to be drilled into the waste disposal area.

10.3.3 Studies of Chernobyl fallout

In 1986, in response to the Chernobyl accident, studies were initiated of the fallout in the SKB study sites of Gideå and Finnsjön. Since the end of 1991, all field work has been concluded and the activities are being focused on summarizing and evaluation. The project includes a sampling and measurement programme, studies of migration in soil profiles, sorption on and migration in rock, water-transported activity and modelling of the turnover and transport of nuclides. The goal of the sampling and measurement programme is to be able to make use of the migration of the nuclides in the fallout for verification and validation of models that describe turnover in the biosphere and geosphere. For the ground migration studies, the goal is to describe the transport and retardation mechanisms for different nuclides in different soils so that models for this transport can be refined and to derive benefit from the site-specific data that exist /10-21, 22/. The purpose of the modelling is to describe the migration of the different nuclides in superficial parts of the geosphere, including groundwater, rock, soil and biomass. Measurements of nuclide concentration in artesian boreholes have shown that certain nuclides are transported down to a depth of 100 m in 200-400 days /10-23, 24/, which is both supported /10-25/ and contradicted /10-26/ by previous investigations. The first summaries have been published during 1992 /10-27/ regarding chemical speciation /10-28, 29/ and activity mapping /10-30/.

Binding of actinides on organic matter in soils can be an important factor for the exposure pathway via vegetables, meat and milk. The complexation of e.g. iodine can be of great importance. The importance of the uncertainty in the turnover of the transuranic elements will be evaluated. Experimental studies may have to be carried out.

10.3.4 Transport to man through production and distribution of food

Today's food production system is so complex that even if the concentrations of radionuclides in the raw materials included in the food products are known, the intake to a given individual (with known dietary habits) cannot be calculated with sufficient accuracy /10-31, 32/. The often large (several powers of ten) dilution factor brought entailed in production and distribution is often overlooked in the safety assessment. Instead, a completely self-sufficient farm has been used in order to be able to describe an "unfavourable but not completely impossible or improbable case" /10-33/.

The production methods for food are one of the factors that determine how different parts of the ecosystems will be linked to man's internal environment. An example

from today's situation is the irrigation of farmland /10-34/, the scale of which must be changed within a few hundred years due to accumulation of salts etc. in the soils.

10.3.5 Uptake in the human body depending on dietary habits and uptake fractions

Dietary habits vary between different places and different individuals. This variation is relatively well known and is handled in the modelling /10-33, 35, 36/. However, dietary habits and other living habits may change more radically in the future. This entails an increased uncertainty with time that is difficult to quantify.

Uptake fractions are also relatively well known through work within other fields (nuclear medicine) and international cooperation /10-37, 38/.

10.3.6 Calculation of individual doses and collective doses and comparison with natural conditions

Consequence or impact is dependent on damages and the probability of such damages, a factor which can be summarized as risk. The risk picture for a final repository of high-level waste can then be compared with risk pictures for other phenomena in society. Such a comparison could conceivably be used to allocate the resources available for risk limitation in another (better) way. However, SKB has no plans to make such a comparison, choosing instead to judge consequence based on the acceptance criteria that will be established by SSI and SKI.

Individual dose is one of the acceptance criteria that can be expected to apply to a final repository. As described above, it is difficult to obtain a good picture of the distribution of individual doses; instead, we have to be content with a conservative picture of the unfavourable, not improbable case. The translation from individual dose to risk, in the dose interval in question, will be a translation to stochastic damage (normally cancer), and will always be difficult to quantify, especially for actinides /10-39/.

Collective dose is easier to describe in numbers, but the interpretation of such values is very controversial. It is claimed, for example, that a threshold value does exist somewhere, which is of great importance for the consequences since it is such incredibly small doses that are added up over so many years.

An alternative view of the consequences of the repository is to compare with the concentrations of radioactive nuclides that exist in nature. Certain such sites with very high concentrations have been investigated /10-6/, but a complete analysis of what consequences the elevated concentrations have had is often lacking.

10.3.7 Site-specific study of the Äspö area

At present a site-specific study is being conducted in the area for the Äspö Hard Rock Laboratory. The area will be characterized with respect to the presence of natural radioactivity in superficial waters, groundwater conditions, discharge areas, soil types, land use, biota, population etc. /10-40/. The characterization is expected to be finished during 1993, after which the area can be used for method studies.

10.3.8 Mathematical and conceptual modelling of dispersal in the biosphere

Dispersal in the biosphere is dependent on a large number of processes and changeable base data. The modelling is therefore done with very general compartment

models, coupled to multiplicative models for uptake in biota and dose calculation /10-36/.

SKB has almost exclusively used the program code BIOPATH in combination with the program system PRISM for uncertainty analysis. These codes have been compared with others in the international studies BIOMOVS /10-41/, VAMP /10-42/ and PSAC /10-43/ and found to be reliable.

A truly realistic biosphere model is difficult to achieve. The conceptual models that have been used are saddled with both uncertainty and variation in input data /10-9/. The structure varies with time and can moreover be difficult to predict. By treating several different schematic simple scenarios, we can nevertheless get a good picture of possible outcomes /10-35, 33/.

10.3.9 Other research on the biosphere

Research concerning the dispersal of radionuclides in the biosphere, and with some relevance for final disposal in geological formations, is being conducted at the Swedish University of Agricultural Sciences, the University of Gothenburg, FOA4 and to some extent by Studsvik and Kemakta under contract to SSI and SKI. Other Nordic research centres working in this field are Risö in Denmark and VTT in Finland. In addition, a large number of institutions have studied the Chernobyl fallout and its consequences. Other research on chemical substances in the environment may be relevant in certain cases.

10.4 PROGRAMME 1993–1998

10.4.1 Wells

The methodology for how wells are to be handled in the safety assessment shall be further refined in keeping with the guidelines issued by concerned authorities. Smaller research efforts are planned to be devoted to surveying the existence of wells, their characteristics and what the water is used for.

10.4.2 Transport through sediment and soil

A study is under way to find an alternative way to model transport through sediment and soil. The K_d concept has its drawbacks, since the transport passes through many different strata which are furthermore not homogeneous. A thermodynamic approach is also being tried.

Site-specific quantitative descriptions will be produced of what types of recipients exist and may come to exist during the next 1000 years.

10.4.3 Changes in the biosphere

Within the site-specific studies, an assessment is needed of how man can be expected to exploit the ecosystems within a given area, for example what the land will be used for during the coming 1000 years.

In connection with the work on systematic analysis of scenarios, the impact of climatic changes and ice ages as well as human impact will be studied. See further in the chapter on Safety Assessment. In the programme concerned with the properties of

the rock, an inventory of the state of knowledge on ice ages and climatic changes will also be conducted.

10.4.4 Natural analogues

The role of sediments as a long-term and possibly final sink for released radionuclides will be more thoroughly studied. One way to do this is to try to quantify nuclide movements (waste-related or chemical analogues) in “natural analogues” such as ores, or leaching strata in peat. Large quantities of lanthanides are leached out of certain till soils, which can give us an opportunity to study how large a retention effect can be counted on in organic sediments. It should also be possible to quantify the concentration factors for uptake in plants and the role of peat as a nuclide concentrator.

10.4.5 Transport pathways in the biosphere

In 1986, in response to the Chernobyl accident, studies were initiated of the fallout in the SKB study sites of Gideå and Finnsjön. These studies are intended to be finished during 1993. The project includes a sampling and measurement programme, studies of migration in soil profiles, sorption on and migration in rock, water-transported activity and modelling of the turnover and transport of nuclides. The goal of the sampling and measurement programme is to be able to utilize the migration of the nuclides in the fallout for verification and validation of models that describe turnover in the biosphere and geosphere. The goal of the ground migration studies is to describe the transport and retardation mechanisms for different nuclides in different soils so that models for this transport can be refined. The purpose of the modelling is to describe the migration of the different nuclides in superficial parts of the geosphere, including groundwater, rock, soil and biomass.

Binding of actinides on organic matter in soils can be an important factor for the exposure pathway via vegetables, meat and milk. The complexation of e.g. iodine can be of great importance. The importance of the uncertainty in the turnover of the transuranic elements will be evaluated. Experimental studies may have to be carried out.

10.4.6 Models and data

Dispersal calculations in KBS-3 and SKB 91 were carried out with traditional box modelling based on available data on present-day ecosystems. Dose calculation is carried out with similar models utilizing radiophysical data and summarized in internationally accepted recommendations issued by ICRP /10-37, 38/.

Validation of models will continue to be carried out internationally within VAMP or BIOMOVs and with the aid of data from the Chernobyl fallout in Gideå and Finnsjön. Some of the parameters used in the box models are still poorly investigated for Nordic conditions. Sensitivity analyses will largely determine which parameters will be studied further during the coming six-year period, but greater weight will be attached to being able to report a model result with a well-founded description of variation and uncertainty.

10.4.7 Site-specific studies

For cases where the releases do not begin until after many tens of thousands of years, after ice ages have probably come and gone, the location of the repository cannot influence the biosphere transport of any nuclides released from the repository.

In scenarios where nuclide release takes place in a nearer future, however, the location of the repository will play a large role in determining how the radionuclides can be transported from the rock to the local ecosystems, and the properties of the points of outflow.

In scenarios where release is assumed to take place within a few thousand years, for example in the event of an initially defective canister, the site will be important for dispersal in local ecosystems, since present-day assumptions regarding land use can, for the most part, be expected to remain valid for this length of time.

It is therefore appropriate to continue site-specific model studies and also take into account the local impact of the final repository. The first study on Äspö will be followed by similar studies for the candidate sites that are proposed for siting of the final repository. The goal is that less generalized models can be used.

10.4.8 Acceptance criteria

The choice of radiological acceptance criteria is of great importance for how biosphere analyses are to be carried out. The work of international agencies should be carefully followed. The Swedish authorities will probably stipulate minimum requirements, which SKB may find reason to further tighten. In this context, comparisons between modellings and observations of outflows of natural nuclides in human surroundings, for example uranium-rich macadam production, can be of interest.

As in other countries, Swedish safety assessments have been based on the principle that "if man as an individual and as a group is protected, other biological species will not be threatened by radioactive releases". This principle has been applied to all types of releases, not just releases from waste storage facilities or final repositories. The principle has been questioned by some researchers in recent years and has led to an inquiry within the IAEA /10-44, 45/. By and large, the inquiry confirmed the above principle. SKB intends to follow developments within this area.

11 TECHNOLOGY FOR DEEP DISPOSAL

11.1 GENERAL

When the characterization of potential sites for the deep repository and the planning and design of a deep repository for demonstration deposition have begun, the continued development of technology for construction and excavation of the repository and for deposition of the waste will be coordinated with the planning and design of the deep repository.

11.2 GOAL OF THE ACTIVITIES 1993-1998

The goal during the period is to develop the technology for the execution of deep disposal of encapsulated fuel, including backfilling and retrieval, to such a degree of maturity that detailed characterization (ramp excavation or shaft sinking) can begin around 1998. During the first three-year period, the development potential of the preferred deposition system will be analyzed and system studies and conceptual designs of machinery and methods will be carried out. During the second three-year period, studies will be conducted on a prototype scale of deposition and retrieval equipment, if such studies are deemed necessary prior to scaling-up to full scale.

Construction methods will be refined with respect to grouting of fine fractures and with respect to the passage of strongly water-bearing zones with high water pressure.

11.3 PRESENT-DAY STATE OF KNOWLEDGE

11.3.1 Deep disposal system

In 1984, the Government approved the KBS-3 method as a system that fulfils society's requirements on radiation protection and long-term safety. This method has since then constituted the reference method in SKB's research and development activities.

Since 1984 SKB has developed and analyzed some other interesting disposal methods with successful results. It has been possible to demonstrate that the alternatives also have potential for fulfilling stringent requirements on long-term performance and safety. The studied alternatives are as follows, see Figure 11-1:

- WP-Cave, which is based on a concentrated isolation of the fuel canisters in a central rock volume surrounded by a bentonite barrier and a hydraulic cage /11-1/.
- Deep Boreholes, VDH (Very Deep Holes), which entails deposition of canisters, surrounded by bentonite, at a depth of between 2 and 4 km in boreholes /11-2/.
- Long Tunnels, VLH (Very Long Holes), which entails deposition of relatively large canisters, surrounded by bentonite, in bored tunnels /11-3/.
- Medium-Long Tunnels, MLH (Medium-Long Holes), which entails deposition of KBS-3 canisters, surrounded by bentonite, in rows in bored tunnels /11-4/.

Comparisons of these alternative methods with the KBS-3 method have shown the KBS-3 method to be the most advantageous (WP-Cave vs. KBS-3 in /11-1/ and VDH vs. VLH vs. MLH vs. KBS-3 in /11-4/). Deposition of encapsulated waste in bored

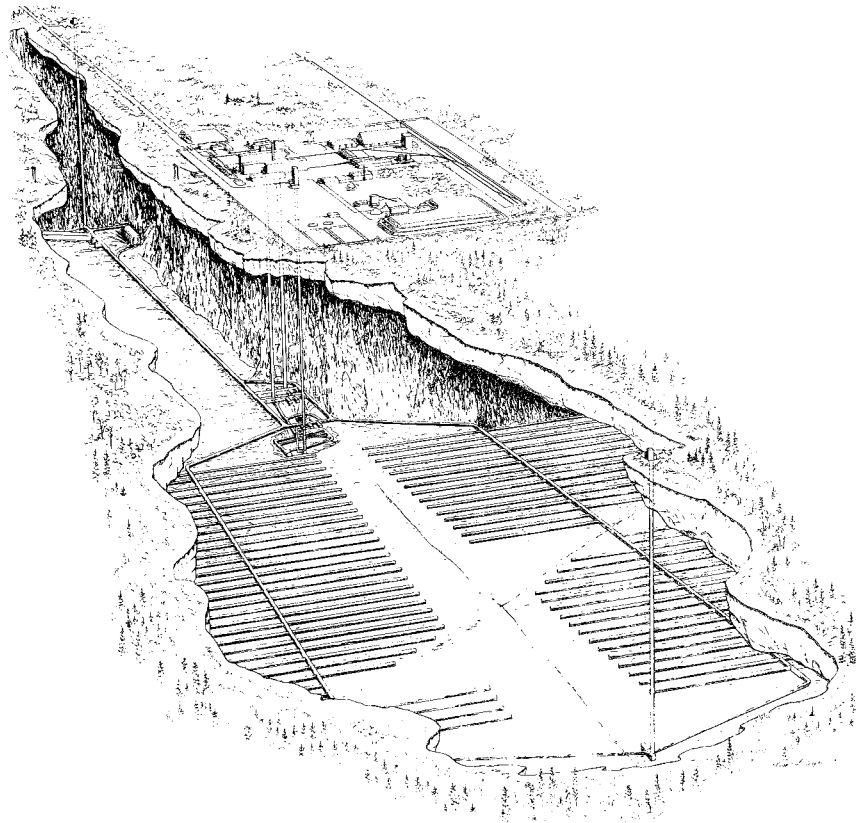

Figure 11-2. Deep repository according to KBS-3 - general layout.

holes in the floor of a system of deposition drifts will therefore comprise the reference method in the continued work as well.

11.3.2 Preferred repository design

The deep repository consists of a series of parallel deposition tunnels on one level, which are connected with transport tunnels. The layout is illustrated in Figure 11-2. The deposition level can be reached from the surface either via shaft alone, such as shown in Figure 11-2, or via a ramp and service shaft.

The waste canisters are placed in vertical holes bored in the tunnel floor and surrounded by highly compacted bentonite blocks. A cross-section of a deposition hole is shown in Figure 11-3.

The canisters are transported from the surface to the deposition level in a radiation-shielded elevator (shaft alternative) or in a radiation-shielded transport container in a ramp (ramp alternative). On the deposition level, the canister is taken up to the appropriate deposition tunnel, where the canister is transferred to a special deposition vehicle, which handles canisters and bentonite inside the deposition tunnel. The vehicle drives into the tunnel. When the canister is in position above the deposition hole, the canister is raised to a vertical position and lowered into the hole. The lower part of the bentonite buffer is then already in place. After canister emplacement, the deposition vehicle backfills the rest of the hole. The deposition sequence is illustrated by Figure 11-4.

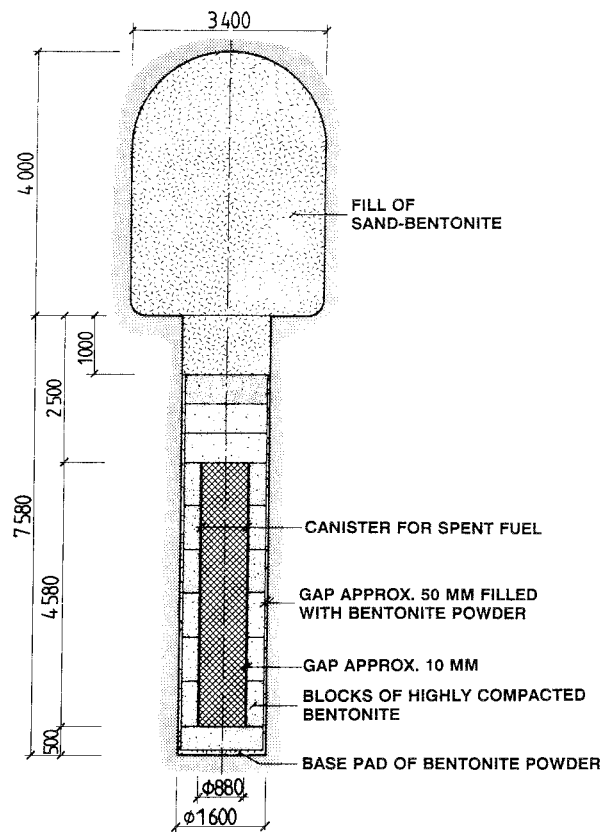

Figure 11-3. Deposition hole with canister and bentonite buffer.

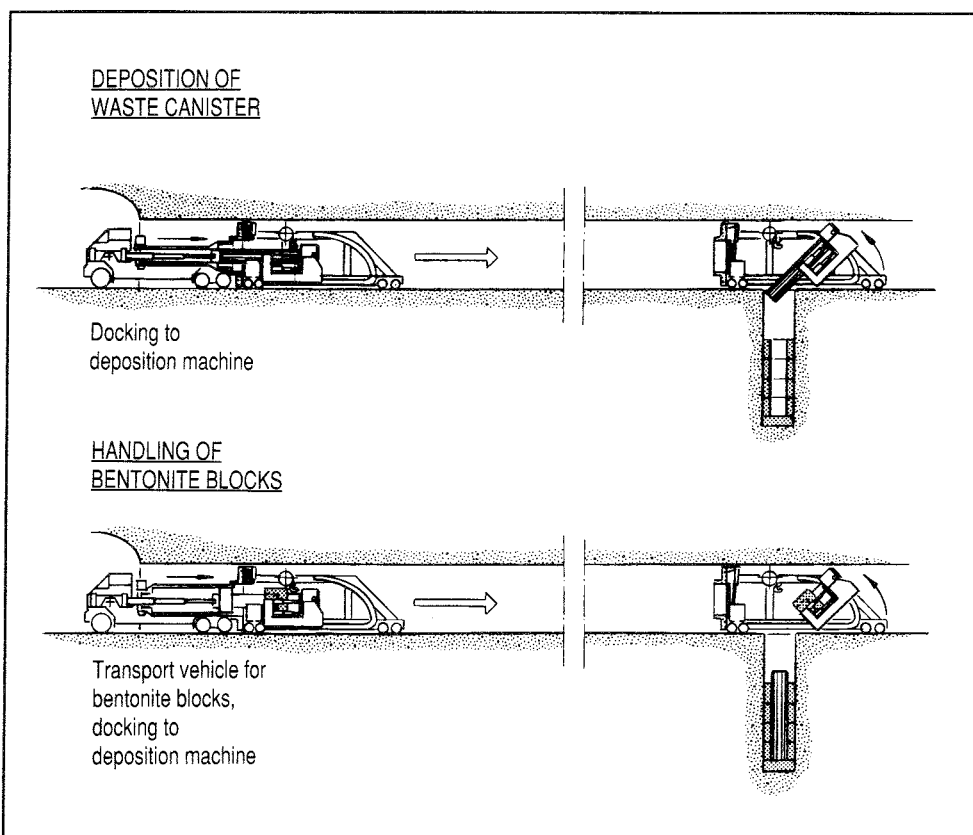

Figure 11-4. Principle for deposition of canister and emplacement of bentonite buffer.

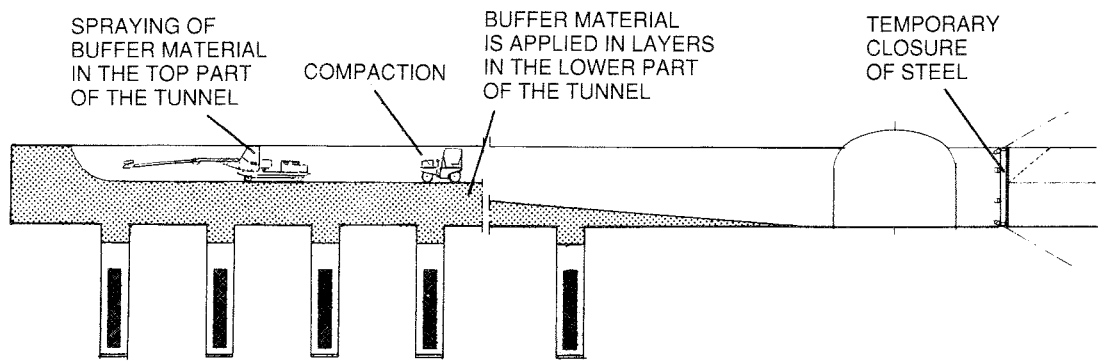

Figure 11-5. Backfilling of the deposition tunnel.

Finally, the deposition tunnel is backfilled with a mixture of bentonite and sand, which is illustrated in Figure 11-5.

The design with canisters in vertically bored holes was originally chosen so that the canisters could be emplaced in undisturbed rock, outside the disturbed zone that it was known could be formed around a blasted tunnel. Furthermore, the idea was to keep each canister sufficiently isolated from surrounding canisters to prevent any transport of fissile material between the canisters. Another advantage of such a design is that the deposition of each canister is an isolated process with little impact on the deposition of surrounding canisters.

The very high level of safety described in SKB 91 /11-5/ presumes well-executed encapsulation, deposition and backfilling.

11.3.3 Technology for excavation and deposition

General

Access to the repository is provided via a vertical shaft or an inclined ramp. The central area on the repository level is excavated first and thereafter transport tunnels and deposition tunnels. Finally, the deposition holes are bored.

The methods for excavation of the deep repository, deposition of the canisters and backfilling around the canisters with bentonite are based on known technology or adaptation of known technology in accordance with established engineering practice to the special applications in question.

Fracture zones and strongly water-bearing rock can cause practical problems in connection with the excavation work and available technical options need to be assessed before detailed characterization (underground excavation and investigation) is commenced.

Drilling-blasting-boring

It is assumed that conventional drilling and blasting will be used to a large extent. With the aid of the smooth blasting technique, impact on the rock walls in tunnels and caverns can be reduced if this is desirable.

In a special blasting damage study on the Äspö ramp /11-6/, the damages in the rock wall were analyzed for three different drilling patterns. The results showed that the

blast-damaged zone had been limited to about three decimetres in walls and roofs, while the floor region was affected more than one metre below the floor.

Boring affects the rock wall much less than blasting /11-7/.

Mechanisms and parameters that control the zone that is affected by drilling/blasting and by boring are, however, incompletely understood. Experiments are planned to be carried out in the Äspö Hard Rock Laboratory, see the background report to RD&D-Programme 92 concerning the Äspö Hard Rock Laboratory.

Rock works

Sinking of a shaft or excavation of a ramp by means of drilling and blasting can be adapted to highly varying conditions.

The use of full-face boring or mechanized excavation entails a potential advantage from the viewpoint of long-term safety, since the rock nearest the shaft or the ramp is then disturbed less than by blasting.

Full-face boring of shafts has long been employed in soft rock types, but recently in hard rock types as well. It is possible to bore the skip shaft, which is the one that is planned to be sunk in the shaft alternative. (Other shafts will be raise-bored.) The price, however, is likely to be higher than for conventional shaft sinking today.

Modern experience is available from boring with a Tunnel Boring Machine (TBM) in hard rock in Sweden: two tunnels below Stockholm (3.5 m in diameter) and one tunnel in the Klippen power station (6.5 m in diameter with a downward gradient of 1:10). This method is primarily of interest for excavating a ramp to deposition depth.

Equipment for mechanical mining of different tunnel profiles in hard rock was tested back in the '70s by Atlas Copco. A modern rig has been manufactured by Robbins and used in the Mount Isa Mine in Australia with good results. That machine has a wheel with cutters along its periphery, mounted on a movable arm. A second, more powerful generation of this machine was delivered in early 1992 to the Pismenco mine at Broken Hill, Australia. The bedrock in both mines consists of hard rock, Precambrian leptites, with a compressive strength of 150-400 MPa. The machine permits a high rate of advance, which has led to great interest on the part of both the mining and the construction industries.

The 7.5 m deep deposition holes with a diameter of 1.6 m are full-face-bored. A rig capable of performing this boring with a roof height of only about 3.5 m is on the drawing table /11-8/.

Rock support

A number of rock support methods are used in underground construction and mining, all according to the rock being worked in. Concrete is often used in poor rock for technical/economic reasons. Only rarely is work interrupted because the problems are technically insurmountable, but rather because the costs are too high. The use of concrete may, however, be limited in a deep repository, since the chemical environment with a neutral pH and small quantities of easily accessible calcium is of great importance for the long-term performance of the engineered barriers. Other methods must be available for use as a complement to or substitute for concrete when needed.

Grouting

Grouting is employed regularly to seal off water seepage into rock caverns. Great experience exists with different grouts and additives. Commercially used grouts are mainly cement-based, but plastic-based ones are also on the market.

Fine fractures

The use of both cement-based materials and bentonite as grouts in fine fractures in the zones nearest the deposition positions was studied in the Stripa project.

It was found that the deposition holes can be sealed against water seepage with the aid of bentonite /11-9/. Sealing is done after the hole has been drilled. Megapackers with a narrow gap between the packer and the rock wall are installed along the zone to be sealed, after which the grout is injected. The best effect in fine fractures was obtained by the use of "dynamic" injection, whereby an oscillating pressure was imposed on the regular static injection pressure. The method can serve the primary purpose of preventing water seepage during the actual deposition procedure.

Pre-grouting with cement-based materials also gave good results in connection with the application of "dynamic" injection in boreholes.

The results for fine fractures in rock that had been sheared and disintegrated mechanically during blasting were, on the other hand, negative. The reason is believed to be that fine rock fragments are torn loose in the fractures and clog the injection channel for the grout.

Wide fractures

Wide fractures with high hydraulic conductivity and high water pressure create practical problems, such as have been experienced during the excavation of the Äspö ramp.

Preparedness for these types of difficulties consists today primarily of familiarity with a number of different grouting materials and experience from projects where these grouts have been used with good or poor results. Based on this knowledge, the problem at hand is solved by trying different materials and methods until a good sealing effect is obtained.

In the Stripa project, models were developed for the properties of the grouts and their expected behaviour in different fractures. These models can also be used on wider fractures. In order to obtain a good description of reality, knowledge is also required of certain fracture properties. These are difficult to measure and determine, however, which makes it more difficult to predict grouting measures and results.

Deposition and retrieval

The vehicle for deposition of canisters and emplacement of the bentonite buffer is specially designed. An initial design sketch is on the drawing table today. It will be further improved by means of design studies and risk analysis of the deposition process. The question of prototype testing will subsequently be considered before design drawing and specifications for the manufacture of full-sized vehicles are produced.

In the event of serious interruptions during the deposition procedure, there are situations that are best rectified by retrieving the canister and starting the deposition procedure over from the beginning. Retrieval of deposited canister is also a component of the demonstration deposition, a requirement being that canisters can be retrieved to the ground surface after the deposition tunnels have been backfilled and sealed.

Equipment for retrieval of canister (and excavation of the buffer material) is being developed in parallel with the equipment for deposition.

The bentonite blocks around the canisters are compacted in a surface facility. The technology is known and compaction equipment is available in many versions for varying applications. The actual handling of the bentonite has not yet been determined, however, nor has the size of the blocks that can be fabricated without compromising good, uniform density and without creating large, uneven stresses.

The blocks for the Buffer Mass Test at Stripa were fabricated in an existing facility. The bentonite in these blocks had a "normal" moisture content, which means that parts of the pore space were filled with gas (air). Moisture-saturated bentonite, in the sense that the pore volume is water-saturated from the beginning, have not been tested, however. The advantage of a higher moisture content from the beginning is that the buffer zone has a higher initial thermal conductivity, which reduces the temperature peak in the buffer. The amount of oxygen near the canister is also reduced somewhat before the buffer has been saturated with water. In the event of saline groundwater, the potential risk of salt enrichment in the buffer during the water saturation phase is also avoided.

Backfilling

The deposition drifts are backfilled with a mixture of sand and bentonite, which is cheaper than pure bentonite. The lower part of the backfill can be applied in layers and compacted in place with ordinary vibrators. The upper part against the roof must be applied in some other way.

In the Stripa project, a mixture of 20% bentonite and 80% sand was sprayed in with shotcreting equipment. However, the density of the backfill material was not high enough to create a large enough swelling pressure so that the sand/bentonite mixture could support the roof of the tunnel and prevent creep deformation /11-10/. A better support can be achieved either by using a much more bentonite-rich mixture, which is costly, or by employing some kind of in-situ compaction.

Plugging

When the deposition procedure has been concluded, the repository will be sealed by backfilling of excavated areas. Tunnels and shafts will be plugged at strategic points. These plugs can be made of concrete and bentonite, which has been demonstrated by tests at Stripa /11-11, 11-12/.

The plugs with the tested designs effectively sealed off channels for water transport inside the tunnel (or the shaft). However, possible axial channels remain in the disturbed zone in the near-field rock outside the plug. These channels must also be sealed, which can be done by cutting out slots in the rock wall so that the plug will have a larger diameter than the tunnel. In addition, grouting shields can be placed around the plug. Design and effects have not been analyzed in detail, however.

Boreholes also need to be sealed with plugs. Method and design have been developed in the Stripa project /11-13/. Supplementary field tests in long holes can be conducted in the Äspö Hard Rock Laboratory.

11.4 PROGRAMME 1993–1998

System studies

Different development possibilities of the KBS-3 design will be analyzed during the first three-year period. The main issues of interest are the necessary height of the deposition tunnels and deposition holes for two canisters on top of one another.

The premises will be analyzed for a shaft or a ramp as a communication pathway between the ground surface and the repository.

The VDH system has been ranked lowest in PASS and will not be studied further as a unitary system. The studies have, however, identified a significant barrier potential in the increasing salinity with depth. The initiated modelling of the barrier function will be pursued further. Moreover, any new geoinformation that may be obtained from the deep drilling work, as well as other information of importance for a KBS-3 repository at a depth of about 500 m below the surface, will be monitored, see section 6.5.

Construction methods

Tests will be conducted with a machine for full-face boring of the deposition holes.

Grouting methods for sealing of fine fractures with megapackers will be further refined. Practical tests will be performed in the Äspö Hard Rock Laboratory.

Methods will be worked on for passage of water-bearing fractures with high pressure. A trial passage of some zone on the laboratory level at Äspö is being considered.

Deposition – retrieval

Deposition and retrieval equipment will be developed in several stages. In a first stage, design drawings will be prepared of full-sized units. A decision will then be made as to whether the deposition vehicle needs to be built and tested on a prototype scale before manufacture on a full scale can begin. The design work and possible prototype-scale tests will be carried out during the period.

Development of technology for rational fabrication of bentonite blocks will be commenced. The work is aimed at fabrication of blocks with both low and high water ratio.

Backfilling and sealing of tunnels and shafts

A suitable strategy for backfilling of the deposition tunnels will be developed up to 1995. The composition, compactability and long-term performance of different mixtures, as well as equipment for achieving a sufficient degree of compaction of these mixtures, will hereby be investigated.

Plugs for sealing of tunnels and shafts will be further developed. Test plugs may be made in the tests in the Äspö Hard Rock Laboratory where large-scale experiments with buffer material are being conducted and the buffer is to be closed in.

12 OTHER WASTE

12.1 BACKGROUND

Two principal types of radioactive waste are obtained part in Sweden: spent fuel and short-lived low- and intermediate-level waste (LLW and ILW). The LLW and ILW consists in the main of waste from the operation of nuclear power plants. A smaller contribution comes from research, industry and medical care. This waste is to be disposed of in SFR, which is already in operation. Radioactive components and waste arising from the eventual decommissioning of the nuclear power plants will also be emplaced in an annex to SFR.

A third category of waste consists of long-lived LLW and ILW. Only a relatively small quantity of such waste will have to be disposed of in Sweden. It consists primarily of waste from the research activities at Studsvik. Such waste is collected, interim-stored and conditioned at Studsvik. Some components from power reactors in or near the reactor core contain long-lived activity and can also be categorized with this type of radioactive waste, along with certain waste to be obtained from the encapsulation plant for spent fuel. The waste is conditioned in cement and packaged in containers of metal (drum) or concrete. In its form, this waste thus resembles that which is sent to SFR, but its nuclide composition is different. The total volume of long-lived LLW and ILW ultimately to be disposed of is estimated at about 20 000 m³.

Much larger quantities of long-lived LLW and ILW are obtained in those countries that reprocess their spent nuclear fuel. During reprocessing, long-lived radionuclides – mainly transuranic elements – are released from the fuel matrix when the latter is chemically dissolved. Most is reused, e.g. plutonium and uranium, or ends up in the high-level waste (HLW). However, relatively large volumes of LLW and ILW with long-lived radionuclides also arise in the process, such as filter resins, evaporator concentrate and various kinds of contaminated trash and scrap.

Without reprocessing, the transuranics and other long-lived nuclides remain in the fuel and can be encapsulated as HLW.

12.2 WASTE COMPOSITION

12.2.1 Waste from research activities at Studsvik

Solid waste and liquids are treated at Studsvik. The solid waste consists of such materials as cloth, wood, paper, plastics (PVC, plexiglas etc.), rubber, glass, iron, stainless steel, aluminium and titanium. Some cadmium is also included. The waste is packaged in drums, which are placed in concrete moulds. Glove boxes for work with alpha-active radionuclides have been scrapped, for which inner containers of stainless steel have been used. Approximately 100 moulds had been produced as of 1990, along with around sixteen 200-litre drums of concrete-immobilized sludge from the treatment of liquid waste with alpha activity. Alpha-active waste from previous research activities that has not yet been conditioned is also kept at Studsvik. It will be treated at Studsvik in the same manner as outlined above.

There is also older conditioned waste at Studsvik containing plutonium and uranium. There are, for example, around 400 drums of concretized plutonium-containing waste.

From the research activities at Studsvik there are also fuel residues, i.e. pieces of fuel pins, fuel pellets or specimens obtained from post-irradiation examinations of fuel. The fuel residues are encapsulated in steel tubes and taken to CLAB for interim storage. Afterwards they will be encapsulated in the same manner as the spent fuel. The fuel residues are not discussed any further in the following.

Some long-lived waste from the use of radiation sources in medicine, research and industry is also treated at Studsvik.

12.2.2 Core components and reactor internals

Components in the reactor core and its immediate vicinity are exposed to a very strong neutron flux during reactor operation. This induces radioactivity in the material of which the components are made. What mainly forms is short-lived nuclides such as Co-60, but also some long-lived nickel and niobium isotopes. The Co-60 concentration is so high that the core components require heavy radiation shielding for a long period of time (>50 years).

Examples of core components are control rods, neutron detector probes, neutron source probes and boron plates. The core components also include fuel boxes from BWR fuel if they are separated from the fuel. Examples of internals with high induced activity are core grids and core support plates.

This waste is transported to CLAB for interim storage. After this it is intended to be embedded in concrete moulds and deposited in the deep repository for other long-lived waste.

12.2.3 Waste from the encapsulation station

The waste from the operation and decommissioning of the encapsulation station will not differ appreciably from the waste from the other nuclear facilities, i.e. it will mainly consist of LLW and ILW of the type that can be sent to SFR. If it should be decided to close SFR while the encapsulation station is still in operation, the repository for long-lived waste offers an alternative. In the event of accidents where the fuel breaks, however, some of the waste may also be classified as long-lived.

12.3 FINAL DISPOSAL

The chemical properties of the long-lived waste do not differ appreciably from those of the waste disposed of in SFR. A similar facility for final disposal will therefore be built. However, the higher content of long-lived activity will impose higher demands on long-term safety. After a thousand years, long-lived activity will still remain in significant quantities in terms of safety, although for example concrete structures may have been altered, along with the waste form itself.

The facility for final disposal of the long-lived waste (and certain other operational waste that arises after SFR has been closed) is planned to be built adjacent to the deep repository for spent fuel. In PLAN 92 they are shown co-sited, whereby the same waste and personnel shafts are used. The repository areas for long-lived waste are named SFL 3 and SFL 5. To avoid disturbances of the deep repository for spent fuel, SFL 3 and 5 have been located at a distance of about 1 km. The tunnel between the

different repository sections will be sealed in the same manner as the deposition tunnels in the fuel repository, i.e. with a sand-bentonite mixture.

SLF 3, where the Studsvik waste and the waste from the encapsulation plant is to be emplaced, consists of a rock vault in which the waste is stacked in concrete cells and grouted with concrete. The space between the concrete cells and the rock is filled with sand-bentonite mixture. All handling is done by remote control via an overhead crane. The principle of the barriers in SFL 3 is the same as the silo repository in SFR.

SFL 5, where concrete moulds with core components etc. are to be deposited, consists of two 350 m long tunnels. The concrete moulds are transported in by a remote-controlled overhead crane and stacked on top of one another. After stacking, they are grouted with concrete.

After concluded deposition in SLF 3 and 5 (as well as SFL 4 for decommissioning waste from CLAB and the encapsulation plant), the tunnels are sealed with sand-bentonite.

Large quantities of LLW and ILW are obtained in countries that send their spent fuel to reprocessing, for example the USA, France, the UK, Germany and Switzerland.

In the USA a final repository for long-lived LLW and ILW has been built in a salt formation in New Mexico. The facility, called WIPP (Waste Isolation Pilot Plant), is a pilot facility and will mainly be used for waste from the American military programme.

At Sellafield in England, investigations are under way for a repository at a depth of about 800 metres. Several test drillings have been carried out in the area around Sellafield. Dounreay in Scotland has also been investigated. The investigations are being led by NIREX, Nuclear Industry Radioactive Waste Executive, which is responsible for conducting investigations and planning for the final disposal of LLW and ILW in England. According to a general repository concept for LLW and ILW presented in 1989, the waste is intended to be emplaced in twenty-six 250-metre-long galleries. The waste is conditioned with cement and packaged in steel drums. Concrete is used for the underground structures and as a backfill material.

In Germany, the feasibility of building a deep repository for long-lived LLW and ILW in an abandoned iron ore mine, Konrad, has been investigated. The repository will be situated at a depth of about 1000 metres. Responsibility for management of radioactive waste in Germany rests with BfS, Bundesamtes für Strahlenschutz. An application for permission to use Konrad for this purpose has been submitted to the appropriate authorities.

Underground disposal of this kind of waste is planned in Switzerland as well. LLW and ILW is expected to be sent back after the reprocessing of Swiss fuel in France. Investigation and planning is under the direction of NAGRA, Nationale Genossenschaft für die Lagerung radioaktiver Abfälle.

SKB will follow developments, and learn from experience, in this field in order to design and plan the disposal of the Swedish LLW and ILW. In an international comparison, Swedish quantities of this waste are small, since Sweden does not intend to reprocess the spent fuel.

12.4 GOALS OF THE ACTIVITIES 1993–1998

Planning, design and construction of facilities beyond those needed for demonstration deposition will commence at the earliest a few years into the 21st century. The goal of investigations concerning other waste during the coming six-year period are to:

- Inventory and characterize existing and forecast waste of this type.
- Continue work on designing the deep repository for LLW and ILW.
- Prepare and gather data for the necessary safety assessments.

12.5 PROGRAMME FOR 1993–1998

Inventory and characterization of the waste includes not only the radionuclide content of the waste. It is also important to know the composition of the waste, the materials it contains, how the waste has been conditioned and packaged, etc. Documentation on the waste will be compiled as the waste is conditioned and packaged. A checklist of components that can be of importance for long-term safety is in the process of being prepared. In many respects it coincides with an equivalent list for SFR.

According to current plans, the final repository for long-lived waste will be built in conjunction with the second stage of the deep repository. No detailed work on the design of the final repository is therefore planned during the period in question. For the time being, current general proposals for repository design can be used for the preparatory safety studies.

The safety assessment will require information in a variety of different areas. In addition to waste composition, repository design and geoproperties of the repository site, a number of specific topics need to be examined. They include the physical and chemical alteration of the concrete with time, the impact of the concrete on the environment, possible gas evolution, formation and importance of organic complexes and colloids, solubility and sorption of radionuclides in and outside the repository, diffusion of radionuclides in concrete and possible backfill, etc. Different scenarios need to be dealt with and models developed that describe the release from the near field and transport in the far field of any leaking nuclides.

In an initial phase which will extend several years into the future, efforts relating to other long-lived waste may largely be restricted to making an inventory of the waste and carefully following international work on development and analysis of deep disposal of long-lived LLW and ILW. Interest is primarily focused on the UK, Germany, France and Switzerland.

Some investigations of an experimental nature that take a long time to carry out may have to be started earlier. These studies should preferably be integrated with the continued investigations that are planned for SFR, since the questions to be dealt with are similar and concern to a large extent chemical changes occurring over a long period of time.

Natural analogues where hyperalkaline chemical conditions have prevailed for tens of thousands of years can provide information on the environment and the reactions to which concrete gives rise. Such an analogue is provided by the deposits of portlandite and hyperalkaline groundwater in Maqarin in Jordan, see section 8.4.

Deep disposal of LLW and ILW differs from SFR in that the rock can be utilized as a barrier to a higher degree. Most of the questions relating to groundwater flow at repository depth and radionuclide migration in the geosphere are the same as for the HLW. The geoinvestigations that are under way and planned for the Äspö Hard Rock Laboratory are therefore highly relevant here as well. Among other things, experiments with radionuclide migration are planned for the construction phase at the Äspö Hard Rock Laboratory. This will provide an opportunity to test some of the conditions that govern the release and transport of radionuclides from a repository with cement-conditioned waste.

REFERENCES

Chapter 1

- 1-1 PLAN 92. Costs for management of the radioactive waste from nuclear power production.
Technical Report TR 92-24, Stockholm.
June 1993.
- 1-2 Final storage of spent nuclear fuel – KBS-3. Parts I-IV.
SKBF/KBS, Stockholm.
May 1983.
- 1-3 **Peltonen E K, Ryhänen V, Salo J-P, Vieno T K and Vuori S J**
Concept and Safety Assessment for Final Disposal of Spent Nuclear Fuel in Finland. Proc. Int. Symp. on Siting, Design and Construction of Underground Repositories for Radioactive Wastes. IAEA, Wien 1986, pp 611-624.
- 1-4 PROJEKT GEWÄHR 1985. NAGRA Projektbericht NGB 85-01 – NGB 85-08, Baden.
Januar 1985
- 1-5 Technical Appraisal of the Current Situation in the Field of Radioactive Waste Management. A Collective Opinion by the Radioactive Waste Management Committee.
OECD/NEA, Paris.
1985
- 1-6 Disposal of Radioactive Waste: Can Long-term Safety be Evaluated? An International Collective Opinion. NEA – IAEA – CEC. OECD/NEA, Paris.
1991
- 1-7 SKB 91. Final disposal of spent nuclear fuel. Importance of the bedrock for safety.
Technical Report TR 92-2, Stockholm.
May 1992.
- 1-8 Evaluation of SKB R&D-Programme 89.
SKN (National Board for Spent Nuclear Fuel).
March 1990.
- 1-9 Miljödepartementet. Program för forskning m m angående kärnkraftsavfallets behandling och slutförvaring.
Regeringsbeslut 21. 1990-12-20
- 1-10 WP-Cave – Assessment of feasibility, safety and development potential.
SKB Technical Report 89-20, Stockholm.
September 1989
- 1-11 **Juhlin C, Sandstedt H**
Storage of nuclear waste in very deep boreholes: Feasibility study and assessment of economic potential. Part I: Geological considerations 1). Part II: Overall facility plan and cost analysis 2).
SKB Technical Report TR 89-39, Stockholm.
December 1989.

- 1-12 Sandstedt H, Wichmann C, Pusch R, Börgesson L, Lönnerberg B**
Storage of nuclear waste in long boreholes.
SKB Technical Report TR 91-35, Stockholm.
August 1991
- 1-13 SKB Annual Report 1991**
Including Summaries of Technical Reports Issued during 1991.
SKB Technical Report TR 91-64, Stockholm.
May 1992
- 1-14 Background report to RD&D-Programme 92.**
Treatment and final disposal of nuclear waste.
Äspö Hard Rock Laboratory.
SKB, Stockholm.
September 1992.
- 1-15 Background report to RD&D-Programme 92.**
Treatment and final disposal of nuclear waste.
Siting of a deep repository.
SKB, Stockholm.
September 1992.

Chapter 2

- 2-1** See 1-7.
- 2-2** Final storage of spent nuclear fuel – KBS-3.
SKBF/KBS, Stockholm.
May 1983.
- 2-3** SKI Project-90.
SKI Technical Report 91:23, Statens Kärnkraftsinspektion, Stockholm.
1991
- 2-4** PROJEKT GEWÄHR 1985.
Nagra Projektbericht NGB 85-01 – NGB 85-08; NAGRA Baden.
Januar 1985
- 2-5 van Kote F et al.**
PAGIS – Etude des Performances de Systèmes d’Isolement Géologique pour déchets radioactifs. Enfouissement dans des formations granitiques.
EUR 11777 FR. CEC, Bruxelles-Luxembourg.
1988
- 2-6** Preliminary comparison with 40 CFR Part 191 Subpart B for the Waste Isolation Pilot Plant.
Sandia Report SAND 91-0893, Albuquerque.
December 1991
- 2-7** Report of Early Site Suitability Evaluation of the Potential Repository Site at Yucca Mountain, Nevada; SAIC-91/8000.
January 1992
- 2-8** Feasibility of disposal of high-level radioactive waste into the seabed.
Volumes 1-8, OECD Nuclear Energy Agency; Paris.
1988

- 2-9** SFR-1 Fördjupad säkerhetsanalys
SKB Arbetsrapport SFR 91-10, SKB, Stockholm.
Augusti 1991
- 2-10 Vieno T, Nordman H**
Safety Analysis of the VLJ Repository.
Nuclear Waste Commission of Finnish Power Companies, Report YJT-91-12
(in Finnish).
May 1991
- 2-11** Disposal of radioactive Waste: Review of safety Assessment methods,
OECD/Nuclear Energy Agency; Paris.
1991
- 2-12** Disposal of Radioactive Waste: Can Long-term Safety be Evaluated? An
International Collective Opinion, OECD/NEA, Paris.
1991
- 2-13 Andersson J (Editor)**
The Joint SKI/SKB Scenario Development Project
SKB Technical Report TR 89-35, Stockholm.
December 1989
- 2-14 Ahlbom K, Ericsson och Äikäs T**
SKB/TVO Ice Age Scenario.
SKB Technical Report TR 91-32, Stockholm.
1991
- 2-15** Projekt Alternativstudier för Slutförvar (PASS). Slutrapport.
SKB, Stockholm.
September 1992
- 2-16 Kjellbert N**
Tullgarn – a near field radionuclide migration code.
SKB Arbetsrapport AR 91-25, Stockholm.
August 1991
- 2-17 Norman S, Kjellbert N**
NEAR21 – A near field radionuclide migration code for use with the PROPER
package.
SKB Technical Report TR 91-19, Stockholm.
April 1991
- 2-18 Nilsson L, Moreno L, Neretnieks N, Romero L**
A resistance network model for radionuclide transport into the near field
surrounding a repository for nuclear waste (SKB, Near Field Model 91).
SKB Technical Report TR 91-30, Stockholm.
June 1991
- 2-19 Edwards A L**
TRUMP: A Computer Program for Transient and Steady State Temperature
Distributions in Multidimensional Systems.
report, Natl. Tech. Inf. Serv., Nat. Bur. of Standards, Springfield, VA.
1969

- 2-20 Bengtsson A, Widén H**
Transient release through the bentonite barrier – SKB 91.
SKB Technical Report TR 91-33, Stockholm.
May 1991
- 2-21 Romero L, Moreno L, Neretnieks I**
A compartment model for solute transport in the near field of a repository for radioactive waste (Calculations for Pu-239).
SKB Technical Report TR 91-48, Stockholm.
October 1991
- 2-22 Nyman C, Ozolins V, Moreno L, Neretnieks I**
Development of a model for handling the movement of redox fronts and other sharp reaction fronts.
Paper presented at Migration 91.
- 2-23 Wolery T J**
Calculation of Chemical Equilibrium between Aqueous Solutions and Minerals: The EQ3/6 Software Package.
Lawrence Livermore National Laboratory, Livermore CA, UCRL-52658.
1979
- 2-24 Bruno J, Sellin P**
Radionuclide solubilities to be used in SKB 91.
SKB Technical Report TR 92-13, Stockholm.
1992 (in print)
- 2-25 Puigdomènech I, Bruno J**
Modelling of uranium solubilities in aqueous solutions: Validation of a thermodynamic data base for the EQ3/6 geochemical codes.
SKB Technical Report TR 88-21, Stockholm.
October 1988
- 2-26 Puigdomènech I, Bruno J**
Plutonium solubilities.
SKB Technical Report TR 91-04, Stockholm.
February 1991
- 2-27 Norman S**
HYDRASTAR – A code for stochastic simulation of groundwater flow.
SKB Technical Report TR 92-12, Stockholm.
May 1992 (in print)
- 2-28 Lindbom B, Boghammar A**
Numerical groundwater flow calculations at the Finnsjön study site – extended regional area.
SKB Technical Report TR 92-03, Stockholm.
March 1992

- 2-29 Ahlbom K (Part A), Svensson U (Part B and C)**
 The groundwater circulation in the Finnsjö area – The impact of density gradients
 Part A: Saline groundwater at the Finnsjö site and its surroundings
 Part B: A numerical study of the combined effects of salinity gradients, temperature gradients and fracture zones
 Part C: A three-dimensional numerical model of groundwater flow and salinity distribution in the Finnsjö area
 SKB Technical Report TR 91-57, Stockholm.
 November 1991
- 2-30 Dershowitz WS, Lee G, Geier J**
 FRACMAN version 2.3. Interactive discrete feature data analysis, geometric modeling, and exploration simulation user documentation.
 Golder Associate Inc., Redmond, Washington, USA.
 1990
- 2-31 Miller I**
 MAFIC version beta 1.2 – Matrix/fracture interaction code with absolute transport user documentation.
 Golder Associates Inc., Redmond Washington, USA.
 1990
- 2-32 Moreno L, Neretnieks I**
 Fluid and solute transport in a network of channels.
 SKB Technical Report TR 91-44, Stockholm.
 September 1991
- 2-33 Bergström U, Nordlinder B**
 Individual doses from radionuclides released to the Baltic coast.
 SKB Technical Report TR 91-41, Stockholm.
 May 1991
- 2-34 Zeevaert T and Jones C**
 Transfer from the geosphere to the biosphere through two different receptor types.
 Proc from "The validity of environmental transfer models BIOMOVs" October 8-10, 1990.
 Swedish radiation protection institute, Stockholm, Sweden.
- 2-35 Nordlinder S and Bergström U**
 A dynamic model of the Cs-137 concentration in fish applied to seven different lake ecosystems – a VAMP scenario.
 Presented at the 6th Nordic Radioecological seminar, Torshavn Faroe Islands 14-18 June 1992.
 Studsvik report NS-92/44.
- 2-36 NEA PSAC User Group**
 PSACOIN level 1b Intercomparison.
 NEA/OECD, Paris.
 1992
- 2-37 Bergström U, Nordlinder S**
 Uncertainties related to dose assessments for high level waste disposal.
 Nuclear safety vol 32 no 3.
 1991

- 2-38 Bergström U, Evans S, Puigdoménech I, Sundblad B**
 Long-term dynamics of a lake ecosystem and the implications for radiation exposure.
 SKB Technical Report TR 88-31, Stockholm.
 September 1988
- 2-39 Norman S**
 Statistical inference and comparison of stochastic models for the hydraulic conductivity at the Finnsjö site.
 SKB Technical Report TR 92-08, Stockholm.
 April 1992
- 2-40 Kung Chen Shan, Wen Xian Huan, Cvetkovic V, Winberg A**
 Stochastic continuum simulation of mass arrival using a synthetic data set. The effect of hard and soft conditioning.
 SKB Technical Report TR 92-18, Stockholm.
 June 1992
- 2-41 Geier J E, Axelsson C-L, Hässler L, Benabderrahmane A**
 Discrete fracture modelling of the Finnsjön rock mass: Phase 2.
 SKB Technical Report TR 92-07, Stockholm.
 April 1992

Chapter 3

- 3-1 Johnson L H and Shoesmith D W**
 Spent Fuel.
 In: Radioactive Waste Forms for the Future, Eds.: W Lutze and R C Ewing, North-Holland Publ. Co. Amsterdam.
 1988
- 3-2 Forsyth R S and Werme L O**
 Spent fuel corrosion and dissolution.
 J. Nucl. Mater., in print.
 1992
- 3-3 Wilson C N**
 Results from NNWSI series 2 bare fuel dissolution tests.
 Pacific Northwest Laboratory Report PNL-7169, Richland WA.
 September 1990
- 3-4 Wilson C N**
 Results from NNWSI series 3 spent fuel dissolution tests.
 Pacific Northwest Laboratory Report PNL-7170, Richland WA.
 June 1990
- 3-5 Forsyth R S, Mattsson O and Schrire D**
 Fissionproduct concentration profiles (Sr, Xe, Cs and Nd) at the individual grain level in power-ramped LWR fuel.
 SKB Technical Report TR 88-24, Stockholm.
 March 1990
- 3-6 Forsyth R S, Werme L O and Bruno J**
 Preliminary study of spent UO₂ fuel corrosion in the presence of bentonite.
 J. Nucl. Mater. vol.160, p. 218.
 1988

- 3-7 Albinsson Y, Forsyth R S, Skarnemark G, Skålberg M, Torstenfelt B and Werme L**
Leaching/migration of UO₂ fuel in compacted bentonite.
Mat. Res. Soc. Symp. Proc. Vol. 176, p. 559.
1990
- 3-8 Werme L, Sellin P and Forsyth R**
Radiolytically induced oxidative dissolution of spent nuclear fuel.
SKB Technical Report TR 90-08, Stockholm.
May 1990
- 3-9 Shoesmith D W and Sunder S**
An electrochemistry-based model for the dissolution of UO₂.
SKB Technical Report TR 91-63, Stockholm.
December 1991
- 3-10 Finch R J and Ewing R C**
Alteration of natural UO₂ under oxidizing conditions from Shinkolobwe, Katanga, Zaire: A natural analogue for the corrosion of spent fuel.
Radiochimica Acta vol. 52/53, p. 395.
1991
- 3-11 Finch R J and Ewing R C**
Phase relations of the uranyl oxide hydrates and their relevance to the disposal of spent fuel.
Mat. Res. Soc. Symp. Proc. vol. 212, p. 241.
1991
- 3-12 Finch R J and Ewing R C**
Alteration of natural uranyl oxide hydrates in Si-rich groundwaters: Implications for uranium solubility.
Scientific Basis of Nuclear Waste Management XV, Materials Research Society, Pittsburg (in print).
1992

Chapter 4

- 4-1 The Swedish Corrosion Institute and its reference group**
Copper as canister material for unreprocessed nuclear waste – evaluation with respect to corrosion.
KBS Technical Report 90, Stockholm.
March 1978
- 4-2 The Swedish Corrosion Institute and its reference group**
Corrosion resistance of a copper canister for spent nuclear fuel.
SKBF/KBS Technical Report TR 83-24, Stockholm.
April 1983
- 4-3 Werme L O, Sellin P and Kjellbert N**
Copper canisters for nuclear high level waste disposal: Corrosion aspects.
SKB Technical Report TR 92-26, Stockholm.
October 1992

- 4-4 Fett T, Keller K and Munz D**
 Determination of crack growth parameters of alumina in 4-point bending tests.
 Nagra Technical Report 85-51, Baden, Switzerland.
 September 1985
- 4-5 Fett T, Hartlieb W, Keller K and Munz D**
 Subcritical crack growth in high-grade alumina for container applications.
 Nagra Technical Report 87-09, Baden, Switzerland.
 September 1987
- 4-6 Johnson L H, Shoemith D W, Ikeda B M and King F**
 Lifetimes of titanium and copper containers for the disposal of used fuel.
 Scientific Basis of Nuclear Waste Management XV, Materials Research
 Society, Pittsburg (in print).
- 4-7 Brookins D G**
 Eh-pH-Digrams for Geochemistry
 Springer-Verlag.
 1988
- 4-8 Grauer R**
 The reducibility of sulphuric acid and sulphate in aqueous solution (translated
 from German).
 SKB Technical Report TR 91-39, Stockholm.
 July 1991
- 4-9 Taxén C**
 Pitting corrosion under mildly oxidizing conditions.
 SKB Arbetsrapport AR 92-43, Stockholm.
 March 1992
- 4-10 Nilsson F (compiled by)**
 Mechanical integrity of canisters.
 SKB Technical Report (in print).
 1992
- 4-11 Henderson P J, Österberg J-O and Ivarsson B**
 Low temperature creep of copper intended for nuclear waste containers.
 SKB Technical Report 92-04, Stockholm.
 March 1992
- 4-12** See 2-15.

Chapter 5

- 5-1 Pusch R, Karnland O, Hökmark H, Sandén T, Börgesson L**
 Final Report of the Rock Sealing Project – Sealing Properties and Longevity of
 Smectite Clay Grouts.
 Stripa Project Technical Report 91-30, SKB, Stockholm.
 December 1991
- 5-2 Börgesson L**
 Interim report on the laboratory and theoretical work in modeling the drained
 and undrained behavior of buffer materials.
 SKB Technical Report TR 90-45, Stockholm.
 December 1990

- 5-3 Pusch R, Karnland O, Hökmark H**
 GMM – A general microstructural model for qualitative and quantitative studies of smectite clays.
 SKB Technical Report TR 90-43, Stockholm.
 December 1990
- 5-4 Karnland O, Pusch R**
 Development of clay characterization methods for use in repository design with application to a natural Ca bentonite clay containing a redox front.
 SKB Technical Report TR 90-42, Stockholm
 December 1990

Chapter 6

- 6-1 AGU, American Geophysical Union.**
 U.S. National Report to International Union of Geodesy and Geophysics, 1987-1990. Contributions in Hydrology. Twentieth General Assembly, IUGG, Vienna, Austria August 11-24.
 1991
- 6-2 Palmqvist K**
 Groundwater in crystalline bedrock.
 SKB Technical Report TR 90-41, Stockholm.
 1990
- 6-3 Larsson E**
 Two phase flow in the disturbed zone around a drift in rock.
 SKB Arbetsrapport (in print), Stockholm.
 1992
- 6-4 Pusch R**
 Alteration of the hydraulic conductivity of rock by tunnel excavation.
 Rock Mechanics and Mining Sciences, Vol. 26, No.1, pp. 71-83.
 Pergamon Press, New York.
 1989
- 6-5 Eliasson T**
 Red coloration of wall rock adjacent to fractures.
 SKB Arbetsrapport (in print), Stockholm.
 1992
- 6-6 Rehbinder G**
 Thermally induced flow of two immiscible stratified liquids in a porous body at a low Rayleigh number.
 Int. J. Heat and Fluid Flow, Vol. 13, No.2, June 1992. Butterworth Heinemann.
 1992
- 6-7 Nyberg G & Voss C**
 Problems in modelling groundwater systems in limited scale.
 SKB Arbetsrapport AR 91-10, Stockholm.
 1991
- 6-8 Ahlbom K, Äikäs T, Ericsson L O**
 SKB/TVO Ice age scenario.
 SKB Technical Report TR 91-32, Stockholm.
 1991

- 6-9 Vallander P, Eurenus J**
Impact of a repository on permafrost development during glaciation advance.
SKB Technical Report TR 91-53, Stockholm.
1991
- 6-10 Lindbom B, Boghammar A**
Exploratory calculations concerning the influence of glaciation and permafrost on the groundwater flow system, and initial study of permafrost influences at the Finnsjön site – a SKB 91 study.
SKB Technical Report TR 91-58, Stockholm.
1991
- 6-11 Boulton G S**
Proposed approach to time-dependent or "event-scenario" modelling of future glaciation in Sweden.
SKB, Arbetsrapport AR 91-27, Stockholm.
1991
- 6-12 Rosén L, Gustafson G**
A strategy for geoscientific classification for high-level waste repository localization.
SKB Technical Report (in print), Stockholm.
1992
- 6-13** SKB Annual Report, 1990.
SKB Technical Report TR 90-46, Stockholm.
1990
- 6-14** SKB Annual Report, 1991.
SKB Technical Report TR 91-64, Stockholm.
1991
- 6-15 de Marsily G**
Quantitative Hydrogeology, Groundwater Hydrology for Engineers.
Academic Press, Inc., Orlando, USA.
1986
- 6-16 Neretnieks I**
Solute transport in fractured rock – Applications to radionuclide waste repositories.
SKB Technical Report TR 90-38, Stockholm.
1990
- 6-17** See 1-7.
- 6-18 Gustafson G**
Äspö Hard Rock Laboratory. Modelling of the groundwater flow and transport of solutes during the construction phase.
SKB Technical Document TD 25-91-008, Stockholm.
1991
- 6-19 Axelsson C, et al.**
Discrete fracture modelling.
SKB, Äspö HRL Progress Report PR 25-89-21, Stockholm.
1990

- 6-20 Kung Chen Shan et al.**
Stochastic continuum simulation of mass arrival using a synthetic data set. The effect of hard and soft conditioning.
SKB Technical Report TR 92-18, Stockholm.
1992
- 6-21 Ericsson L O**
Fractal dimension for fracture generations with the Levy-Lee clustering modell, conceptual modelling of Äspö.
SKB, Äspö HRL Progress Report PR 25-90-16a (ed. M. Liedholm), Stockholm.
1991
- 6-22 Dershowitz W et al.**
The implication of fractal dimension in hydrology and rock mechanics.
SKB Technical Report TR 92-17, Stockholm.
1992
- 6-23 Bergman M et al.**
Utnyttjande av numeriska beräkningsmodeller för geoteknisk projektering av anläggningar i berg.
BeFo, Arbetsrapport från projekt 132, Stockholm.
1988
- 6-24 Tsang C F (Editor).**
Coupled processes associated with a nuclear waste repository.
Academic Press, San Diego, CA, USA.
1987
- 6-25 Tsang C F**
Coupled behaviour of joints.
Proceedings of ISRM Conference, Loen, Norway. Balkema.
1990
- 6-26 Rehbinder G**
2D & 3D simplified analysis founded upon the continuum approach and radial symmetry.
SKB Arbetsrapport (in print), Stockholm.
1992
- 6-27 SKI, Decovalex**
Decovalex. International co-operative project for the development of coupled models and their validation against experiments in nuclear waste isolation, Project Plan.
SKI, Progress Report, Stockholm.
1991
- 6-28 Larsson S-Å, Tullborg E-L**
Tectonics and paleostress regimes in the southern part of the Baltic Shield during the last 1200 Ma – a review.
SKB Technical Report (in print), Stockholm.
1992
- 6-29 Andreasson P-G, Rodhe A**
The Protogine Zone Geology and Mobility during the last 1.5 Ga.
SKB Technical Report (in print), Stockholm.
1992

- 6-30 Wannäs K O, Flodén T**
Tectonic framework of the Hanö Bay area, Southern Baltic Area.
SKB Technical Report (in print), Stockholm.
1992
- 6-31 Milnes A G, Gee D G**
Bedrock stability in the southeastern Sweden – evidence from fracturing in the Ordovician limestones of northern Öland.
SKB Technical Report (in print), Stockholm.
1992
- 6-32 Eronen M, Olander H**
On the world's ice ages and changing environments.
TVO Report YJT-90-13, Helsinki, Finland.
1990
- 6-33 Björk S, Svensson N-O**
Climatic change and uplift patterns-past, present and future.
SKB Technical Report (in print), Stockholm.
1992
- 6-34 Kuhla G**
Probability of expected climatic stresses in North America in the next one M.Y.
In Scott, Craig, Benson and Harwell (eds), A summary of FY-1978 consultant input for scenario methodology development. Pacific Northwest Laboratory of Batelle Memorial Inst, PNL-2851.
1979
- 6-35 Imbrie J, Imbrie J Z**
Modelling the climatic response to orbital variations.
Science, Vol. 207, pp. 943-953.
1980
- 6-36 Boulton G S, Payne A**
Simulation of past and prediction of future glaciation in Europe.
SKB Technical Report (in print), Stockholm.
1992
- 6-37 Rosengren L, Stephansson O**
Distinct element modelling of the rock mass response to glaciation at Finnsjön, central Sweden.
SKB Technical Report TR 90-40, Stockholm.
1990
- 6-38 Israelsson J, Rosengren L, Stephansson O**
Sensitivity study of rock mass response to glaciation at Finnsjön, central Sweden.
SKB Technical Report (in print), Stockholm.
1992
- 6-39 Påsse T**
Empirical estimation of isostatic uplift using the lake-tilting method at Lake Fegen and Lake Säven, southwestern Sweden.
Mathematical Geology, Vol. 22, No. 7, 1990.
1990

- 6-40 Bäckblom G, Stanfors R (Eds)**
 Interdisciplinary study of post-glacial faulting in the Lansjärv area, northern Sweden, 1986–1988.
 SKB Technical Report TR 89-31, Stockholm.
 1990
- 6-41 Lagerbäck R**
 Seismically deformed sediments in the Lansjärv area, northern Sweden.
 SKB Technical Report TR 91-17, Stockholm.
 1991
- 6-42 Stanfors R (Editor)**
 The Lansjärv excursion 1991 – Proceedings
 SKB Technical Report (in print), Stockholm.
 1992
- 6-43 Slunga R**
 The seismicity of southern Sweden, 1979–1984, final report.
 FOA Report C20578-T1, ISSN 0347-3694, Stockholm.
 1985
- 6-44 Slunga R, Nordgren L**
 Earthquake measurements in southern Sweden Oct 1, 1986 –
 Mar 31, 1987.
 SKB Technical Report TR 87-27, Stockholm.
 1987
- 6-45 Slunga R**
 Earthquake mechanisms in northern Sweden Oct 1987 – Apr 1988.
 SKB Technical Report TR 89-28, Stockholm.
 1989
- 6-46 Muir-Wood R**
 A review of the seismotectonics of Sweden.
 SKB Technical Report (in print), Stockholm.
 1992
- 6-47 Sakellariou M, et al.**
 Technical note. On the fractal character of rock surfaces.
 Int. J. Rock Mech. Min. Sci & Geomech Abstr. Vol 28, No. 6, pp. 527-533.
 Pergamon Press.
 1991
- 6-48 Maddock R, et al.**
 Direct fault dating trials at the Äspö Hard Rock Laboratory.
 SKB Technical Report (in print), Stockholm.
 1992

Chapter 7

- 7-1 Laaksoharju M**
 Measured and predicted groundwater chemistry at Äspö.
 SKB Progress Report PR 25-90-13, Stockholm.
 1990

- 7-2 Laaksoharju M**
Shallow groundwater chemistry at Laxemar, Äspö and Ävrö.
SKB Progress Report PR 25-88-04, Stockholm.
1988
- 7-3 Nilsson A-C**
Chemical characterization of deep groundwater on Äspö.
SKB Progress Report PR 25-89-14, Stockholm.
1989
- 7-4 Wikberg P (Editor), Gustafson G, Rhen I, Stanfors R**
Äspö Hard Rock Laboratory. Evaluation and conceptual modelling based on the pre-investigations 1986–1990.
SKB Technical Report TR 91-22, Stockholm.
1991
- 7-5 Wikberg P, Axelsen K, Fredlund F**
Deep groundwater Chemistry.
SKB Technical Report TR 87-07, Stockholm.
1987
- 7-6 Grenthe I, Stumm W, Laaksoharju M, Nilsson A-C, Wikberg P**
Redox potentials and redox reactions in deep groundwater systems.
Chemical Geology 98(1992)p 131–150.
1992
- 7-7 Pirhonen P, Pitkänen P**
Redox capacity of crystalline rocks. Laboratory studies under 100 bar oxygen gas pressure.
SKB Technical Report TR 91-55, Stockholm.
1991
- 7-8 Landström O, Tullborg E-L**
The influence of fracture mineral/groundwater interaction on the mobility of U, Th, REE and other trace elements.
SKB Technical Report TR 90-37, Stockholm.
1990
- 7-9 Tullborg E-L, Wallin B, Landström O**
Hydrogeochemical studies of fracture minerals from water conducting fractures and deep groundwaters at Äspö.
SKB Progress Report 25-90-01, Stockholm.
1991
- 7-10 Possnert G, Tullborg E-L**
Carbon-14 analyses of calcite coatings in open fractures from the Klipperås study site, southern Sweden.
SKB Technical Report TR 89-36, Stockholm.
1989
- 7-11 Possnert G, Tullborg E-L**
Carbon-14 analyses of calcite coatings in open fractures from borehole KAS05 at Äspö.
SKB Progress Report PR 92- (in print).

- 7-12 Wallin B**
Sulphur and oxygen isotope evidence from dissolved sulphates in groundwater and sulphide sulphur in fissure fillings at Äspö, southeastern Sweden.
SKB Progress Report PR 25-92-08, Stockholm.
1992
- 7-13 Nebot J, Bruno J**
The implications of soil acidification on a future high level waste repository.
Part I: The effect of increased weathering, erosion and deforestation
SKB Technical Report TR 91-45, Stockholm.
1991
- 7-14 Smellie J, Laaksoharju M**
The Äspö Hard Rock Laboratory.
Final evaluation of the hydrogeochemical pre-investigation in relation to existing geologic and hydraulic conditions.
SKB Technical Report TR 92-31, Stockholm.
1992
- 7-15 Bruno J and Sandino A**
The solubility of amorphous and crystalline schoepite in neutral to alkaline solutions.
Materials Research Society Symposium Proceedings Vol 127 (1989) p 871.
1989
- 7-16 Bruno J, Sandino A and Fredlund F**
The solubility of $(\text{UO}_2)_3(\text{PO}_4)_2 \cdot 4\text{H}_2\text{O}(\text{s})$ in neutral and alkaline media.
Migration-89 Symposium in Monterey, California, November 6-10.
1989
- 7-17 Bruno J, Grenthe I, Lagerman B**
On the $\text{UO}_2^{2+}/\text{U}^{4+}$ redox potential.
Acta Chemica Scandinavica 44 (1990) p 896-901.
1990
- 7-18 Grenthe I, Lagerman B**
Studies on metal carbonate equilibria 22. A coulometric study of the uranium (VI)-carbonate system, the composition of the mixed hydroxide carbonate species.
Acta Chemica Scandinavica 45 (1991) p 122-128.
1991
- 7-19 Grenthe I, Lagerman B**
Studies on metal carbonate equilibria 12. Complex formation in the Th(IV)- $\text{H}_2\text{O}-\text{CO}_2(\text{g})$ system. Acta Chemica Scandinavica 45 (1991), p 231-238.
1991
- 7-20 Lagerman B**
Complex formation in the actinoid- $\text{H}_2\text{O}-\text{CO}_2(\text{g})$ system. PhD thesis at Royal Institute of Technology, Stockholm, TRITA-OOK-1029.
1990
- 7-21 Bidogli G, Cavalli P, Grenthe I, Omenetto N, Pan Qi, Tanet G**
Studies on metal carbonate equilibria 21. Studies of the U(VI)- $\text{H}_2\text{O}-\text{CO}_2(\text{g})$ system by thermal lensing spectrophotometry.
Talanta 1991 38(1991) p 433-437.
1991

- 7-22 Engkvist I, Albinsson Y**
Hydrolysis studies of thorium using solvent extraction technique.
Radiochemica Acta (1992) (submitted).
1991
- 7-23 Puigdomènech I, Bruno J**
Plutonium solubilities.
SKB Technical Report TR 91-04, Stockholm.
1991
- 7-24 Eriksen T, Ndalamba P, Bruno J, Caceci M**
The solubility of $TcO_2 \cdot nH_2O$ in neutral to alkaline solutions under constant pCO_2 . Radiochemica Acta (1991) (submitted).
1991
- 7-25 Bruno J, Charlet L, Karthein R, Sandino A and Wersin P**
Adsorption, precipitation and co-precipitation of trace metals on carbonate minerals at low temperatures. Water Rock Interaction Symposium, WRI/-6. Ed. by Miles D L and Balkema, Rotterdam, Brookfield.
1989
- 7-26 Eriksen T, Daqing C**
On the interaction of granite with Tc(IV) and Tc(VII) in aqueous solution.
SKB Technical Report TR 91-47, Stockholm.
1991
- 7-27 Byegård J, Albinsson Y, Skarnemark G, Skålberg M**
Field and laboratory studies of the reduction and sorption of technetium (VII).
Radiochemica Acta (1992) (submitted).
1991
- 7-28 Pettersson J E, Ephraim J, Allard B, Borén H**
Characterization of humic substances from deep groundwaters in granitic bedrock in Sweden.
SKB Technical Report TR 90-29, Stockholm
1990
- 7-29 Pettersson C, Arsenie I, Ephraim J, Borén H, Allard B**
Properties of fulvic acids from deep groundwaters. Sci. Tot. Environ. Vol 81/82 (1989) p 287-296.
1989
- 7-30 Allard B, Arsenie I, Borén H, Ephraim J H, Gårdhammar G, Pettersson C**
Isolation and characterization of humics from natural waters.
SKB Technical Report TR 90-27, Stockholm.
1990
- 7-31 Ephraim J, Borén H, Pettersson C, Arsenie I, Allard B**
A novel description of the acid-base properties of an aqueous fulvic acid. Environmental Science and Technology Vol 23 (1989) p 356-362.
1989
- 7-32 Ephraim J H, Mathuthu A S, Marinsky J A**
Complex forming properties of natural organic acids. Part 2. Complexes with iron and calcium.
SKB Technical Report TR 90-28, Stockholm.
1990

- 7-33 Bidoglio G, Grenthe I, Pan Qi, Robuch P, Omenetto N**
Complexation of Eu and Tb with fulvic acids as studied by fine resolved laser induced fluorescence. *Talanta* 1991 38(1991), p 999-1008.
1991
- 7-34 Sätmark B, Albinsson Y**
Sorption of fission products on natural occurring mineral colloids and their stability. *Radiochemica Acta* (1992) (submitted).
1991
- 7-35 Ledin A, Karlsson S, Allard B**
Effects of pH, ionic strength and organic macromolecules on size distribution and surface charge of colloidal quartz and hematite. *Journal of Applied Geochemistry* (1992) (submitted).
1992
- 7-36 Pedersen K**
Deep groundwater microbiology in Swedish granitic rock and its relevance for radionuclide migration from a Swedish high level nuclear waste repository. SKB Technical Report TR 89-23, Stockholm.
1989
- 7-37 Pedersen K**
Potential effects of bacteria on radionuclide transport from a Swedish high level nuclear waste repository.
SKB Technical Report TR 90-05, Stockholm.
1991
- 7-38 Pedersen, K, Ekendahl S, Arlinger J**
Microbes in crystalline bedrock. Assimilation of CO₂ and introduced organic compounds by bacterial populations in groundwater from deep crystalline bedrock at Laxemar and Stripa.
SKB Technical Report TR 91-56, SKB, Stockholm.
1991
- 7-39 Pedersen K, Albinsson Y**
Possible effects of bacteria on trace element migration in crystalline bedrock. *Radiochemica Acta* 54 (1992) s 91-95.
1991
- 7-40 Pedersen K, Albinsson Y**
The effect from the number of cells, pH and lanthanide concentration on the sorption of promethium on gramnegative bacterium.
SKB Technical Report TR 90-26, Stockholm.
1990
- 7-41 Allard B, Karlsson F, Neretnieks I**
Concentrations of particulate matter and humic substances in deep groundwater and estimated effects on the adsorption and transport of radionuclides.
SKB Technical Report 90-50, Stockholm.
1991
- 7-42 Eriksen T and Locklund B**
Radionuclide sorption on crushed and intact granitic rock. Volume and surface effects.
SKB Technical Report TR 89-25, Stockholm.
1989

- 7-43 Albinsson Y**
Sorption of radionuclides in granitic rock.
SKB Report AR 91-07, Stockholm.
1991
- 7-44 Rundberg R S, Albinsson Y**
Carbonate adsorption on goethite as a function of pH and ionic strength.
Radiochemica Acta (1992) (submitted).
1992
- 7-45 Rundberg R S, Albinsson Y**
Neptunium adsorption on goethite and hematite as a function of pH.
Radiochemica Acta (1992) (submitted).
1992
- 7-46 Albinsson Y and Engkvist I**
Diffusion of Am, Pu, U, Np, Cs, I and Tc in compacted sand-bentonite mixture.
SKB Technical Report TR 89-22, Stockholm.
1989
- 7-47 Brandberg F, Skagius K**
Porosity, sorption and diffusivity data compiled for the SKB 91 study.
SKB Technical Report TR 91-16, Stockholm.
1991
- 7-48 Albinsson Y, Sätmark B**
Transport of actinides and Tc through a bentonite backfill containing small quantities of iron, copper or minerals in inert atmosphere.
SKB Technical Report TR 90-06, Stockholm.
1990
- 7-49 Andersson K, Allard B, Bengtsson M, Magnusson B**
Chemical composition of cement pore solutions. Cement Concrete Research
Vol 19 (1989) p 327-332.
1989
- 7-50 Wiborgh M, Markström A**
Compilation of potential chemical toxic elements in a copper canister containing HLW.
SKB Arbetsrapport AR 91-31, Stockholm.
1991
- 7-51** See 1-14.

Chapter 8

- 8-1 Schorscher H D, Shea M E**
The regional geology, mineralogy and geochemistry of the Poços de Caldas alkaline caldera complex, Minas Gerais, Brazil.
SKB Technical Report TR 90-10, Stockholm.
1990
- 8-2 Waber N, Schorscher H D, Peters T**
Mineralogy, petrology and geochemistry of the Poços de Caldas analogue study sites, Minas Gerais, Brazil. I: Osamu Utsumi uranium mine.
SKB Technical Report TR 90-11, Stockholm.
1990

- 8-3 Waber N**
Mineralogy, petrology and geochemistry of the Poços de Caldas analogue study sites, Minas Gerais, Brazil. II: Morro do Ferro.
SKB Technical Report TR 90-12, Stockholm.
1990
- 8-4 Shea M E**
Isotopic geochemical characterisation of selected nepheline syenites and phonolites from the Poços de Caldas alkaline complex, Minas Gerais, Brazil.
SKB Technical Report TR 90-13, Stockholm.
1990
- 8-5 Holmes D C, Pitty A E, Noy R**
Geomorphological and hydrogeological features of the Poços de Caldas caldera and the Osamu Utsumi mine and Morro do Ferro analogue study sites, Brazil.
SKB Technical Report TR 90-14, Stockholm.
1990
- 8-6 Nordstrom D K, Smellie J A T, Wolf M**
Chemical and isotopic composition of groundwaters and their seasonal variability at the Osamu Utsumi and Morro do Ferro analogue study sites, Poços de Caldas, Brazil.
SKB Technical Report TR 90-15, Stockholm.
1990
- 8-7 MacKenzie A B, Linsalata P, Miekeley N, Osmond J K, Curtis D B**
Natural radionuclide and stable element studies of rock samples from the Osamu Utsumi mine and Morro do Ferro analogue study sites, Poços de Caldas, Brazil.
SKB Technical Report TR 90-16, Stockholm.
1990
- 8-8 Miekeley N, Coutinho de Jesus O, Porto da Silveira C-L, Linsalata P, Andrews J N, Osmond J K**
Natural series nuclide and rare earth element geochemistry of waters from the Osamu Utsumi mine and Morro do Ferro analogue study sites. Poços de Caldas, Brazil.
SKB Technical Report TR 90-17, Stockholm.
1990
- 8-9 Miekeley N, Couthino de Jesus O, Porto da Silveira C-L, Degueudre C**
Chemical and physical characterisation of suspended particles and colloids in waters from the Osamu Utsumi mine and Morro do Ferro analogue study sites, Poços de Caldas, Brazil.
SKB Technical Report TR 90-18, Stockholm.
1990
- 8-10 West J, Vialta A, McKinley I G**
Microbiological analysis at the Osamu Utsumi mine and Morro do Ferro analogue study sites, Poços de Caldas, Brazil.
SKB Technical Report TR 90-19, Stockholm.
1990
- 8-11 Bruno J, Cross J E, Eikenberg J, McKinley I G, Read D, Sandino A, Sellin P**
Testing of geochemical models in the Poços de Caldas analogue study.
SKB Technical Report TR 90-20, Stockholm.
1990

- 8-12 Cross J, Haworth A, Lichtner P C, McKenzie A B, Moreno L, Neretnieks I, Nordstrom D K, Read D, Romero L, Sharland S M, Tweed C J**
Testing models of redox front migration and geochemistry at the Osamu Utsumi mine and Morro do Ferro analogue sites, Poços de Caldas, Brazil.
SKB Technical Report TR 90-21, Stockholm.
1990
- 8-13 Cathles L M, Shea M E**
Near-field high temperature transport: Evidence from the genesis of the Osamu Utsumi uranium mine analogue site, Poços de Caldas, Brazil.
SKB Technical Report TR 90-22, Stockholm.
1990
- 8-14 Nordstrom D L, Puigdomenech I, McNutt R H**
Geochemical modelling of water-rock interactions at the Osamu Utsumi mine and Morro do Ferro analogue sites, Poços de Caldas, Brazil.
SKB Technical Report TR 90-23, Stockholm.
1990
- 8-15 Romero L, Moreno L, Neretnieks I**
Modelling of the movement of the redox front in the uranium mine in Poços de Caldas, Brazil.
SKB Technical Report TR 90-39, Stockholm.
1990
- 8-16 Miekeley N, Kuchler I L**
Interactions between thorium and humic compounds in surface waters. *Inorg. Chim. Acta*, 140, 315-319.
1987
- 8-17 Miekeley N, Vale M G R, Porto da Silveira C L**
Determination of isotopic and total uranium at ultra-trace level in water by alpha-spectroscopy and micro-injection ICP-AES. *Inorg. Chim. Acta*, 140, 321-325.
1987
- 8-18 Zhu M**
Simulation of redox front movement in the Poços de Caldas mine. In: Some aspects of modelling of the migration of chemical species in groundwater systems. Licentiate Thesis (January 1988). Royal Institute of Technology, Dept. Chem. Eng., Stockholm.
1988
- 8-19 Miekeley N, Jesus H C, da Silveira C L P, Kuechler I L**
Colloid Investigations in the Poços de Caldas Natural Analogue Project. Presented at the Twelfth International Symposium on the Scientific Basis for Nuclear Waste Management (MRS). October 10-13, Berlin, p 831-842.
1988
- 8-20 Smellie J A T, Chapman N A, McKinley I G, Penna Franca E, Shea M**
Testing Safety Assessment Models Using Natural Analogues in High Natural-series Groundwaters; a Progress Report on the Second Year of the Poços de Caldas Project. Presented at the Twelfth International Symposium on the Scientific Basis for Nuclear Waste Management. (MRS) October 10-13, Berlin, p 863-870.
1988

- 8-21 West J M, Vialta A, McKinely I G**
The Influence of Microbial Activity on the Movement of Uranium at the Osamu Utsumi Mine, Poços de Caldas, Brazil. Presented at the Twelfth International Symposium on the Scientific Basis for Nuclear Waste Management. (MRS) October 10-13, Berlin, p 771-777.
1988
- 8-22 Coutinho de Jesus**
Desequilíbrios radioactivos em aguas e rochas e outros aspectos geoquimicos da mina de uranio "Osamu Utsumi" e do deposito torifero "Morro do Ferro", Poços de Caldas, M.G.M.Sc. Thesis. Pontifical Universidade Catholica do Rio de Janeiro (PUC).
1989
- 8-23 Cross J, Haworth A, Neretnieks I, Sharland S M, Tweed C J**
Modelling of redox front movement in a uranium mine at Poços de Caldas. Presented at the Migration 89 Symposium in Monterey, California, November 6-10.
1989
- 8-24 Nyman C, Ozolins V, Moreno L, Neretnieks I**
Development of a model for handling the movement of redox fronts and other sharp reaction fronts. In the Fifteenth International Symposium on the Scientific Basis for Nuclear Waste Management (MRS), November 4-8, Strasbourg.
1991
- 8-25 Waber N**
Behaviour of thorium and light rare earth elements during lateritic weathering of the Th-REE deposit at Morro do Ferro, Poços de Caldas, Brazil. In Chemistry and Migration Behaviour of Actinides and Fission Products in the Geosphere, Jerez de La Frontera, 21-25 October.
1991
- 8-26 Romero L, Neretnieks I, Moreno L**
Movement of the redox front at a uranium mine at Poços de Caldas. In the Fifteenth International Symposium on the Scientific Basis for Nuclear Waste Management (MRS).
November 4-8, Strasbourg.
1991
- 8-27 Cross J E, Gabriel D S, Haworth, Neretnieks I, Sharland S M, Tweed C J**
Modelling of redox front and uranium movement in a uranium mine at Poços de Caldas, Brazil. Harwell Report NSS/R252, AEA D&R 0081, Oxon, Didcot, UK.
1991
- 8-28 Chapman N A, McKinley I G, Shea M E, Smellie J A T**
The Poços de Caldas Project: Summary and implications for radioactive waste management.
SKB Technical Report TR 90-24, Stockholm.
1990
- 8-29 Lichtner P**
The quasi-stationary state approximation to coupled mass transport and fluid rock interactions in a porous medium. *Geochimica Cosmochimica Acta* 52 (1988), p 143-165.
1988

- 8-30** Cigar Lake Project, Annual Report of the AECL/SKB Cigar Lake Project. Phase 1: 1989-1990, AECL, Pinawa.
1990
- 8-31** Cigar Lake Project, Second Annual Report of the AECL/SKB Cigar Lake Project. Year 2, 1990-1991, AECL, Pinawa.
1991
- 8-32 Naudet R**
Oklo: Des reacteurs nucléaires fossiles. Eyrolles, Paris.
1991
- 8-33 Tweed D J, Linklater C M, Eikenberg J, Alexander W R, Dayal R, Eagleson K, Miledowski A E and Khoury H N**
A natural analogue of high pH cement pore waters from the Maqarin area of northern Jordan: Comparison of predicted and observed trace element chemistry. In Migration 91, Third International Conference in Jerez de la Frontera, October 21-25.
1991

Chapter 9

- 9-1** R&D-Programme 89. Handling and final disposal of nuclear waste. Programme for research, development and other measures.
SKB, Stockholm.
September 1989.
- 9-2 Almén, K-E and Zellman, O**
Äspö Hard Rock Laboratory. Field Investigation Methodology and Instruments used in the Preinvestigation phase, 1986–1990.
SKB Technical Report TR 91-21, Stockholm.
1991
- 9-3** See 1-14.
- 9-4 Ljunggren C och Norman R**
Kärnborring med omvänd spolning. Etapp 2B. Fullskaleförsök.
SKB Arbetsrapport AR 92-44, Stockholm.
1992
- 9-5 Falk L**
Directional Borehole Antenna – Theory.
Stripa Project Technical Report 92-16, SKB, Stockholm.
1992
- 9-6 Cosma C, Heikkinen P and Pekonen S**
Improvement of High Resolution Borehole Seismics. Part I, Development of Processing Methods for VSP Surveys. Part II, Piezoelectric Signal Transmitter for Seismic Measurements.
Stripa Project Technical Report 91-13, SKB, Stockholm.
1991

- 9-7 Heikkinen E, Salesa P and Hinkkanen H (Editors)**
Geophysical Investigations in the Veitsivaara Area, Finland. Summary Report. YJT-91-20. Finland.
1991
- 9-8 Wikberg P, Gustafsson G, Rhén I and Stanfors R**
Äspö Hard Rock Laboratory. Evaluation and Conceptual Modelling Based on the Pre-investigations 1986–1990
SKB Technical Report TR 91-22, Stockholm.
1991
- 9-9 Svensson U, Andersson J-E, Andersson P, Eriksson K-O, Gustafsson E, Ittner T, Nordqvist R and Rhén I**
Long-Term Pumping and Tracer Test (LPT-2) in Boreholes KAS06. Numerical Prediction, Evaluation and Validation of Groundwater Flow and Transport.
SKB Technical Report (in print).
1992
- 9-10 Gustafsson E, Andersson P and Nordqvist R**
Radially Converging Tracer Experiment in a Low Angle Fracture Zone at the Finnsjö Site, Central Sweden. The Fracture Zone Project, Phase 3.
SKB Technical Report (in print).
1992
- 9-11 Birgersson L and Ågren T**
Site Characterization and Validation Drift, Report 1: Instrumentation, Site Preparation and Tracers.
Stripa Project Technical Report 92-02, SKB, Stockholm.
January 1992
- 9-12 Andersson P, Andersson P, Gustafsson E and Olsson O**
Investigation of Flow Distribution in a Fracture Zone at the Stripa Mine, Using the Radar Methods. Results and Interpretation.
SKB Technical Report TR 89-33, Stockholm.
1989
- 9-13 Christiansson R and Stenberg L**
Manual for the Field Work in the Tunnel. Documentation of the Geological, Hydrogeological and Groundwater Chemistry Conditions in the Access Tunnel.
SKB Progress Report PR 25-91-10, Stockholm.
1991
- 9-14 Stanfors R (Editor)**
Evaluation of Geological Predictions in the Access Ramp 0-0/700 meters.
SKB Progress Report PR 25-92-02, Stockholm.
1991
- 9-15 Almén K-E and Johansson B**
The Hydro Monitoring System (HMS) of the Äspö Hard Rock Laboratory.
SKB Progress Report PR 25-92-09, Stockholm (in print).
1992
- 9-16 See 2-1.**

Chapter 10

- 10-1 Axelsson C-L, Byström J, Eriksson Å, Holmien J, Mjatema H M**
Hydraulic Evaluation of the ground water conditions at Finnsjön. The effects on dilution in a domestic well.
SKB Technical Report TR 91-54, Stockholm.
1991
- 10-2 Elert M and Argärde A-C**
Modelling of the interface between the geosphere and the biosphere – Discharge through a sediment layer. Project SSI P295-84.
Swedish National Institute of Radiation Protection, Stockholm, Sweden.
1985
- 10-3 Elert M, Argärde A-C and Ericsson A-M**
Modelling of the interface between the geosphere and the biosphere – Discharge through a soil layer.
Kemakta AR 88-23. Swedish National Institute of Radiation Protection, Stockholm, Sweden.
1988
- 10-4 Sundblad B, Puigdomenech I, Mathiasson**
Interaction between geosphere and biosphere in lake sediments.
SKB Technical Report TR 91-40, Stockholm.
1992
- 10-5 Hoffman F O**
Conclusions of BIOMOVS phase 1
Proc from "The validity of environmental transfer models BIOMOVS", October 8-10, 1990, Swedish Radiation Protection Institute, Stockholm, Sweden.
- 10-6 Landström O, Sundblad B**
Migration of Thorium, Uranium, Radium and ¹³⁷Cs in till soils and their uptake in organic matter and peat.
SKB Technical Report TR 86-24, Stockholm.
1986
- 10-7 Bernardt G P, Randall D B and Hess C T**
137-Cs in wood ash within the state of maine.
Health Physics v 62 no 6.
June 1992
- 10-8 Jantunen M J, Reponen A, Mustonen R, Itkonen A and Kauranen P**
Behavior of Chernobyl fallout radionuclides in peat combustion.
Health Phys.62(3):245-249.
March 1992
- 10-9 Bergström U and Nordlinder S**
Uncertainties Related to Dose Assesment for High Level Waste Disposal.
Nuclear Safety Vol 32 No 3.
July-September 1991
- 10-10 Dames and Moore**
Report of a seminar on Natural environment change.
UKDOE rep no DOE/RW/89.029.
January 1989

10-11 Thorne M C

The biosphere; current status.
Electrowatt engineering services (UK) LTD West Sussex HL89/1085.
June 1988

10-12 Andersson J (Editor)

The joint SKI/SKB scenario development project.
SKB Technical Report TR 89-35, Stockholm.
1989

10-13 Evans S

Quantitative estimates of sedimentation rates and sediment growth in two Swedish lakes.
SKB Technical Report TR 86-29, Stockholm.
1986

10-14 Sundblad B

Recipient evolution – transport and distribution of elements in the lake Sibbo-Trobbofjärden area.
SKB Technical Report TR 86-30, Stockholm.
1986

10-15 Andersson K

Water composition in the lake Sibbofjärden, lake Trobbofjärden area.
SKB Technical Report TR 87-30, Stockholm.
1987

10-16 Bergström U, Evans S, Puigdomenech I, Sundblad B

Long-term dynamics of a lake ecosystem and the implications for radiation exposure.
SKB Technical Report TR 88-31, Stockholm.
September 1988

10-17 Smith G

Scenario B5; Ageing of a Lake.
BIOMOVS Technical Report 5 National Institute of Radiation Protection, Stockholm, Sweden.
May 1989

10-18 Gustavsson E, Skålberg M, Sundblad B, Karlberg O, Tullborg E-L, Ittner T, Carbol P, Eriksson N and Lampe S

Radionuclide deposition and migration within the Gideå and Finnsjön study sites, Sweden: A study of the fallout after the Chernobyl accident. Phase I, initial survey.
SKB Technical Report TR 87-28, Stockholm.
1987

10-19 Carbol P, Ittner T and Skålberg M

Radionuclide Deposition and Migration of the Chernobyl fallout in Sweden.
Radiochimica Acta 44/45,207-212.
1988

- 10-20 Ittner T**
 Long term sampling and measuring program. Joint report for 1987, 1988 and 1989. Within the project: Fallout studies in the Gideå and Finnsjö areas after the Chernobyl accident in 1986.
 SKB Technical Report TR 91-09, Stockholm.
 December 1990
- 10-21 Ittner T**
 Surface mapping of the Gideå area.
 SKB Technical Report TR 91-29, Stockholm.
 1991
- 10-22 Ittner T, Tammela P-T and Gustavsson E**
 Soil map, area and volume calculations in Orrmyrberget catchment basin at Gideå, Northern Sweden.
 SKB Technical Report TR 91-29, Stockholm.
 June 1991
- 10-23 Ittner T, Gustavsson E and Nordqvist R**
 Radionuclide content in surface and groundwater transformed into breakthrough curves. A Chernobyl fallout study in a forested area of northern Sweden.
 SKB Technical Report TR 91-28, Stockholm.
 1991
- 10-24 Nordqvist R, Gustavsson E and Ittner T**
 Transport of the Chernobyl fallout in soil and bedrock – A field study.
 Applied Geochemistry (in print).
 1991
- 10-25 Landström et al.**
 Migration experiments in Studsvik.
 SKBF/KBS Technical Report TR 83-18, Stockholm.
 January 1981
- 10-26 Abelin H, Neretniks I, Tunbrant S and Moreno L**
 Final report of the Migration in a single fracture – experimental results and evaluation.
 Stripa Project Technical Report 85-03, SKB, Stockholm.
 May 1985
- 10-27 Nilsson S, Ittner T, Carbol P, Gustafsson E, Mathiasson L, Nordqvist R, Skarnemark G, Skålberg M, Sundblad B**
 A Chernobyl fallout redistribution study in a forested catchment area in northern Sweden.
 Sci. Tot. Environment, to be published.
- 10-28 Carbol P, Skålberg M and Skarnemark G**
 Speciation of the Chernobyl fallout by sequential chemical separation. Science of the total environment (in print).
 1992
- 10-29 Carbol P, Skålberg M and Skarnemark G**
 Chemical speciation of radionuclides originating from the Chernobyl fallout – Gideå study site – V. Science of the total environment (in print).
 1992

- 10-30 Skålberg M, Carbol P, Gustavsson E, Ittner T, Mathiasson L, Skarnemark G, Sundblad B**
The Gideå study site – Area description and deposition pattern of the Chernobyl fallout.
Sci. Tot. Environment, to be published.
1992
- 10-31 Strand P, Selnaes T D and Reitan J B**
Area and time distribution of external and internal doses from Chernobyl fallout the lack of correlation in Norway. Health physics v 62 no 6.
June 1992
- 10-32 Whicker F W**
Scenario B8; The relative importance of ingestion for multiple pathway dose assessments. BIOMOVS Technical Report 11 National Institute of Radiation Protection, Stockholm, Sweden.
Sept 1990
- 10-33** See 6-17.
- 10-34 Grogan H A**
Scenario B2 Irrigation with Contaminated Groundwater. BIOMOVS Technical Report 6 National Institute of Radiation Protection, Stockholm, Sweden.
1989
- 10-35 Bergström U and Nordlinder S**
Individual radiation doses from unit releases of long lived radionuclides.
SKB Technical Report TR 90-09, Stockholm.
April 1990
- 10-36 Bergstrom U, Nordlinder B**
Individual doses from radionuclides released to the Baltic coast.
SKB Technical Report TR 91-41, Stockholm.
1991
- 10-37 ICRP**
Age-dependent Doses to members of the public from intake of radionuclides.
Annals of the ICRP. ICRP publ no 56, Pergamon press.
1990
- 10-38 ICRP**
Limits for intake of radionuclides by workers.
Annals of the ICRP. ICRP publ no 30, Pergamon press.
1982
- 10-39 Wrenn M R**
Is thorium really more radiotoxic than plutonium.
Health physics v62 no 6 pp s 39.
June 1992
- 10-40 Sundblad B, Mathiasson L, Holby O, Landström O, Lampe S**
Chemistry of soil and sediments, hydrology and natural exposure rate measurements at the Äspö hard rock laboratory.
SKB Progress Report PR 25-91-08, Stockholm.
1991

10-41 Zeevaert T and Jones C

Transfer from the geosphere to the biosphere through two different receptor types.

Proc from "The validity of environmental transfer models BIOMOVs", October 8-10, 1990, Swedish Radiation Protection Institute, Stockholm, Sweden.

10-42 Nordlinder S and Bergström U

A dynamic model of the Cs-137 concentration in fish applied to seven different lake ecosystems – a VAMP scenario. Presented at the 6th Nordic Radioecological seminar, Torshavn Faroe Islands 14-18 June 1992.

Studsvik report NS-92/44.

1992

10-43 NEA PSAC User Group, PSACOIN level 1b Intercomparison.

NEA/OECD, Paris.

1992

10-44 IAEA

Effects on ionizing radiation on plants and animals at level implied by current radiation standards.

Technical report series no 332, IAEA, Vienna.

1992.

10-45 IAEA

Assessing the impact of deep sea disposal of low level waste on living marine resources.

Technical report series no 288, IAEA Vienna.

1988

Chapter 11

11-1 See 1-10.

11-2 Juhlin C, Sandstedt H

Storage of nuclear waste in very deep boreholes.

SKB Technical Report TR 89-39, Stockholm.

1989

11-3 Sandstedt H, Wickman C, Pusch R, Börgesson L, Lönnerberg B

Storage of nuclear waste in long boreholes.

SKB Technical Report TR 91-35, Stockholm.

1991

11-4 See 2-15.

11-5 See 1-7.

11-6 Äspörampen. Föredrag på Bergmekanikdagen 1992.

11-7 Pusch R

Influence of various excavation techniques on the structure and physical properties of "near field" rock around large boreholes.

SKB Technical Report TR 89-32, Stockholm.

1989

- 11-8 Autio J**
Description of Tamrock equipment for boring vertical deposition holes.
SKB Arbetsrapport AR 92-40, Stockholm.
1992
- 11-9 Pusch R et al.**
Sealing Project Executive Summary and General Conclusions of the Rock
Sealing Project.
Stripa Project Technical Report 92-27, SKB, Stockholm.
1992
- 11-10 Pusch R, Börgesson L**
Final Report of the Buffer Mass Test – Volume II: test results.
Stripa Project Technical Report 85-12, SKB, Stockholm.
1985
- 11-11 Pusch R, Börgesson L, Ramqvist G**
Final Report of the Borehole, Shaft and Tunnel Sealing Test – Volume II: Shaft
plugging.
Stripa Project Technical Report 87-07, SKB, Stockholm.
1987
- 11-12 Pusch R, Börgesson L, Ramqvist G**
Final Report of the Borehole, Shaft and Tunnel Sealing Test – Volume III:
Tunnel plugging.
Stripa Project Technical Report 87-03, SKB, Stockholm.
1987
- 11-13 Pusch R, Börgesson L, Ramqvist G**
Final Report of the Borehole, Shaft and Tunnel Sealing Test – Volume I:
Borehole plugging.
Stripa Project Technical Report 87-01, SKB, Stockholm.
1987