

SKB

**TECHNICAL
REPORT**

92-28

**A rock mechanics study of fracture
zone 2 at the Finnsjön site**

Bengt Leijon¹, Christer Ljunggren²

1 Conterra AB
2 Renco AB

January 1992

A ROCK MECHANICS STUDY OF FRACTURE ZONE 2 AT THE
FINNSJÖN SITE

Bengt Leijon¹, Christer Ljunggren²

1 Conterra AB

2 Renco AB

January 1992

This report concerns a study which was conducted for SKB. The conclusions and viewpoints presented in the report are those of the author(s) and do not necessarily coincide with those of the client.

Information on SKB technical reports from 1977-1978 (TR 121), 1979 (TR 79-28), 1980 (TR 80-26), 1981 (TR 81-17), 1982 (TR 82-28), 1983 (TR 83-77), 1984 (TR 85-01), 1985 (TR 85-20), 1986 (TR 86-31), 1987 (TR 87-33), 1988 (TR 88-32), 1989 (TR 89-40), 1990 (TR 90-46) and 1991 (TR 91-64) is available through SKB.

**A ROCK MECHANICS STUDY OF FRACTURE
ZONE 2 AT THE FINNSJÖN SITE**

Bengt Leijon
CONTERRA AB

Christer Ljunggren
RENCO AB

January 1992

ABSTRACT

Comprehensive field investigations at the Finnsjön study site have revealed a subhorizontal fracture zone, termed Zone 2, that exhibits anomalous characteristics in terms of high hydraulic conductivity, governing the groundwater transport pattern on a regional scale. The present study provides an assessment of the mechanical characteristics of Zone 2. Thus, estimates of the deformational characteristics of the zone, based on available borehole information, show that the zone forms a diffuse and rather moderate mechanical contrast to the surrounding bedrock. As also verified by stress measurement results, major stress anomalies attributable to the zone are therefore not to be expected. Bound estimates of stress conditions during periods of glaciation and deglaciation are also derived, and possible impacts of these loadings on the fracture zone are discussed. It is concluded that glaciation represents stable conditions, whilst the complex loading mechanisms encountered during deglaciation may trigger re-activation of structures at shallow depth. Taking the above results as an example, implications of a feature like Zone 2 on the integrity of a hypothetical repository are discussed in more general terms. Considering the likely spatial extension of the mechanical disturbances related to the repository excavations and the fracture zone respectively, it is suggested that a mutual distance of the order of one hundred metres is sufficient to avoid mechanical interaction.

SUMMARY

In recent years, the potential impact of gently dipping fracture zones on repository performance has drawn increasing attention. This is because data now available indicate that such zones may be more frequent, and more conductive to water, than previously thought. These indications are strongly supported by results gained from investigations at the Finnsjön site in east-central Sweden, a region dominated by early precambrian foliated granitoids. At this site, a number of large-scale fracture zones have been identified and characterized. A subhorizontal fracture zone at about 200 m depth, referred to as Zone 2, has been found to exhibit anomalous characteristics in terms of high hydraulic conductivity, governing the groundwater transport patterns on a regional scale.

The present study intends to provide complementary information on certain geomechanical aspects related to Zone 2, that may have implications with respect to its hydrogeological characteristics. Estimates are provided for the site specific stress conditions, and for the deformational characteristics of the fracture zone. These estimates forms the basis for discussing the mechanical behaviour of the zone from a conceptual viewpoint, and also for addressing the more general question of potential interaction between a feature like Zone 2 and a hypothetical repository. Mechanical conditions during periods of glaciation and deglaciation are also discussed.

The overall conceptual appreciation of Zone 2 as a mechanical system component, is that it forms an integrated part of the rock mass, rather than a discrete feature. In fact, distinguishing a lower boundary of the zone finds no support in the data available. The zone is characterized by mechanical properties that differs moderately from those of the surrounding rock mass. Results obtained using several methods to estimate the in-situ deformation modulus of Zone 2 show

values that fall roughly in the interval 20-50% of the values for the rock mass outside the zone.

Given the current stress field as determined by measurements at Finnsjön, it is not likely that Zone 2 creates any major stress anomaly on a larger scale. This is a consequence of its mechanically diffuse nature and the lack of sharp contrast in deformational characteristics with respect to the neighbouring bedrock. A further conclusion related to the current stress conditions is that the stress anisotropy found can not contribute much in explaining the very high water transmissivity recorded within the zone.

Stress anomalies in the proximity of fracture zones are of concern also with respect to selecting criteria for the minimum distance between fracture zones and repository excavations. A brief survey of the forms of mechanical disturbances to be expected from the relatively small excavations being considered, shows that these are confined to the excavation near-field. Thus, to avoid mechanical interaction between a fracture zone like Zone 2 - inducing only very local disturbances of the stress field - and an hypothetical repository excavation, it is suggested that a minimum distance of about 100 m would be sufficient. The other mechanical perturbation imposed by a repository is the thermomechanical stress field. This will develop successively over a long period of time (thousands of years) and ultimately involve a very large rock volume. Interaction with large-scale features like fracture zones will therefore inevitably occur. The current understanding, also supported by this study, is that interaction will not be significant with respect to repository integrity, but more work in this area would be recommended.

Stress changes imposed by glaciation represent the most significant source of natural change in mechanical loading conditions that may be expected during repository lifetime. Estimates of stress conditions during periods of glaciation

and deglaciation have therefore been derived, to evaluate possible impact on structures like Zone 2. Vertical stress can be estimated with some confidence, and stress magnitudes are simply proportional to the thickness of the overlying ice sheet. Horizontal stresses are more difficult to predict, because there are uncertainties as to the generating mechanisms. Estimates of horizontal stress at depth of 250 m (corresponding to Zone 2) spans the approximate interval 20-35 MPa. The upper bound estimate assumes development of horizontal creep deformations during glaciation, as a consequence of the excessive vertical stress. Stress conditions during glaciation correspond to increased confinement in all directions, which interlocks structures thus prohibiting shear movements. Glaciation periods are therefore characterized by stable conditions.

In contrast to glaciation, deglaciation periods are characterized by a complex and rapid sequence of stress changes. A number of more or less quantifiable loading mechanisms can be identified, including:

- Rapid unloading of vertical stress. This occurs concurrently with decrease of ice sheet thickness.
- Unloading of induced horizontal stress. This process is not well understood and may involve creep effects, that would imply periods of large stress anisotropy which translates into large shear stresses.
- Local stress concentrations near retreating ice margins.
- Excessive pore water pressures in discontinuities. This can result from meltwater beneath the ice or in ice lakes and fractures, being hydraulically interconnected to the bedrock groundwater.

It is conceivable that the complex interaction of these loadings triggers reactivation and permanent changes of structures at shallow depth (such as Zone 2). Modes of deformation that can be envisaged include:

- Opening-up of gently dipping fractures due to drastically decreased normal (vertical) stress, possibly assisted by excessive water pressures.
- Shear displacements initiated by increased deviatoric stresses and possibly assisted by excessive water pressures.
- Reactivation of subhorizontal, extension-type fractures commonly referred to as sheet-fractures.

It is thus concluded that deglaciation periods are critical with regard to the mechanical and hydraulic characteristics of Zone 2, as observed today, and with regard to potential changes during repository lifetime. Further research, aimed at quantifying loading mechanisms involved as well as rock mass response would be recommended.

TABLE OF CONTENTS

	<u>Page</u>
1 INTRODUCTION	1
1.1 Background	1
1.2 Scope	2
2 THE FINNSJÖN STUDY SITE AND FRACTURE ZONE 2	4
3 ROCK STRESS CONDITIONS	9
3.1 Time scale	9
3.2 Present stress conditions	10
3.3 Glaciation	14
3.4 Deglaciation	17
3.5 Pore water pressure during glaciation and deglaciation	19
4 DEFORMATIONAL CHARACTERISTICS OF FRACTURE ZONE 2	21
4.1 General	21
4.2 RQD to estimate in-situ deformation modulus	22
4.3 The Q-system to estimate in-situ deformation modulus	24
4.4 JRC and JCS to estimate in-situ deformation modulus	28
4.5 Summary	34
5 MECHANICAL CONCEPTUALIZATION OF ZONE 2	36
6 RESPONSE OF ZONE 2 TO DIFFERENT LOADINGS	40
6.1 Present conditions	40
6.2 Glaciation	42
6.3 Deglaciation	44
6.3.1 Vertical unloading of gravitational stress	44
6.3.2 Induced horizontal stresses	45
6.3.3 Excessive water pressures	47
6.3.4 Local stress concentrations at the ice front	47

(cont.)

	<u>Page</u>
6.4 Geological evidences	48
6.5 Loadings from a hypothetical repository	50
6.5.1 Interference with excavations	51
6.5.2 Interference with thermal stress field	55
7 HYDROMECHANICAL CONDITIONS	57
7.1 Present conditions	57
7.2 Glaciation and deglaciation	60
8 CONCLUDING REMARKS	61
9 REFERENCES	66

1 INTRODUCTION

1.1 Background

Excluding rock masses accessed by excavations, the Finnsjön site in east-central Sweden probably hosts one of the most comprehensively investigated rock masses in the world. Surface- and subsurface investigations at the site was initiated more than ten years ago, as part of a study site investigation programme aimed at demonstrating the feasibility of selected Swedish crystalline rock formations as host media for HLW (high level waste) disposal. Later, the Finnsjön study site, composed of a 1.8 Ga old foliated granodiorite has been utilized for more fundamental research in geology, hydrogeology, geochemistry and geophysics, all with reference to nuclear waste disposal.

One of the research objectives has been to quantify relevant characteristics of major fracture zones, of which a number have been identified and investigated at Finnsjön. Interest has successively been focused on a subhorizontal fracture zone at about 200 m depth, referred to as Zone 2. Results from geohydrological and geochemical investigations have shown that this particular zone possesses anomalous characteristics in terms of high hydraulic conductivity of certain sub-structures within the zone. This exerts a governing influence on site hydrogeology on a regional scale, and it appears that the zone constitutes the interface between mobile, non-saline groundwater above it, and stagnant saline water below it.

Interest for the role of subhorizontal fracture zones has been further enhanced by results from other investigations, indicating that they may be more frequent than previously believed, and that the unexpectedly high permeability may not be a peculiarity of Zone 2, but perhaps a typical characteristic of gently dipping zones. In conclusion, subhorizontal fracture zones are important - potentially favourable - fea-

tures to consider in the process of repository site selection and performance evaluation.

1.2 Scope

The present study addresses the geomechanical characteristics of Zone 2. On the basis of the site-specific geomechanical information available on Zone 2, factors and processes that have relevance, directly or indirectly, with respect to repository siting and performance are also discussed in more general terms. More specifically, the questions that emerged during the process of work definition, and found relevant to consider were:

- (1) On the basis of available data - can the large-scale mechanical characteristics of the zone be quantified/estimated, especially in relation to the host rock?
- (2) What are the current rock stress conditions within the volume of rock investigated?
- (3) Given estimates of boundary stress conditions and mechanical properties, what are the mechanical system impacts of Zone 2?
- (4) What conclusions can then be drawn as regards desirable, minimum distances between such a zone and a hypothetical repository?
- (5) Glaciation can significantly alter rock stress conditions during repository lifetime. What estimates can be given of stress conditions during the periods of glaciation and deglaciation, and, what may be the response of Zone 2 to these loadings?
- (6) Certain horizons of the zone exhibit very high hydraulic conductivity, as compared to the normal range of values

for otherwise similar fracture zones. Are there explanations for this in terms of current stress field, or stress conditions experienced by these structures during late glaciations?

It has been attempted to penetrate these questions in a systematic manner. Geomechanical behaviour of large rock masses is inherently complex. Comprehensive analysis of the problems outlined above would therefore demand thorough parameter quantification and application of elaborate theories and models. This has however not been within the scope of the present study. The work has instead aimed at developing a conceptual but still correct understanding of the parameters and processes discussed.

Consequently, the report is neither meant to provide any detailed, quantitative analysis results, nor any far-reaching interpretations. It is meant to be a worthwhile contribution in terms of bracketing parameters of concern and developing a principally correct understanding of the mechanics involved.

2 THE FINNSJÖN STUDY SITE AND ZONE 2

The Finnsjön study site is located in northern Uppland, central Sweden, Fig. 2.1. The geology and hydrogeology of the bedrock was investigated during the years 1977-1982 within the site selection studies for a repository for spent nuclear fuel, (Olkiewicz et al., 1979; Carlsson et al., 1980; Carlsson and Gidlund, 1983). Later, in 1985, a second phase was initiated, focusing on detailed investigation of the sub-horizontal fracture zone, (Zone 2). Below is summarized the current geoscientific knowledge of the Finnsjön study site and fracture zone 2.

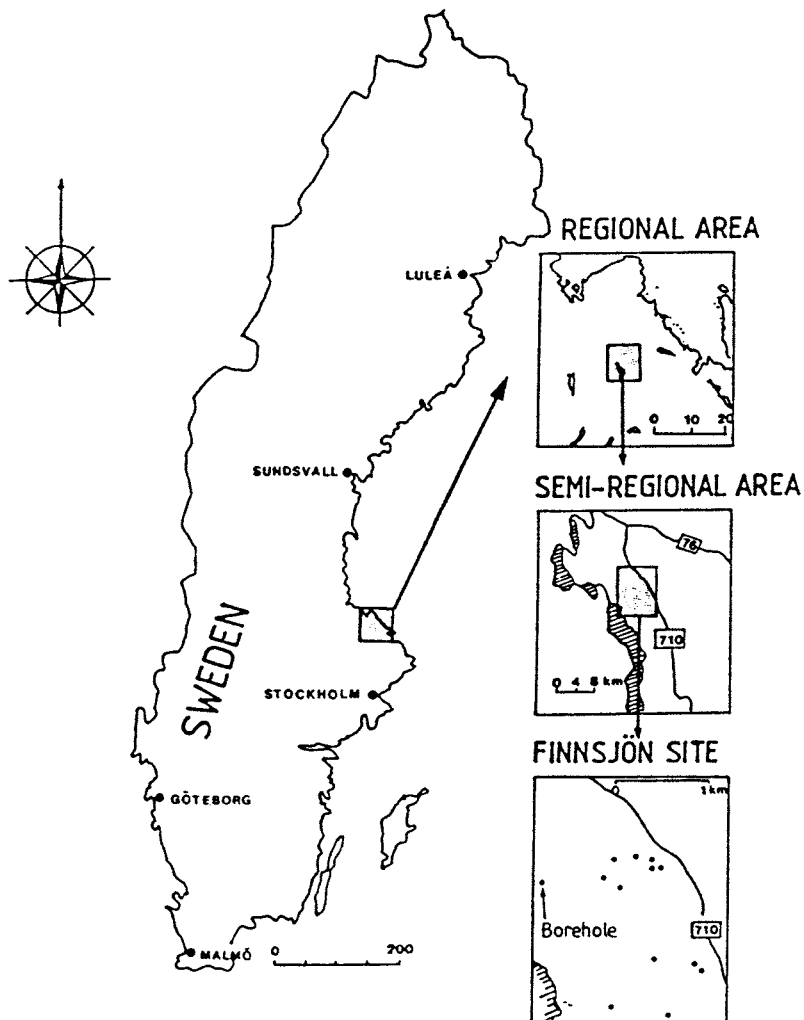

Figure 2.1. Location of the Finnsjön study site. After Ahlbom and Tirén (1989).

The Finnsjön study site is situated within a 50 km² shear lens, which is a part of a regional, c. 20-30 km wide, WNW trending shear belt that was developed 1,600 - 1,800 million years ago, (Ahlbom and Tirén, 1989). The Finnsjön rock block, bounded by regional and semi-regional fracture zones, constitutes the main part of the Finnsjön site. The ground surface area of the block is 5.6 km². Within the Finnsjön area the predominant rock is a greyish, medium-grained and foliated granodiorite. Minor amounts of pegmatite, metabasite and aplite also occur. The present mineralogy of the granodiorite is the result of metamorphic reactions ca. 1.83 Ga ago. Figure 2.2 shows a map of the fracture zones and drilled boreholes within the area.

Fracture zone 2 is found in the northern part of the Finnsjön rock block within an area of approx. 500x500 m, and has been drilled through and examined by 8 boreholes. The zone is approximately 100 m wide and strikes northwest with a dip of 16° towards SW. The upper boundary of the zone is extremely planar and is located in the drillholes between 100 to 240 m below ground surface. The location of the lower boundary is not distinct and therefore somewhat uncertain. Fracture zone 2 is interpreted to occur in borehole KFI07 at a depth of 295 m, Fig. 2.3. However, at this location the zone can not be followed as a continuous plane. Instead faulting on later formed and steeply dipping fracture zones appears to have displaced zone 2.

Zone 2 was formed as a some hundred metres wide ductile shear zone at a depth of 10-15 km. The granodioritic bedrock above the zone is relatively unfractured and unaltered, while the rock below the zone contains inliers of fault rocks and is generally characterized by a higher degree of fracturing. The fracture frequency within the zone is relatively low, on average 5 fr/m, a value only slightly larger than in the country rock. In contrast, however, the frequency of sealed fractures is greater in most parts of the zone, with infillings mostly of hydrothermal origin.

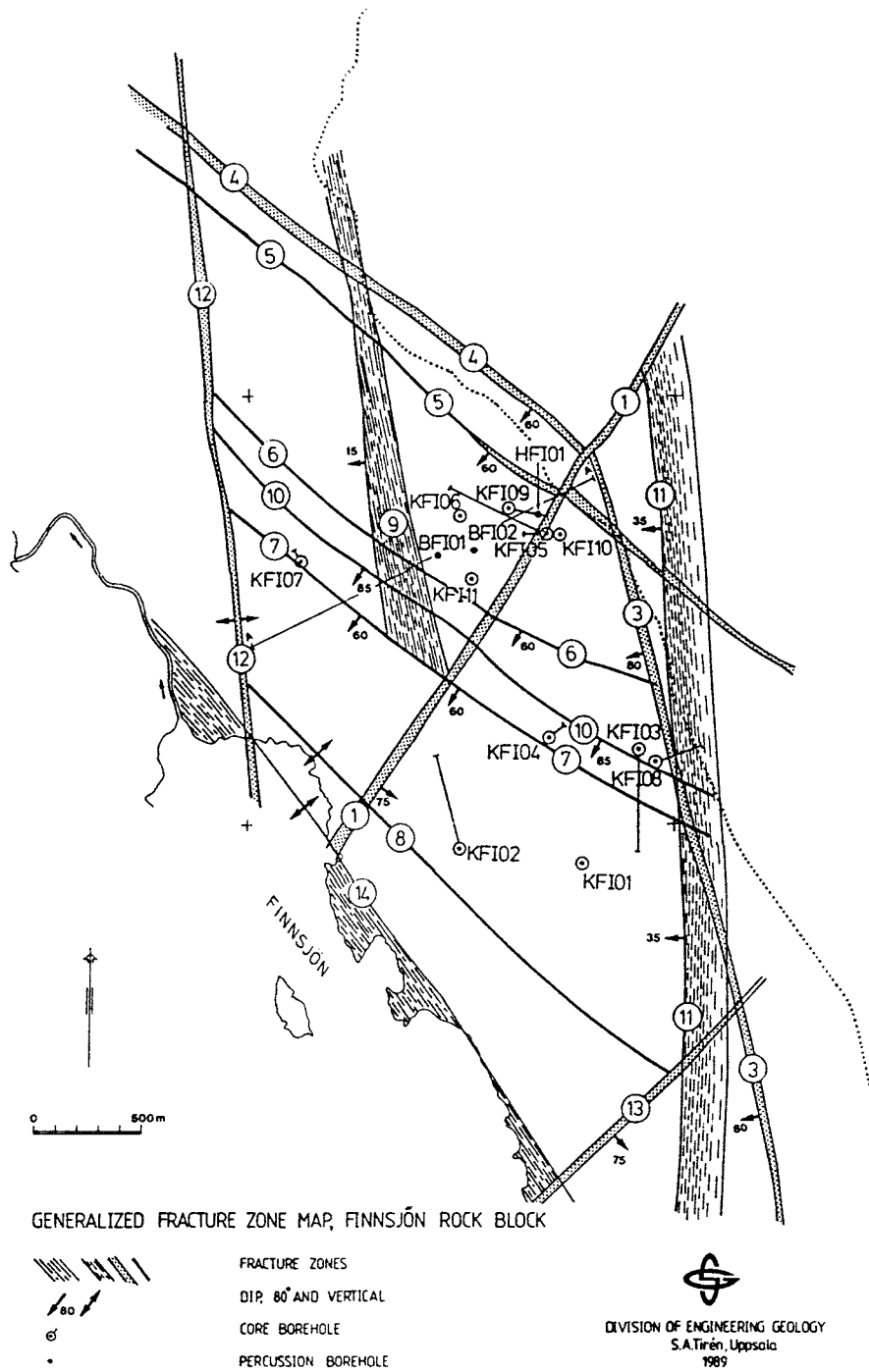

Figure 2.2. Map of fracture zones and boreholes in the Brändan area. After Ahlbom and Tirén (1991).

A large number of hydraulic tests have been conducted to characterize Zone 2 and its near vicinity. In general, single-hole injection tests showed a decrease in hydraulic conductivity with depth for the rock above zone 2. This decrease is, however, interrupted by zone 2 where the hydraulic conductivity is increased by one to four orders of magnitude (Ahlbom and Smellie, 1989). Further testing showed that the high conductivities could be correlated to a few very narrow sections in the boreholes. The uppermost of these zones coincides with the upper boundary of Zone 2. Towards the lower boundary of the zone several alternating thin horizons of very high conductivity are found. The hydraulic conductivity as function of depth is shown in Fig. 2.4. An interesting feature of fracture zone 2 is that its upper boundary is also a boundary between fresh, non-saline groundwater (above) and stagnant saline water (below).

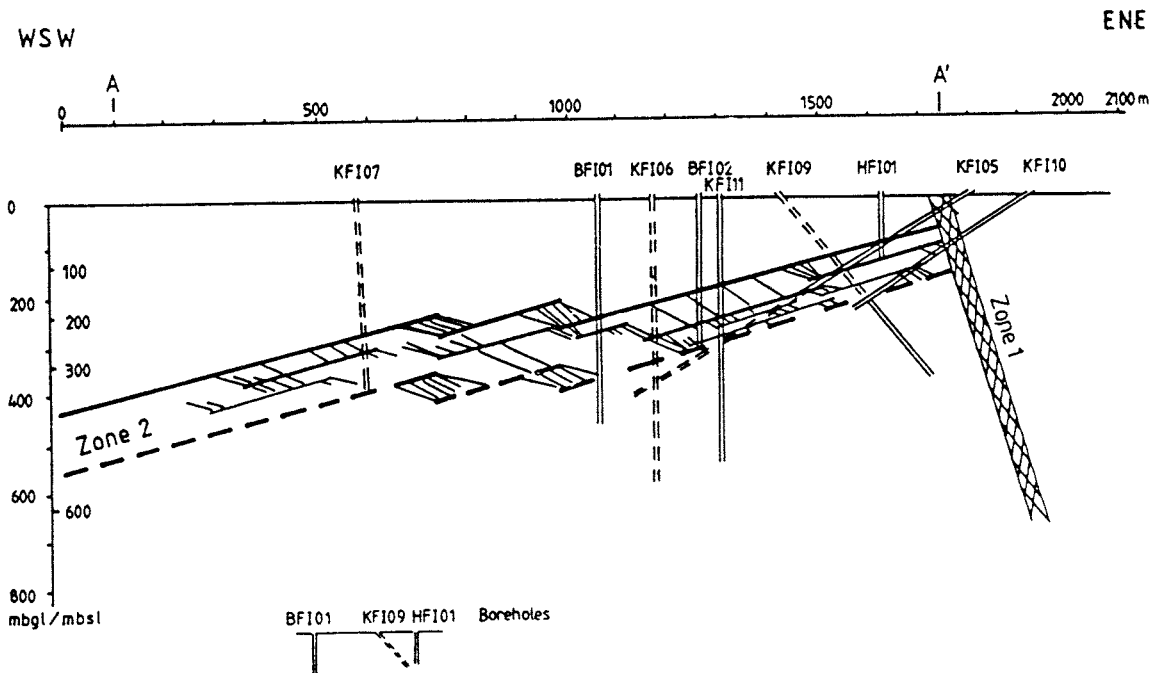

Figure 2.3. Vertical section of Zone 2. After Ahlbom and Tirén (1991).

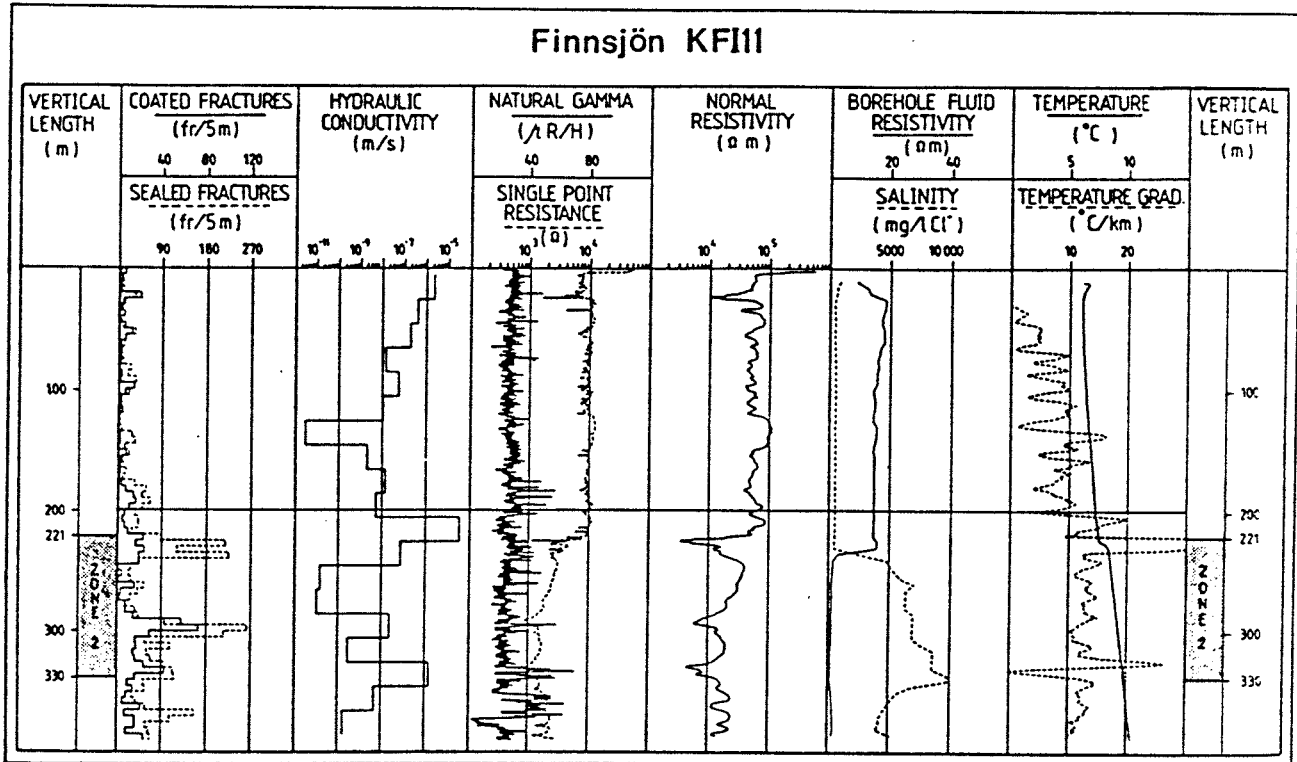

Figure 2.4. Composite geophysical log of borehole KFI11.
After Ahlbom and Smellie (1989).

3 ROCK STRESS CONDITIONS

3.1 Time scale

The in-situ stresses constitute the boundary loadings to the system under study. We need to consider not only the present stress field, but also past and (if possible) future variations thereof, induced by geological- and climate changes. Of special interest in this context is effects related to glaciation. The reasons are that i) it can be shown that glaciation/deglaciation have considerable impact on the state of stress, ii) loadings related to glaciation may have influenced the current mechanics of the rock mass, and iii) glaciation is likely to occur within repository lifetime, and hence a repository will be subjected to similar loading patterns.

Thus, we can view stress conditions with reference to three different time scales:

- The current state of stress. This can be established with some confidence on the basis of existing knowledge on stress conditions in Swedish bedrock in general, together with site specific stress measurement data.
- Stress variations over a, in geological terms, "short-term" perspective (say 50.000 years). This includes loadings related to the process of glaciation and deglaciation.
- Geologically "long-term" stress history. This refers to the many and complex processes of geological evolution that are too "slow" to have any significance during repository lifetime. It includes conditions of temperature and pressure which are completely different from today's. This perspective is not considered here.

3.2 Present stress conditions

Rock stress measurements by means of hydraulic fracturing were conducted in 1987 at the Finnsjön study site (Bjarnason and Stephansson, 1988). The measurements were carried out in borehole KFI06, Figs. 2.2 - 2.3. A total of 14 successful hydraulic fracturing tests were obtained, spread out from surface down to 500 m depth. By application of the hydraulic fracturing technique the maximum and minimum horizontal stresses (σ_{h1} and σ_{h2}) are determined.

The evaluated measurement results reveal thrust fault conditions from surface down to approximately 500 m, below which strike-slip fault conditions are indicated. Linear regression analysis of the minimum horizontal stress, σ_{h2} above and below Zone 2 respectively indicate a slight stress discontinuity associated with the fracture zone. It should be pointed out, however, that no evidence exist for such an interpretation.

The measured stress magnitudes as a function of depth are shown in Fig. 3.1, including linear regression analysis of both the minimum and maximum horizontal stress. In the linear regression analysis for σ_{h2} the existence of any stress discontinuity has been ignored. Added in the figure is also the theoretical vertical stress, σ_v corresponding to the weight of the overlying rock.

Although the hydraulic fracturing technique is two-dimensional allowing only the stresses in the plane perpendicular to the borehole to be determined, some few measurements sometimes results in transverse (horizontal) fractures. In the case of a vertical borehole such as KFI06, a transverse fracture then permits the determination of the vertical stress. The measurements in borehole KFI06 gave three such fractures. The agreement with the theoretical vertical stress is very good, the maximum difference being as low as 5%.

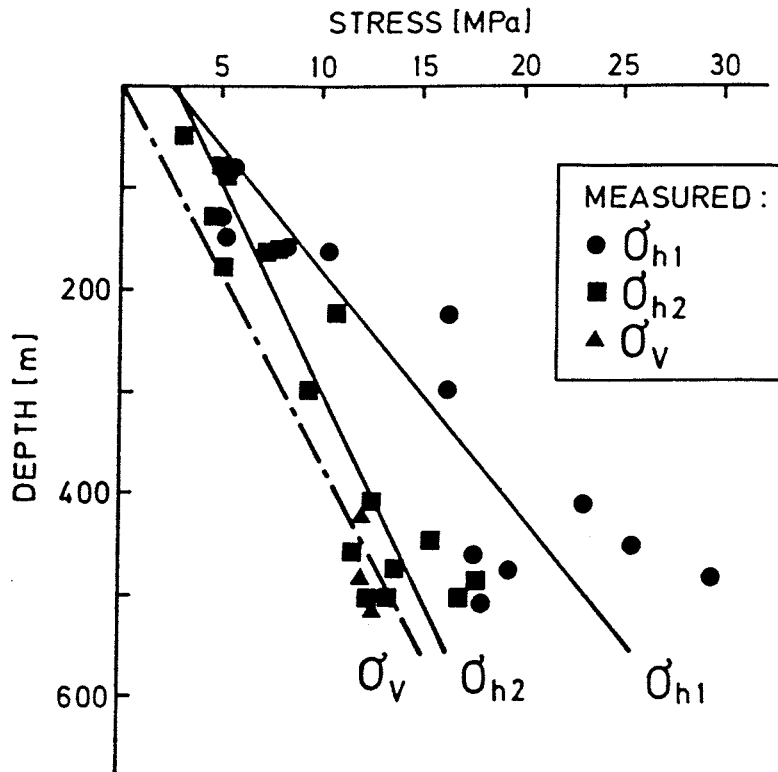

Fig. 3.1. Measured stress magnitudes versus depth, Finnsjön study site. After Bjarnason and Stephansson (1988).

The orientation of the maximum horizontal stress has been determined to $N48^{\circ}W \pm 11^{\circ}$, Fig. 3.2. This orientation is almost parallel to the strike of the oldest set of joints and nearly perpendicular to the youngest and most frequent set of joints.

The stress data from Finnsjön should be compared to the bank of general background data from Fennoscandia. The Fennoscandian Rock Stress Data Base (FRSDB) which was compiled in 1986 contains about 500 entries from more than 100 sites in Fennoscandia, (Stephansson et al., 1987). Based on the hydraulic fracturing data contained in the FRSDB at the time of release, regression analyses gave the following:

$$\sigma_{h1} = 2.8 + 0.0399 z \quad (\text{MPa})$$

FRSDB

$$\sigma_{h2} = 2.2 + 0.0240 z \quad (\text{MPa})$$

where z denotes depth in metres.

A corresponding exercise for the Finnsjön data gave the following:

$$\sigma_{h1} = 2.4 + 0.0412 z \quad (\text{MPa})$$

Finnsjön

$$\sigma_{h2} = 2.6 + 0.0237 z \quad (\text{MPa})$$

Calculating the average horizontal stress, σ_H at Finnsjön yields:

$$\sigma_H = \frac{\sigma_{h1} + \sigma_{h2}}{2} = 2.5 + 0.0325 \cdot z$$

From the above figures it can be seen that the data from Finnsjön are in close agreement with the average trend in Fennoscandia.

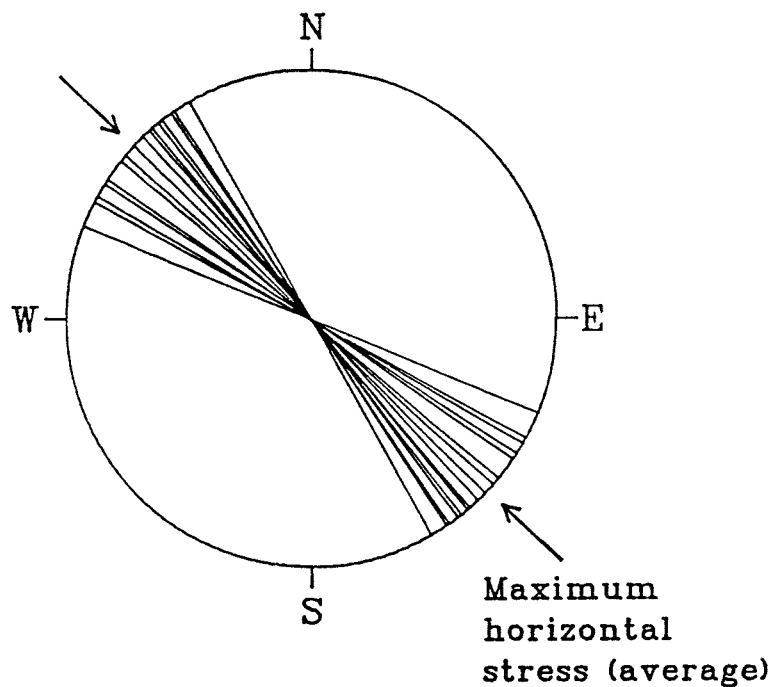

Figure 3.2. Orientation of the maximum horizontal stress at Finnsjön study site.

For the orientation of the maximum horizontal stress one can notice that the obtained orientation at Finnsjön agrees with the observed, though with a large variability, NW-SE trend that has been found for Scandinavia, (Stephansson and Ljunggren, 1988; Müller et al., 1990).

In summary, the following can be concluded as regards the present stress conditions at Finnsjön:

- Rock stresses are as would expected in Swedish bedrock, both in terms of magnitudes and directions. Assuming $\pm 20\%$ as a conservative estimate of the uncertainty in the experimental data as represented by the regression lines in Fig. 3.1, we arrive at stress estimates for the Finnsjön site as given Fig. 3.3. The number $\pm 20\%$ as a measure of uncertainty is based less on the data as such, and more on general experience. We can, however, with reasonable confidence state that the stress conditions at the site, excluding very local stress variations affecting individual data points, are covered by the intervals given in Fig. 3.3.

- At depths corresponding to Zone 2, stress magnitudes are in the range 5 - 17 MPa. Measurements reveal no evidences of major stress disturbances associated with Zone 2. Results from the few points contained within Zone 2 are in agreement with the general trend of increasing magnitudes with depth.

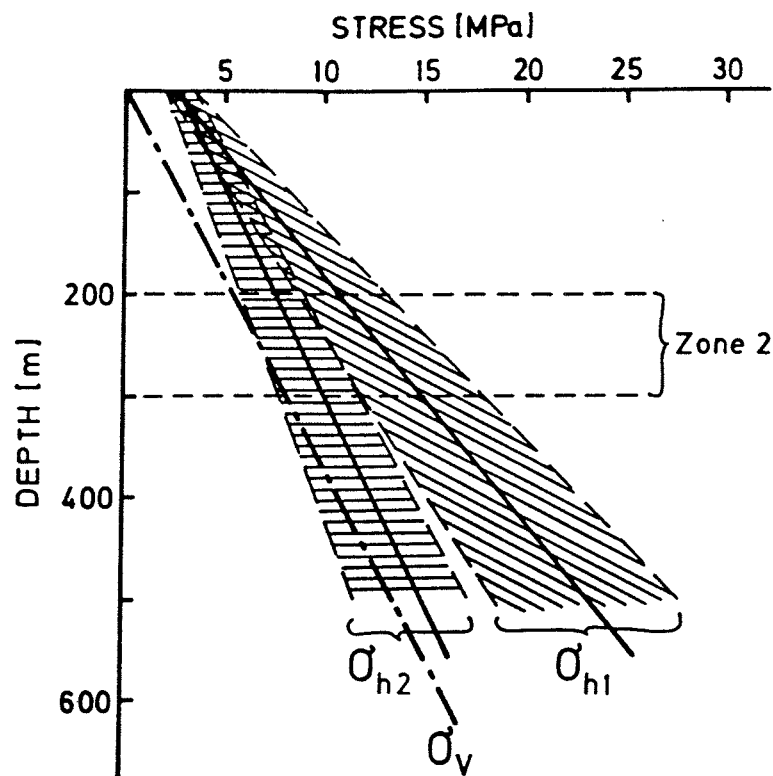

Figure 3.3. Upper and lower bound estimates for the current horizontal stress field at the Finnsjön study site. The vertical stress is assumed to be equal to the lithostatic pressure.

3.3 Glaciation

It is clear that glaciation periods reflects into large and relatively rapid changes in ground stress conditions. Loading mechanisms that can be envisaged are many and complex. They include elastic, gravitational compression and viscoelastic stress generation, as well as bending effects in connection with surpression and rebound. Quantitative estimates of stress perturbations associated with glaciations have been presented (e.g Lee and Asmis, 1979; Asmis and Lee, 1984) but results available are neither complete, nor very precise. Major uncertainties remain, especially with regard to stress conditions during deglaciation periods.

Here, we attempt to provide very crude estimates of the stress changes associated with some of these loading mechanisms, whilst others that are felt to be of lesser concern are neglected. We also neglect that repeated glaciations, ice retreats and re-advances may have caused accumulated effects.

The most obvious effect of a glaciation is an increase of the vertical stress due to the weight of the ice sheet, and hence proportional to the ice thickness. The increase is approximately 10 MPa per km ice thickness, and a maximum extra vertical load of the order of 30 MPa may therefore be assumed. Since the rock mass is confined in the horizontal direction, additional horizontal stresses are induced by the extra vertical gravity load caused by the ice sheet.

The horizontal stresses acting during a period of glaciation are more difficult to estimate, because of the influence of other components than purely gravitational loading. A lower bound estimate of the horizontal stress field can be obtained by assuming linear elastic conditions and zero lateral (horizontal) displacement. Then, the induced horizontal stress is given by:

$$\sigma_H = \frac{\nu}{1 - \nu} \cdot \sigma_V = K \cdot \sigma_V \quad (1)$$

For typical values of Poisson's ratio (0.2 - 0.3), K assumes values of 0.25 - 0.40. To obtain the total horizontal stress, the component induced by glaciation should be superimposed to the preexisting stress field. The latter is taken to be identical to the horizontal stress as measured today, c.f Fig. 3.3. This follows from the assumption of elasticity, which precludes the existence of remnant stress. Today's excess of horizontal stress must therefore be attributed to global scale tectonic processes (plate tectonics) not related to glaciation.

Superimposing the so calculated glacially induced -and tectonic horizontal stress components yields the result shown in Fig. 3.4 (σ_{Hmin}).

Under persistent anisotropic (but still elastic) conditions in the rock mass, the horizontal stresses induced by gravity alone can be larger than as given by Eq. (1). Such conditions are however not found at the Finnsjön site.

To obtain an upper bound estimate of the horizontal stress field, we consider possible inelastic effects. Several authors, e.g. Voight and St.Pierre (1974) have discussed the possibility of today's excess horizontal stresses being remnants of originally gravity-induced stresses that have been preserved through creep processes. This hypothesis assumes that the rock mass cannot tolerate high deviatoric stresses. Sustained vertical load from an ice sheet (or sediments) will then initiate deformations that, at least on a very large scale, can be considered as creep phenomena. The creep deformations will tend to even out the stress anisotropy. In our case this means that higher horizontal stresses, higher than for the elastic case, are generated. When the vertical load is removed through processes of erosion or deglaciation, a corresponding reduction in vertical stress occurs. The creep-induced horizontal stresses, however will partly be "frozen in" and remain after the removal of the vertical load. Relief of these stresses again require creep deformations. This theory could explain the existing horizontal stress field as complex remnants from previous glaciation periods.

Theoretically, such a creep process can proceed until hydrostatic conditions are approached, i.e a one-to-one ratio between the vertical and horizontal stresses is established. Although this is not a very realistic situation, it provides an upper bound estimate of the horizontal stress field during a glaciation period. This result, again for the assumption of a 3 km thick ice sheet is shown in Fig. 3.4 (σ_{Hmax}).

In summary then, Figure 3.4 shows the estimated vertical stress, and the two bounding estimates for the horizontal stress field during a period of glaciation. The bound estimates for the horizontal stress field are obtained by as-

suming i) purely elastic conditions, and ii) hydrostatic conditions resulting from creep processes. The vertical stress is assumed to be equal to the lithostatic loading from the rock and the overlying ice sheet.

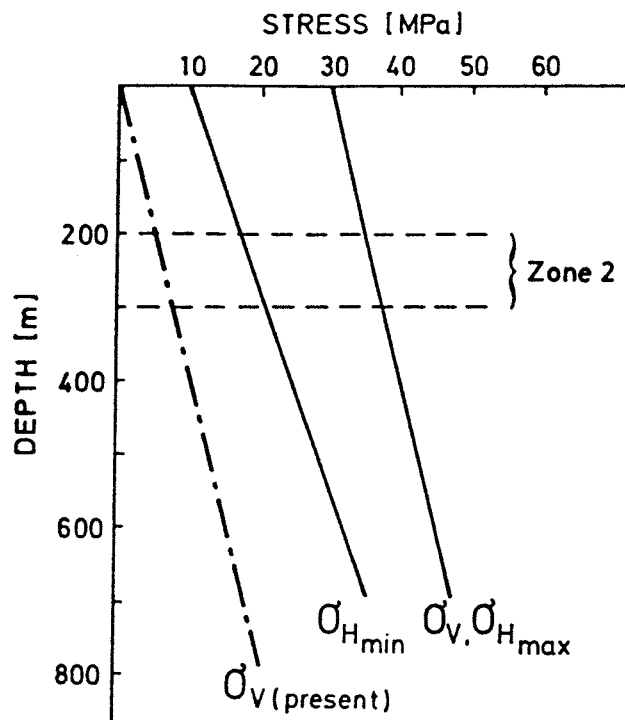

Figure 3.4. Stress estimates for the Finnsjön site during a period of glaciation. σ_{Hmax} and σ_{Hmin} denotes upper -and lower bound estimates of the horizontal stresses respectively, and σ_V is the vertical stress (thickness of ice sheet is 3 km, Poisson's ratio of the rock is 0.2). Dashed curve indicate the current vertical stress.

3.4 Deglaciation

Deglaciation will result in a reduction of vertical stress, proportional to the decrease of the ice thickness. It can be concluded from the existing bank of rock stress data that this reduction occurred concurrently with ice melting (no creep effects in the vertical direction); If not, we should expect to now measure a remnant of excess vertical stress.

However, data at large, from Scandinavia and elsewhere, indicate no such effects but show good agreement with current overburden loads.

As discussed in the previous section, the rate and nature of horizontal destressing accompanying deglaciation may be more complicated, and depend on the stress generating mechanisms operating during a glaciation period. If the horizontal destressing is delayed or prohibited, as postulated by the creep-hypothesis, the deglaciation would become a period of critical stress conditions; The very rapid vertical unloading, horizontal stresses remaining partly unrelieved implies large deviatoric (shear) stresses. Possible implications of this will be discussed later.

The above comments refer to stress effects that occur on a large scale as a consequence of deglaciation. In addition to that, the bedrock will undergo a complex sequence of more local stress changes at and near the retreating ice front. Figure 3.5 illustrates this schematically, for the hypothetical case of linear elastic rock and an ice front, shaped as a truncated wedge. It can be seen that the stresses under the ice sheet are compressive in all directions, as would be expected. At and outside the front, the horizontal stresses near the surface become tensile. For an ice sheet with a thickness of 1000 m, the tensile zone extends to depths of about 1200 m, and laterally far outside the position of the front itself. The tension zone is a consequence of the downward movement of the surface below the ice, which introduces a bending deformation at and outside the edge. The illustration shows local stresses and deformations caused by the ice only. To obtain the total stress field, the prevailing tectonic stress field should be superimposed. For conditions such as those found at Finnsjön, this means adding compressive, horizontal stresses. This would reduce the zone being in tension, and may balance out the tensile component completely (i.e. all parts of the rock mass would be loaded in compression).

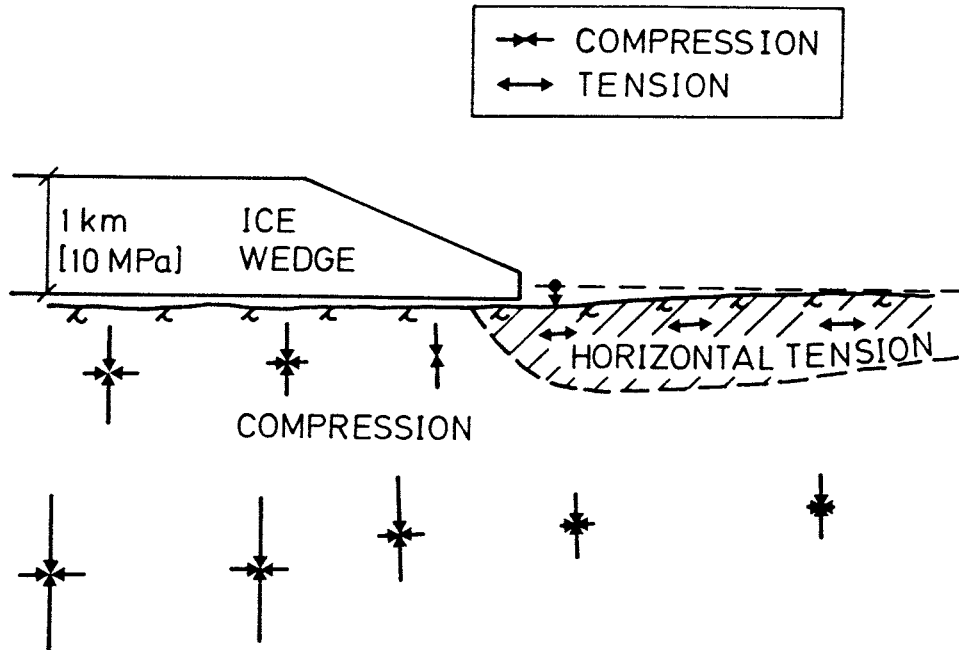

Figure 3.5. Schematic illustration of loading conditions at the edge of a retreating ice sheet.

3.5 Pore-water pressure during glaciation and deglaciation

During periods when the bed surface of an ice sheet is melted, there is potential for significant alterations of the hydrostatic head in the bedrock. This is due to hydraulic communication between the bedrock ground water and pressurized water below the ice sheet, or ice lakes near margins. The phenomenon has been thoroughly discussed by Koerner (1984). There appears to be significant uncertainty as to both nature and magnitudes of these pressure changes.

In their mathematical modelling of glaciation, Rosengren and Stephansson (1990) considered the extreme case of an ice lake 3 km above ground surface, and hydraulic communication, through fractures in the ice, between the lake and conductive structures in the underlying rock. This implies a pore water pressure increase of approximately 30 MPa, and a corresponding reduction of the effective normal stress across the

discontinuities involved. Such a large reduction of normal stress would dramatically decrease the shear resistance of the discontinuities, resulting in relief of shear stresses. Even much smaller pressure magnitudes may affect bedrock stability.

Pusch et al. (1990) and Talbot (1990) discuss a somewhat different effect, resulting from the same kind of over-pressurization but related to retreat of an ice front. This is illustrated in Fig. 3.6; Meltwater overpressure near a retreating ice front access the bedrock through activated, steeply dipping fracture systems. If the superficial bedrock at and beyond the ice front is adfrozen so preventing leakage up to the free surface, the overpressure could be further communicated along subhorizontal fractures before being discharged upwards. This, in turn, would create vertical uplift forces that could extend over significant areas outside the ice front. Pusch et al. (1990) suggest that this mechanism is responsible for the transport of glacial sediments into superficial sheeting fractures. Such fracture fillings have been found at several locations. The phenomena was documented and analyzed in detail by Carlsson (1979) in connection with excavation work in the Forsmark area.

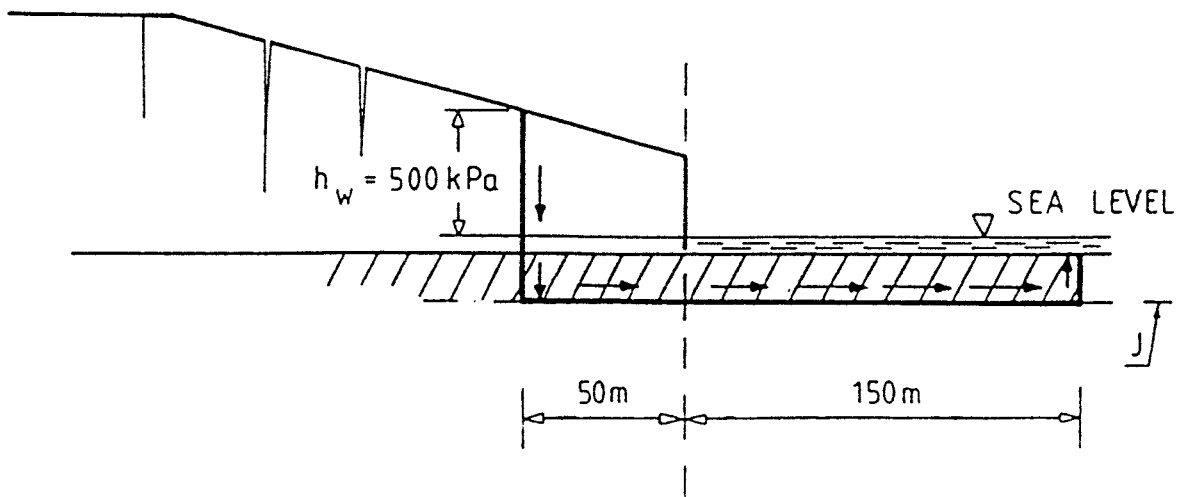

Figure 3.6. Schematic picture of pressurization of a horizontal fracture overlaid by adfrozen bedrock, from Pusch et al. (1990).

4 DEFORMATIONAL CHARACTERISTICS OF FRACTURE ZONE 2

4.1 General

From a fundamental mechanics point of view, rock materials are discontinuous on all scales. Whether or not a continuum approach is still valid in the analysis of a rock mechanics problem depends to a large extent on the scale of the discontinuities involved. In the present case, we are primarily interested in rock mass properties on a scale of hundreds of metres. This means that the contributions of intact rock matrix and smaller scale features such as joints can be superimposed to arrive at meaningful values for bulk properties such as modulus of deformation. Input to these calculations must nevertheless be taken from very small scale data available (borehole information). This implies that the complex scale dependencies attached to joint properties must be considered in the process of estimating large scale characteristics.

Assuming that the continuum approach applies on the scale of interest, the rock mass deformability is described (although not completely) by the modulus of deformation. The fact that a jointed rock mass does not behave elastically has prompted the use of the term modulus of deformation rather than modulus of elasticity (Young's modulus). Due to the softening effect of discontinuities on different scales, the rock mass always has a lower deformation modulus (i.e. more deformable) than intact specimens. Laboratory determinations on core specimens from Finnsjön yielded an average Young's modulus of $E_i = 82.5 \text{ GPa}$ (Swan, 1977).

There are a number of methods available to estimate the modulus of deformation of the rock mass, on the basis of borehole information. To provide such estimates for Zone 2 at Finnsjön and its surroundings, the following three methods have been applied:

- Empirical relationships between RQD (Rock Quality Designation) and the in-situ deformation modulus.
- Classification of the rock mass by use of the Q-system and from the resulting ranking then estimate the in-situ deformation modulus.
- Estimation of the in-situ deformation modulus based on JRC (Joint Roughness Coefficient) and JCS (Joint Compressive Strength).

In all cases, the attempts to estimate the deformation characteristics were based on information from the core drilled borehole KFI06, (Figs. 2.2 - 2.3). Besides using existing logging data from this borehole, certain sections of the core were re-surveyed for the present purpose. KFI06 is vertical and has a diameter of 56 mm (core diameter 42 mm). It intersects the upper boundary of Zone 2 at about 190 m and the lower boundary at approximately 290 m.

4.2 RQD to estimate in-situ deformation modulus

The RQD index has been used for more than 30 years as a measure of the rock quality within a borehole. A secondary outcome of the RQD was the empirical correlation of RQD with the in-situ deformation modulus. Procedures for, and the justification of using the RQD value to directly predict the in-situ deformation modulus has been discussed in the literature (Coon and Merritt, 1970; Bieniawski, 1978). As a first approximation, it can indicate the "region" of the in-situ modulus.

The RQD-values for different depth intervals including horizons of uniform rock quality are presented in Table 1. Besides, an average RQD for Zone 2 is also shown in Table 1.

Table 1. RQD-values determined on drill core from borehole KFI06.

Depth interval (m)	RQD (%)	Rock quality	Comments
134 - 151	99	excellent	Above zone 2
154 - 190	99	excellent	Above zone 2
188 - 209	92	excellent	
190 - 290	84	good	
250 - 275	69	fair	
250 - 282	72	fair	
260 - 270	66	fair	
300 - 350	98	excellent	Below zone 2

The intervals 134 - 151 m, 154 -190 m and 300 - 350 m indicated from a visual inspection a good rock quality, and have been included in Tables 1 and 2 as references. The interval 190 - 290 m covers the entire Zone 2 when penetrated by borehole KFI06. The other intervals in Tables 1 and 2 have been chosen to illustrate the reduction in RQD as the interval is concentrated around the section of intense fracturing.

By application of the empirical relationship (in graphical form) by Coon and Merrit (1970) which includes crystalline rocks such as granite and gneiss one obtains estimates on the in-situ deformation modulus, E_m as presented in Table 2.

It should be pointed out that the above approach, using RQD, does not consider that the deformation modulus of a rock mass and especially a fracture zone is stress dependent. Nor is it specified to apply for a certain normal stress. Since the empirical relationship, however, was calibrated against in-situ deformation modulus measurements using plate jack tests one may assume a stress level of approximately 5 MPa.

Table 2. Estimates of in-situ deformation modulus based on RQD, drill core from KFI06, Finnsjön.

Depth interval (m)	RQD (%)	Deformation modulus E_m , (GPa)	Percentage of E_i (%)
134 - 151	99	70	85
154 - 190	99	70	85
188 - 209	92	45	55
190 - 290	84	25	30
250 - 275	69	9	11
250 - 282	72	11	13
260 - 270	66	8	10
300 - 350	98	69	84

4.2 The Q-system to estimate in-situ deformation modulus

The Q-system was developed for the primary purpose of rock mass classification for the design of tunnel support (Barton et al., 1974). The quantitative assessment of the considered geological parameters should be obtained from investigations of excavated underground constructions (tunnel walls, roof, etc.). The system, when first presented, had been calibrated against more than 200 tunnel case records.

Later, some results have been reported where the Q-system was used on drill cores for rock mass classification (Barton, 1976; Cameron-Clarke and Budavari, 1981). In the latter reference is concluded that "drill core data may be used with some certainty to classify rock masses with Q values exceeding approximately 0.1". Based on this, an attempt has been made to apply the Q-system on the KFI06 drill core to estimate the in-situ deformation modulus.

The six parameters in the Q-system to describe the rock mass quality are combined in the following way:

$$Q = \frac{RQD}{J_n} \cdot \frac{J_r}{J_a} \cdot \frac{J_w}{SRF} \quad (2)$$

where

RQD = rock quality designation

J_n = joint set number

J_r = joint roughness number

J_a = joint alteration number

J_w = joint water reduction factor

SRF = stress reduction factor

The rock mass description and corresponding ratings for each of the six parameters are given by Barton et al. (1974). Two of the parameters, J_r and J_a , should be relevant to that joint set which is considered to be weakest from a stability point of view. In the case when using the Q-system to estimate the deformation modulus such a consideration is not relevant. J_r and J_a are instead assigned values representative for typical joints from (i) the subhorizontal joint set and, (ii) the two subvertical joint sets. Thus, the former Q-value should be used for estimating the deformation modulus in the vertical direction, and the latter in the horizontal direction.

To classify the rock mass with respect to the parameters in the Q-system, three sections of the drill core from borehole KFI06 were chosen; The section 188 m - 209 m which includes the upper boundary of Zone 2, section 260 m - 270 m which includes the most intensified fractured part of Zone 2, and section 134 m - 151 m which from a visual inspection indicated very good rock mass quality and therefore was chosen as a reference.

Tables 3 and 4 show the ranking of each parameter and the resulting Q-value. The Joint Water Reduction Factor considers the water leakage into an underground construction. For ob-

vious reasons is it difficult to estimate that from a drill core. However, from the measurements of the hydraulic conductivity it is known that high conductivity is restricted to few and very narrow zones (Ahlbom et al., 1986; Tirén, 1991). Intersecting one of the highly conductive horizons with a thought excavation would undoubtedly result in high water inflows. For the remainder of the studied sections, however, fairly dry conditions would be expected. Given the purpose of the calculation (to estimate the modulus of deformation for the rock mass) and the fact that the water bearing horizons represent a minor proportion of the sections, an averaging procedure for obtaining the J_w -value would not be appropriate. Instead, the parameter was given a ranking of 1.0, which corresponds to dry conditions or minor inflow.

Table 3. Ranking values for the Q-system parameters relevant to the subhorizontal joint set.

Depth interval (m)	RQD (%)	J_n	J_r	J_a	J_w	SRF	Q
134 - 151	99	9	3	2	1	1	16
188 - 209	92	9	1.5	3	1	1	5
260 - 270	66	9	2	2	1	1	7

Table 4. Ranking values for the Q-system parameters relevant to the subvertical joint sets.

Depth interval (m)	RQD (%)	J_n	J_r	J_a	J_w	SRF	Q
134 - 151	99	9	2.5	1.5	1	1	18
188 - 209	92	9	2.5	2	1	1	13
260 - 270	66	9	2.5	2	1	1	9

The parameter $J_n = 9$ corresponds to 3 major joints sets, and the $SRF = 1$ is obtained from the stress situation at Finnsjön and the strength of the intact rock material.

Bieniawski (1978) investigated the correlation between the rock mass rating (RMR) of the Geomechanics Classification and the in-situ rock mass deformation modulus determined by large-scale methods such as plate bearing, tunnel relaxation, flatjack and pressure chamber tests. As a result from this investigation Bieniawski op. cit. suggested a simple numerical relationship between the rock mass rating and the in-situ deformation modulus. Later, Hoek and Brown (1980) suggested that also the Q-system could be used for the purpose of estimating the deformation modulus, using an approximate relationship between the Q-system and the RMR derived by Bieniawski. Barton (1983) presented an empirical relationship between the in-situ deformation modulus and the Q-value having the form:

$$E_m = 25 \log Q \quad (3)$$

By inserting the calculated Q-values in Eq. (3) we obtain deformation modulus values as presented in Table 5.

Table 5. Q-values and deformation modulus based on information from the drill core of borehole KFI06, Finnsjön.

Depth interval (m)	subhorizontal joint set		subvertical joint sets	
	Q	E_m (GPa)	Q	E_m (GPa)
134 - 151	16	30	18	32
188 - 209	5	18	13	28
260 - 270	7	21	9	24

As is seen from Table 5 the difference between the estimated deformation modulus for sections 134 m - 151 m and 260 m -

270 m is fairly small. One might expect a larger difference. The reason for the small difference is probably found in the determination of J_r and J_a . These are the most difficult parameters to assess accurately from a drill core.

As for the RQD approach in section 2.1 neither this one takes into account that the deformation modulus is stress dependent. However, since Bieniawski's (1978) numerical relationship between the rock mass rating and the in-situ deformation modulus is based on plate bearing tests etc, one can assume the modulus values to be representative for a normal stress on the order of 5 MPa.

4.4 JRC and JCS to estimate in-situ deformation modulus

As has been addressed previously the deformability of a fracture zone is highly dependent of the joint stiffness which, in turn, depends on the stress level. For the simplified case illustrated in Fig. 4.1, the contributions from intact rock blocks and joints can easily be added together to obtain the system stiffness. The rock is assumed to be bedded or regularly jointed, and loaded perpendicular to the joint/bedding planes. By superimposing the deformability of the joints (expressed by the joint stiffness) and the intact rock (expressed by E_i) the resulting deformation modulus of the rock mass is obtained (Barton, 1983):

$$E_m/E_i = \frac{k_n \cdot S}{k_n \cdot S + E_i} \quad (4)$$

where, E_m = deformation modulus of the rock mass
 E_i = deformation modulus of the intact rock
 k_n = normal stiffness of individual joints
 S = mean joint spacing

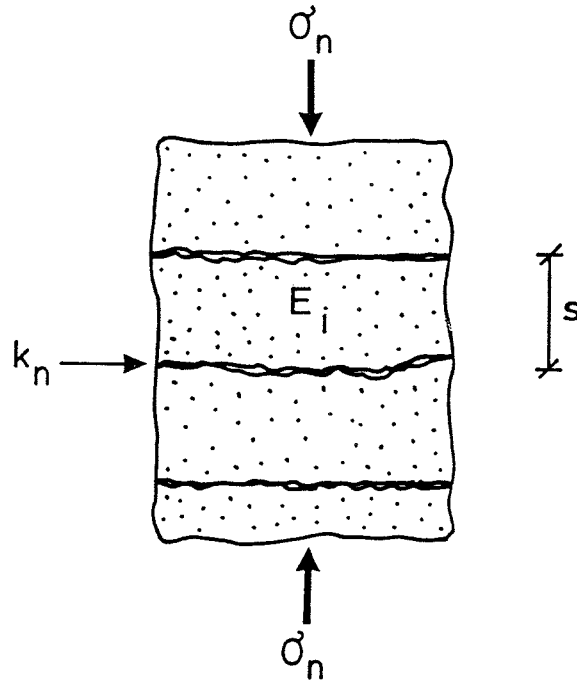

Figure 4.1. Schematic of rock mass geometry and loading direction to express the deformation modulus as in Eq. (4).

Further, based on a total of more than 60 rock joint tests, Bandis et al. (1983) presented formulas that allowed the complete stress-closure curve for a given joint to be predicted if only the JRC and JCS values of the specific joint were known. The initial aperture (a_j) of a joint can then be determined from the following empirical equation:

$$a_j = \frac{JRC}{5} \left(0.2 \frac{\sigma_c}{JCS} - 0.1 \right) \quad (5)$$

where, a_j = initial aperture (mm) at very low stress (≈ 1 kPa)
 σ_c = uniaxial compressive strength of the rock

Having determined the initial aperture of the joint, the initial joint normal stiffness (k_{ni}) can then be obtained from the following relation:

$$k_{ni} = -7.15 + 1.75 \cdot JRC + 0.02 \left(\frac{JCS}{a_j} \right) \quad (6)$$

The maximum closure (V_m) of the joint is then obtained by combining the effects of JRC, JCS and a_j on the maximum closure:

$$V_m = A + B(\text{JRC}) + C \cdot \left(\frac{\text{JCS}}{a_j}\right)^D \quad (7)$$

A, B, C and D are constants which values for repeated normal loading cycles were determined to:

$$A = -0.1032$$

$$B = -0.0074$$

$$C = 1.135$$

$$D = -0.251$$

Finally, to determine the joint normal stiffness (k_n) at various normal stress levels (σ_n) we have the following relation:

$$k_n = k_{ni} \left(1 - \frac{\sigma_n}{V_m k_{ni} + \sigma_n}\right)^{-2} \quad (8)$$

Equation (8) is the derivate of the function suggested by Bandis et al. (1983) to describe a hyperbolic variation of joint closure with normal stress, and allows the normal stiffness, k_n to be determined for any stress level, σ_n .

Thus, by determining the typical JRC and JCS values on the joint of interest, and the uniaxial compressive strength of the intact rock, Eqs. (5) - (8) can be solved. If the Young's modulus of the intact rock (E_1) and the mean joint spacing (S) are known the deformation modulus of the rock mass can then be solved for different stress levels, Eq. (4).

At the Finnsjön study site, mapping of outcrops has defined three different joint sets (Ahlbom and Tirén, 1989). Two joint sets are steeply dipping and the third is gently dipping. Hence, the assumptions needed for applying the above method are not fully met.

An attempt using Eqs. (4) - (8) has nevertheless been made to estimate the possible ranges of values of the deformation modulus. The mean joint spacing is determined in two ways; (i) by taking into account only fractures having a dip between $0^\circ - 25^\circ$ from the horizontal, and (ii) by only considering fractures with a dip between $65^\circ - 90^\circ$ from the horizontal. The former method should indicate the deformation modulus under vertical loading, whereas the latter should indicate the deformation modulus when subjected to horizontal loading.

The JRC values were determined on typical joints within each depth interval investigated and for each joint set. The parameter denoted S is the average joint spacing (vertical or horizontal joints). In the absence of any reliable technique to determine the JCS value a conservative approach was decided, applying a lower bound JCS suggested by Barton and Choubey (1977) being equal to $0.25 \cdot \sigma_c$. Tables 6 and 7 below include the input data used for the analyses.

Table 6. Input data for estimation of the vertical deformation modulus using the JRC and JCS parameters.

Depth interval (m)	S (horizontal fractures) (m)	JRC	JCS (MPa)
134 - 151	4.0	7	60
188 - 209	0.53	4	60
260 - 270	0.28	8	60
190 - 290	0.39	7*	60

* Assumed value

Table 7. Input data for estimation of the horizontal deformation modulus using the JRC and JCS parameters.

Depth interval (m)	S (vertical fractures) (m)	JRC	JCS (MPa)
134 - 151	0.3	10	60
188 - 209	0.13	11	60
260 - 270	0.15	9	60

The uniaxial compressive strength, σ_c and the Young's modulus, E_i of the Finnsjön rock have been determined to 241 MPa and 82.5 GPa, respectively (Swan, 1977). The mean joint spacing in Tables 6 and 7 includes a correction factor to compensate for the bias in the apparent joint spacing introduced by the angle between the borehole and the joint plane.

Since the joint normal stiffness, k_n is indeed dependent on the actual stress level (see Eq. (8)) the deformation modulus is also a function of the normal stress. Tables 8 and 9 present the resulting deformation modulus for three different normal stress levels, and the variation of the deformation modulus as a function of the normal stress is shown in graphical form in Fig. 4.2.

Table 8. The resulting vertical deformation modulus for different normal stress levels.

Depth interval (m)	Deformation modulus, E_m (GPa)		
	$\sigma_n = 5$ MPa	$\sigma_n = 10$ MPa	$\sigma_n = 20$ MPa
134 - 151	69	78	81
188 - 209	55	73	80
260 - 270	12	25	47
190 - 290	28	51	70

Table 9. The resulting horizontal deformation modulus for different normal stress levels.

Depth interval (m)	Deformation modulus, E_m (GPa)		
	$\sigma_n = 5$ MPa	$\sigma_n = 10$ MPa	$\sigma_n = 20$ MPa
134 - 151	19	36	59
188 - 209	9	19	39
260 - 270	11	25	49

By comparing the results in Tables 8 and 9, it can be seen that the horizontal deformation modulus is less than the vertical. This is due to, after correction for orientational bias, a much higher fracture frequency for the subvertical fractures compared to the subhorizontal. It is also caused by the JRC value, which is higher for the subvertical joints. A high JRC value decreases the deformation modulus.

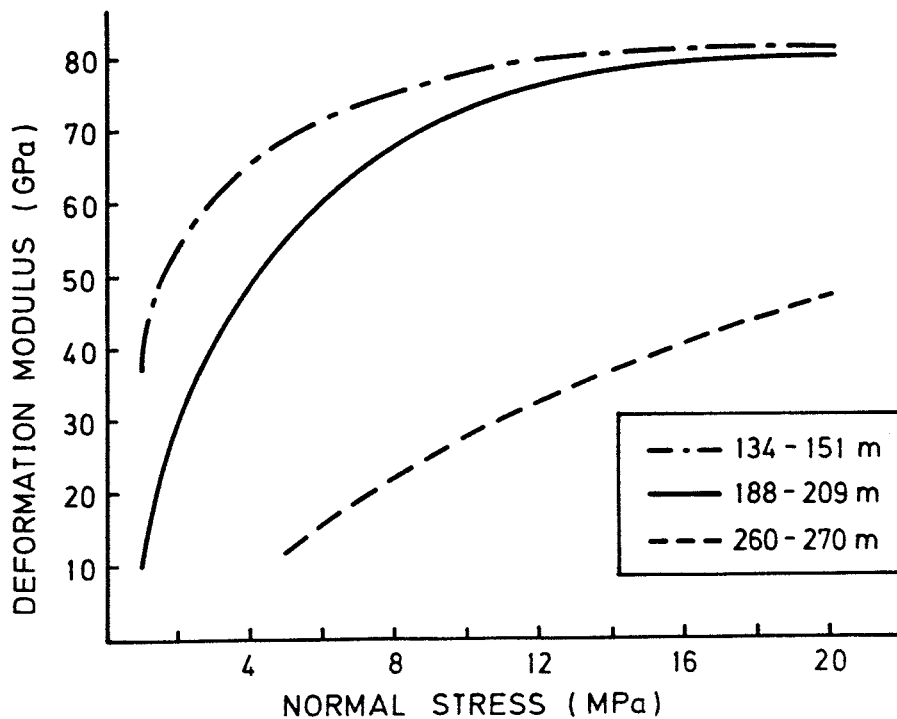

Figure 4.2. The vertical deformation modulus as a function of the normal stress.

4.5 Summary

In Fig. 4.3 below the results from the three different approaches to evaluate the deformation modulus are shown. The modulus values from the RQD- and Q system approaches have been put in as discrete points at a normal stress of 5 MPa. Figure 4.4 shows the results as function of depth, and is only intended to give a feeling for the deformational characteristics within and outside Zone 2. As normal stress levels have been used those derived from the available rock stress data, c.f. Fig. 3.1.

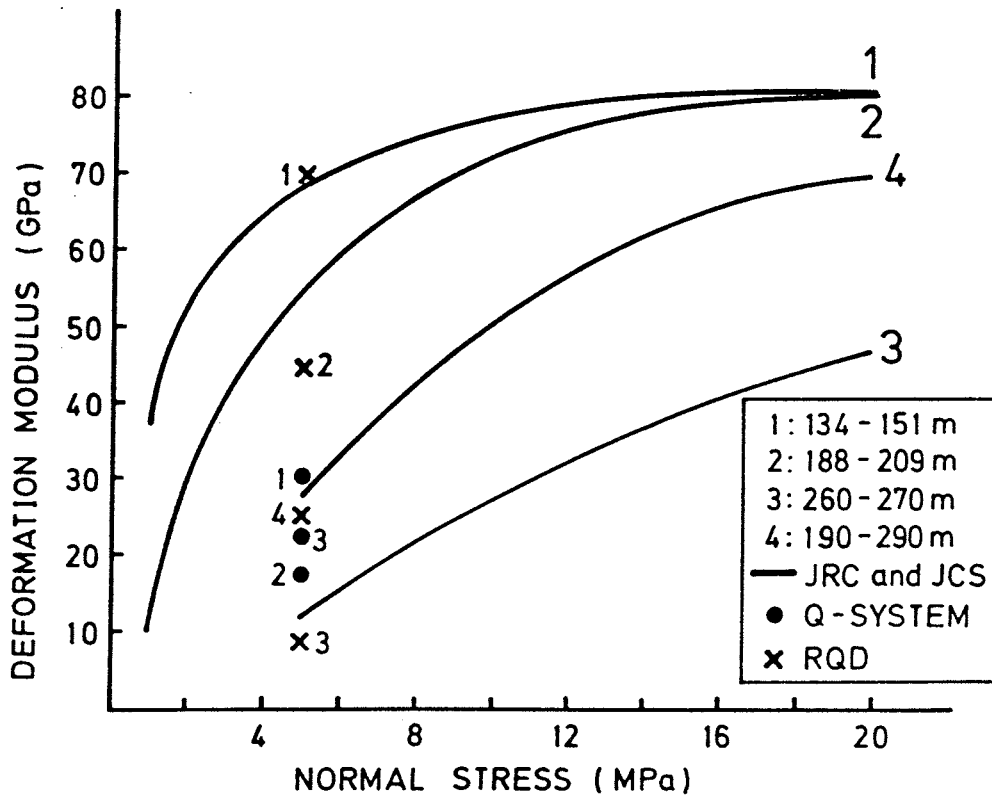

Figure 4.3. Deformation modulus estimates as function of normal stress.

The estimates given are crude, but still some important conclusions can be drawn: (i) as a lower bound estimate the rock mass deformation modulus is not less than 15 GPa, (ii) looking at the complete zone, the RQD- and the JRC & JCS

methods indicate a deformation modulus of no less than 25 GPa (30% of Young's modulus), (iii) for the reference section the RQD- and the JRC & JCS approaches indicate a deformation modulus of 65 - 70 GPa (80% of Young's modulus), and (iv) the results do not in any way contradict the existing bank of large-scale field data, as obtained from various case studies, (Bieniawski, 1978; Heuze, 1980).

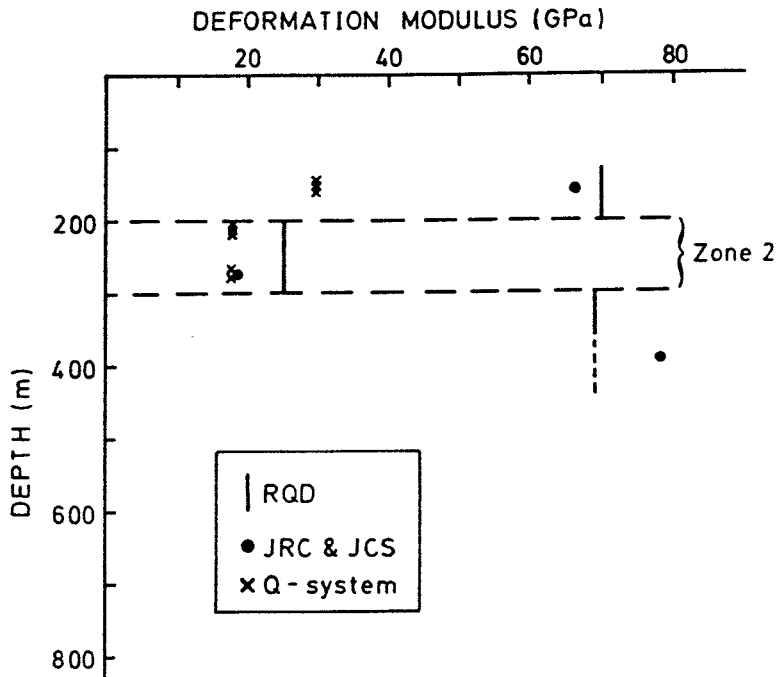

Figure 4.4. Calculated rock mass modulus at Finnsjön study site as function of depth. Summary of results obtained with the three methods applied.

5 MECHANICAL CONCEPTUALIZATION OF ZONE 2

The attempts to quantify the mechanical characteristics of Zone 2, as presented in Chapter 4, were limited to estimates of deformability as a bulk parameter. Shear properties (stiffness and strength) were not considered. Empirical methods verified in engineering practice would probably allow fair estimates of shear characteristics of individual joints, on the basis of the existing borehole data. It is not believed, however, that those methods could be used with reasonable confidence to assess the the shear characteristics of the much larger feature referred to as Zone 2. This is because i) the scale dependency of these properties and ii) the still poor understanding of how to represent Zone 2 conceptually. The results presented in chapter 4 can however assist in developing a conceptual model of Zone 2 as a mechanical system component.

As a general rule, the scale for which mechanical characteristics are defined should comply with the scale of the problem considered. This rule is very relevant in the present context. It implies that, depending on type of loading, we may be interested in the characteristics of Zone 2 as whole, or in the properties of individual discontinuities. To avoid confusion we define:

- The local scale as the scale comparable to the dimensions of single fractures, i.e. decimetres, metres or, at most, tens of metres;
- The large scale as the scale comparable to the dimensions of Zone 2, i.e. hundreds of metres;
- The regional scale as the scale comparable to the dimensions of the site, i.e. kilometres or more.

As an example, we may imagine that the rock mass within Zone 2 was investigated for the purpose of engineering any con-

ventional underground facility. One would then of course note the differences in rock quality between the Zone 2 horizon and the surroundings. However, conditions would not be considered extreme in any respect, and construction of openings would be feasible using conventional methods. Special attention would be paid to the identified, narrow water bearing horizons because they might affect local stability and would definitely cause problems with water inflow. In this case, it would thus not be appropriate to represent the zone as a whole, because the features that matters are the individual fractures/narrow sections.

However, even if viewed in the large scale, it appears that Zone 2 should not be considered as a distinct feature, but rather as a part of the continuous rock mass, exhibiting mechanical characteristics that are somewhat (but not dramatically) different from those of the surrounding rock mass. In fact, distinguishing a lower boundary finds no support in the data available. The feature of major concern is thus not Zone 2 as a whole, but rather the narrow, hydraulically "open" structures documented, especially at and near the upper bound of Zone 2. Important parameters related to these structures are:

- geometrical characteristics (dip, length, aperture)
- ability to transfer normal loads (degree of mechanical contact, normal stiffness, compressive- and tensile strength)
- ability to transfer shear loads (shear strength -and stiffness)

Some more general observations from the field investigations should be recalled in this context:

- The majority (if not all) of the boreholes intersecting Zone 2 shows a marked discontinuity with a width of a few

centimeters, constituting the upper boundary. At this horizon, intense fracturing typically occurred. Loose, gravel-like material found and idiomorphic mineral aggregates in cavities observed are other, strong indices of this discontinuity being very open.

- The upper part of Zone 2 governs the hydrology on the regional scale. This also indicates the presence of open discontinuities of large dimensions.

One could thus imagine one or a few, completely open structures of lateral dimensions hundreds of metres. This would however create major disturbances in the vertical stress field on the same scale - a situation which contradicts to the stress measurement data as well as to general experience. Furthermore, it is mechanically unrealistic, because the overlying bedrock can not remain unsupported over large areas. Mechanical coupling such that compressive normal loads can be transferred across the discontinuity must therefore exist. This coupling may be patchy and unevenly distributed on the local scale or probably smaller, and cause stress anomalies on a similarly small scale.

Within Zone 2, and especially in the proximity of discrete, open structures, high frequencies of filled and completely healed fractures have been reported. Apart from contributing to the decrease of overall rock mass stiffness, these fractures are unlikely to affect the mechanics of the system to any significant degree.

Figure 5.1 attempts to summarize the discussion above, and to visualize the idea that has evolved of the mechanical characteristics of Zone 2; The rock volume forms an integrated part of the bedrock, but is characterized by stiffness -and strength values that are moderately lower than for the surrounding rock mass. Individual discontinuities, preferably subhorizontal, of unknown but probably large extension are also found, especially in the uppermost part of the zone.

These discontinuities can transfer normal, compressive forces, resulting in only local, if any, disturbances in the vertical stress field. Their response to shear forces or unloading is much more difficult to predict.

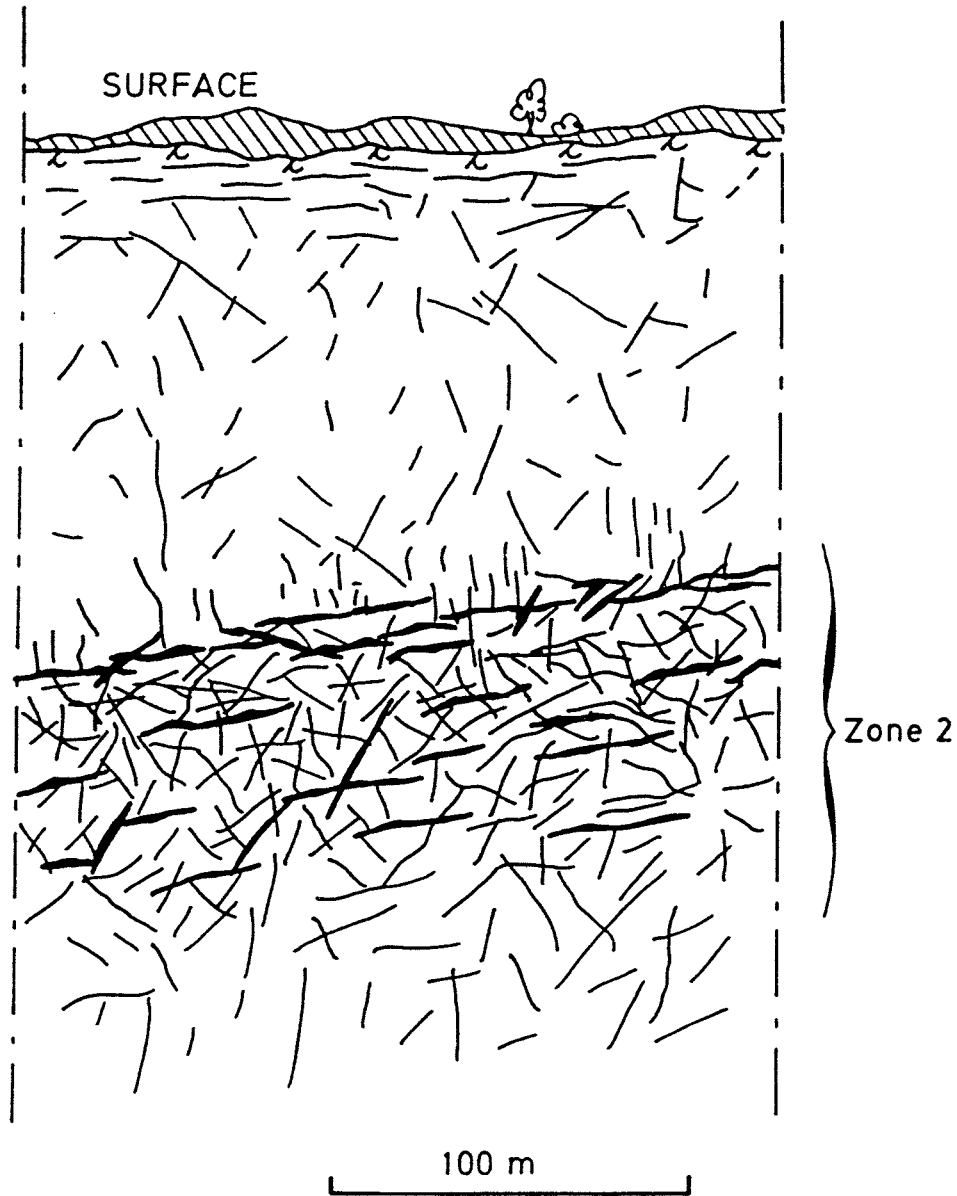

Figure 5.1. Mechanical conceptualization of Zone 2.

6 RESPONSE OF ZONE 2 TO DIFFERENT LOADINGS

In previous chapters, we have:

- estimated the present stress conditions in the area, and loadings imposed by glaciation processes
- attempted to quantify one of several mechanical parameters that characterize the rock mass referred to as Zone 2
- discussed the mechanics of Zone 2 from a conceptual viewpoint.

Below, possible rock mass reactions to different load situations are discussed. The cases considered are the various natural stress environments outlined in chapter 3, and also possible interactions with loadings generated by construction and operation of a hypothetical repository.

6.1 Present conditions

The current stress conditions at Finnsjön were summarized in Fig. 3.3. The assumed conceptual model of Zone 2, and the derived bulk estimates for its deformation modulus (Fig. 4.4) indicate that large scale disturbances of the stress field due to the overall lower stiffness of Zone 2 as compared to its surroundings would be insignificant. As was discussed in chapter 5, individual subhorizontal discontinuities may affect the vertical stress field due to a bridging effect. Figure 6.1 illustrates the principle, for a case of a uniaxial stress field acting normal to a plane containing open voids. This very simplified example shows that the redistribution of vertical stress extends to a distance perpendicularly out from the plane, similar to the long dimension of the voids. It is reasonable to assume that contact conditions of the major discontinuities within Zone 2 are nonuniform on the local scale (or less), but not on the large scale. This implies then, that the stress disturbances remain correspondingly local. Due to the near-horizontal orientation of the

structures, the interaction with the horizontal stress field will theoretically be small, probably insignificant.

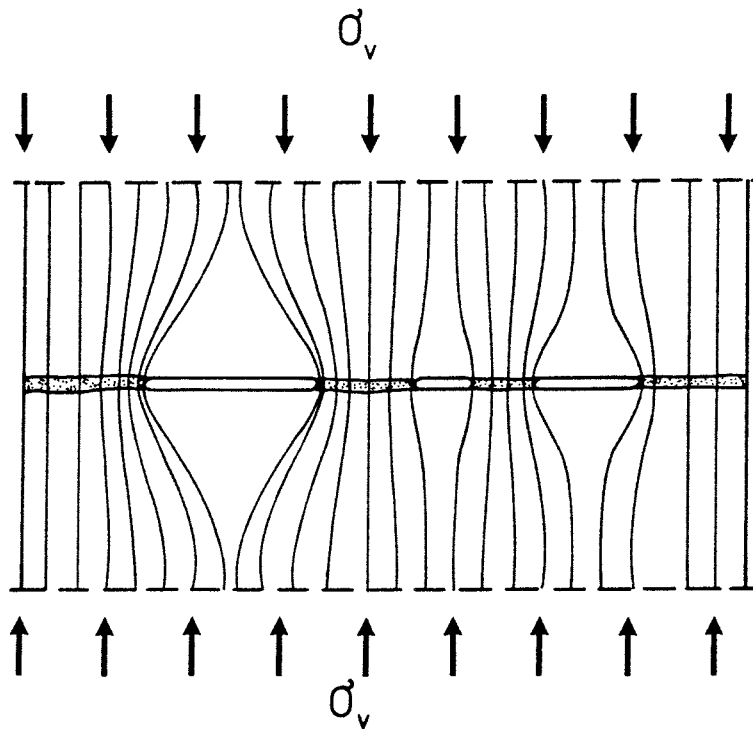

Figure 6.1. Schematic illustration of stress flow across a layer containing open voids. Loading is uniaxial and perpendicular to the layer.

Given that the horizontal and vertical stresses are principal stresses, which is a good assumption, the maximum shear stresses at zone depth is about 3 - 4 MPa. In the plane of Zone 2, the shear stresses will at most reach magnitudes of about 2 MPa (very local stress concentrations excluded). The shear strength of the discontinuities involved has not been determined, but it is still clear that 2 MPa is less than any reasonable strength limit.

In summary, it appears that Zone 2, when subjected to the current stress field, will not create significant stress anomalies on a large scale. Very local disturbances associated with individual discontinuities are more likely to exist. The stresses dealt with are not comparable to the strengths, neither for the rock mass nor for single discontinuities.

6.2 Glaciation

Stress conditions during periods of glaciation were discussed in section 3.3, and bounding estimates were given for horizontal and vertical stresses. The vertical stresses generated will obviously cause a compression of subhorizontal discontinuities.

Figure 6.2 again displays the stress estimates, as previously given in Fig. 3.4. In addition, the stress situation at a depth corresponding to Zone 2 (250 m) is shown in the form of a Mohr-diagram. The pore water pressure (assumed to be equal to the present water head) has been subtracted to obtain effective stresses. For the upper bound estimate, $\sigma_{Hmax} = \sigma_v$. Assuming that σ_H and σ_v are principal stresses, this implies zero shear stress in all directions (a point in the Mohr-diagram). The half-circle gives the stress conditions corresponding to the lower-bound estimate of horizontal stress. It is seen that the maximum shear stress will be about 8 MPa. By assuming a simple Coulumb-Navier shear strength criteria and zero cohesion for the rock mass (which is a gross simplification), we can use the diagram to determine a minimum friction angle required to maintain stability. This angle is found to be 19° , which should be compared to the shear strength of discontinuities in-situ. Again, no site specific estimates of shear properties have been made in the present case. A broad estimate based on data available in the literature would give values within a range of 30° - 50° . We may also compare with the present - obviously stable - conditions, which translate into a friction angle of 25° - 30° . The implication is that conditions during glaciation are stable with respect to shear movements, provided that the pore-water pressure is not increased significantly.

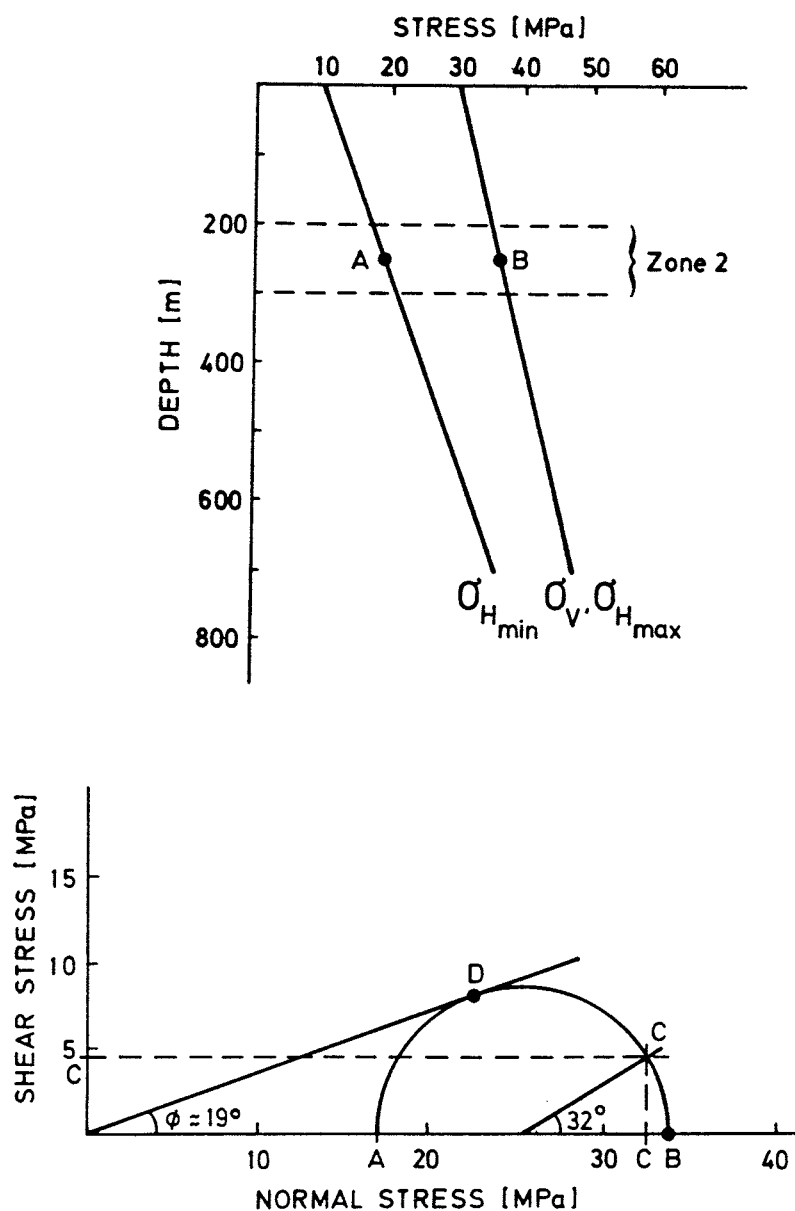

Figure 6.2. Upper: Stress estimates for the Finnsjön site during a period of glaciation, cf. Fig. 3.4. Lower: Mohr-diagram representation of effective stress conditions during glaciation;

A = σ_H -lower bound estimate
 B = σ_V (and σ_H -upper bound estimate)
 C = Normal -and shear stress acting on a discontinuity parallel to Zone 2
 D = Normal -and shear stress acting on a discontinuity having the most unfavourable orientation with respect to shear failure.

Discontinuities oriented parallel to Zone 2 will be subjected to even lower shear stresses (the friction angle discussed above applies to discontinuities oriented in the most unfavourable direction, in this case those having a dip of about 55°). Assuming the dip of Zone 2 to be 16° , the normal and shear stress components acting on a plane parallel to the zone are found to be 33 MPa and 4 MPa respectively, Fig. 6.2.

In summary, stress conditions encountered during a period of glaciation would correspond to stable conditions with regard to Zone 2. Regardless of orientation, discontinuities would be subjected to increasing normal stresses, and consequently the response to be expected is compression and closure. The high confinement improves stress transfer through the rock mass, and reduces the ability of discontinuities (discrete fractures as well as the entire zone) to cause stress concentrations. This would result in a homogeneous stress field.

6.3 Deglaciation

It is recalled from chapter 3 that deglaciation will be accompanied by large, rapid and complex stress changes. In summary the loading mechanisms identified are:

- Vertical unloading of gravitational stresses
- Unloading of gravitationally induced horizontal stresses
- Local stress concentrations and possibly horizontal unloading near the ice front
- Possibly excess water pressures in open structures having hydraulic connection with fractures in the ice sheet.

6.3.1 Vertical unloading of gravitational stresses

The most well-defined result of a deglaciation is the rapid reduction of vertical stress. At Zone 2 depth, a total reduc-

tion from about 35 MPa at maximum glaciation down to 5 MPa will take place, given a maximum thickness of the ice of 3 km. Existing laboratory and field test data suggest that such a substantial unloading results in opening-up and/or widening of preexisting fractures. The real loading sequence in-situ will differ significantly from those of controlled testing, especially in terms of loading rates, but aperture changes due to the unloading must still be considered as plausible. The nature of aperture increase will be highly dependent on to what extent the closure resulting from the previous compression (ice loading) included components of elastic, and hence recoverable, deformation of the fracture surfaces.

6.3.2 Induced, horizontal stresses

Horizontal stresses, as induced during glaciation and possibly remaining to an unknown extent after deglaciation (and unloading in the vertical direction) can theoretically affect preexisting discontinuities. The extreme scenario for the period immediately after deglaciation would be to assume horizontal stresses as estimated for the case of 3 km glaciation, cf. Fig. 3.4, and a present-day, vertical stress field. Figure 6.3 illustrates, in the form of a Mohr-diagram, conditions at Zone 2 depth for different alternatives as regards horizontal stress field. It is easily seen that the combination of high horizontal stress (no relaxation at deglaciation) and today's vertical stress results in critical conditions with respect to shear failure of discontinuities. Friction angles required to maintain stability are 40° and 52° , corresponding to lower bound -and upper bound estimates of horizontal stress respectively.

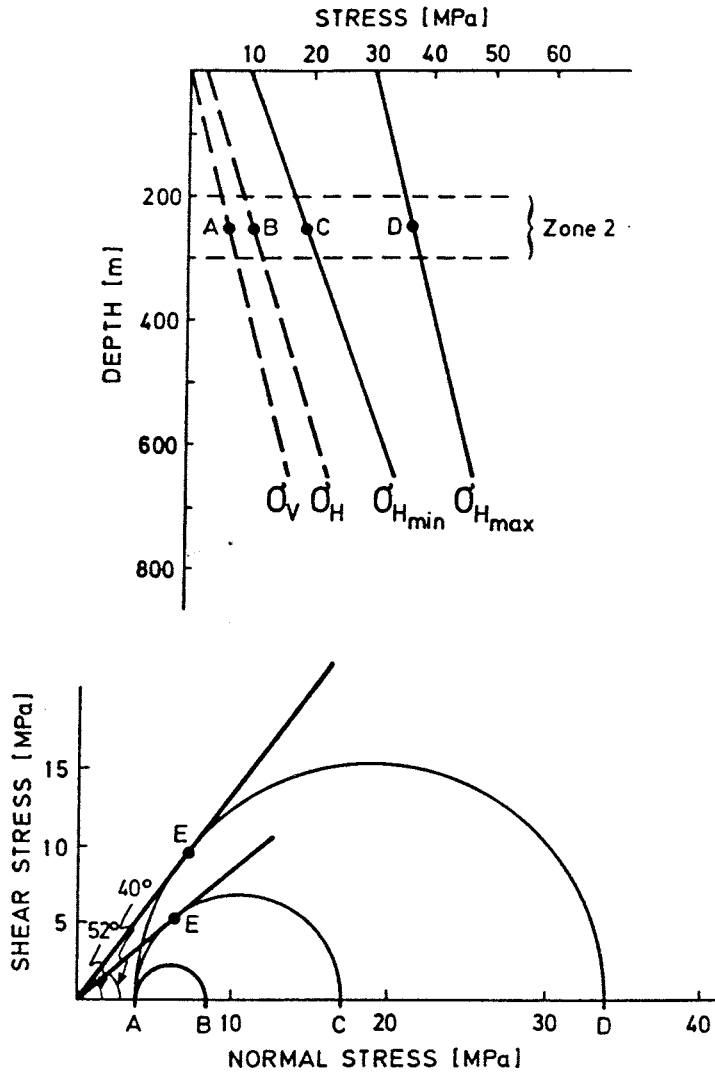

Figure 6.3. Upper: Stress estimates for the Finnsjön site, current conditions (dashed curves) and during a period of glaciation (solid curves). Lower: Mohr-diagram representation of possible effective stress conditions during glaciation;

- A = vertical stress - present-day conditions
- B = horizontal stress - present-day conditions
- C = horizontal stress during glaciation/deglaciation - lower bound estimate
- D = horizontal stress during glaciation/deglaciation - upper bound estimate
- E = Normal- and shear stress acting on a discontinuity having the most unfavourable orientation with respect to shear failure.

6.3.3 Excessive water pressures

Adding excessive pore water pressures would lower the effective normal stresses across the discontinuities, by a rate of 1 MPa per 100 m added water column (hydraulic head). Using the representation in Fig. 6.3, this corresponds to moving the half-circles to the left along the horizontal (normal stress) axis, maintaining their radius constant. In effect, a higher angle of friction would be required to maintain stability. Since ice thickness can be considerable (several hundred metres), even near a retreating ice front, there is a potential for pore water pressures within the interval 0-10 MPa. This would be sufficient to trigger shear movements in discontinuities, thereby relieving shear stresses. Besides causing instability in shear, the pressurization can theoretically also create considerable vertical lifting forces. Assuming a loading mechanism as illustrated in Fig. 3.6, the ratio between the ice thickness and the thickness of a rock slab that can be lifted depends on densities only, and is about 2.7 to 1. This means that a water pressure corresponding to an ice thickness of about 500 m is, in theory, capable to cause lifting and separation if injected into a large, horizontal fracture at 200 m depth.

6.3.4 Local stress concentrations at the ice front

This loading mechanism was illustrated in Figure 3.5. The effect at a depth of 200-300 m would be a general decrease of horizontal stress. Complete horizontal unloading is unlikely because of the preexisting stress field. A rotation of the principal stresses will also occur, which results in development of shear components in the horizontal plane.

6.4 Geological evidences

The discussion above is based on an analytical approach, and results are useful in order to qualitatively understand the problem and the factors governing stability of discontinuities during glaciation. It does not, however, produce quantitative results with any degree of precision, cf. Fig. 6.3. This is because of i) the uncertainty in local stress conditions, and ii) the poorly defined mechanical properties of the discontinuities. Extending the scale to consider Zone 2 as a single feature, rather than the individual discontinuities, would not decrease uncertainty in results.

An alternative approach is to consider geological evidences, interpreted in mechanical terms. From the detailed geological investigations conducted at Finnsjön, it can, for example, be readily concluded that Zone 2 has not been subject to any large scale post-glacial shear movements, resulting in displacements in the metre-scale. This does not exclude the possibility of late reactivation of lower-order discontinuities within the zone. Investigations at Finnsjön so far do suggest that reactivation related to recent glaciation/deglaciation periods has occurred, although this cannot be definitely proved (Tirén, 1991).

A well known geological feature of special significance in the present context are nearly horizontal fractures commonly termed sheet fractures or, more generally, sheet structures. Sheet fractures have not been subject to study at Finnsjön, but they are abundant in brittle, granitic and gneissic rocks, and have been reported from many places in Sweden. Carlsson (1979) conducted detailed investigations of superficial sheet structures in connection with excavation work at Forsmark, not far from the Finnsjön site. He found that typical features of sheet structures include increasing spacing with depth and a more precisely horizontal orientation at depth than near surface, where the orientation is less regular and tend to follow local topography. Development tend to

be highly independent of other, preexisting structures. Sheeting is known to occur at depths of 100 m, and probably down to 200 m (Tirén, 1991). Original development at periods prior to glaciation has been proven, as has reactivation attributable to glaciation and/or deglaciation. Deposition of glacial sediment in sometimes very wide-aperture sheet fractures has been documented at depths <15 m (Carlsson, 1979). Carlsson also concludes that while climatic factors may influence the development of sheet fractures very near surface, the most important factor governing the present status of sheet structures is the combination of high horizontal -and low vertical stress. Furthermore, that these conditions likely resulted from a non-synchronous relaxation of horizontal versus vertical stress at deglaciation, in a manner as described in chapter 3.

Several striking similarities, both in terms of development pattern and in geometrical arrangement, are found when comparing sheet fractures with fracturing that under certain conditions develop around highly stressed mine openings. The prerequisites for this kind of fracturing to occur are brittle and massive rock, high stresses parallel to the direction of fracture, and a free surface (low confinement) normal to fracturing. Fractures have been found to develop in intact rock at stress levels of 50-100 MPa (Borg, 1983). This refers to the stress parallel to the direction of fracturing. It is a common misunderstanding that this form of "tension cracking" requires tensional stresses perpendicular to the plane of fracturing. The requirement is, however, that the combination of stresses results in an extensional strain larger than a rock-type specific, critical value. This is possible also in the case of compressive stresses in all directions, provided only that the ratio of maximum to minimum stress exceeds a certain value. This value depends on the critical strain described, and the deformational properties of the rock.

Adding these observations of obviously analogous fracturing under engineered conditions (mines) to the observations of sheeting in nature, there remains little doubt that Carlsson's hypothesis on the development of sheet fractures is correct. Now, given that sheet fractures down to 100-200 m depth have been documented, and late reactivation proven (although only very near surface) at other locations, it appears realistic to assume that similar reactivation can have affected subhorizontal discontinuities within Zone 2. It is furthermore interesting to note the stress levels generating sheeting-type fractures in mines (50-100 MPa). In comparison to natural fracturing, the mining case can be seen as a small scale test. The larger geometrical scale, and the much longer duration of loading encountered in nature suggest that stress levels required to initiate fracturing would be lower in the case of naturally induced sheeting than in the mining case. Horizontal stress levels as estimated for Zone 2 for the case of a deglaciation period would thus be quite sufficient to not only reactivate old sheet structures, but also to initiate new fractures.

6.5 Loadings from a hypothetical repository

The mechanical loads imposed by a repository are of two types. One is the disturbance in the stress field caused by the excavations themselves. These loads occur concurrently with creating the excavations. Given hard rock formations as the host medium, they are probably not time dependent to any significant extent. The other source of load is the output of thermal energy from the disposed waste into the surrounding rock. This will increase rock temperature and develop thermal stress fields. This process is, of course, time dependent. Initially, the thermal perturbation is restricted to a local scale near deposition holes, tunnels etc. In later stages, the local temperature gradients in the near field will diminish and the entire repository will act as a single heat source. The rock volume subjected to elevated temperatures

will grow correspondingly, and the thermal front will eventually reach the ground surface. It is thus clear that the thermal stress field will reach, and interact with, major discontinuities.

Mechanical interaction between the repository and fracture zones may influence the minimum acceptable distance between the repository excavations and fracture zones. It is therefore relevant here to briefly discuss possible interaction for the case of Zone 2 at Finnsjön and a hypothetical repository.

6.5.1 Interference with excavations

Basic criteria

A single excavation created in competent rock causes a redistribution of the stress field in its neighbourhood. The exact stress field within this disturbed zone depends on excavation geometry and rock material properties. Disturbance declines rapidly away from the excavation. A good rule of thumb is that influence on the stress field around a long excavation (such as tunnel or shaft) is significant only to a distance from the boundary of about 1.5 times the mean cross sectional diameter of the excavation. Currently discussed repository concepts involves excavations like tunnels, shafts and boreholes with rather small diametres (metres or at the most 10 metres scale). The dimensions of the disturbed zone will thus also be confined to the local scale.

Figure 6.4 illustrates schematically one reasonable definition of the distance at which mechanical interaction occurs between a mined excavation and a fracture zone. The critical distance is taken to be the distance when the stress-disturbed zone around the excavation meets the hypothetical stress anomaly caused by the fracture zone. For the case of Zone 2, global stress anomalies were considered unlikely due

to the diffuse nature of the zone. Local stress concentrations attached to individual discontinuities were also discussed, and not believed to extend more than a few metres or at most tens of metres into the rock mass, Fig. 6.1. This implies then, that the critical distance as defined in Fig. 6.4, would be a few tens of metres, and that the value 100 m could be used as a conservative criteria.

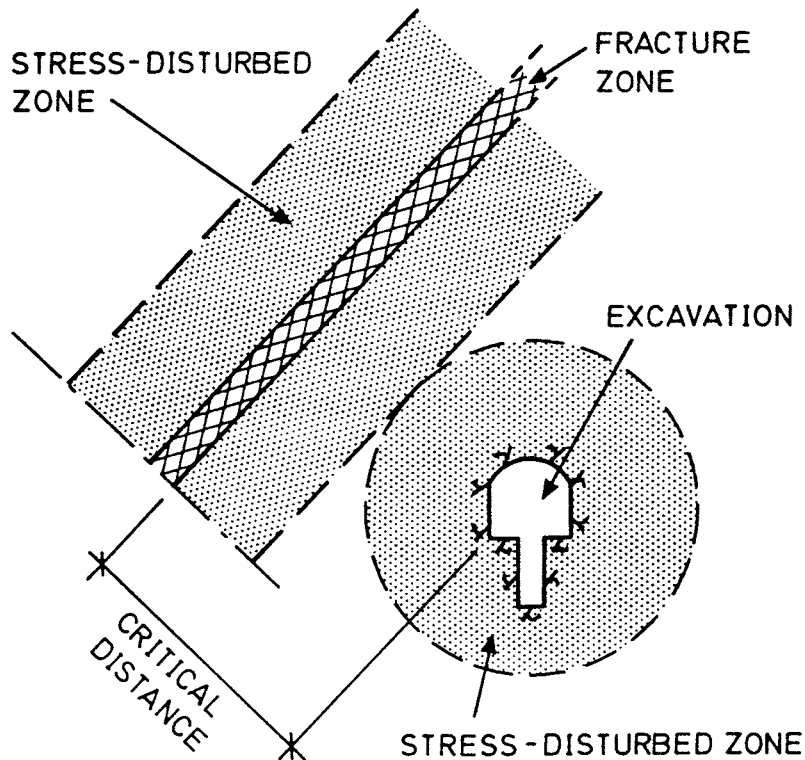

Figure 6.4. Schematic illustration of one criteria for selection of the minimum acceptable distance between a repository excavation and a fracture zone.

So far, we have only considered the case of one excavation, resulting in a very localized mechanical disturbance. It is wellknown from mining, however, that the presence of excavations can alter conditions within very large rock volumes.

The most obvious reason for large-scale rock mass disturbance from mining is simply large single excavations. This can be readily excluded in the repository case. An other possibility is multiple excavations located so as to influence each other

mutually due to overlapping disturbed zones, and together causing effects similar to a larger scale feature. This would be unlikely in a repository-case, because internal distances between drifts, holes etc are design parameters that can be fully controlled.

Excavation-induced rock bursts

An other example of large scale effects, related to small scale excavations, is the phenomena of mining-induced rock bursts. Different types of induced rock bursts can be distinguished:

- Violent failures, confined to the near-field of a single opening. This form is very local and is attributable to high stresses in combination with unfavourable properties of the rock. It can occur at relatively shallow depth (500-1000 m if stresses are high) but has nothing to do with large-scale structures, and is hence not of interest here.
- High extraction ratios, causing overstressing of remnants. This does not apply to the repository situation.
- Excavations triggering shear movements in preexisting faults under high stresses. This form normally occurs in large, distinct fault zones only, and requires very high stresses. It is observed in mines at depths of the order of 2000 - 4000 m.

It is concluded that the conditions observed at Zone 2 do not meet criteria for any form of excavation-induced rock bursts, and thus this need not be further discussed.

Progressive failure

Progressive caving is another example taken from mining, where single excavation can cause dramatic effects in a large rock mass. Caving initiate at the excavation boundary and progresses more or less upwards, sometimes to large distances from the onset or until the ground surface is reached. The major driving mechanism is gravity. The phenomena is however restricted to specific geological conditions, with layers or zones of weak rock surrounded by a more competent rock mass. For the geological conditions at Finnsjön, progressive caving is not a realistic scenario. Furthermore, progression requires that space is made available for the caved material. If not, equilibrium will develop at some point due to the internal volume expansion of the rock as it fails.

Comments

In summary, it appears that the critical distance with respect to mechanical interaction between excavations in a repository and a geological feature like Zone 2 is a few tens of metres only. This is obtained from estimates of the rock volumes influenced by repository excavations and the conceptual understanding of Zone 2, as discussed earlier. A brief survey of more complex and large-scale modes of excavation-induced instability verified in mining practice does not alter this view, because geological and/or excavation geometry conditions required for these phenomena do not apply to the present situation. It is important to point out, however, that this conclusion relies upon the interpretation of Zone 2 as a zone of less competent rock, rather than a distinct feature. It can therefore not be generalized to other types of large scale geological structures. There are several cases in which global stress concentrations have been documented in connection with faults, rock type boundaries etc, as has associated interferences with excavations (e.g. Borg, 1988).

6.5.2 Interference with thermal stress field

The thermal gradients and the associated thermal stress field in the first phase of repository lifetime will be confined to the near-field around deposition drifts/holes. This stage is not considered here.

The far-field thermal disturbance develop over a time scale of hundreds or thousands of years after disposal. Thermal stresses develop concurrently as a result of constrained thermal expansion of the rock. While the process of heat dissipation into the rock as such is well understood, the accompanying mechanical response of large rock masses is not. Most of the existing knowledge on thermomechanical rock behaviour refers to the near-field scale, allowing verification by field testing. This includes results produced from heater test at Stripa in Sweden and from the test sites at Hanford and Climax in the United States. An overview of available data has been presented by Hustrulid (1982).

For the large scale, uncertainties remain as to the role discontinuities and their ability to accommodate thermal expansion. It is possible that such effects will reduce the induced thermal stresses and also reduce fracture apertures. An analysis of the response of Zone 2 to a superimposed thermomechanical field is beyond the scope of this study. For a first estimate, we may extrapolate results from thermomechanical test in near-field scale and accept that as an upper bound estimate for conditions in the large scale. Furthermore, we may assume a thermal source power output according to the KBS-3 disposal concept (maximum canister skin temperature less than 100°C). The resulting stress field will vary with time and both tensile and compressive stresses will occur. For the given assumptions, magnitudes as derived from a theoretical calculation would not be expected to exceed values of a few Megapascals. This should be compared with (and superimposed to) the preexisting stress field. It is difficult to imagine that the additional, thermomechanical

load would have any significant effects that would influence the minimum distance to a fracture zone. The main conclusion, however, is that knowledge in this field need to be improved.

7 HYDROMECHANICAL CONDITIONS

7.1 Present conditions

According to measurement results presented in chapter 3, the normal stress components at 250 m depth (corresponding to Zone 2) are:

maximum horizontal stress,	$\sigma_{h1} = 12.7$ MPa
minimum horizontal stress,	$\sigma_{h2} = 8.6$ MPa
mean horizontal stress,	$\sigma_H = 10.7$ MPa
vertical stress,	$\sigma_V = 6.6$ MPa

The difference in vertical versus horizontal stress has been thought of as possibly responsible for the anomalously high hydraulic transmissivity of Zone 2. This hypothesis can be checked against general background data on stress-transmissivity relationships.

A considerable amount of experiments have been reported, in which stresses acting on discontinuities have been altered, and the response in terms of water transport characteristics determined (see e.g. Barton and Stephansson, 1990). Most of the experiments refer to laboratory scale, and to effects of the normal stress acting on the discontinuity only. A lesser amount of data is available from testing in block-scale, excavation scale and/or under more complex stress conditions. Dershowitz et al. (1991) compiled some of the data available, relating normal stress to fracture transmissivity. They found that most results generally fitted into a relationship of the form,

$$\frac{T}{T_0} = \left(\frac{\sigma}{\sigma_0}\right)^{-\beta} \quad (9)$$

where T_0 and T denotes transmissivity before -and after the stress change, σ_0 and σ the initial and final normal stress acting across the discontinuity. The coefficient β varies approximately within the range 0.2-2.0. In our case, we apply

this relationship to estimate the transmissivity difference to be expected as a consequence of the very moderate "stress change" from 6.6 MPa (vertical stress at 250 m) to 10.7 MPa (mean horizontal stress at 250 m). Inserting these values, we obtain:

For $\beta = 0.2$: transmissivity changes by a factor of 1.1

For $\beta = 2.0$: transmissivity changes by a factor of 2.6

This general result can be compared to transmissivity data obtained for the fracture zones at Finnsjön. The assumptions are i) that steeply dipping zones are subjected to a normal stress equal to the mean horizontal stress as given above, while the normal stress acting on Zone 2 is the vertical stress; ii) differences in other stress components than the normal stress across the zone does not affect transmissivity (necessary assumption because Eq. (9) considers only the latter component), and iii) scale effects are not significant.

Table 10 has been reproduced from Anderson et al. (1991) and shows condensed-form data on key parameters of seven of the fracture zones identified at Finnsjön. Besides large general variation in transmissivity, it is seen that the steeply dipping zones (1, 5, 6 and 10) exhibit values that are a factor $4 \cdot 10^1$ to $4 \cdot 10^5$ less than those of Zone 2. Thus, the measured difference is much more pronounced than was predicted above using Eq. (9). The relevance of the comparison can perhaps be questioned, because the data in Table 10 are bulk properties, representing entire zones, whilst Eq. (9) refers to single discontinuities. However, if the resolution was increased to study individual discontinuities at Finnsjön, the water-bearing features within Zone 2 would stand out as even more anomalous in terms of high transmissivity, than does Zone 2 as a whole.

An other observation from Table 10 is that flat lying zones others than Zone 2, i.e. number 9 and 11, do not show remarkably high transmissivities. This does not preclude the existence of a stress-transmissivity relationship. It just shows that to evaluate a possible stress-transmissivity relationship, one has to consider the geological history of each zone, and the resulting, local scale characteristics of constituent fracture systems.

The conclusion is thus that background data on stress-transmissivity relationships for discontinuities can not explain the high transmissivity of Zone 2 (or parts thereof) as a result of low normal (vertical) stress. This conclusion is in line both with experiences from the Swedish study site investigation program, and with general mining experience.

Table 10. Estimated geometrical and hydraulic properties of fracture zones at Finnsjön. From Andersson et al. (1991).

Fracture zone	Vertical depth (m)	Width (m)	Inclin. (degrees)	T (m^2/s)	K (m/s)
1	55-75	20	75SE	$1-5 \cdot 10^{-4}$	$5-25 \cdot 10^{-6}$
2	100-300	100	16SW	$2-4 \cdot 10^{-3}$	$2-4 \cdot 10^{-5}$
5	170-180	5	60SW	$5-15 \cdot 10^{-5}$	$5-50 \cdot 10^{-6}$
	320-350			$1-2 \cdot 10^{-5}$	$1-5 \cdot 10^{-6}$
	550-560			$1-2 \cdot 10^{-6}$	$1-5 \cdot 10^{-7}$
6	515-520	5	60SW	$1-5 \cdot 10^{-8}$	$1-10 \cdot 10^{-9}$
9	105-160	50	15SW	$1-5 \cdot 10^{-6}$	$1-10 \cdot 10^{-8}$
10	45-48	5	85SW	$1-5 \cdot 10^{-8}$	$1-10 \cdot 10^{-9}$
11	16-120	100	35SW	$1-5 \cdot 10^{-4}$	$1-5 \cdot 10^{-6}$
	82-174			$5-10 \cdot 10^{-4}$	$5-10 \cdot 10^{-6}$
	364-394			$1-5 \cdot 10^{-4}$	$1-5 \cdot 10^{-6}$
	364-436			$5-10 \cdot 10^{-7}$	$5-10 \cdot 10^{-9}$

7.2 Glaciation and deglaciation

Glaciation will increase normal stresses in all directions, to all probability accompanied by decreased hydraulic transmissivity. Horizontal discontinuities will be subjected to the largest change in normal stress (6 to 36 MPa, i.e. a factor of 6 for the case of 3 km ice). Equation (9) predicts a decrease in transmissivity of about one order of magnitude for this stress change.

Deglaciation is again much more complex. As was discussed in chapter 6, loading mechanism include:

- Rapid vertical unloading, possibly accompanied by development or reactivation of sheeting phenomena
- Horizontal unloading to an unknown extent and at an unknown rate
- Local stress concentrations near ice edges, including shear components in the horizontal directions
- Elevated pore pressures, promoting shear displacements in discontinuities, and possibly also causing joint separation.

It is clear that these loadings and associated deformations, taken by themselves or in combinations, represent mechanical changes of magnitudes enough to significantly alter water transport characteristics. Any meaningful quantitative assessment of these effects, however, would require a systematic approach, thorough analysis, and input data in terms of stresses and joint mechanical properties that are much more refined than the crude estimates given in previous chapters. The topic will therefore not be further treated here.

8 CONCLUDING REMARKS

The conceptual understanding of Zone 2 that has emerged during the present work shows that there is, mechanically speaking, no sharp contrast or boundary between the rock mass within the zone, and the host bedrock. It rather appears that Zone 2 forms an integrated part of the continuous rock mass - though exhibiting somewhat different mechanical characteristics compared to its surroundings. The prerequisite for this interpretation is, of course, that the scale of observation is large enough that joints and fractures within the rock mass need not be considered individually. The higher fracture frequency within Zone 2 reduces overall rock mass quality. In terms of common engineering rock mass classification indexes, however, the zone horizon would still, taken as whole, qualify as fair rock. Estimates of bulk rock mass deformation modulus for the zone horizon show values that are a factor of 2 or, at most, 3 less than for the over -and underlying rock mass. This may seem like a drastic difference, but has little effect in terms of in-situ stress conditions.

Given the current stress field as determined by measurements at Finnsjön, it is not likely that Zone 2 creates any major stress anomaly on a large scale. This is a consequence of its mechanically diffuse nature. It is emphasized that this conclusion refers to Zone 2 only; It is well known from mining and rock engineering that more distinct large-scale discontinuities can alter stress conditions significantly.

The question of stress anomalies in the proximity of fracture zones is of concern with respect to selecting criteria for the minimum distance between fracture zones and repository excavations. A brief survey of the forms of mechanical disturbances to be expected from the relatively small excavations being considered, show that these are confined to the excavation near-field. Thus, to avoid mechanical interaction between a fracture zone like Zone 2 (characterized by very local stress field disturbance, if any at all) and an hypo-

thetical repository excavation (near-field disturbance only) is suggested that a minimum distance of about 100 m would be sufficient. The other mechanical perturbation imposed by a repository is the thermomechanical stress field. This will develop successively over a long period of time (thousands of years) and ultimately involve a very large rock volume. Interaction with large-scale features like fracture zones will therefore inevitably occur. The current understanding (also supported by this study) is that this interaction will not be significant with respect to repository integrity, but more work in this area would be recommended.

Stress changes imposed by glaciation represent the most significant source of natural change in mechanical loading conditions that may be expected during repository lifetime. Estimates of stress conditions during periods of glaciation and deglaciation have therefore been derived, in order to evaluate possible impact on structures like Zone 2. Vertical stress can be estimated within reasonable confidence, because the driving mechanism is gravity, and stress magnitudes are simply proportional to the thickness of the overlying ice sheet. The ratio is approximately 10 MPa stress increase per kilometre ice thickness. Horizontal stresses are more difficult to predict, because there are uncertainties as to generating mechanisms. Estimates referring to a depth of 250 m (corresponding to Zone 2) spans the approximate interval 20-35 MPa. The upper bound estimate assumes development of horizontal creep deformations during glaciation, as a consequence of the excessive vertical stress.

In terms of mechanical status of the rock mass, glaciation periods are characterized by stable conditions. This is due to increased confinement in all directions, interlocking structures and prohibiting shear movements. This is most likely reflected by lower rock mass permeability, as compared to current conditions.

In contrast to glaciation, deglaciation periods are characterized by a complex and rapid sequence of stress changes. A number of more or less quantifiable loading mechanisms can be identified, including:

- Rapid unloading of vertical stress. This occurs concurrently with decrease of ice sheet thickness.
- Unloading of induced horizontal stress. This process is not well understood. Due to creep effects, the horizontal destressing may commence offset in time, in relation to vertical unloading. This implies periods of large stress anisotropy synonymous to large shear stresses.
- Local stress concentrations near retreating ice margins.
- Excessive pore water pressures in discontinuities. This can result from pressurized ice bed meltwater or ice lakes, being hydraulically interconnected to bedrock groundwater.

It is conceivable that the complex interaction of these loadings triggers reactivation and permanent changes of structures at shallow depth (such as Zone 2). Modes of deformation that can be envisaged include:

- opening-up of gently dipping fractures due to drastically decreased normal(vertical) stress, possibly assisted by excessive water pressures.
- shear displacements initiated by increased deviatoric stresses and possibly assisted by excessive water pressures.
- reactivation of subhorizontal, extension-type fractures commonly referred to as sheet-fractures. Sheeting phenomena are commonly observed in brittle rock down to 100-200 m depth, and superficial reactivation related to glaciation

periods has been proven. This strongly suggest that similar phenomena can be expected in subhorizontal fractures within Zone 2.

It is thus concluded that deglaciation periods are critical with regard to the mechanical and hydraulic characteristics of Zone 2, as observed today, and with regard to potential changes during repository lifetime. Further research, aimed at quantifying loading mechanisms involved as well as rock mass response appears to be motivated. Means available to improve knowledge include:

- Physical experiments to establish relevant in-situ parameters
- Analysis using advanced numerical models, capable of resembling complex material behaviour and loading systems
- Collecting and evaluating geological evidences of effects of glaciation/deglaciation.

These tools need to be employed in combination to yield optimum results. The establishment of the Hard Rock Laboratory (HRL) will open new opportunities to conduct experiments in-situ. However, the possibilities to collect valid data from experiments will remain severely limited, due to the sampling problem involved, and to the difference in scale between the problems considered and any realistic loading experiment. This reflects into similar drawbacks being attached to numerical modelling results, because they are entirely dependent upon the quality of input data. The probably most rewarding approach to improve the state of proven knowledge is the systematic collection and analyses of appropriate geological evidences of past glaciations. Ideas that perhaps could be further explored include improved methods to distinguish postglacial reactivation of fractures at depth, or comparisons of bedrock conditions between glaciated and non-glaciated regions.

Addressing, finally, the observed, hydraulic characteristics of Zone 2 from a mechanical standpoint, it is felt that the present work contributes only rather marginally. This is so because the task implies combining the crude estimates derived for the site-specific mechanical conditions, with complex hydromechanics relationships. These relationships are currently subject to intense research on a fundamental level, and exploring their nature goes far beyond the scope of the present work. A valid conclusion, however, is that the current stress field alone can not explain the observed, anomalously high transmissivity of certain structures within Zone 2. This can be stated on the basis of available experimental data on stress-transmissivity relationship of fractures, and can also be predicted from practical rock engineering experience.

9 REFERENCES

- Ahlbom, K., Andersson, P., Ekman, L., Gustavsson, E., Smellie, J. and E.-L. Tullborg, 1986. Preliminary investigations of fracture zones in the Brändan area, Finnsjön study site. SKB TR 86-05, Swedish Nuclear Fuel and Waste Management Co., Stockholm, 155 p.
- Ahlbom, K. and S Tirén, 1989. Overview of geologic and hydrogeologic character of the Finnsjön site and its surroundings. SKB AR 89-08. Swedish Nuclear Fuel and Waste Management Co., Stockholm, 45 p.
- Ahlbom, K. and J.A.T. Smellie, (Eds.) 1989. Characterization of fracture zone 2, Finnsjön study-site. SKB TR 89-19, Swedish Nuclear Fuel and Waste Management Co., Stockholm.
- Ahlbom, K. and S. Tirén, 1991. Overview of geologic and hydrologic conditions at the Finnsjön site and its surroundings. SKB TR 91-08. Swedish Nuclear Fuel and Waste Management Co., Stockholm, 52 p.
- Andersson, J-E., Nordqvist, R., Nyberg, G., Smellie, J. and S. Tirén, 1991. Hydrogeological conditions in the Finnsjön area. Compilation of data and conceptual model. SKB TR 91-24. Swedish Nuclear Fuel and Waste Management Co., Stockholm.
- Amis, H.W. and C.F. Lee, 1984. Glacially induced stress changes. Proc. Workshop on Transitional Processes. Atomic Energy of Canada Limited, AECL-7822, Pinawa, Manitoba, Canada, pp. 123-135.
- Bjarnason, B. and O. Stephansson, 1988. Hydraulic fracturing stress measurements in borehole Fi-6 Finnsjön study site, central Sweden. SKB AR 88-54, Swedish Nuclear Fuel and Waste Management Co., Stockholm, 40 p.

- Bandis, S.C., Lumsden, A.C. and N.R. Barton, 1983. Fundamentals of rock joint deformation. *Int. J. Rock Mech. Min. Sci. & Geomech. Abstr.*, Vol. 20, No. 6, pp. 249-268.
- Barton, N., Lien, R. and J. Lunde, 1974. Engineering classification of rock masses for the design of tunnel support. *Rock Mechanics*, 6, pp. 189-236.
- Barton, N., 1976. Recent experiences with the Q system in tunnel support design. In: Z.T. Bieniawski (Editor), *Proc. Symp. on Exploration for Rock Engineering*. Johannesburg, Vol. 1, pp. 107-115.
- Barton, N. and V. Choubey, 1977. The shear strength of rock joints in theory and practice. *Rock Mechanics*, Vol. 10/1-2, pp. 1-54.
- Barton, N., 1983. Application of Q system and index tests to estimate shear strength and deformability of rock masses. *Proc. Int. Symp. Engineering Geology and Underground Construction*. Sept. 1983, Lisbon. A.A. Balkema, pp. II.51-II.70.
- Barton, N. and O. Stephansson, (Eds.) 1990. *Proceedings of the International Symposium on Rock Joints*, Loen, Norway, 4-6 June, 1990. Balkema, Rotterdam, 816 p.
- Bieniawski, Z.T., 1978. Determining the rock mass deformability: Experience from case histories. *Int. J. Rock Mech. Min. Sci. & Geomech. Abstr.*, Vol 15, pp. 237-247.
- Borg, T., 1983. Prediction of rock failures in mines with application to the Näsliden Mine in northern Sweden. *Doctoral Thesis 1983:26D*, Luleå University of Technology, Luleå, Sweden.

- Borg, T., 1988. Drifting with destress blasting - Rock mechanics investigations at the 815 m level in the MalMBERGET Mine. Report BeFo 331:1/88, Swedish Rock Engineering Research Foundation, Stockholm (in swedish, summary in english).
- Cameron-Clarke, I.S., and S. Budavari, 1981. Correlation of rock mass classification parameters obtained from borecore and in-situ observations. Engineering Geology, Vol. 17, pp. 19-53.
- Carlsson, A., 1979. Characteristic features of a superficial rock mass in southern central Sweden - Horizontal and sub-horizontal fractures and filling material. Striae, Vol. 11, 79 p.
- Coon, A.F. and A.H. Merritt, 1970. Predicting in-situ modulus of deformation using rock quality indexes. A.S.T.M. Special Technical Publication 477, A.S.T.M., Philadelphia, pp. 154-173.
- Dershowitz, B., Wallman, P. and S. Kindred, 1991. Discrete fracture modelling for the Stripa site characterization and validation drift inflow predictions. Stripa Project, TR 91-16, Swedish Nuclear Fuel and Waste Management Co., Stockholm.
- Hoek, E. and E.T. Brown, 1980. Underground excavations in rock. Inst. of Min. and Metall., London, 527 p.
- Heuze, F.E., 1980. Scale effects in the determination of rock mass strength and deformability. Rock Mechanics 12, pp. 167-192.
- Hustrulid, W., 1983. Design of geomechanical experiments for radioactive waste disposal - A rethink. Proc. Int. Symp. on Field Measurements in Geomechanics, Zurich, September 5-8. Balkema, Rotterdam, pp. 1381-1408.

- Koerner, F.M., 1984. Conditions at the ice/rock interface of large ice sheets. Proc. Workshop on Transitional Processes. Atomic Energy of Canada Limited, AECL-7822, Pinawa, Manitoba, Canada, pp. 200-211.
- Lee, C.F. and H.W. Asmis, 1979. An interpretation of the crustal stress field in northeast North America. Proc. 20th U.S. Symp. on Rock Mechanics, Austin Texas, pp. 655-662.
- Müller, L., 1974. Rock mass behaviour-determination and application in engineering practice. Proc. 3rd Congr. Rock Mech., Vol. 1, Denver, pp. 205-215.
- Müller, B., Fuchs, K., Mastin, L., Gregersen, S., Pavoni, N., Stephansson, O., Ljunggren, C. and M.L. Zoback, 1990. Regional Patterns of stress in Europe. J. Geophys. Res. (in press)
- Pusch, R., Börgesson, L. and S. Knutsson, 1990. Origin of silty fracture fillings in crystalline bedrock. Geologiska Föreningens i Stockholm Förhandlingar. Vol. 112, pp. 209-213.
- Rosengren, L. and O. Stephansson, 1990. Distinct element modelling of the rock mass response to glaciation at Finnsjön, central Sweden. SKB TR 90-40. Swedish Nuclear Fuel and Waste Management Co., Stockholm.
- Stephansson, O., Dahlström, L-O., Bergström, K., Myrvang, A., Fjeld, O.K., Hanssen, T.H., Särkkä, P. and A. Väätäinen, 1987. Fennoscandian rock stress data base - FRSD. Research report TULEA 1987:06, Luleå University of Technology, Luleå, Sweden, 35 p.

- Stephansson, O. and Ljunggren, C., 1988. Swedish stress data for the World Stress Map Project and geological implications of the data in FRSDb. In Proc. Workshop on Nordic Rock Stress Data, Trondheim, SINTEF Report, October 1988.
- Swan, G., 1977. The mechanical properties of the rocks in Stripa, Kråkemåla, Finnsjön, and Blekinge. KBS TR-48, Swedish Nuclear Fuel and Waste Management Co., Stockholm, 54 p.
- Talbot, C.J., 1990. Problems posed to a bedrock radwaste repository by gently dipping fracture zones. Geologiska Föreningens i Stockholm Förhandlingar. Vol. 112, Pt. 4, pp. 355-359.
- Tirén, S., 1991. Personal communication.
- Voight, B. and B.H.P. St. Pierre, 1974. Stress history and rock stress. Proc. 3rd Congr. Int. Soc. Rock Mech., Denver, Colorado, 2, pp. 580-582.

List of SKB reports

Annual Reports

1977-78

TR 121

KBS Technical Reports 1 – 120

Summaries

Stockholm, May 1979

1979

TR 79-28

The KBS Annual Report 1979

KBS Technical Reports 79-01 – 79-27

Summaries

Stockholm, March 1980

1980

TR 80-26

The KBS Annual Report 1980

KBS Technical Reports 80-01 – 80-25

Summaries

Stockholm, March 1981

1981

TR 81-17

The KBS Annual Report 1981

KBS Technical Reports 81-01 – 81-16

Summaries

Stockholm, April 1982

1982

TR 82-28

The KBS Annual Report 1982

KBS Technical Reports 82-01 – 82-27

Summaries

Stockholm, July 1983

1983

TR 83-77

The KBS Annual Report 1983

KBS Technical Reports 83-01 – 83-76

Summaries

Stockholm, June 1984

1984

TR 85-01

Annual Research and Development Report 1984

Including Summaries of Technical Reports Issued during 1984. (Technical Reports 84-01 – 84-19)

Stockholm, June 1985

1985

TR 85-20

Annual Research and Development Report 1985

Including Summaries of Technical Reports Issued during 1985. (Technical Reports 85-01 – 85-19)

Stockholm, May 1986

1986

TR 86-31

SKB Annual Report 1986

Including Summaries of Technical Reports Issued during 1986

Stockholm, May 1987

1987

TR 87-33

SKB Annual Report 1987

Including Summaries of Technical Reports Issued during 1987

Stockholm, May 1988

1988

TR 88-32

SKB Annual Report 1988

Including Summaries of Technical Reports Issued during 1988

Stockholm, May 1989

1989

TR 89-40

SKB Annual Report 1989

Including Summaries of Technical Reports Issued during 1989

Stockholm, May 1990

1990

TR 90-46

SKB Annual Report 1990

Including Summaries of Technical Reports Issued during 1990

Stockholm, May 1991

1991

TR 91-64

SKB Annual Report 1991

Including Summaries of Technical Reports Issued during 1991

Stockholm, April 1992

Technical Reports

List of SKB Technical Reports 1992

TR 92-01

GEOTAB. Overview

Ebbe Eriksson¹, Bertil Johansson²,
Margareta Gerlach³, Stefan Magnusson²,
Ann-Chatrin Nilsson⁴, Stefan Sehlstedt³,
Tomas Stark¹

¹SGAB, ²ERGODATA AB, ³MRM Konsult AB

⁴KTH

January 1992

TR 92-02

Sternö study site. Scope of activities and main results

Kaj Ahlbom¹, Jan-Erik Andersson², Rune Nordqvist²,
Christer Ljunggren³, Sven Tirén², Clifford Voss⁴

¹Conterra AB, ²Geosigma AB, ³Renco AB,

⁴U.S. Geological Survey

January 1992

TR 92-03

Numerical groundwater flow calculations at the Finnsjön study site – extended regional area

Björn Lindbom, Anders Boghammar

Kemakta Consultants Co, Stockholm

March 1992

TR 92-04

Low temperature creep of copper intended for nuclear waste containers

P J Henderson, J-O Österberg, B Ivarsson

Swedish Institute for Metals Research, Stockholm

March 1992

TR 92-05

Boyancy flow in fractured rock with a salt gradient in the groundwater – An initial study

Johan Claesson

Department of Building Physics, Lund University,
Sweden

February 1992

TR 92-06

Characterization of nearfield rock – A basis for comparison of repository concepts

Roland Pusch, Harald Hökmark

Clay Technology AB and Lund University of
Technology

December 1991

TR 92-07

Discrete fracture modelling of the Finnsjön rock mass: Phase 2

J E Geier, C-L Axelsson, L Hässler,

A Benabderrahmane

Golden Geosystem AB, Uppsala, Sweden

April 1992

TR 92-08

Statistical inference and comparison of stochastic models for the hydraulic conductivity at the Finnsjön site

Sven Norman

Starprog AB

April 1992

TR 92-09

Description of the transport mechanisms and pathways in the far field of a KBS-3 type repository

Mark Elert¹, Ivars Neretnieks², Nils Kjellbert³,
Anders Ström³

¹Kemakta Konsult AB

²Royal Institute of Technology

³Swedish Nuclear Fuel and Waste Management Co

April 1992

TR 92-10

Description of groundwater chemical data in the SKB database GEOTAB prior to 1990

Sif Laurent¹, Stefan Magnusson²,

Ann-Chatrin Nilsson³

¹IVL, Stockholm

²Ergodata AB, Göteborg

³Dept. of Inorg. Chemistry, KTH, Stockholm

April 1992

TR 92-11

Numerical groundwater flow calculations at the Finnsjön study site – the influence of the regional gradient

Björn Lindbom, Anders Boghammar

Kemakta Consultants Co., Stockholm, Sweden

April 1992

TR 92-12

HYDRASTAR – a code for stochastic simulation of groundwater flow

Sven Norman

Abraxas Konsult

May 1992

TR 92-13

Radionuclide solubilities to be used in SKB 91

Jordi Bruno¹, Patrik Sellin²

¹MBT, Barcelona Spain

²SKB, Stockholm, Sweden

June 1992

TR 92-14

Numerical calculations on heterogeneity of groundwater flow

Sven Follin

Department of Land and Water Resources,

Royal Institute of Technology

June 1992

TR 92-15

Kamlunge study site.

Scope of activities and main results

Kaj Ahlbom¹, Jan-Erik Andersson²,
Peter Andersson², Thomas Ittner²,
Christer Ljunggren³, Sven Tirén²

¹Conterra AB

²Geosigma AB

³Renco AB

May 1992

TR 92-16

**Equipment for deployment of canisters
with spent nuclear fuel and bentonite
buffer in horizontal holes**

Vesa Henttonen, Miko Suikki
JP-Engineering Oy, Raisio, Finland
June 1992

TR 92-17

**The implication of fractal dimension in
hydrogeology and rock mechanics
Version 1.1**

W Dershowitz¹, K Redus¹, P Wallmann¹,
P LaPointe¹, C-L Axelsson²
¹Golder Associates Inc., Seattle, Washington, USA
²Golder Associates Geosystem AB, Uppsala,
Sweden
February 1992

TR 92-18

**Stochastic continuum simulation of
mass arrival using a synthetic data set.
The effect of hard and soft conditioning**

Kung Chen Shan¹, Wen Xian Huan¹, Vladimir
Cvetkovic¹, Anders Winberg²
¹Royal Institute of Technology, Stockholm
²Conterra AB, Gothenburg
June 1992

TR 92-19

**Partitioning and transmutation.
A review of the current state of the art**

Mats Skålberg, Jan-Olov Liljenzin
Department of Nuclear Chemistry,
Chalmers University of Technology
October 1992

TR 92-20

**SKB 91
Final disposal of spent nuclear fuel.
Importance of the bedrock for safety**

SKB
May 1992

TR 92-21

The Protogine Zone.

**Geology and mobility during the last
1.5 Ga**

Per-Gunnar Andréasson, Agnes Rodhe
September 1992

TR 92-22

Klipperås study site.

Scope of activities and main results

Kaj Ahlbom¹, Jan-Erik Andersson²,
Peter Andersson², Tomas Ittner²,
Christer Ljunggren³, Sven Tirén²

¹Conterra AB

²Geosigma AB

³Renco AB

September 1992

TR 92-23

**Bedrock stability in Southeastern
Sweden. Evidence from fracturing in
the Ordovician limestones of Northern
Öland**

Alan Geoffrey Milnes¹, David G Gee²
¹Geological and Environmental Assessments
(GEA), Zürich, Switzerland
²Geologiska Institutionen, Lund, Sweden
September 1992

TR 92-24

Plan 92

**Costs for management of the
radioactive waste from nuclear power
production**

Swedish Nuclear Fuel and Waste Management Co
June 1992

TR 92-25

**Gabbro as a host rock for a nuclear
waste repository**

Kaj Ahlbom¹, Bengt Leijon¹, Magnus Liedholm²,
John Smellie¹
¹Conterra AB
²VBB VIAK
September 1992

TR 92-26

**Copper canisters for nuclear high level
waste disposal. Corrosion aspects**

Lars Werme, Patrik Sellin, Nils Kjellbert
Swedish Nuclear Fuel and Waste Management
Co, Stockholm, Sweden
October 1992

TR 92-27

Thermo-mechanical FE-analysis of butt-welding of a Cu-Fe canister for spent nuclear fuel

B L Josefson¹, L Karlsson², L-E Lindgren²,
M Jonsson²

¹Chalmers University of Technology, Göteborg,
Sweden

²Division of Computer Aided Design, Luleå
University of Technology, Luleå, Sweden

October 1992