

Report

**P-16-08**

October 2016



Prototype Repository  
– Sensor data report  
(Period 010917–150101)  
Report No 27

Reza Goudarzi

SVENSK KÄRNBRÄNSLEHANTERING AB

SWEDISH NUCLEAR FUEL  
AND WASTE MANAGEMENT CO

Box 250, SE-101 24 Stockholm  
Phone +46 8 459 84 00  
skb.se

SVENSK KÄRNBRÄNSLEHANTERING



ISSN 1651-4416

**SKB P-16-08**

ID 1536489

October 2016

# **Prototype Repository – Sensor data report (Period 010917–150101) Report No 27**

Reza Goudarzi, Clay Technology AB

This report concerns a study which was conducted for Svensk Kärnbränslehantering AB (SKB). The conclusions and viewpoints presented in the report are those of the authors. SKB may draw modified conclusions, based on additional literature sources and/or expert opinions.

Data in SKB's database can be changed for different reasons. Minor changes in SKB's database will not necessarily result in a revised report. Data revisions may also be presented as supplements, available at [www.skb.se](http://www.skb.se).

A pdf version of this document can be downloaded from [www.skb.se](http://www.skb.se).

© 2016 Svensk Kärnbränslehantering AB





# Abstract

The Prototype Repository Test consists of two sections. The installation of the first section of Prototype Repository was made during summer and autumn 2001 and section 2 was installed in spring and summer 2003. The retrieval of the outer section started at the end of November 2010 and finished at the end of December 2011. All measurements from the sensor in section 2 have been presented in the sensors data report SKB P-13-39 (Goudarzi 2014).

After the retrieval of the outer section, validation tests of the total pressure sensors of type Geocon were made. It was then discovered that, the up to 2012-01-01 used calibration values (linear equation) gave inaccurate readings of the total pressure. The improvements of the readings were large when a polynomial calibration equation was used instead. At the presentation of the data in this report the polynomial equation was used.

This report presents data from measurements in the Prototype Repository section I during the period 2001-09-17 to 2015-01-01. The report is organized so that the actual measured results are shown in Appendix 1–5, where Appendix 5 deals with measurement of water pressure in the rock (by VBB/VIK). The main report and Appendix 1–4 deal with the rest of the measurements.

## Section 1

The following measurements are made in the bentonite in each of the two instrumented deposition holes in section 1 (1 and 3): Temperature is measured in 32 points, total pressure in 27 points, pore water pressure in 14 points and relative humidity in 37 points. Temperature is also measured by all relative humidity gauges. Every measuring point is related to a local coordinate system in the deposition hole.

The following measurements are made in the backfill in section 1. Temperature is measured in 20 points, total pressure in 18 points, pore water pressure in 23 points and relative humidity in 45 points. Temperature is also measured by all relative humidity gauges. Furthermore, water content is measured by an electric chain in one section. Every measuring point is related to a local coordinate system in the tunnel.

The following measurements are made on the surface of the canisters in section 1: Temperature is measured every meter along two fiber optic cables. Furthermore, displacements of the canister in hole 3 are measured with 6 gauges.

The following measurements are made in the rock in section 1: Temperature is measured in 37 points in boreholes in the floor. Water pressure is measured in altogether 64 points in 17 boreholes all around the tunnel.

## Conclusions

A general conclusion is that the measuring systems work well during this measuring period. 275 (excluding water pressure sensors in the rock) out of totally 363 installed sensors in section 1 are out of order, the majority being RH-sensors that fail at water saturation. Furthermore almost all suction sensors placed in the backfill is not giving reliable values due to high degree of saturation (RH 100 %).

The drainages of the inner section together with the drainage of the outer plug were closed at the beginning of November 2004. The pressure (pore pressure and total pressure) both in the backfill and in some parts of the buffer in the six deposition holes increased after this date. At the beginning of December 2004 damages on the cables to the installed heaters in two of the canisters (canister No 2 and No 6) were observed. The power to all of the canisters was then switched off and the drainage of the tunnel was opened. The power of canisters was switched on again on December 15 except for canister No 2 where all of the installed heaters were out of order. The drainage of the tunnel was kept open. The increase in pore pressure affected the saturation rate of the backfill and the buffer. The failure of the heaters in canister No 2 and the time when the power was switched off affected also

the measurements especially the temperature measurements in the buffer. A packer installed in the rock in section 1 was broken around the 18th of April 2006. The broken packer caused an increase in the measured total and pore pressure in the backfill in section 1. The work with the new tunnel near by the Prototype site which started in April 2007 has affected the pressure, water outflow and saturation of the backfill. Some packers installed in the rock in section 2 have been reinstalled because of leakage at 16th of December 2014. The strong increasing of measured total and pore pressure in the backfill in section 1 and even in C4 for hole 1 and hole 3 in the end of this measuring period probably depends on this activity.

# Sammanfattning

Prototypförväret består av två sektioner. Den första sektionen installerades under sommaren och hösten 2001 och Sektion 2 installerades under våren och sommaren 2003. I slutet av november 2010 började arbetet med att demontera den yttre sektionen av försöket och demonteringen har avslutat i december 2011.

I denna rapport presenteras data från mätningar i Prototypförväret för section I under perioden 2001-09-17 till 2015-01-01. Rapporten är uppdelad så att själva mätresultaten redovisas i Appendix 1–5, Appendix 5 behandlar vattentrycksmätningar i berget (handhas av VBB/VIK).

I själva huvudrapporten och Appendix 1–4 behandlas alla övriga mätningar.

Efter demontering av yttre sektionen, utfördes en utvärdering av totaltrycksgivarna av fabrikket Geocon. Då upptäcktes att de använda kalibreringsparametrarna och den linear ekvationen för totaltryck inte var optimala. Den alternativa polynoma ekvationen vid redovisning av data används i den här rapporten vilket gav högre tryck.

## Sektion 1

Följande mätningar görs i bentoniten i vardera av de två instrumenterade deponeringshålen i Sektion 1 (1 och 3): Temperatur mäts i 32 punkter, totaltryck i 27 punkter, porvattentryck i 14 punkter och relativa fuktigheten i 37 punkter. Temperaturen mäts även med relativa fuktighetsmätare. Varje mätpunkt relateras till ett lokalt koordinatsystem i deponeringshålet.

Följande mätningar görs i återfyllningen i Sektion 1: Temperaturen mäts i 20 punkter, totaltryck i 18 punkter, porvattentryck i 23 punkter och relativa fuktigheten i 45 punkter. Temperaturen mäts även med alla relativa fuktighetsmätare. Varje mätpunkt relateras till ett lokalt koordinatsystem i tunneln. Dessutom mäts vatteninnehållet i en sektion med en geoelektrisk mätkedja.

Följande mätningar görs på ytan i kapselns kopparhölje i samtliga 4 kapslar i Sektion 1: Temperaturen mäts varje meter längs två fiberoptiska kablar från två håll. Dessutom mäts förskjutningar av kapseln i hål 3 med 6 givare.

Följande mätningar görs i berget i Sektion 1: Temperatur mäts i borrhål i 37 punkter i golvet. Vattentryck mäts i sammanlagt 64 punkter i 17 borrhål runt hela tunneln.

## Slutsatser

En generell slutsats är att mätsystemen tycks fungera bra under den här mätningens period. 275 av totalt 363 installerade givare i Sektion 1 (med undantag av vattentrycksmätare i berget) fungerar inte. Många av dessa (64 stycken) är RH-mätare som slutar fungera vid vattenmättnad. Portrycket och totaltrycket både i återfyllnaden och i bufferten ökade markant efter stängningen av dränaget. Ökningen av portrycket påverkade också vattenmättnaden i vissa delar av buffert och återfyllnade. Skador observerades på kablarna till de installerade värmarna i två av kapslarna i början av december 2004, varefter effekten till samtliga kapslar stängdes av samtidigt som dräneringen av tunneln öppnades. Effekten till alla kapslar utom kapsel nr. 2 sattes på igen den 15:e december. Skadorna på kablarna till värmarna i kapsel 2 var så omfattande att det inte var möjligt att använda dessa. Dräneringen av tunneln förblev öppen. En packer installerad i berget i Sektion 1 gick sönder kring den 18:e april 2006. Den läckande packern medförde att totaltrycken och portrycken i återfyllningen i Sektion 1 ökade markant. Arbetet med den nya tunneln nära Prototype-tunneln vilket startade i april 2007 har påverkat tryckte, utflödet ur tunneln samt vattenmättnaden av återfyllningen i de båda tunnelsektionerna. Det var ett antal läckande manschetter i yttre sektionen byttes ut i 16:e december 2014 (dag 4836). Denna aktivitet förmodligen medförde den starka ökningen av portryck o totaltryck i återfyllningen Sektion 1 och även i C4 i deponering hål 1 och hål 3 i slutet av den här mätt period.



# Contents

<b>1</b>	<b>Introduction</b>	9
<b>2</b>	<b>Geometry and coordinate systems</b>	11
<b>3</b>	<b>Brief description of the instruments</b>	13
<b>4</b>	<b>Location of instruments in section 1</b>	15
4.1	Strategy for describing the position of each device in the bentonite and rock in and around the deposition holes	15
4.2	Position of each instrument in the bentonite in hole 1 (DA3587G01)	16
4.3	Position of each instrument in the bentonite in hole 3 (DA3575G01)	18
4.4	Instruments on the canister surface in holes 1–4	21
4.5	Position of temperature sensors in the rock	23
4.6	Strategy for describing the position of each device in the backfill in section 1	24
4.7	Position of each instrument in the backfill	26
<b>5</b>	<b>Results and comments for section 1</b>	29
5.1	General	29
5.2	Deposition hole 1	31
5.2.1	Total pressure (App. 1\pages 45–46)	31
5.2.2	Relative humidity (App. 1\pages 47–50)	31
5.2.3	Pore water pressure (App. 1\pages 51–52)	32
5.2.4	Temperature in the buffer (App. 1\pages 52–55)	32
5.2.5	Canister power in dep. hole 1 (App. 1\page 57)	32
5.2.6	Temperature on the canister surface (App. 1\page 58)	33
5.3	Deposition hole 3	33
5.3.1	Total pressure (App. 2\pages 59–61)	33
5.3.2	Relative humidity (App. 2\pages 61–65)	33
5.3.3	Pore water pressure (App. 2\page 66)	34
5.3.4	Temperature in the buffer (App. 2\pages 67–70 and 71)	34
5.3.5	Canister Power in dep. hole 1 (App. 2\page 72)	34
5.3.6	Temperature on the canister surface (App. 2\pages 72–73)	34
5.4	Deposition hole 2	35
5.4.1	Canister power (App. 3\page 75)	35
5.4.2	Temperature on the canister surface (App. 3\pages 76–77)	35
5.5	Deposition hole 4	35
5.5.1	Canister power (App. 3\page 78)	35
5.5.2	Temperature on the canister surface (App. 3\pages 78–79)	35
5.6	Backfill in section 1	35
5.6.1	Total pressure in the backfill (App. 4\pages 81–82)	35
5.6.2	Suction in the backfill (App. 4\pages 83–86)	36
5.6.3	Pore water pressure in the backfill (App. 4\pages 86–88)	36
5.6.4	Temperature in the backfill (App. 4\pages 88–90)	36
5.7	Temperature in the rock	37
5.7.1	Near hole 1 (App. 1\pages 56–57)	37
5.7.2	Near hole 2 (App. 3\page 75)	37
5.7.3	Near hole 3 (App. 2\pages 70–71)	37
5.7.4	Near hole 4 (App. 3\page 77)	37
5.8	Analyze of data from section 1	37
5.8.1	Deposition hole 1	37
5.8.2	Deposition hole 3	39
5.8.3	Backfill	41
	<b>References</b>	43
	<b>Appendix 1</b> Dep. hole 1	45
	<b>Appendix 2</b> Dep. hole 3	59
	<b>Appendix 3</b> Dep. holes 2 and 4	75
	<b>Appendix 4</b> Backfill in section 1	81
	<b>Appendix 5</b> Water pressure measurements in the rock mass	91



# 1 Introduction

The Prototype Repository Test consists of two sections. The installation of the first section of Prototype Repository was made during summer and autumn 2001 and section 2 was installed in spring and summer 2003.

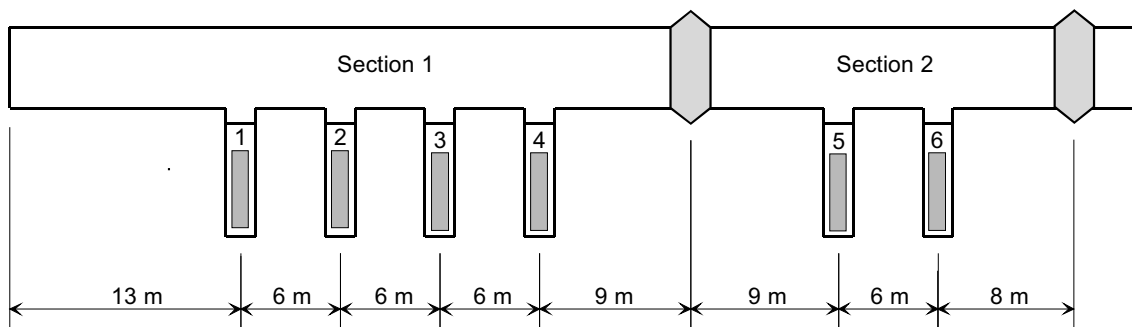
Section 1 consists of four full-scale deposition holes, copper canisters equipped with electrical heaters, bentonite blocks and a deposition tunnel backfilled with a mixture of bentonite and crushed rock and ends with a concrete plug as shown in Figure 1-1. Section 2 consists of two full-scale deposition holes with a backfilled tunnel section and ends also with a concrete plug.

The bentonite buffer in deposition holes 1, 3, 5 and 6, the backfill and the surrounding rock are instrumented with gauges for measuring temperature, water pressure, total pressure, relative humidity, resistivity and canister displacement. The instruments are connected to data collection systems by cables protected by tubes, which are led through the rock in watertight lead throughs.

In general the data for section 1 in this report are presented in diagrams covering the time period 2001-09-17 to 2015-01-01. The time axis in the diagrams represent number of days from start 2001-09-17, which is the day the heating of the canister in hole 1 was started. For section 2 the data had presented in diagrams covering the time period 2003-05-08 to 2011-01-01 in the sensors data report No 25 (Goudarzi 2014).

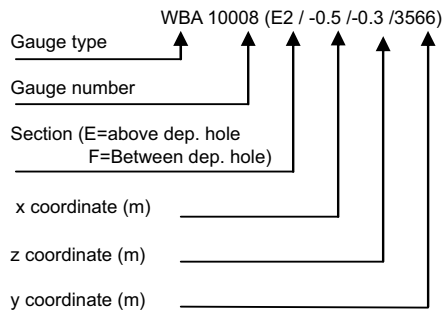
This report consists of several parts. In chapters 2, 3 and 4 a test overview with the positions of those measuring points and a brief description of the instruments are shown. In chapter 5 the measured results from all measurements in section 1, except water pressure in the rock, are presented and commented. The diagrams of those measured results are attached in Appendix 1-4. The result and comment of the measurements of water pressure in the rock is presented separately in Appendix 5.

A quick guide to the position of the instruments in the buffer and backfill is shown in Figure 1-2.

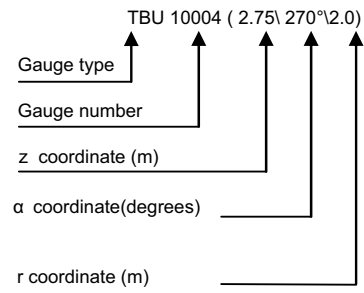


**Figure 1-1.** Schematic view of the Prototype Repository.

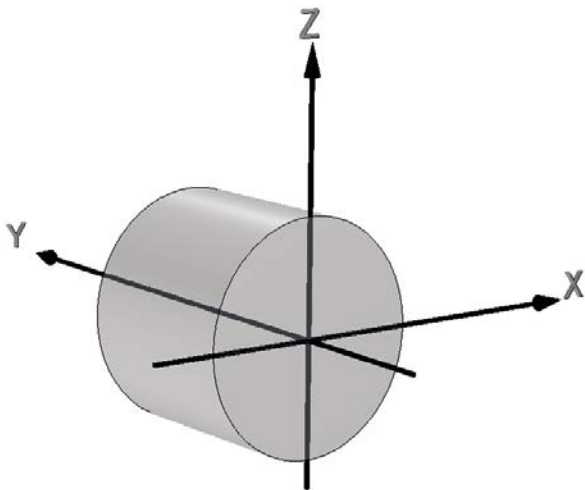
### Transducers in the backfill



### Transducers in dep. holes 1, 3,5 and 6 and in the rock

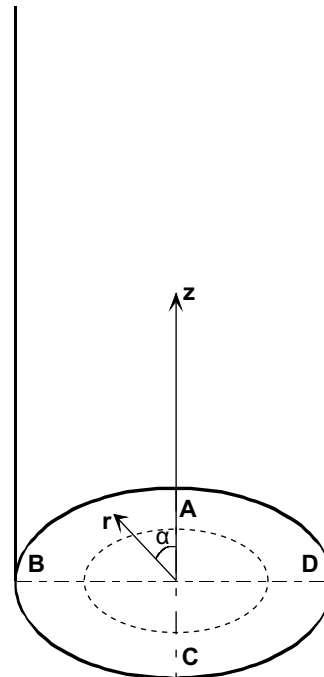


### Coordinate system in backfill



End of tunnel at	Y =3599.8 m
Center dep.hole 1.at	Y =3587 m
Center dep.hole 2 at	Y =3581 m
Center dep.hole 3 at	Y =3575 m
Center dep.hole 4 at	Y =3569 m
Inner plug surface at	Y=3561.4 m
Center dep.hole 5 at	Y =3551 m
Center dep.hole 6 at	Y =3545 m
Outer plug surface at	Y=3538.6 m
Tunnel radius	Z=X =2.5 m

### Coordinate system in dep. holes



Tunnel direction	C-A
Bottom of hole	Z=0
Bottom of canister	Z=0.5
Top of canister	Z=5.400
Upper buffer surface	Z=7.125
Dep. hole radius	r=0.875
Canister radius	r=0.525

Figure 1-2. Quick guide.



## 2 Geometry and coordinate systems

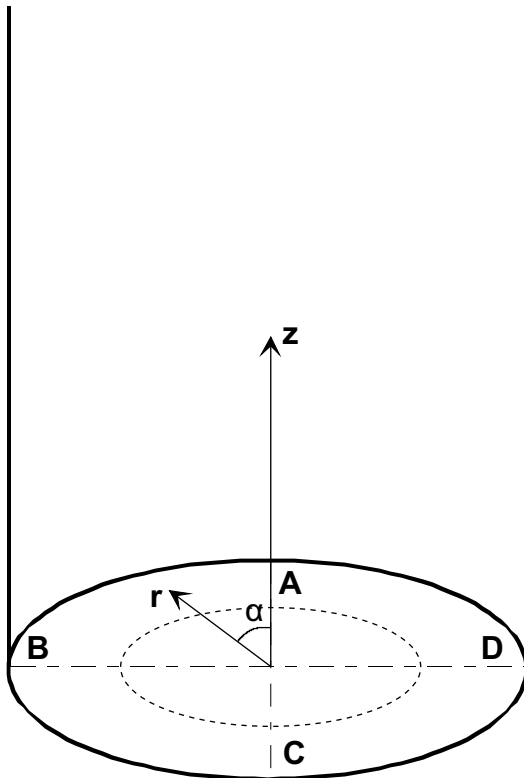
The Prototype Repository consists of two sections as shown in Figure 1-1. The geometry and the coordinate system for the sensors are different for the deposition holes and the tunnel. The temperature sensors in the rock are defined with the same coordinate system as the deposition holes.

### Deposition holes

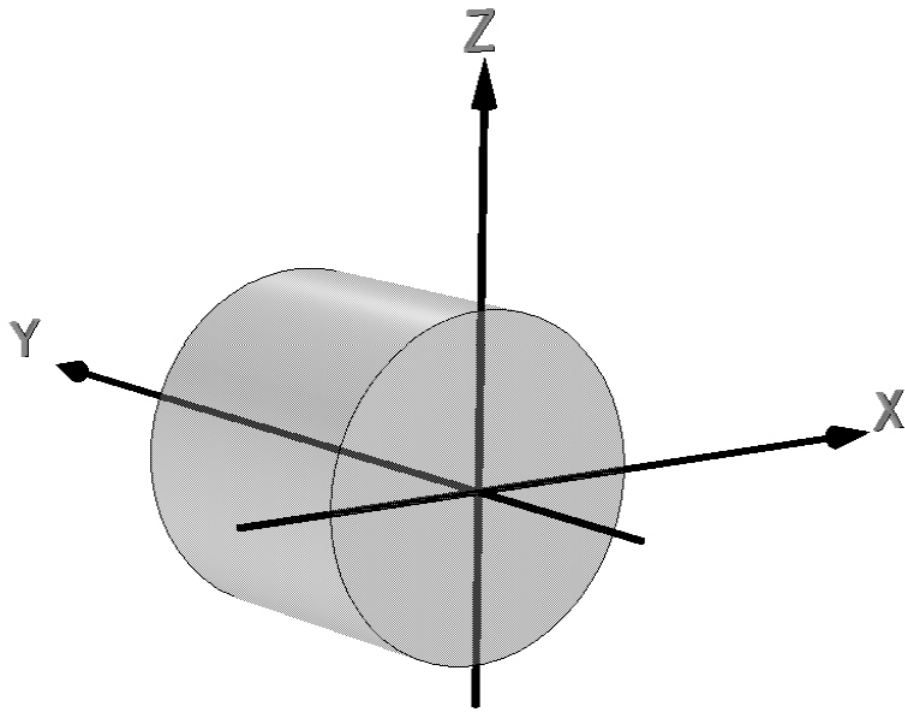
In section 1 the deposition holes are termed 1-4 according to Figure 1-1. The coordinate system for these holes is shown in Figure 2-1. With the  $z$ -axis starting from the cement casting and the angle  $\alpha$  counted anti-clockwise from direction A. Measurements are mainly made in four vertical sections A, B, C and D according to Figure 2-1. Direction A and C are placed in the tunnels axial direction with A headed against the end of the tunnel i.e. almost towards West.

### Tunnel

The coordinate system of the backfill in the tunnel is shown in Figure 3-2. The coordinate  $y$  starts at the entrance on ground, which means that the tunnel ends at  $y = 3599, 8$ . The  $y$ -axis runs in the centre of the tunnel, which means that the tunnel walls intersect the  $z$  and  $x$ -axes at  $\pm 2.5$  m. The  $z$ -coordinate is determined positive upwards and the  $x$ -coordinate is determined positive to the right when facing the end of the tunnel.



*Figure 2-1. Figure describing the instrument planes (A-D) and the coordinate system used when describing the instrument positions.*



*Figure 2-2. Coordinate system of the tunnel.*

### **3 Brief description of the instruments**

The different standard instruments that are used in the buffer, backfill and rock (temperature) are briefly described in this chapter.

#### **Measurements of temperature**

##### *Buffer, backfill and rock*

Thermocouples from Pentronic have been used to measure temperature. Measurements are done in 32 points in each instrumented hole (hole1 and hole 3). In addition, temperature gauges are built into the capacitive relative humidity sensors and some of the other sensor types as well.

#### **Canister**

Temperature is measured on the surface of the canister with optical fiber cables. An optical measuring system called FTR (Fiber Temperature Laser Radar) is used.

#### **Measurement of total pressure in the buffer and backfill**

Total pressure is the sum of the swelling pressure and the pore water pressure. It is measured with the following instrument types:

- Geocon total pressure cells with vibrating wire transducers.
- Kulite total pressure cells with piezo resistive transducers.

#### **Measurement of pore water pressure in the buffer and backfill**

Pore water pressure is measured with the following instrument types:

- Geocon pore pressure cells with vibrating wire transducer.
- Kulite pore pressure cells with piezo resistive transducer.

#### **Measurement of the water saturation process in the buffer and backfill**

The water saturation process is recorded by measuring the relative humidity in the pore system, which can be converted to total suction (negative water pressure). The following techniques and devices are used:

- Vaisala relative humidity sensor of capacitive type. The measuring range is 0–100 % RH.
- Rotronic relative humidity sensors of capacitive type. The measuring range is 0–100 % RH.
- Wescor soil psychrometer. The sensor is measuring the dry and the wet temperature in the pore volume of the material. The measuring range is 95.5–99.6 % RH corresponding to the pore water pressure –0.5 to –6 MPa. Psychrometers are placed in the backfill in section I.



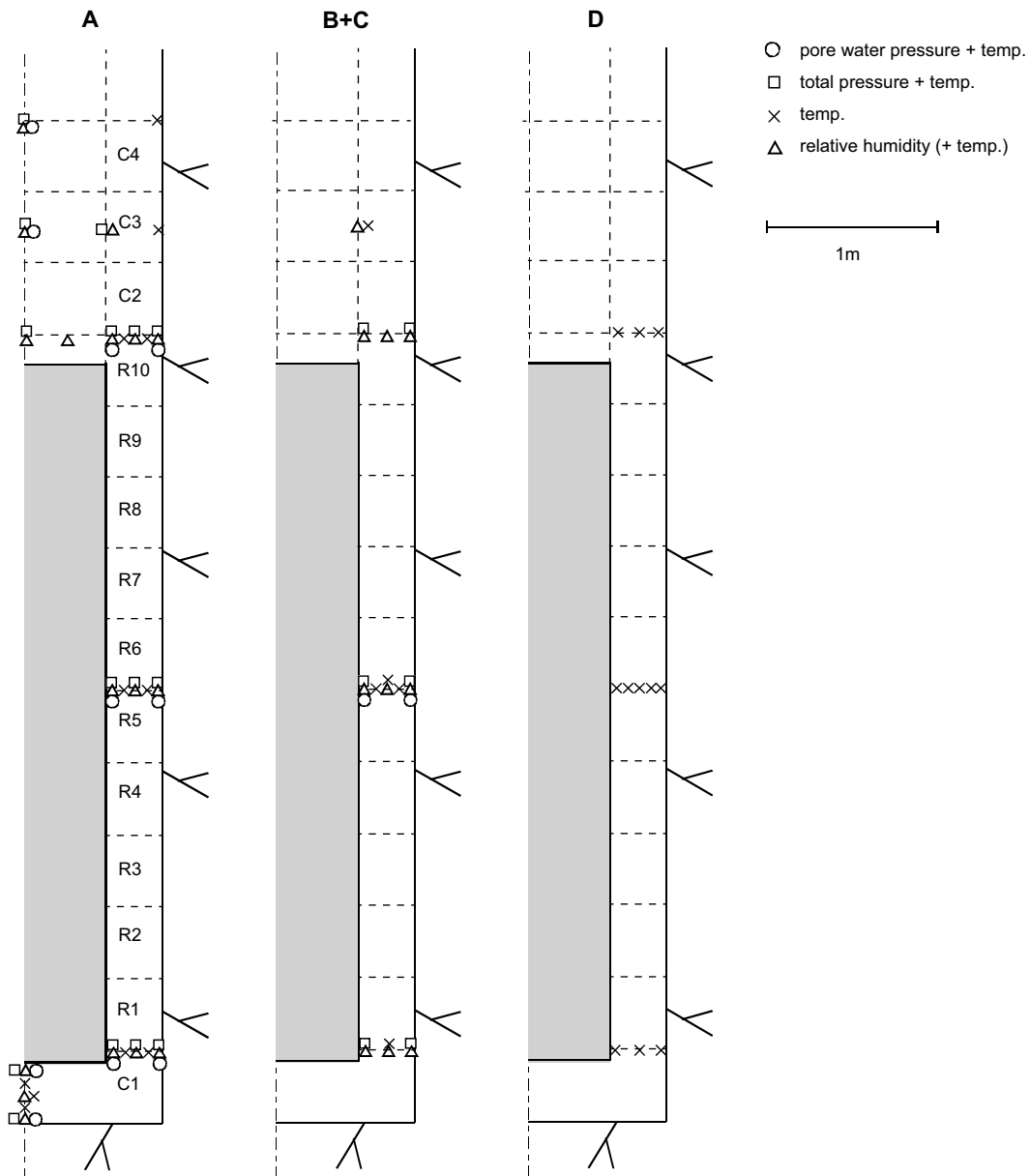
## 4 Location of instruments in section 1

### 4.1 Strategy for describing the position of each device in the bentonite and rock in and around the deposition holes

The same principles are used for describing the position of all sensors in the bentonite inside the deposition holes as well as the thermocouples in the rock around the deposition holes. The principles are described in the quick guide inserted as a folded A3 page at the end of the report.

The type of instruments and their locations are described in detail in Börgesson and Sandén (2001).

Every instrument is named with a unique name consisting of one letter describing the type of measurement, two letters describing where the measurement takes place (buffer, backfill, rock or canister), one figure denoting the deposition hole (1–4) and four figures specifying the instrument according to a separate list (see Table 4-1 to 4-10). Every instrument position is then described with three coordinates according to Figure 4-1.



**Figure 4-1.** Schematic view over the instruments in four vertical sections and the block designation.

The  $r$ -coordinate is the horizontal distance from the centre of the hole and the  $z$ -coordinate is the height from the surface of the bottom casting of the hole (the block height is set to 500 mm). The  $\alpha$ -coordinate is the angle from the vertical direction A (almost West).

Figure 4-1 shows an overview of the instruments in the buffer. The bentonite blocks are called cylinders and rings. The cylinders are numbered C1–C4 and the rings R1–R10 respectively.

## 4.2 Position of each instrument in the bentonite in hole 1 (DA3587G01)

The instruments are located in three main levels in the blocks, 50 mm, 160 mm and 250 mm, from the upper surface. The thermocouples are mostly placed in the 50 mm level and the other gauges in the 160 mm level except for the Geokon type 1 pressure sensors and the Rotronic humidity sensors, which are placed in the 250 mm level depending on the size of the sensor house.

Exact positions of the sensors are described in Tables 4-1 to 4-4.

**Table 4-1. Numbering and position of instruments for measuring temperature (T) in the buffer in hole 1.**

Type and number	Block	Instrument position				Fabricate	Remark
		Direction	$\alpha$ degree	r m	Z m		
TBU10001	Cyl. 1	Center	270	0,050	0,054	Pentronic	
TBU10002	Cyl. 1	Center	270	0,050	0,254	Pentronic	
TBU10003	Cyl. 1	Center	270	0,050	0,454	Pentronic	
TBU10004	Cyl. 1	A	355	0,635	0,454	Pentronic	
TBU10005	Cyl. 1	A	355	0,735	0,454	Pentronic	
TBU10006	On the top of the canister in hole 2					Pentronic	
TBU10007	Cyl. 1	C	175	0,685	0,454	Pentronic	
TBU10008	Cyl. 1	D	270	0,585	0,454	Pentronic	
TBU10009	Cyl. 1	D	270	0,685	0,454	Pentronic	
TBU10010	Cyl. 1	D	270	0,785	0,454	Pentronic	
TBU10011	Ring 5	A	0	0,635	2,980	Pentronic	
TBU10012	Ring 5	A	0	0,735	2,980	Pentronic	
TBU10013	Ring 5	B	90	0,585	2,980	Pentronic	
TBU10014	Ring 5	B	90	0,685	2,980	Pentronic	
TBU10015	Ring 5	B	90	0,785	2,980	Pentronic	
TBU10016	Ring 5	C	175	0,585	2,980	Pentronic	
TBU10017	Ring 5	C	175	0,685	2,980	Pentronic	
TBU10018	Ring 5	C	175	0,735	2,980	Pentronic	
TBU10019	Ring 5	D	270	0,585	2,980	Pentronic	
TBU10020	Ring 5	D	270	0,635	2,980	Pentronic	
TBU10021	Ring 5	D	270	0,685	2,980	Pentronic	
TBU10022	Ring 5	D	270	0,735	2,980	Pentronic	
TBU10023	Ring 5	D	270	0,785	2,980	Pentronic	
TBU10024	Ring 10	A	0	0,635	5,508	Pentronic	
TBU10025	Ring 10	A	0	0,735	5,508	Pentronic	
TBU10026	Ring 10	D	270	0,585	5,508	Pentronic	
TBU10027	Ring 10	D	270	0,685	5,508	Pentronic	
TBU10028	Ring 10	D	270	0,785	5,508	Pentronic	
TBU10029	Cyl. 3	A	0	0,785	6,317	Pentronic	
TBU10030	Cyl. 3	B	95	0,585	6,317	Pentronic	
TBU10031	Cyl. 3	C	185	0,585	6,317	Pentronic	
TBU10032	Cyl. 4	A	0	0,785	7,026	Pentronic	

**Table 4-2. Numbering and position of instruments for measuring total pressure (P) in the buffer in hole 1.**

Type and number	Block	Instrument position				Fabricate	Remark
		Direction	$\alpha$ degree	r m	Z m		
PBU10001	Cyl. 1	Center	0	0,000	0,000	Geokon	In cement
PBU10002	Cyl. 1	Center	0	0,100	0,504	Geokon	
PBU10003	Cyl. 1	A	5	0,585	0,504	Kulite	Vertical
PBU10004	Cyl. 1	A	5	0,685	0,504	Kulite	Vertical
PBU10005	Cyl. 1	A	5	0,785	0,504	Kulite	Vertical
PBU10006	Cyl. 1	B	95	0,635	0,504	Geokon	
PBU10007	Cyl. 1	B	105	0,735	0,504	Geokon	
PBU10008	Cyl. 1	C	185	0,635	0,504	Geokon	
PBU10009	Cyl. 1	C	195	0,735	0,504	Geokon	
PBU10011	Ring 5	A	5	0,685	2,780	Geokon I	
PBU10012	Ring 5	A	5	0,785	3,030	Kulite	In the slot
PBU10013	Ring 5	B	95	0,585	2,780	Geokon I	
PBU10014	Ring 5	B	95	0,785	2,780	Geokon I	
PBU10015	Ring 5	C	185	0,535	3,030	Geokon I	In the slot
PBU10016	Ring 5	C	185	0,825	2,870	Kulite	In the slot
PBU10017	Ring 10	Center	0	0,050	5,558	Geokon	
PBU10019	Ring 10	A	5	0,685	5,558	Kulite	Vertical
PBU10020	Ring 10	A	5	0,785	5,558	Kulite	Vertical
PBU10021	Ring 10	B	90	0,635	5,558	Geokon	
PBU10022	Ring 10	B	100	0,735	5,558	Geokon	
PBU10023	Ring 10	C	190	0,735	5,558	Geokon	
PBU10024	Ring 10	C	180	0,635	5,558	Geokon	
PBU10025	Cyl. 3	Center	0	0,050	6,317	Kulite	Vertical
PBU10026	Cyl. 3	A	5	0,585	6,567	Geokon	
PBU10027	Cyl. 4	Center	0	0,050	7,076	Kulite	Vertical

**Table 4-3. Numbering and position of instruments for measuring pore water pressure (U) in the buffer in hole 1.**

Type and number	Block	Instrument position				Fabricate	Remark
		Direction	$\alpha$ degree	r m	Z m		
UBU10001	Cyl. 1	Center	90	0,050	0,054	Kulite	
UBU10002	Cyl. 1	Center	90	0,050	0,254	Geokon	Horizontal
UBU10003	Cyl. 1	A	355	0,585	0,344	Geokon	
UBU10004	Cyl. 1	A	355	0,785	0,344	Kulite	
UBU10005	Ring 5	A	355	0,585	2,780	Geokon	
UBU10006	Ring 5	A	355	0,785	2,870	Kulite	
UBU10007	Ring 5	B	85	0,535	2,870	Kulite	In the slot
UBU10008	Ring 5	B	85	0,825	2,870	Kulite	In the slot
UBU10009	Ring 5	C	175	0,535	2,780	Geokon	In the slot
UBU10010	Ring 5	C	175	0,825	2,780	Geokon	In the slot
UBU10011	Ring 10	A	355	0,585	5,398	Kulite	
UBU10012	Ring 10	A	355	0,785	5,308	Geokon	
UBU10013	Cyl. 3	Center	90	0,050	6,317	Geokon	
UBU10014	Cyl. 4	Center	90	0,050	6,916	Geokon	

**Table 4-4. Numbering and position of instruments for measuring water content (W) in the buffer in hole 1.**

Type and number	Block	Instrument position				Fabricate	Remark
		Direction	$\alpha$ degree	r m	Z m		
WBU10001	Cyl. 1	Center	180	0,050	0,054	Rotronic	Horizontal
WBU10002	Cyl. 1	Center	0	0,400	0,254	Rotronic	
WBU10003	Cyl. 1	Center	180	0,100	0,254	Rotronic	
WBU10004	Cyl. 1	A	350	0,785	0,344	Vaisala	
WBU10005	Cyl. 1	A	350	0,685	0,344	Vaisala	
WBU10006	Cyl. 1	A	350	0,585	0,344	Vaisala	
WBU10007	Cyl. 1	B	80	0,585	0,344	Vaisala	
WBU10008	Cyl. 1	B	80	0,685	0,254	Rotronic	
WBU10009	Cyl. 1	B	80	0,785	0,254	Rotronic	
WBU10010	Cyl. 1	C	170	0,585	0,254	Rotronic	
WBU10011	Cyl. 1	C	170	0,685	0,254	Rotronic	
WBU10012	Cyl. 1	C	170	0,785	0,254	Rotronic	
WBU10013	Ring 5	A	350	0,585	2,870	Vaisala	In the slot
WBU10014	Ring 5	A	350	0,685	2,870	Vaisala	
WBU10015	Ring 5	A	350	0,785	2,870	Vaisala	
WBU10016	Ring 5	B	80	0,535	2,780	Rotronic	
WBU10017	Ring 5	B	80	0,685	2,780	Rotronic	
WBU10018	Ring 5	B	80	0,785	2,780	Rotronic	
WBU10019	Ring 5	C	180	0,535	2,870	Vaisala	
WBU10020	Ring 5	C	180	0,685	2,870	Vaisala	
WBU10021	Ring 5	C	180	0,785	2,780	Rotronic	
WBU10022	Ring 10	Center	0	0,050	5,418	Vaisala	
WBU10023	Ring 10	A	180	0,362	5,428	Vaisala	
WBU10024	Ring 10	A	350	0,585	5,398	Vaisala	
WBU10025	Ring 10	A	350	0,685	5,398	Vaisala	
WBU10026	Ring 10	A	350	0,785	5,398	Vaisala	
WBU10027	Ring 10	B	80	0,585	5,308	Rotronic	
WBU10028	Ring 10	B	80	0,685	5,308	Rotronic	
WBU10029	Ring 10	B	80	0,785	5,308	Rotronic	
WBU10030	Ring 10	C	170	0,585	5,398	Vaisala	
WBU10031	Ring 10	C	170	0,785	5,308	Rotronic	
WBU10032	Cyl. 3	Center	270	0,050	6,317	Vaisala	
WBU10033	Cyl. 3	A	350	0,585	6,317	Vaisala	
WBU10034	Cyl. 3	B	90	0,585	6,317	Vaisala	
WBU10035	Cyl. 3	C	180	0,585	6,317	Rotronic	
WBU10036	Cyl. 4	Center	180	0,050	6,916	Vaisala	
WBU10037	Cyl. 4	Center	270	0,050	6,756	Vaisala	

### 4.3 Position of each instrument in the bentonite in hole 3 (DA3575G01)

The instruments are located according to the same system as those in hole 1.

The positions of each instrument are described in Tables 4-5 to 4-9.



**Table 4-5. Numbering and position of instruments for measuring temperature (T) in the buffer in hole 3.**

Type and number	Block	Instrument position				Fabricate	Remark
		Direction	$\alpha$ degree	r m	Z m		
TBU30001	Cyl. 1	Center	270	0,050	0,095	Pentronic	Just above canister lid
TBU30002	Cyl. 1	Center	270	0,050	0,295	Pentronic	
TBU30003	Cyl. 1	Center	270	0,050	0,445	Pentronic	
TBU30004	Cyl. 1	A	355	0,635	0,445	Pentronic	
TBU30005	Cyl. 1	A	355	0,735	0,445	Pentronic	
TBU30006	Cyl. 1	B	85	0,685	0,445	Pentronic	
TBU30007	Cyl. 1	C	175	0,685	0,445	Pentronic	
TBU30008	Cyl. 1	D	270	0,585	0,445	Pentronic	
TBU30009	Cyl. 1	D	270	0,685	0,445	Pentronic	
TBU30010	Cyl. 1	D	270	0,785	0,445	Pentronic	
TBU30011	Ring 5	A	0	0,635	2,971	Pentronic	
TBU30012	Ring 5	A	0	0,735	2,971	Pentronic	
TBU30013	Ring 5	B	90	0,585	2,971	Pentronic	
TBU30014	Ring 5	B	90	0,685	2,971	Pentronic	
TBU30015	Ring 5	B	90	0,785	2,971	Pentronic	
TBU30016	Ring 10	A	329	0,410	5,394	Pentronic	
TBU30017	Ring 5	C	175	0,685	2,971	Pentronic	
TBU30018	Ring 5	C	175	0,735	2,971	Pentronic	
TBU30019	Ring 5	D	270	0,585	2,971	Pentronic	
TBU30020	Ring 5	D	270	0,635	2,971	Pentronic	
TBU30021	Ring 5	D	270	0,685	2,971	Pentronic	
TBU30022	Ring 5	D	270	0,735	2,971	Pentronic	
TBU30023	Ring 5	D	270	0,785	2,971	Pentronic	
TBU30024	Ring 10	A	0	0,635	5,504	Pentronic	
TBU30025	Ring 10	A	0	0,735	5,504	Pentronic	
TBU30026	Ring 10	D	270	0,585	5,504	Pentronic	
TBU30027	Ring 10	D	270	0,685	5,504	Pentronic	
TBU30028	Ring 10	D	270	0,785	5,504	Pentronic	
TBU30029	Cyl. 3	A	0	0,785	6,314	Pentronic	
TBU30030	Cyl. 3	B	95	0,585	6,314	Pentronic	
TBU30031	Cyl. 3	C	185	0,585	6,314	Pentronic	
TBU30032	Cyl. 4	A	0	0,785	7,015	Pentronic	

**Table 4-6. Numbering and position of instruments for measuring total pressure (P) in the buffer in hole 3.**

Type and number	Block	Instrument position in block				Fabricate	Remark
		Direction	$\alpha$ degree	r mm	Z mm		
PBU30001	Cyl. 1	Center	0	0	0	Geokon	In cement
PBU30002	Cyl. 1	Center	0	100	495	Geokon	
PBU30003	Cyl. 1	A	5	585	495	Kulite	Vertical
PBU30004	Cyl. 1	A	5	685	495	Kulite	Vertical
PBU30005	Cyl. 1	A	5	785	495	Kulite	Vertical
PBU30006	Cyl. 1	B	95	635	495	Geokon	
PBU30007	Cyl. 1	B	105	735	495	Geokon	
PBU30008	Cyl. 1	C	185	635	495	Geokon	
PBU30009	Cyl. 1	C	195	735	495	Geokon	
PBU30010	Ring 5	A	5	535	3021	Kulite	In the slot
PBU30011	Ring 5	A	5	685	2771	Geokon I	
PBU30012	Ring 5	A	5	825	3021	Kulite	In the slot
PBU30013	Ring 5	B	95	585	2771	Geokon I	
PBU30014	Ring 5	B	95	785	2771	Geokon I	
PBU30015	Ring 5	C	185	535	3021	Geokon I	In the slot
PBU30016	Ring 5	C	185	825	2971	Kulite	In the slot
PBU30017	Ring 10	Center	0	50	5556	Geokon	
PBU30018	Ring 10	A	5	585	5556	Kulite	Vertical
PBU30019	Ring 10	A	5	685	5556	Kulite	Vertical
PBU30020	Ring 10	A	5	785	5556	Kulite	Vertical
PBU30021	Ring 10	B	90	635	5556	Geokon	
PBU30022	Ring 10	B	100	735	5556	Geokon	
PBU30023	Ring 10	C	180	735	5556	Geokon	
PBU30024	Ring 10	C	190	635	5556	Geokon	
PBU30025	Cyl. 3	Center	0	50	6314	Kulite	Vertical
PBU30026	Cyl. 3	A	5	585	6564	Geokon	
PBU30027	Cyl. 4	Center	0	50	7065	Kulite	Vertical

**Table 4-7. Numbering and position of instruments for measuring pore water pressure (U) in the buffer in hole 3.**

Type and number	Block	Instrument position in block				Fabricate	Remark
		Direction	$\alpha$ degree	r mm	Z mm		
UBU30001	Cyl. 1	Center	90	50	45	Kulite	
UBU30002	Cyl. 1	Center	90	100	245	Geokon	Horizontal
UBU30003	Cyl. 1	A	355	585	335	Geokon	
UBU30004	Cyl. 1	A	355	785	335	Kulite	
UBU30005	Ring 5	A	355	585	2771	Geokon	
UBU30006	Ring 5	A	355	785	2861	Kulite	
UBU30007	Ring 5	B	85	535	2861	Kulite	In the slot
UBU30008	Ring 5	B	85	825	2861	Kulite	In the slot
UBU30009	Ring 5	C	175	535	2771	Geokon	In the slot
UBU30010	Ring 5	C	175	825	2771	Geokon	In the slot
UBU30011	Ring 10	A	355	585	5396	Kulite	
UBU30012	Ring 10	A	355	785	5306	Geokon	
UBU30013	Cyl. 3	Center	90	50	6314	Geokon	
UBU30014	Cyl. 4	Center	90	50	6910	Geokon	

**Table 4-8. Numbering and position of instruments for measuring water content (W) in the buffer in hole 3.**

Type and number	Block	Instrument position				Fabricate	Remark
		Direction	$\alpha$ degree	r m	Z m		
WBU30001	Cyl. 1	Center	180	0,050	0,045	Rotronic	Horizontal
WBU30002	Cyl. 1	Center	0	0,400	0,215	Rotronic	
WBU30003	Cyl. 1	Center	180	0,100	0,245	Rotronic	
WBU30004	Cyl. 1	A	350	0,785	0,335	Vaisala	
WBU30005	Cyl. 1	A	350	0,685	0,335	Vaisala	
WBU30006	Cyl. 1	A	350	0,585	0,335	Vaisala	
WBU30007	Cyl. 1	B	80	0,585	0,335	Vaisala	
WBU30008	Cyl. 1	B	80	0,685	0,245	Rotronic	
WBU30009	Cyl. 1	B	80	0,785	0,245	Rotronic	
WBU30010	Cyl. 1	C	170	0,585	0,245	Rotronic	
WBU30011	Cyl. 1	C	170	0,685	0,245	Rotronic	
WBU30012	Cyl. 1	C	170	0,785	0,245	Rotronic	
WBU30013	Ring 5	A	350	0,585	2,861	Vaisala	In the slot
WBU30014	Ring 5	A	350	0,685	2,861	Vaisala	
WBU30015	Ring 5	A	350	0,785	2,861	Vaisala	
WBU30016	Ring 5	B	80	0,535	2,771	Rotronic	
WBU30017	Ring 5	B	80	0,685	2,771	Rotronic	
WBU30018	Ring 5	B	80	0,785	2,771	Rotronic	
WBU30019	Ring 5	C	180	0,535	2,861	Vaisala	In the slot
WBU30020	Ring 5	C	180	0,685	2,861	Vaisala	
WBU30021	Ring 5	C	180	0,785	2,771	Rotronic	
WBU30022	Ring 10	Center	180	0,050	5,416	Vaisala	
WBU30023	Ring 10	A	352	0,262	5,396	Vaisala	
WBU30024	Ring 10	A	350	0,585	5,396	Vaisala	
WBU30025	Ring 10	A	350	0,785	5,396	Vaisala	
WBU30026	Ring 10	A	350	0,685	5,396	Vaisala	
WBU30027	Ring 10	B	80	0,585	5,306	Rotronic	
WBU30028	Ring 10	B	80	0,685	5,306	Rotronic	
WBU30029	Ring 10	B	80	0,785	5,306	Rotronic	
WBU30030	Ring 10	C	170	0,585	5,396	Vaisala	
WBU30031	Ring 10	C	170	0,785	5,306	Rotronic	
WBU30032	Cyl. 3	Center	180	0,050	6,314	Vaisala	
WBU30033	Cyl. 3	A	350	0,585	6,314	Vaisala	
WBU30034	Cyl. 3	B	90	0,585	6,314	Vaisala	
WBU30035	Cyl. 3	C	180	0,585	6,314	Rotronic	
WBU30036	Cyl. 4	Center	180	0,050	6,910	Vaisala	
WBU30037	Cyl. 4	Center	270	0,050	6,750	Vaisala	

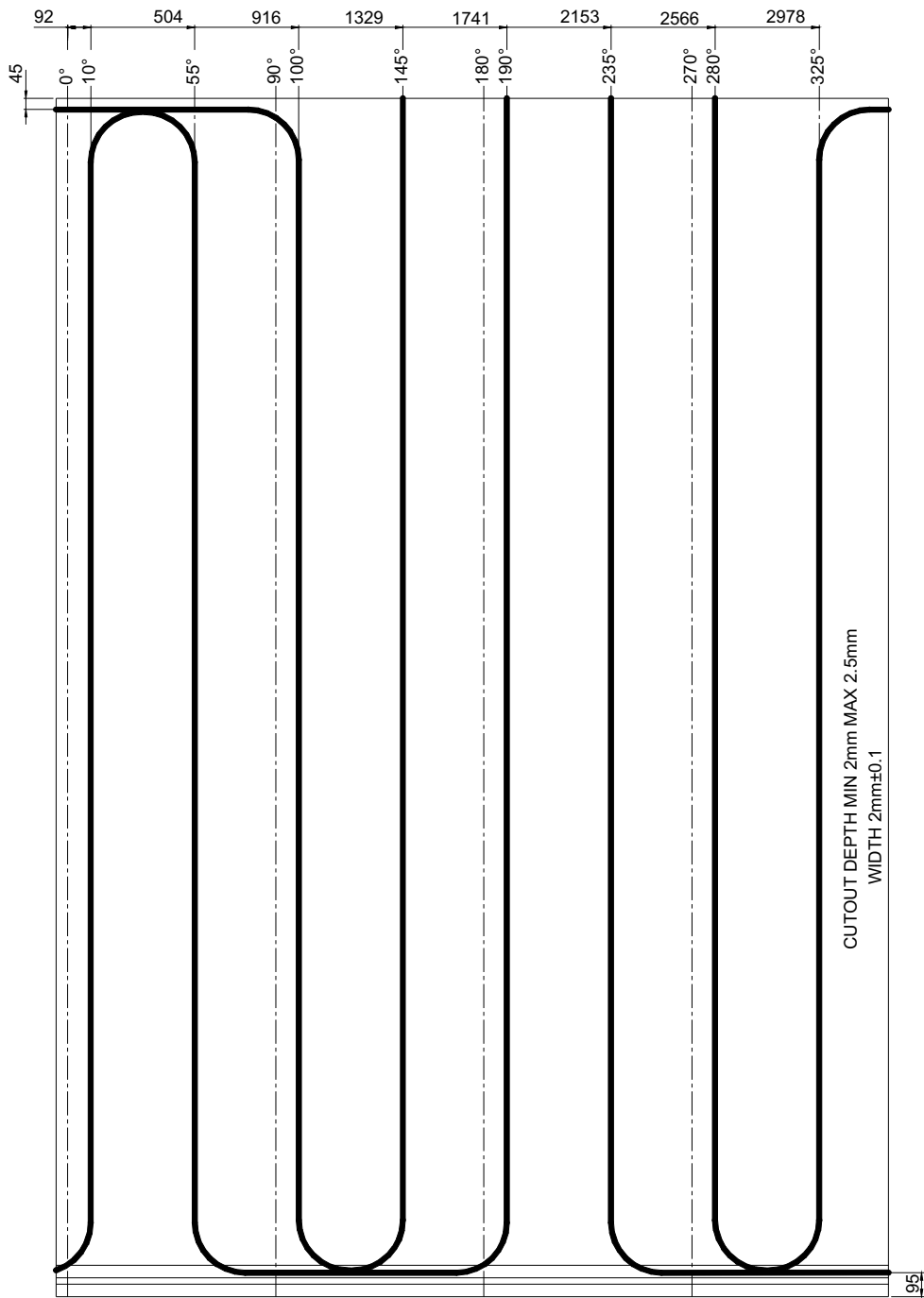
#### 4.4 Instruments on the canister surface in holes 1–4

The canisters are instrumented with optical fiber cables on the copper surface.

Figure 4-2 shows how two optical fiber cables are placed on the canister surface. Both ends of a cable are used for measurements. This means that the two cables are used for four measurements.

With this laying the cables will enter and exit the surface at almost the same position. Curvatures are shaped as a quarter circle with a radius of 20 cm. The cables are placed in a milled out channels on the surface. The channels have a width and a depth of just above 2 mm

In addition to the optical cables one thermocouple (TBU 10006) is fixed to the lid of the canister in deposition hole 2 (see Table 4-1).

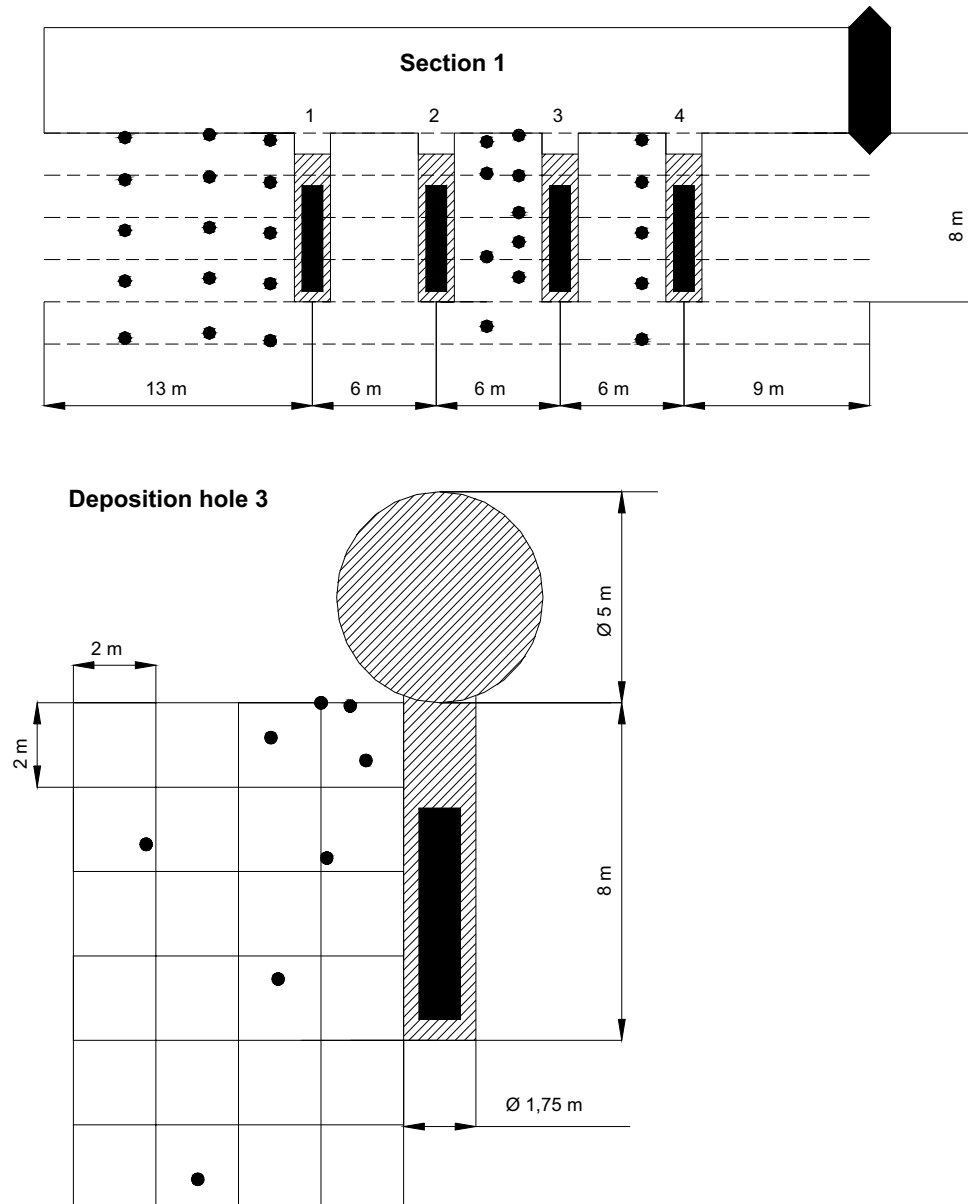


**SHELL EXPANSION OF COPPER CANISTER  
ALL DIMENSIONS EXPANDED**

*Figure 4-2. Laying of the optical fiber cables with protection tube of Inconel 625 (outer diameter 2 mm) for measurement of the canister surface temperature (surface unfolded).*

## 4.5 Position of temperature sensors in the rock

The positions of the temperature sensors in the rock are termed in the same way as the sensors in the buffer in the deposition holes. Figure 4-3 shows an overview of the temperature sensors placed in the rock. The sensors are assigned to the closest deposition hole. The positions are described in Table 4-9.



**Figure 4-3.** Overview of the temperature sensors in the rock. Length section (upper) and cross section (towards the end of the tunnel).

**Table 4-9. Numbering and position of temperature sensors in the rock.**

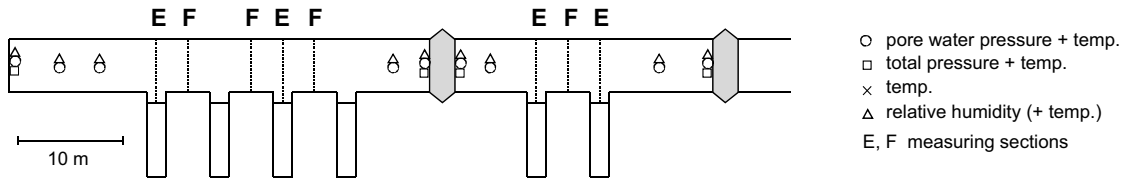
Type and number	Instrument position in rock			Fabricate
	$\alpha$ degree	r m	Z m	
<b>Measured from DA3587G01 (Hole 1)</b>				
TROA0350	360	9,080	7,785	Pentronic
TROA0340	360	9,080	5,785	Pentronic
TROA0330	360	9,080	3,385	Pentronic
TROA0320	0	9,080	0,986	Pentronic
TROA0310	0	9,081	-1,714	Pentronic
TROA0650	360	4,990	7,922	Pentronic
TROA0640	360	4,982	5,922	Pentronic
TROA0630	360	4,972	3,522	Pentronic
TROA0620	360	4,961	1,122	Pentronic
TROA0610	360	4,951	-1,478	Pentronic
TROA1050	359	2,014	7,663	Pentronic
TROA1040	359	2,022	5,663	Pentronic
TROA1030	359	2,032	3,263	Pentronic
TROA1020	359	2,042	0,863	Pentronic
TROA1010	359	2,053	-1,837	Pentronic
<b>Measured from DA3581G01 (Hole 2)</b>				
TROA1840	179	2,403	7,584	Pentronic
TROA1830	179	2,427	6,084	Pentronic
TROA1820	179	2,489	2,135	Pentronic
TROA1810	179	2,541	-1,165	Pentronic
<b>Measured from DA3575G01 (Hole 3)</b>				
TROA2150	134	3,287	7,956	Pentronic
TROA2140	1	1,993	5,977	Pentronic
TROA2130	1	1,975	4,228	Pentronic
TROA2120	2	1,961	2,838	Pentronic
TROA2110	3	1,944	1,168	Pentronic
TROA1850	360	2,013	7,887	Pentronic
TROA2330	90	2,192	7,922	Pentronic
TROA2320	90	1,786	6,630	Pentronic
TROA2310	109	7,111	4,638	Pentronic
TROA2440	124	4,090	7,172	Pentronic
TROA2430	90	2,735	4,317	Pentronic
TROA2420	89	3,912	1,449	Pentronic
TROA2410	89	5,86	-3,297	Pentronic
<b>Measured from DA3569G01 (Hole 4)</b>				
TROA3050	359	2,013	7,665	Pentronic
TROA3040	359	2,020	5,665	Pentronic
TROA3030	358	2,030	3,265	Pentronic
TROA3020	357	2,040	0,865	Pentronic
TROA3010	357	2,051	-1,784	Pentronic

## 4.6 Strategy for describing the position of each device in the backfill in section 1

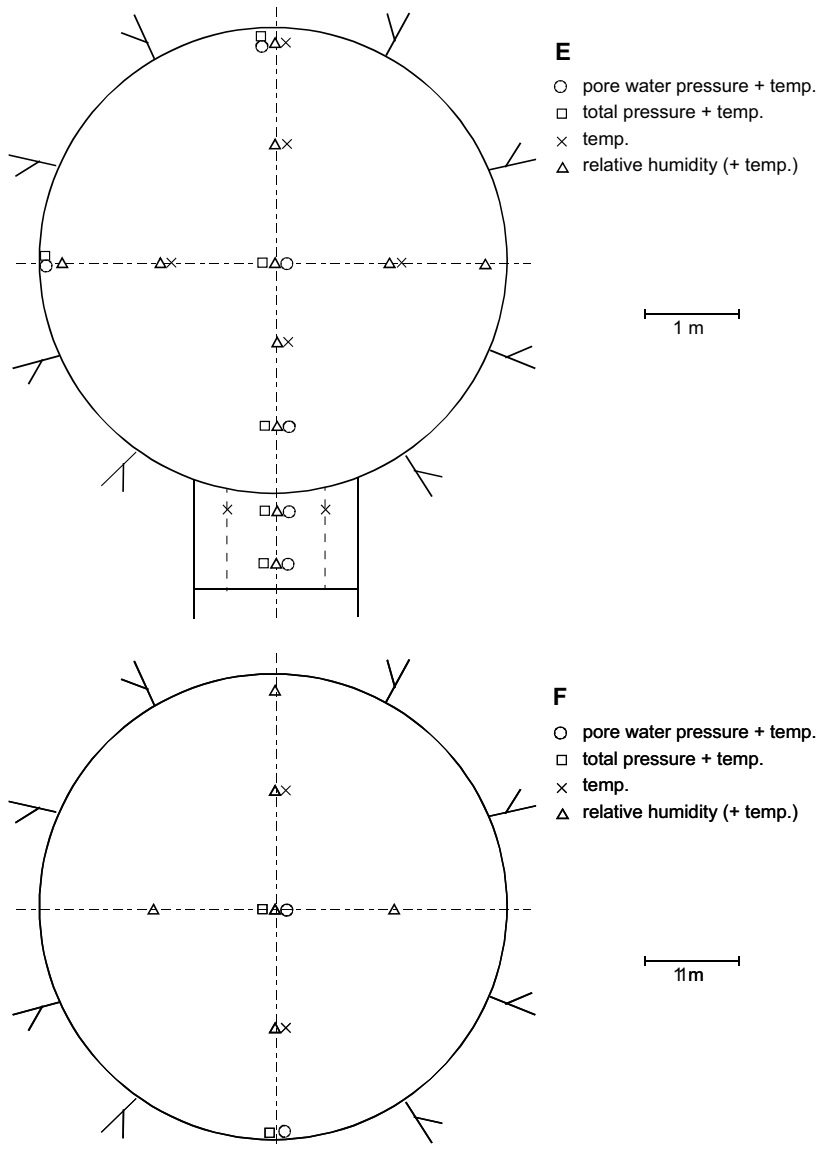
The principles of terming the instruments are described in the quick guide inserted as a folded A3 page at the end of the report.

Every instrument is named with a unique name consisting of one letter describing the type of measurement, two letters describing where the measurement takes place (buffer, backfill, rock or canister) and five figures specifying the instrument according to separate lists (see Tables 4-10 to 4-13). Every instrument position is then described with three coordinates according to Figure 2-2. The  $x$ -coordinate is the horizontal distance from the centre of the tunnel and the  $z$ -coordinate is the vertical distance from the centre of the tunnel. The  $y$ -coordinate is the same as in the tunnel coordinate system, i.e.  $y=3\,599$  corresponds to the end of the tunnel.

The backfill is mainly instrumented in vertical sections straight above and between the deposition holes (Figures 4-4 and 4-5).



**Figure 4-4.** Schematic view over the instrumentation of the backfill.



**Figure 4-5.** Schematic view over the sensors positions in the different sections.

## 4.7 Position of each instrument in the backfill

The positions of each instrument are described in Tables 4-10 to 4-13.

**Table 4-10. Numbering and position of instruments for measuring temperature (T) in the backfill.**

Type and number	Instrument position				Fabricate	Remark
	Section	x m	z m	y m		
TBA10001	E, over dep.hole 1	-1,3	-0,1	3 587	Pentronic	
TBA10002	E, over dep.hole 1	0,1	1,3	3 587	Pentronic	
TBA10003	E, over dep.hole 1	0,0	-0,8	3 587	Pentronic	
TBA10004	E, over dep.hole 1	-0,5	-2,6	3 587	Pentronic	
TBA10005	E, over dep.hole 1	0,5	-2,6	3 587	Pentronic	
TBA10006	E, over dep.hole 1	-0,1	2,3	3 587	Pentronic	
TBA10007	E, over dep.hole 1	1,3	-0,1	3 587	Pentronic	
TBA10008	F, between dep.hole 1 and 2	0,0	1,3	3 584	Pentronic	
TBA10009	F, between dep.hole 1 and 2	-0,1	-1,3	3 584	Pentronic	
TBA10010	F, between dep.hole 2 and 3	0,0	1,2	3 578	Pentronic	
TBA10011	F, between dep.hole 2 and 3	0,0	-1,2	3 578	Pentronic	
TBA10012	E, over dep.hole 3	-0,1	2,3	3 575	Pentronic	
TBA10013	E, over dep.hole 3	0,0	1,3	3 575	Pentronic	
TBA10014	E, over dep.hole 3	0,0	-0,9	3 575	Pentronic	
TBA10015	E, over dep.hole 3	-0,5	-2,6	3 575	Pentronic	
TBA10016	E, over dep.hole 3	0,5	-2,6	3 575	Pentronic	
TBA10017	E, over dep.hole 3	-1,3	0,0	3 575	Pentronic	
TBA10018	E, over dep.hole 3	1,3	0,0	3 575	Pentronic	
TBA10019	F, between dep.hole 3 and 4	0,0	1,2	3 572	Pentronic	
TBA10020	F, between dep.hole 3 and 4	0,0	-1,3	3 572	Pentronic	

**Table 4-11. Numbering and position of instruments for measuring total pressure (P) in the backfill.**

Type and number	Instrument position				Fabricate	Remark
	Section	x m	z m	y m		
PBA10001	Inner part	0,2	0,1	3589	Kulite	
PBA10002	E, over dep.hole 1	0,0	0,0	3587	Geokon	
PBA10003	E, over dep.hole 1	0,0	-1,8	3587	Geokon	
PBA10004	E, over dep.hole 1	0,0	-2,6	3587	Geokon	
PBA10005	E, over dep.hole 1	0,0	-3,1	3587	Kulite	
PBA10006	E, over dep.hole 1	-2,3	0,1	3587	Kulite	
PBA10007	E, over dep.hole 1	0,2	2,3	3587	Kulite	
PBA10008	F, between dep.hole 1 and 2	0,0	0,0	3584	Geokon	
PBA10009	F, between dep.hole 1 and 2	-0,1	-1,8	3584	Geokon	
PBA10010	F, between dep.hole 2 and 3	0,0	-0,2	3578	Kulite	
PBA10011	F, between dep.hole 2 and 3	0,0	-2,3	3578	Kulite	
PBA10013	E, over dep.hole 3	0,0	-1,8	3575	Kulite	
PBA10015	E, over dep.hole 3	0,0	-3,1	3575	Geokon	
PBA10016	E, over dep.hole 3	-2,3	0,0	3575	Geokon	
PBA10017	E, over dep.hole 3	0,0	0,0	3575	Geokon	
PBA10018	F, between dep.hole 3 and 4	0,0	0,0	3572	Geokon	
PBA10019	F, between dep.hole 3 and 4	0,0	-2,3	3572	Geokon	
PBA10020	In front of plug	0,0	0,0	3561	Kulite	



**Table 4-12. Numbering and position of instruments for measuring pore water pressure (U) in the backfill.**

Type and number	Instrument position			Fabricate	Remark
	Section	x m	z m		
UBA10001	Inner part	-0,2	-0,1	3589	Kulite
UBA10002	Inner part	0,0	0,0	3592	Geokon
UBA10003	Inner part	-0,2	-0,1	3590	Geokon
UBA10004	E, over dep.hole 1	0,0	-0,1	3587	Geokon
UBA10005	E, over dep.hole 1	-0,2	-1,8	3587	Kulite
UBA10006	E, over dep.hole 1	0,1	-2,6	3587	Kulite
UBA10007	E, over dep.hole 1	0,4	-3,2	3587	Kulite
UBA10008	E, over dep.hole 1	-2,3	0,0	3587	Geokon
UBA10009	E, over dep.hole 1	0,0	2,3	3587	Geokon
UBA10010	F, between dep.hole 1 and 2	0,0	0,0	3584	Kulite
UBA10011	F, between dep.hole 1 and 2	0,1	-1,8	3584	Kulite
UBA10012	F, between dep.hole 2 and 3	0,0	-0,2	3578	Kulite
UBA10013	F, between dep.hole 2 and 3	0,0	-2,3	3578	Kulite
UBA10014	E, over dep.hole 3	0,0	0,0	3575	Kulite
UBA10015	E, over dep.hole 3	0,0	-1,8	3575	Geokon
UBA10016	E, over dep.hole 3	0,3	-2,6	3575	Geokon
UBA10017	E, over dep.hole 3	-0,1	-3,1	3575	Geokon
UBA10018	E, over dep.hole 3	-2,3	0,0	3575	Geokon
UBA10019	E, over dep.hole 3	0,0	0,0	3575	Geokon
UBA10020	F, between dep.hole 3 and 4	0,0	0,0	3572	Kulite
UBA10021	F, between dep.hole 3 and 4	0,0	-2,3	3572	Kulite
UBA10022	In front of plug	0,0	0,0	3565	Kulite
UBA10023	In front of plug	0,1	0,0	3562	Kulite

**Table 4-13. Numbering and position of instruments for measuring relative humidity (W) in the backfill.**

Type and number	Instrument position			Fabricate	Remark
	Section	x m	z m		
WBA10001	Inner part	0,0	0,0	3589	Wescor
WBA10002	Inner part	0,0	0,0	3592	Wescor
WBA10003	Inner part	0,1	-0,1	3590	Wescor
WBA10004	E, over dep.hole 1	0,3	2,3	3587	Wescor
WBA10005	E, over dep.hole 1	0,0	1,3	3587	Wescor
WBA10006	E, over dep.hole 1	0,0	0,1	3587	Wescor
WBA10007	E, over dep.hole 1	0,1	-0,8	3587	Wescor
WBA10008	E, over dep.hole 1	0,0	-1,7	3587	Wescor
WBA10009	E, over dep.hole 1	-0,1	-2,6	3587	Wescor
WBA10010	E, over dep.hole 1	-0,5	-3,1	3587	Wescor
WBA10011	E, over dep.hole 1	-2,3	-0,1	3587	Wescor
WBA10012	E, over dep.hole 1	-1,3	0,0	3587	Wescor
WBA10013	E, over dep.hole 1	1,3	0,0	3587	Wescor
WBA10014	E, over dep.hole 1	2,3	0,0	3587	Wescor
WBA10015	F, between dep.hole 1 and 2	0,0	1,3	3584	Wescor
WBA10016	F, between dep.hole 1 and 2	0,0	2,3	3584	Wescor
WBA10017	F, between dep.hole 1 and 2	0,0	0,0	3584	Wescor
WBA10018	F, between dep.hole 1 and 2	0,0	-1,3	3584	Wescor
WBA10019	F, between dep.hole 1 and 2	-1,3	0,0	3584	Wescor
WBA10020	F, between dep.hole 1 and 2	1,3	0,0	3584	Wescor
WBA10021	F, between dep.hole 2 and 3	0,0	2,3	3578	Wescor
WBA10022	F, between dep.hole 2 and 3	0,0	1,2	3578	Wescor
WBA10023	F, between dep.hole 2 and 3	0,0	-0,2	3578	Wescor
WBA10024	F, between dep.hole 2 and 3	0,0	-1,2	3578	Wescor
WBA10025	F, between dep.hole 2 and 3	-1,3	0,0	3578	Wescor
WBA10026	F, between dep.hole 2 and 3	1,3	0,0	3578	Wescor
WBA10027	E, over dep.hole 3	0,0	2,5	3575	Wescor
WBA10028	E, over dep.hole 3	0,0	1,3	3575	Wescor
WBA10029	E, over dep.hole 3	0,0	0,0	3575	Wescor
WBA10030	E, over dep.hole 3	0,0	-0,9	3575	Wescor
WBA10031	E, over dep.hole 3	0,0	-1,6	3575	Wescor
WBA10032	E, over dep.hole 3	-0,3	-2,6	3575	Wescor
WBA10033	E, over dep.hole 3	0,1	-3,1	3575	Wescor
WBA10034	E, over dep.hole 3	-2,3	0,0	3575	Wescor
WBA10035	E, over dep.hole 3	-1,3	0,0	3575	Wescor
WBA10036	E, over dep.hole 3	1,3	0,0	3575	Wescor
WBA10037	E, over dep.hole 3	2,3	0,0	3575	Wescor
WBA10038	F, between dep.hole 3 and 4	0,0	2,3	3572	Wescor
WBA10039	F, between dep.hole 3 and 4	0,0	1,2	3572	Wescor
WBA10040	F, between dep.hole 3 and 4	0,0	0,0	3572	Wescor
WBA10041	F, between dep.hole 3 and 4	0,0	-1,3	3572	Wescor
WBA10042	F, between dep.hole 3 and 4	-1,3	0,0	3572	Wescor
WBA10043	F, between dep.hole 3 and 4	1,3	0,0	3572	Wescor
WBA10044	In front of plug	0,0	0,0	3565	Wescor
WBA10045	In front of plug	-0,1	0,0	3562	Wescor

## 5 Results and comments for section 1

### 5.1 General

In this chapter short comments on general trends in the measurements are given. Sensors that are not delivering reliable data or no data at all are noted and comments on the data collection in general are given.

The heating of the canister in hole1 started with an applied constant power of 1 800 W at 010917. This date is also marked as start date for the test. The backfilling started 010903 and was finished 011120 and the plug was cast at 011214. In order to simulate the radioactive decay, the power was decreased 20 W one year after start of the first heater. At the beginning of September 2004 the power was decreased with about 30 W to 1 710 W in deposition holes 1–4. Table 5-1 shows some important dates for section 1. At the beginning of November 2004 the drainage of the inner part of section 1 and the drainage trough the outer plug were closed. At the beginning of December 2004 damages on the cables for the installed heaters in one of the canisters in section 1 (No 1) and one in section 2 (No 6) were observed. The damages were probably caused by the high water pressure in the buffer and backfill. It was then decided to switch off the power to all canisters. This was done on December 2. The drainage of the tunnel was opened on December 6 and investigations of the damaged cables were initialized. The power to all the canisters, except for canister 2, was on December 15 switched on. The damages on heaters in canister 2 were so severe that it was impossible to apply any power on this canister. The drainage of the tunnel was kept open.

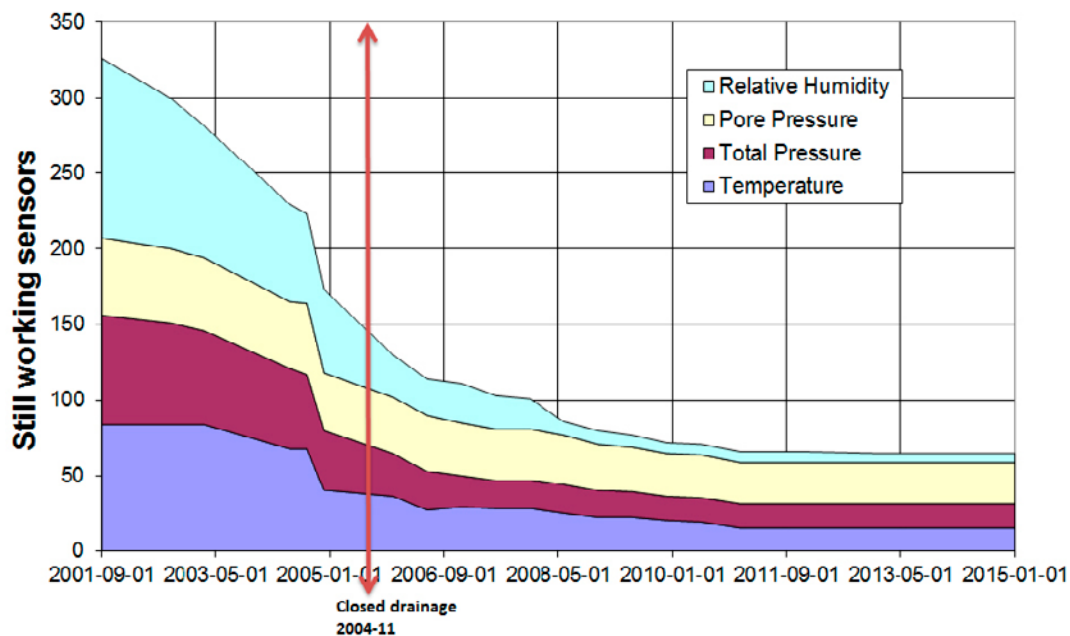
In December 2005, 2006, 2007 and in January 2009 and 2010 the power to the canisters was reduced with about 30 W. The applied power after the latest reduction is about 1 560 W. There were problems with the some electrical heaters in the canister in hole 1 (2014-02-27/day 4 546) and in the canister in hole 3(2014-04-23/ day 4 603) during this measuring period. At the end of this measuring period the power applied on the canister in hole 1 was 1 160 W and in hole 3 about 340 W. Beside the above reported power reductions a change in power was made June 23, 2003 due to additional calculations of the power from measurement of the energy. The power of the canisters was adjusted to 1 800 W. The most significant change was made for canister 2 (See section 5.4.1 and Appendix 3 page 138).

After the retrieval of the outer section, validation tests of the total pressure sensors of type Geocon were made. It was then discovered that, the up to 2012-01-01 used calibration values (linear equation) gave inaccurate readings of the total pressure. The improvements of the readings were large when a polynomial calibration equation was used instead. At the presentation of the data in this report the polynomial equation was used.

At present about 275 (excluding water pressure sensors in the rock and the displacement sensors for the canister) out of totally 363 installed sensors are out of order. In Figure 5-1 the numbers of still working sensors in the buffer and the backfill of section 1 are plotted as function of time from September 2001. The figure shows that the majority of the broken sensors are RH-sensors and thermocouples (in deposition hole 3). The figure also shows that the numbers of broken sensors increased after the closing of the drainage of the tunnel.

**Table 5-1. Key dates for section 1.**

Activity	Date
Start backfilling	3/9 2001
Start heating canister 1	17/9 2001
Start heating canister 2	24/9 2001
Start heating canister 3	11/10 2001
Start heating canister 4	22/10 2001
Finish backfilling	20/11 2001
Plug casting	14/12 2001
Decreased power (-20 W)	17/9 2002
Decreased power (-40 W)	5/9 2003
Decreased power (-30 W)	8/9 2004
The drainage of tunnel was closed	1/10 2004
The power to all canisters was switched off	2/12 2004
The drainage of the tunnel was opened	6/12 2004
The power to the canisters was switched on	15/12 2004
Decreased power (-30 W)	2/12 2005
A packer installed in the rock was broken	18/5 2006
Decreased power (-30 W)	21/12 2006
Decreased power (-30 W)	11/12 2007
Decreased power (-30 W)	29/1 2009
Decreased power (-30 W)	21/1 2010
Start of the dismantling of the outer plug	29/11 2010
The dismantling of the section2 has finished	20/12 2011
Decreased power in the canister 1 (-120 W)	6/3 2013
Decreased power in the canister 3 (-1060 W)	20/5 2013
Decreased power in the canister 1 (-290 W)	27/2 2014
Decreased power in the canister 3 (-130 W)	23/4 2014



*Figure 5-1. The number of still working sensors placed in the buffer and backfill in section 1 as function of date. The coloured fields are representing the four types of installed sensors.*

The measured processes were slow up to about 20 days after the drainage of the tunnel was closed. Very small changes of the measured parameters occurred up to that date. After that the readings from some of the total and pore pressure sensors placed in the buffer reacted strongly (quick increase in pressure). Also the total and pore pressure sensors placed in the backfill recorded high pressures caused by the closing of the drainage. After the reopening of the drainage of the tunnel, both the pore pressures and the total pressures in the backfill were stabilized on almost the same level as before the closing of the drainage. At around day 1 670 both the total pressure sensors and the pore pressure sensors are measuring an increase in pressure. This is caused by a failure in one packer placed in the rock at the inner part of the tunnel causing an increase in out flow of water from the inner section from about 1.5 l/min to more than 9 l/min.

A slow but obvious wetting of the backfill is noted until about 20 days after the closing of the drainage. After that a strong increase of the wetting rate was monitored by several psychrometers. The measurement of the temperature on the canister surface with the optical system has stopped functioning.

## **5.2 Deposition hole 1**

### **5.2.1 Total pressure (App. 1\pages 45–46)**

#### **Geokon (App. 1\pages 45–46)**

The measured pressure range is from 1.4 to 8.5 MPa. The highest pressure is indicated from the peripheral sensors in the bottom block (C1). Four sensors in block R5 and block R10 yielded a high increase in total pressure when the drainage of the tunnel was closed. Most of the sensors yielded a drop in pressure when the heaters where switched off and the drainage of the tunnel was opened again and an increase in pressure when the heaters where switched on again.

All of the installed sensors are out of order.

#### **Kulite (App. 1\page 46)**

The highest pressure 7 MPa is indicated from the peripheral sensor (PBU 10012) in block R5. Three of the installed sensors indicated a rapid increase in pressure when the drainage of the tunnel was closed followed by a drop in pressure when the power was switched off and the drainage was reopened. After the power was switched on the pressure increased to the same level as before the closing of the drainage.

Two sensors were not installed and six of the installed sensors are out of order.

### **5.2.2 Relative humidity (App. 1\pages 47–50)**

#### **Vaisala (App. 1\pages 47–48)**

Since temperature is also measured with all relative humidity sensors, the diagrams include those measured temperatures. The temperature measurements start at about 16 degrees while the RH measurements start at about 70 %RH.

The sensors placed above the canister (in Cylinder 3 and 4) are indicating that these sensors have reached 100 relative humidity during this measuring period.

Sixteen sensors are out of order, most of them due to high water saturation of the buffer.

### **Rotronic (App. 1\pages 49–50)**

All Rotronic sensors placed between the canister and the rock measured RH higher than 90 % within 200 days after the start of the test. Two of the sensors placed in the central part of block C1 indicated a drying of the bentonite (decreasing in RH from about 75 %) up to the time when they stopped working (after about 1 000 days).

All of the installed sensors have stopped giving reliable RH values, most of them due to high water saturation of the buffer.

### **5.2.3 Pore water pressure (App. 1\pages 51–52)**

#### **Geokon (App. 1\page 51)**

The highest pressures 500–1 600 kPa are measured near the canister surface in block R5 (UBU10005) and in the periphery of block R5 (UBU10010). Two sensors in block C1 are also recording an increasing pressure (UBU10002, UBU10003) while the rest of the sensors are measuring very low pressures at the last reading before they were broken (day 3 639).

Sensor UBU10003 placed in Block C1 is recording a high pressure about 2.4 MPa during this measuring period.

Seven of eight sensors are out of order.

#### **Kulite (App. 1\page 52)**

Rather high water pressures have been measured by three sensors located in block R5 (1 200–3 500 kPa). One sensor placed in the outer slot started to react about 50 days after the start of the measurement. The pore pressure measured with two of the sensors reacted strongly during the period when the drainage of the tunnel was closed and during the period when the power to the canister was switched off. The sensors measured an increase of the pressure with about 100 kPa after the middle of May 2007. This change in pressure is probably caused by the preparation work done for a new tunnel near by the Prototype tunnel.

All of the installed sensors have stopped giving reliable values.

### **5.2.4 Temperature in the buffer (App. 1\pages 52–55)**

The measured temperature after the power to the canister was switched on again ranges from 28.0 °C (in the periphery of the upper bentonite cylinder C4) to 70.0 °C in block R5 close to the canister. The highest temperature gradient measured in the buffer is 0.57 °C /cm (block R5).

Thirty-two sensors are out of order.

The temperature in the buffer is also measured with the Geokon sensors (from day 1 350). The maximum temperature recorded with these sensors is about 37 °C at the end of this measuring period (UBU10010 placed in block R5).

### **5.2.5 Canister power in dep. hole 1 (App. 1\page 57)**

The power of the canister in whole 1 was kept constant during one year at 1 800 W since the start 010917. After one year the power was decreased with about 20 W. After another year the power was decreased with about 40 W. The next reduction of power was made at the beginning of September year 2004 (about 30 W). The power of the canister in hole 1 was about 1 710 W after this reduction. During the period between December 6 and December 15, 2004 the power to the canister was switched off. After that period the power was adjusted to about 1 710 W again. At the beginning of December 2005, 2006, 2007 and January 2009 and 2010 the power was decreased with 30 W. After these reductions the power was about 1 560 W until 2013-03-06 (day 4 188) when the power has reduced to about 1 440 W due to electrical heater failure. The power has reduced to about 1 150 W during this measuring period due to electrical heater failure.

### **5.2.6 Temperature on the canister surface (App. 1\page 58)**

The first diagram shows the maximum temperature, measured with the optical cables placed on the surface of the canister, plotted as function of time. The maximum measured temperature on the canister surface is about 75 °C. With no damages on the optical cables this plot should have four curves. Only one curve with relevant values is presented here up to December 24 which indicates that the optical cables are damaged. The second diagram shows the distribution of the temperature along the optical cables at December 1, 2004. The length of the cables on the canister surface is about 20 m. The variation of a few degrees is caused by the difference in temperature in the centre and ends of the canister. At December 15, 2004 the optical system for measuring the temperature on this canister stopped functioning.

## **5.3 Deposition hole 3**

### **5.3.1 Total pressure (App. 2\pages 59–61)**

#### **Geokon (App. 2\pages 59–60)**

Most of the sensors placed in block C1 and block R10 yielded an increase in total pressure when the drainage of the tunnel was closed.

The total pressures measured in this deposition hole are significantly lower than those measured in deposition hole 1. The maximum pressure registered so far is 3 MPa (PBU30023). This value was obtained when the drainage was closed. The sensor is placed in block R10.

Sensor PBU30008 placed in block C1 yielded a strong increasing about 3.1 MPa in total pressure in the end of this measuring period.

Twelve sensors are out of order.

#### **Kulite (App. 2\pages 60–61)**

The highest pressure, 2.0 MPa, is indicated from the peripheral placed sensors in block C1. Also two sensors placed in block R10 have measured a pressure higher than 1.5 MPa. The sudden change in pressure which occurred around day 180 was probably caused by early data logger problems.

Eleven sensors are out of order.

### **5.3.2 Relative humidity (App. 2\pages 61–65)**

#### **Vaisala (App. 2\pages 61–63)**

A significant drying of the bentonite close to the top of the canister was observed by the two sensors WBU30022 and WBU30023. After the closing of the drainage both sensors indicated an instant and significant increasing in relative humidity. The still working sensor (WBU30022) is measuring a slowly increasing in humidity, implying a wetting of the buffer close to the canister lid.

An increased wetting of the bentonite can be observed by sensors placed in block R10 between the canister and the rock. One sensor placed in block R5 showed an increase in relative humidity from about 70 % to 82 % after the closing of the drainage.

Two sensors (WBU30019 and WBU30020) placed in block R5 measured a decrease in relative humidity (indicating a drying of the buffer) after the power was switched on again. During this measuring period the still working sensors (WBU30020, WBU30033) are measuring a slowly increase in relative humidity.

Seventeen sensors are out of order.

### **Rotronic (App. 2\pages 63–65)**

All Rotronic sensors in hole 3 have failed or increased the measured RH to 100 %. The reason for this is unclear. Since there are no other signs of strong wetting, malfunction are more probable than strong wetting. One sensor (WBU30016) placed close to the canister in block R5 was indicating a drying of the bentonite until it failed.

### **5.3.3 Pore water pressure (App. 2\page 66)**

#### **Geokon (App. 2\page 66)**

One sensor UBU30014 placed in C4 yields continue increasing to about 1 MPa in the end of this measuring period (day 4 836). All sensors yield very low pressures except for one sensor below the canister that yields a sudden increase to 220 kPa around day 300.

#### **Kulite (App. 2\page 66)**

UBU30004 yielded a maximum pressure of 440 kPa. This sensor is placed near the rock surface at the bottom of the deposition hole. The rest of the sensors yield low pressures. UBU30011 placed in C4 yields increasing to about 100 kPa during this measuring period.

### **5.3.4 Temperature in the buffer (App. 2\pages 67–70 and 71)**

The measured temperature ranges from 38 °C (in the periphery of the upper bentonite cylinder C4) to a temperature of 83.2 °C in the centre close to the canister. These measurements are from the period just before the power to the canisters where switched off. The highest temperature gradient measured with the sensors is 0.59 °C/cm (block R5). There have appeared some problems with some data scan units, which explains the noise in some curves.

30 sensors are out of order.

The temperature in the buffer is also measured with the Geokon sensors (from day 1 350). The maximum temperature recorded at the end of this measuring period with these sensors is about 33 °C (UBU30015 placed in block R5 close to the canister). The temperature drop in the buffer measured by the Gecon sensors is caused by the reduction in the applied power on the canister (day 4 599).

### **5.3.5 Canister Power in dep. hole 1 (App. 2\page 72)**

The power of the canister in hole 3 was kept constant at 1 800 W from the start 011011 until 020917, when the power was decreased with about 20 W. The power has been stepwise decreased according to Table 5-1. During the period between December 6 and December 15 the power of all canisters was switched off. After that period the power was adjusted to about 1 710 W. At the beginning of December 2005, 2006, 2007 and January 2009 and 2010 the power was decreased with 30 W. After these reductions the power was about 1 560 W until 2013-05-20 (day 4 264) when the power has reduced to about 490 W due to electrical heater failure. The power has reduced to about 360 W during this measuring period due to electrical heater failure.

### **5.3.6 Temperature on the canister surface (App. 2\pages 72–73)**

The first diagram shows the maximum temperature plotted as a function of time. The maximum measured temperature on the canister surface was about 100 °C just before the power to the canisters was switched off. The temperature recovered, but only to about 93 °C after the power was switched on again and after that a slightly decrease in temperature was measured until the sensor stopped functioning at the end of August 2005. The second diagram shows the distribution of the temperature along the cables. See also chapter 5.2.6.



## **5.4 Deposition hole 2**

### **5.4.1 Canister power (App. 3\page 75)**

The power of the canister in hole 2 was kept constant at 1 800 W from the start 010924 until 020917, when the power was decreased with about 20 W. After two years (September 2003) the power was decreased with about 40 W to 1 740 W. The interruption in the curve between days 409 and 456 is caused by data collection problems. At the beginning of September 2004 the power was decreased with about 40 W to 1 710 W. Since permanent damages on the heaters in the canister were observed on December 1, 2004 the power to this canister has been switched off and not been restarted.

### **5.4.2 Temperature on the canister surface (App. 3\pages 76–77)**

See chapter 5.2.6. The maximum measured temperature on the canister surface was just before the power was switched off about 96 °C. The reason for the unexpected increase in temperature after 450 days is the difficulties with the measurement of the power (see chapter 5.2.5). The actual power at that time was probably higher than 1 800 W. After the power was switched off the temperature on the canister surface was stabilized on about 30 °C. The sensor stopped giving reliable data at the beginning of June 2005.

## **5.5 Deposition hole 4**

### **5.5.1 Canister power (App. 3\page 78)**

The power of the canister in hole 4 was kept constant at 1 800 W from the start 011011 until 020917, when the power was decreased with about 20 W. Some initial problems with the control system for the power have been overcome. The power has been stepwise decreased according to Table 5-1. During the period between December 6 and December 15 the power of all canisters was switched off. After that period the power was adjusted to about 1 710 W. At the beginning of December 2005, 2006, 2007 and January 2009 and 2010 the power was decreased with 30 W. After the latest reduction the power is now about 1 550 W.

### **5.5.2 Temperature on the canister surface (App. 3\pages 78–79)**

See chapter 5.2.6. The maximum measured temperature on the canister surface after the power was switched on again was 88 °C. The sensor stopped giving reliable data at the beginning of April 2005.

## **5.6 Backfill in section 1**

### **5.6.1 Total pressure in the backfill (App. 4\pages 81–82)**

#### **Geokon (App. 4\pages 81)**

All these sensors yielded high increase in total pressure in connection with closing of the tunnel drainage. The maximum measured pressure was about 2.5 MPa. After the opening of the drainage the total pressure was stabilized on the same level as before the closing of the drainage (maximum pressure about 0.2 MPa). At around the 20th of April 2006, a packer placed in a borehole in section I of the tunnel started to leak resulting in an increase of water drained out from the inner section from about 1.5 l/min to about 9 l/min. The damaged packer caused also an increase in the measured total pressure of about 300 kPa (around day 1 660). At the beginning of April 2007 some of the sensors indicated an increase in the measured pressure. The change in the measure pressures was probably related to the work with the excavation of a new tunnel near by the Prototype-tunnel which was initialized at that time. The measured total pressures at the end of this measuring period vary between 2 400–3 000 kPa at the end of this measuring period. The rapidly increase of pressure in the end of this measuring period caused probably by a damaged packer.

Three sensors are out of order.

### **Kulite (App.4 \pages 82)**

These measurements yielded rather small increase in total pressure until the drainage of the tunnel was closed. The maximum pressure recorded is with PBA10013, about 350 kPa. The sensor stopped functioning during a period of about 100 day after the rapid increase in pressure when the tunnel drainage was closed. Sensor PBA10013 is placed 1.7 m above the bentonite surface in hole 3.

All sensors are out of order.

### **5.6.2 Suction in the backfill (App. 4\pages 83–86)**

The suction in the backfill is measured with Wescor psychrometers. The steady but slow wetting (decrease in suction) observed in about 50 % of the sensors continues. Seven sensors close to the roof and walls of the tunnel and one sensor just above the buffer in hole 1 indicate fast wetting that has gone close to water saturation (less than 1 000 kPa suction). Also the sensor placed just inside the plug has reached a suction value that indicates saturation. In connection with the closing of the drainage, a very rapid decrease in suction was recorded by the installed psychrometers. Six of these sensors placed in the central part of the tunnel section yielded an increase in suction, after the reopening of the drainage, to the same level as before the closing. Seven of the sensors measured a decrease in suction after the packer was damaged.

All of these sensors have stopped giving reliable values due to high water saturation of the backfill.

### **5.6.3 Pore water pressure in the backfill (App. 4\pages 86–88)**

#### **Geokon (App. 4\pages 86–87)**

All these sensors yielded high increase in pore pressure when the drainage of the tunnel was closed. Many of the sensors recorded pressures up to 2.5 MPa. After the opening of the drainage the pore pressure was stabilized at low pressures (below 0.1 MPa). Also these sensors reacted when the packer was broken by measuring an increase in pore pressure of about 200 kPa. At the beginning of April 2007 some of the sensors are indicating an increase in the measured pressure. The change in the measure pressures is probably related to the work with the excavation of a new tunnel near by the Prototype-tunnel which was initialized at that time. The measured pore pressures vary between 2 000–2 500 kPa at the end of this measuring period. The rapidly increase of pressure in the end of this measuring period caused probably by a damaged packer.

#### **Kulite (App. 4\pages 87–88)**

Also some of these sensors recorded very high water pressure after the closing of the drainage. The still functioning sensors measured an increase in pore pressure of about 200 kPa at the time when the packer installed in the rock was broken. The sensors reacted also when the excavation of the nearby tunnel was initialized. Tow still functioning sensors UBA10005 and UBA10007 have recorded suddenly increasing to about 2 500 kPa in the end of this measuring period (day 4 836). The rapidly increase of pressure in the end of this measuring period caused probably by a damaged packer.

Eleven sensors are out of order.

### **5.6.4 Temperature in the backfill (App. 4\pages 88–90)**

The measured temperature in the backfill over the whole test period ranges from 16 to 35 °C. The highest temperature was as expected measured above the buffer in hole 3 just before the drainage was opened. Also these sensors reacted when the packer was broken (a decrease in temperature). The measured temperatures at the end of this measuring period vary between 17 and 24 °C.

## **5.7 Temperature in the rock**

### **5.7.1 Near hole 1 (App. 1\pages 56–57)**

The maximum temperature measured in the rock is 38.6 °C. This temperature was measured with the thermocouple TROA1030 located 2.038 m from the centre of the canister in deposition hole 1. The temperature in the rock close to the deposition hole decreased when the power to the canisters was switched off but increased again when the power was switched on to a temperature about 1 °C lower than before the power was switched off. The temperature is continuing to drop and the maximum temperature at the end of this measuring period is about 31 °C. The temperature decreasing in the rock caused by problem with applied power in the canister.

### **5.7.2 Near hole 2 (App. 3\page 75)**

The maximum temperature in the rock (46.8 °C) was measured by TROA1820 located 2.490 m from the centre of the canister in deposition hole 2 just before the power to the canisters was switched off. Since no power is applied to this canister anymore the temperature in the rock around the deposition hole is continuing to decrease and the maximum temperature at the end of this measuring period is about 25 °C. The temperature decreasing in the rock caused by problem with applied power in the canister.

### **5.7.3 Near hole 3 (App. 2\pages 70–71)**

The maximum temperature in the rock (48.8 °C) was measured by TROA2120 located 1.967 m from the centre of the canister in deposition hole 3 just before the power to the canisters was switched off. Although the power was switched on again the temperature around the deposition hole is continuing to drop. This is most obvious for the sensors installed in the direction towards deposition hole 2. The maximum temperature measured temperature at the end of this measuring period is about 27 °C. The temperature decreasing in the rock caused by problem with applied power in the canister.

### **5.7.4 Near hole 4 (App. 3\page 77)**

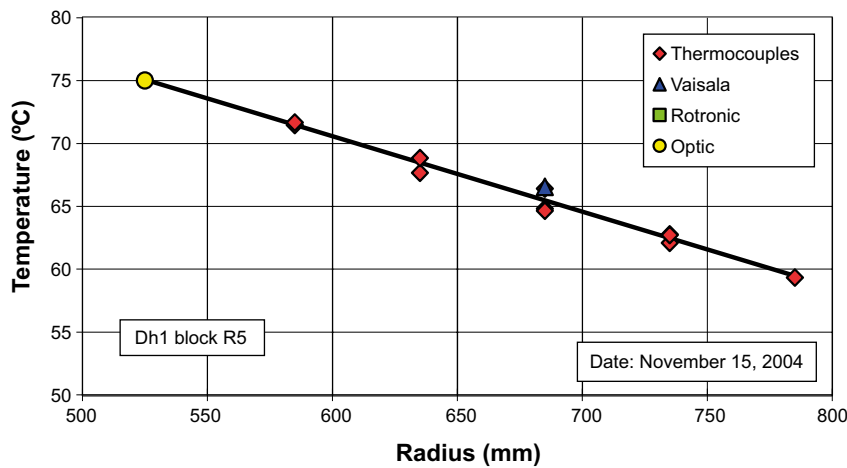
The maximum temperature in the rock (46.5 °C) is measured by TROA3030 located 2.034 m from the centre of the canister in deposition hole 4. Also for this deposition hole there was a drop in the temperature in the rock when the power was switched off. After the power was switched on again the temperature in the rock increased to almost the same level as before the power was switched off and has been remained relatively constant until last measuring period (day 4264) after reduction of power in the canister in hole3. The maximum temperature in the rock at the end of this measuring period is about 37 °C. The temperature decreasing in the rock caused by problem with applied power in the canister.

## **5.8 Analyze of data from section 1**

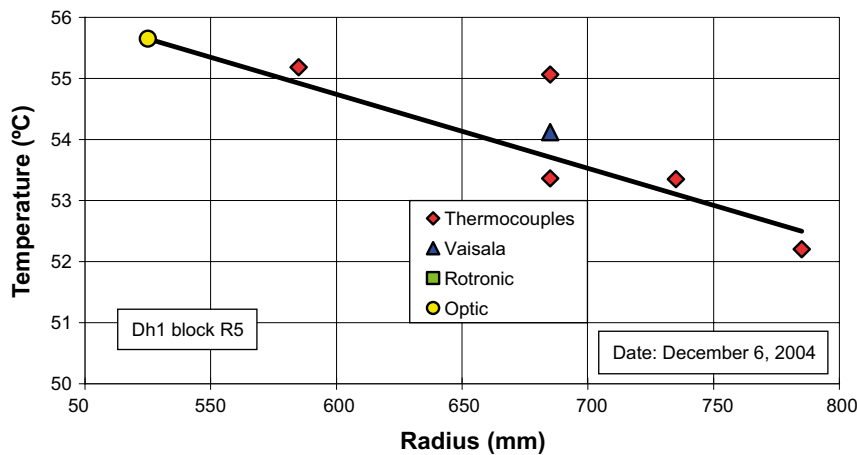
### **5.8.1 Deposition hole 1**

Before the drainage of the tunnel was closed and the power of the canister was switched off the saturation of the buffer at mid height of the canister in block R5 was considered (indicated both by the relative humidity sensors and total pressure sensors) to be high even close to the canister (PBU10015). Also installed pore pressure sensors placed in block R5 (e.g. UBU 10007) are measuring high pressures close to the canister which also is indicating that the bentonite is saturated. This was not changed when the drainage was opened and the power of the canister was switched on again. The degree of saturation in the solid blocks both under (Block C1) and above the canister (Blocks C2–C4) is much lower. However the degree of saturation interpretable from measurements of relative humidity, swelling pressure and pore pressure is increasing with time. This trend is continuing with the same rate after the drainage was opened and the power was switched on.

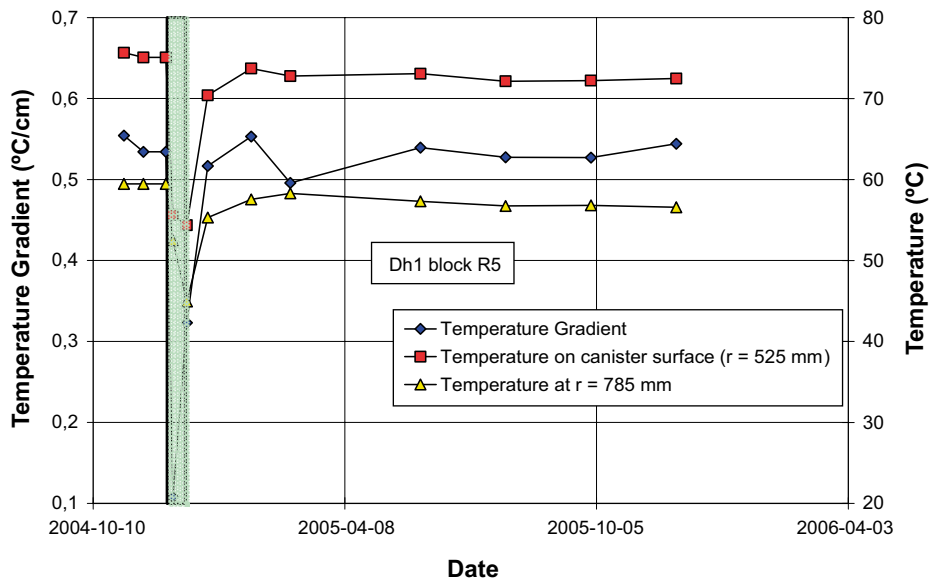
In Figure 5-2 the temperature in the buffer is plotted as function of the radius from the centre of the deposition hole. The measurements are made with different type of sensors in block R5 (at mid height of the canister). A straight line is fitted to the measured values. The temperature gradient is determined from the fitted line in the figure. This gradient together with the temperature on the canister surface and the temperature in the buffer close to the outer radius of the ring shaped block ( $r = 785 \text{ mm}$ ) are plotted as function of time in Figure 5-4. The shaded part of the plot represents the time when the power to the canister was switched off at the beginning of December 2004. The plot shows that the temperature after this is somewhat lower than before, probably due to the fact that no power is applied to canister 2 after December 2, 2004. However the temperature gradient over the buffer is similar before and after the switch on/off the power of the canisters. The determination of the gradient was made up to the beginning of December 2005. After that the number of still working sensors are too few, to be able to determine the temperature gradient.



**Figure 5-2.** The temperature in block R5 in Dh 1 as function of radius from the centre of the deposition hole on November 15, 2004.



**Figure 5-3.** The temperature in block R5 in Dh 1 as function of radius from the centre of the deposition hole on December 6, 2004.



**Figure 5-4.** The temperature and temperature gradient plotted as function the date in deposition hole 1 block R5.

### 5.8.2 Deposition hole 3

The saturation of the buffer, as an average, indicated by both RH-transducers and total pressure transducers was before the closing of the drainage much lower compared to the buffer in deposition hole 1, although some total pressure sensors placed above and under the canister indicated rather high total pressures. When the drainage was closed those total pressure sensors which before had indicated high total pressure reacted with a rapid increase in pressure while the rest of the transducers did not react at all. When the drainage was opened again and the power to the canisters was switched off there was a decrease in the pressure. For most of the transducers the pressure went down to the same level as before the closing of the drainage. One RH sensor placed in block R5 at a radius of 785 mm reacted with a significant increase in RH (from 70 % to 82 %) when the drainage was closed. The RH was maintained on the higher level even after the opening of the drainage. Also some transducers placed in the buffer but close the canister top reacted with an increase in RH of about 5 %. These transducers had before the closing of the drainage indicated a drying of the buffer. The rest of the RH transducers reacted very little at the closing/opening of the drainage. The buffer is today far from saturated (indicated both by RH-sensors, total pressure sensors and pore pressure sensors).

In Figure 5-5 the temperature in deposition hole 3 is plotted as function of the radial distance from the centre of the deposition hole. Compared with the corresponding plot for deposition hole 1 this plot shows a significant drop in temperature between the surface of the canister

and the buffer (inner diameter of the ring). This indicates that the initial slot (of about 10 mm) between the canister and the buffer was still open.

The temperature gradient over the inner slot together with the temperature on the canister and the temperature on the inner radius of the ring shaped block are plotted as function of time in Figure 5-6. The shaded part of the plot represents the time when the power to canisters was switched off. Immediately after the power was switched off the temperature gradient increased which indicate that the slot was isolating the canister resulting in a much faster drop in temperature of the buffer than the canister surface. When the power was switched on again the temperature gradient over the slot reached the same level as before the closing of the drainage indicating an open slot between the canister and the buffer. The figure also shows that the gradient is decreasing with time which might be an indication that the gap is getting smaller. The sensors for measuring the temperature on the canister surface stopped functioning of August 2005. The temperature gradient over the inner slot could not be calculated after that date.

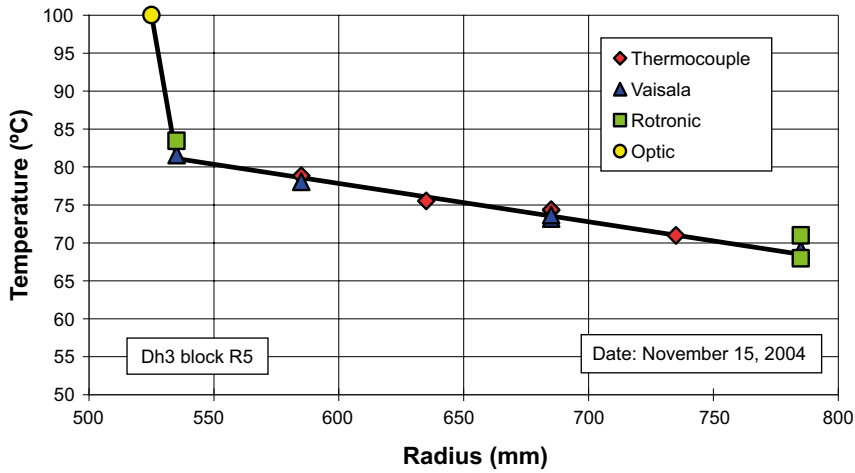


Figure 5-5. The temperature in block R5 in Dh 3 as function of radius from the centre of the deposition hole on November 15, 2004.

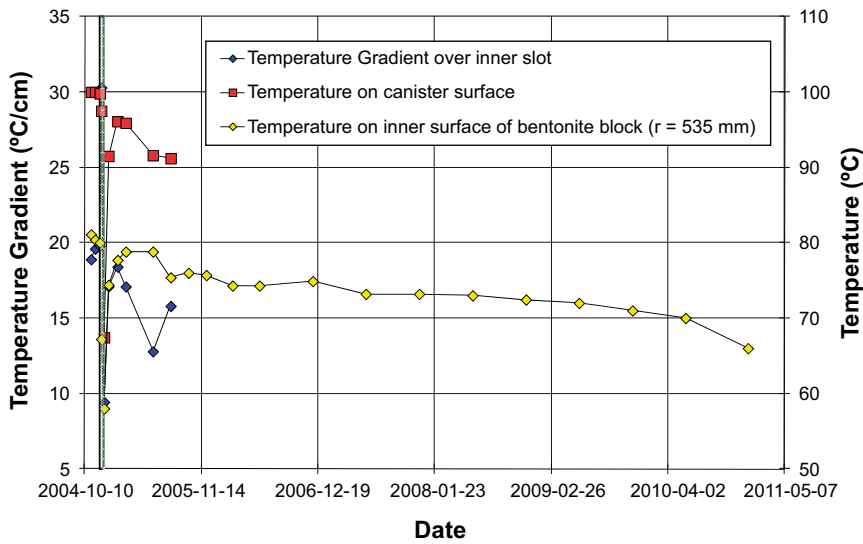


Figure 5-6. The temperature and temperature gradient over the inner slot plotted as function the date in deposition hole 3 block R5.

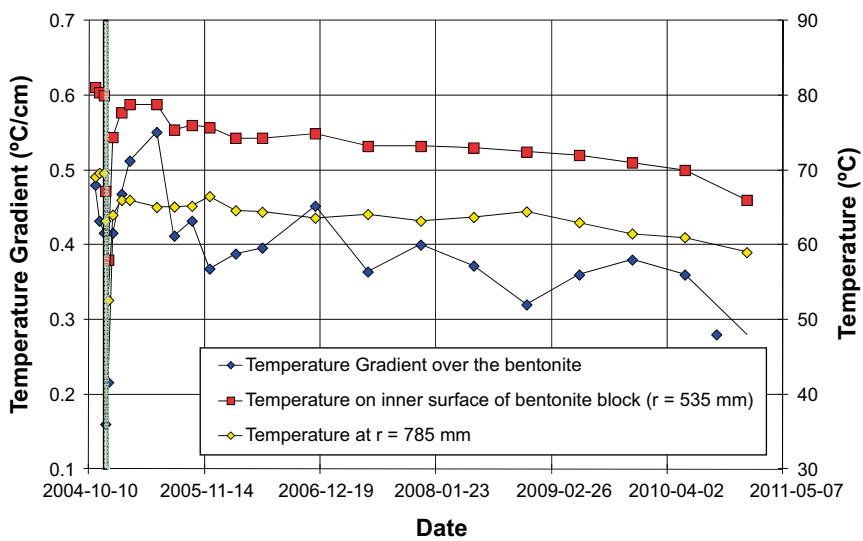
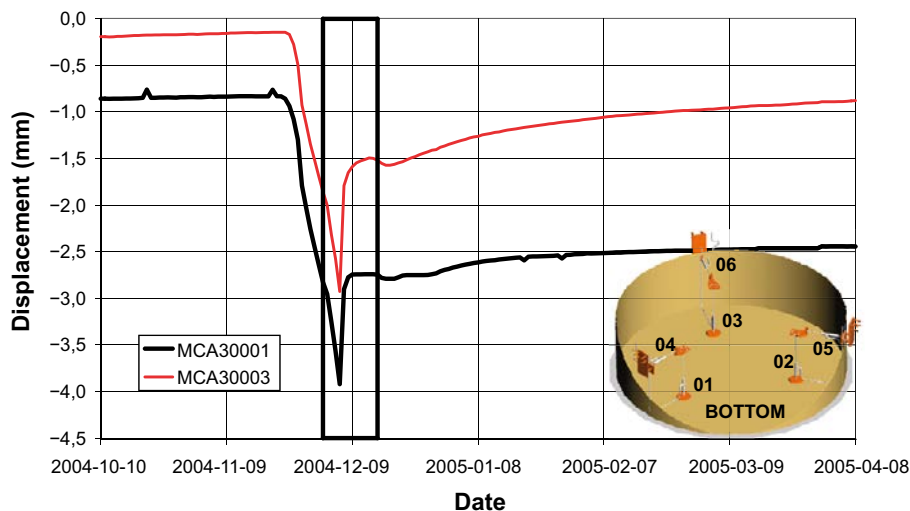


Figure 5-7. The temperature and temperature gradient over the buffer plotted as function the date in deposition hole 3 block R5.



**Figure 5-8.** Vertical displacement of the canister in Dh 3. Negative sign on the displacement means that the canister is moving downwards.

The temperature gradient over the buffer is plotted in Figure 5-7 together with the temperature on the inner surface of the block and the temperature at the radius of  $r = 785$  mm. After the power was switched on again also this gradient stabilized on the same level as before the power was switched off.

A conclusion of the analyses is that even though the pressure in the backfill and in the surrounding rock was high (more than 2 MPa) when the drainage was closed, water did not enter the inner slot between the buffer and the canister. The fact that no water pressure acted directly on the canister surface can also explain the large vertical displacement of the canister measured when the drainage was closed (see Figure 5-8). If the increased pore pressure (2.5 MPa) would act directly on the canister surface the deformation should be much smaller than what was measured. The measured deformation was probably caused by large deformations of the solid bentonite block below the canister.

### 5.8.3 Backfill

The pore pressure in the backfill increased fast from a low level when the drainage of the tunnel was closed. This affected the rate in which the backfill was saturated measured both with soil psychrometers and with resistivity measurements made by GRS. After the drainage was reopened the pore pressure stabilized on the same level as before it was close. The saturation rate (measured with both psychrometers and resistivity measurements) decreased to the same rate as before the closing of the drainage for most of the sensors.

When a packer placed in a borehole in section I was broken (at the middle of April 2006) the pressure in the backfill (both total pressure and pore pressure) increased with about 300 kPa.

An increase of the total pressure and the pore pressure can also be observed around day 2040 (corresponding to the date 2007-04-19). The increase in pressure is probably related to the work with the excavation of a new tunnel nearby the Prototype-tunnel which was initialized at that time. The pore pressure and total pressure are continuing to increase and the total pressure has at the end of this measuring period reach a maximum of about 900 kPa.

The change in pressure affected also the measured suction values (measured with soil psychrometers). Eight of the sensors measured a decrease in suction of about 500 kPa due to the broken packer. All of the installed sensors have stopped giving reliable values after most of them have reached a suction value less than 1 000 kPa which is indicating that the backfill is saturated.

The outflow from the inner section of the Prototype tunnel as function of time is shown in Figure 5-9. The figure is showing that the outflow from section I increased from about 1.8 l/min to about 9 l/min when the installed packer was broken. The large scatter and the increase in the outflow starting at the beginning of summer 2007 are probably caused by the work with the new tunnel placed close to the Prototype tunnel.

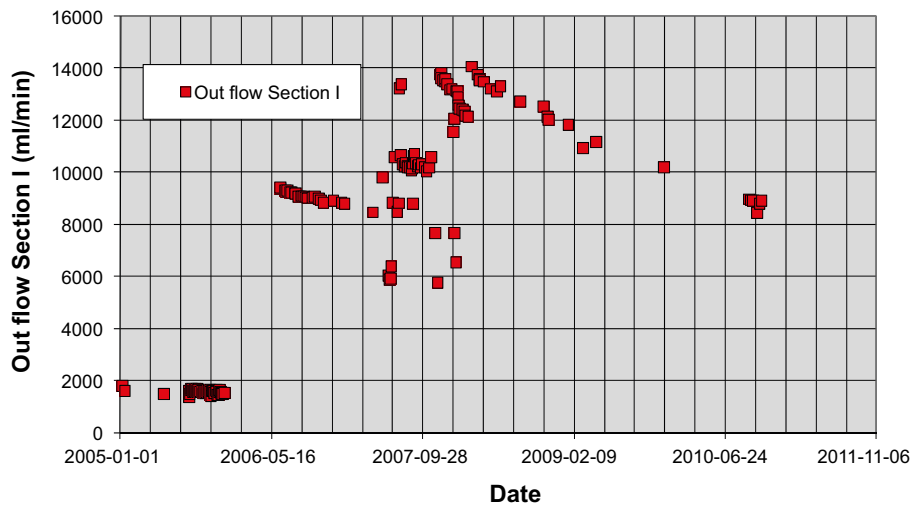


Figure 5-9. The measured outflow from the inner section of the Prototype tunnel.



## References

SKB's (Svensk Kärnbränslehantering AB) publications can be found at [www.skb.com/publications](http://www.skb.com/publications).

**Börgesson L, Sandén T, 2001.** Äspö Hard Rock Laboratory. Prototype Repository. Report on instrument positions in buffer/backfill and preparation of bentonite blocks for instruments and cables in section I. SKB IPR-01-20, Svensk Kärnbränslehantering AB.

**Goudarzi R, 2014.** Prototype Repository – Sensor data report (Period 010917–130101). Report No 25. SKB P-13-39, Svensk Kärnbränslehantering AB.

**Goudarzi R, 2015.** Prototype Repository – Sensor data report (Period 010917–140101). Report No 26. SKB P-14-30, Svensk Kärnbränslehantering AB.

**Forsmark T, Rhén I, Andersson C, 2001.** Äspö Hard Rock Laboratory. Prototype Repository. Hydrogeology – Injection test campaign 2, Flow measurement of DA3575G01, groundwater salinity, ground water leakage into G-, I- and J-tunnels. SKB IPR-01-31, Svensk Kärnbränslehantering AB.

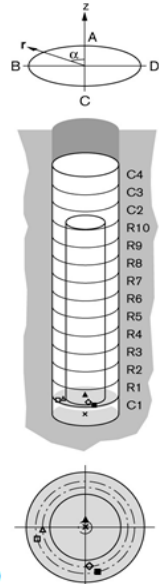
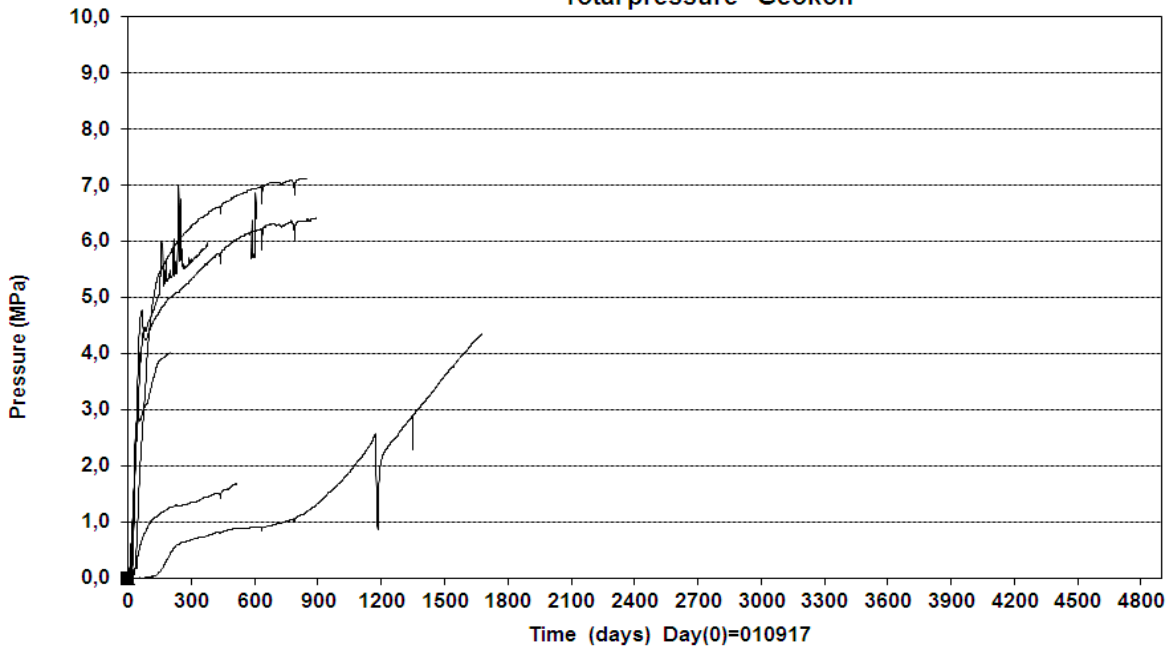
**Rhén I, Forsmark T, 2001.** Äspö Hard Rock Laboratory. Prototype Repository. Hydrogeology. Summary report of investigations before the operation phase. SKB IPR-01-65, Svensk Kärnbränslehantering AB.

**Rhén I, Forsmark T, Torin L, Puigdomenech I, 2001.** Äspö Hard Rock Laboratory. Prototype Repository. Hydrogeological, hydro-chemical and temperature measurements in boreholes during the operation phase of the Prototype Repository. Tunnel section I. SKB IPR-01-32, Svensk Kärnbränslehantering AB.



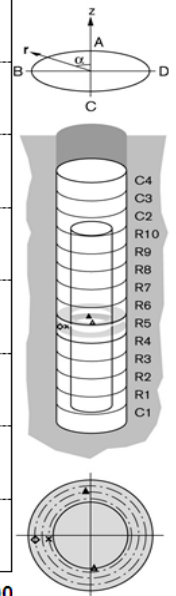
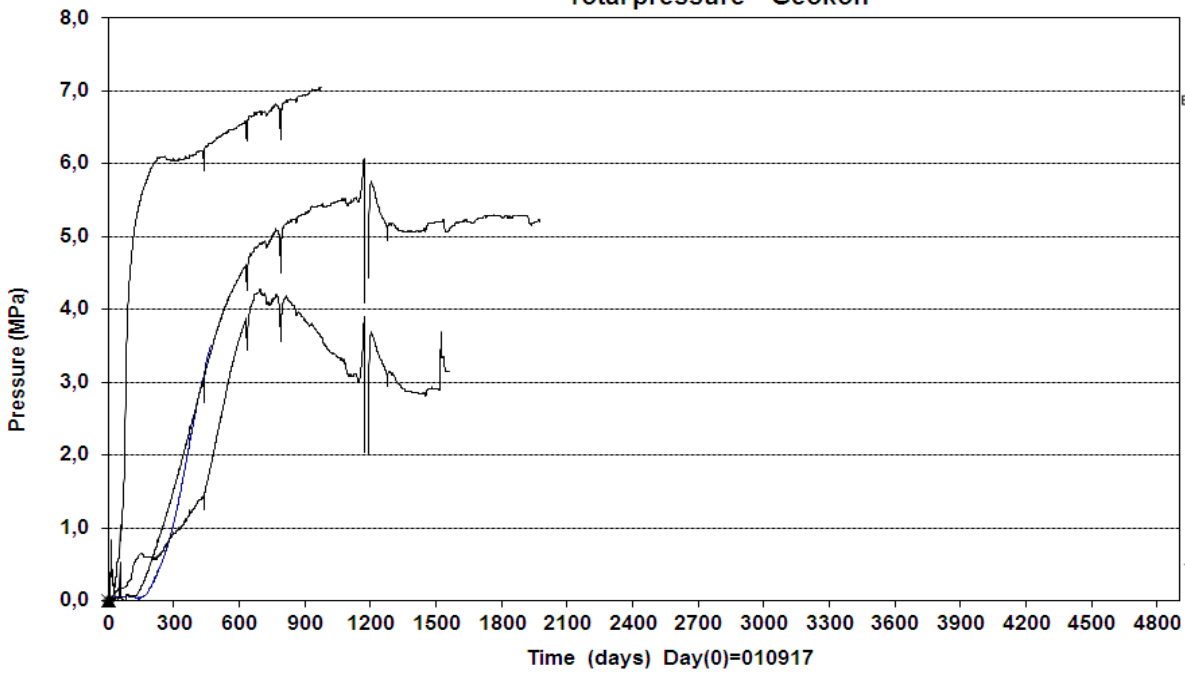
Dep. hole 1

Prototype\Hole 1\Cyl.1 (010917-20150101)  
Total pressure - Geokon



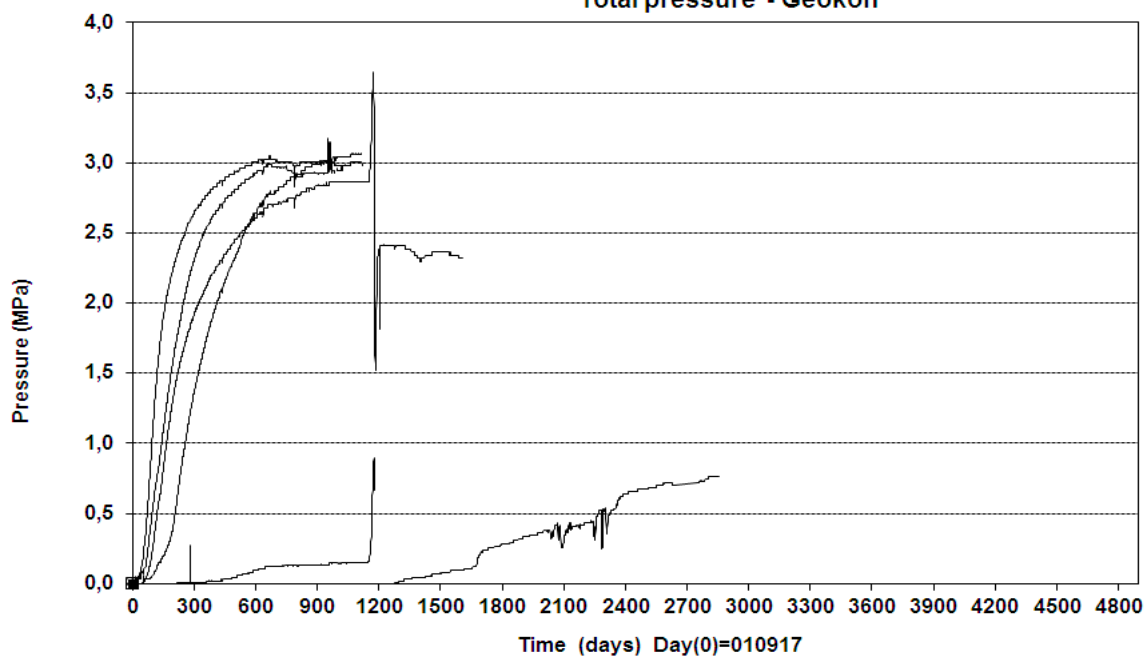
× PBU10001(0 0° 0)	▲ PBU10002(0.504 0° 0.100)	◇ PBU10008(0.504 185° 0.635)
△ PBU10006(0.504 95° 0.635)	□ PBU10007(0.504 105° 0.735)	■ PBU10009(0.504 195° 0.735)

Prototype\Hole 1\Ring5 (010917-20150101)  
Total pressure - Geokon



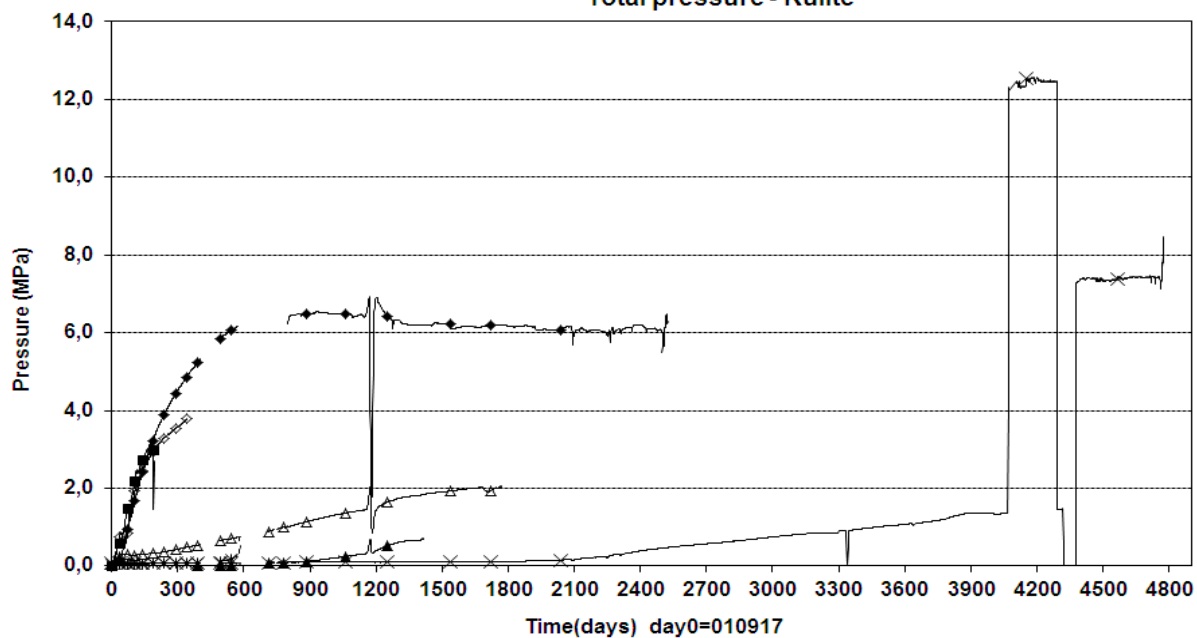
× PBU10013(2.780 95° 0.585)	▲ PBU10011(2.780 5° 0.685)
◇ PBU10014(2.780 95° 0.785)	△ PBU10015(3.030 185° 0.535)

PrototypeHole 1\ Ring10 and Cyl.3 (010917-20150101)  
Total pressure - Geokon



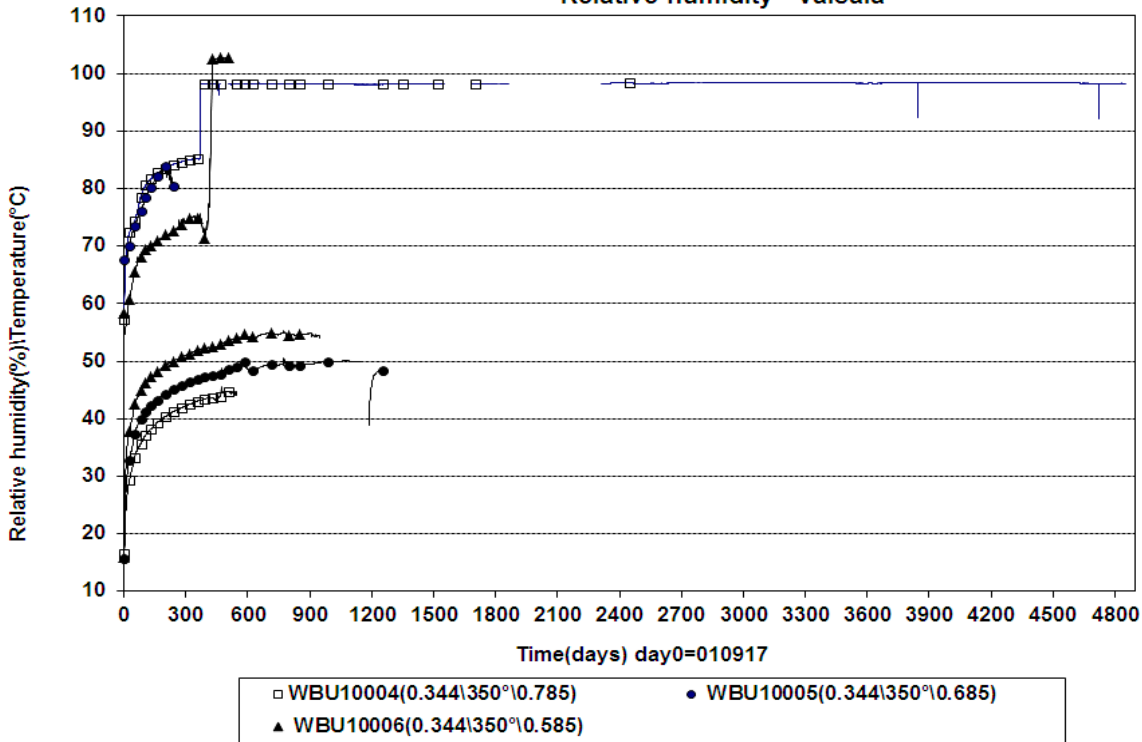
× PBU10017(5.558\0°\0.050)	▲ PBU10021(5.558\90°\0.635)	◇ PBU10022(5.558\100°\0.735)
△ PBU10023(5.558\190°\0.735)	□ PBU10026(6.567\5°\0.585)	■ PBU10024(5.558\180°\0.635)

Prototype\ Hole 1 (010917-20150101)  
Total pressure - Kulite

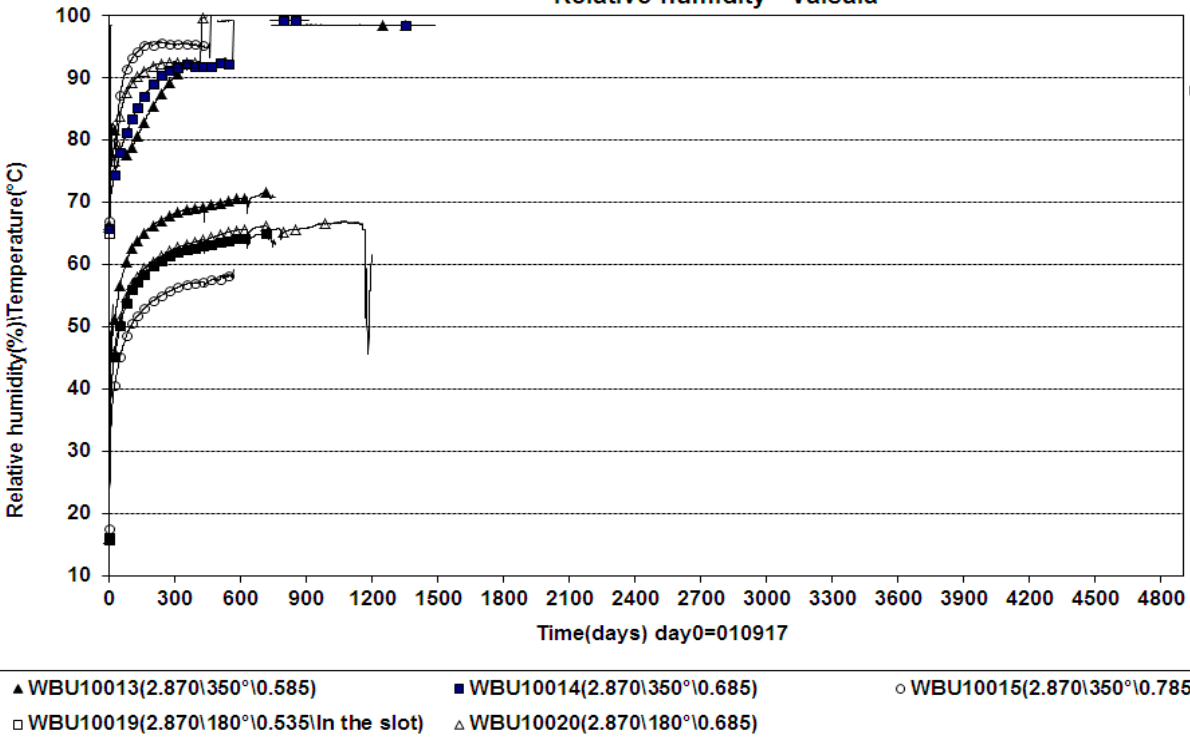


■ PBU10004(0.504\5°\0.685)	◇ PBU10005(0.504\5°\0.785)	◆ PBU10012(3.030\5°\0.785)
▲ PBU10019(5.558\5°\0.685)	△ PBU10020(5.558\5°\0.785)	× PBU10025(6.317\0°\0.050)
* PBU10027(7.076\0°\0.050)		

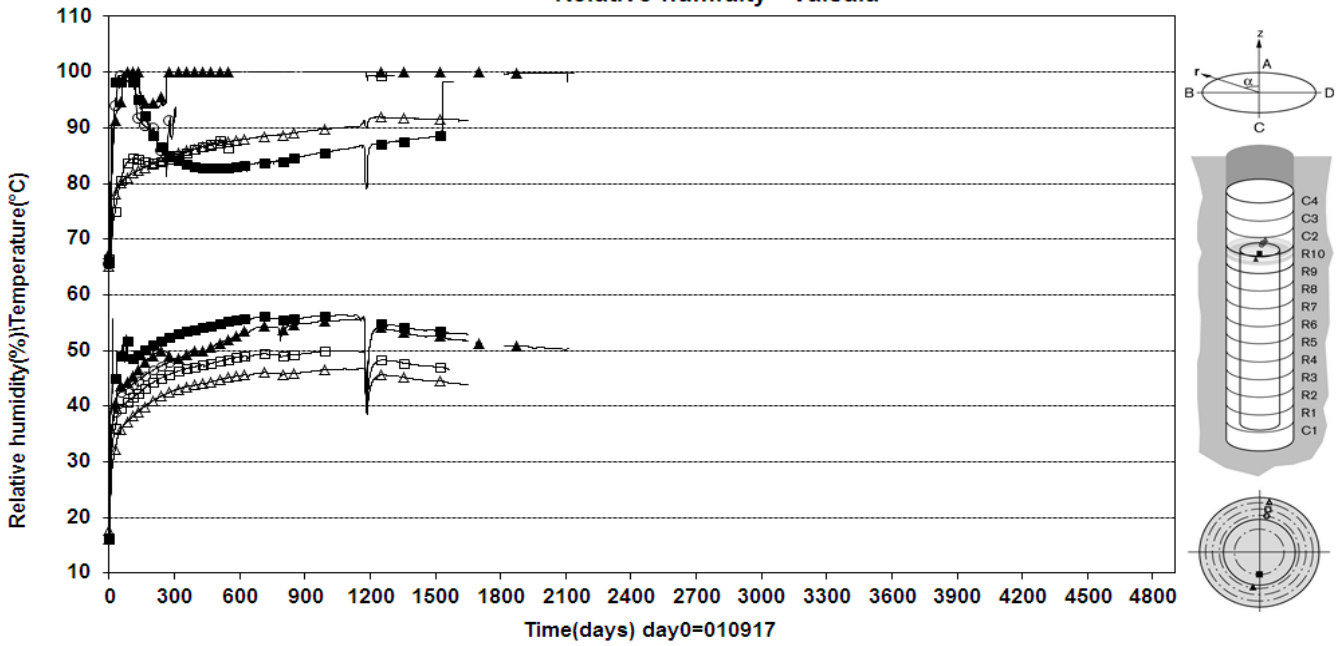
Prototype\Hole 1\Cyl.1 (010917-20150101)  
Relative humidity - Vaisala



Prototype\Hole 1\Ring.5 (010917-20150101)  
Relative humidity - Vaisala

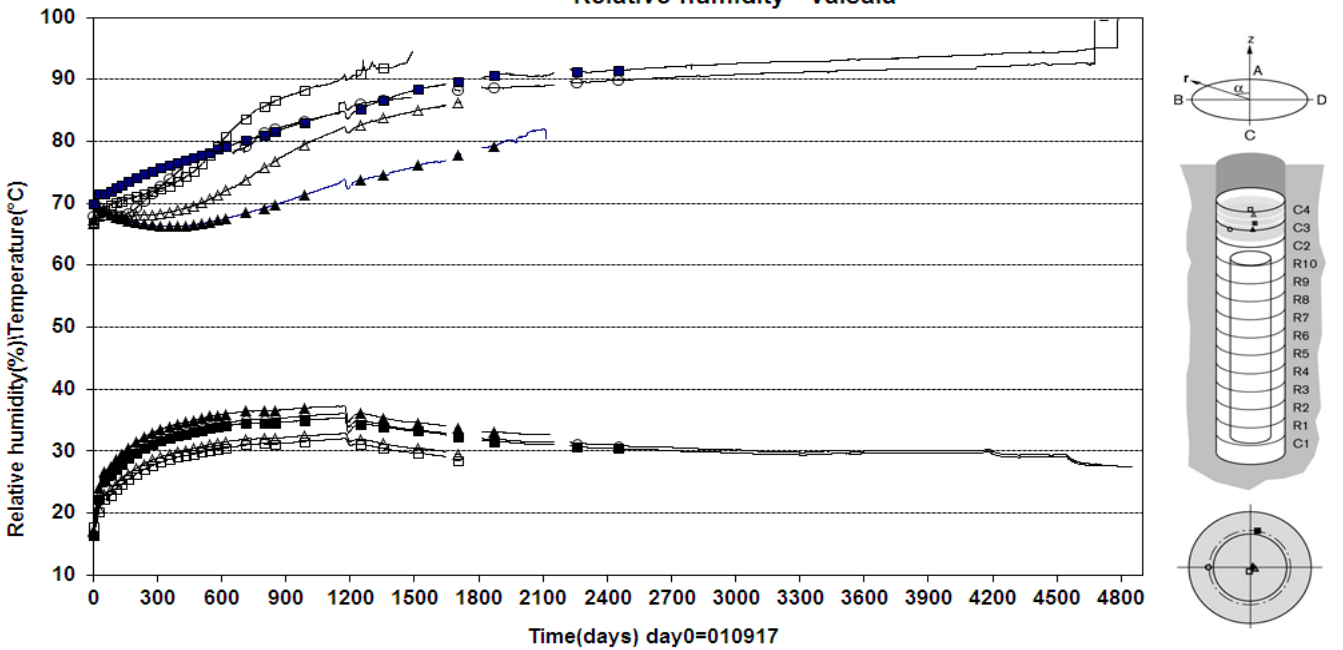


PrototypeHole 1\Ring10 (010917-20150101)  
Relative humidity - Vaisala



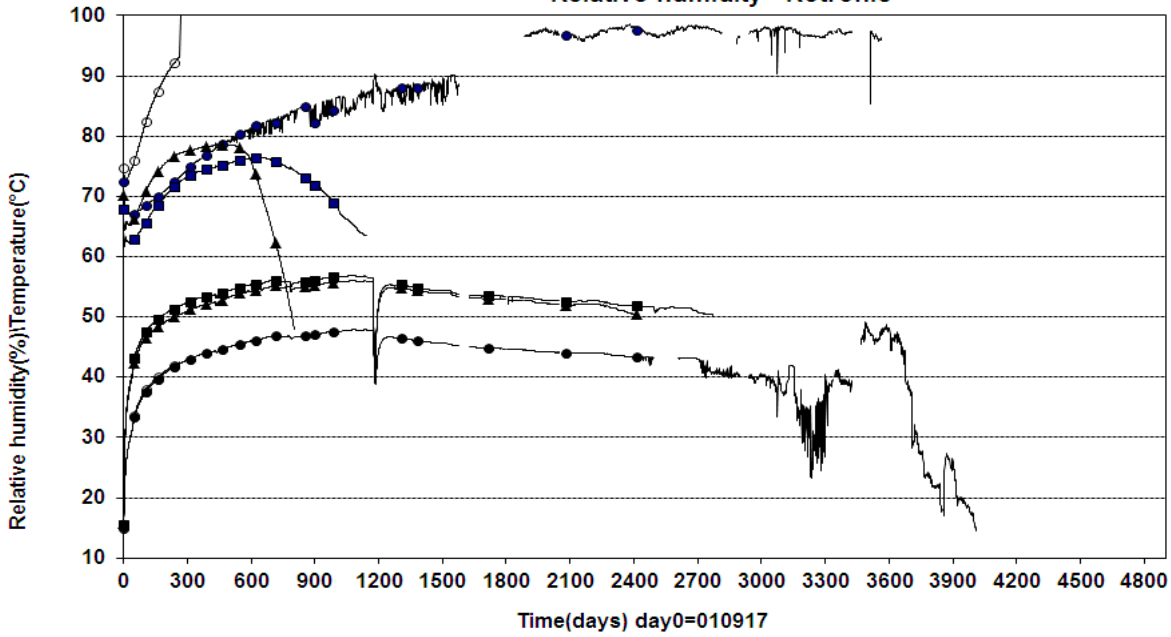
- |                              |                              |                              |
|------------------------------|------------------------------|------------------------------|
| ■ WBU10023(5.428\180°\0.362) | ○ WBU10024(5.398\350°\0.585) | □ WBU10025(5.398\350°\0.685) |
| △ WBU10026(5.398\350°\0.785) | ▲ WBU10030(5.398\170°\0.585) |                              |

PrototypeHole 1\Cyl.3 and Cyl.4 (010917-20150101)  
Relative humidity - Vaisala



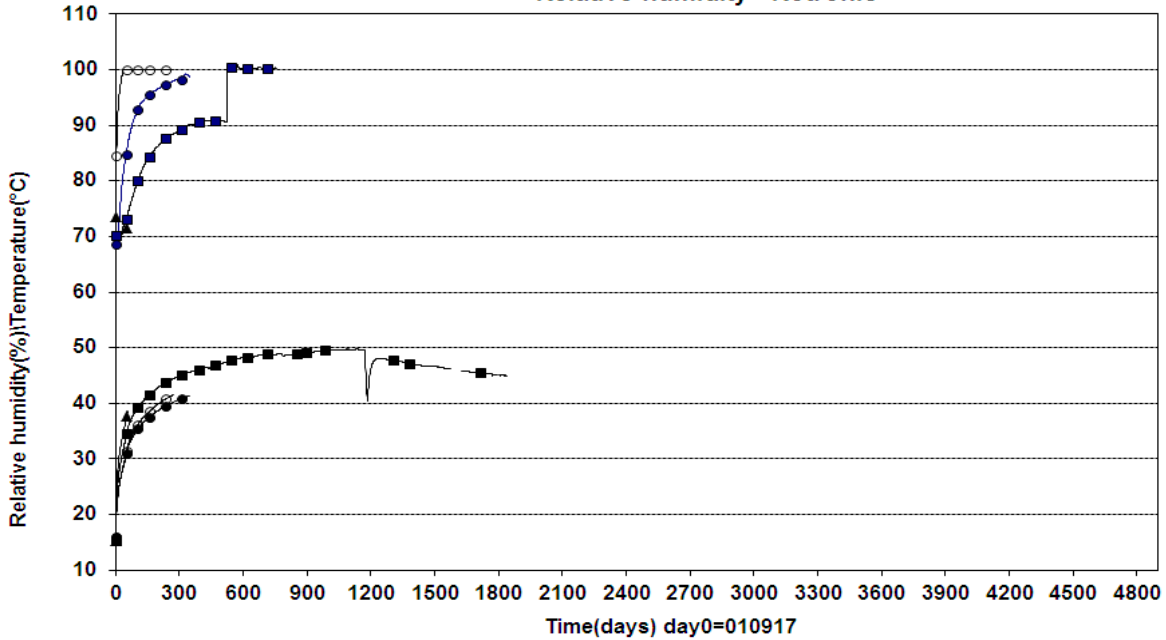
- |                              |                              |                             |
|------------------------------|------------------------------|-----------------------------|
| ▲ WBU10032(6.317\270°\0.050) | ■ WBU10033(6.317\350°\0.585) | ○ WBU10034(6.317\90°\0.585) |
| □ WBU10036(6.916\180°\0.050) | △ WBU10037(6.756\270°\0.050) |                             |

Prototyp\Hole 1\Cyl.1 (010917-20150101)  
Relative humidity - Rotronic



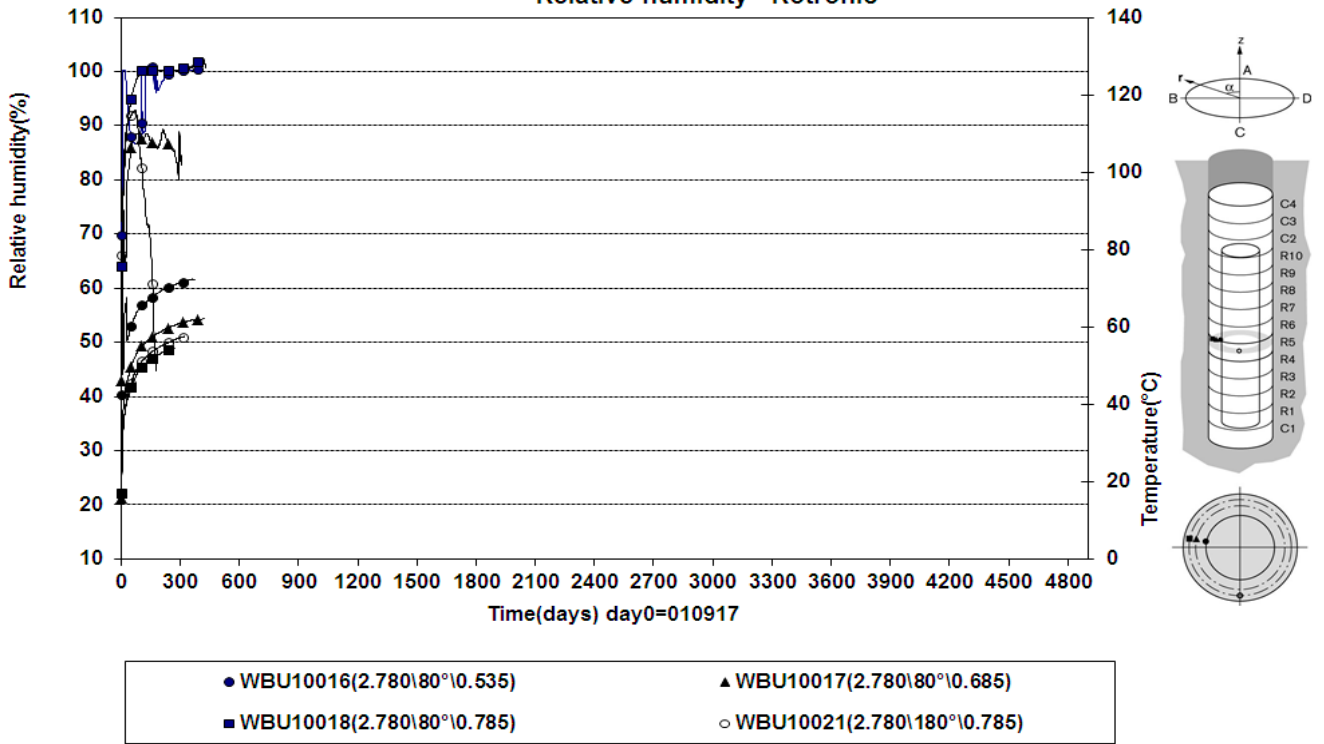
- WBU10001 (0.054\180°\0.050)
- ▲ WBU10002 (0.254\0°\0.400)
- WBU10003 (0.254\180°\0.100)
- WBU10008(0.254\180°\0.685)

Prototyp\Hole 1\Cyl.1 (010917-20150101)  
Relative humidity - Rotronic

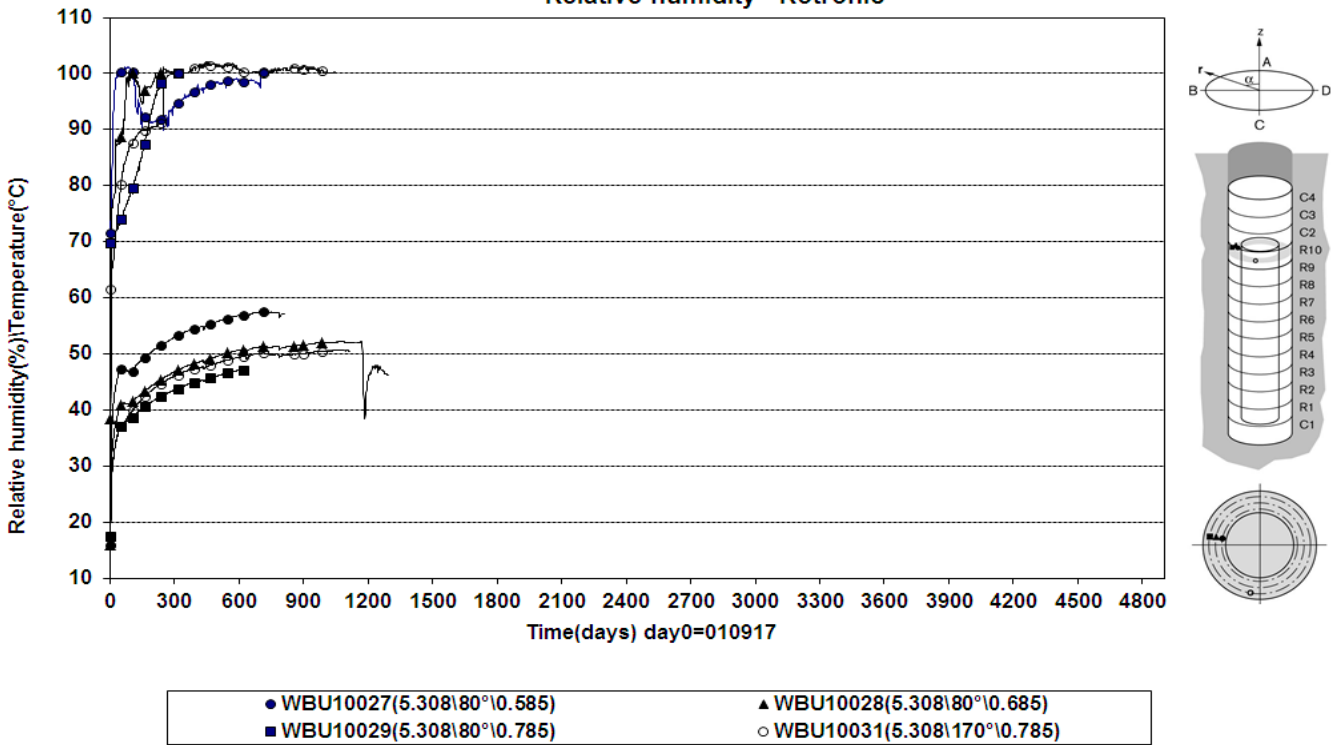


- WBU10009(0.254\180°\0.785)
- ▲ WBU10010(0.254\170°\0.585)
- WBU10011(0.254\170°\0.685)
- WBU10012(0.254\170°\0.785)

Prototyp\Hole 1\Ring.5 (010917-20150101)  
Relative humidity - Rotronic

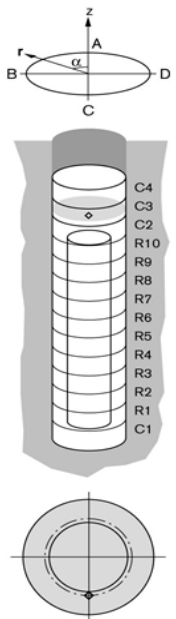
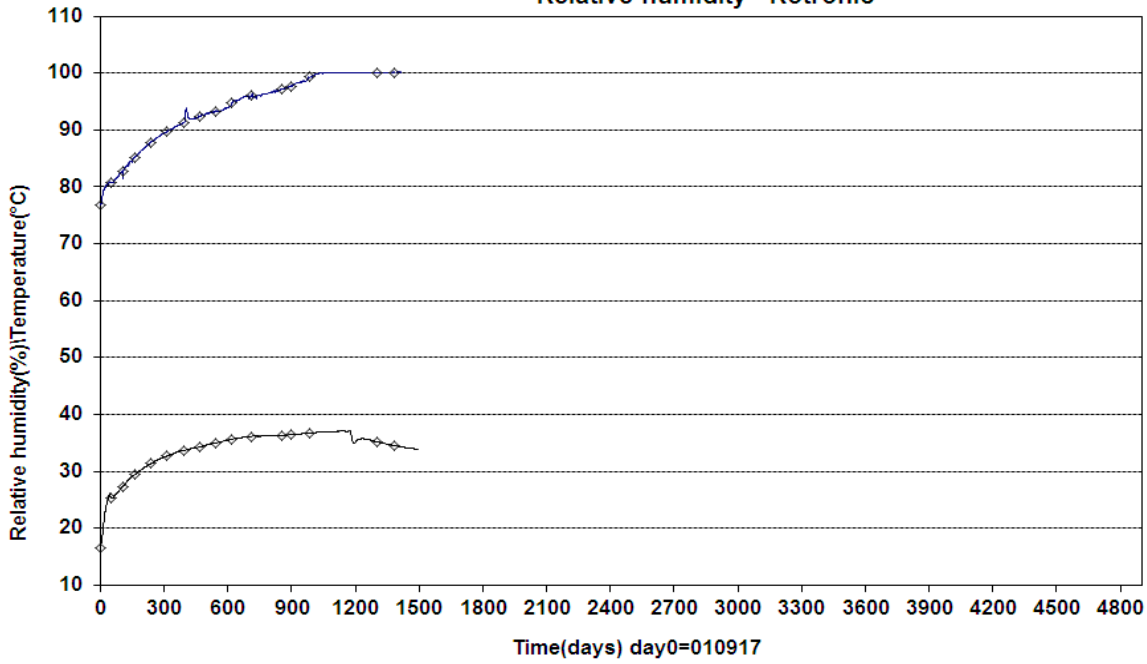


Prototyp\Hole 1\Ring10 (010917-20150101)  
Relative humidity - Rotronic



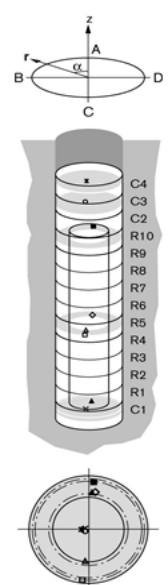
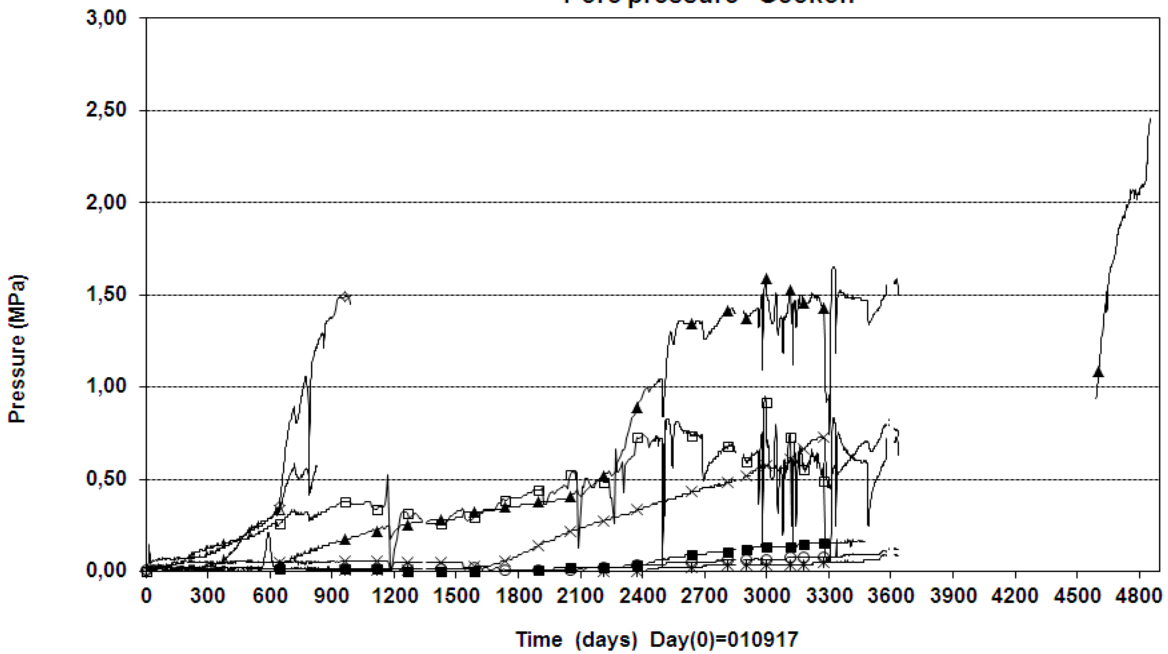


Prototyp\Hole 1\Cyl.3 (010917-20150101)  
Relative humidity - Rotronic



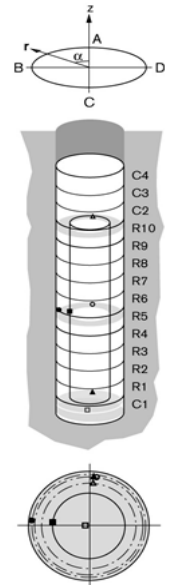
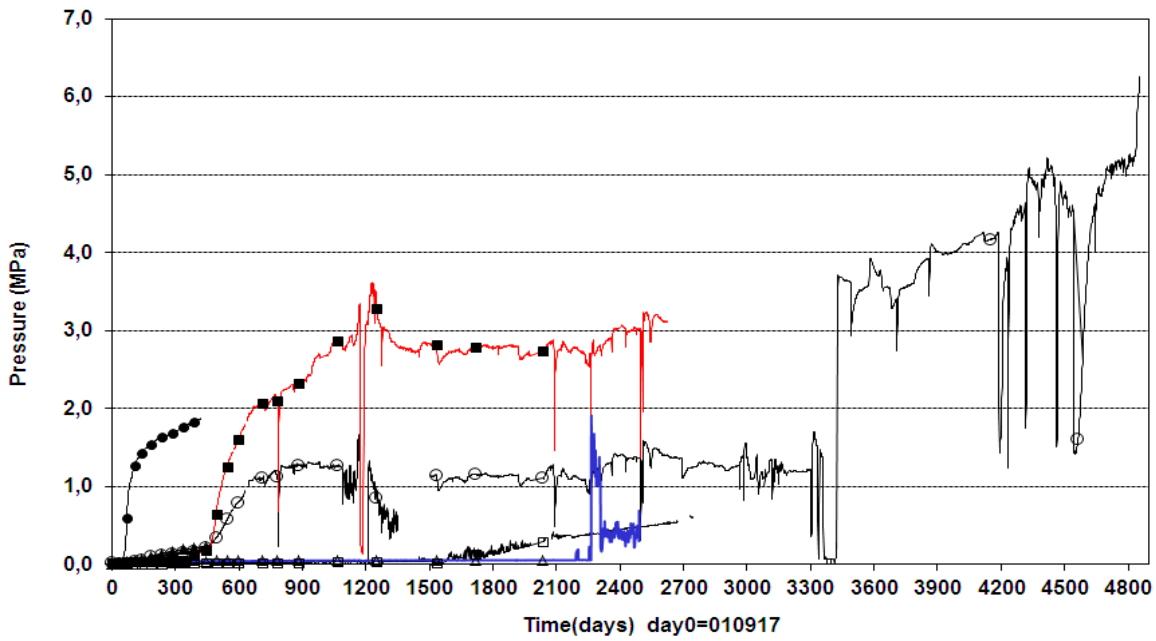
◇ WBU10035(6.317\180°\0.585)

Prototyp\Hole 1 (010917-20150101)  
Pore pressure - Geokon



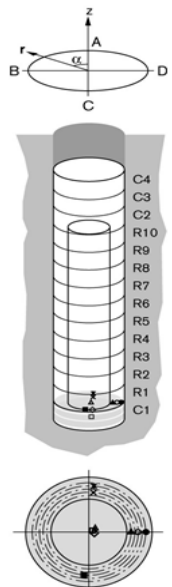
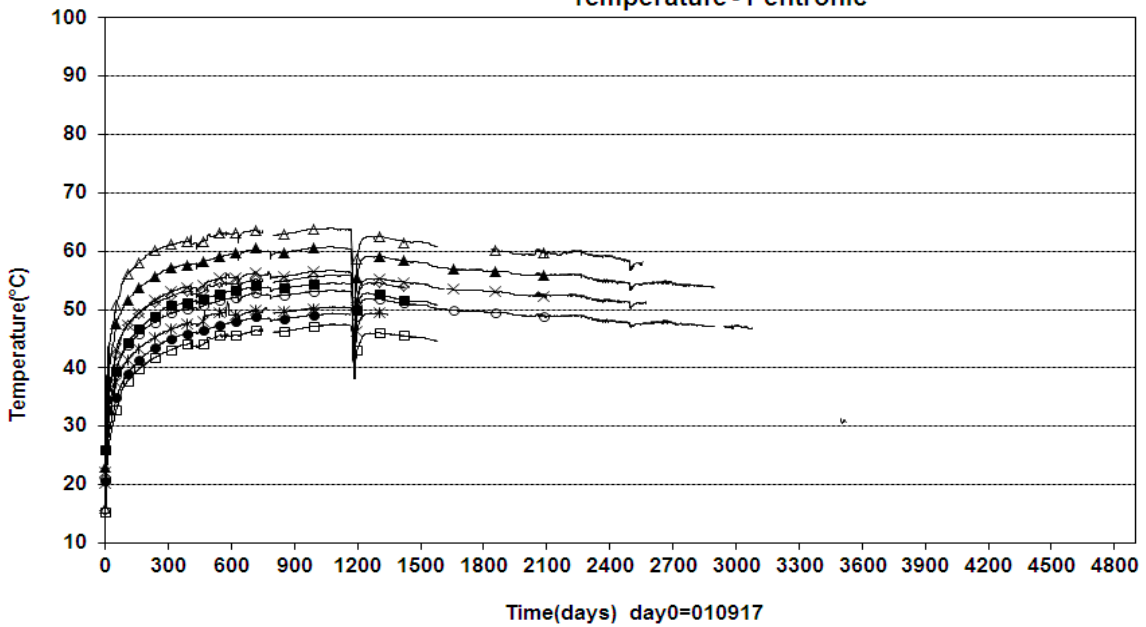
× UBU10002(0.254\90°\0.100)	▲ UBU10003(0.344\355°\0.585)	◇ UBU10005(2.780\355°\0.585)
△ UBU10009(2.780\175°\0.535)	□ UBU10010(2.780\175°\0.825)	■ UBU10012(5.308\355°\0.785)
○ UBU10013(6.317\90°\0.050)	× UBU10014(6.916\90°\0.050)	

Prototype\ Hole 1 (010917-20150101)  
Pore pressure - Kulite



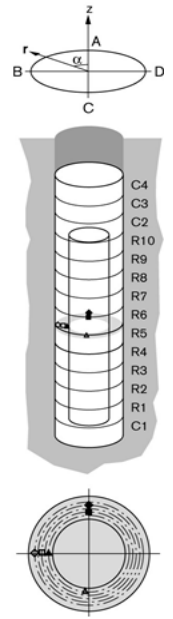
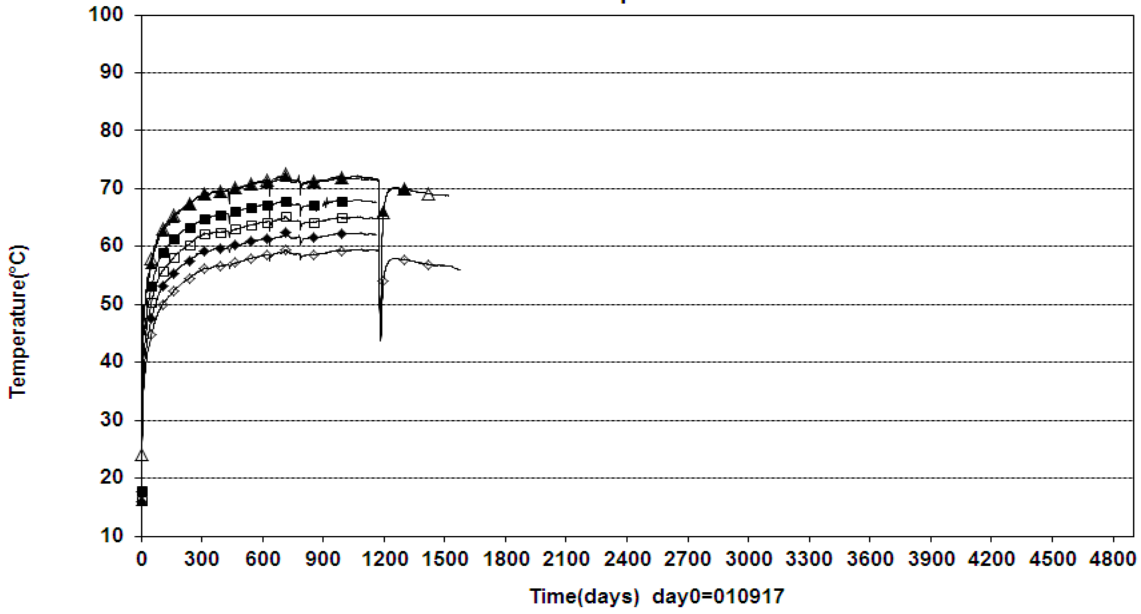
□ UBU10001(0.054\190°\0.050)	▲ UBU10004(0.344\355°\0.785)
○ UBU10006(2.870\355°\0.785)	■ UBU10007(2.870\85°\0.535\In the slot)

Prototype\ Hole 1\Cyl.1 (010917-20150101)  
Temperature - Pentronic



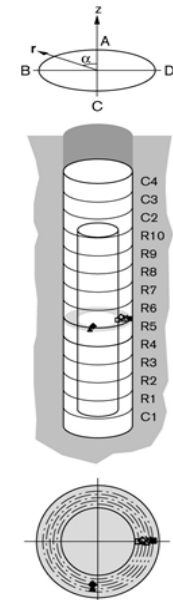
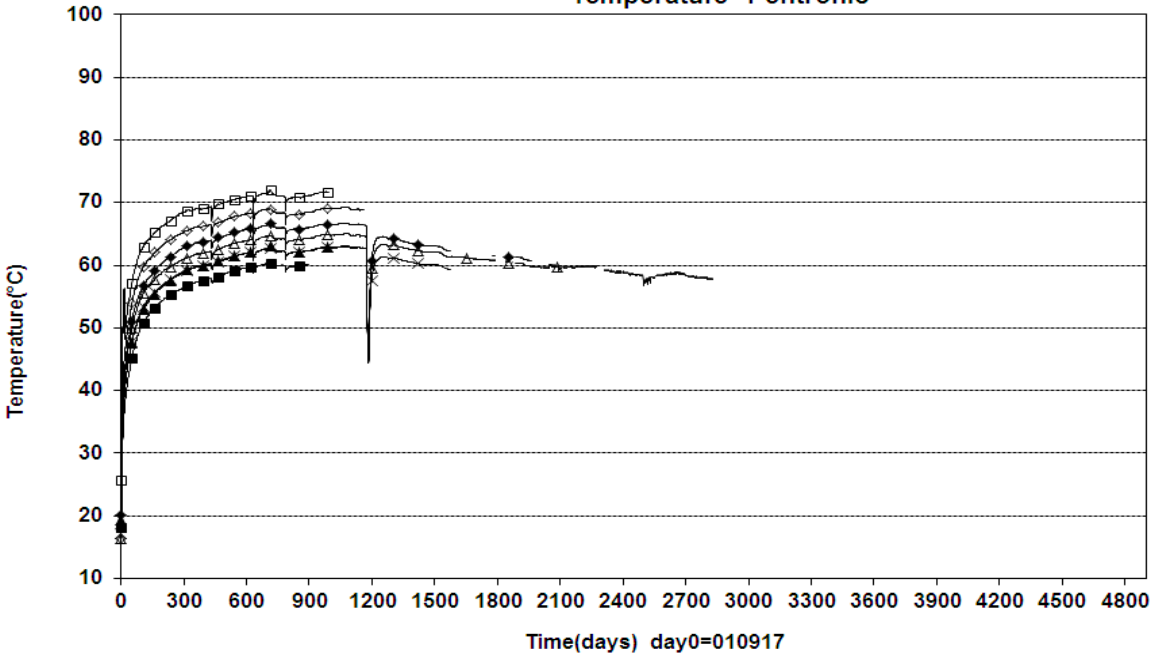
□ TBU10001(0.054\270°\50)	◇ TBU10002(0.254\270°\0.050)	△ TBU10003(0.454\270°\0.050)
× TBU10004(0.454\355°\0.635)	× TBU10005(0.454\355°\0.735)	■ TBU10007(0.454\175°\0.685)

Prototype\Hole 1 \Ring5 (010917-20150101)  
Temperature - Pentronic



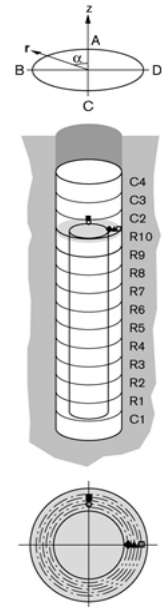
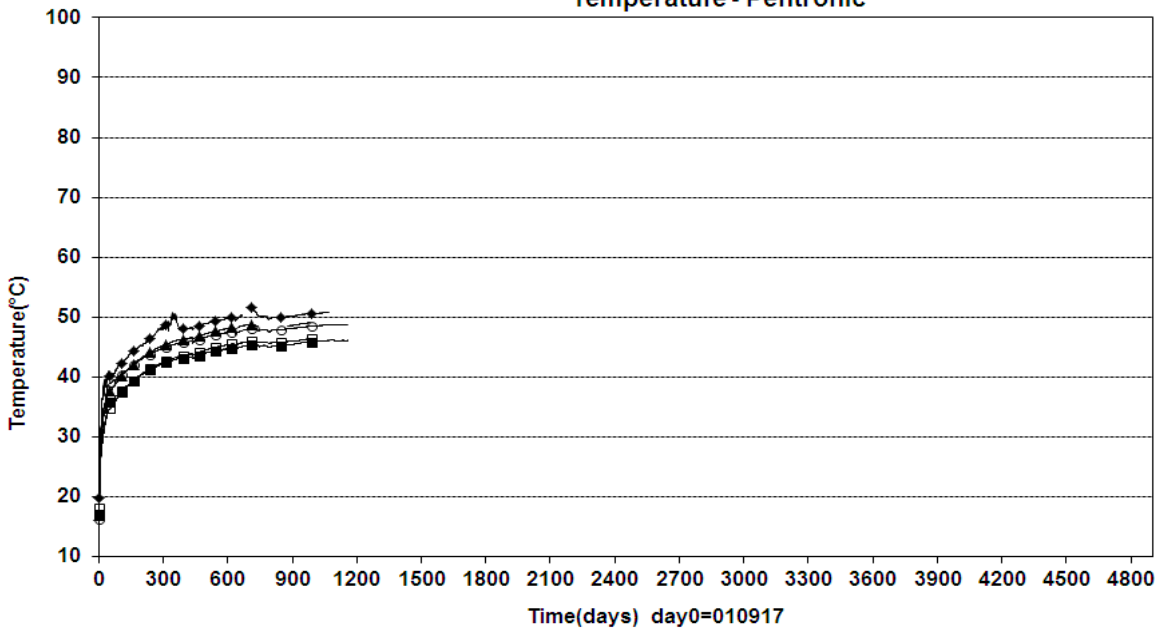
- |                             |                             |                              |
|-----------------------------|-----------------------------|------------------------------|
| ■ TBU10011(2.980\0°\0.635)  | ◆ TBU10012(2.980\0°\0.735)  | ▲ TBU10013(2.980\90°\0.585)  |
| □ TBU10014(2.980\90°\0.685) | ◇ TBU10015(2.980\90°\0.785) | △ TBU10016(2.980\175°\0.585) |

Prototype\Hole 1 \Ring5 (010917-20150101)  
Temperature - Pentronic



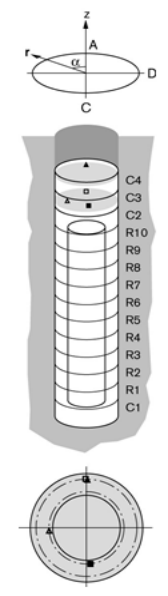
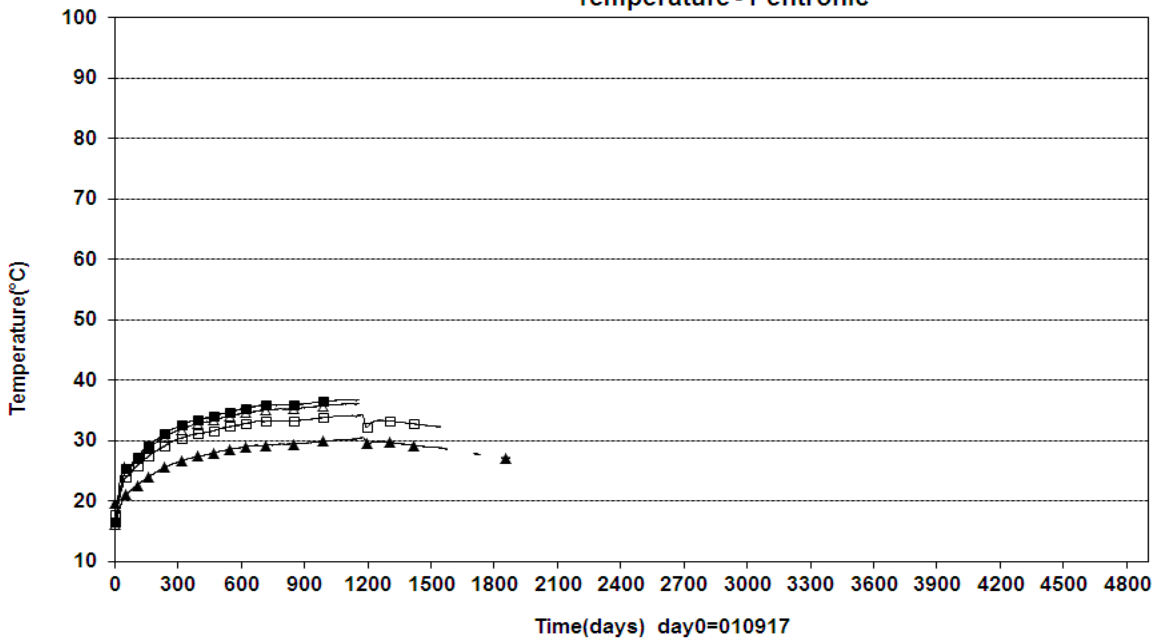
- |                              |                              |                              |
|------------------------------|------------------------------|------------------------------|
| ◆ TBU10017(2.980\175°\0.685) | ▲ TBU10018(2.980\175°\0.735) | □ TBU10019(2.980\270°\0.585) |
| ◇ TBU10020(2.980\270°\0.635) | △ TBU10021(2.980\270°\0.685) | × TBU10022(2.980\270°\0.735) |

Prototype\Hole 1 \Ring10 (010917-20150101)  
Temperature - Pentronic



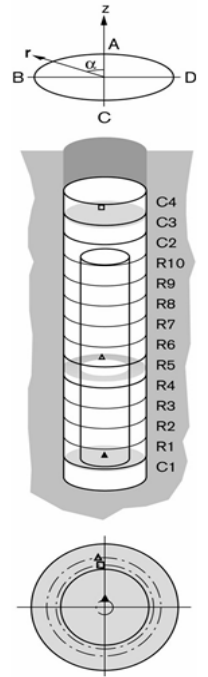
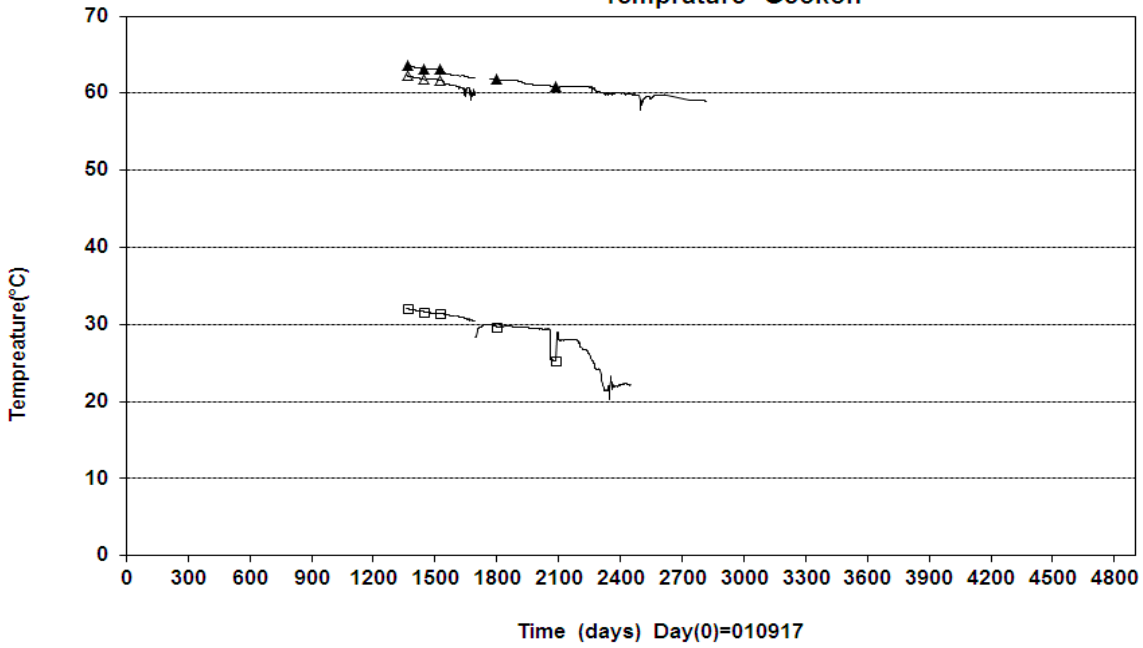
- TBU10024(5.508\0°\0.635)
- TBU10025(5.508\0°\0.735)
- ◆ TBU10026(5.508\270°\585)
- ▲ TBU10027(5.508\270°\0.685)
- TBU10028(5.508\270°\0.785)

Prototype\Hole 1 \Cyl.3 and Cyl.4 (010917-20150101)  
Temperature - Pentronic



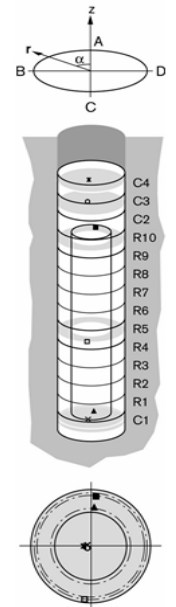
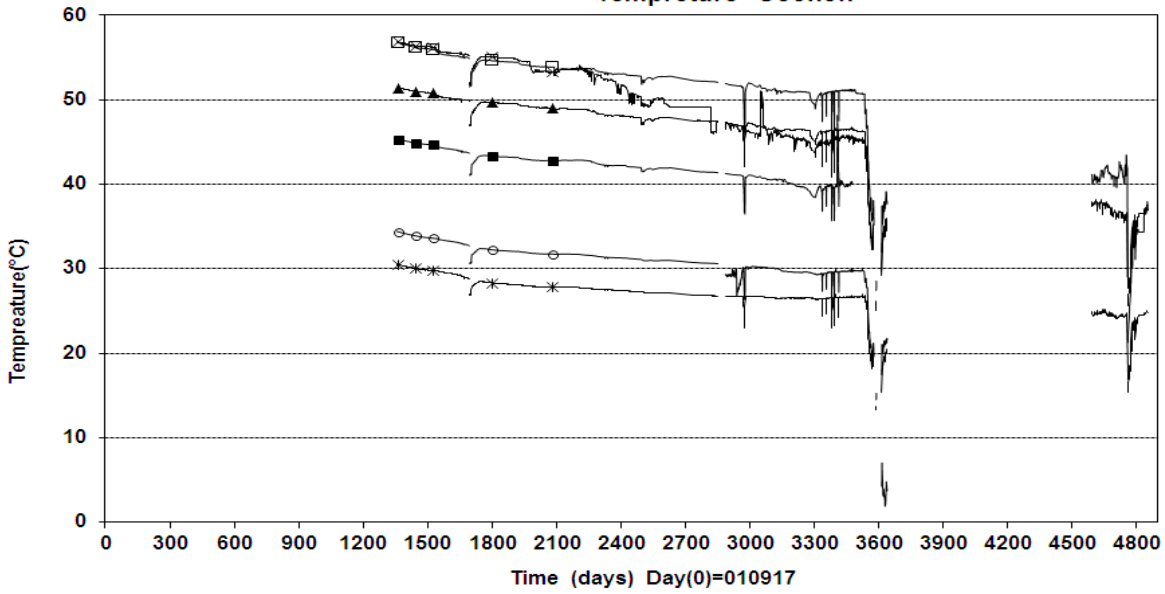
- TBU10029(6.317\0°\0.785)
- TBU10031(6.317\185°\0.585)
- △ TBU10030(6.317\95°\0.585)
- ▲ TBU10032(7.026\0°\0.785)

Prototype\Hole 1\Cyl.1 (20010917-20150101)  
Temprature - Geokon



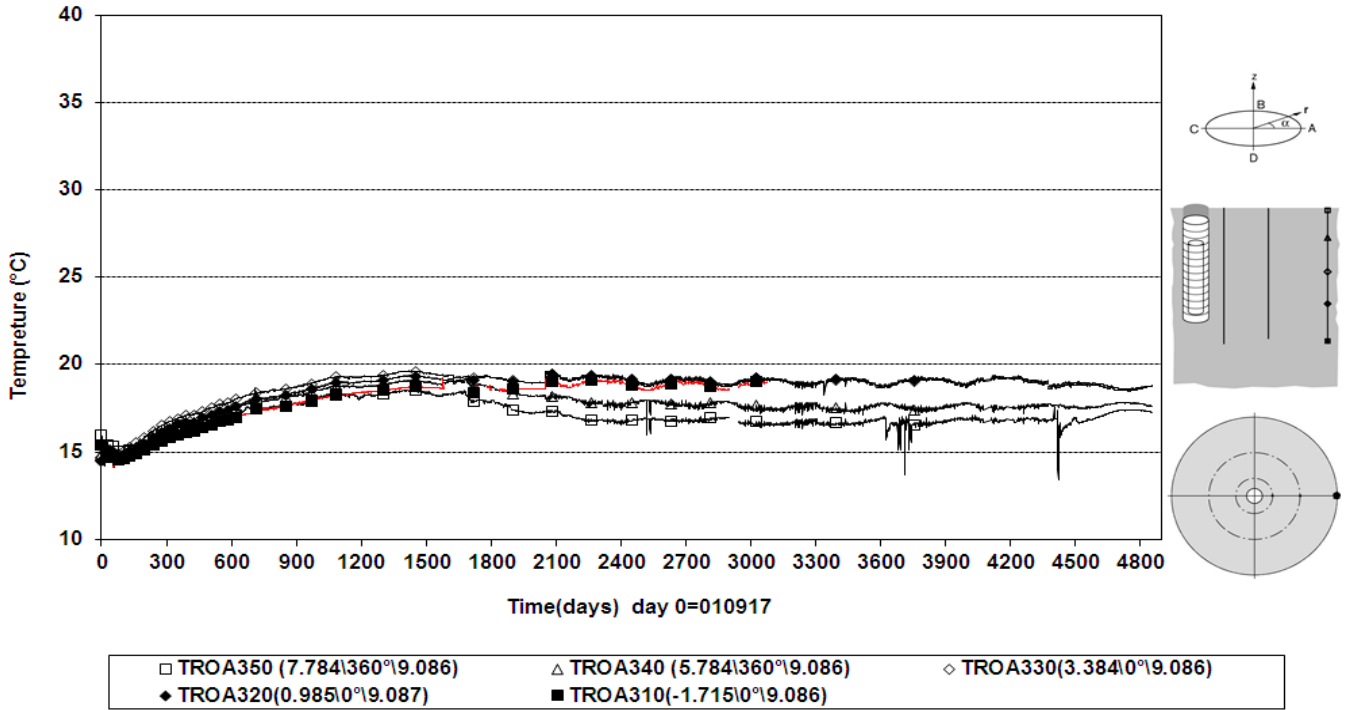
▲ PBU10002(0.504|90°|0.100)    ▲ PBU10011(2.780|5°|0.685)    □ PBU10026(6.567|5°|0.585)

Prototype\Hole 1 (20010917-20150101)  
Temprature - Geokon

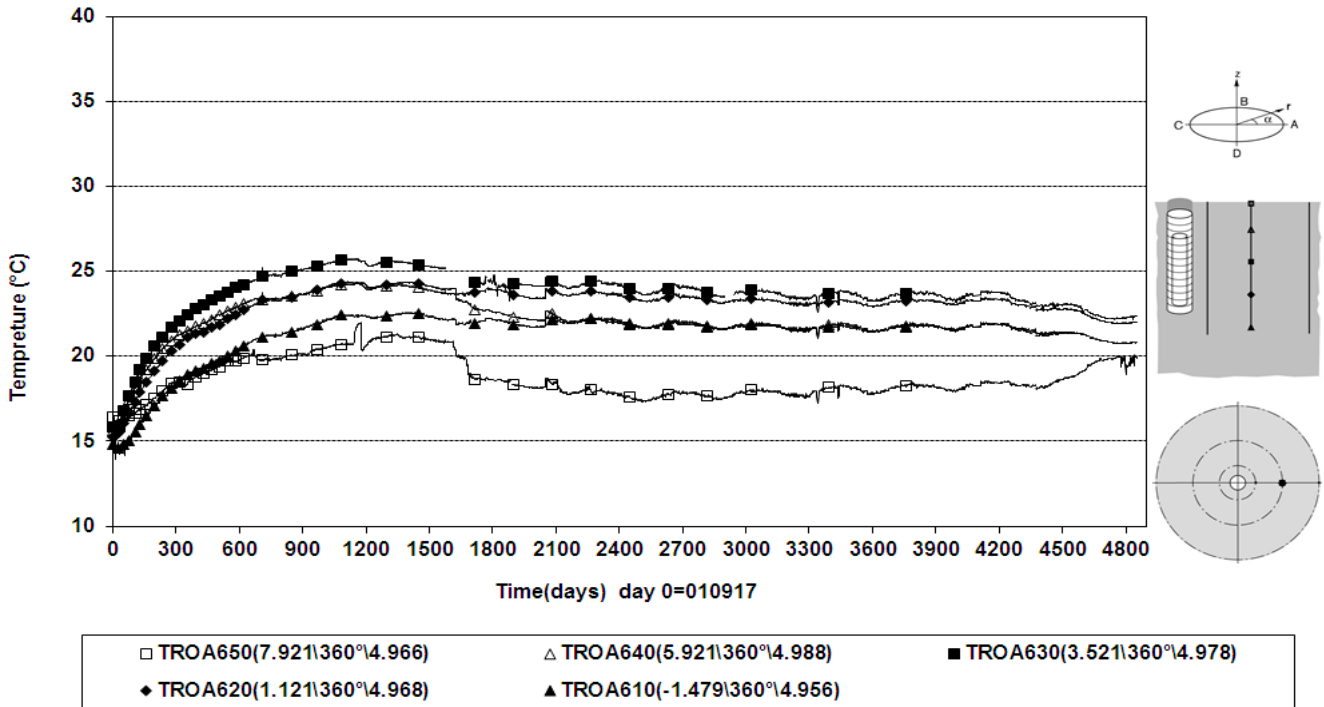


× UBU10002(0.254|90°|0.100)    ▲ UBU10003(0.344|355°|0.585)    □ UBU10010(2.780|175°|0.825)  
■ UBU10012(5.308|355°|0.785)    ○ UBU10013(6.317|90°|0.050)    × UBU10014(6.916|90°|0.050)

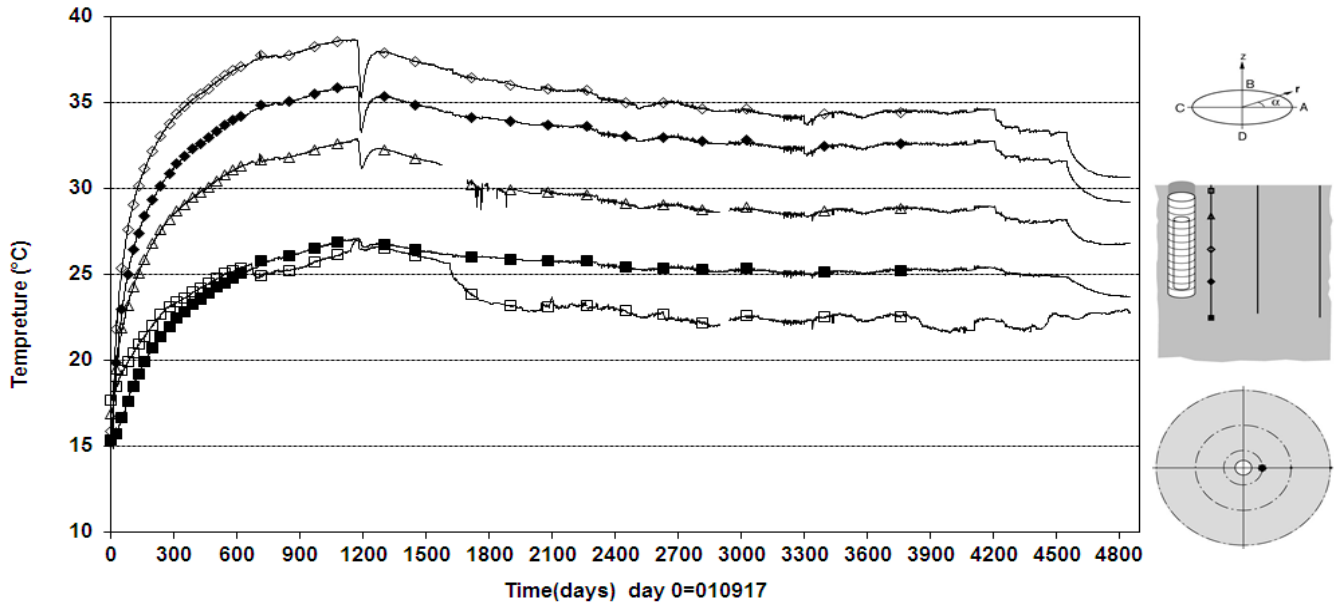
Prototype\Rock\Hole 1 (010917-20150101)  
Temperature - Pentronic



Prototype\Rock\Hole 1 (010917-20150101)  
Temperature - Pentronic

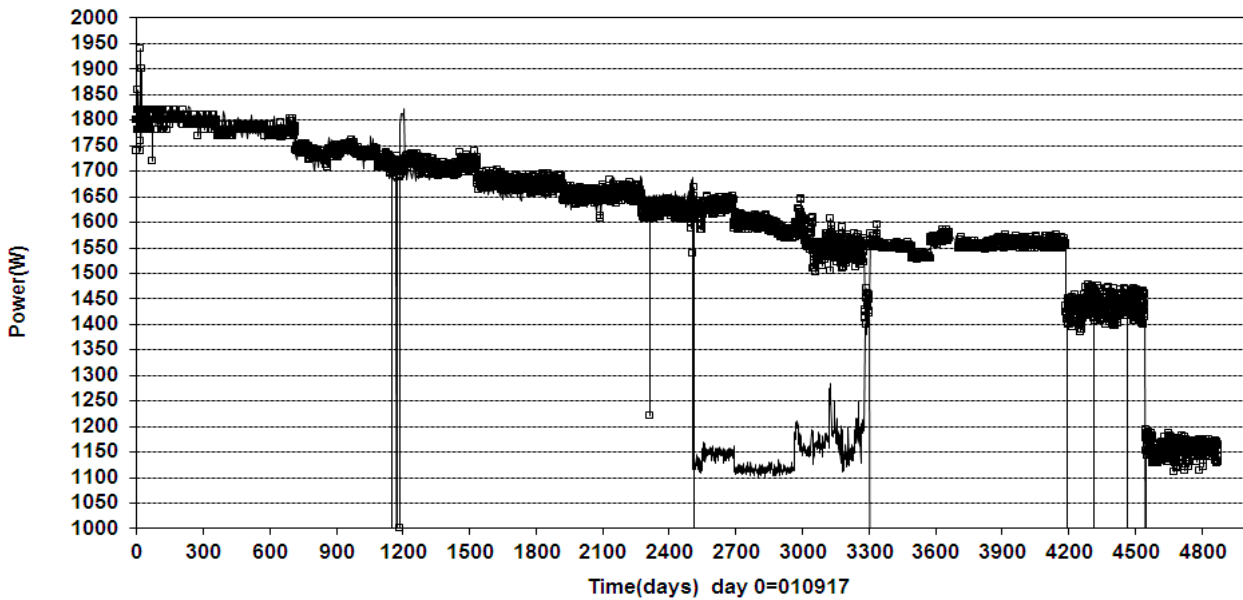


Prototype\Rock\Hole 1 (010917-20150101)  
Temperature - Pentronic



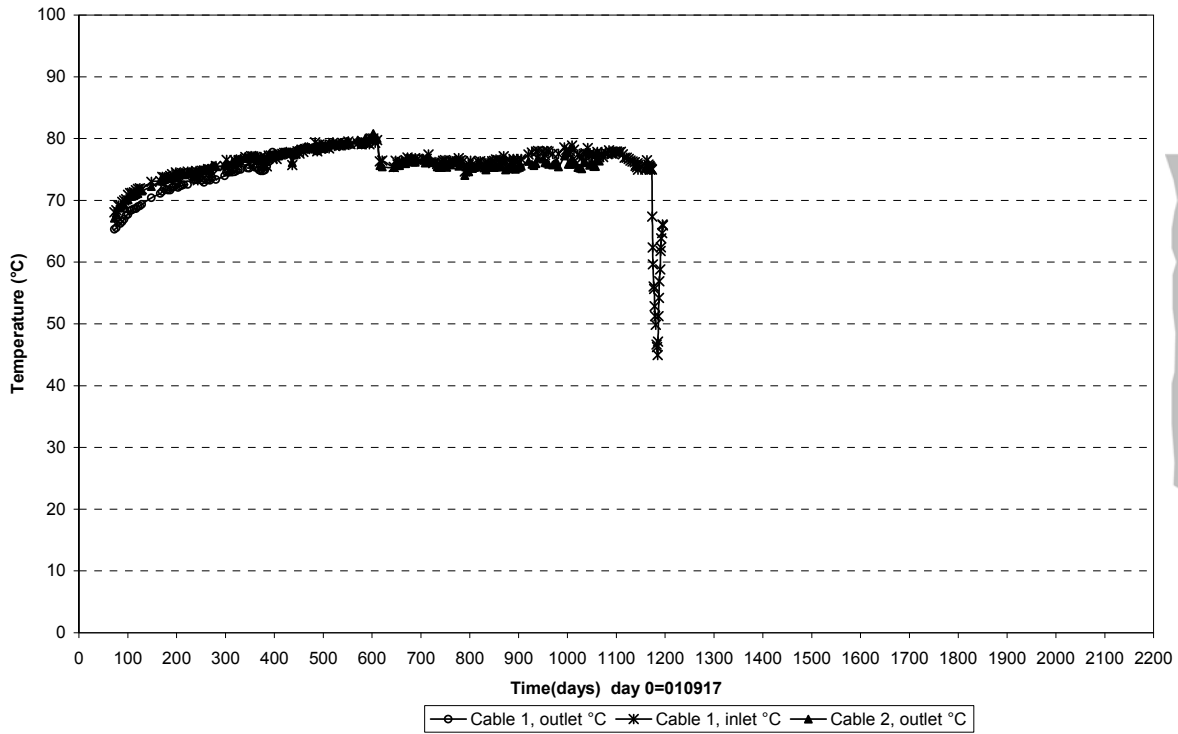
□ TROA1050(7.662\359°\2.020)	△ TROA1040(5.662\359°\2.028)	◇ TROA1030(3.262\359°\2.038)
◆ TROA1020(0.862\359°\2.048)	■ TROA1010(-1.838\359°\2.059)	

Prototype\Hole 1 (20010917-20150101)  
Canister power

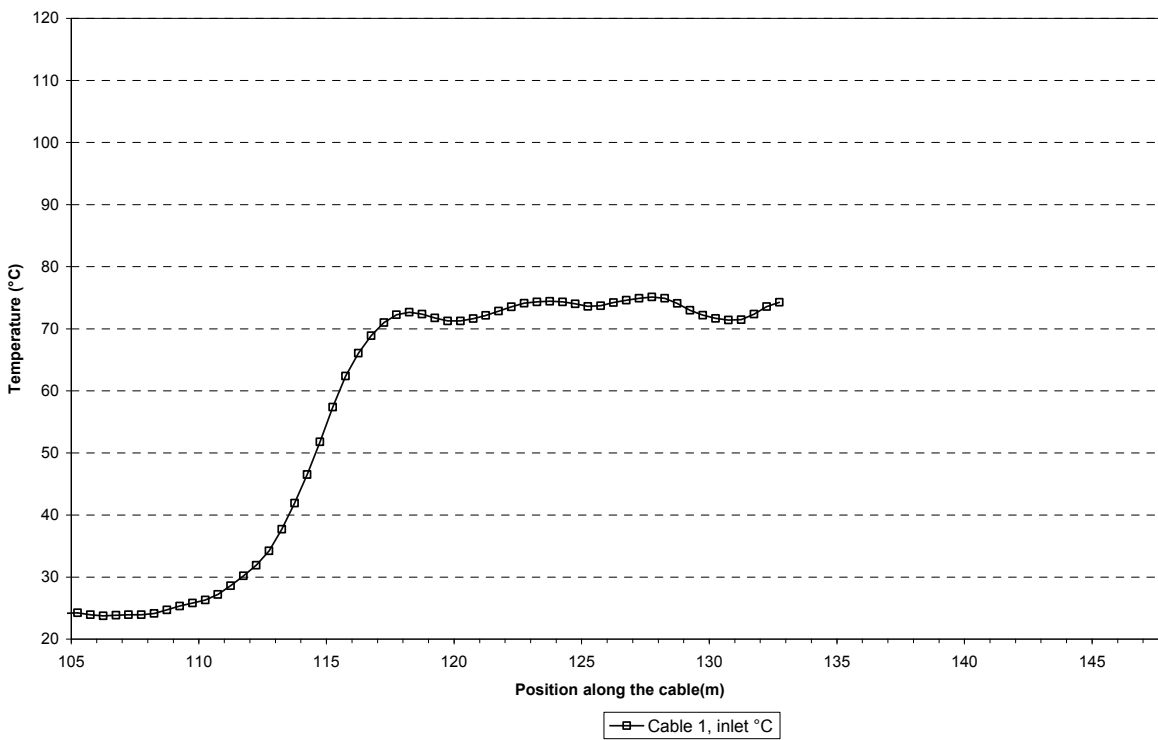


— Measured power (W)	—□— Power-used energy (W)
----------------------	---------------------------

Prototypel Hole 1 \Canister (010917-070601)  
 Max. temperature on the canister surface - Optical fiber cables



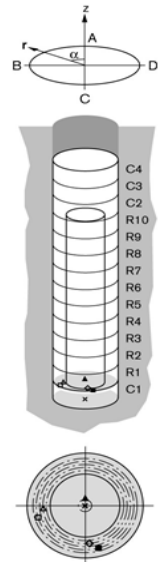
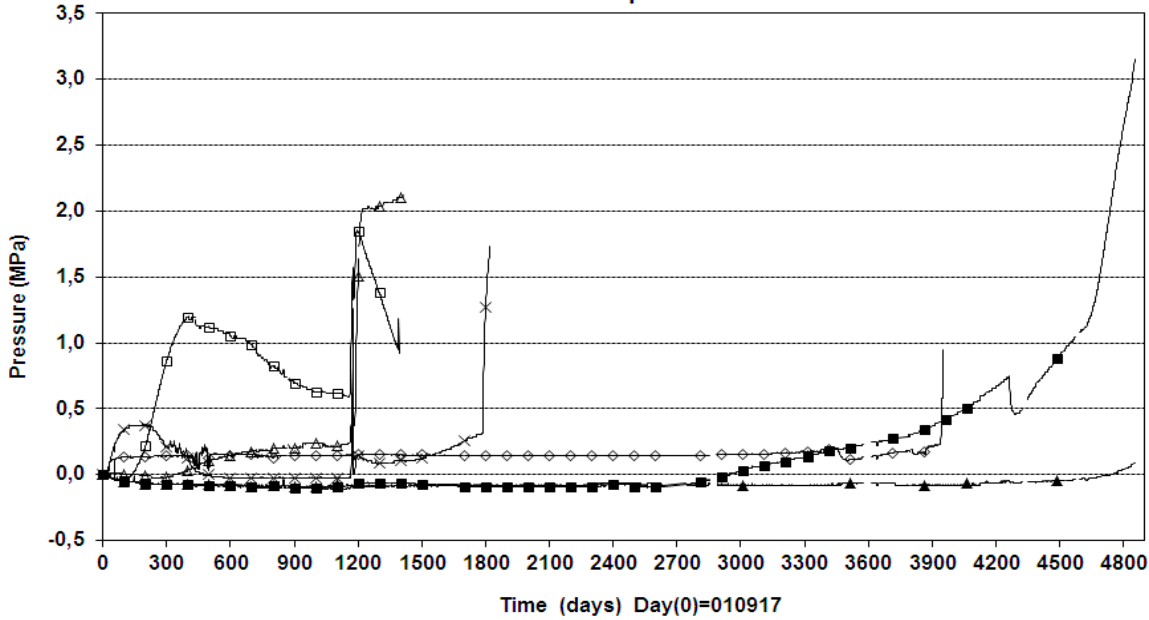
Prototypel Hole 1 \Canister (041201)  
 Temperature profile on the canister surface - Optical fiber cables





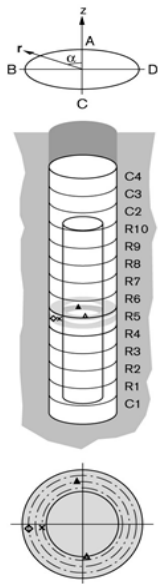
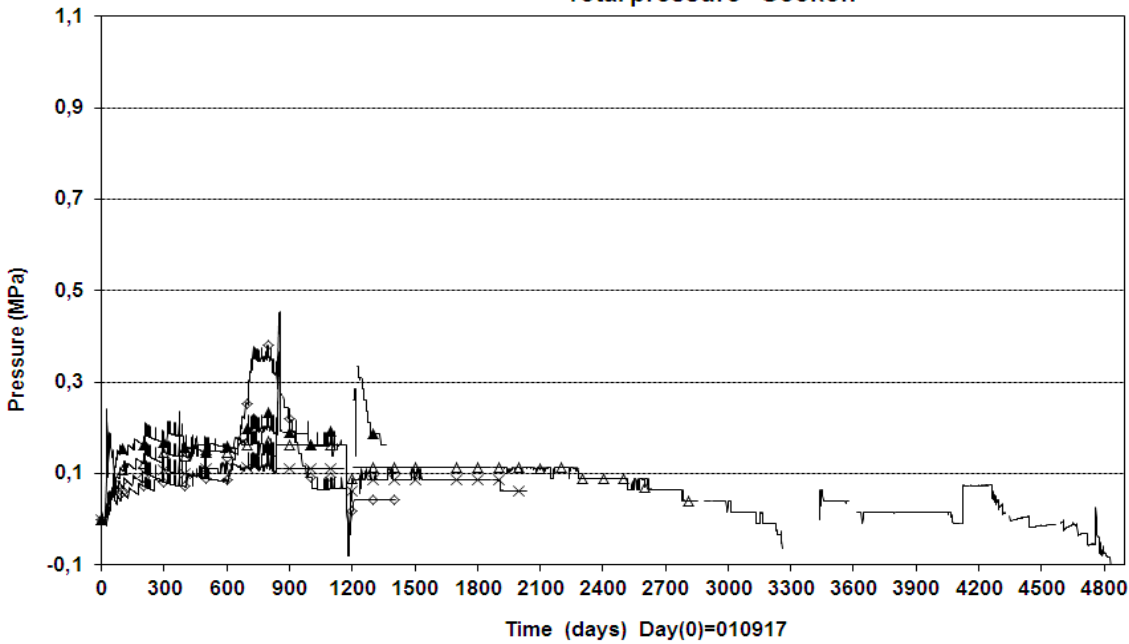
Dep. hole 3

Prototype\Hole 3\Cyl.1 (010917-20150101)  
Total pressure - Geokon



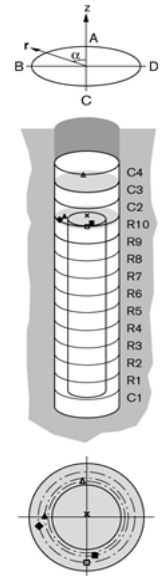
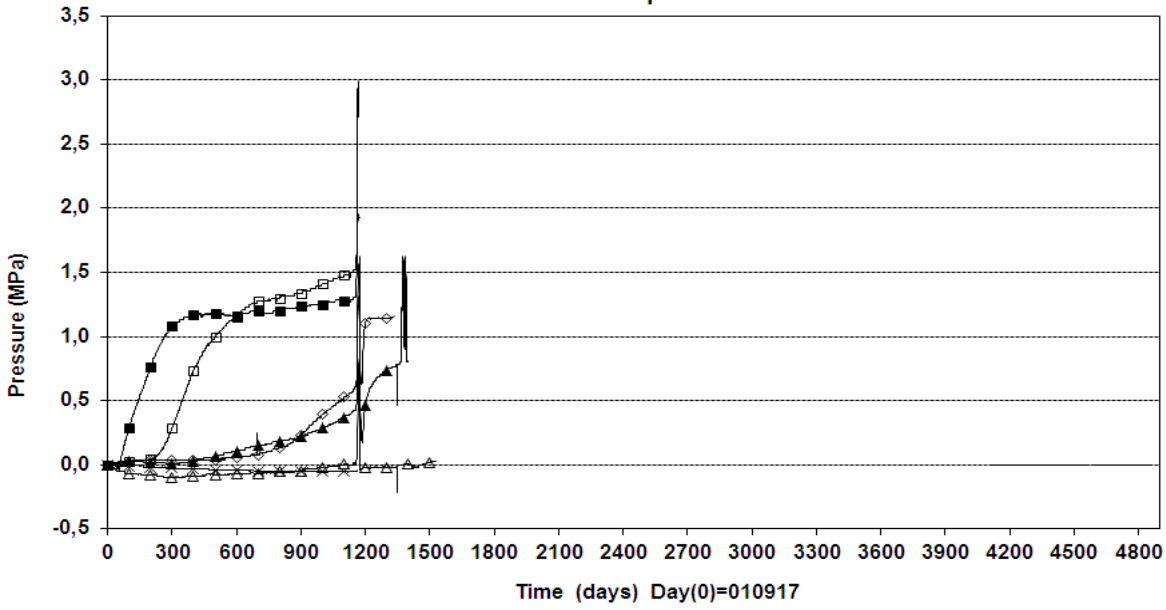
× PBU30001(0 0°\0)	▲ PBU30002(0.495 0°\0.100)	◇ PBU30008(0.495 185°\0.635)
△ PBU30006(0.495 95°\0.635)	□ PBU30007(0.495 105°\0.735)	■ PBU30009(0.495 195°\0.735)

Prototype\Hole 3 \Ring5 (010917-20150101)  
Total pressure - Geokon



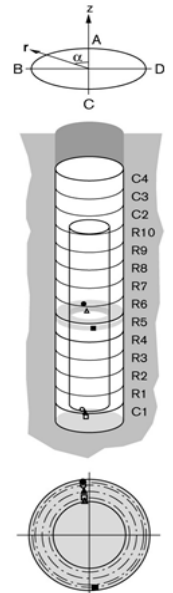
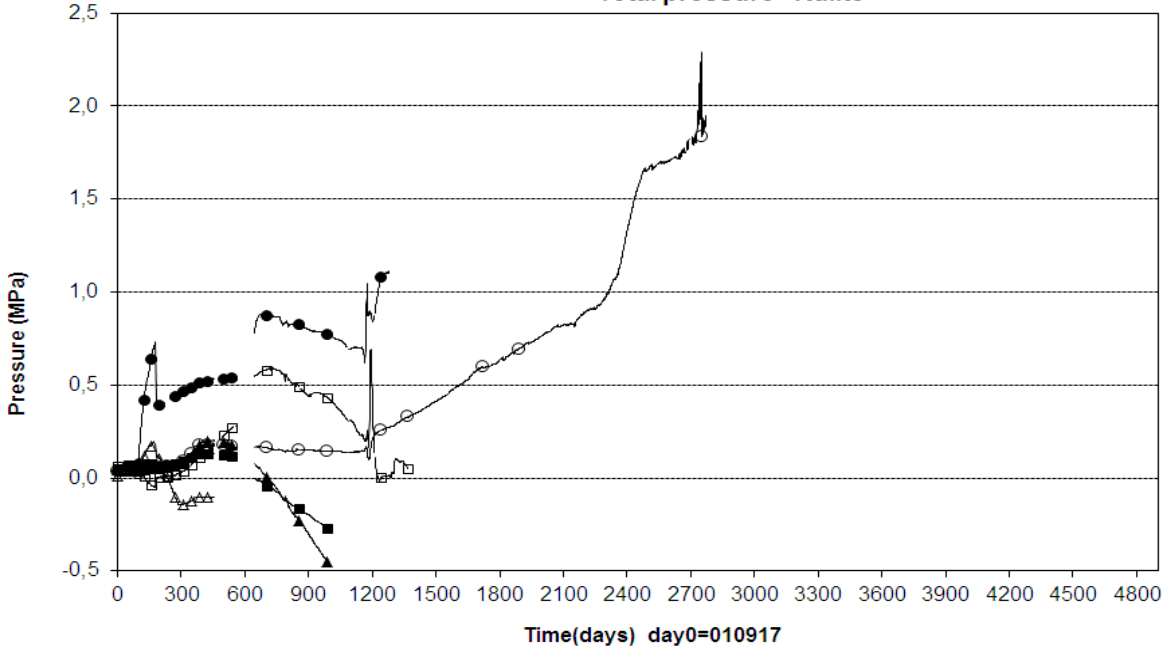
× PBU30013(2.771 95°\0.585)	▲ PBU30011(2.771 5°\0.685)
◇ PBU30014(2.771 95°\0.785)	△ PBU30015(3.021 185°\0.535)

Prototype\Hole 3\Ring10 and Cyl.3 (010917-20150101)  
Total pressure - Geokon



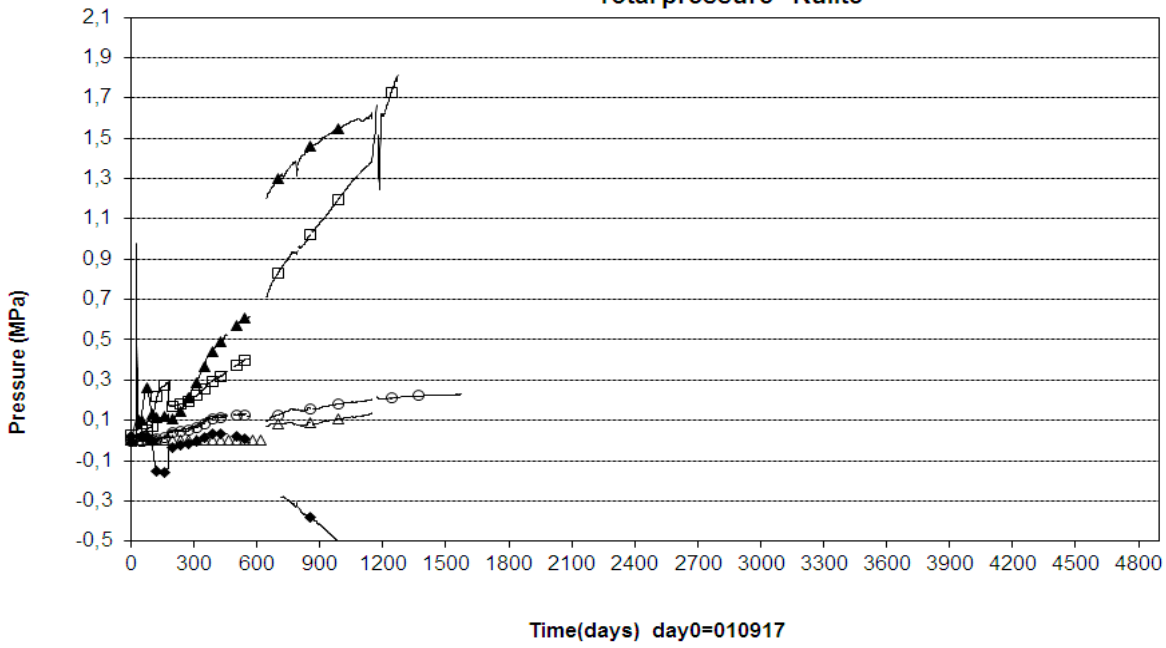
× PBU30017(5.556\10°\0.050)	▲ PBU30021(5.556\90°\0.635)	◇ PBU30022(5.556\100°\0.735)
△ PBU30026(6.654\5°\0.585)	□ PBU30023(5.556\190°\0.735)	■ PBU30024(5.556\190°\0.635)

Prototype\Hole 3 \Cyl.1 and Ring5 (010917-20150101)  
Total pressure - Kulite



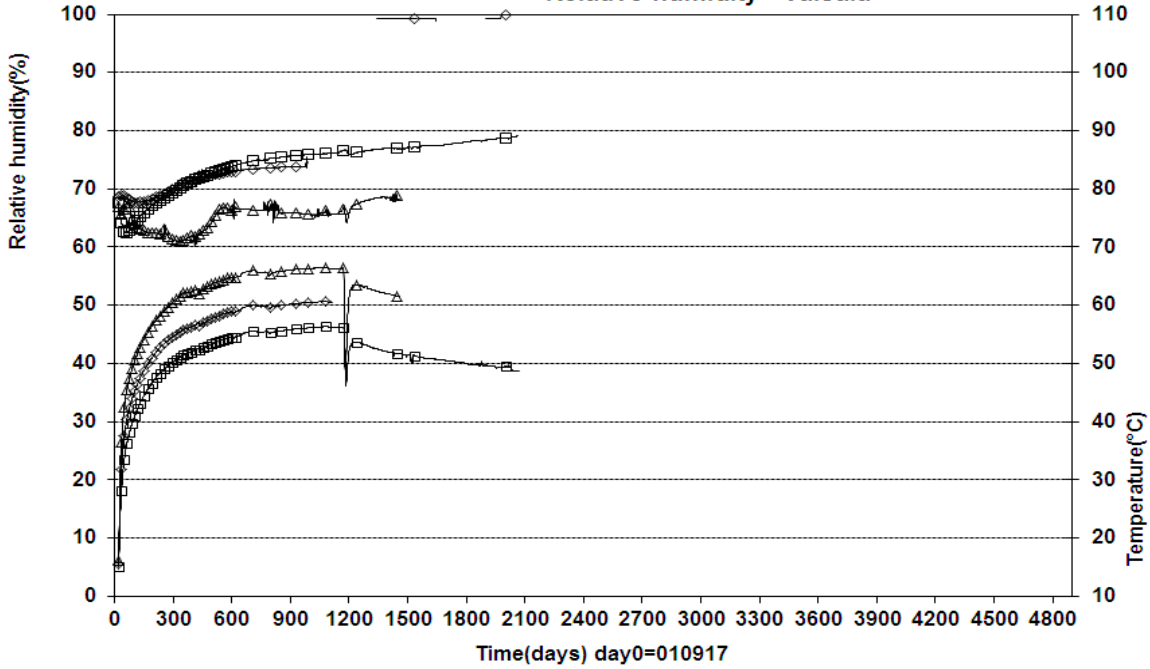
□ PBU30003(Cyl.1\5°\0.585)	▲ PBU30004(Cyl.1\5°\0.685)	○ PBU30005(Cyl.1\5°\0.785)
△ PBU30010(Ring5\5°\0.585)	● PBU30012(Ring5\5°\0.825)	■ PBU30016(Ring5\185°\0.825)

Prototype\Hole 3\Ring10 and Cyl.3-4 (010917-20150101)  
Total pressure - Kulite



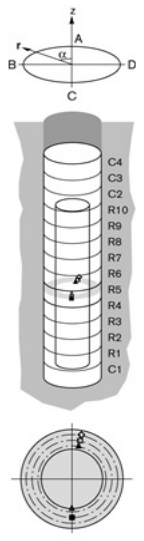
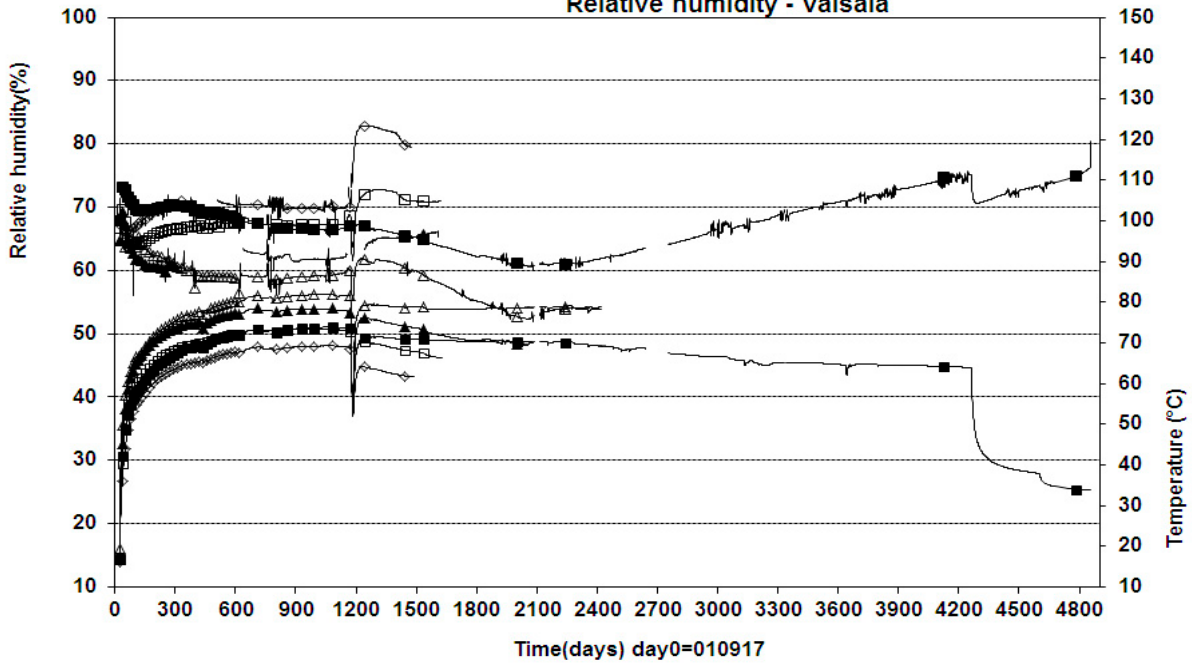
- ◆ PBU30018(Ring10\5°\0.585)
- PBU30019(Ring10\5°\0.685)
- ▲ PBU30020(Ring10\5°\0.785)
- PBU30025(Cyl.3\0°\0.050)
- △ PBU30027(Cyl.4\0°\0.050)

Prototype\Hole 3\Cyl.1 (010917-20150101)  
Relative humidity - Vaisala



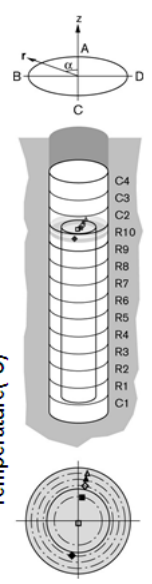
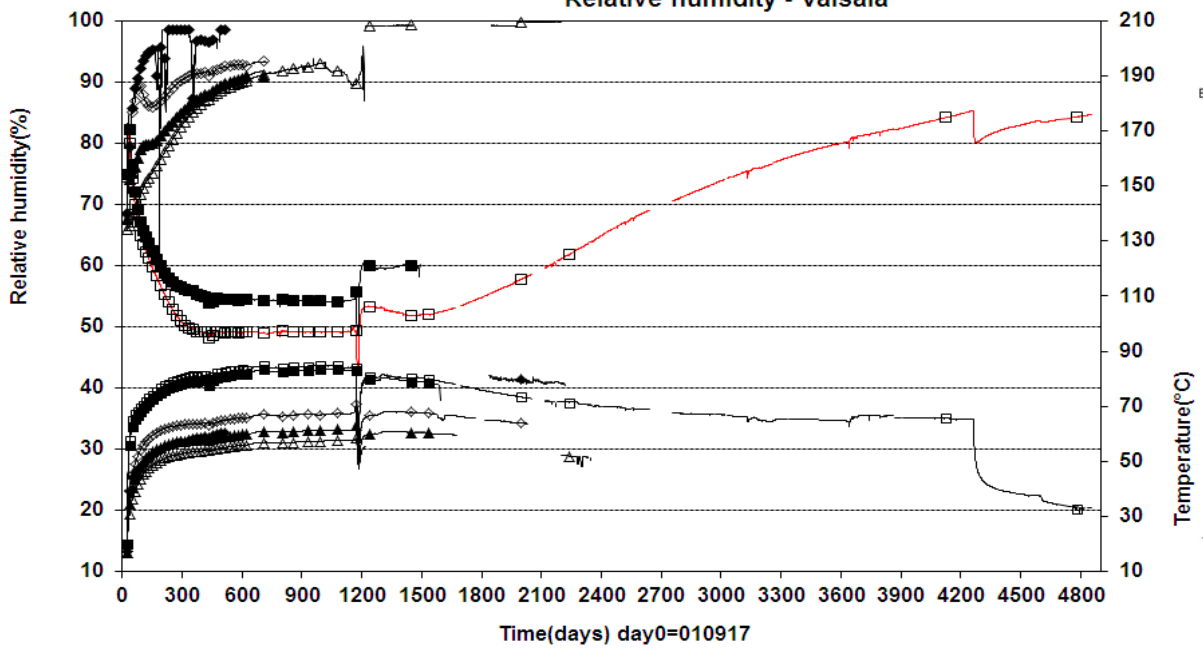
- WBU30004(0.335\350°\0.785)
- ◇ WBU30005(0.335\350°\0.685)
- △ WBU30006(0.335\350°\0.585)

Prototype\Hole 3\Ring 5 (010917-20150101)  
Relative humidity - Vaisala



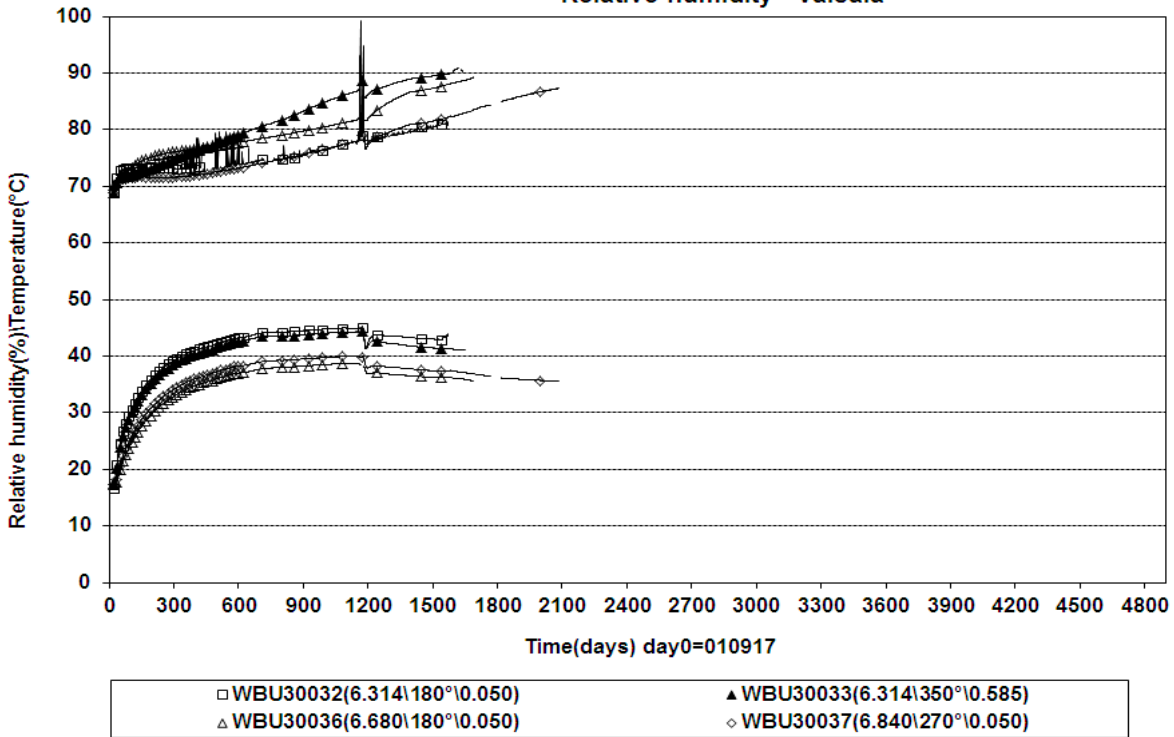
- |                              |  |
|------------------------------|--|
| ▲ WBU30013(2.840\350°\0.585) | □ WBU30014(2.840\350°\0.685)             |
| ◇ WBU30015(2.840\350°\0.785) | △ WBU30019(2.840\180°\0.535\In the slot) |

Prototype\Hole 3\Ring 10 (010917-20150101)  
Relative humidity - Vaisala

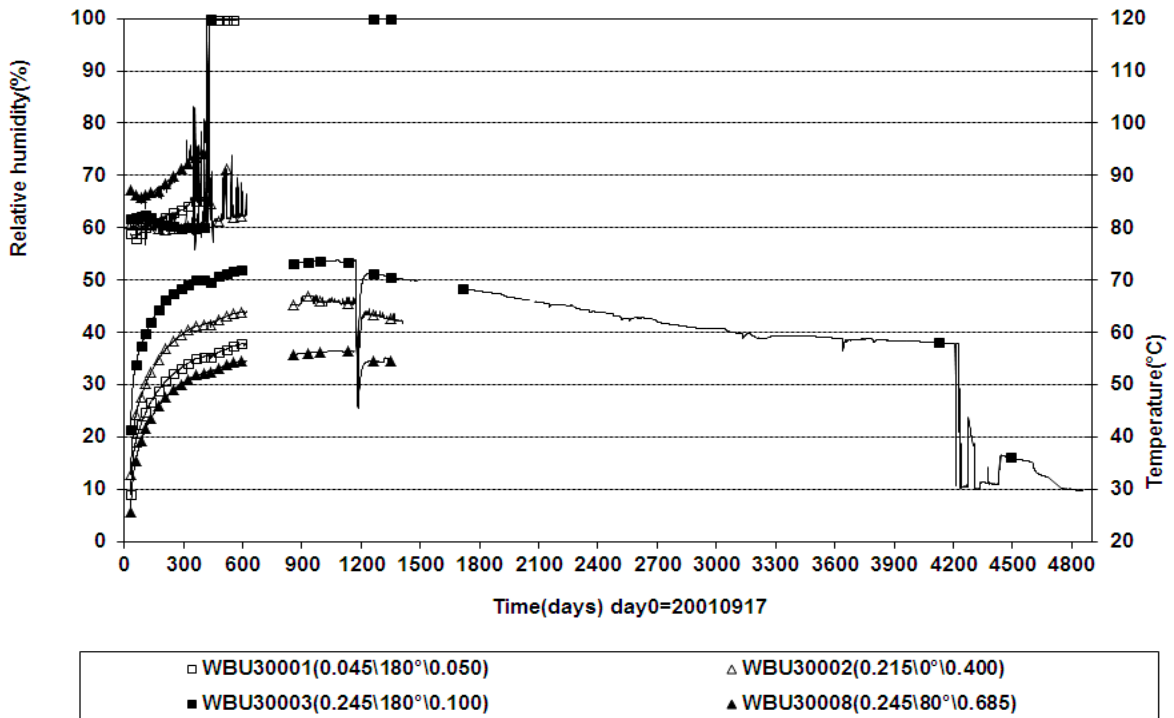


- |                              |                              |                              |
|------------------------------|------------------------------|------------------------------|
| □ WBU30022(5.416\180°\0.050) | ■ WBU30023(5.396\352°\0.262) | ◇ WBU30024(5.396\350°\0.585) |
| △ WBU30025(5.396\350°\0.785) | ▲ WBU30026(5.396\350°\0.685) | ◆ WBU30030(5.396\170°\0.585) |

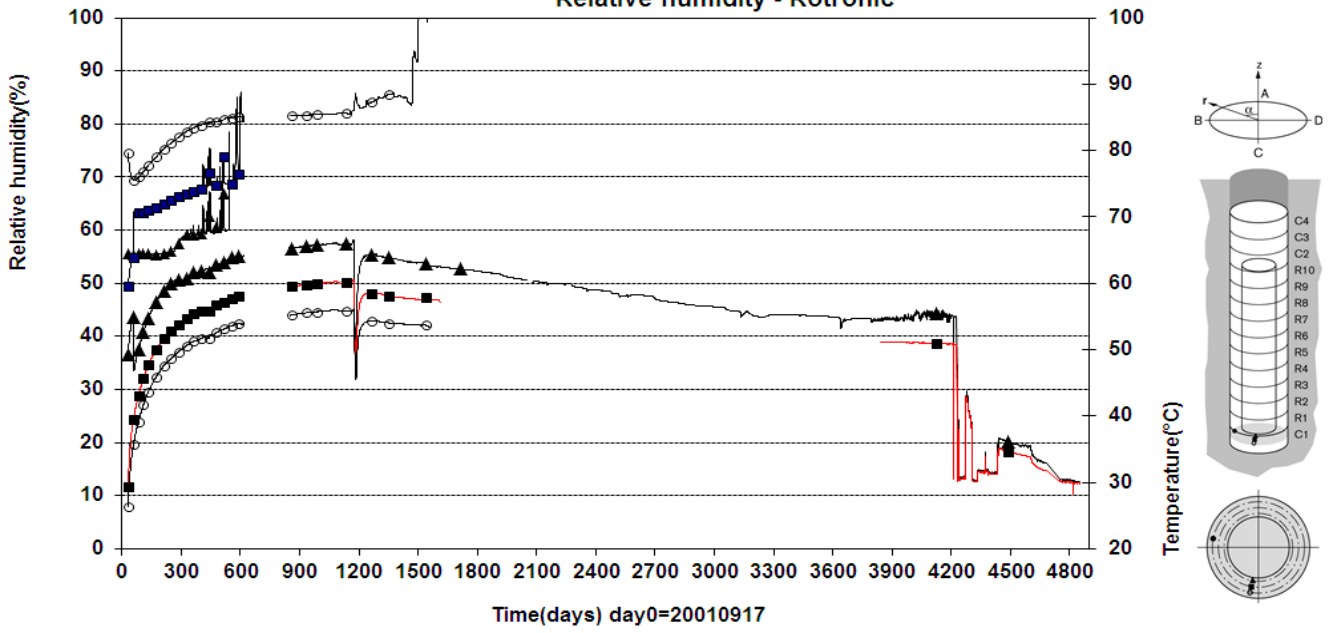
Prototype\Hole 3\Cyl.3 and Cyl.4 (010917-20150101)  
Relative humidity - Vaisala



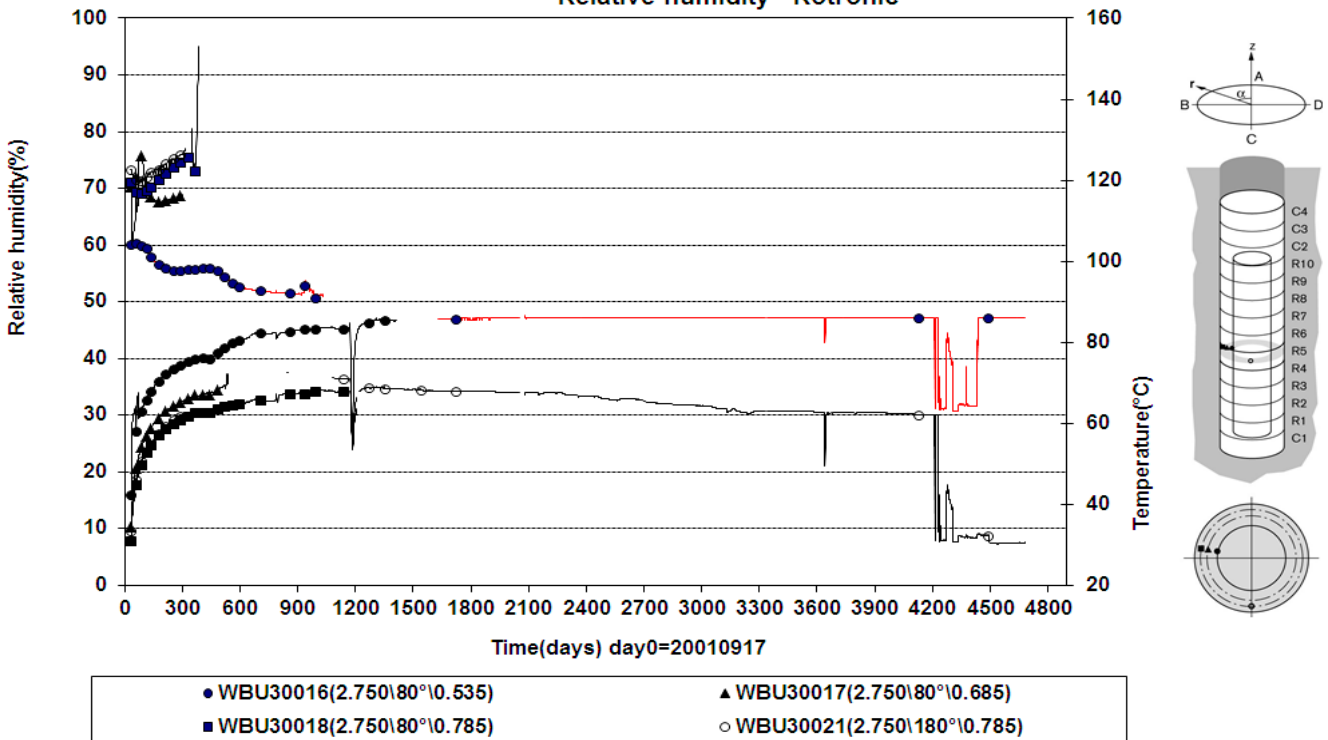
Prototype\Hole 3\Cyl.1 (20010917-20150101)  
Relative humidity - Rotronic



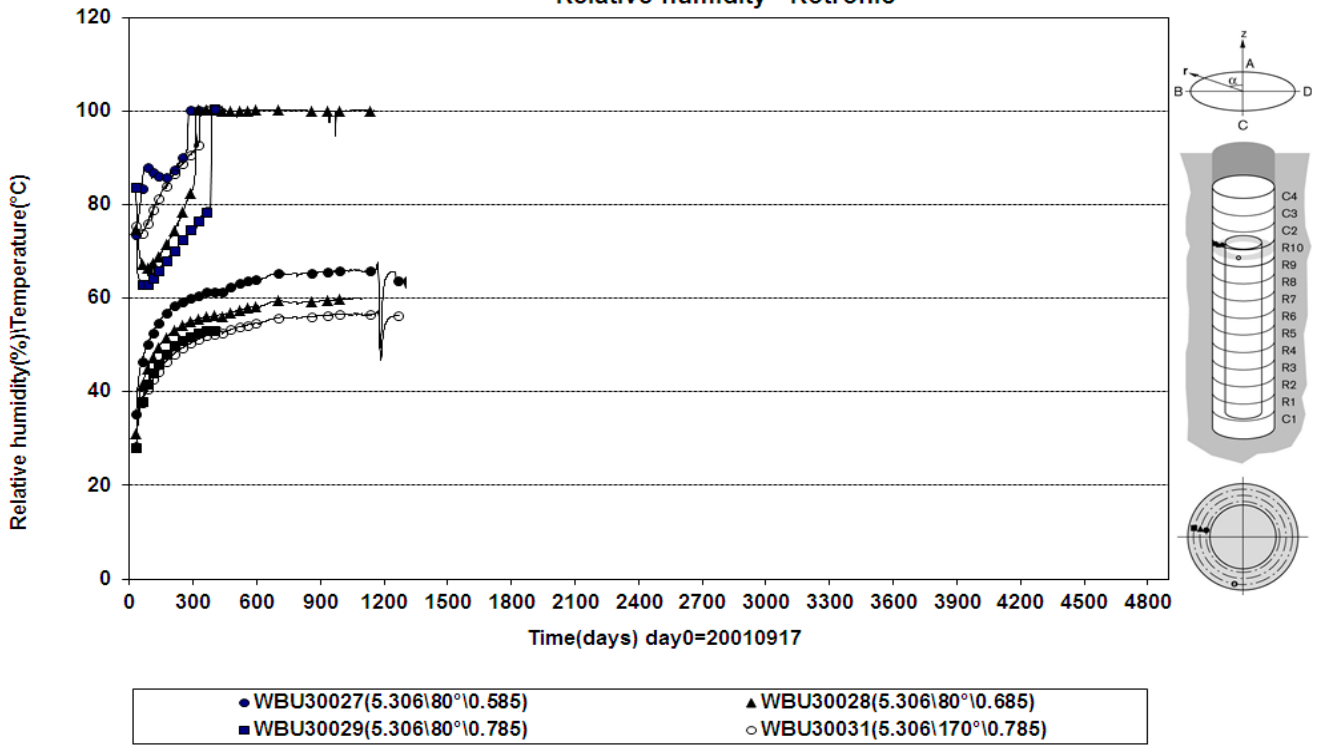
Prototype\Hole 3\Cyl.1 (20010917-20150101)  
Relative humidity - Rotronic



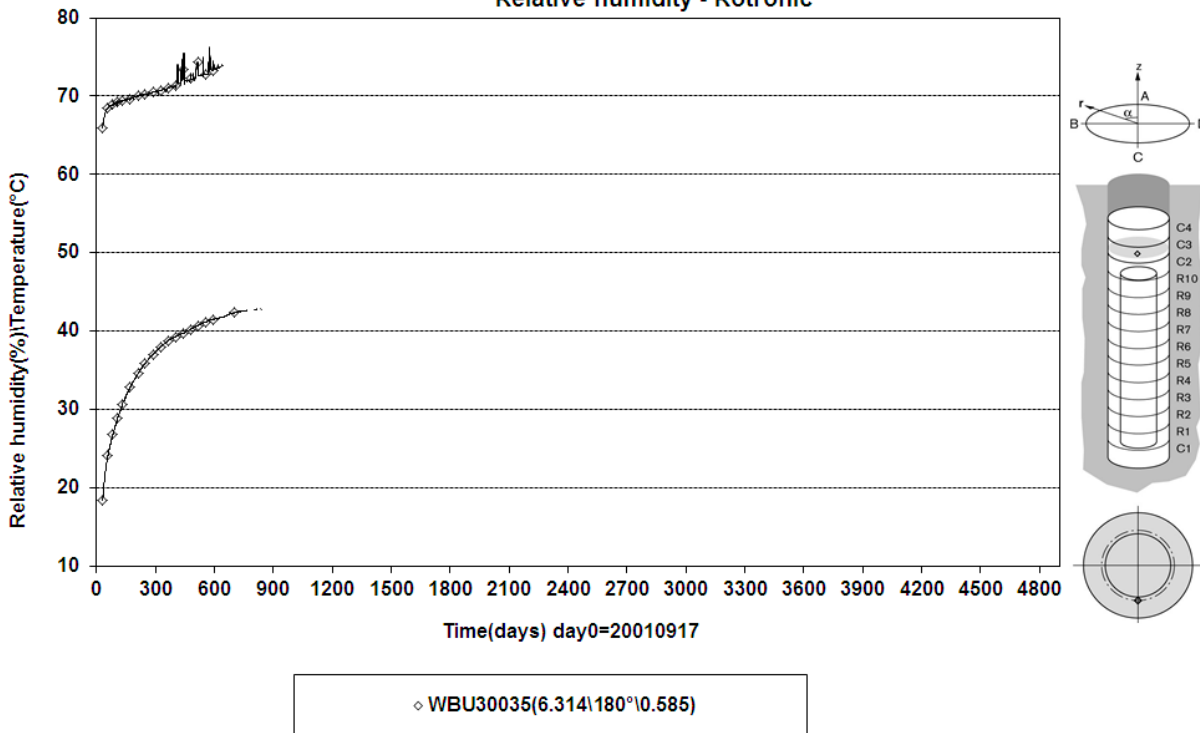
Prototype\Hole 3\Ring 5 (20010917-20150101)  
Relative humidity - Rotronic



Prototype\Hole 3\Ring 10 (20010917-20150101)  
Relative humidity - Rotronic

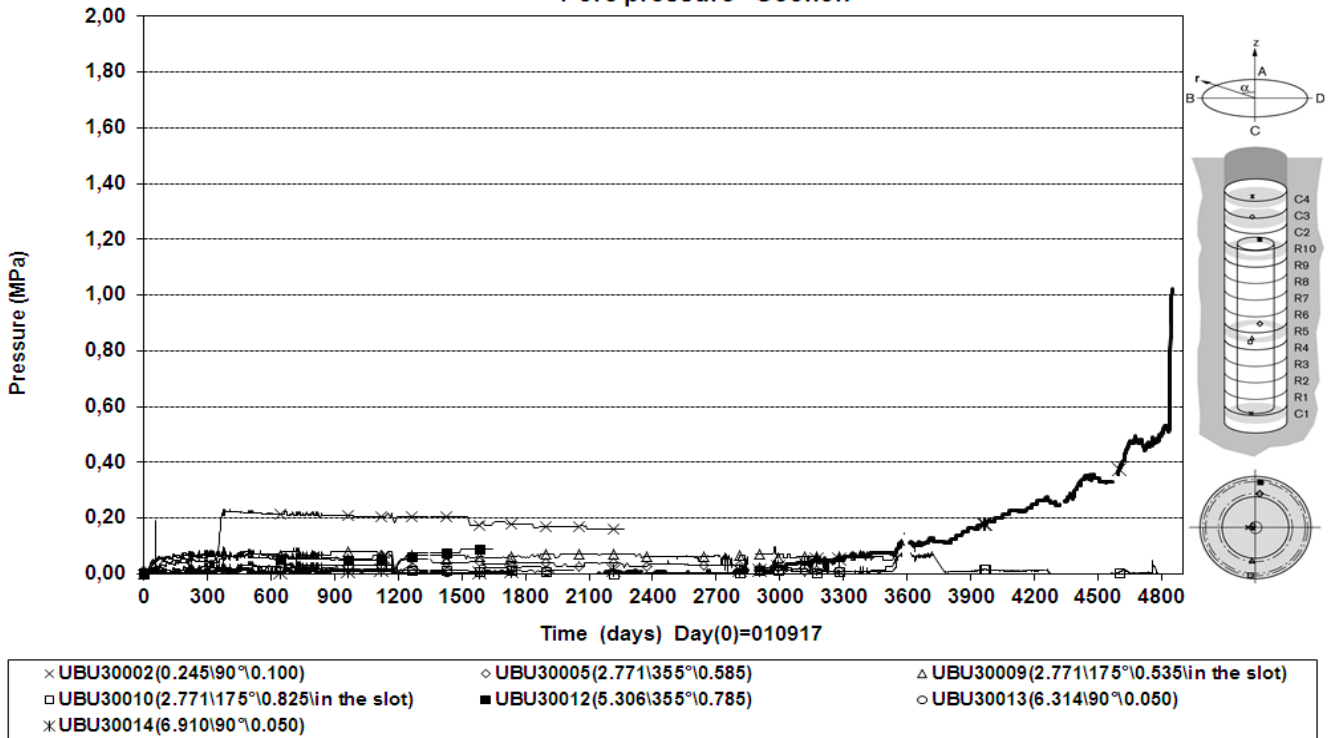


Prototype\Hole 3\Cyl.3 (20010917-20150101)  
Relative humidity - Rotronic

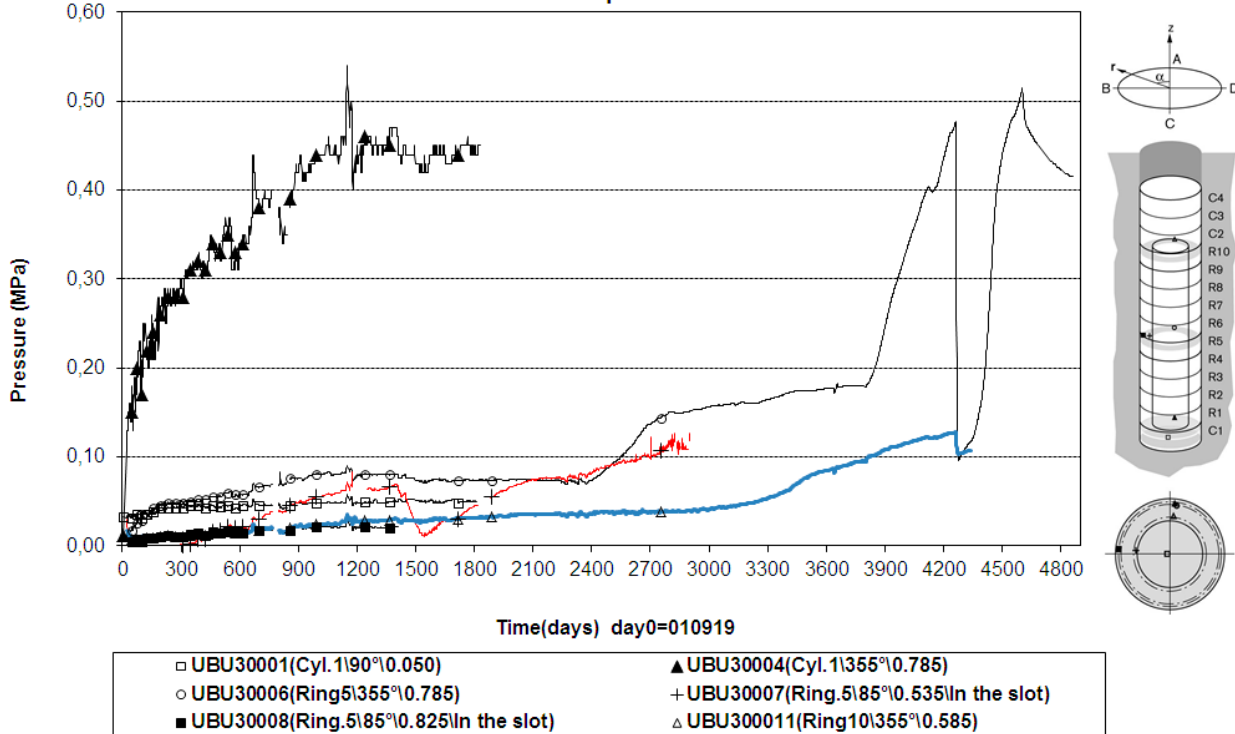




Prototype\Hole 3 (010917-20150101)  
Pore pressure - Geokon

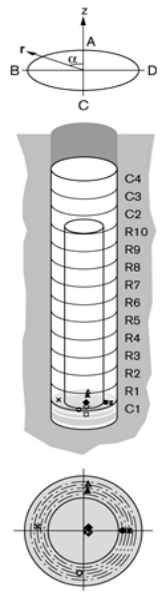
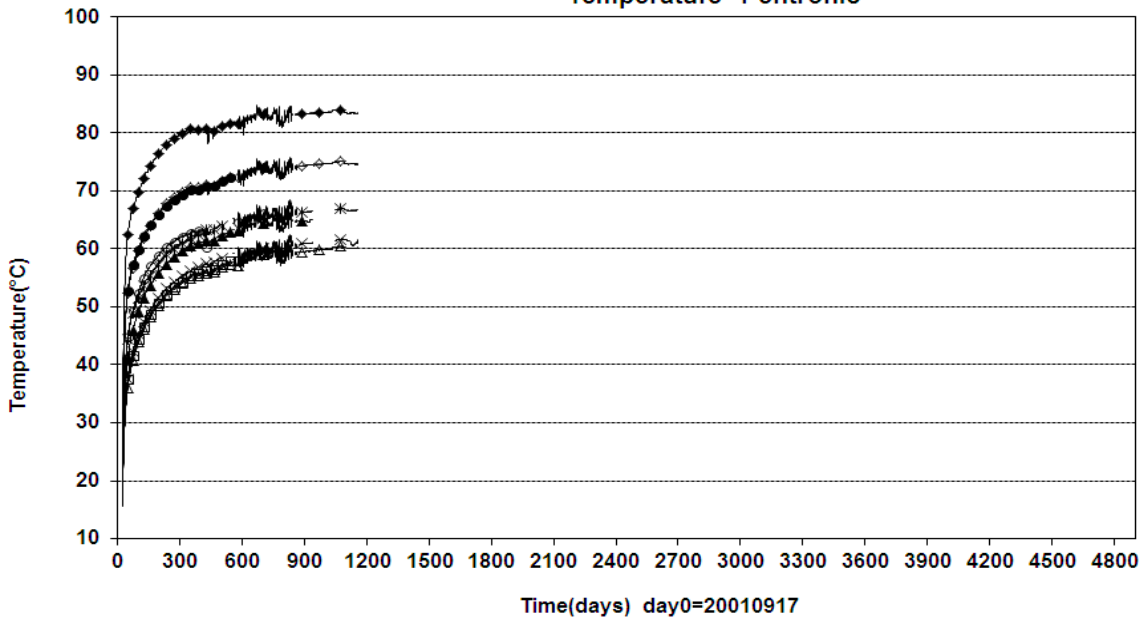


Prototype\Hole 3 (010917-20150101)  
Pore pressure - Kulite



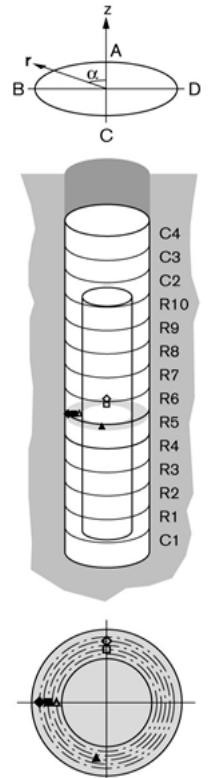
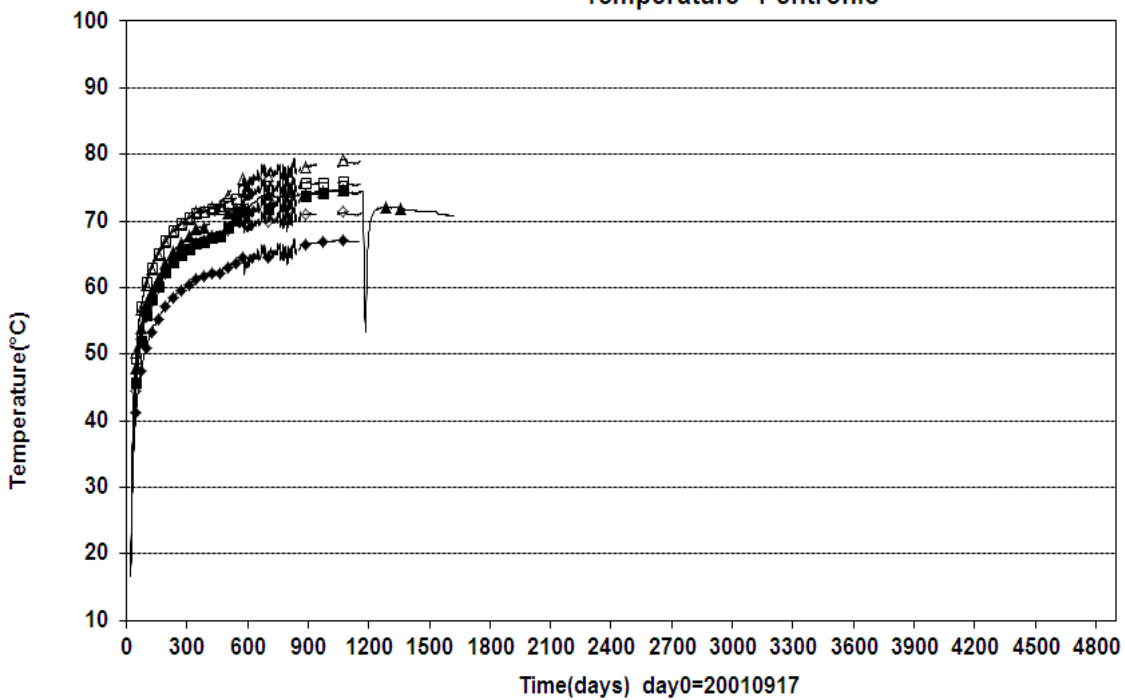


PrototypeHole 3\Cyl.1 (20010917-20150101)  
Temperature - Pentronic



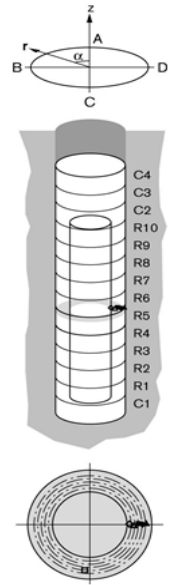
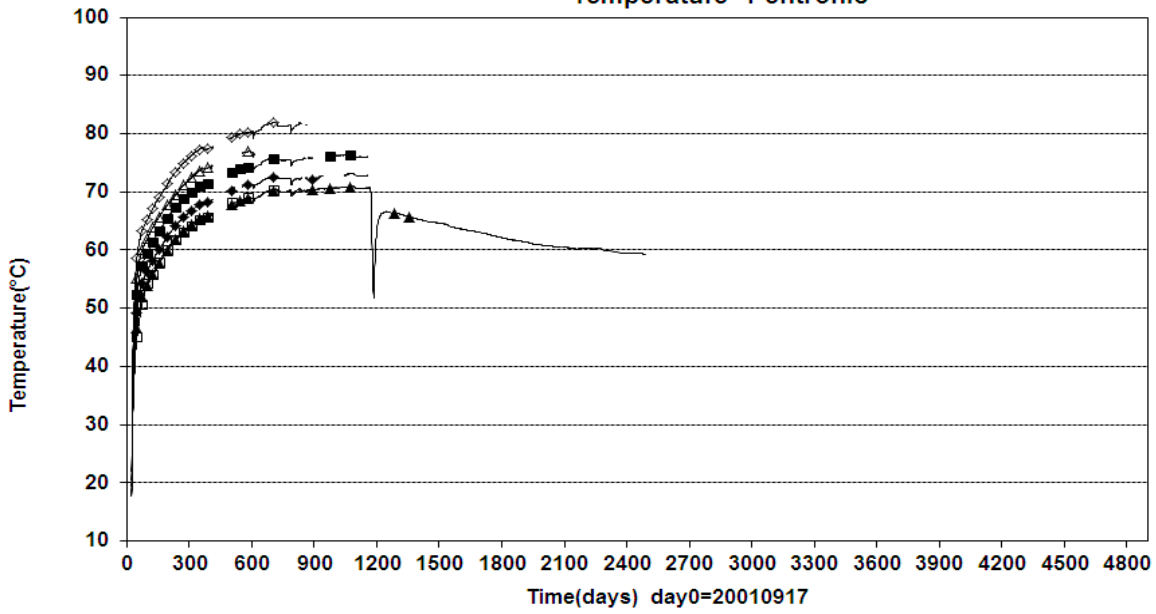
□ TBU30001(0.095\270°\0.050)	◇ TBU30002(0.295\270°\0.050)	◆ TBU30003(0.445\270°\0.050)
▲ TBU30004(Cyl.1\355°\0.635)	△ TBU30005(Cyl.1\355°\0.735)	× TBU30006(Cyl.1\85°\0.685)
○ TBU30007(Cyl.1\175°\0.685)	● TBU30008(Cyl.1\270°\0.585)	* TBU30009(Cyl.1\270°\0.685)

PrototypeHole 3\Ring5 (20010917-20150101)  
Temperature - Pentronic



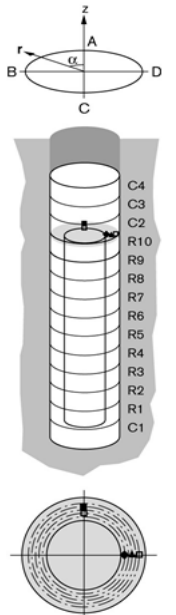
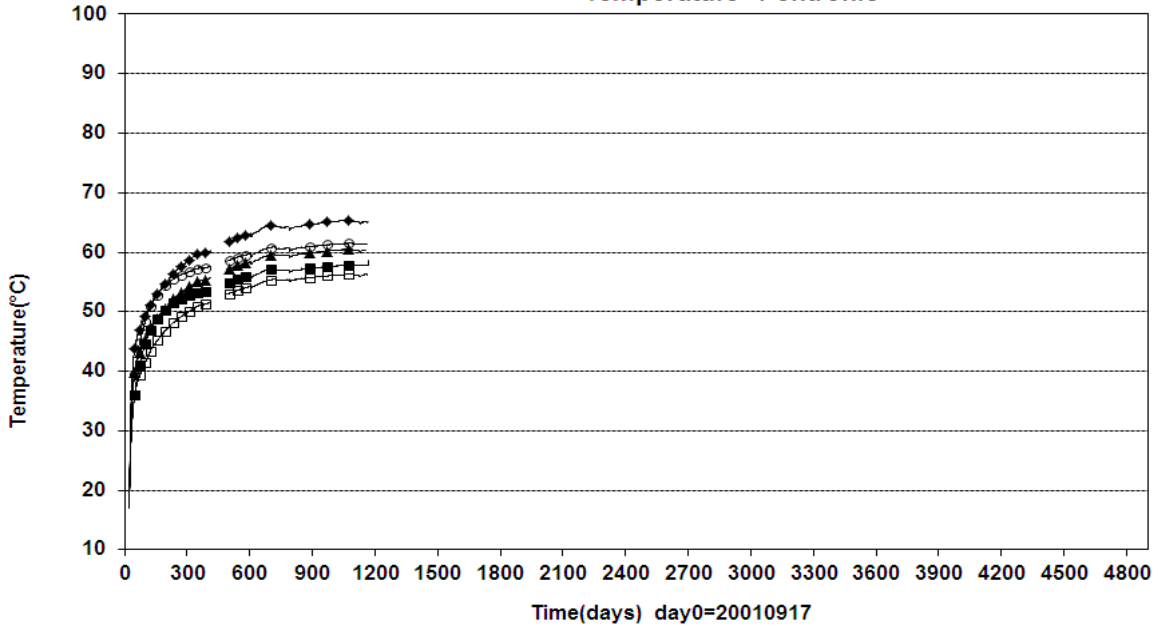
□ TBU30011(2.971\0°\0.635)	◇ TBU30012(2.971\0°\0.735)	△ TBU30013(2.971\90°\0.585)
■ TBU30014(2.971\90°\0.685)	◆ TBU30015(2.971\90°\0.785)	▲ TBU30017(2.971\175°\0.685)

Prototype\Hole 3\Ring5 (010917-20150101)  
Temperature - Pentronic



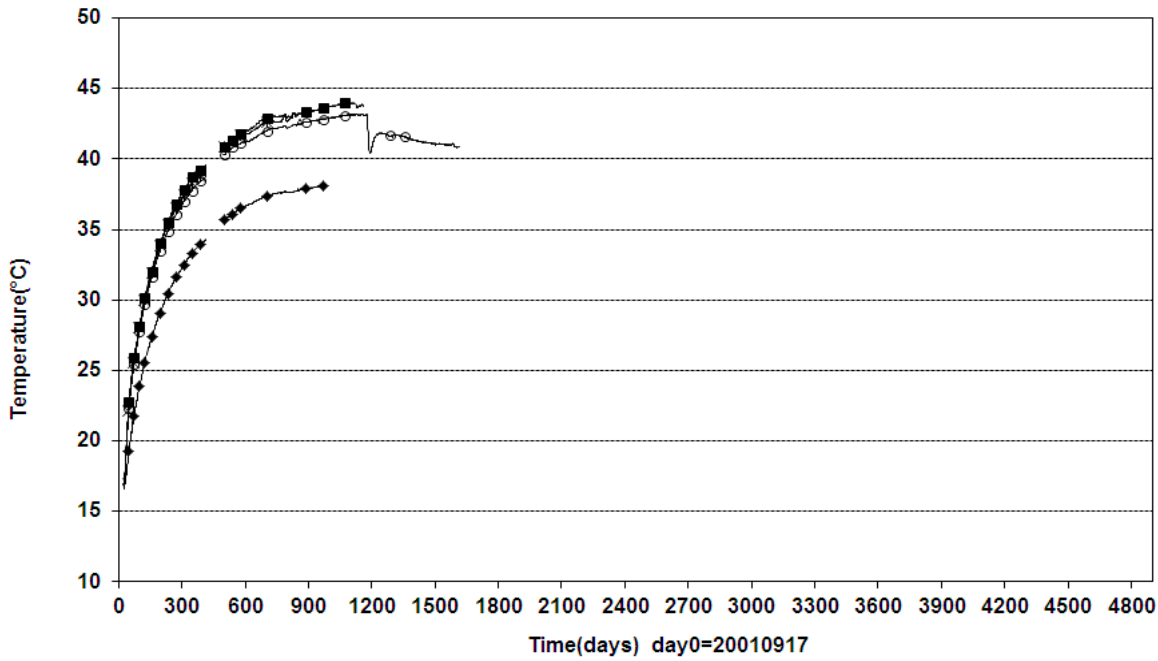
- |                              |                              |                              |
|------------------------------|------------------------------|------------------------------|
| □ TBU30018(2.971\175°\0.735) | ◇ TBU30019(2.971\270°\0.585) | △ TBU30020(2.971\270°\0.635) |
| ■ TBU30021(2.971\270°\0.685) | ◆ TBU30022(2.971\270°\0.735) | ▲ TBU30023(2.971\270°\0.785) |

Prototype\Hole 3\Ring10 (20010917-20150101)  
Temperature - Pentronic

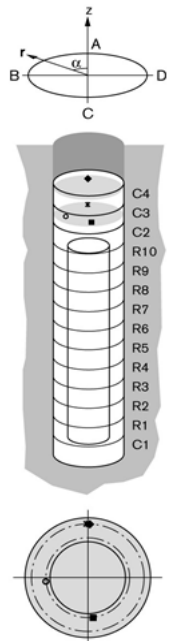


- |                              |                              |                              |
|------------------------------|------------------------------|------------------------------|
| ○ TBU30024(5.504\0°\0.635)   | ■ TBU30025(5.504\0°\0.735)   | ◆ TBU30026(5.504\270°\0.585) |
| ▲ TBU30027(5.504\270°\0.685) | □ TBU30028(5.504\270°\0.785) |                              |

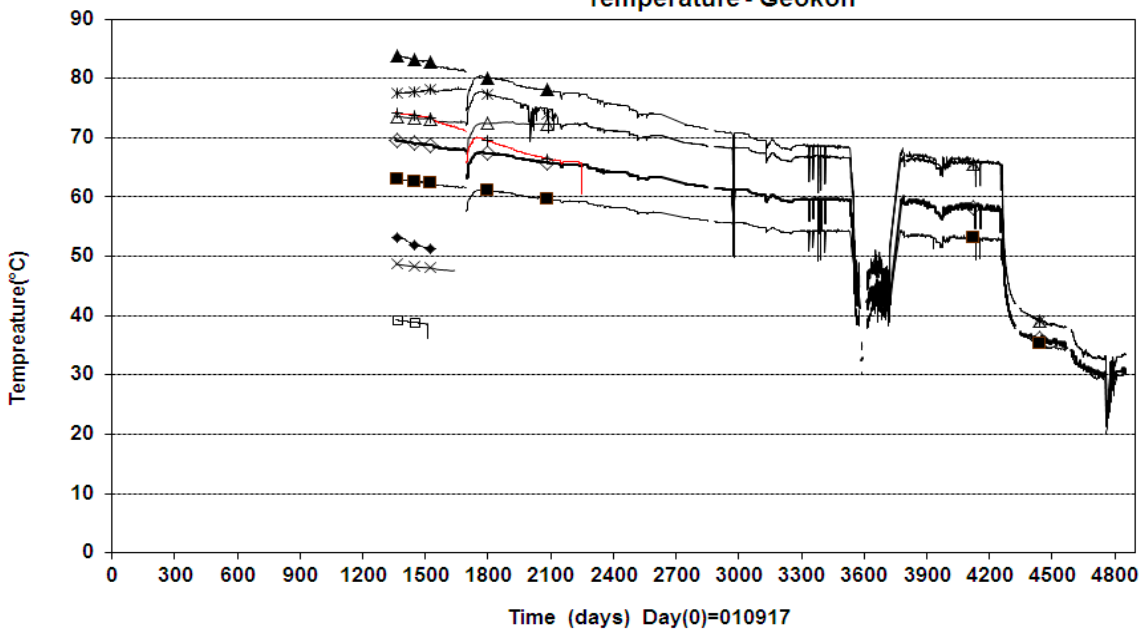
Prototype\Hole 3\Cyl.3 and Cyl.4 (20010917-20150101)  
Temperature - Pentronic



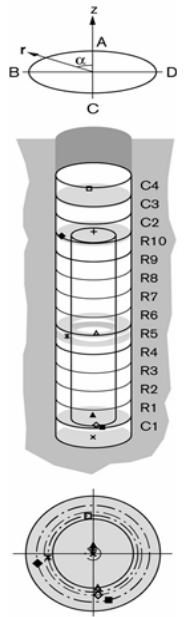
* TBU30029(6.314\0°\0.785)	○ TBU30030(6.314\95°\0.585)
■ TBU30031(6.314\185°\0.585)	◆ TBU30032(7.015\0°\0.785)



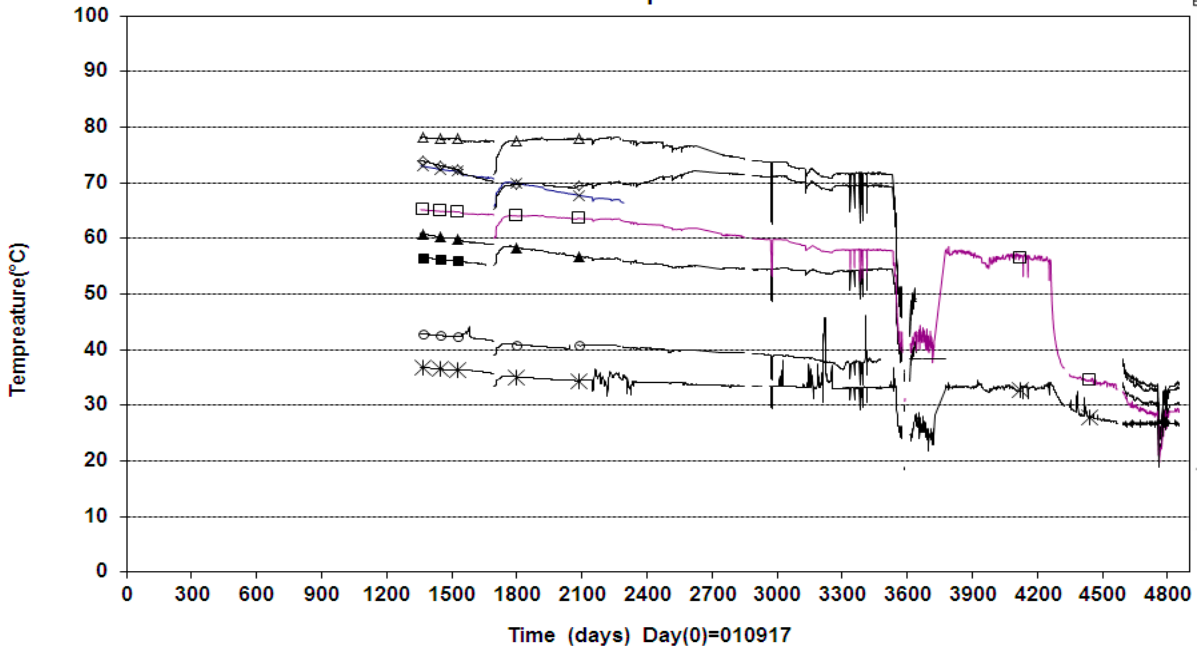
Prototype\Hole 3 (20010917-20150101)  
Temperature - Geokon



× PBU30001(0\0°\0)	▲ PBU30002(0.495\0°\0.100)	◇ PBU30008(0.495\185°\0.635)
■ PBU30009(0.495\195°\0.735)	* PBU30013(2.771\95°\0.585)	△ PBU30015(3.021\185°\0.535)
+ PBU30017(5.556\0°\0.050)	◆ PBU30022(5.556\100°\0.735)	□ PBU30026(6.654\5°\0.585)

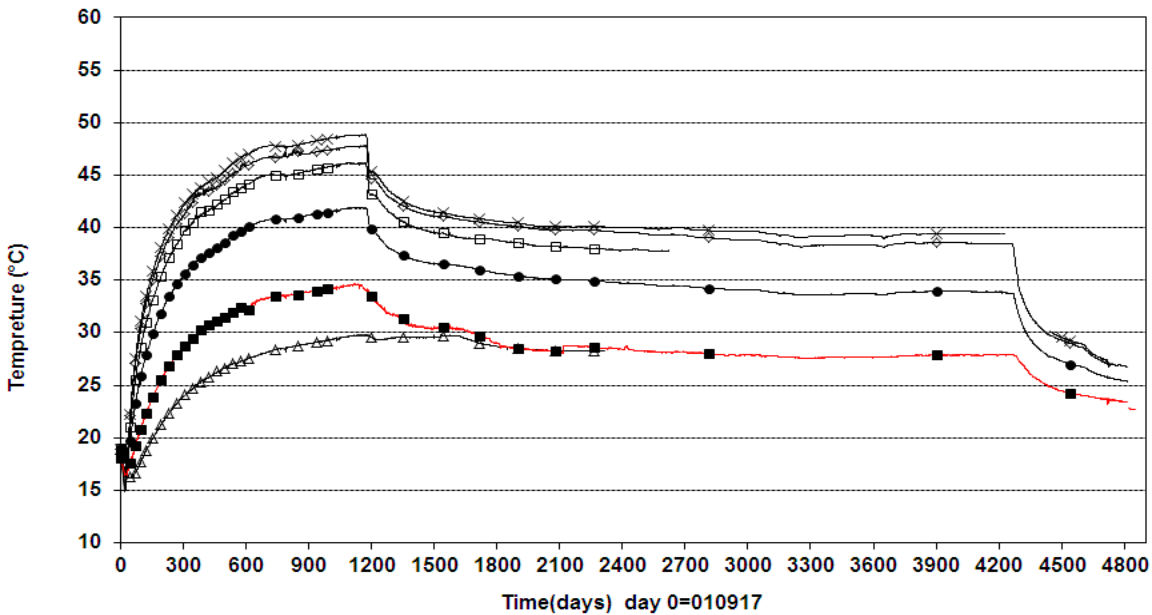


Prototype\Hole 3 (20010917-20150101)  
Temperature - Geokon



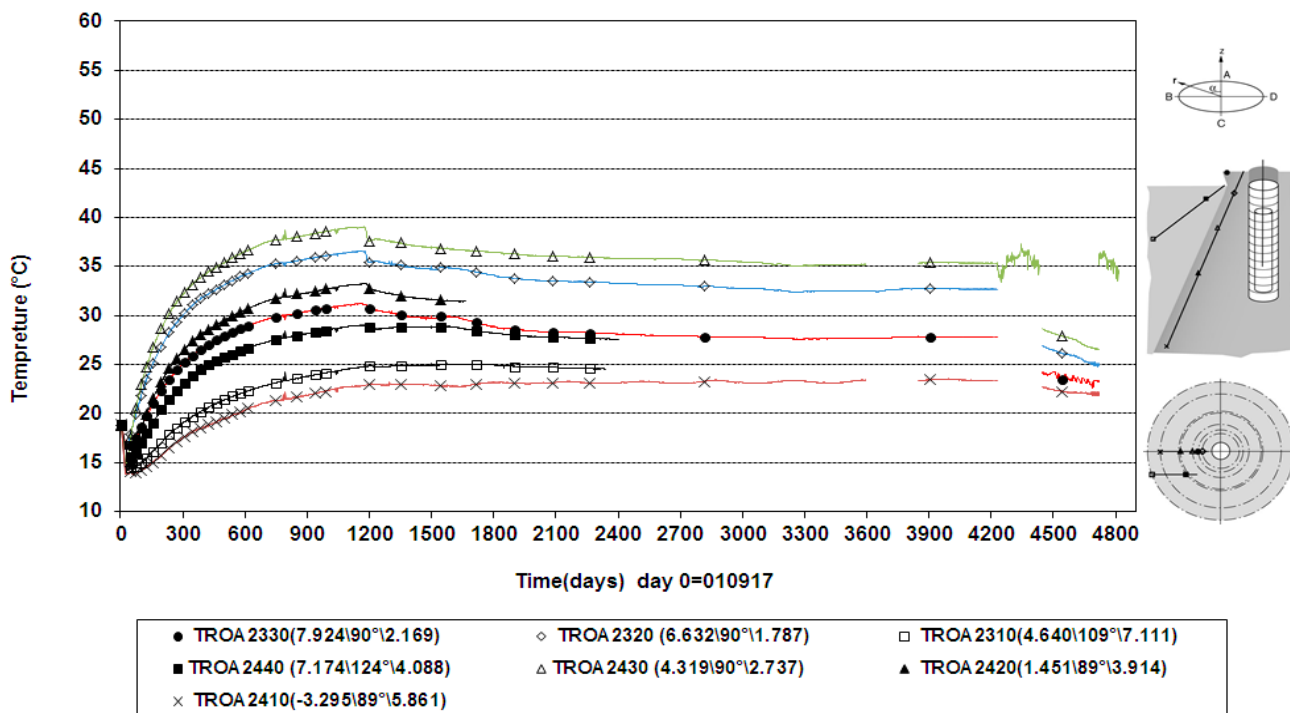
× UBU30002(0.245\90°\0.100)	▲ UBU30003(0.335\355°\0.585)	◇ UBU30005(2.771\355°\0.585)
△ UBU30009(2.771\175°\0.535 in the slot)	□ UBU30010(2.771\175°\0.825 in the slot)	■ UBU30012(5.306\355°\0.785)
○ UBU30013(6.314\90°\0.050)	* UBU30014(6.910\90°\0.050)	

Prototype\Rock\Hole 3 (20010917-20150101)  
Temperature - Pentronic

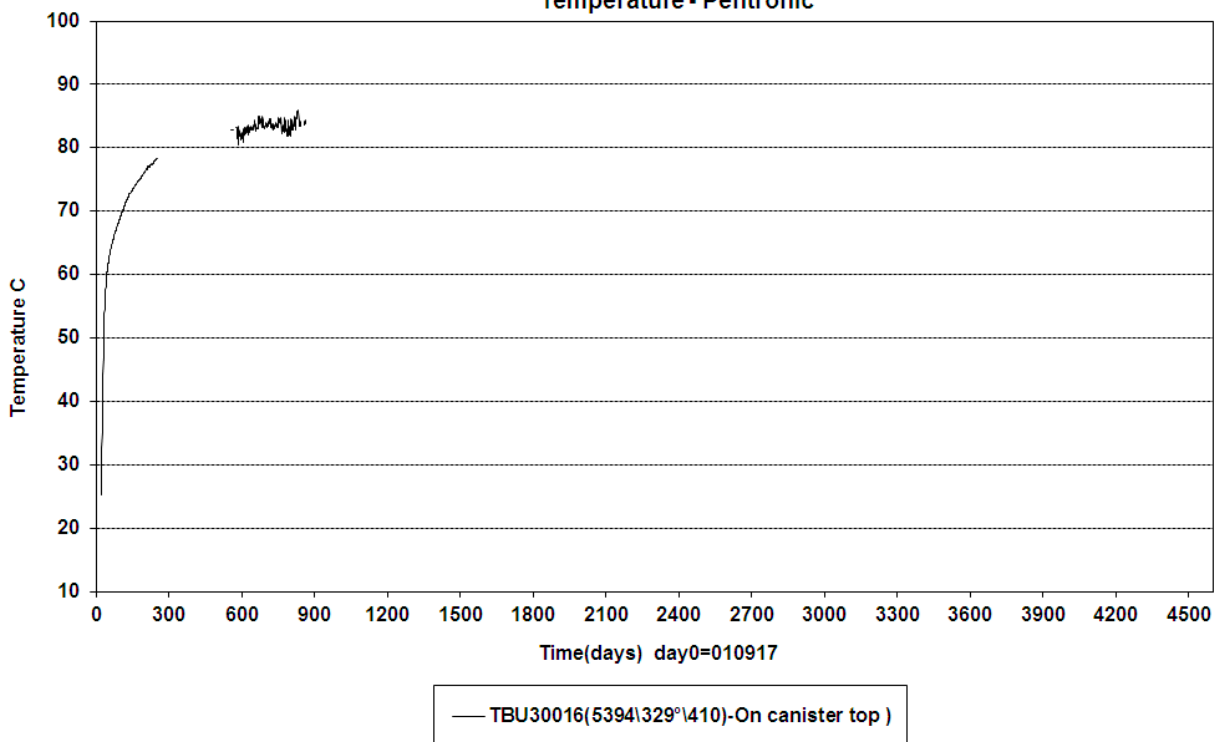


△ TROA 2150(7.958\134°\3.284)	● TROA 2140 (5.979\1°\1.999)	◇ TROA 2130(4.230\2°\1.981)
× TROA 2120(2.840\2°\1.967)	□ TROA 2110(1.170\3°\1.950)	■ TROA 1850 (7.889\0°\2.019)

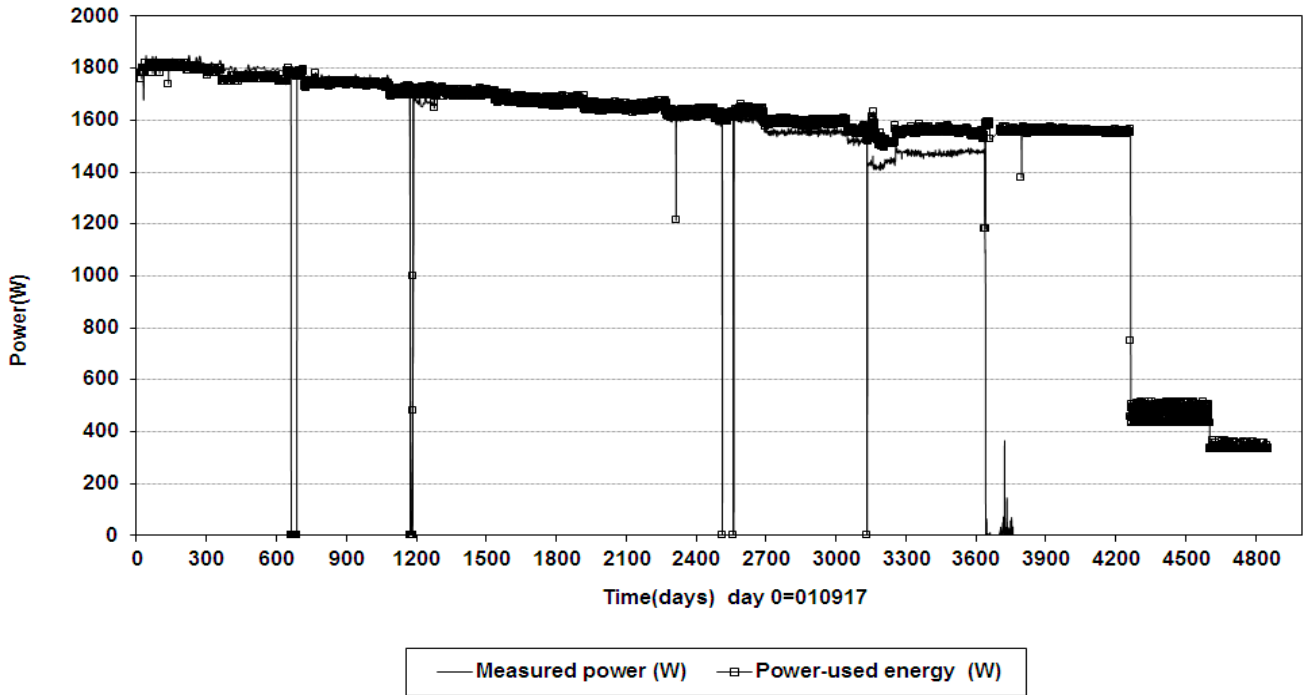
Prototype\Rock\Hole 3 (20010917-20150101)  
Temperature - Pentronic



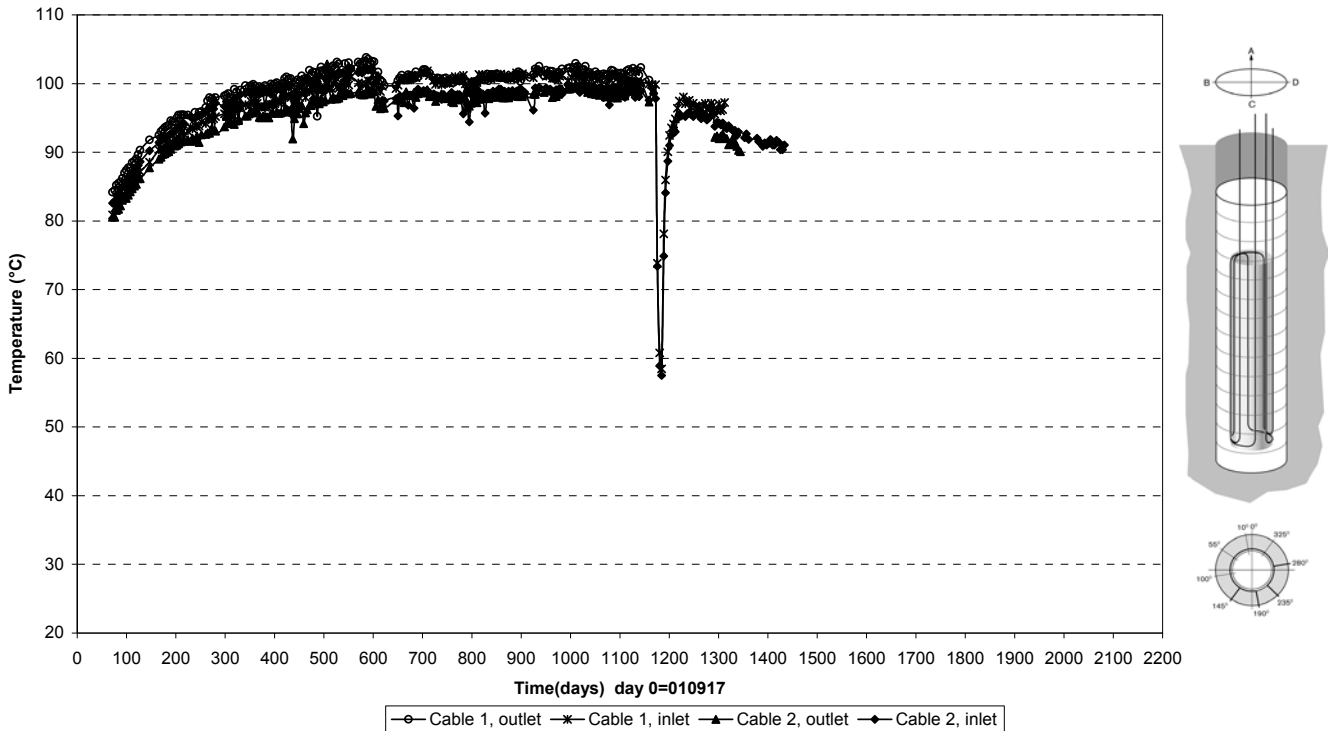
Prototype\Hole 3\ On canister top (010917-20140101)  
Temperature - Pentronic



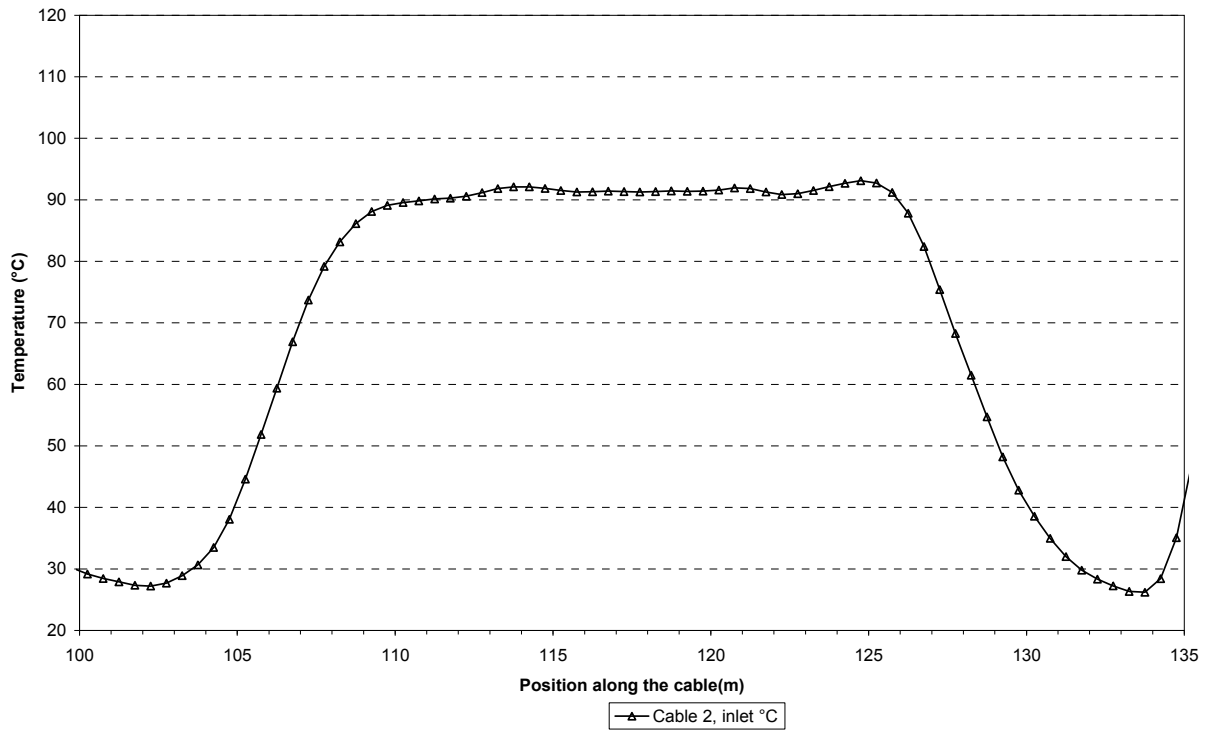
Prototype\Hole 3 (20010917-20150101)  
Canister power



Prototype\ Hole 3 \Canister (010917-070601)  
Max. temperature on the canister surface - Optical fibre cables



Prototype\ Hole 3 \Canister (050601)  
Temperature profile on the canister surface - Optical fiber cables

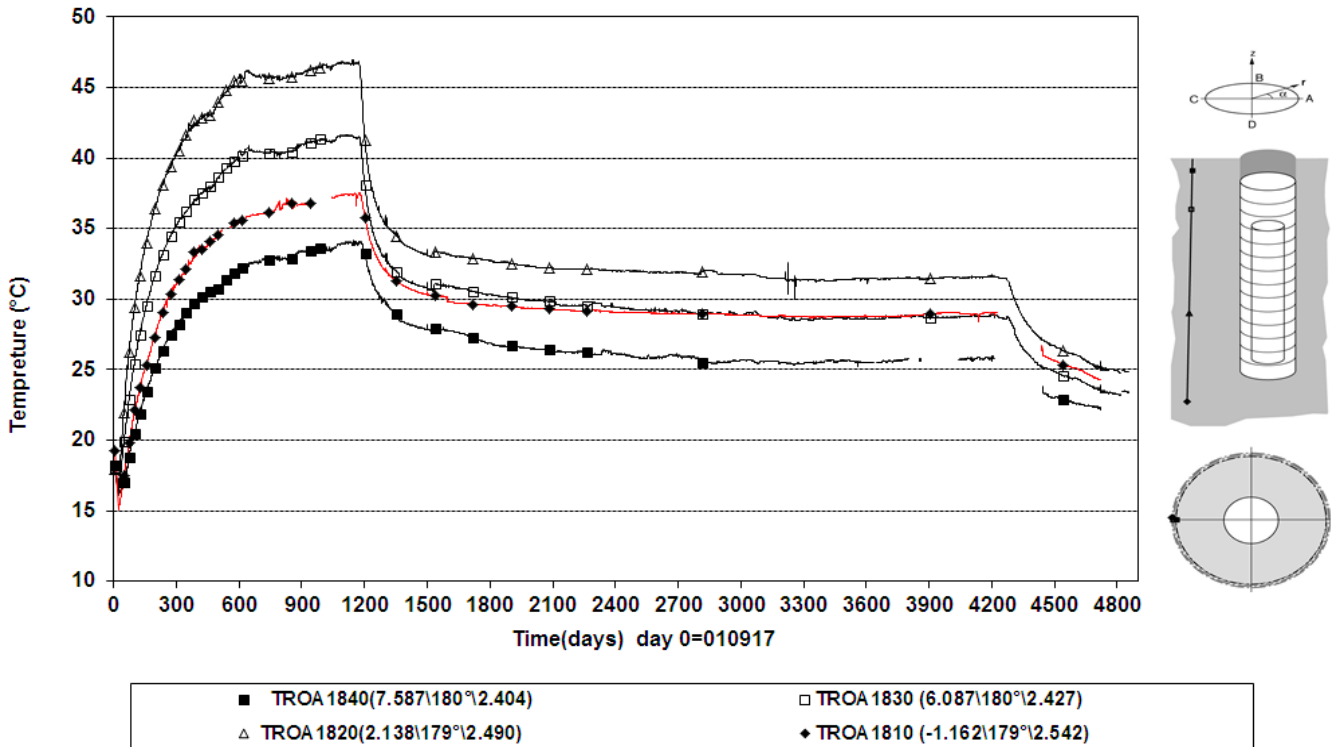




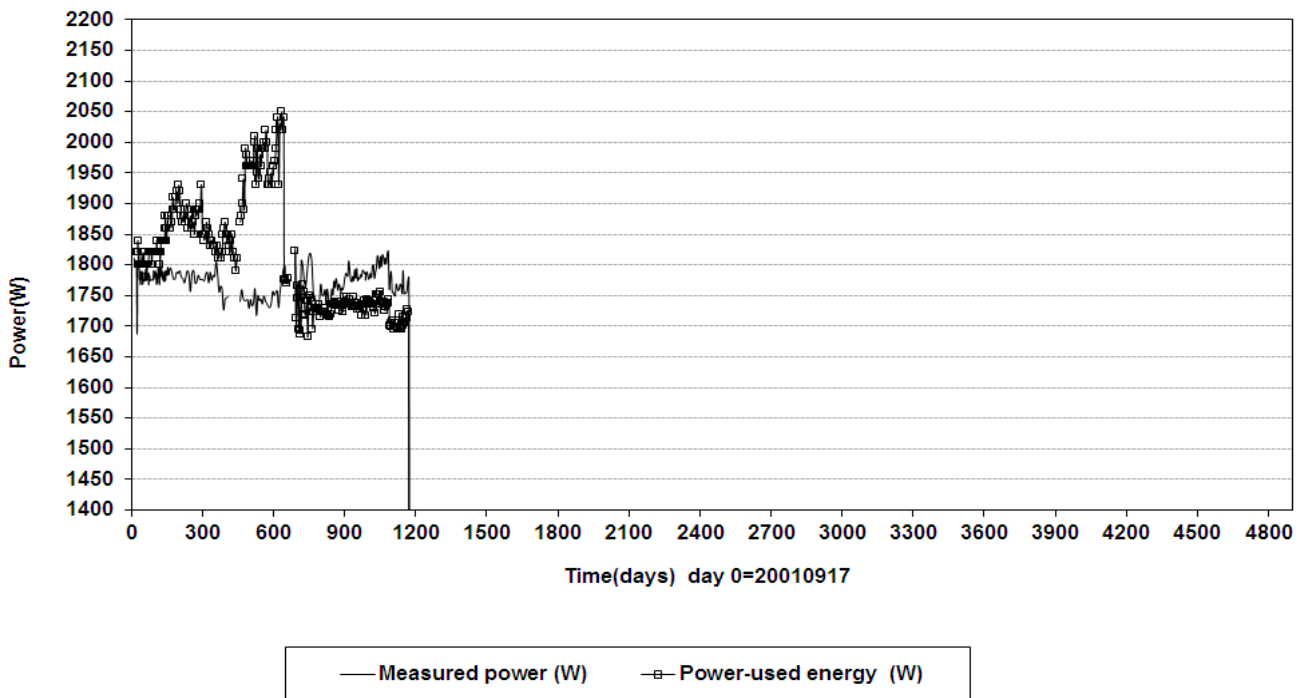


Dep. holes 2 and 4

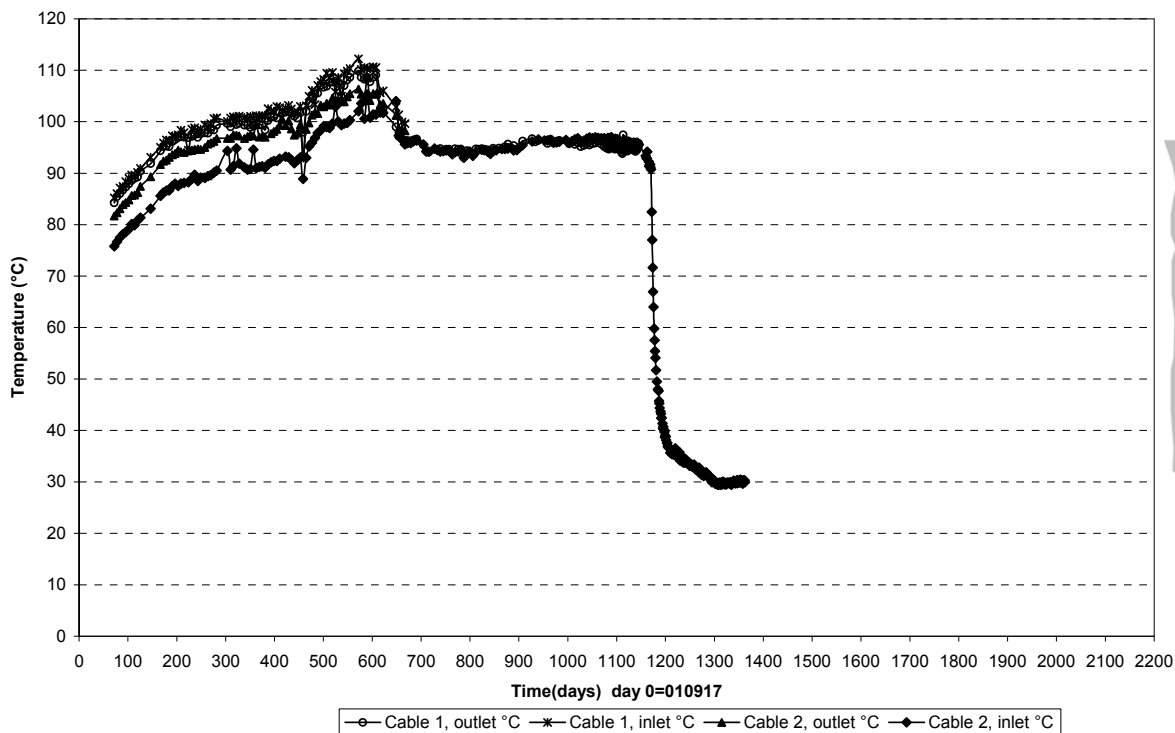
Prototype\Rock\Hole 2 (20010917-20150101)  
Temperature - Pentronic



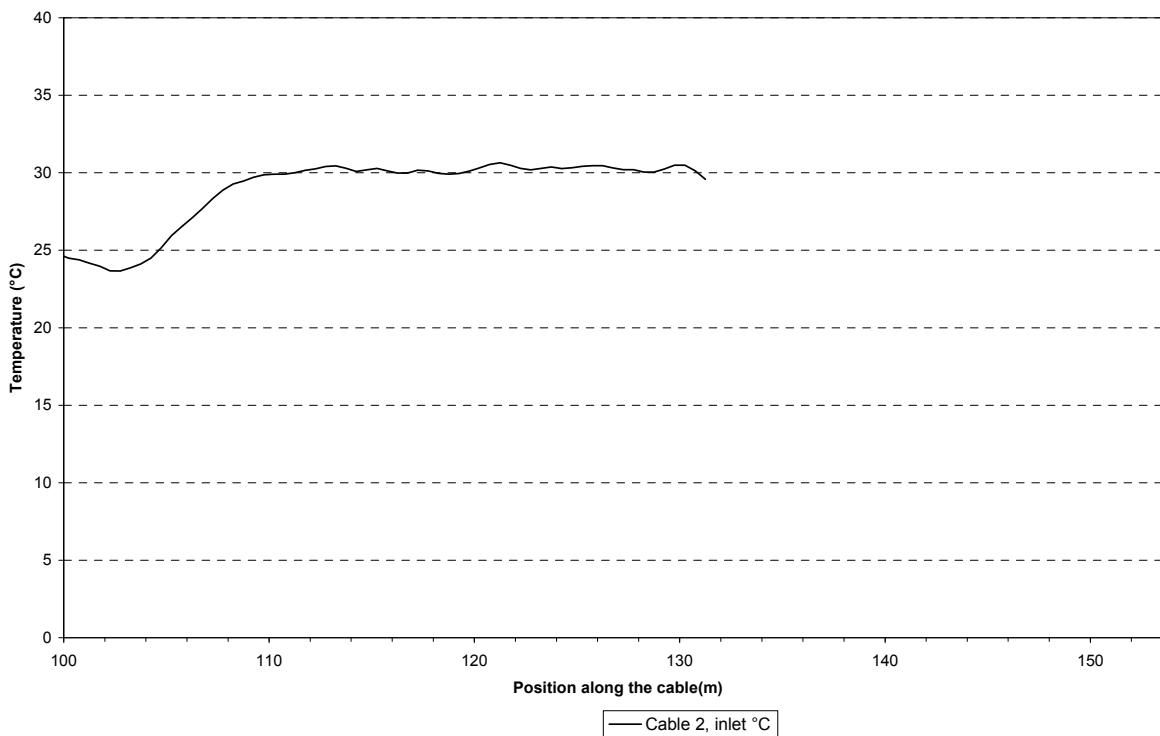
Prototype\Hole 2 (20010917-20150101)  
Canister power



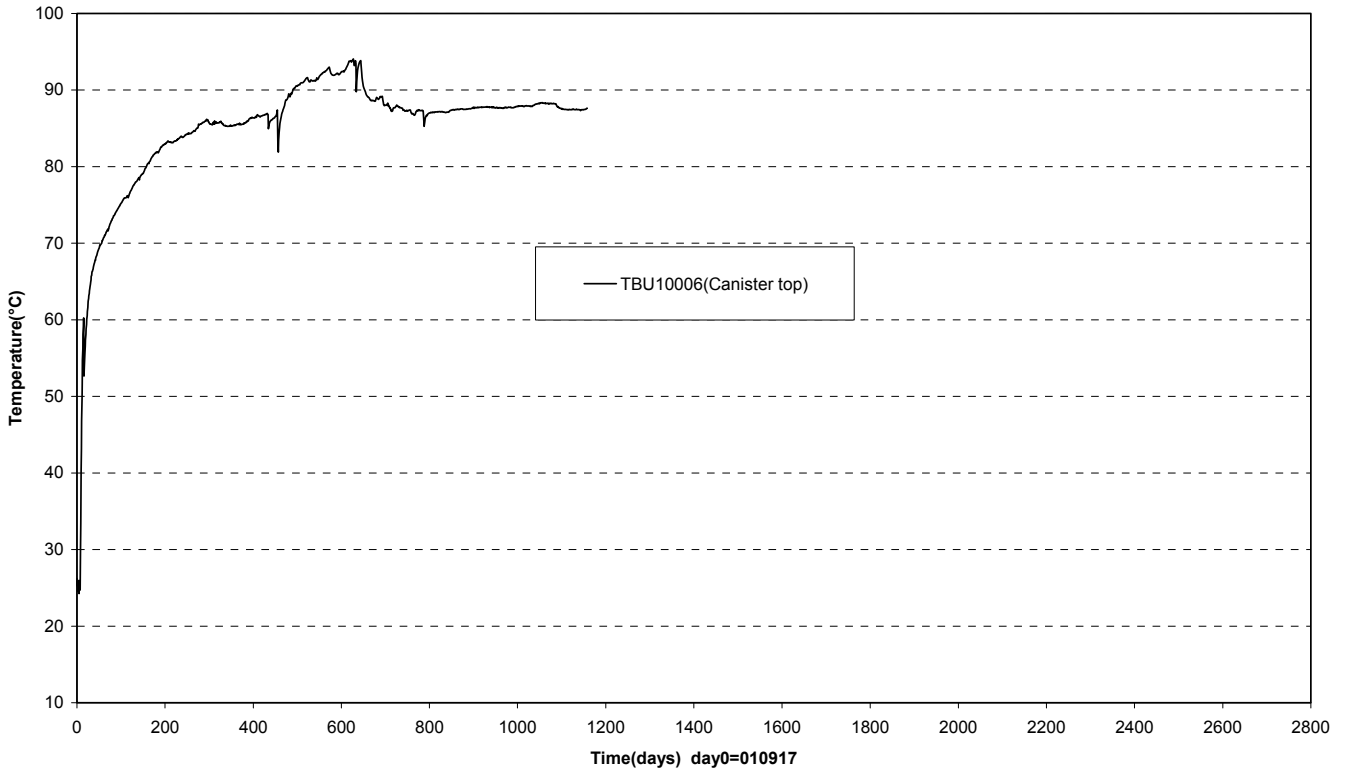
Prototype\ Hole 2 \Canister (010917-070601)  
 Max. temperature on the canister surface - Optical fiber cables



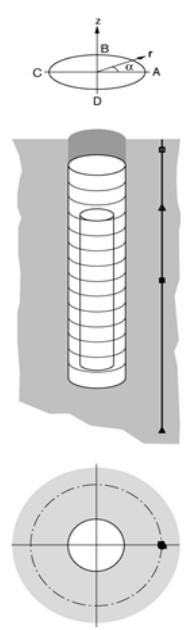
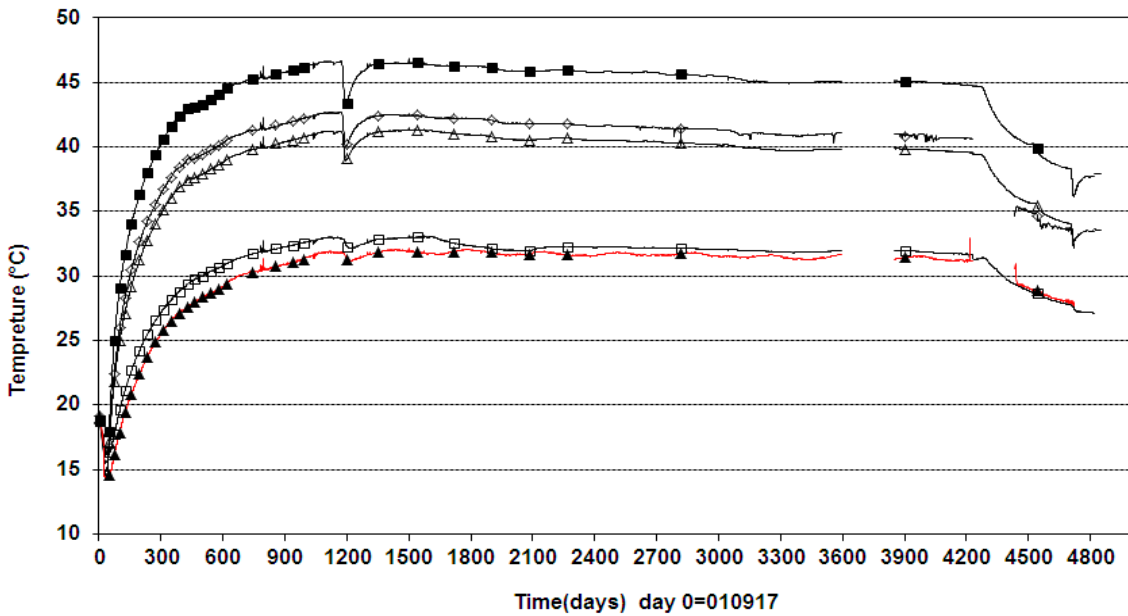
Prototype\ Hole 2 \Canister (050601)  
 Temperature profile on the canister surface - Optical fiber cables



Prototype\Hole 2 \Canister top (010917-081201)  
Temperature - Pentronic

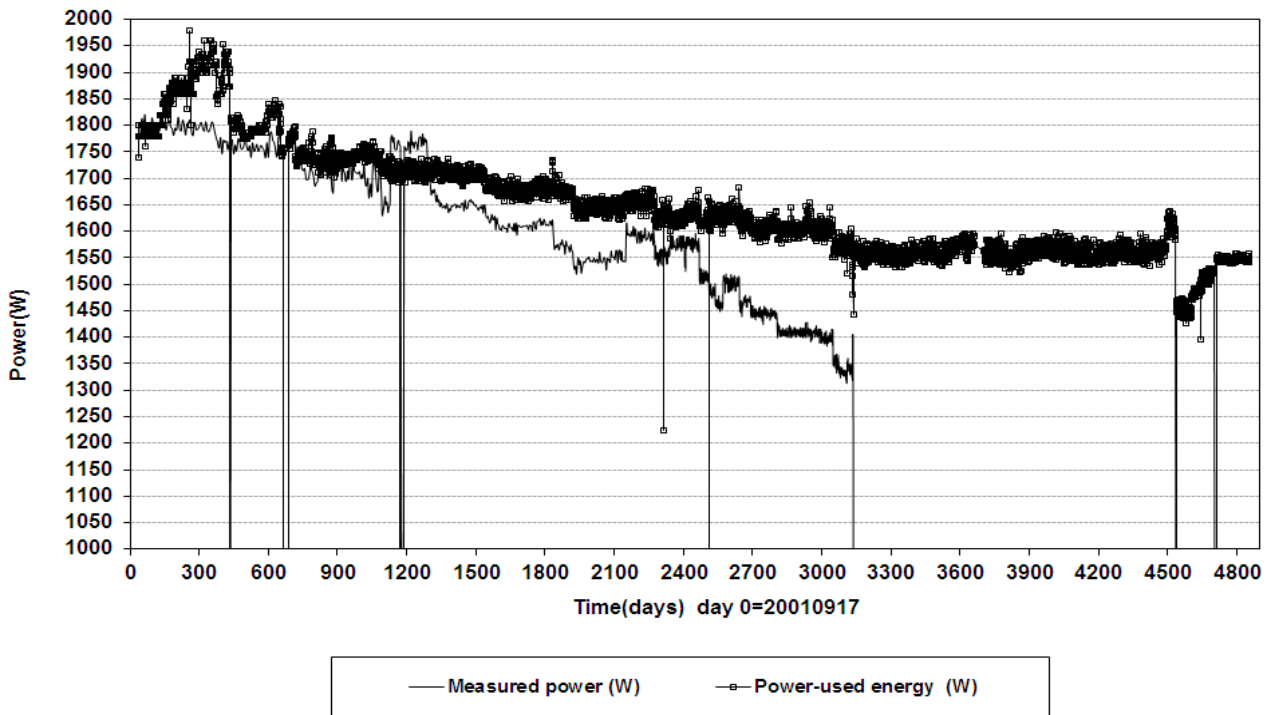


Prototype\Rock\Hole 4 (20010917-20150101)  
Temperature - Pentronic

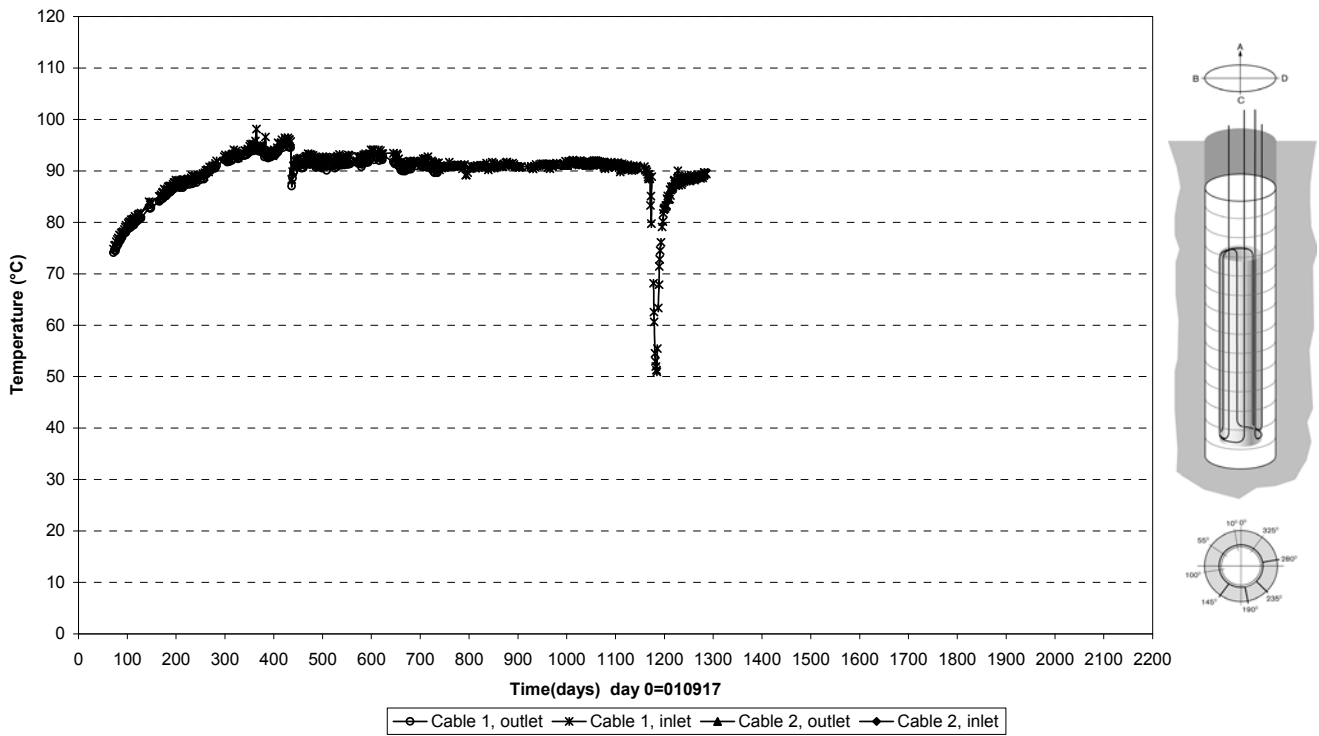


□ TROA 3050 (7.671\360°\2.017)	△ TROA 3040 (5.671\359°\2.025)	■ TROA 3030(3.271\358°\2.034)
◇ TROA 3020(0.871\358°\2.045)	▲ TROA 3010(-1.778\357°\2.056)	

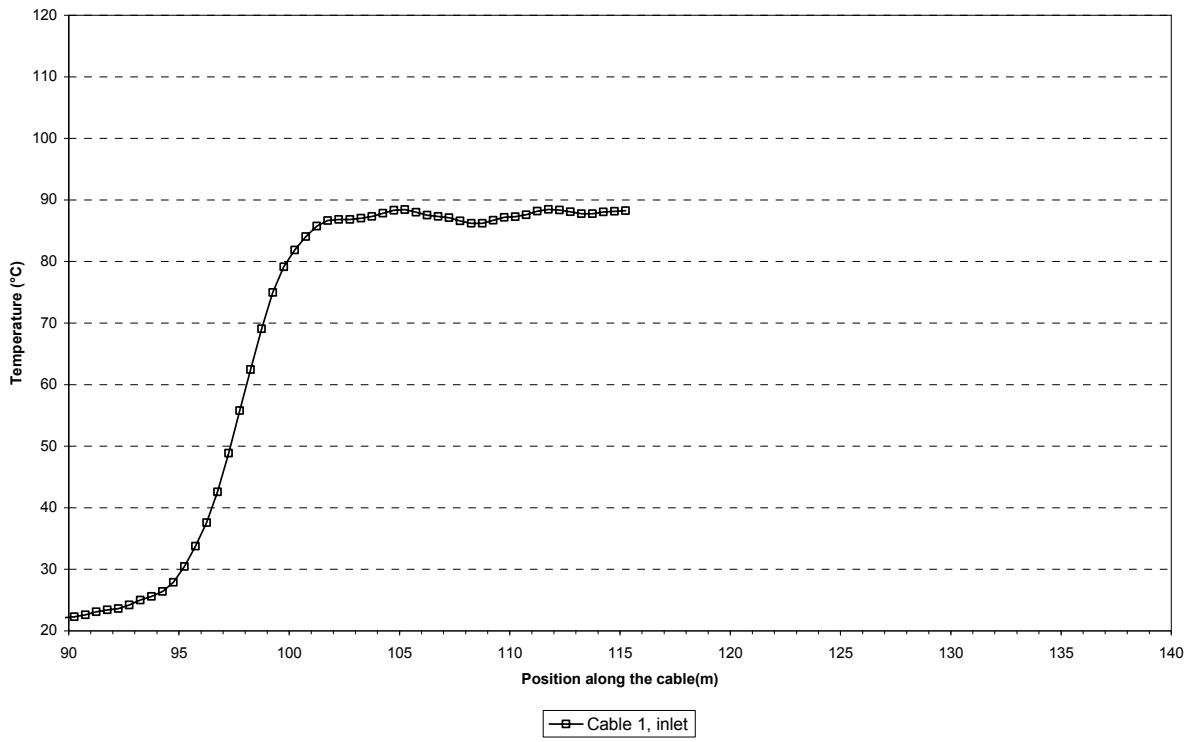
Prototype\Hole 4 (20010917-20150101)  
Canister power



Prototype\ Hole 4 \Canister (010917-070601)  
Max. temperature on the canister surface - Optical fiber cables



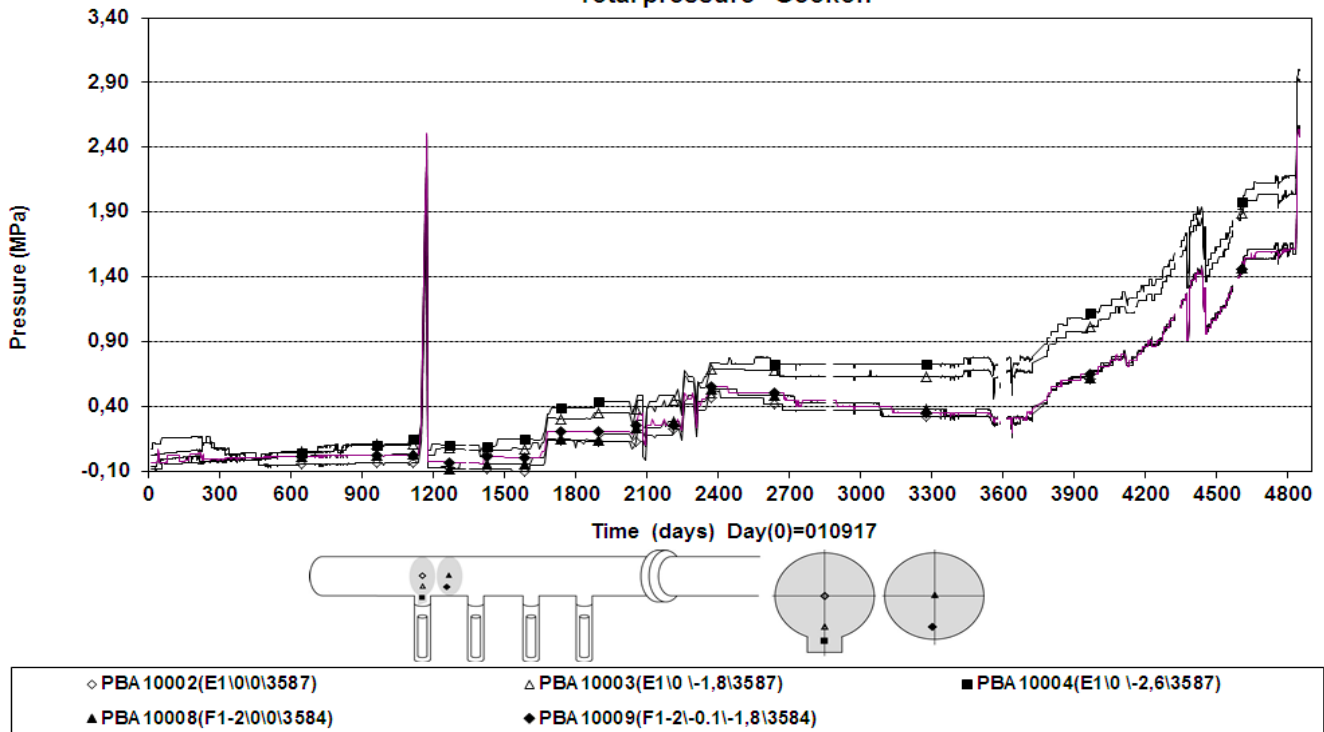
Prototype\ Hole 4\Canister (041130)  
Temperature profile on the canister surface - Optical fiber cables



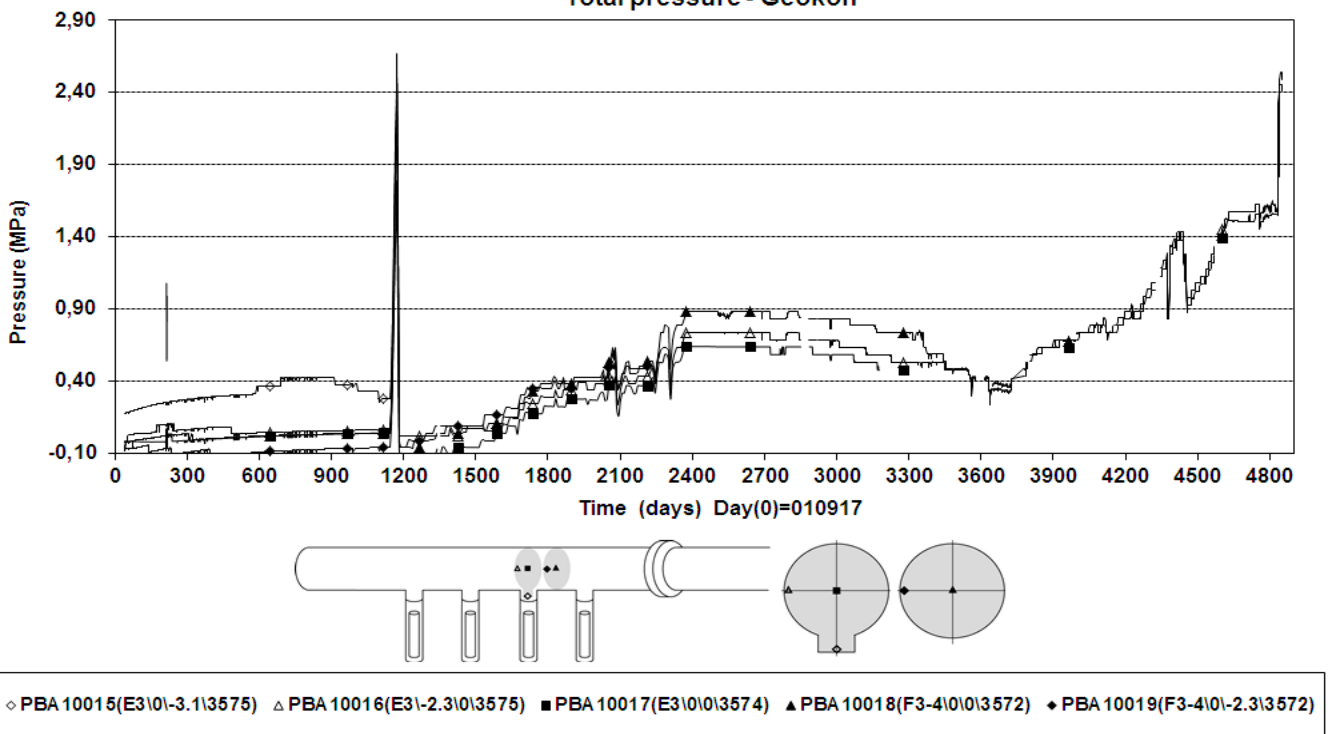


Backfill in section 1

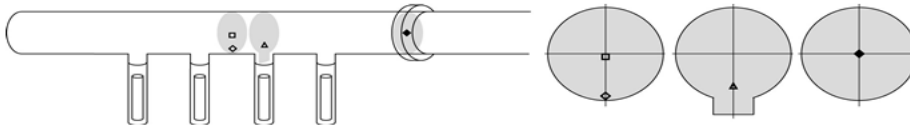
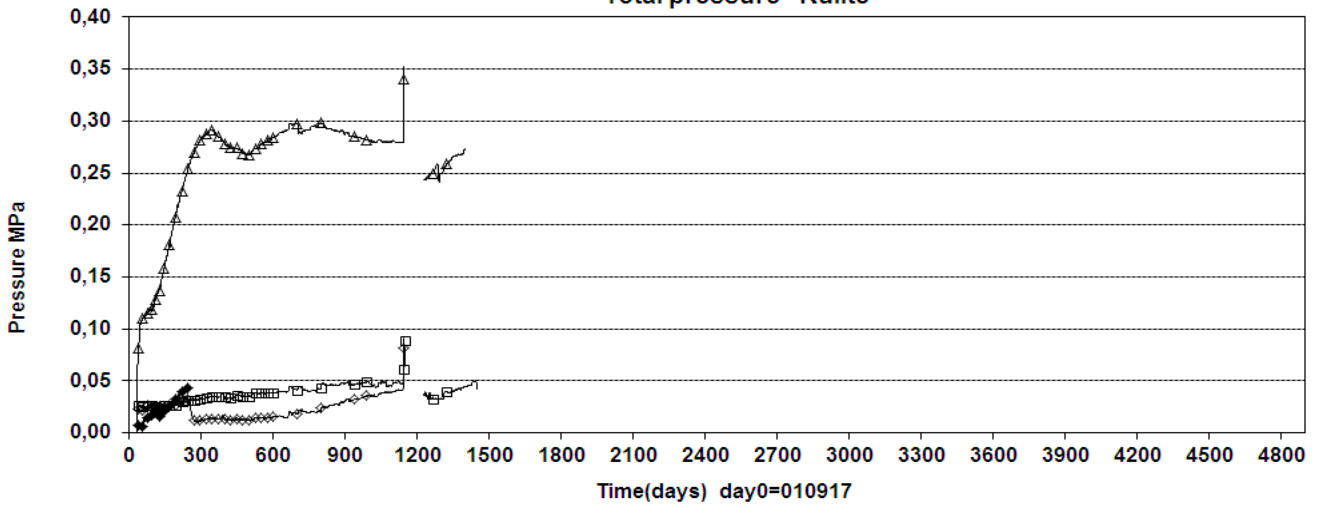
Prototype\Backfill\Section 1 (010917-20150101)  
Total pressure - Geokon



Prototype\Backfill\ Section 1 (010917-20150101)  
Total pressure - Geokon

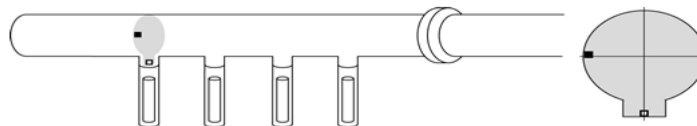
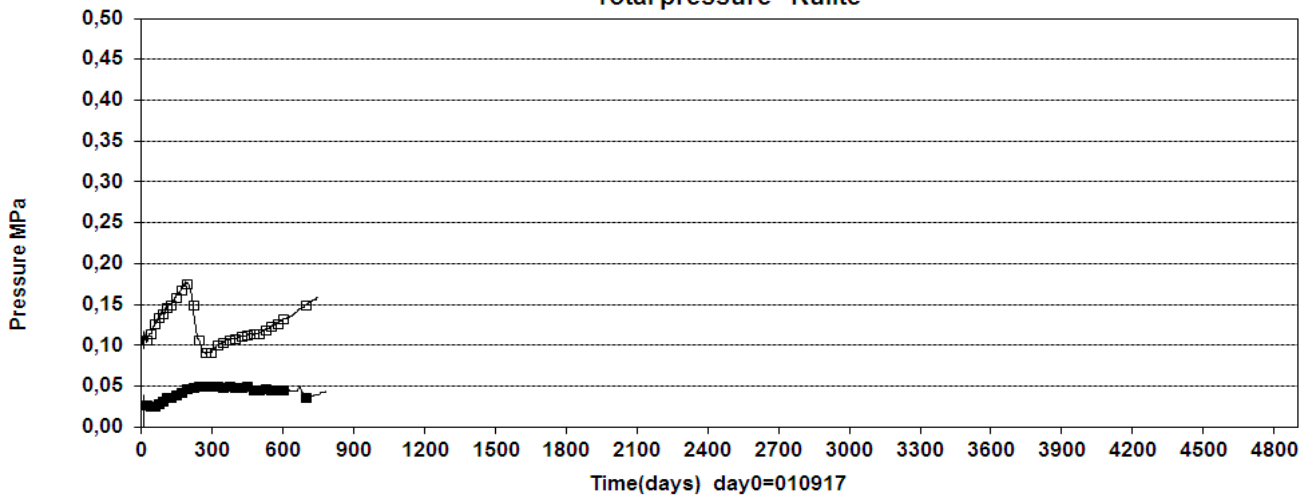


Prototype\Backfill\Section 1 (20010917-20150101)  
Total pressure - Kulite



- PBA 10010(F1-2\0\0-0.2\3\578)
- ◇ PBA 10011(F1-2\0\0-2.3\3\578)
- △ PBA 10013(E3\0\0-1.82\3\575)
- ◆ PBA 10020(In front of plug\0\0\3\561)

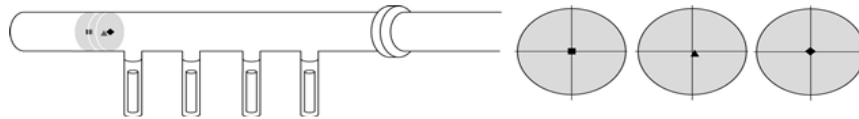
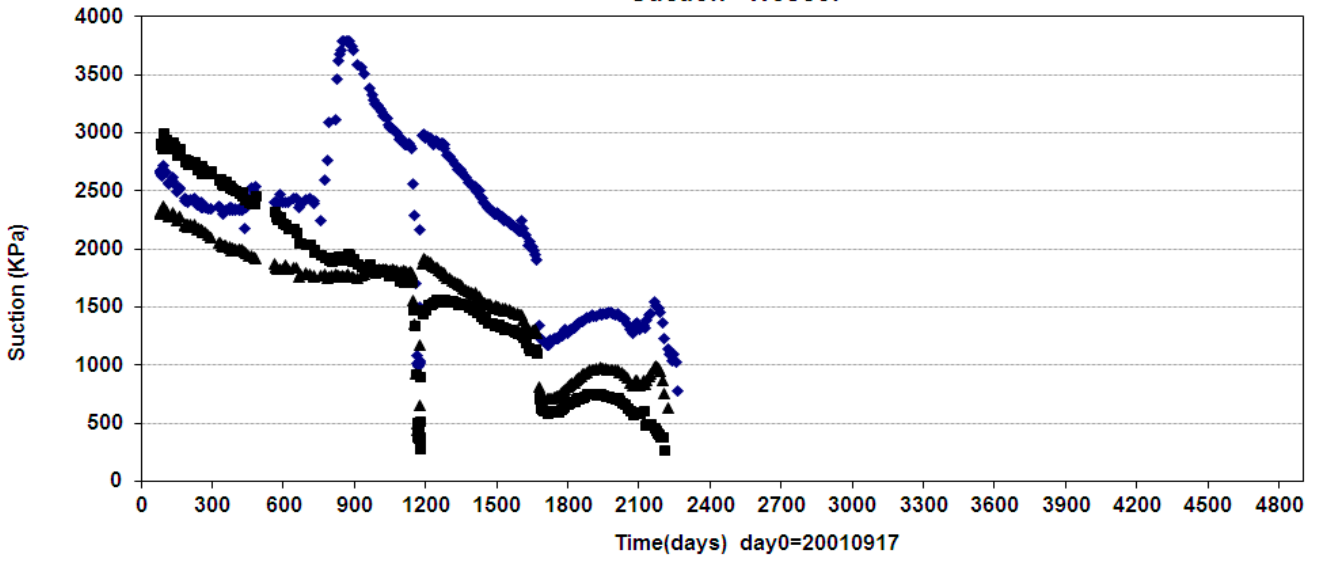
Prototype\Backfill\Section 1 (20010917-20150101)  
Total pressure - Kulite



- PBA 10005(E1\0\0-3.1\3\587)
- PBA 10006(E1\0\0-2.3\0.1\3\587)

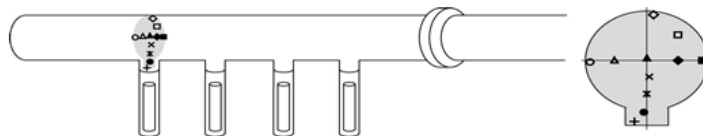
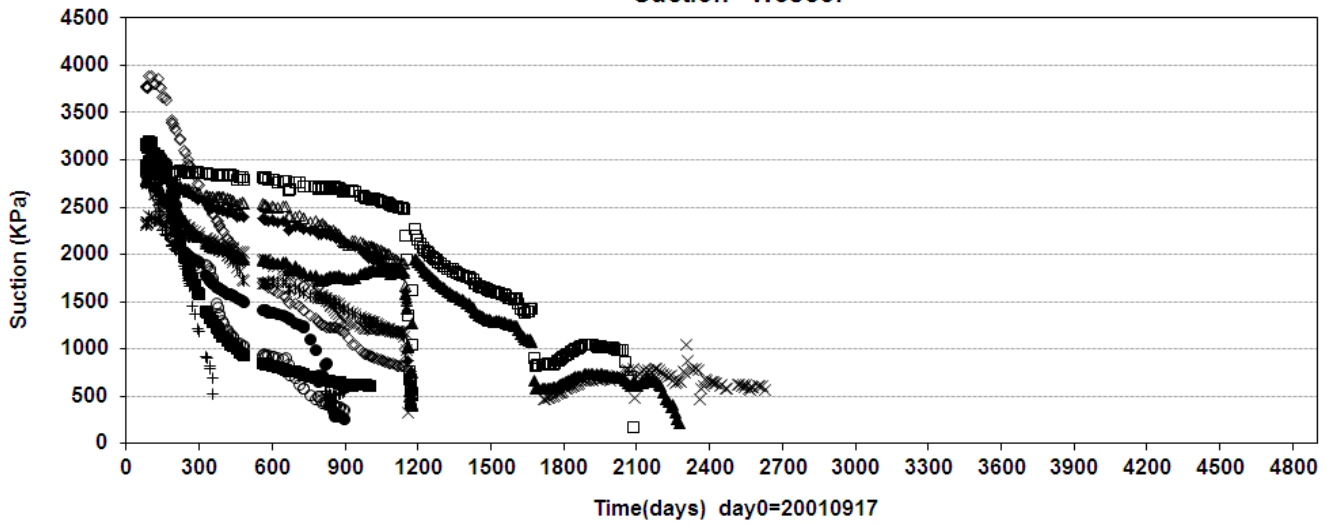


PrototypelBackfill\ Inner part (20010917-20150101)  
Suction - Wescor



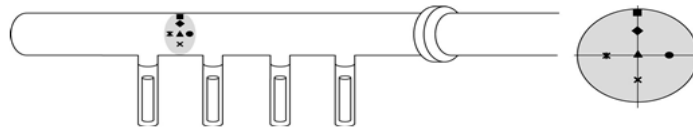
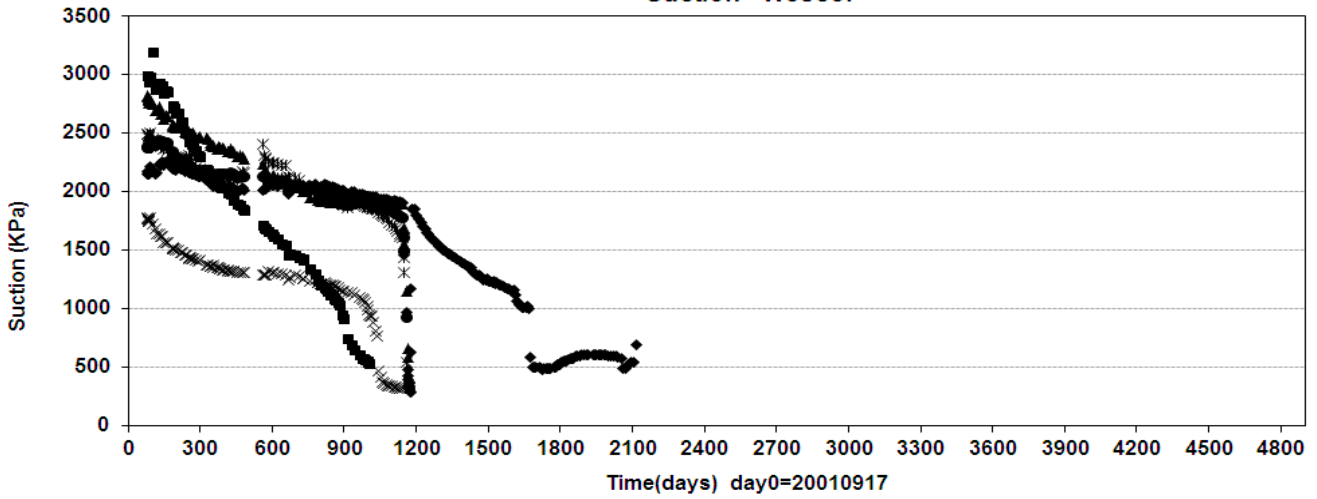
- ◆ WBA10001(Inner part\0\0\3589)
- WBA10002(Inner part\0\0\3592)
- ▲ WBA10003(Inner part\0.1\-0.1\3590)

PrototypelBackfill\ Above dep.hole 1 (20010917-20150101)  
Suction - Wescor



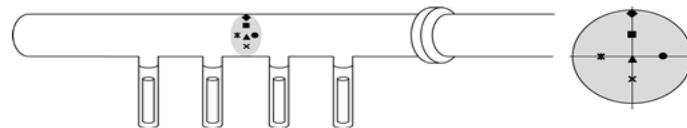
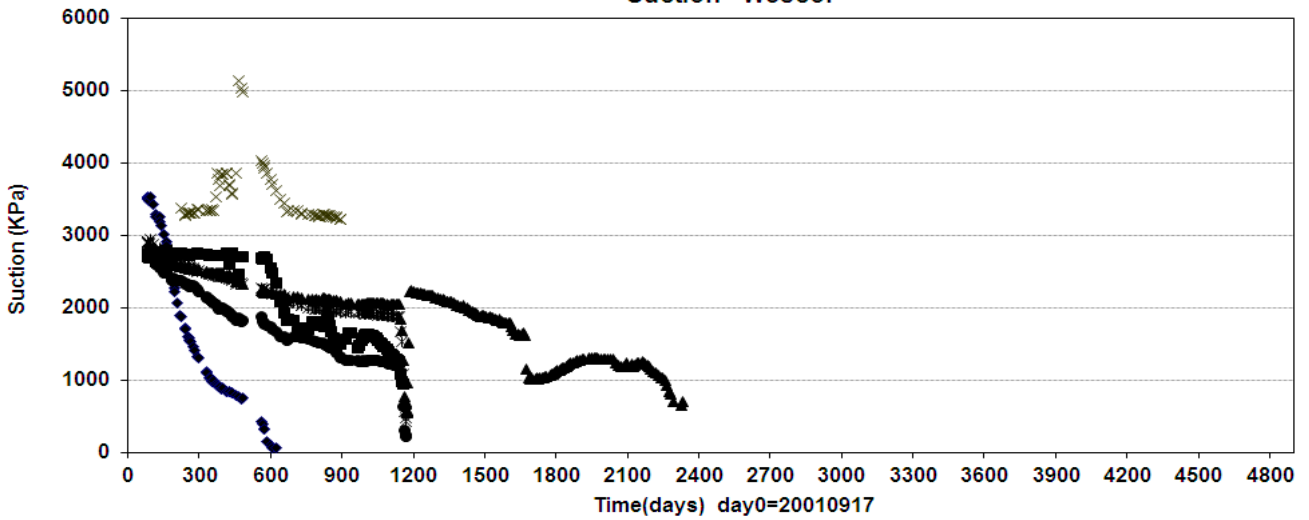
- ◇ WBA10004(E1\0.25\2.3\3587)
- × WBA10007(E1\0.1\-0.8\3587)
- + WBA10010(E1\-0.5\-3.13\3587)
- ◆ WBA10013(E1\1.3\0\3587)
- WBA10005(E1\0\1.25\3587)
- × WBA10008(E1\0\-1.7\3587)
- WBA10011(E1\-2.3\-0.1\3587)
- WBA10014(E1\2.3\0\3587)
- ▲ WBA10006(E1\0\0.1\3587)
- WBA10009(E1\-0.1\-2.6\3587)
- △ WBA10012(E1\-1.3\0\3587)

Prototype\Backfill \ Between dep.hole 1 and hole 2 (20010917-20150101)  
Suction - Wescor



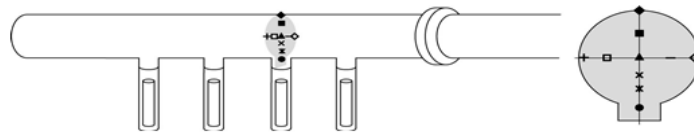
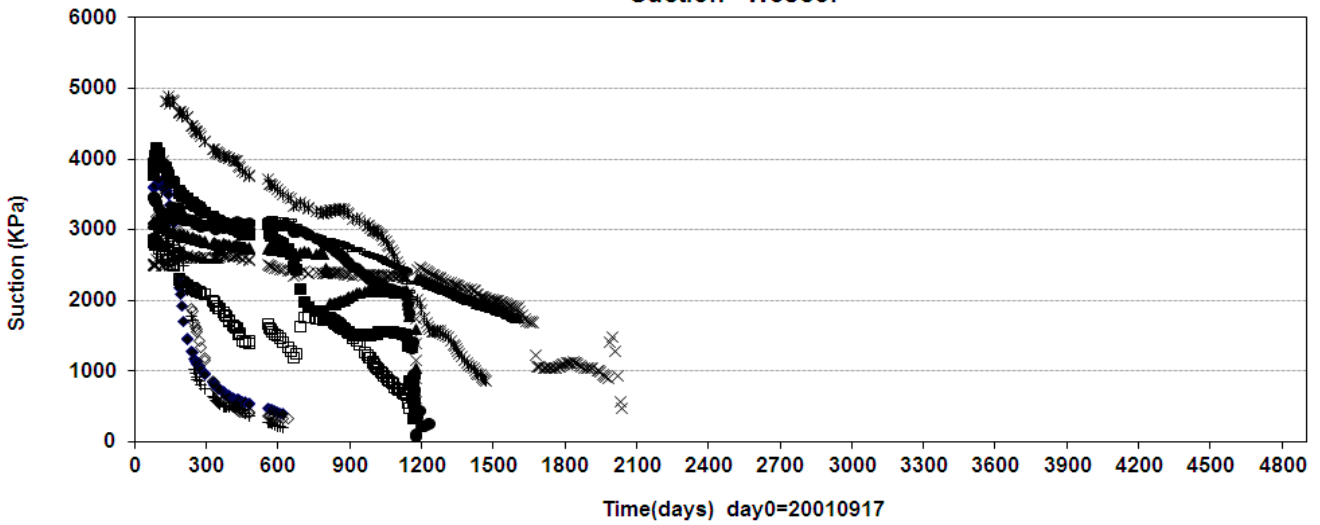
- ◆ WBA10015(F1-2\0\1.3\3584)    ■ WBA10016(F1-2\0\2.3\3584)    ▲ WBA10017(F1-2\0\0\3584)
- × WBA10018(F1-2\0\1.3\3584)    \* WBA10019(F1-2\1.3\0\3584)    ● WBA10020(F1-2\1.3\0\3584)

Prototype\Backfill \ Between dep.hole 2 and hole 3 (20010917-20150101)  
Suction - Wescor



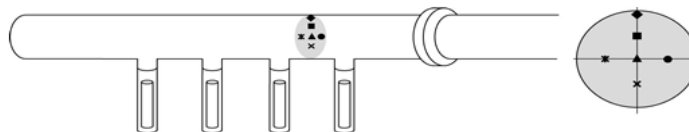
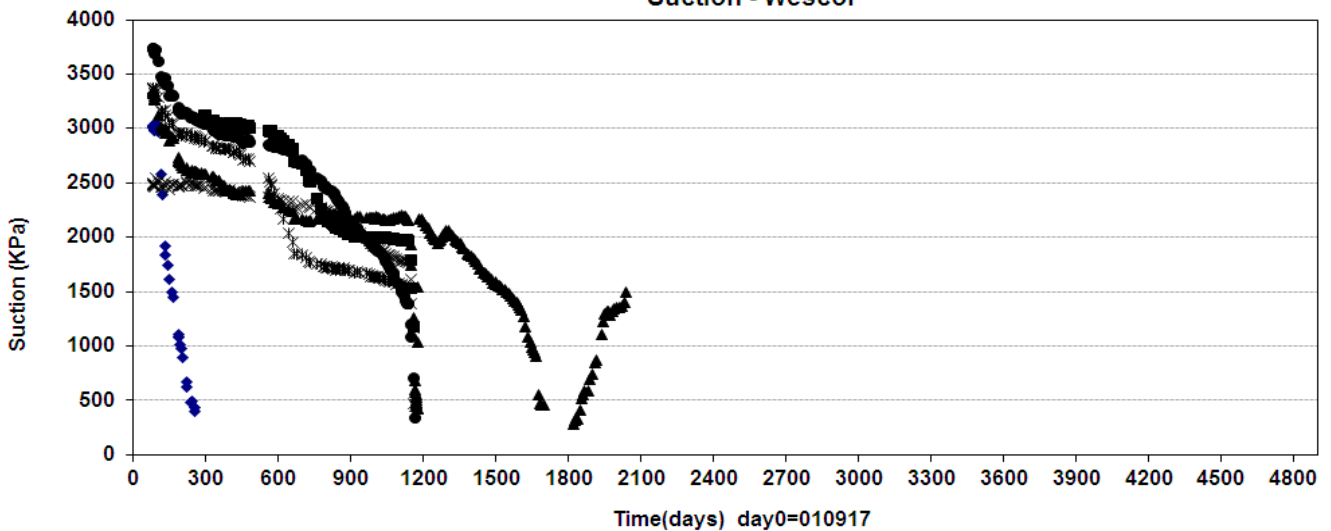
- ◆ WBA10021(F2-3\0\2.3\3578)    ■ WBA10022(F2-3\0\1.2\3578)    ▲ WBA10023(F2-3\0\0.2\3578)
- \* WBA10025(F2-3\1.3\0\3578)    ● WBA10026(F2-3\1.3\0\3578)    × WBA10024(F2-3\0\1.2\3578)

Prototype\Backfill\ Above dep.hole 3 (20010917-20150101)  
Suction - Wescor



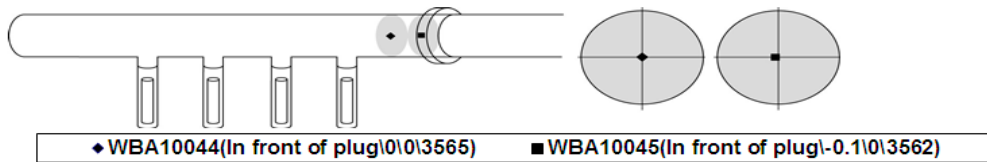
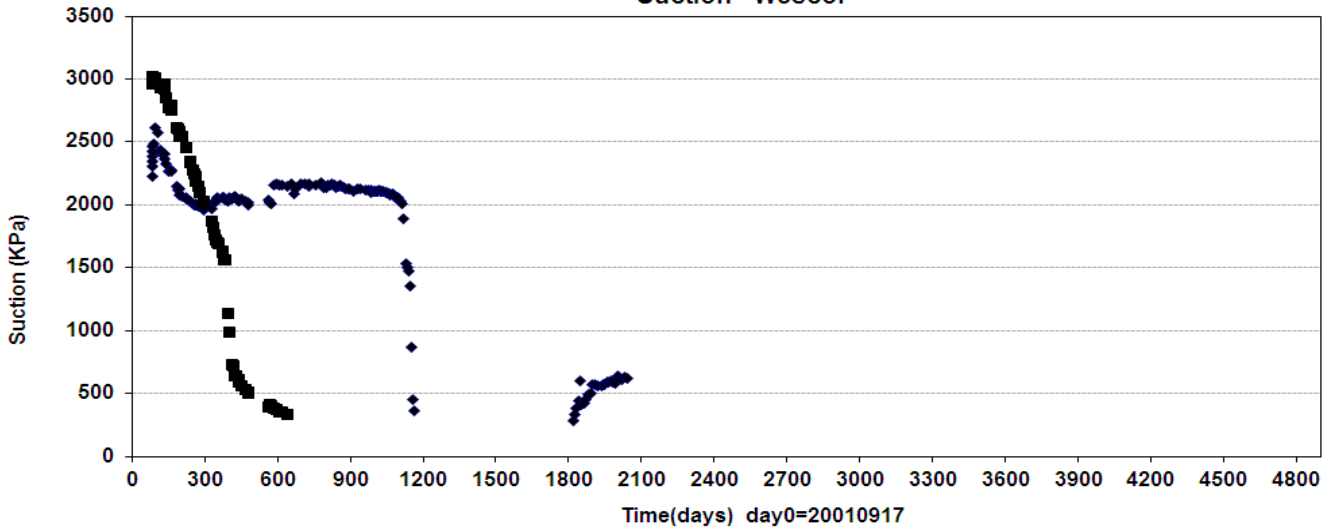
- |                           |                             |                           |                           |
|---------------------------|-----------------------------|---------------------------|---------------------------|
| ◆ WBA10027(E3\0\2.5\3574) | ■ WBA10028(E3\0\1.3\3575)   | ▲ WBA10029(E3\0\0\3575)   | × WBA10030(E3\0\0.9\3575) |
| * WBA10031(E3\0\1.6\3575) | ● WBA10032(E3\0.3\2.6\3575) | + WBA10034(E3\2.3\0\3575) | □ WBA10035(E3\1.3\0\3575) |

Prototype\Backfill\ Between dep.hole 3 and hole 4 (20010917-20150101)  
Suction - Wescor

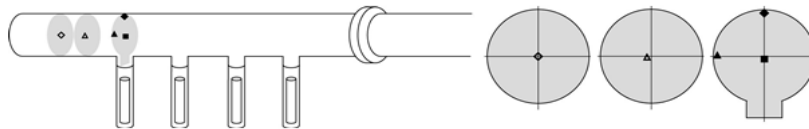
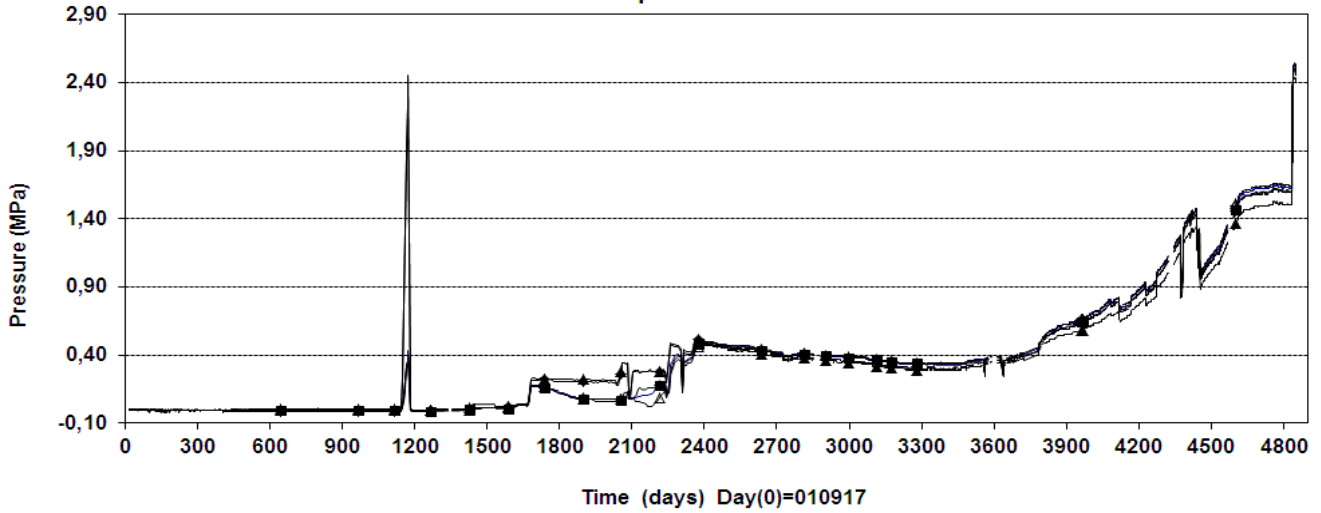


- |                              |                              |                              |
|------------------------------|------------------------------|------------------------------|
| ◆ WBA10038(F3- 4\0\2.3\3572) | ■ WBA10039(F3- 4\0\1.2\3572) | ▲ WBA10040(F3- 4\0\0\3572)   |
| × WBA10041(F3- 4\0\1.1\3572) | * WBA10042(F3- 4\1.3\0\3572) | ● WBA10043(F3- 4\1.3\0\3572) |

Prototype\Backfill \ In front of plug (20010917-20150101)  
Suction - Wescor

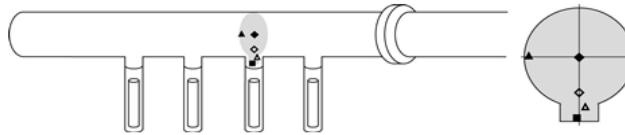
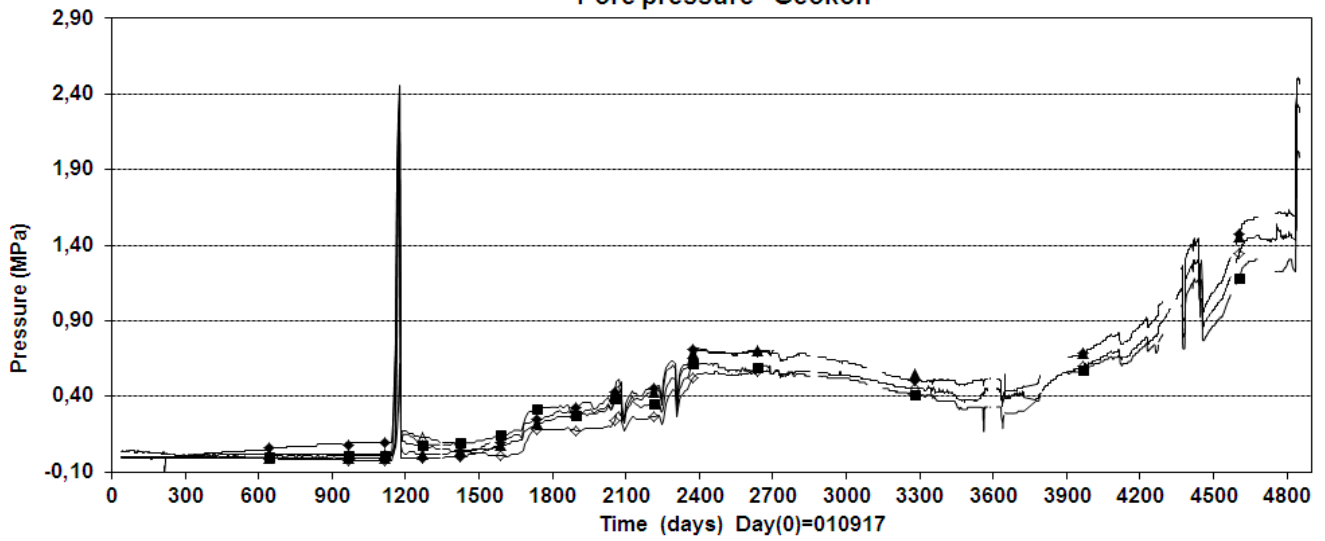


Prototype\Backfill\Section 1 (010917-20150101)  
Pore pressure - Geokon



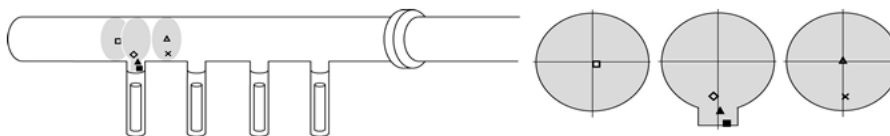
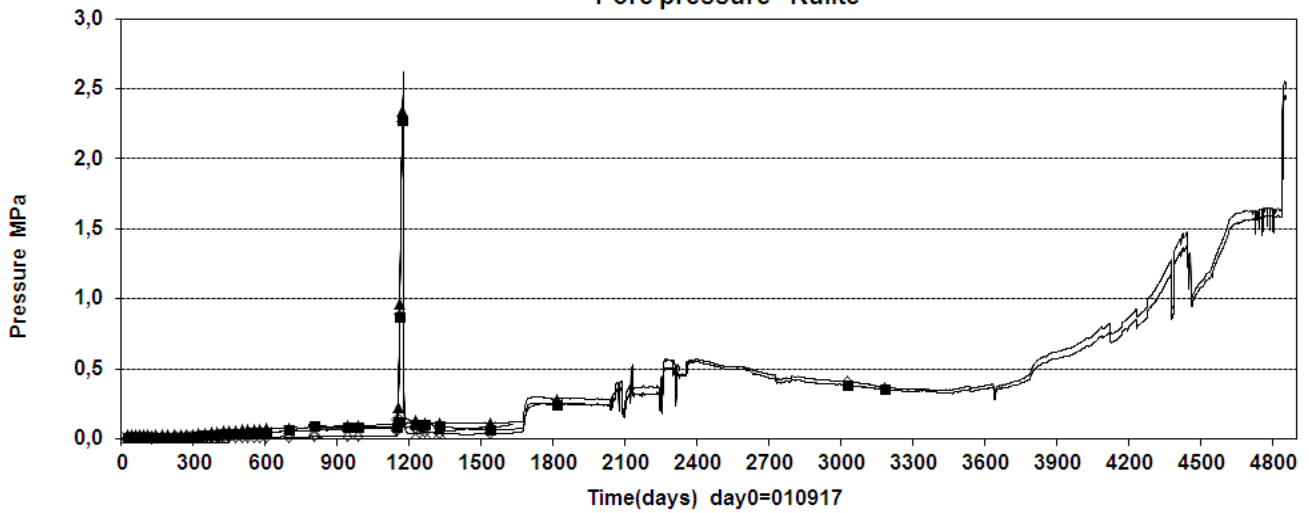
- |                                   |                                       |                           |
|-----------------------------------|---------------------------------------|---------------------------|
| ◇ UBA 10002 (Inner part\0\0\3592) | △ UBA 10003 (Inner part\0.2\0.1\3590) | ■ UBA 10004 (E1\0\0\3587) |
| ▲ UBA 10008 (E1\2.3\0\3587)       | ◆ UBA 10009 (E1\0\2.3\3587)           |                           |

PrototypelBackfill \ Section 1 (010917-20150101)  
Pore pressure - Geokon



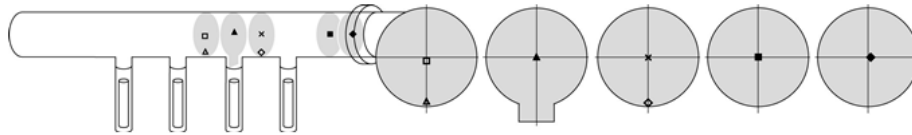
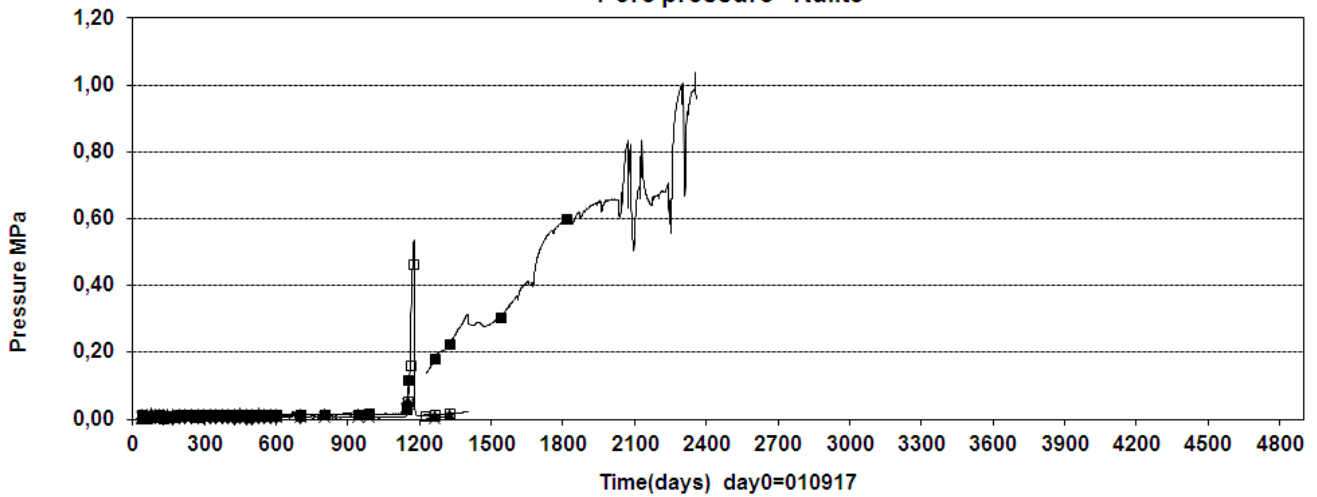
- ◇ UBA 10015(E3\0\1-1.82\3575)
- △ UBA 10016(E3\0.25\1-2.6\3575)
- UBA 10017(E3\0-0.1\1-3.1\3575)
- ▲ UBA 10018(E3\1-2.3\0\3575)
- ◆ UBA 10019(E3\0\0\3574)

PrototypelBackfill \ Section 1 (20010917-20150101)  
Pore pressure - Kulite



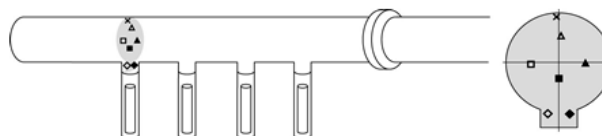
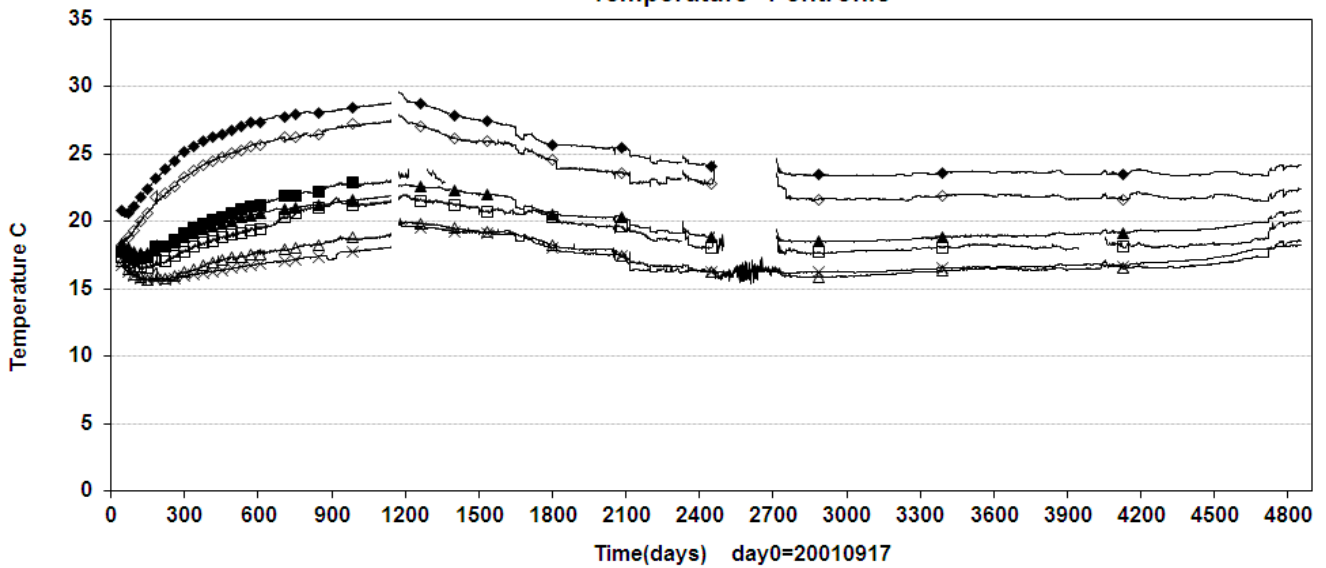
- UBA 10001(Inner part\0-0.2\1-0.1\3589)
- ◇ UBA 10005(E1\1-0.2\1-1.8\3587)
- ▲ UBA 10006(E1\0.1\1-2.6\3587)
- UBA 10007(E1\0.4\1-3.2\3587)
- △ UBA 10010(F1-2\0\0\3584)
- × UBA 10011(F1-2\0.1\1-1.2\3584)

Prototype\Backfill\Section 1 (20010917-20150101)  
Pore pressure - Kulite



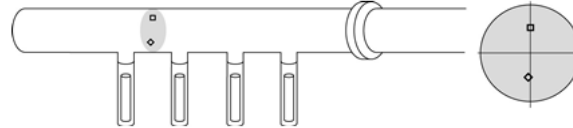
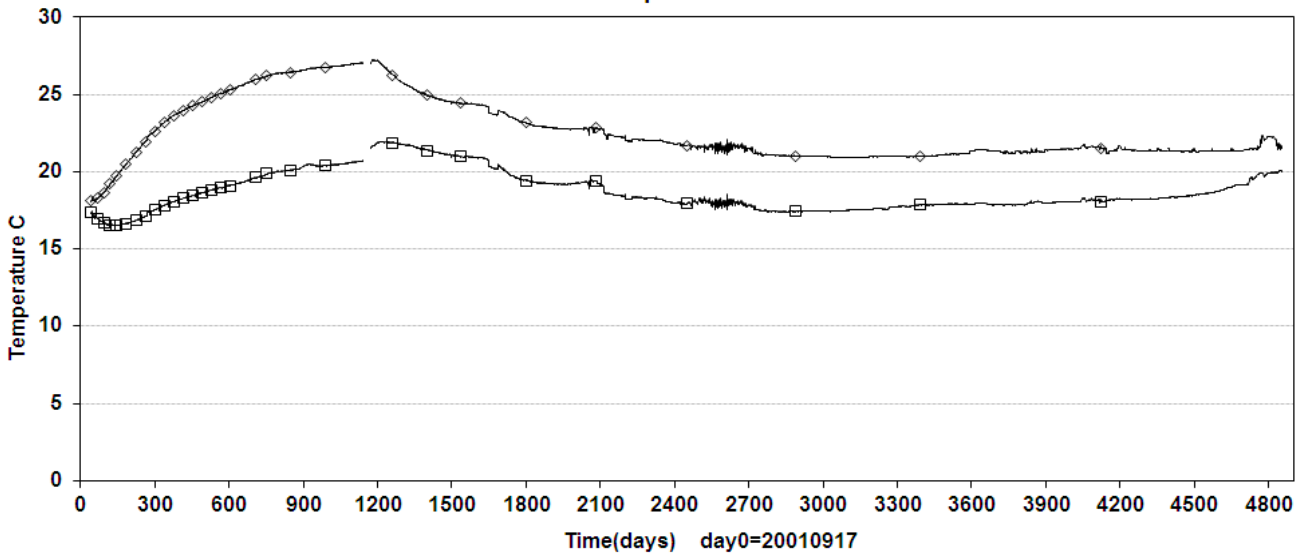
- |  |                                |  |
|--|--------------------------------|--|
| □ UBA 10012(F2-3\0\0-0.2\3578)           | △ UBA 10013(F2-3\0\0-2.3\3578) | ▲ UBA 10014(E3\0\0\3575)               |
| × UBA 10020(F3-4\0\0\3572)               | ◇ UBA 10021(F3-4\0\0-2.3\3572) | ■ UBA 10022(In front of plug\0\0\3565) |
| ◆ UBA 10023(In front of plug\0.1\0\3561) |                                |  |

Prototype\ Backfill \ Above dep.hole1 (20010917-20150101)  
Temperature - Pentronic



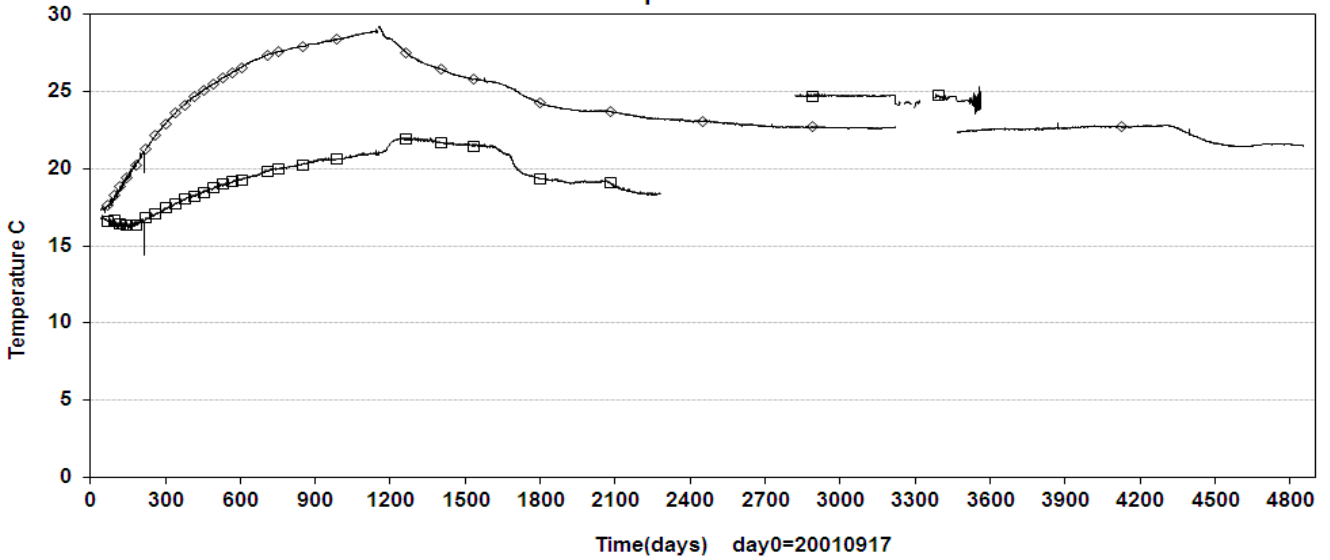
- |                                |                                |                              |
|--------------------------------|--------------------------------|------------------------------|
| □ TBA 10001(E1\1.25\0.1\3587)  | △ TBA 10002(E1\0.1\1.3\3587)   | ■ TBA 10003(E1\0\0.8\3587)   |
| ◇ TBA 10004(E1\0.5\1-2.6\3587) | ◆ TBA 10005(E1\0.5\1-2.6\3587) | × TBA 10006(E1\0.1\2.3\3587) |
| ▲ TBA 10007(E1\1.25\0.1\3587)  |                                |                              |

Prototype\ Backfill \ Between dep.hole 1-2 (20010917-20150101)  
Temperature - Pentronic



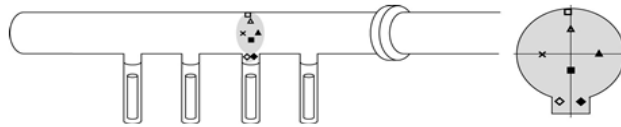
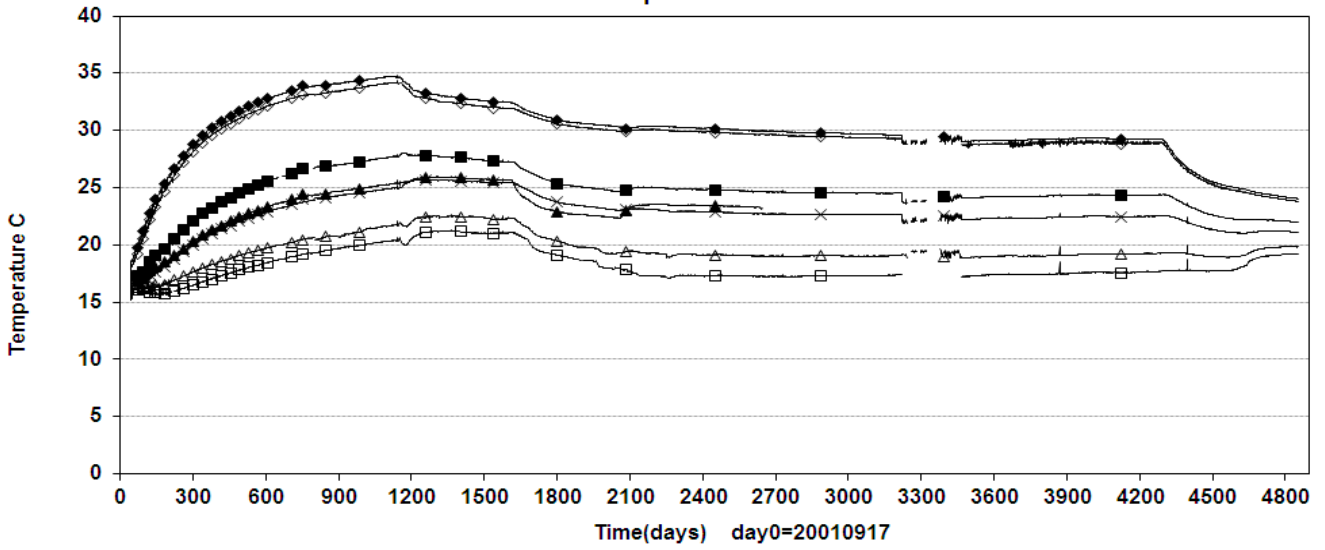
□ TBA10008(F1-2\0\1.25\3584)      ◇ TBA10009(F1-2\0-0.1\1-1.3\3584)

Prototype\ Backfill \ Between dep.hole 2-3 (010917-20150101)  
Temperature - Pentronic



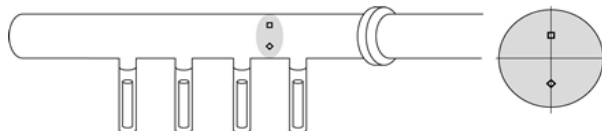
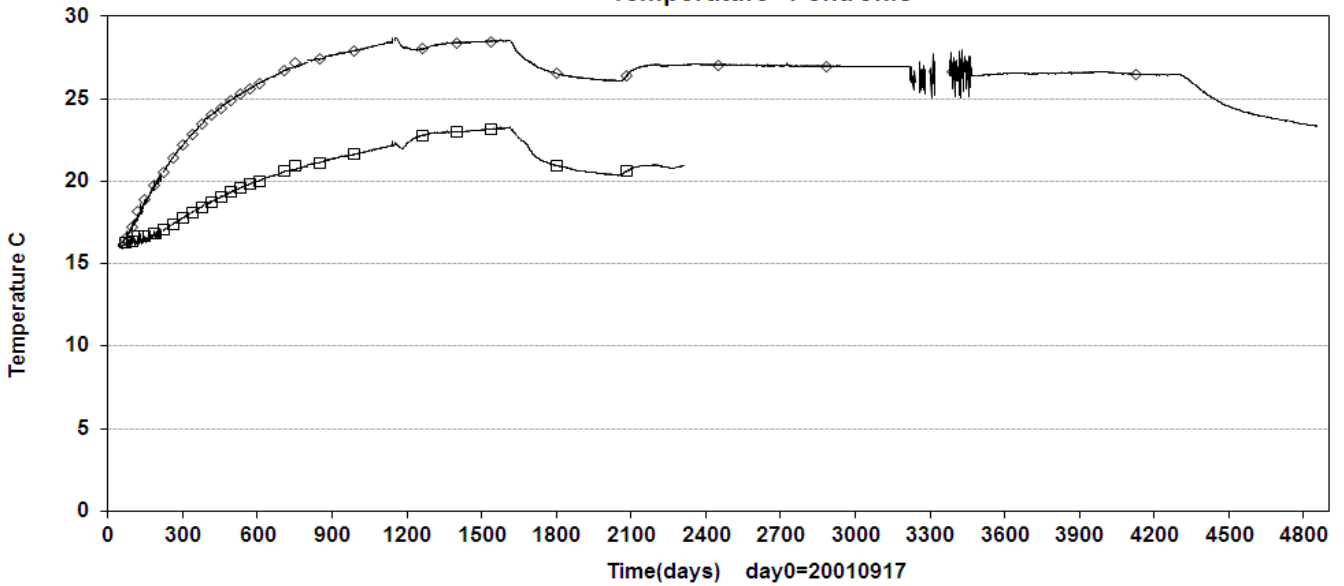
□ TBA10010(F2-3\0\1.15\3578)      ◇ TBA10011(F2-3\0\1-1.24\3578)

Prototype\ Backfill \ Above dep.hole3 (20010917-20150101)  
Temperature - Pentronic



- TBA 10012(E3\0-0.1\2.3\3575)    △ TBA 10013(E3\0\1.3\3575)    ■ TBA 10014(E3\0\0-0.9\3575)
- ◇ TBA 10015(E3\0-0.5\1-2.6\3575)    ◆ TBA 10016(E3\0.5\1-2.6\3575)    × TBA 10017(E3\1-1.3\0\3575)

Prototype\ Backfill \ Between dep.hole 3-4 (20010917-20150101)  
Temperature - Pentronic



- TBA 10019(F3-4\0\1.2\3572)    ◇ TBA 10020(F3-4\0\1-1.3\3572)



## Water pressure measurements in the rock mass

### A5.1 Introduction

The hydraulic properties of the rock, geometry of tunnels and deposition holes, water pressure far away from the tunnels and the hydro-mechanical properties of the backfill and buffer govern the saturation of the buffer and backfill. It is important to measure the water pressure in the rock for the interpretation of the measurements in the buffer and backfill and to sample data useful for the modelling of the saturation process.

This appendix presents the still on-going (2015) measurements in section I. Section II has been dismantled during 2011 and pressure measurements are no longer performed there. Any earlier measurements are presented in Goudarzi (2015).

### A5.2 Measurements in the boreholes

A large number of boreholes are instrumented with one or several packers. In all packed-off sections, the water pressure is measured. Each borehole section is connected to a tube of polyamide that via lead-through holes ends in the G-tunnel. All pressure transducers are placed in the G-tunnel to facilitate easy calibration and exchange of transducers that are out of order. The transducers are connected to the HMS system at Äspö Laboratory and it is a flexible system for changing the logging frequency. The maximum scan frequency is 1/second. During periods with no hydraulic tests, preliminary the logging (storing a value in the data base) frequency is 2/hour with an automatic increase of the sampling frequency if the pressure change since last registration is larger than 2 kPa. During hydraulic tests, the sampling frequency is up to 1 logging every 3rd second (maximum logging rate possible).

All data now shown in plots are quality verified data from the SICADA database, which is a change from earlier reports when data was collected from the HMS system itself.

### A5.3 Instrumentation with bentonite packers in section I

Section I will be in operation for a long time, possibly up to 20 years, and there will be no access to the instruments in the boreholes for a long period. It was decided to develop a new type of packer that was not dependent of an external pressure to seal-off the borehole sections. These packers are made of compacted bentonite with rubber coverage. For chemical reasons the bentonite is not allowed to be in contact with the surrounding water in the rock mass and therefore the packers have a cover made of polyurethane (PUR-rubber). This rubber also protected the packers against unwanted wetting during transport and installation. After installing all packers in a borehole, the compacted bentonite was wetted to make it swell and expanded against the borehole wall. This packer system is used in 14 boreholes with a length between 12 and 50 meters in the tunnel floor and the walls (see Rhén et al. 2001).

Due to the expected high temperature near the deposition holes two boreholes (KA3574A and KA3576A) were equipped with stainless steel pipes instead of polyamide tubes.

In some sections used for circulation or hydrochemistry sampling purposes in section I, a dummy is installed to reduce the water-filled volume of the section. Depending on the purpose the dummies were made either by high-density polyethylene (circulation sections) or PEEK (hydrochemistry sections) material. The dummy consists of two parts, positioned around the centre rod.

The packers were inserted into the borehole with  $\varnothing$  20 mm massive stainless steel rods. A special designed manual-hoisting rig was used to insert the equipment into the boreholes. When the packers were at their correct position the equipment was attached to a locking device mounted on the tunnel wall at the borehole collar. Before insertion, the equipment was cleaned with a cleaner delivering hot steam (100 °C) at high pressure.

The instrument configuration for the boreholes provided with bentonite packers is summarised in Table A5-1 and illustrated in Figures A5-1 and A5-2.

**Table A5-1. Instrumentation configuration in section I. “Lead-through”: pipes between the packers.**

Borehole:sec	Sec. length (m)	Type of section	Type of dummy	Packer length	Lead-through (no:diameter:type)
KA3563G:1	15–30.01	P		2 m	1:6/4:PA
KA3563G:2	10–13	P		2 m	2:6/4:PA
KA3563G:3	4–8	P		1 m	3:6/4:PA
KA3563G:4	1.5–3	P, C	HD	1 m	6:6/4:PA
KA3566G01:1	23.5–30.01	P		2 m	1:6/4:PA
KA3566G01:2	20–21.5	P, C	HD	2 m	4:6/4:PA
KA3566G01:3	12–18	P		2 m	5:6/4:PA
KA3566G01:4	7.3–10	P		1 m	6:6/4:PA
KA3566G01:5	1.5–6.3	P, F		1 m	8:6/4:PA
KA3566G02:1	19–30.1	P		1 m	1:6/4:PA
KA3566G02:2	16–18	P, C	HD	2 m	4:6/4:PA
KA3566G02:3	12–14	P		1 m	5:6/4:PA
KA3566G02:4	8–11	P		2 m	6:6/4:PA
KA3566G02:5	1.3–6	P, F		1 m	8:6/4:PA
KA3572G01:1	7.3–12.03	P		2 m	1:6/4:PA
KA3572G01:2	2.7–5.3	P, C	HD	2 m	4:6/4:PA
KA3573A:1	26–40.07	P		2 m	1:6/4:PA
KA3573A:2	21–24	P, F		2 m	3:6/4:PA
KA3573A:3	14.5–19	P		2 m	4:6/4:PA
KA3573A:4	10.5–12.5	P, F		2 m	6:6/4:PA
KA3573A:5	1.3–8.5	P		1 m	7:6/4:PA
KA3574G01:1	8–12.03	P		1 m	1:6/4:ST
KA3574G01:2	5.1–7	P		1 m	2:6/4:ST
KA3574G01:3	1.8–4.1	P, C	HD	1 m	5:6/4:ST
KA3576G01:1	8–12.01	P		2 m	1:6/4:ST
KA3576G01:2	4–6	P, HC	PE	1 m	2:6/4:ST, 1:1/8"/2:PE
KA3576G01:3	1.3–3	P		1 m	3:6/4:ST, 1:1/8"/2:PE
KA3578G01:1	6.5–12.58	P		1 m	1:6/4:PA
KA3578G01:2	4.3–5.5	P, HC	PE	2 m	2:6/4:PA, 1:1/8"/2:PE
KA3579G:1	14.7–22.65	P		1 m	1:6/4:PA
KA3579G:2	12.5–13.7	P		1 m	2:6/4:PA
KA3579G:3	2.3–11.5	P		2 m	3:6/4:PA
KA3584G01:1	7–12	P		2 m	1:6/4:PA
KA3584G01:2	1.3–5	P		1 m	2:6/4:PA
KA3590G01:1	16–30	P		1 m	1:6/4:PA
KA3590G01:2	7–15	P, F, F		1 m	4:6/4:PA
KA3590G01:3	1.3–6	P, HC		1 m	5:6/4:PA, 1:1/8"/2:PE
KA3590G02:1	25.5–30.01	P, F		2 m	2:6/4:PA
KA3590G02:2	15.2–23.5	P		2 m	3:6/4:PA
KA3590G02:3	11.9–13.2	P, HC	PE	2 m	4:6/4:PA, 1:1/8"/2:PE
KA3590G02:4	1.3–9.9	P		1 m	5:6/4:PA, 1:1/8"/2:PE
KA3593G:1	25.2–30.02	P		1 m	1:6/4:PA
KA3593G:2	23.5–24.2	P, HC	PE	1 m	2:6/4:PA, 1:1/8"/2:PE
KA3593G:3	9–22.5	P		2 m	3:6/4:PA, 1:1/8"/2:PE
KA3593G:4	3–7	P, F		2 m	5:6/4:PA, 1:1/8"/2:PE
KA3600F:1	43–50.1	P		1 m	1:6/4:PA
KA3600F:2	40.5–42	P, HC	PE	1 m	2:6/4:PA, 1:1/8"/2:PE
KA3600F:3	20–39.5	P		2 m	3:6/4:PA, 1:1/8"/2:PE
KA3600F:4	1.3–18	P		1 m	4:6/4:PA, 1:1/8"/2:PE

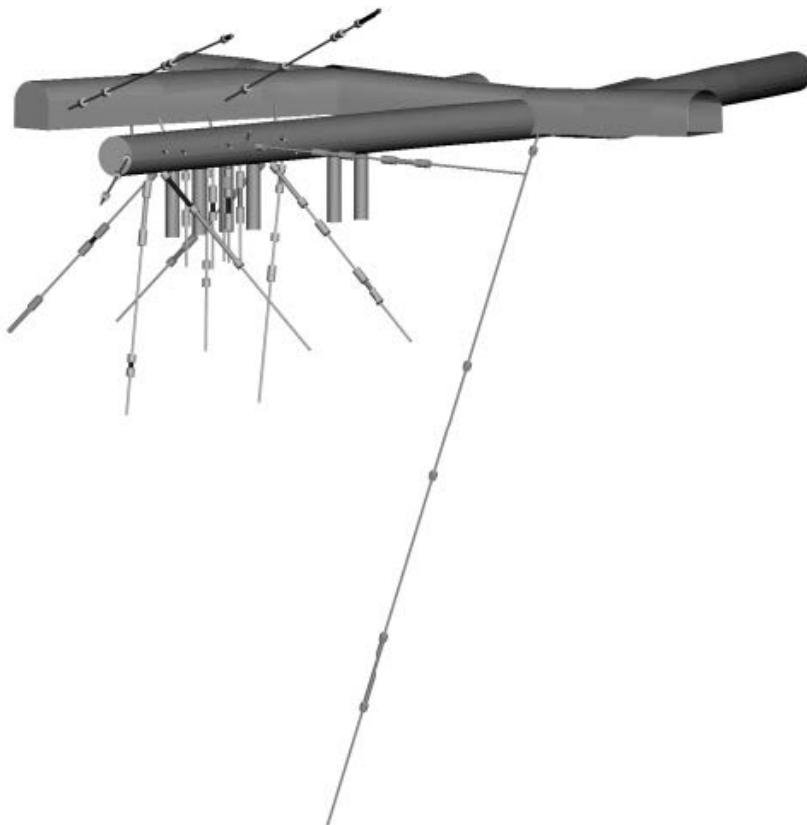
Borehole:sec	Sec. length (m)	Type of section	Type of dummy	Packer length	Lead-through (no:diameter:type)
KA3510A:1	125–150	P		1 m	1:6/4:PA
KA3510A:2	110–124	P, F		1 m	3:6/4:PA
KA3510A:3	75–109	P		1 m	4:6/4:PA
KA3510A:4	51–74	P		1 m	5:6/4:PA
KA3510A:5	4.5–50	P		1 m	6:6/4:PA
KG0021A01:1	42.5–48.82	P, HC		1 m	1:6/4:ST, 1:1/8"/2:PE
KG0021A01:2	37–41.5	P		1 m	2:6/4:PA, 1:1/8"/2:PE
KG0021A01:3	35–36	P, C	HD	1 m	5:6/4:PA, 1:1/8"/2:PE
KG0021A01:4	19–34	P		1 m	6:6/4:PA, 1:1/8"/2:PE
KG0021A01:5	5–18	P		1 m	7:6/4:PA, 1:1/8"/2:PE
KG0048A01:1	49–54.69	P, HC		1 m	1:6/4:ST, 1:1/8"/2:PE
KG0048A01:2	34.8–48	P		1 m	2:6/4:PA, 1:1/8"/2:PE
KG0048A01:3	32.8–33.8	P, C	HD	1 m	5:6/4:PA, 1:1/8"/2:PE
KG0048A01:4	13–31.8	P		1 m	6:6/4:PA, 1:1/8"/2:PE
KG0048A01:5	5–12	P		1 m	7:6/4:PA, 1:1/8"/2:PE

Type of section:

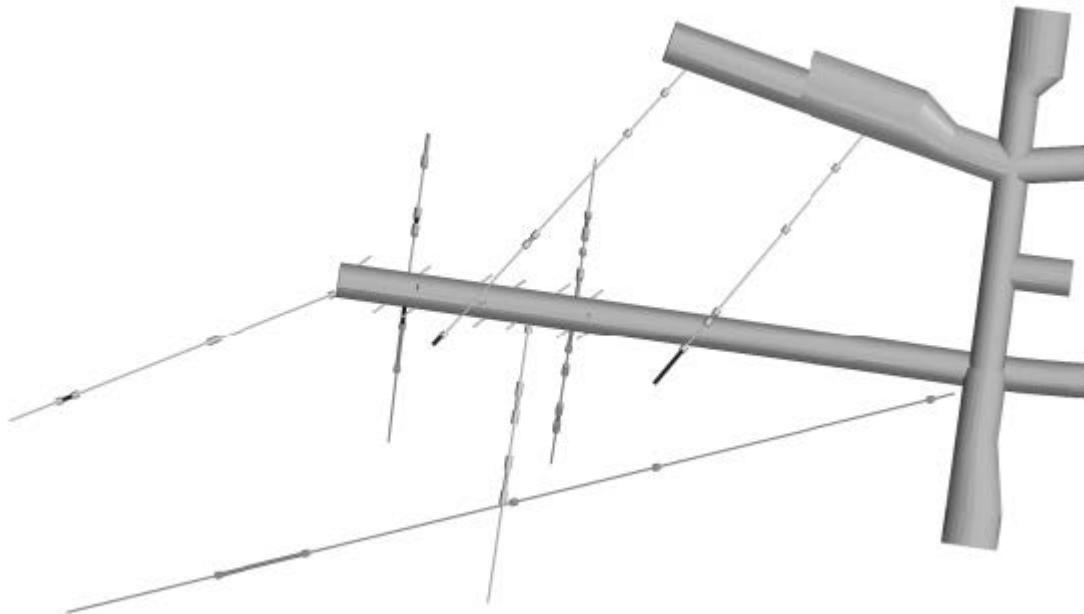
P Pressure measurement  
C Circulation possible  
HC Hydrochemistry sampling  
F Flow

Materials:

PA Polyamide  
ST Steel  
PE PEEK  
HD HD1000 (High Density Polyethylene)



**Figure A5-1.** View of the drilled core holes in the Prototype Repository section I. The length from the I-tunnel to the end of the TBM-tunnel is 90 m. The diameter of the TBM tunnel is 5 m and the diameter of the deposition holes is 1.75 m. The depth of the deposition holes is 8.37 m in the centre and 8.15 m along the deposition hole wall. The diameter of the core holes is 76 mm except for the short core holes in the roof of the TBM tunnel that have a diameter of 56 mm. The monitoring boreholes used in the presentation in this report are located in the inner part of the tunnel surrounding the area with the four innermost canister holes. Also included are two holes drilled from the G-tunnel and the long hole KA3510A drilled from the main tunnel.



*Figure A5-2. Overview of section I in Prototype Repository.*

#### **A5.4 Instrumentation with mechanical packers**

In section 1 sixteen short boreholes (2 m) in the tunnel roof and walls are equipped with mechanical packers, see Table A5-2. After insertion into the hole, the pulling of a nut on the centre pipe expanded the packer. Since these holes are directed upwards, the de-aeration required an extra lead-through connected to a tube ending in the innermost part of the borehole. The de-aeration was made during the backfilling and in boreholes with very little flow the de-aeration was made by filling water through the outer tube.

**Table A5-2. Boreholes instrumented with mechanical packers (“Inclination”: inclination of the borehole).**

<b>Borehole</b>	<b>Borehole length (m)</b>	<b>Inclination (°)</b>
KA3563A01	2.06	-7.7
KA3563D01	approx. 2	2.8
KA3563I01	2.15	73
KA3566C01	2.1	3.5
KA3568D01	2.3	-2.3
KA3573C01	2.05	34.9
KA3574D01	2.05	12.6
KA3578C01	2.09	-5.4
KA3578H01	1.9	59.1
KA3579D01	2	-1
KA3588C01	2.04	-4
KA3588D01	1.9	-1.8
KA3588I01	1.96	65.6
KA3592C01	2.1	4.4
KA3597D01	2.22	3.1
KA3597H01	2.06	55.1

## A5.5 Calibration intervals

Recalibration of pressure transducers are made a couple of times every year.

## A5.6 Pressure measurements

In this section pressure measurement of all monitored holes in the Prototype repository is shown in plots below. The pressure values plotted are daily mean values. The definition of day 0 is the day the heating of canister 1 started, i.e. 2001-09-17. In Table A5-3 the dates of the starting of the heaters in section 1 are presented.

**Table A5-3. Heaters in canisters.**

Canister in deposition hole	Started	Stopped
1 (DA3587G)	2001-09-17	
2 (DA3581G)	2001-09-24	2004-12-01
3 (DA3575G)	2001-11-10	
4 (DA3569G)	2001-11-24	

The position of pressure measurement is indicated for all observation sections.

In general sections close to the prototype rock wall indicate lower pressure head than further away from the prototype.

In the longer holes the section closest to the wall has a lower head than sections deeper into the rock mass.

A pressure drop 2002-05-07 for most of the observation sections are shown in the plots. The most major pressure change happens in the lowest section of KA3566G02 (approx. 70 m) but are also clearly visible for section 2–4 of the same borehole. The pressure recovered during the evening of 2002-12-02. The cause for the pressure change is unknown.

Several sections have had a slight decreasing trend since the summer of 2002. This trend was in most cases discontinued after 2004-11-01 when the draining of section I was closed down.

During the period 2003-05-08 until 2003-05-15 a total of 19 hydraulic tests (TC 1) were done in several of the boreholes in section I and II. The tests caused groundwater pressure interference in the whole of the prototype repository area. Since the tests were mostly short-time tests it is only shown in some of the borehole section plots.

During the summer 2003 (2003-07-13 to 2003-08-05) no pressure data was recorded. In some of the long boreholes inclined to the south of the prototype show a pressure drop in mid-August.

Hydraulic single hole tests were done in nine boreholes during 2003-10-21 to 2003-10-23 (TC 2). The tests caused groundwater pressure interference in the whole of the prototype repository area. Since the tests were mostly short-time tests it is only shown in some of the borehole section plots.

Hydraulic single hole tests were done in eight boreholes during 2004-02-02 to 2004-02-04 (TC 3). The tests caused groundwater pressure interference in the whole of the prototype repository area. Since the tests were mostly short-time tests it is only shown in some of the borehole section plots.

A pressure drop of around 700 kPa in KA3566G01:4 is observed 2004-02-25. It remained so for some weeks before recovering, but dropped again in May and remains that way at the end of the month. This pattern was observed in this section during the spring 2003. The following investigation showed a faulty data-scan coupling (corrosion) which was replaced 2004-08-10.

Hydraulic single hole tests were done in eight boreholes during 2004-08-11 to 2004-08-18 (TC 4). The tests caused groundwater pressure interference in the whole of the prototype repository area. Since the tests were mostly short-time tests it is only shown in some of the borehole section plots.

During the period 2005-01-19 until 2005-01-28 a total of 26 hydraulic tests (TC 5) were done in several of the boreholes in section I and II. The tests caused groundwater pressure interference in the whole of the prototype repository area. Since the tests were mostly short-time tests it is only shown in some of the borehole section plots.

During week 36, starting 2005-09-05, several boreholes have a rather sudden drop in pressure which does not recover immediately. The reason is not known yet.

Hydraulic single hole tests were done in eight boreholes during 2005-11-28 to 2005-12-02 (TC 6). A total of 17 tests were done. The tests caused groundwater pressure interference in the whole of the prototype repository area. Since the tests were mostly short-time tests it is only shown in some of the borehole section plots.

In KA3573A the pressure in section 3 suddenly decreases around 200 kPa 2006-02-12/13. This is the initial phase as it turned out later, see below, of the total pressure loss of that section.

In KA3566G01 sections 2 and 3, and 4 and 5 respectively are short-cut from 2006-03-03. The reason is not known.

A pressure drop in several borehole sections on the south side of the prototype repository is observed from approximately 2006-04-18. At the same time the drainage from section 1 increases from 1.5 to 9 L/min. Section KA3573A:3 which lost most of its pressure head is believed to lead groundwater, together with sections KA3573A:2 and KA3573A:4, into the section 1 backfill. In earlier investigations this borehole had flow rates over 50 L/min (Rhén and Forsmark 2001). The following borehole/sections are affected by this pressure drop event: KA3510A:3–5, KA3566G01:1, KA3573A:2–4, KA3590G01:1–2, KG0021A01:1–4 and KG0048A01:1–4. The pressure decrease is probably a result of a leaking tube or a tube coupling from KA3573A:3. The pressure in KA3573A:3 is now at the same level as the pressure in the backfill (around 500 kPa).

Hydraulic single hole tests were done in eight boreholes during 2006-09-25 to 2006-09-29 (TC 7). A total of 17 tests were done. The tests caused groundwater pressure interference in the whole of the prototype repository area. Since the tests were mostly short-time tests it is only shown in some of the borehole section plots.

In November/December 2006, dilution measurements were made KA3563G:4, KA3566G01:2, KA3566G02:2, KA3572G01:2, KA3574G01:3, KG0021A01:3 and KG0048A01:3.

The work with excavating a new tunnel niche from I-niche, for sealing experiments, commenced in March 2007. The project is called “Sealing of Tunnel at Great Depth”. Since it is situated rather close to the Prototype Repository it is expected to influence the pressure levels around the prototype.

During the period March–December 2007, the drilling and testing of three boreholes in niche I, KI0010B01, KI0014B01 and KI0016B01 causes major pressure head fluctuations in most of the observation sections in the prototype repository. The overall groundwater head level decreases during this period but late in the period seems to recover. The new boreholes are drilled within the project “Sealing of Tunnel at Great Depth”.

The pressure transducers in KA3510A were taken out of operation 2007-08-20. The reason is the on-going tunnel construction works in the I-niche. They were taken in operation again in August 2008.

KA3566G02 transducers do not seem to work properly since the start of the “Sealing of Tunnel at Great Depth” project in the summer of 2007.

Hydraulic single hole tests were done in eight boreholes during 2007-10-15 to 2007-10-19 (TC 8). A total of 17 tests were done. The tests caused some groundwater pressure interference in the prototype repository area.

The pressure in KA3574G01:2 suddenly start rising from 2008-08-30.

Hydraulic single hole tests were done in eight boreholes during 2008-10-20 to 2008-10-24 (TC 9). A total of 17 tests were done.

Fan grouting was done in the project “Sealing of Tunnel at Great Depth” during several periods during the spring 2009.

There is a sudden pressure decrease in KA3510A:1 and KA3510A:2 2009-04-16 which last until 2009-05-07.

No pressure recordings are made in HMS between 2009-05-23 and 2009-06-11.

During the period 2009-11-09 until 2009-11-19 six interference-tests (TC 10) were done in boreholes KA3539G:2, KA3542G02:5, KA3554G01:2, KA3590G02:1, KG0021A01:3 and KG0048A01:3. Flowing periods were 6 hours for each of the boreholes.

The general pressure trend is decreasing pressures since January 2008.

Pressure increases occurs KA3588C01:1 and KA3588D01 during the months of January and February 2010. It decreases after a while. The reason is unknown.

Preparations for demolition of the outer plug, section II, started at the end of November 2010. During 2010-11-23 and 2010-11-24 groundwater sampling is made from several boreholes within the prototype section I and II. A pressure decrease is clearly seen in the plots for several of the observation sections in both sections.

Demolition work of the outer plug of section II started during December 2010 and was finalized during February 2011. The work was done by drilling several boreholes into the concrete plug continued by mechanical impact with a hydraulic hammer and a hydraulic breaker. All demolition work in the tunnel section II was finalized by 2011-12-15.

The boreholes in section I closest to the plug between section I and II show an obvious pressure drop during 2011 due to the demolition of section II. The pressure recovers during 2012.

The pressure recovery has continued during 2013 and 2014.

A pressure drop occurs in the period close to 2013-11-01 in almost all of the remaining borehole-sections of the Prototype section I. The reason for this remains unknown so far.

In December 2014 work with replacing packers in multi-section borehole from section II is done. The boreholes that have their packers replaced with a single mechanical packer are KA3539G, KA3542G01, KA3542G02, KA3548G01, KA3554G01, KA3554G02 and KA3557G. The pressure in most of the borehole sections in section I responds with a very fast pressure increase shown in the pressure diagrams. This pressure increase seems to be permanent (June 2015).

In Table A5-4 the pressure sensor status 2015-01-01 is estimated based on pressure head data.

**Table A5-4. Apparent pressure sensor status.**

Borehole:sec	Secup (m)	Seclow (m)	Pressure status 2015-01-01	Comment
KA3510A:1	125.00	150.00	OK	
KA3510A:2	110.00	124.00	OK	
KA3510A:3	75.00	109.00	OK	
KA3510A:4	51.00	74.00	Not OK	Pressure very low since June 2010
KA3510A:5	4.50	50.00	OK	
KA3563A01:1	0.65	2.06	OK	
KA3563D01:1	0.65	2.01	OK	
KA3563G:1	15.00	30.01	OK	
KA3563G:2	10.00	13.00	OK	
KA3563G:3	4.00	8.00	OK	
KA3563G:4	1.50	3.00	OK	
KA3563I01:1	0.65	2.15	OK	
KA3566C01:1	0.65	2.1	OK	
KA3566G01:1	23.50	30.01	OK	
KA3566G01:2	20.00	21.50	OK	
KA3566G01:3	12.00	18.00	OK	
KA3566G01:4	7.30	10.00	Not OK	Shortcut between sections 4 and 5
KA3566G01:5	1.50	6.30	Not OK	Shortcut between sections 4 and 5
KA3566G02:1	19.00	30.10	Not OK	Pressure drop May 2007. All sections shortcut!
KA3566G02:2	16.00	18.00	Not OK	Pressure drop May 2007. All sections shortcut!
KA3566G02:3	12.00	14.00	Not OK	Pressure drop May 2007. All sections shortcut!
KA3566G02:4	8.00	11.00	Not OK	Pressure drop May 2007. All sections shortcut!
KA3566G02:5	1.30	6.00	Not OK	Pressure drop May 2007. All sections shortcut!
KA3568D01:1	0.65	2.30	OK	
KA3572G01:1	7.30	12.03	OK	
KA3572G01:2	2.70	5.30	OK	
KA3573A:1	26.00	40.07	Not OK	Probable tube failure in section 3
KA3573A:2	21.00	24.00	Not OK	Probable tube failure in section 3
KA3573A:3	14.50	19.00	Not OK	Probable tube or tube coupling failure
KA3573A:4	10.50	12.50	Not OK	Probable tube failure in section 3
KA3573A:5	1.30	8.50	Not OK	Probable tube failure in section 3
KA3573C01:1	0.65	2.05	OK	
KA3574D01:1	0.65	2.05	OK	
KA3574G01:1	8.00	12.03	OK	
KA3574G01:2	5.10	7.00	Not OK?	Sudden pressure increase 2008-08-30
KA3574G01:3	1.80	4.10	OK	
KA3576G01:1	8.00	12.01	OK	
KA3576G01:2	4.00	6.00	Not OK?	Pressure decrease starting Jan. 2009
KA3576G01:3	1.30	3.00	OK	
KA3578C01:1	0.65	2.09	OK	
KA3578G01:1	6.50	12.58	OK?	Shortcut between sections
KA3578G01:2	4.30	5.50	OK?	Shortcut between sections
KA3578H01:1	0.65	1.90	OK	
KA3579D01:1	0.65	2.00	Not OK	Air in borehole section?



Borehole:sec	Secup (m)	Seclow (m)	Pressure status 2015-01-01	Comment
KA3579G:1	14.70	22.65	OK?	Shortcut between sections
KA3579G:2	12.50	13.70	OK?	Shortcut between sections
KA3579G:3	2.30	11.50	Not OK	Air in borehole section?
KA3584G01:1	7.00	12.00	OK	
KA3584G01:2	1.30	5.00	OK	
KA3588C01:1	0.65	2.04	OK	
KA3588D01:1	0.65	1.90	Not OK	Not in operation any longer?
KA3588I01:1	0.65	1.96	OK	
KA3590G01:1	16.00	30.00	Not OK?	Shortcut between sections.
KA3590G01:2	7.00	15.00	Not OK?	Shortcut between sections.
KA3590G01:3	1.30	6.00	OK	
KA3590G02:1	25.50	30.01	OK	
KA3590G02:2	15.20	23.50	OK	
KA3590G02:3	11.90	13.20	OK	
KA3590G02:4	1.30	9.90	OK	
KA3592C01:1	0.65	2.01	Not OK?	Air in borehole section?
KA3593G:1	25.20	30.02	Not OK	Very low pressure in section
KA3593G:2	23.50	24.20	OK	
KA3593G:3	9.00	22.50	OK	
KA3593G:4	3.00	7.00	OK	
KA3597D01:1	0.65	2.22	Not OK?	Air in borehole section?
KA3597H01:1	0.65	2.06	OK	
KA3600F:1	43.00	50.10	OK	
KA3600F:2	40.50	42.00	OK	
KA3600F:3	20.00	39.50	OK	
KA3600F:4	1.30	18.00	OK	
KG0021A01:1	42.50	48.82	OK	
KG0021A01:2	37.00	41.50	OK	
KG0021A01:3	35.00	36.00	OK	
KG0021A01:4	19.00	34.00	OK	
KG0021A01:5	5.00	18.00	OK	
KG0048A01:1	49.00	54.69	OK	
KG0048A01:2	34.8	48	OK	
KG0048A01:3	32.80	33.80	OK	
KG0048A01:4	13.00	31.80	OK	
KG0048A01:5	5.00	12.00	OK	

### A5.7 Drainage of section I

The drainage system in section I was shut down 2004-11-01. It resulted in a major pressure increase in most borehole sections close to the prototype tunnel. The pressure increased until 2004-12-06.

The drained water amount was approximately 2.5 L/min. The flow rate of weir MG0004G decreased accordingly with the same order of magnitude after November 1.

The drainage system was re-opened 2004-12-06 due to electrical problems with the canister heaters. It is still open (2015-05-06). The pressure in most borehole sections within section I decreased rapidly again after the re-opening.

In mid-April 2006 the flow rate from section I rather suddenly increase to 9 L/min, while pressure decreases in several boreholes on the south side of the prototype. This is a result of tube failure in borehole section KA3573A:3.

The flow rate from section I was still around 9 L/min at the end of 2010.

The flow during the period 2010–2014 decreases through weir MG0004G. This can be observed in the flow diagrams below. No measurement data of the drainage flow is available during this period, but a measurement made 2015-05-06 show a drainage flow of 0.16 L/min which is considerably lower than earlier.

## **A5.8 Flow measurements**

Earlier estimations and measurements of in-leaking ground water amounts to the tunnel system are presented in Forsmark et al. (2001) and Rhén and Forsmark (2001).

Data from eleven flow weirs are presented in this data report, out of which six is currently (2015) in operation but some of these have been maintained and has not been recalibrated calibrated yet.

A weir at the tunnel G opening measures the leaking-in amounts from this tunnel. The weir was taken in operation in January 2002-01-21 and is named MG0004G. The water from MG0004G is led to PG5. The pumped water amounts from section I mentioned above was prior to November 1, 2004, when the drainage of section I was closed down, included in the rates from this weir station which is clearly shown in the diagram below. The packer or tube failure of KA3573A:3 2006-04-18 resulted in an increase of water being drained from section I due to the fact that groundwater in the rock got contact with the backfill in section I via the borehole. Until the beginning of 2006 the trend was decreasing. The weir has been replaced with a new one in November 2014 and flow measurements will commence during the autumn 2015.

The weir MF0061G halfway down tunnel F measures today the in-leaking amounts from the first half of tunnel F, see plot of this weir. Earlier, until autumn 2001, in-leaking water from tunnel G was led to tunnel F and weir MF0061G thereby to some extent explaining the high flow rate during that period. The in-leaking water in tunnel J+ is included in the flow rate of MF0061G.

The weir MA3426G measures the flow rates from the south part of tunnel J and tunnel at chainage 3 426–3 514 m. Until December 2003 the in-leaking amounts from tunnel section 3 515–3 600 was included in the presented flow rate. The in-leaking water in tunnel I is included in this weir's flow rate.

In December 2003 three new flow measurement weirs were constructed in the A-tunnel outside section II plug. They are called MA3515G, MA3525G and MA3535G (in operation 2003-12-10). The water from these three weirs is led to MA3426G. Continuous measurement is done since the spring of 2004. Manual measurements done in December 2003 show a flow rate for MA3515G of 0.175–0.19 L/min, for MA3525G of 1.15–1.25 L/min and for MA3535G of 0.38–0.45 L/min. The increase of flow during October 2004 was caused by yet unknown causes, but it is believed that the final grouting that was done around Plug 2 October 8, 2004 is the cause to it. The flow rates have now decreased once again.

Two weirs have, during the winter 2004/2005, been constructed inside niches I and J+. They are called MI0008G (in operation 2005-01-20) and MJ0033G (in operation 2005-01-20) respectively. The water from MI0008G is led to MA3426G. The water from MJ0033G is led to MF0061G. MI0008G is included in the continuously measurement program (HMS) while MJ0033G is measured manually approximately every fortnight. The readings from MI0008G have however not been correct since August 2005 and therefor no readings are presented since then. Manual readings will be made in the future. A manual reading 2006-06-26 shows a flow of 2.85 L/min which is within the same order of magnitude as the flow readings of the pre-August 2005 period.

MI0008G was plugged 2007-08-02 during the preparations of the construction of Tunnel S which will start inside niche I and the water is led to MA3426G.

The automatic registration of flow in MA3515G, MA3525G and MA3535G were cancelled during autumn 2007 due to the on-going tunnel construction work in the I-niche. The registration was resumed in April 2008 and continued until November 2010 when preparation started for the demolishing work of Prototype section II.

No measurement of the flow into the A-tunnel from the intersection with tunnel I-J and the inner prototype plug is made today (2014). An attempt to construct a measurement weir 4–7 meters from the plug was made a couple of years ago (2012?) but the flow was very low and was not possible to quantify with the methodology available.

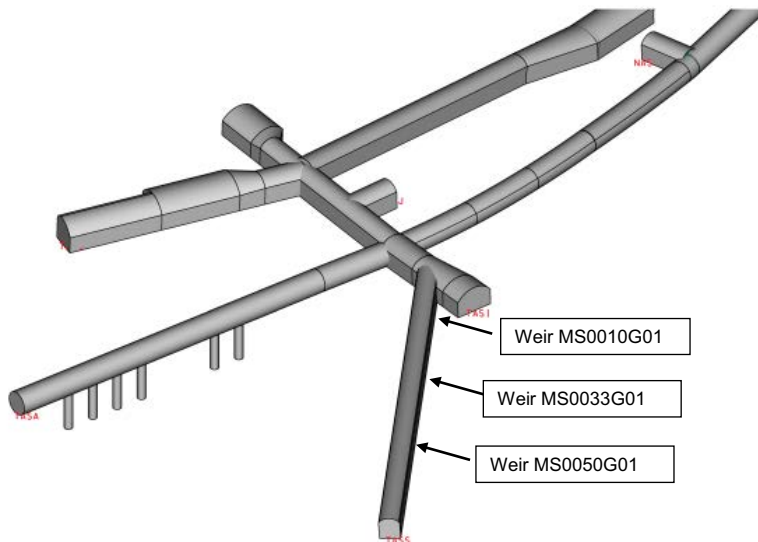
The flow rate in MA3426G has been extremely high during the period June until November 2007. This is due to that in-leaking water from the new boreholes KI0010B01 and KI0016B01 together with the water previously measured in MI0008G is led to MA3426G. A single rate measurement 2007-10-18 gives a flow rate from KI0010B01 of 44 L/min and from KI0016B01 of 7 L/min.

The pre-investigations for TASS resulted in major in-leaking amounts through the three long core holes drilled in the planned direction of TASS. During this period the in-leaking accumulated initial flow rates from the three boreholes was approximately 230 L/min, but the overall flow rate during the period until they were grouted was approximately 65 L/min which is the increase of flow in weir MA3426G where the water was directed.

Three weirs are located within the TASS-tunnel and their locations are shown in Figure A5-3 below, measuring the flow into sections 10–33 m, 33–50 m and 50–80.7 m respectively.

### A5.9 Water sampling

Water sampling for chemical analysis have been done at several occasions, see Table A5-5. Each one of them may have a short-lived effect on the hydrostatic pressure in the rock mass. In some cases the flowing of a section continued for several days and the following pressure response is clearly shown in the subsequent plot.

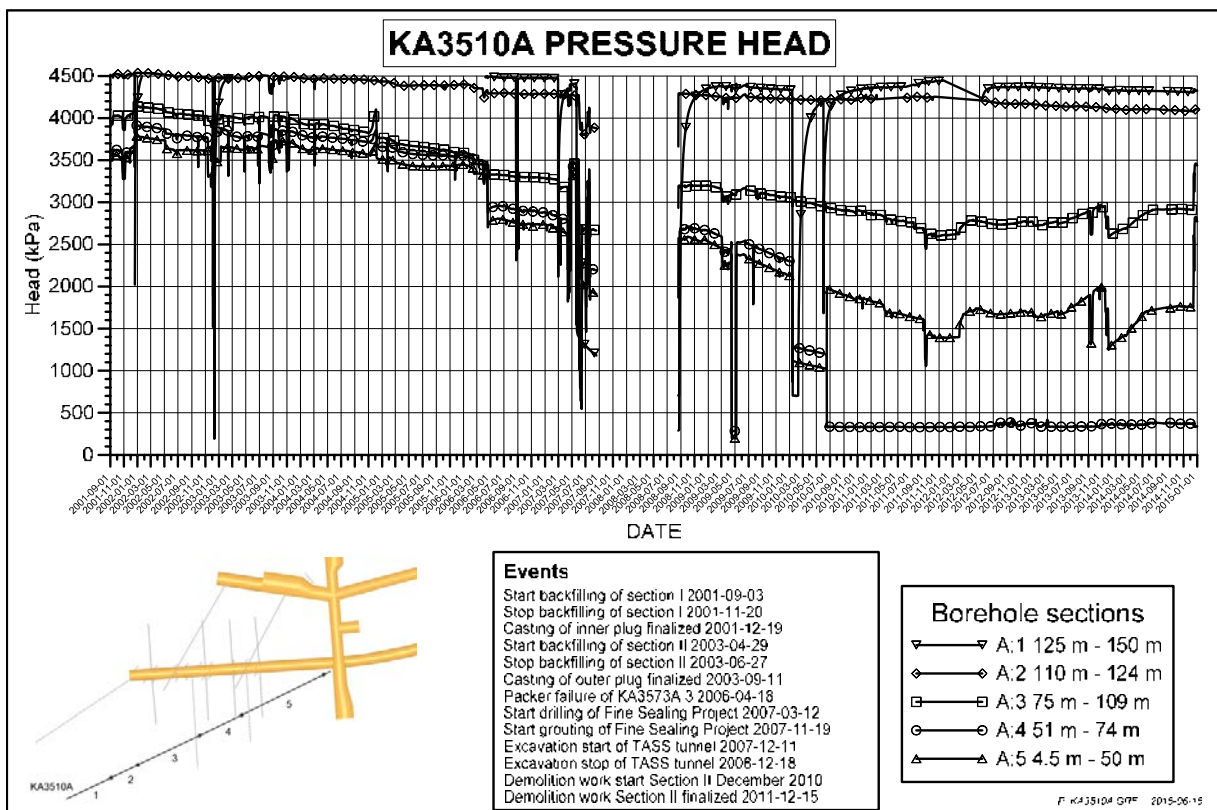


**Figure A5-3.** The tunnel-system including the TASS-tunnel with indication of the weir locations in TASS.

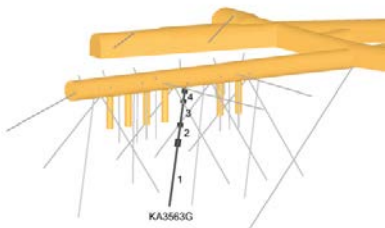
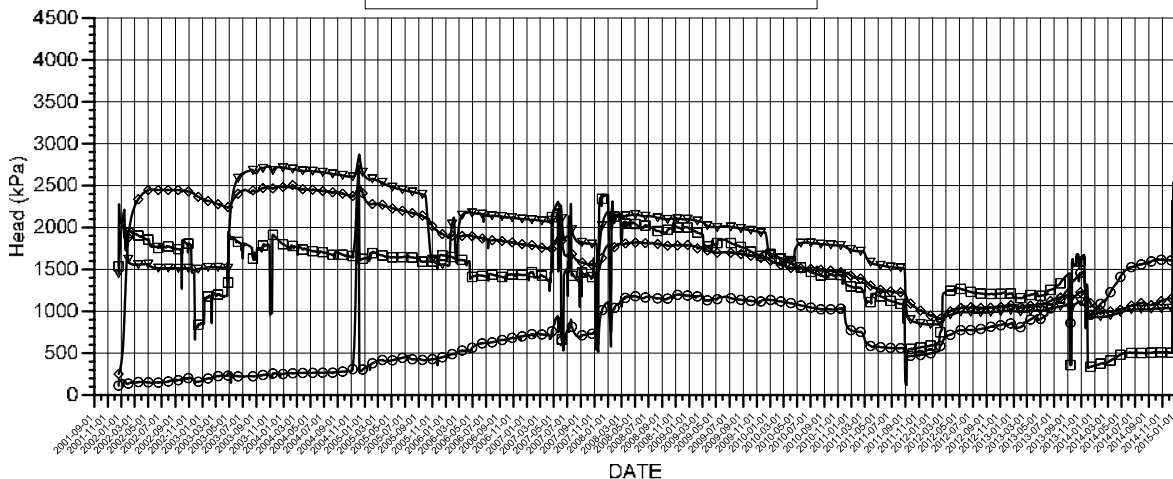
**Table A5-5. Water sampling dates in boreholes close to the Prototype Repository. Start and stop of times are for the flowing of the section.**

Borehole	Start date/time	Stop date/time	Secup	Seclow	Section number
KA3600F	2001-10-15 10:30:00	2001-10-15 10:45:00	40.50	42.00	2
KA3600F	2001-10-15 10:45:00	2001-10-15 11:15:00	43.00	50.10	1
KA3573A	2002-09-24 10:30:00	2002-09-24 11:00:00	26.00	40.07	1
KA3573A	2002-09-24 11:40:00	2002-09-24 13:40:00	21.00	24.00	2
KA3600F	2002-09-25 11:00:00	2002-09-25 13:40:00	40.50	42.00	2
KA3600F	2002-09-25 11:25:00	2002-09-25 11:44:00	43.00	50.01	1
KA3510A	2002-12-12 08:30:00	2002-12-12 08:50:00	4.50	50.00	5
KA3510A	2002-12-12 08:30:00	2002-12-12 08:52:00	110.00	124.00	2
KA3510A	2002-12-12 10:30:00	2002-12-12 11:04:00	75.00	109.00	3
KG0048A01	2003-06-03 10:06:00	2003-06-03 10:12:00	32.80	33.80	3
KA3566G02	2003-06-04 12:30:00	2003-06-04 17:30:00	16.00	18.00	2
KG0021A01	2003-06-30 11:03:00	2003-06-30 11:09:00	35.00	36.00	3
KA3600F	2003-07-03 13:51:00	2003-07-03 13:53:00	40.50	42.00	2
KA3572G01	2003-08-11 15:28:00	2003-08-28 15:00:00	2.70	5.30	2
KG0021A01	2003-09-18 09:40:00	2003-09-18 09:55:00	35.00	36.00	3
KG0048A01	2003-09-18 09:45:00	2003-09-18 09:55:00	32.80	33.80	3
KA3573A	2003-09-25 09:00:00	2003-09-25 10:00:00	26.00	40.07	1
KA3600F	2003-09-25 09:00:00	2003-09-25 09:45:00	43.00	50.10	1
KA3600F	2003-09-25 09:30:00	2003-09-25 10:00:00	40.50	42.00	2
KA3573A	2003-09-29 10:20:00	2003-09-29 10:40:00	21.00	24.00	2
KA3566G02	2003-09-29 11:00:00	2003-09-29 13:50:00	16.00	18.00	2
KA3590G01	2003-09-30 09:00:00	2003-09-30 12:45:00	16.00	30.00	2
KA3600F	2004-02-17 09:55:00	2004-02-17 10:11:00	40.50	42.00	2
KG0021A01	2004-02-17 10:27:00	2004-02-17 10:43:00	35.00	36.00	3
KG0048A01	2004-03-02 09:24:00	2004-03-02 09:40:00	32.80	33.80	3
KA3590G01	2004-03-03 21:36:00	2004-03-03 21:36:00	7.00	15.00	2
KA3572G01	2004-04-02 10:35:00	2004-04-07 10:15:00	2.70	5.30	2
KA3573A	2004-09-21 09:23:00	2004-09-22 09:54:00	26.00	40.07	1
KA3600F	2004-09-21 09:23:00	2004-09-22 10:03:00	43.00	50.10	1
KA3573A	2004-09-22 09:2200	2004-09-22 10:03:00	21.00	24.00	2
KA3600F	2004-09-22 09:18:00	2004-09-22 09:44:00	40.50	42.00	2
KA3590G01	2004-11-15 11:16:00	2005-01-20 09:40:00	7.00	15.00	2
KA3566G02	2004-11-19 08:30:00	2004-11-22 09:53:00	16.00	18.00	2
KA3566G02	2005-02-03 10:20	2005-03-10 14:00	16.00	18.00	2
KA3573A	2005-09-26 10:5800	2005-09-26 10:58:00	21.00	24.00	2
KA3600F	2005-09-26 10:42:00	2005-09-26 10:42:00	40.50	42.00	2
KA3510A	2005-10-03 09:24:00	2005-10-03 09:29:00	110.00	124.00	2
KA3573A	2005-10-05 10:30:00	2005-10-05 11:05:00	26.00	40.07	1
KA3600F	2005-10-07 09:20:00	2005-10-07 10:03:00	43.00	50.10	1
KA3510A	2005-10-07 12:15:00	2005-10-07 12:38:00	110.00	124.00	2
KA3600F	2006-07-12 09:37:00	2006-07-12 10:04:00	40.50	42.00	2
KA3572G01	2006-07-12 10:00:00	2006-07-18 15:35:00	2.70	5.30	2
KG0021A01	2006-07-12 13:40:00	2006-07-12 14:29:00	35.00	36.00	3
KG0048A01	2006-07-12 14:42:00	2006-07-12 15:36:00	32.80	33.80	3
KA3590G01	2006-07-13 09:55:00	2006-07-13 16:00:00	7.00	15.00	2
KA3566G02	2006-07-13 10:10:00	2006-07-13 19:25:00	16.00	18.00	2

Borehole	Start date/time	Stop date/time	Secup	Seclow	Section number
KA3510A	2006-09-20 08:30:00	2006-09-20 08:35:00			No section data avail.
KA3573A	2006-10-02 10:15:00	2006-10-02 10:37:00	21.00	24.00	2
KA3600F	2006-10-02 09:50:00	2006-10-02 10:10:00	40.50	42.00	2
KA3573A	2006-10-03 09:50:00	2006-10-03 10:17:00	26.00	40.07	1
KA3600F	2006-10-03 09:50:00	2006-10-03 10:13:00	43.00	51.10	1
KA3600F	2007-01-09 14:32:00	2007-01-09 14:58:00			No section data avail.
KA3572G01	2007-01-10 09:30:00	2007-01-16 10:33:00			No section data avail.
KA3566G02	2007-01-11 08:57:00	2007-01-11 16:35:00			No section data avail.
KA3590G01	2007-01-15 09:07:00	2007-01-15 14:37:00			No section data avail.
KG0021A01	2007-01-10 09:50:00	2007-01-10 10:21:00	35.00	36.00	3
KG0048A01	2007-01-10 13:59:00	2007-01-10 14:26:00	32.80	33.80	3



### KA3563G PRESSURE HEAD



#### Events

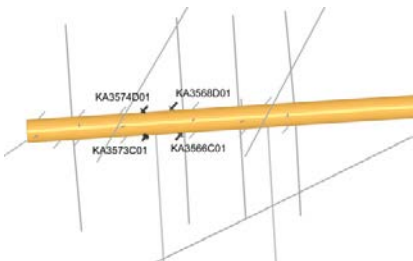
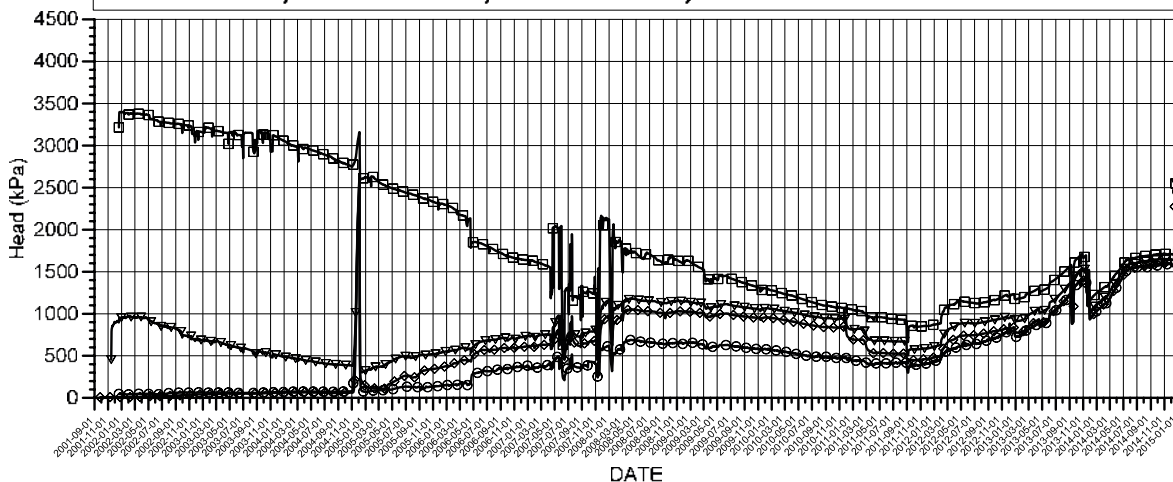
- Start backfilling of section I 2001-09-03
- Stop backfilling of section I 2001-11-20
- Casting of inner plug finalized 2001-12-19
- Start backfilling of section II 2003-04-29
- Stop backfilling of section II 2003-06-27
- Casting of outer plug finalized 2003-09-11
- Packer failure of KA3573A.3 2006-04-18
- Start drilling of Fine Sealing Project 2007-03-12
- Start grouting of Fine Sealing Project 2007-11-19
- Excavation start of TASS tunnel 2007-12-11
- Excavation stop of TASS tunnel 2008-12-18
- Demolition work start Section II December 2010
- Demolition work Section II finalized 2011-12-15

#### Borehole sections

- ▼—▼ G:1 15 m - 30 m
- ◆—◆ G:2 10 m - 13 m
- G:3 4 m - 8 m
- G:4 1.5 m - 3 m

P\_KA3563G.DRF 2015-06-15

### KA3566C01, KA3568D01, KA3573C01, KA3574D01 PRESSURE HEAD



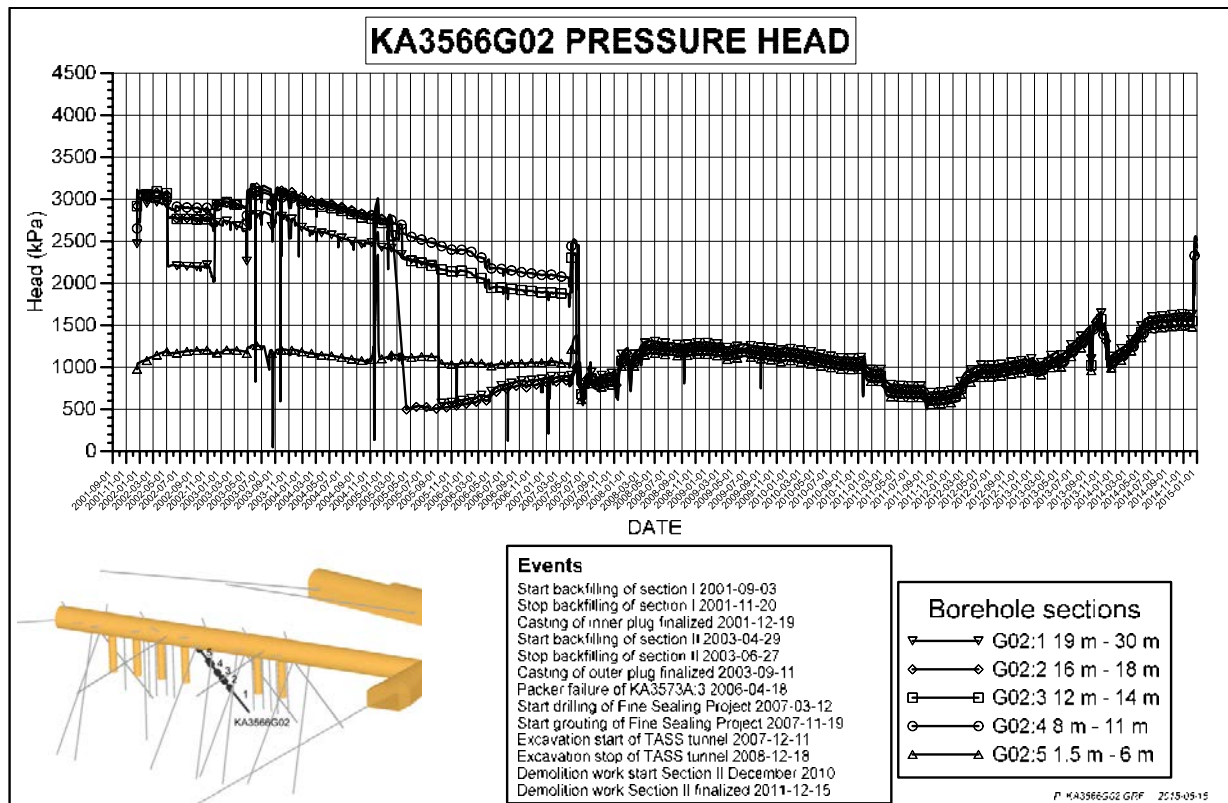
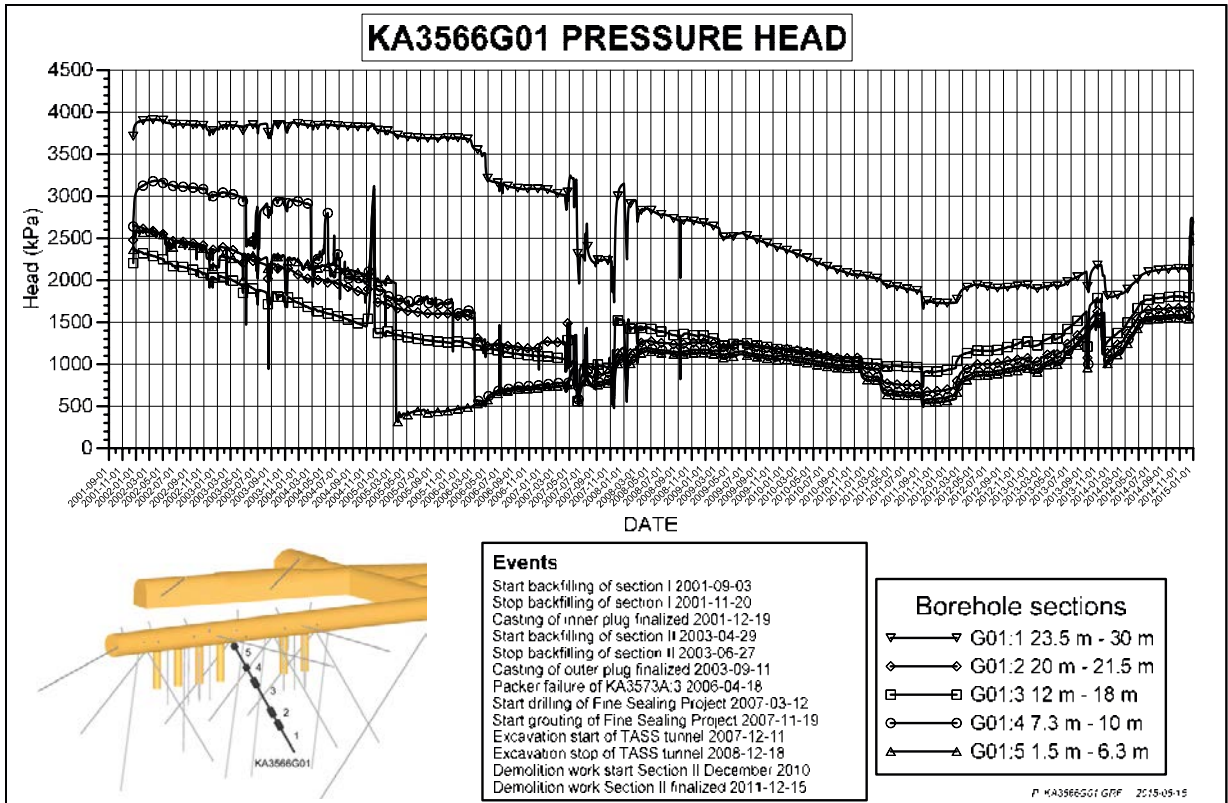
#### Events

- Start backfilling of section I 2001-09-03
- Stop backfilling of section I 2001-11-20
- Casting of inner plug finalized 2001-12-19
- Start backfilling of section II 2003-04-29
- Stop backfilling of section II 2003-06-27
- Casting of outer plug finalized 2003-09-11
- Packer failure of KA3573A.3 2006-04-18
- Start drilling of Fine Sealing Project 2007-03-12
- Start grouting of Fine Sealing Project 2007-11-19
- Excavation start of TASS tunnel 2007-12-11
- Excavation stop of TASS tunnel 2008-12-18
- Demolition work start Section II December 2010
- Demolition work Section II finalized 2011-12-15

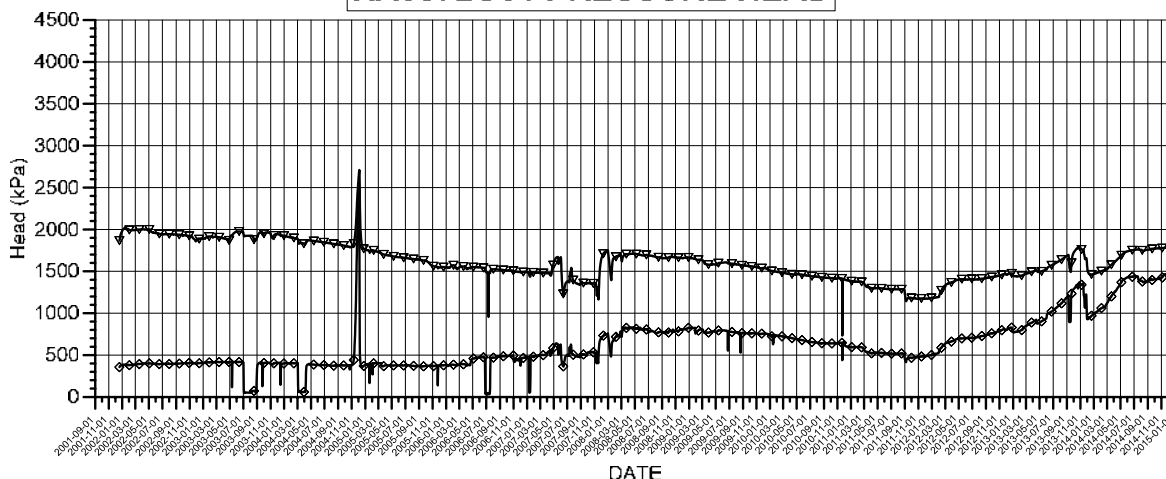
#### Borehole sections

- ▼—▼ KA3566C01:1 0.65 m - 2 m
- ◆—◆ KA3568D01:1 0.65 m - 2 m
- KA3573C01:1 0.65 m - 2 m
- KA3574D01:1 0.65 m - 2 m

P\_KA3566C01\_P\_KA3574D01.DRF 2015-06-15



### KA3572G01 PRESSURE HEAD

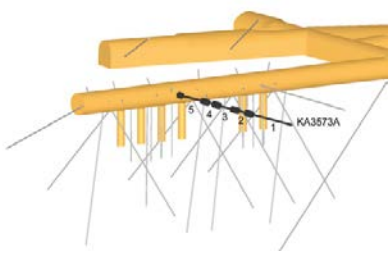
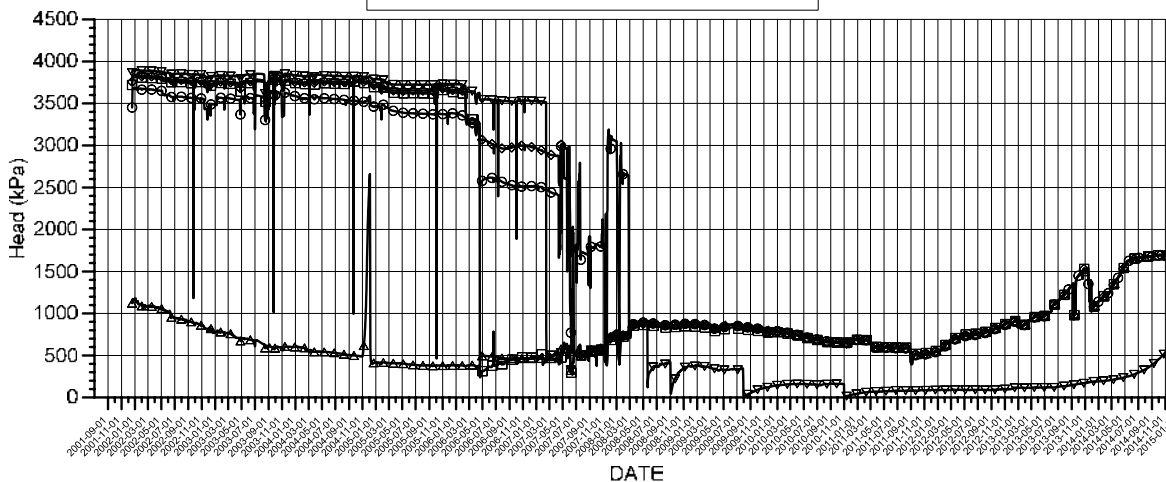


- Events**
- Start backfilling of section I 2001-09-03
  - Stop backfilling of section I 2001-11-20
  - Casting of inner plug finalized 2001-12-19
  - Start backfilling of section II 2003-04-29
  - Stop backfilling of section II 2003-06-27
  - Casting of outer plug finalized 2003-09-11
  - Packer failure of KA3573A 3 2006-04-18
  - Start drilling of Fine Sealing Project 2007-03-12
  - Start grouting of Fine Sealing Project 2007-11-19
  - Excavation start of TASS tunnel 2007-12-11
  - Excavation stop of TASS tunnel 2008-12-18
  - Demolition work start Section II December 2010
  - Demolition work Section II finalized 2011-12-15

- Borehole sections**
- ▽—▽ G01:1 7.3 m - 12.0 m
  - ◇—◇ G01:2 2.7 m - 5.3 m

P\_KA3572G01 GPF 2015-05-15

### KA3573A PRESSURE HEAD

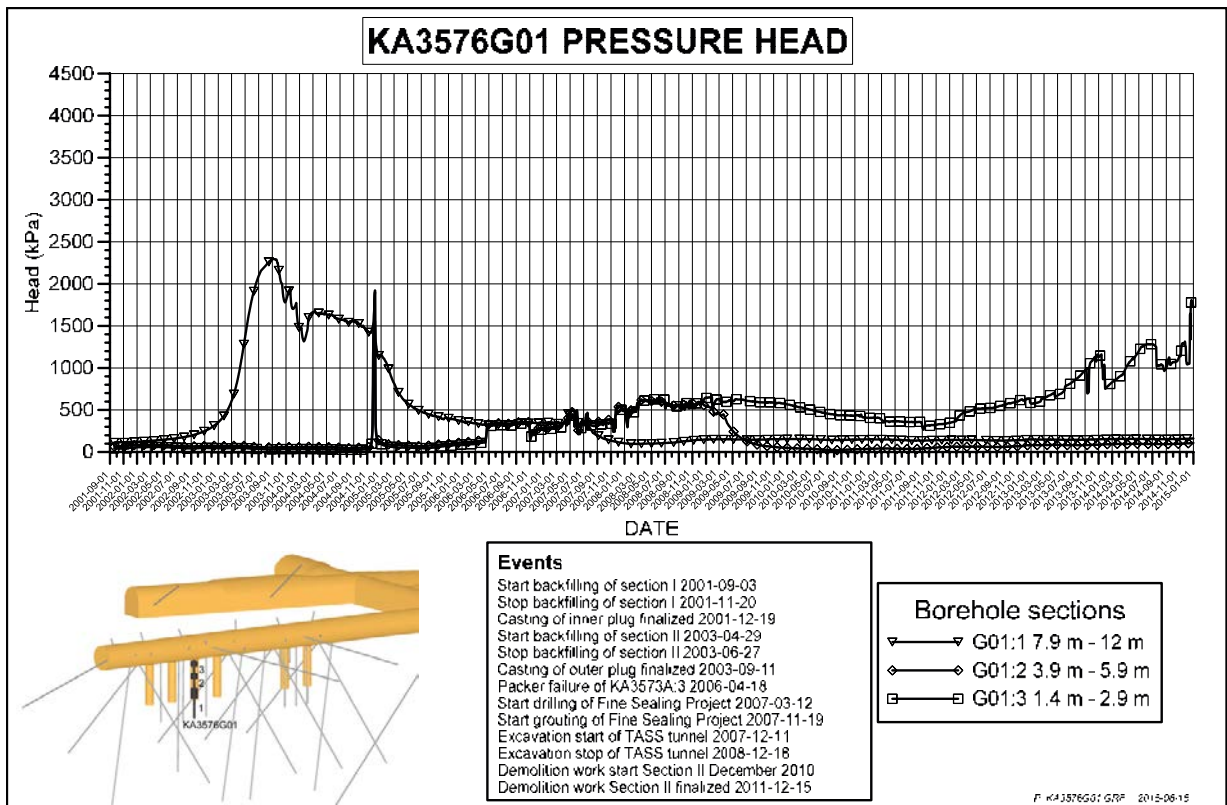
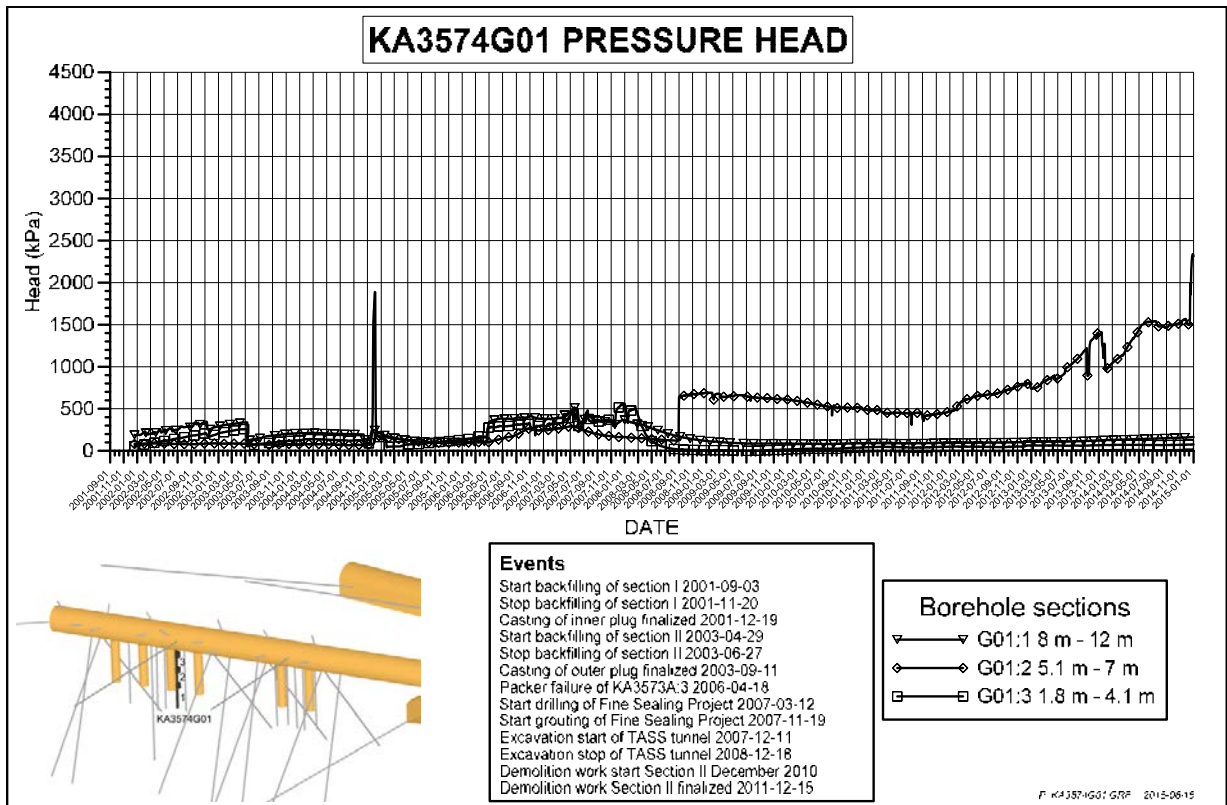


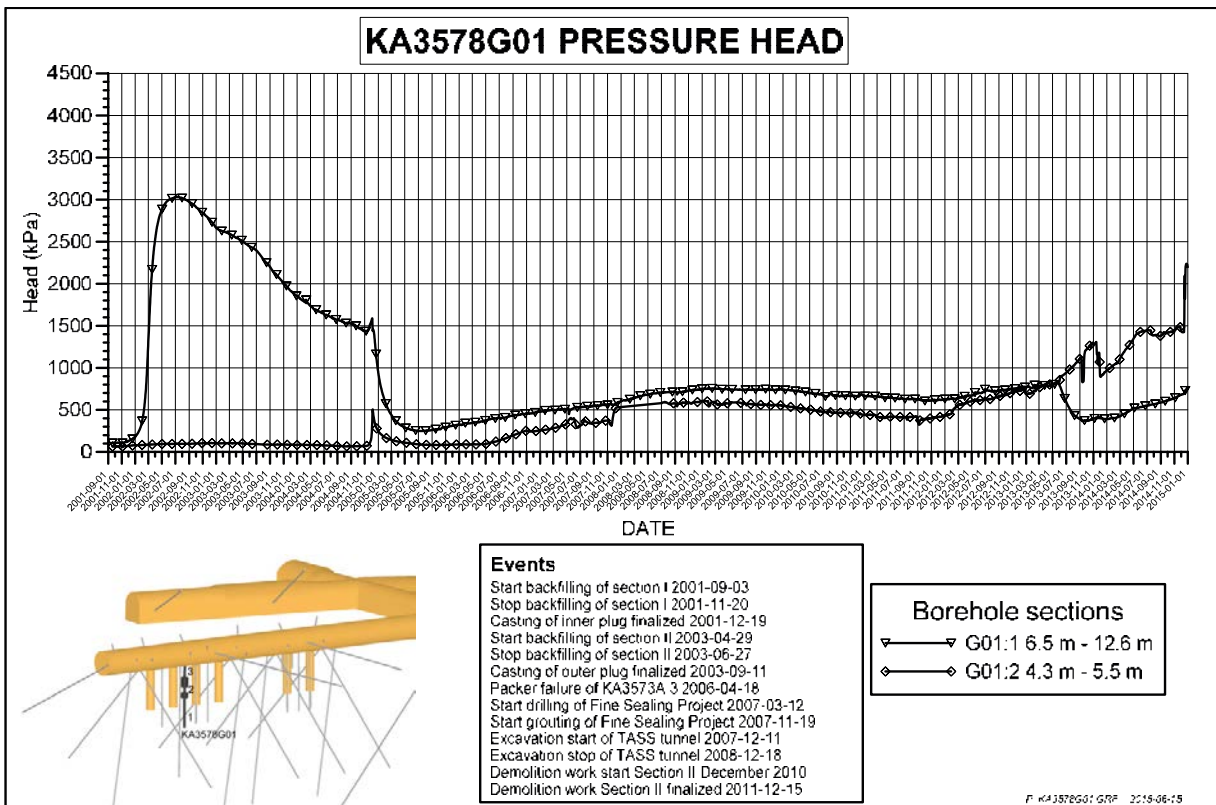
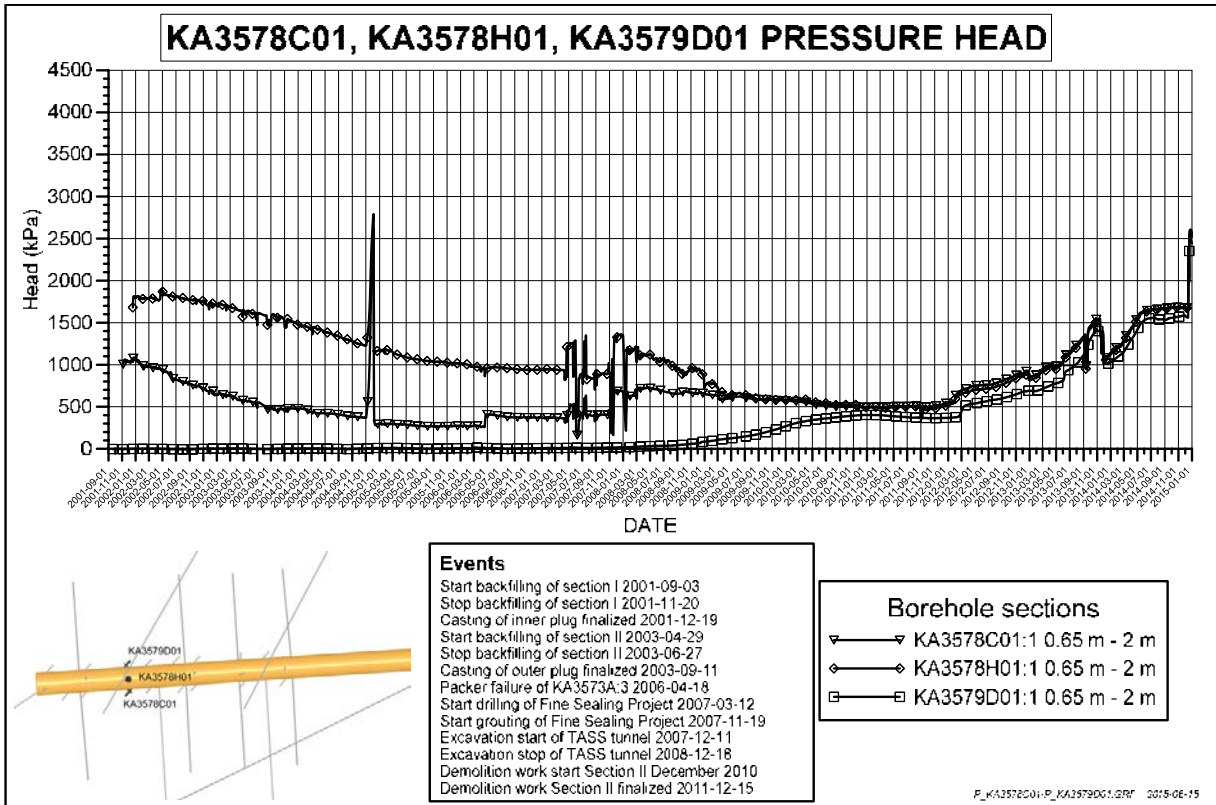
- Events**
- Start backfilling of section I 2001-09-03
  - Stop backfilling of section I 2001-11-20
  - Casting of inner plug finalized 2001-12-19
  - Start backfilling of section II 2003-04-29
  - Stop backfilling of section II 2003-06-27
  - Casting of outer plug finalized 2003-09-11
  - Packer failure of KA3573A:3 2006-04-18
  - Start drilling of Fine Sealing Project 2007-03-12
  - Start grouting of Fine Sealing Project 2007-11-19
  - Excavation start of TASS tunnel 2007-12-11
  - Excavation stop of TASS tunnel 2008-12-18
  - Demolition work start Section II December 2010
  - Demolition work Section II finalized 2011-12-15

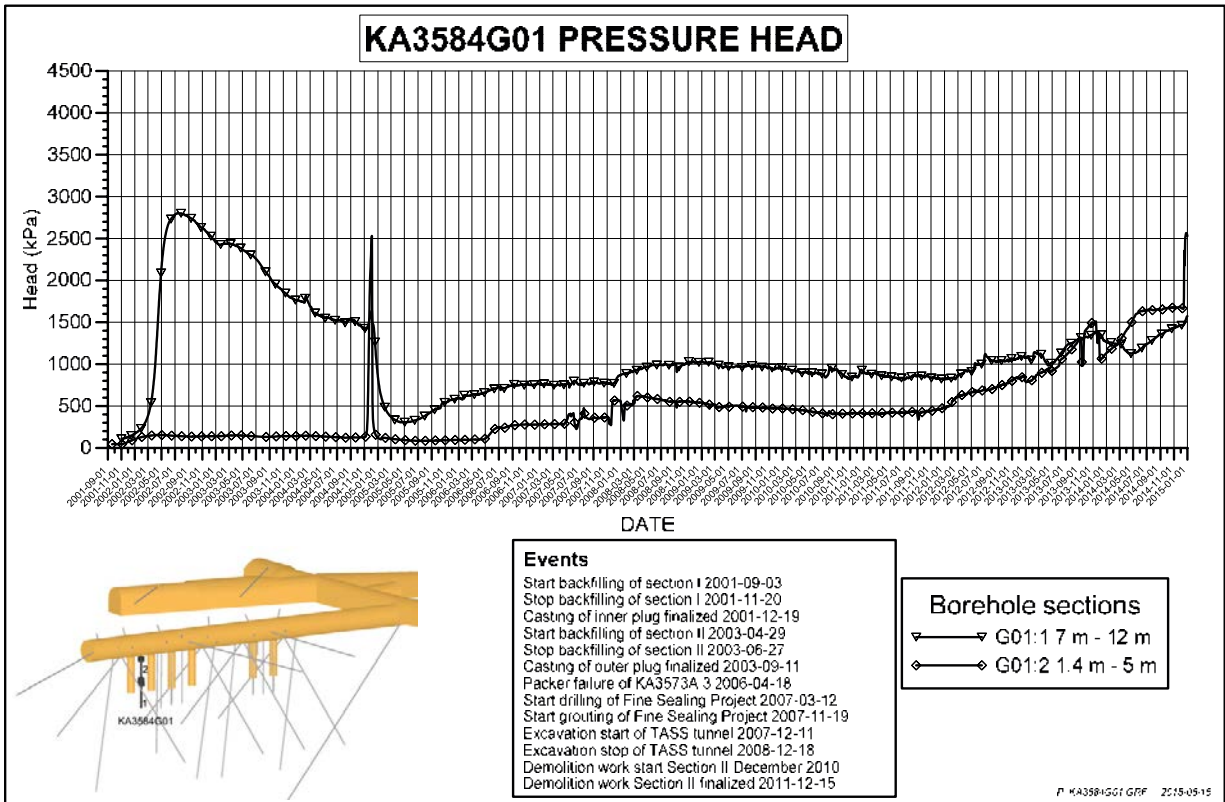
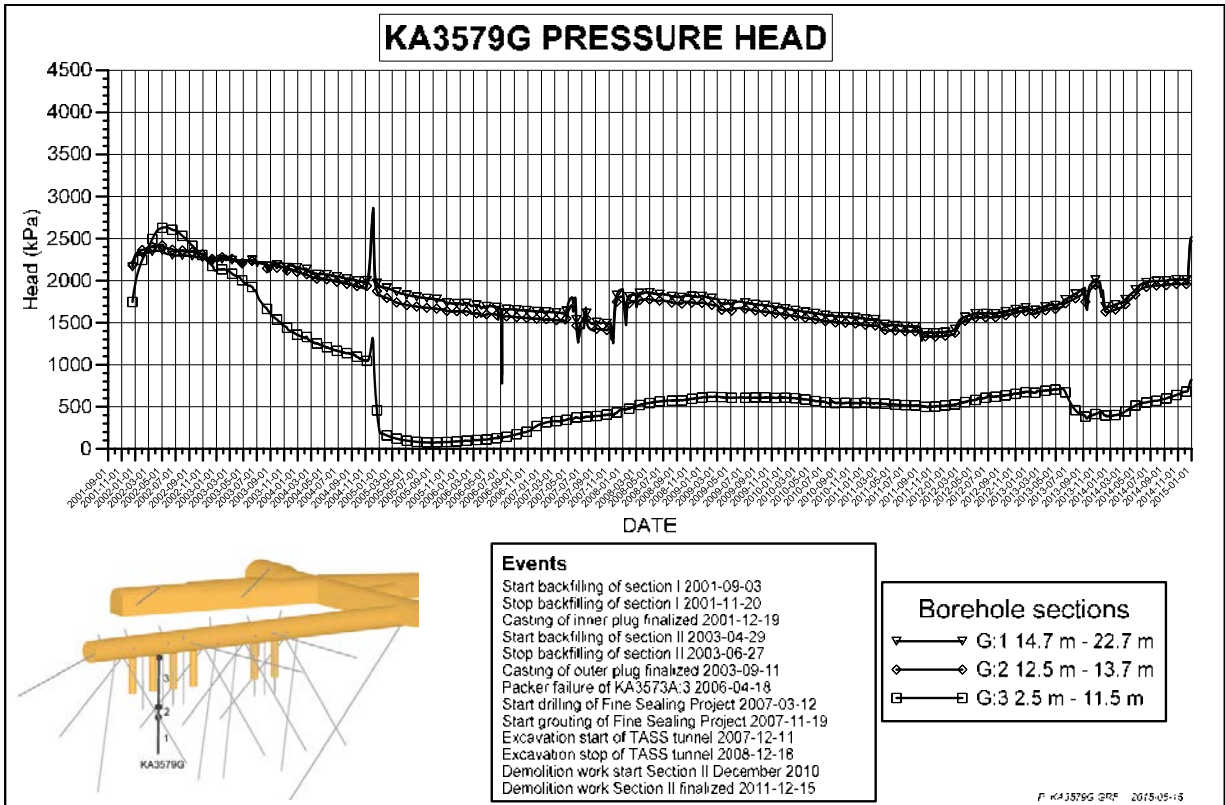
- Borehole sections**
- ▽—▽ A:1 26 m - 40.1 m
  - ◇—◇ A:2 21 m - 24 m
  - A:3 14.5 m - 19 m
  - A:4 10.5 m - 12.5 m
  - ▲—▲ A:5 3.4 m - 8.5 m

P\_KA3573A GPF 2015-05-15

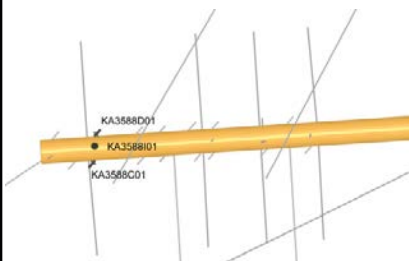
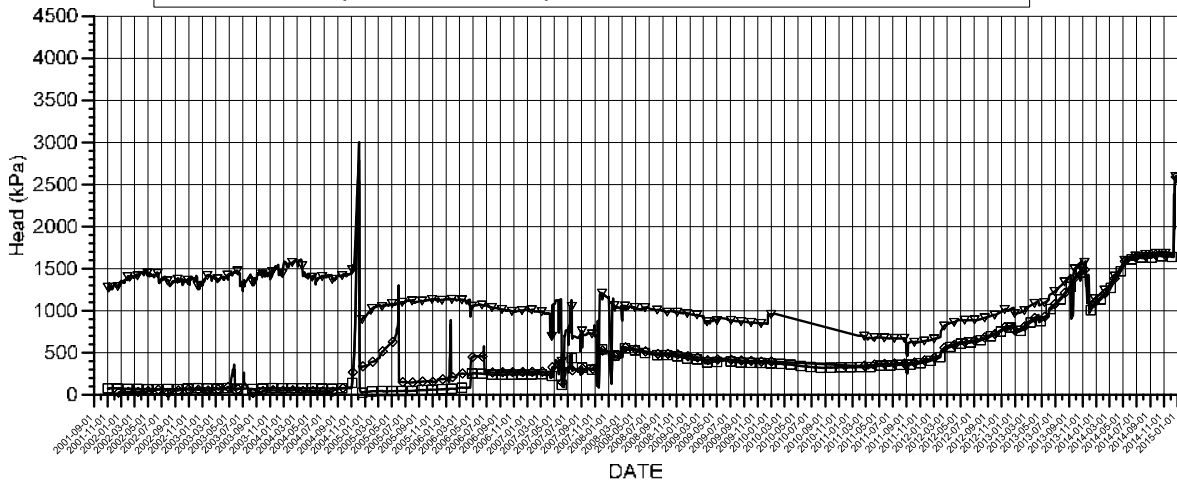








### KA3588C01, KA3588D01, KA3588I01 PRESSURE HEAD

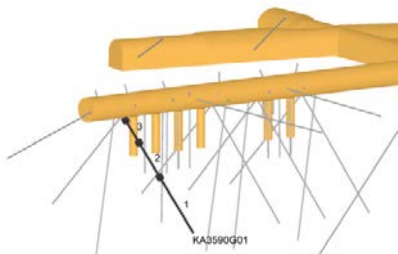
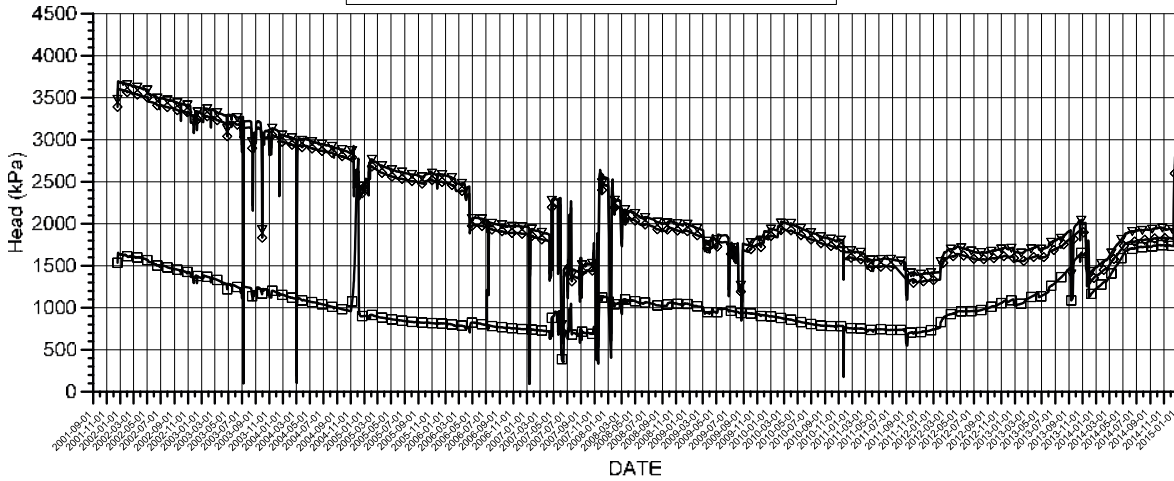


- Events**
- Start backfilling of section I 2001-09-03
  - Stop backfilling of section I 2001-11-20
  - Casting of inner plug finalized 2001-12-19
  - Start backfilling of section II 2003-04-29
  - Stop backfilling of section II 2003-06-27
  - Casting of outer plug finalized 2003-09-11
  - Packer failure of KA3573A:3 2006-04-18
  - Start drilling of Fine Sealing Project 2007-03-12
  - Start grouting of Fine Sealing Project 2007-11-19
  - Excavation start of TASS tunnel 2007-12-11
  - Excavation stop of TASS tunnel 2008-12-18
  - Demolition work start Section II December 2010
  - Demolition work Section II finalized 2011-12-15

- Borehole sections**
- KA3588C01:1 0.65 m - 2 m
  - KA3588D01:1 0.65 m - 2 m
  - KA3588I01:1 0.65 m - 2 m

P\_KA3588C01\_P\_KA3588I01.GRF 2015-06-15

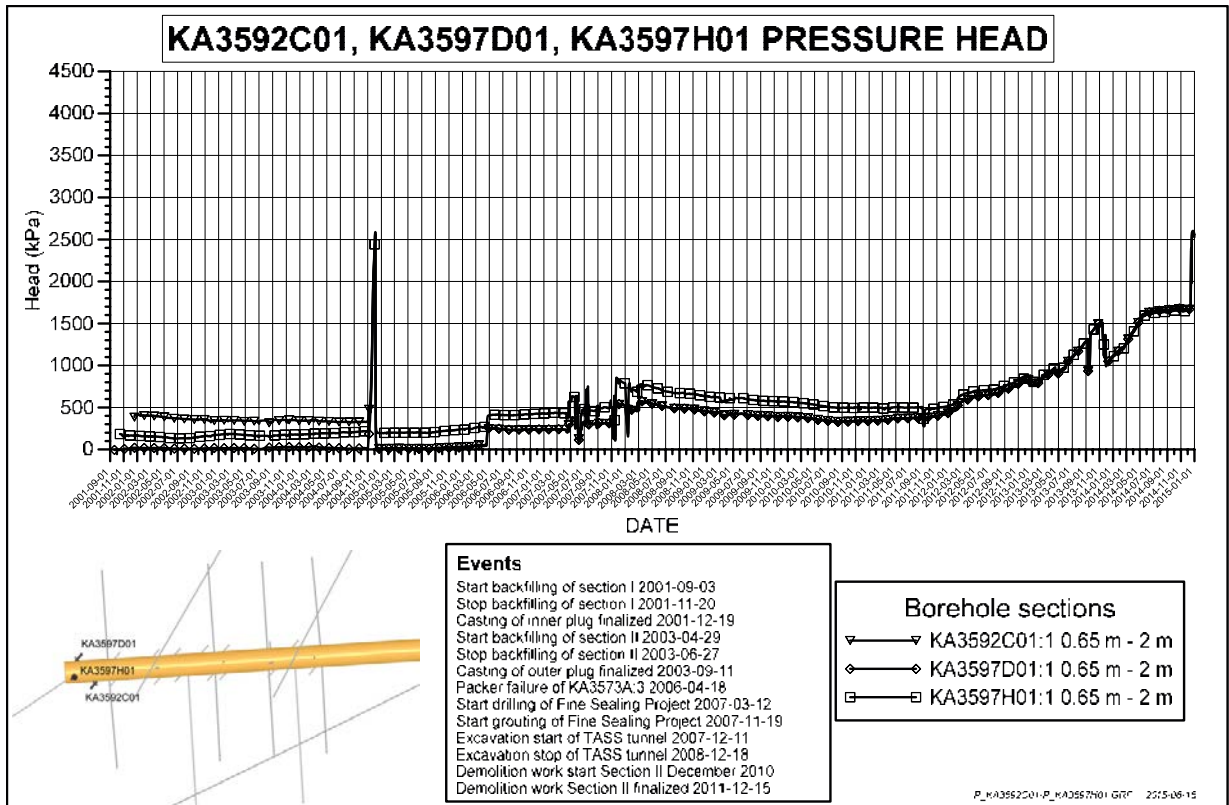
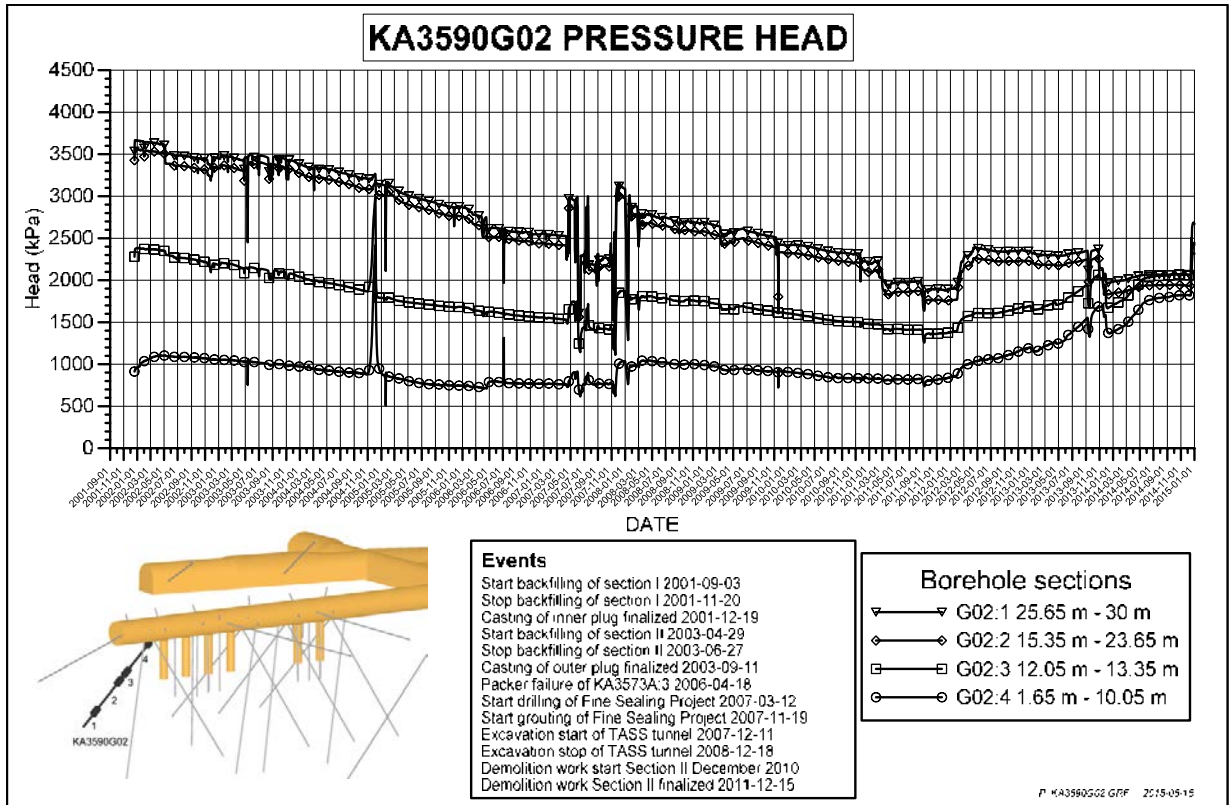
### KA3590G01 PRESSURE HEAD



- Events**
- Start backfilling of section I 2001-09-03
  - Stop backfilling of section I 2001-11-20
  - Casting of inner plug finalized 2001-12-19
  - Start backfilling of section II 2003-04-29
  - Stop backfilling of section II 2003-06-27
  - Casting of outer plug finalized 2003-09-11
  - Packer failure of KA3573A:3 2006-04-18
  - Start drilling of Fine Sealing Project 2007-03-12
  - Start grouting of Fine Sealing Project 2007-11-19
  - Excavation start of TASS tunnel 2007-12-11
  - Excavation stop of TASS tunnel 2008-12-18
  - Demolition work start Section II December 2010
  - Demolition work Section II finalized 2011-12-15

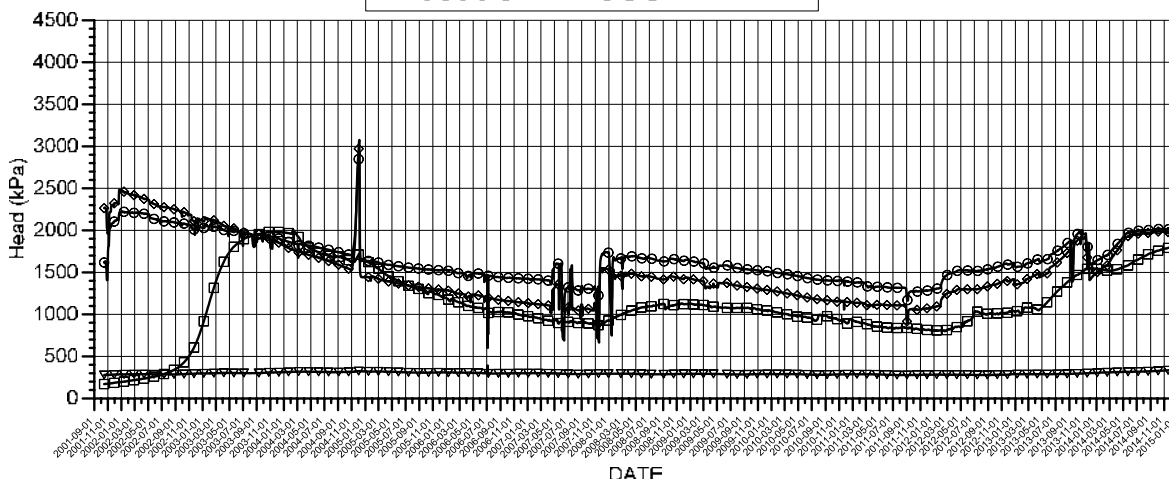
- Borehole sections**
- G01:1 16 m - 30 m
  - G01:2 7 m - 15 m
  - G01:3 1.5 m - 6 m

P\_KA3590G01.GRF 2015-05-15

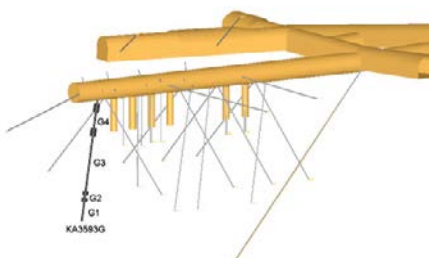




### KA3593G PRESSURE HEAD



DATE



#### Events

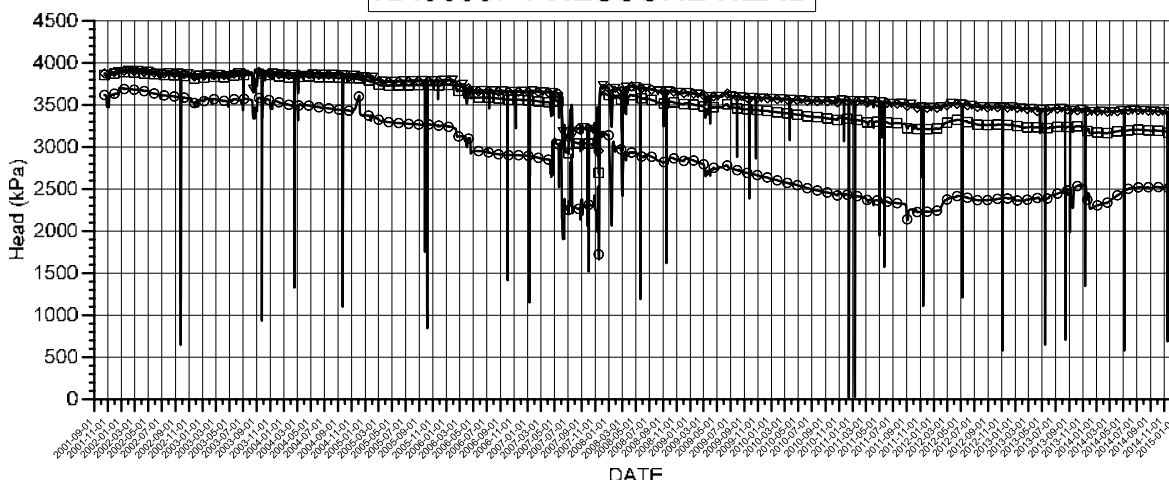
- Start backfilling of section I 2001-09-03
- Stop backfilling of section I 2001-11-20
- Casting of inner plug finalized 2001-12-19
- Start backfilling of section II 2003-04-29
- Stop backfilling of section II 2003-06-27
- Casting of outer plug finalized 2003-09-11
- Packer failure of KA3573A:3 2006-04-18
- Start drilling of Fine Sealing Project 2007-03-12
- Start grouting of Fine Sealing Project 2007-11-19
- Excavation start of TASS tunnel 2007-12-11
- Excavation stop of TASS tunnel 2008-12-18
- Demolition work start Section II December 2010
- Demolition work Section II finalized 2011-12-15

#### Borehole sections

- ▽ G:1 25.2 m - 30 m
- ◇ G:2 23.5 m - 24.2 m
- G:3 9 m - 22.5 m
- G:4 3 m - 7 m

F: KA3593G GRF 2015-06-15

### KA3600F PRESSURE HEAD



DATE



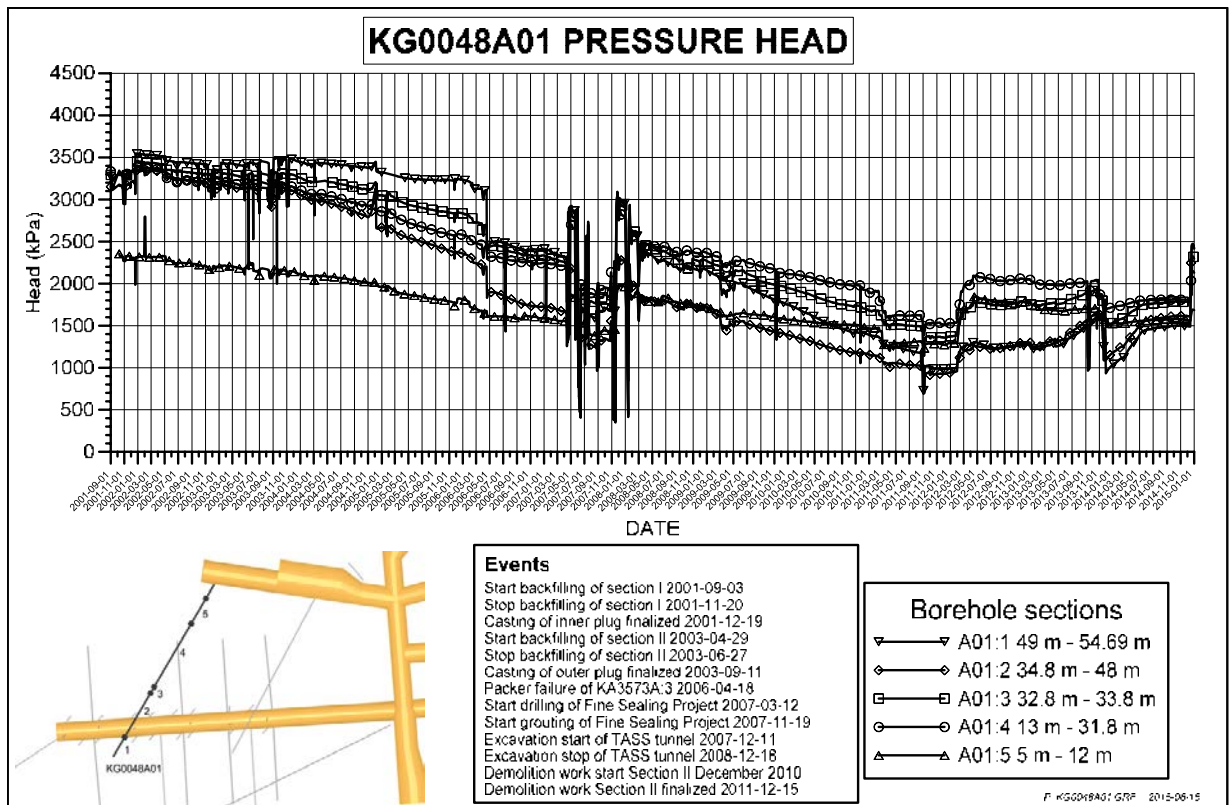
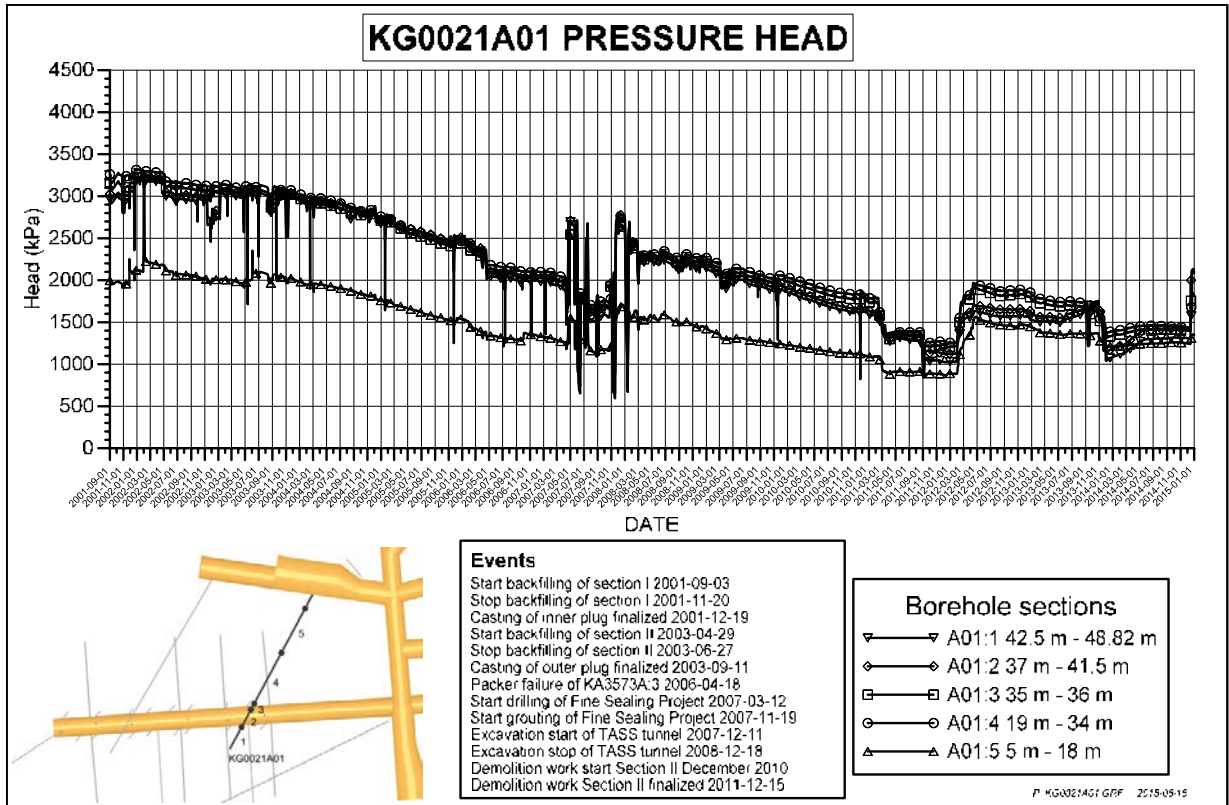
#### Events

- Start backfilling of section I 2001-09-03
- Stop backfilling of section I 2001-11-20
- Casting of inner plug finalized 2001-12-19
- Start backfilling of section II 2003-04-29
- Stop backfilling of section II 2003-06-27
- Casting of outer plug finalized 2003-09-11
- Packer failure of KA3573A:3 2006-04-18
- Start drilling of Fine Sealing Project 2007-03-12
- Start grouting of Fine Sealing Project 2007-11-19
- Excavation start of TASS tunnel 2007-12-11
- Excavation stop of TASS tunnel 2008-12-18
- Demolition work start Section II December 2010
- Demolition work Section II finalized 2011-12-15

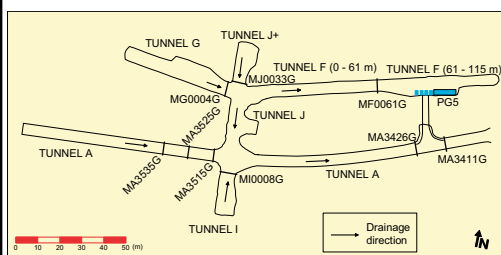
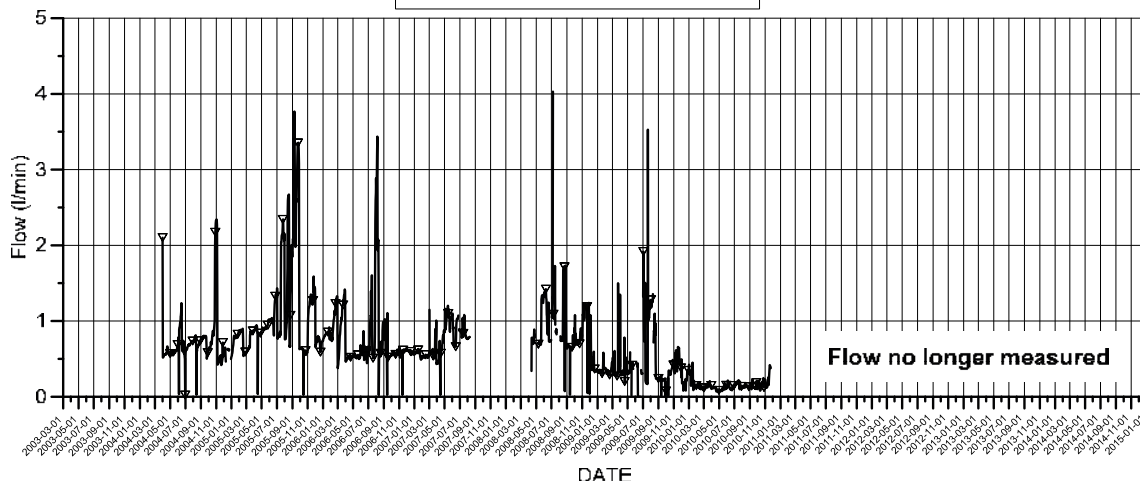
#### Borehole sections

- ▽ F:1 43 m - 50.1 m
- ◇ F:2 40.5 m - 42 m
- F:3 20 m - 39.5 m
- F:4 3.4 m - 18 m

F: KA3600F GRF 2015-06-15



### MA3515G WEIR FLOW

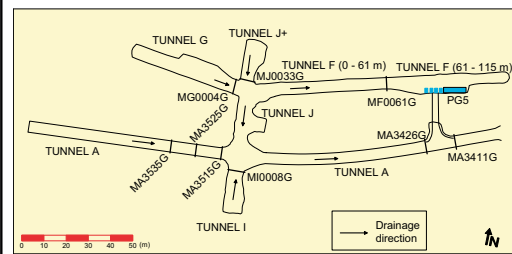
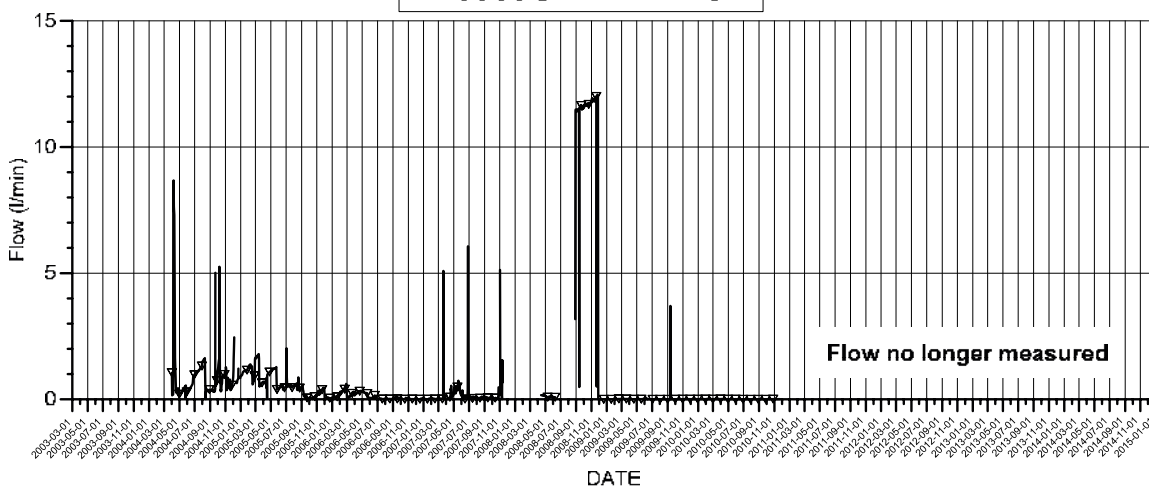


- Events**
- Start backfilling of section I 2001-09-03
  - Stop backfilling of section I 2001-11-20
  - Casting of inner plug finalized 2001-12-19
  - Start backfilling of section II 2003-04-29
  - Stop backfilling of section II 2003-06-27
  - Casting of outer plug finalized 2003-09-11
  - Packer failure of KA3573A:3 2006-04-18
  - Start drilling of Fine Sealing Project 2007-03-12
  - Start grouting of Fine Sealing Project 2007-11-19
  - Excavation start of TASS tunnel 2007-12-11
  - Excavation stop of TASS tunnel 2008-12-18
  - Demolition work start Section II December 2010
  - Demolition work Section II finalized 2011-12-15

WEIR MA3515G

G MA3515G G7F 2015-06-15

### MA3535G WEIR FLOW

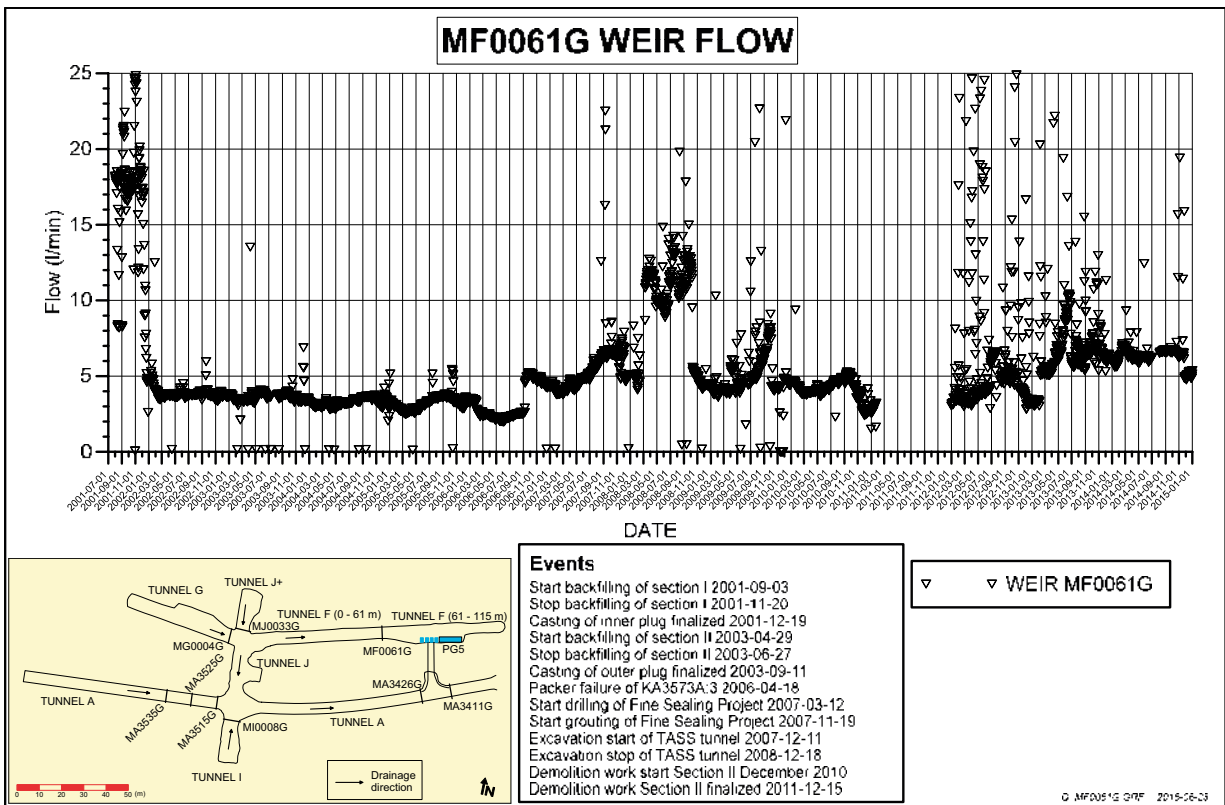
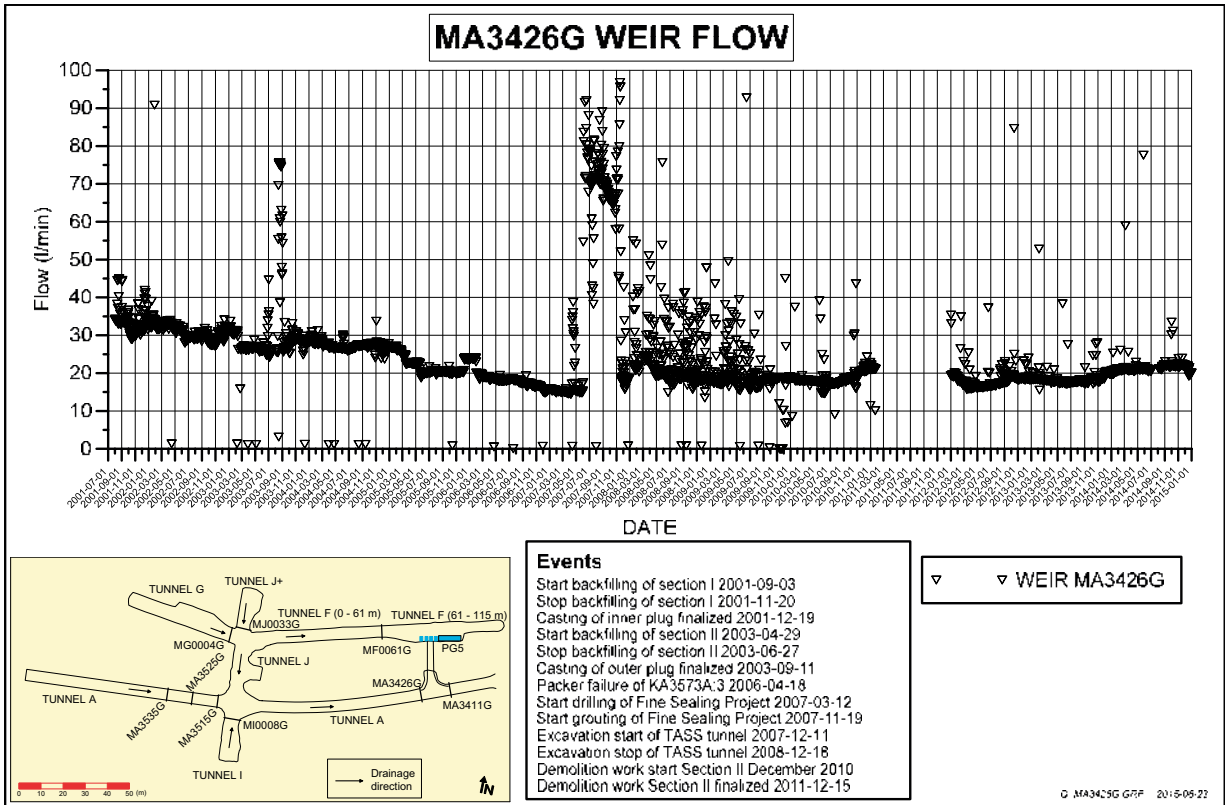


- Events**
- Start backfilling of section I 2001-09-03
  - Stop backfilling of section I 2001-11-20
  - Casting of inner plug finalized 2001-12-19
  - Start backfilling of section II 2003-04-29
  - Stop backfilling of section II 2003-06-27
  - Casting of outer plug finalized 2003-09-11
  - Packer failure of KA3573A:3 2006-04-18
  - Start drilling of Fine Sealing Project 2007-03-12
  - Start grouting of Fine Sealing Project 2007-11-19
  - Excavation start of TASS tunnel 2007-12-11
  - Excavation stop of TASS tunnel 2008-12-18
  - Demolition work start Section II December 2010
  - Demolition work Section II finalized 2011-12-15

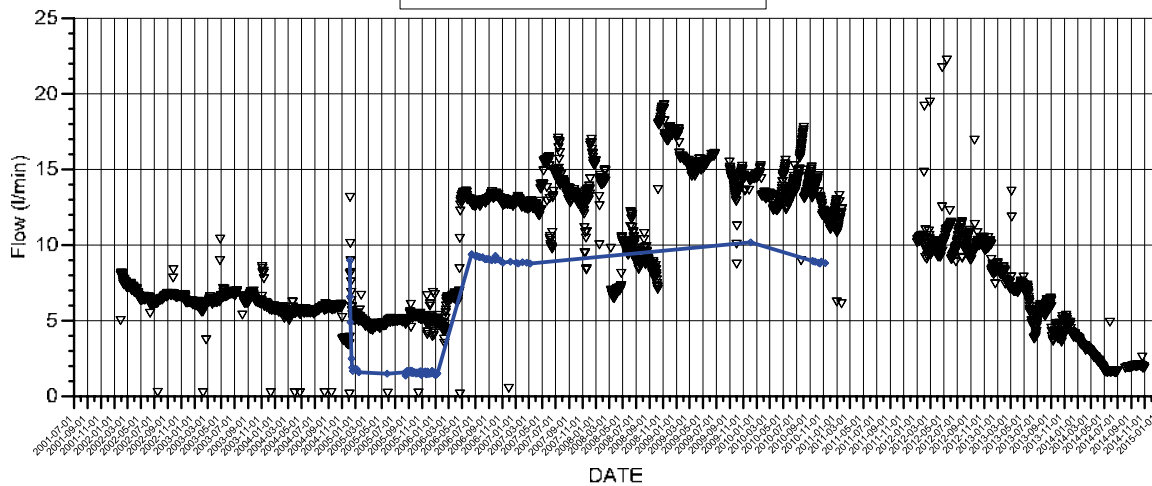
WEIR MA3535G

G MA3535G G7F 2015-06-15

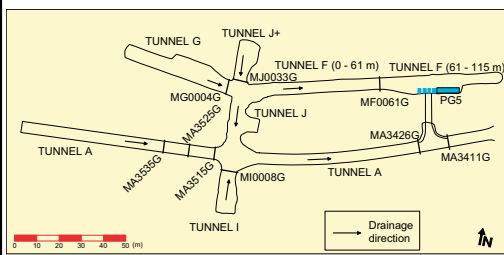




### MG0004G WEIR FLOW



DATE



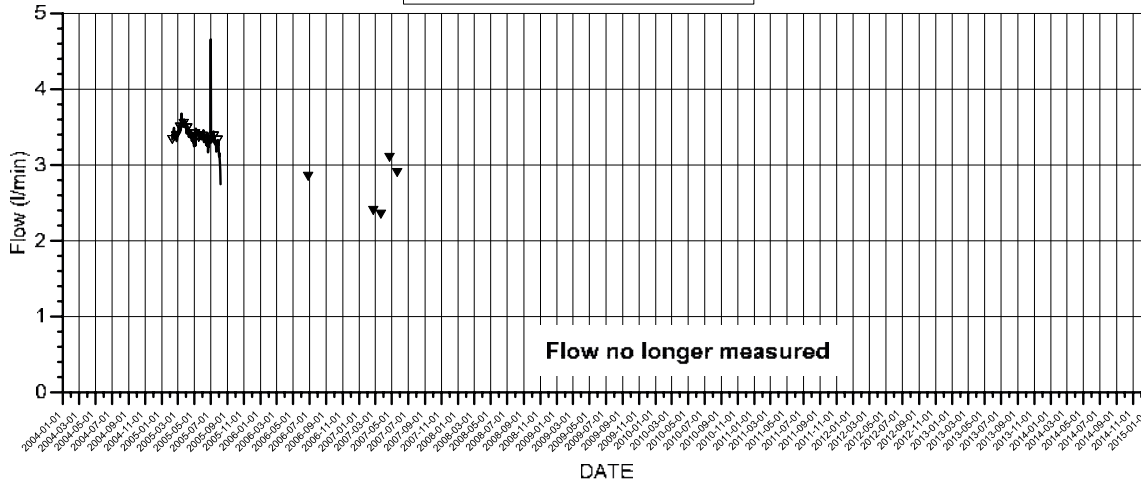
#### Events

- Start backfilling of section I 2001-09-03
- Stop backfilling of section I 2001-11-20
- Casting of inner plug finalized 2001-12-19
- Start backfilling of section II 2003-04-29
- Stop backfilling of section II 2003-06-27
- Casting of outer plug finalized 2003-09-11
- Packer failure of KA3573A.3 2006-04-18
- Start drilling of Fine Sealing Project 2007-03-12
- Start grouting of Fine Sealing Project 2007-11-19
- Excavation start of TASS tunnel 2007-12-11
- Excavation stop of TASS tunnel 2008-12-18
- Demolition work start Section II December 2010
- Demolition work Section II finalized 2011-12-15

- ▽ WEIR MG0004G
- Flow from Section I

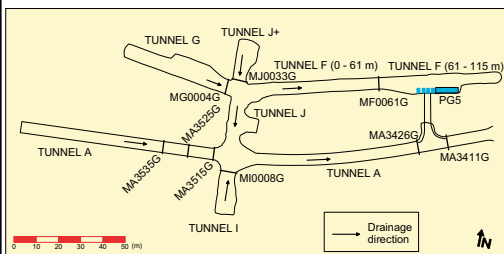
© MG0004G GRF 2015-05-15

### MI0008G WEIR FLOW



Flow no longer measured

DATE



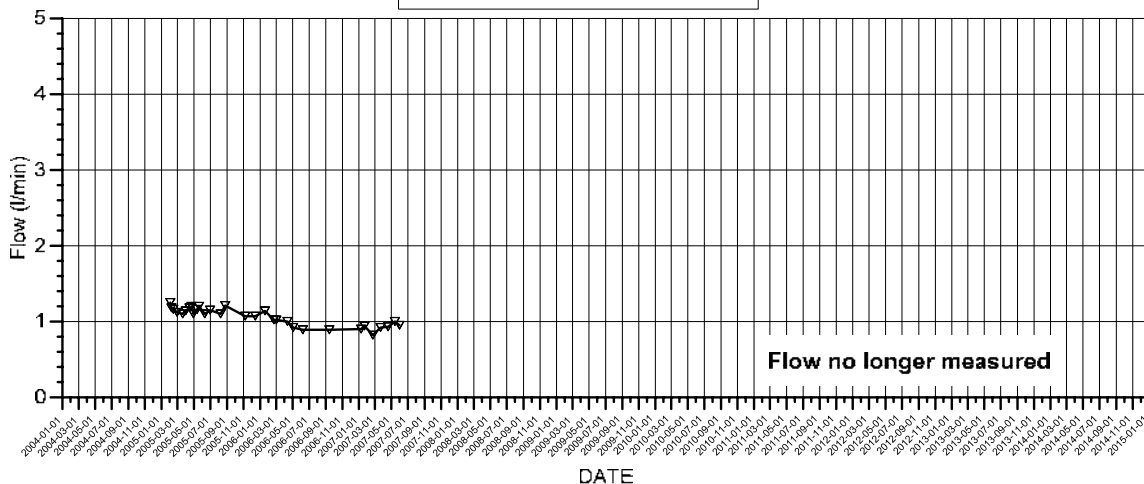
#### Events

- Start backfilling of section I 2001-09-03
- Stop backfilling of section I 2001-11-20
- Casting of inner plug finalized 2001-12-19
- Start backfilling of section II 2003-04-29
- Stop backfilling of section II 2003-06-27
- Casting of outer plug finalized 2003-09-11
- Packer failure of KA3573A.3 2006-04-18
- Start drilling of Fine Sealing Project 2007-03-12
- Start grouting of Fine Sealing Project 2007-11-19
- Excavation start of TASS tunnel 2007-12-11
- Excavation stop of TASS tunnel 2008-12-18
- Demolition work start Section II December 2010
- Demolition work Section II finalized 2011-12-15

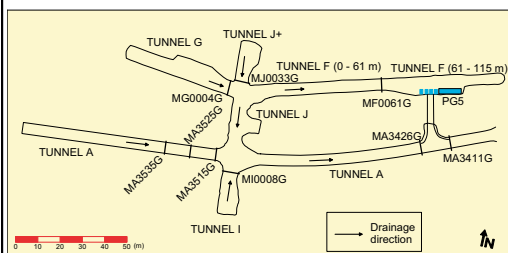
- ▽ WEIR MI0008G
- ▽ Manual readings

© MI0008G GRF 2015-06-15

### MJ0033G WEIR FLOW



Flow no longer measured



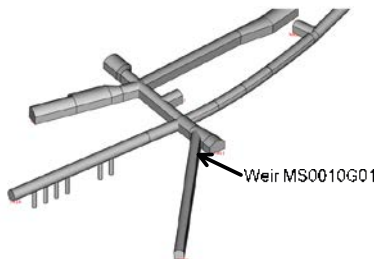
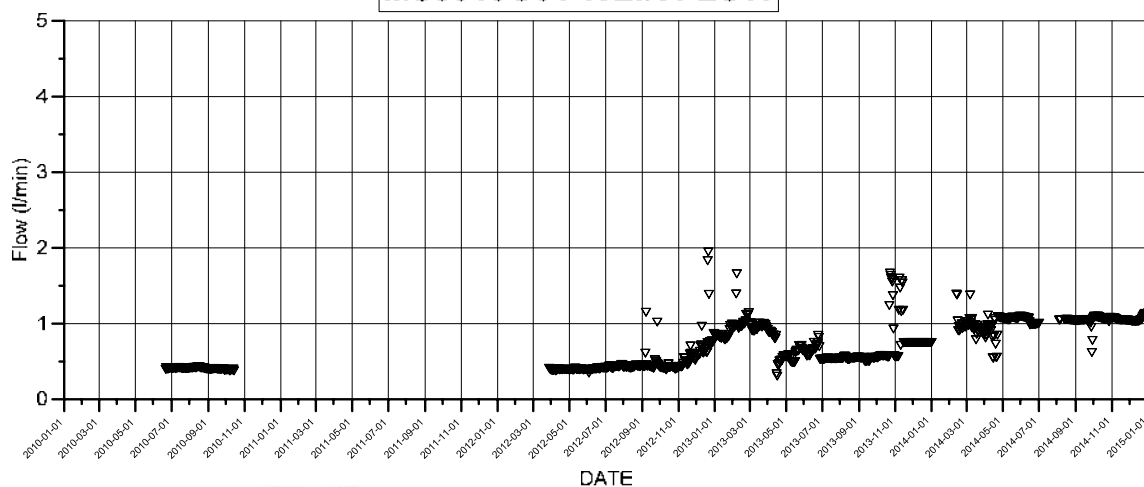
#### Events

- Start backfilling of section I 2001-09-03
- Stop backfilling of section I 2001-11-20
- Casting of inner plug finalized 2001-12-19
- Start backfilling of section II 2003-04-29
- Stop backfilling of section II 2003-06-27
- Casting of outer plug finalized 2003-09-11
- Packer failure of KA3573A 3 2006-04-18
- Start drilling of Fine Sealing Project 2007-03-12
- Start grouting of Fine Sealing Project 2007-11-19
- Excavation start of TASS tunnel 2007-12-11
- Excavation stop of TASS tunnel 2008-12-18
- Demolition work start Section II December 2010
- Demolition work Section II finalized 2011-12-15

WEIR MJ0033G

© MJ0033G GFF 2015-05-15

### MS0010G01 WEIR FLOW



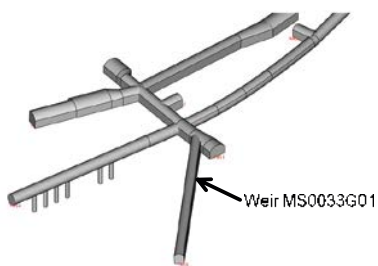
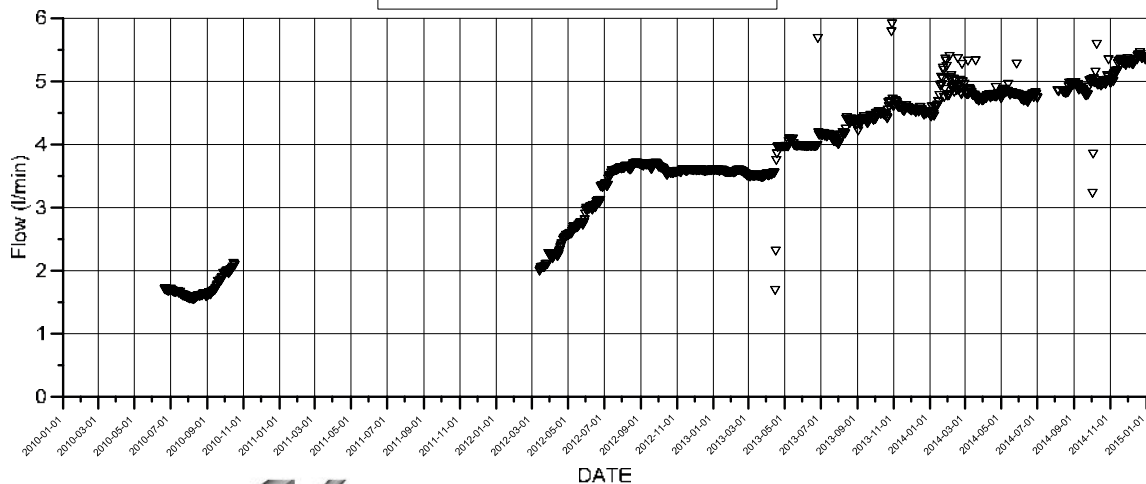
#### Events

- Start backfilling of section I 2001-09-03
- Stop backfilling of section I 2001-11-20
- Casting of inner plug finalized 2001-12-19
- Start backfilling of section II 2003-04-29
- Stop backfilling of section II 2003-06-27
- Casting of outer plug finalized 2003-09-11
- Packer failure of KA3573A:3 2006-04-18
- Start drilling of Fine Sealing Project 2007-03-12
- Start grouting of Fine Sealing Project 2007-11-19
- Excavation start of TASS tunnel 2007-12-11
- Excavation stop of TASS tunnel 2008-12-18
- Demolition work start Section II December 2010
- Demolition work Section II finalized 2011-12-15

WEIR MS0010G01

© MS0010G01 GFF 2015-06-23

### MS0033G01 WEIR FLOW

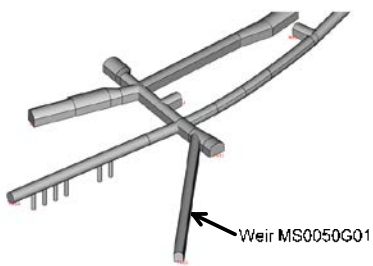
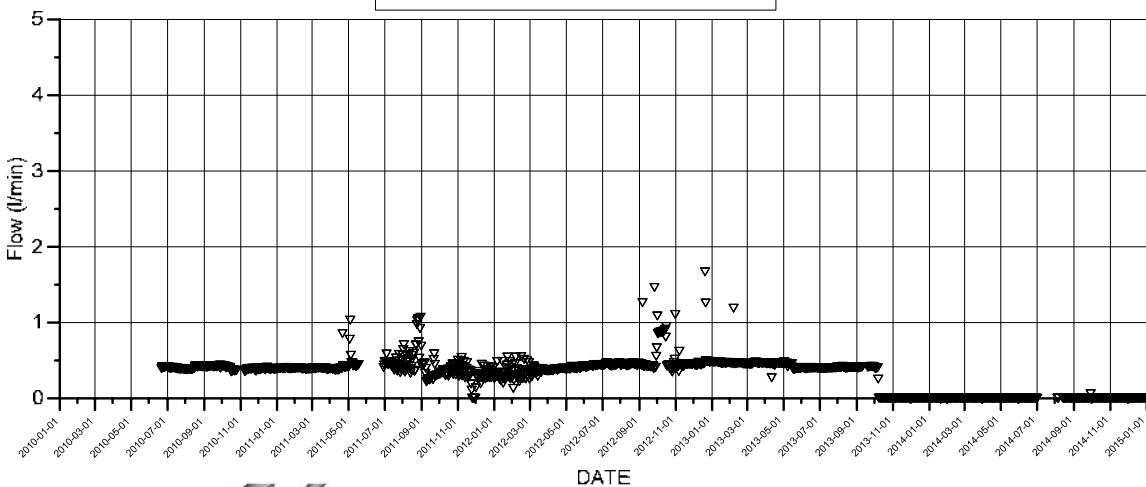


- Events**
- Start backfilling of section I 2001-09-03
  - Stop backfilling of section I 2001-11-20
  - Casting of inner plug finalized 2001-12-19
  - Start backfilling of section II 2003-04-29
  - Stop backfilling of section II 2003-06-27
  - Casting of outer plug finalized 2003-09-11
  - Packer failure of KA3573A:3 2006-04-18
  - Start drilling of Fine Sealing Project 2007-03-12
  - Start grouting of Fine Sealing Project 2007-11-19
  - Excavation start of TASS tunnel 2007-12-11
  - Excavation stop of TASS tunnel 2008-12-18
  - Demolition work start Section II December 2010
  - Demolition work Section II finalized 2011-12-15

▽ WEIR MS0033G01

© MS0033G01 GPF 2015-06-15

### MS0050G01 WEIR FLOW



- Events**
- Start backfilling of section I 2001-09-03
  - Stop backfilling of section I 2001-11-20
  - Casting of inner plug finalized 2001-12-19
  - Start backfilling of section II 2003-04-29
  - Stop backfilling of section II 2003-06-27
  - Casting of outer plug finalized 2003-09-11
  - Packer failure of KA3573A:3 2006-04-18
  - Start drilling of Fine Sealing Project 2007-03-12
  - Start grouting of Fine Sealing Project 2007-11-19
  - Excavation start of TASS tunnel 2007-12-11
  - Excavation stop of TASS tunnel 2008-12-18
  - Demolition work start Section II December 2010
  - Demolition work Section II finalized 2011-12-15

▽ WEIR MS0050G01

© MS0050G01 GPF 2015-05-15

