

System design of backfill

Full scale production test of backfill blocks

Torbjörn Sandén, Linus Andersson, Victor Jensen
Clay Technology AB

January 2015

Svensk Kärnbränslehantering AB
Swedish Nuclear Fuel
and Waste Management Co
Box 250, SE-101 24 Stockholm
Phone +46 8 459 84 00



ISSN 1651-4416

SKB P-14-24

ID 1356316

System design of backfill

Full scale production test of backfill blocks

Torbjörn Sandén, Linus Andersson, Victor Jensen
Clay Technology AB

January 2015

Keywords: Bentonite, Backfill, Block compaction, KBP1003.

This report concerns a study which was conducted for SKB. The conclusions and viewpoints presented in the report are those of the authors. SKB may draw modified conclusions, based on additional literature sources and/or expert opinions.

Data in SKB's database can be changed for different reasons. Minor changes in SKB's database will not necessarily result in a revised report. Data revisions may also be presented as supplements, available at www.skb.se.

A pdf version of this document can be downloaded from www.skb.se.

Abstract

The main alternative for backfilling of deposition tunnels considered by SKB includes emplacement of pre-compacted blocks into approx. 70% of the tunnel volume. The rest of the tunnel volume i.e. slots between block and tunnel walls is planned to be filled with bentonite pellets. Pellets will also be placed on the tunnel floor in order to provide an even surface on which the backfill blocks can be stacked. The backfill blocks will be installed in the deposition tunnels with the so-called robot method. Since the robot will need in average about one minute for the emplacement of each block, the blocks must have a certain size in order to backfill the tunnel at the desired rate (6 meter backfill/day). In order to emplace the blocks in the deposition tunnel in a controlled way, it must be possible to handle them in a secure way (vacuum lifting) and they must keep together (no cracks or loose material) and have the intended dimensions.

This report contains results from backfill block manufacturing tests performed in full scale at Höganäs Bjuv AB. In the development of the robot method a new block size was chosen and a new mould for block manufacturing constructed. The block size have been optimized with respect to tunnel size, the developed pattern of stacked blocks, and the capacity of the robot that will be used for emplacement and also with respect to the capacity of the available press for block manufacturing. The blocks will have a size of 571×500×400 mm and have a weight of 228 kg.

Three batches of candidate backfill materials have been used in this work; 250 tons of bentonite from Ashapura, India delivered in 2010, 100 tons of bentonite from Ibeco, Greece delivered in 2011 and 600 tons of bentonite from Ashapura, India delivered in 2012. In addition two other materials were tested, Minelco and MX-80. Minelco was introduced late in the process as a backup material since there were some problems with the initial compaction tests in full scale with the Asha 2010 material. MX-80 is SKB's reference material for the buffer and is also planned to be used as sealing material behind a deposition tunnel plug. For that purpose also this material was added to the test matrix. Extensive investigations of the delivered materials have been done in laboratory. The investigations included determination of compaction properties at different water contents and pressure, grain size distribution of delivered material and the influence of friction between bentonite and the mould on the homogeneity of compacted samples. The delivered Asha 2010 material contained a rather large amount of coarse material and the initial tests in full scale showed that the obtained block quality was rather bad with very brittle edges. After having performed tests in both laboratory scale and in full scale, with the coarsest material sieved away before compaction it was decided to crush this bentonite in order to increase the block quality.

The blocks have been checked regarding homogeneity by drilling cores at different positions. The cores have then been sawed in slices and the density and water content determined at different levels. These investigations have shown that there is a certain density gradient in all blocks. The gradient is obvious at the corners, decreases at the midpoint of the sides and is almost negligible at the centre of the blocks. The density gradient is not expected to influence neither the block handling nor the final density of the backfilling.

The tests in full scale have shown that it is possible to manufacture blocks of this size with high quality. The same type of press that was used in these tests can be used in a future manufacturing plant. This press should, however, be designed to yield the right filling height and there should also be access to vacuum during compaction.

Sammanfattning

Det huvudalternativ för återfyllning av deponeringstunnlar som övervägs av SKB innebär att förkompakterade block staplas i tunnarna och fyller cirka 70 % av tunnelvolymen. Resterande tunnelvolym dvs. spalterna mellan block och tunnelväggar planeras att fyllas med bentonitpelletar. Pelletar kommer också att placeras på golvet för att skapa ett jämnt underlag på vilket blocken kan staplas. Återfyllningsblocken kommer att placeras i tunneln med den s.k. robotmetoden, vilket innebär att blocken måste ha en viss storlek eftersom roboten kommer att behöva cirka en minut för inplaceringen av varje block. För att blocken ska kunna placeras i tunneln på ett kontrollerat sätt måste de kunna lyftas säkert. Planen är att använda vacuumlyftdon för att åstadkomma detta. Blocken måste hålla ihop (inga sprickor eller löst material) och ha de avsedda dimensionerna.

Denna rapport innehåller resultat från de tillverkningstester av återfyllningsblock som har genomförts på Höganäs Bjuf AB. I samband med utvecklingen av robotmetoden valdes en ny blockstorlek och en form för tillverkning av block i denna storlek har konstruerats. Blockstorleken är optimerad med avseende på tunnelstorlek, det valda mönstret för staplingen, kapaciteten hos roboten men också med hänsyn tagen till kapaciteten hos den press som var tillgänglig för testerna. Blocken kommer att ha en storlek på 571×500×400 mm och ha en vikt på cirka 228 kg.

Tre omgångar av olika tänkbara återfyllningsmaterial har levererats. Under vintern 2010 leverades 250 ton från Ashapura, Indien, under våren 2011 levererades 100 ton från Ibeco, Grekland och sommaren 2012 levererades 600 ton från Ashapura, Indien. Förutom dessa material har även två andra testats, Minelco och MX-80. Minelco tillkom senare som ett reservmaterial eftersom det inledningsvis fanns problem vid tillverkningen av block av Asha 2010. MX-80 är SKB:s referensmaterial för bufferten och planeras även att användas som tätningsmaterial bakom deponeringstunnelpluggarna. Eftersom det då ska pressas block av detta material lades även detta till som en del i testerna. De material som har testats för blockpressning har även undersökts i laboratoriet. Försöken har innefattat bestämningar av kompakteringsegenskaper vid olika vatteninnehåll och tryck, kornstorleksfördelning och även hur friktionen påverkar homogeniteten hos de kompakterade blocken. Det Asha-material som levererades innehöll en ganska stor andel grovt material och de inledande försöken resulterade i block med låg kvalitet när det gällde alla hörn som var väldigt spröda. Efter att ha genomfört tester i både laboratorium och full skala där det grövre materialet i Asha 2010 hade siktats bort beslöts det att krossa detta material för att öka blockkvaliteten.

Blocken har undersökts när det gäller homogenitet genom att borra ut kärnor från olika positioner. Från kärnorna har det sågats ut skivor där det har bestämts densitet och vatteninnehåll på olika nivåer. Undersökningarna har visat att det finns en viss densitetsgradient i alla block. Gradienten är tydlig i hörnen på blocken, minskar på mitten av långsidorna och är närmast försumbar i centrum av blocken. Densitetsgradienterna förväntas inte påverka vare sig blockhantering eller den slutliga densiteten hos återfyllningen.

Testerna i full skala har visat att det är möjligt att tillverka block i denna storlek med hög kvalitet. Samma typ av press som har använts i dessa tester kan användas i en framtida fabrik för tillverkning av återfyllningsblock. Dock bör pressen vara designad för att erhålla tillräcklig fyllhöjd i formen och det bör också finnas tillgång till vacuum under pressningen.

Contents

1	Introduction	7
2	Material and requirements	9
2.1	General	9
2.2	Materials	10
2.3	Backfill block requirements	10
3	Material properties determined in laboratory	11
3.1	General	11
3.2	Granule size distribution	11
3.2.1	General	11
3.2.2	Method	11
3.2.3	Results	11
3.2.4	Crushing the Asha 2010 material	12
3.3	Compaction properties	14
3.4	Bulk density	15
3.5	Influence of grain size distribution regarding block quality of the Asha 2010 material-small scale laboratory investigation	16
3.6	Influence of friction	18
3.6.1	General	18
3.6.2	Test description	18
3.6.3	Results	19
3.6.4	Conclusions and comments	22
4	Manufacturing description and quality control	23
4.1	General	23
4.2	Block sizes	23
4.2.1	Brick size	23
4.2.2	Full scale	23
4.3	New mould	23
4.3.1	General	23
4.3.2	New mould I	24
4.3.3	Elastic expansion	24
4.3.4	New mould II	24
4.4	Pressing principle	25
4.4.1	General	25
4.4.2	Filling factor	25
4.4.3	Two step compaction	26
4.4.4	Trapped air	27
4.5	Block handling	27
4.6	Quality control of compacted blocks	28
4.6.1	General	28
4.6.2	Laboratory determinations	28
4.6.3	Sampling brick size blocks	28
4.6.4	Sampling of full scale backfill blocks	29
5	Block compaction at Höganäs Bjuf AB	31
5.1	General	31
5.1.1	Block manufacturing with brick size blocks	31
5.1.2	Block manufacturing in full scale, new mould I	31
5.1.3	Block manufacturing in full scale, new mould II	31
5.2	Höganäs Bjuf AB, January/June 2011, brick size blocks	31
5.2.1	General test description	31
5.2.2	Results	32
5.3	Höganäs Bjuf AB, June 2011, brick size blocks	35
5.3.1	General test description	35
5.3.2	Results	35

5.4	Höganäs Bjuf AB, February 15 2011, full scale blocks	36
5.4.1	General test description	36
5.4.2	Results	36
5.4.3	Block investigations	36
5.5	Höganäs Bjuf AB, February 19, 2011, full scale blocks	38
5.5.1	General test description	38
5.5.2	Test description and results	38
5.5.3	Block investigations	41
5.6	Höganäs Bjuf AB, February 26, 2011, full scale blocks	42
5.6.1	General test description	42
5.6.2	Test description and results	42
5.6.3	Block investigations	42
5.7	Höganäs Bjuf AB, July 4–5, 2011, full scale blocks	45
5.7.1	General test description	45
5.7.2	Test description and results	46
5.7.3	Block investigations	46
5.8	Höganäs Bjuf AB, November 14–15, 2011, full scale blocks	52
5.8.1	General test description	52
5.8.2	Test description and results	53
5.8.3	Block investigations	57
5.9	Höganäs Bjuf AB, Februari 18, 2013, full scale blocks	60
5.9.1	General test description	60
5.9.2	Test description and results	60
6	Summary and conclusions	65
6.1	General	65
6.2	Material tests in laboratory	65
6.2.1	General	65
6.2.2	Grain size distribution	65
6.2.3	Compaction properties	66
6.3	Manufacturing of brick size blocks	66
6.4	Manufacturing of full scale blocks	67
6.4.1	General	67
6.4.2	Press cycle and moulds	67
6.4.3	Block quality	67
6.4.4	Technical aspects	67
6.5	Recommendations and conclusions	68
	References	69
Appendix 1	Ibeco RWC-BF 2010	71
Appendix 2	Asha NW BFL-L 2010	73
Appendix 3	Volclay MX-80	75

1 Introduction

One of the main objectives with this work was to verify that backfill blocks can be manufactured with controlled properties and quality in industrial scale.

The reference technique for backfilling of deposition tunnels in the KBS3-V concept is to use pre-compacted blocks together with a filling of pellets close to the tunnel wall (Figure 1-1). In the suggested reference technique, the blocks will be emplaced one by one by a robot, programmed to stack blocks in the tunnel according to a prescribed pattern. After a section of the deposition drift have been filled with blocks, bentonite pellets will be blown into the remaining slot between blocks and rock.

The chosen method implies that the backfill blocks must have a certain size in order to fill up the tunnel within the desired time i.e. six meter tunnel should be filled with backfill every 24 hours. The calculated time for the robot for emplacement of one backfill block is one minute. With the selected block size in this project, 500×571×400 mm, about 900 blocks must be emplaced every 24 hours. This will take about 15 hours of effective robot work. The remaining hours will be needed for preparation of the pellet bed, blowing pellet into the slot, block handling and maintenance.

The block manufacturing in full scale described in this report was performed at Höganäs Bjuf AB. The ordinary production at this company is manufacturing of refractory bricks. In this kind of production suitable hydraulic presses are available and also other equipment needed for the block handling, packaging of blocks on pallets and storing.

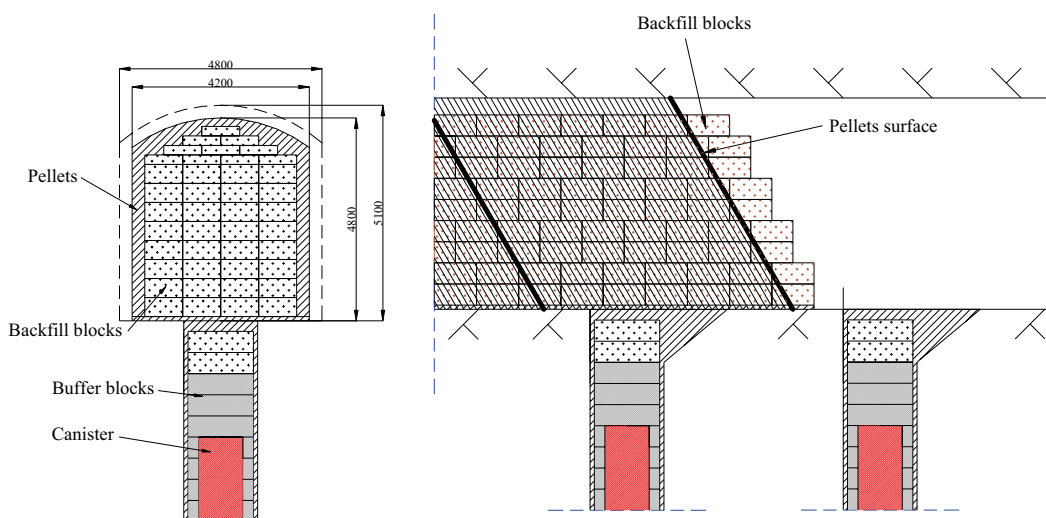

Figure 1-1. Schematic showing the principle design of the backfilling.

2 Material and requirements

2.1 General

In the backfill production report (SKB 2010), a reference design of backfill blocks is presented. The design can be compiled as follows:

- **Material.** The reference material is a bentonite clay with a montmorillonite content of 50–60% (accepted variation is 45–90%). Content of sulphide, sulphur and organic carbon will be determined during production. No limits have yet been specified.
- **Density.** The dry density of the compacted block should be $1,700 \text{ kg/m}^3$ ($\pm 50 \text{ kg/m}^3$).
- **Block dimensions.** According to the reference design, two block sizes will be used, 1) $700 \times 667 \times 510 \text{ mm}$ and 2) $700 \times 600 \times 250 \text{ mm}$. The accuracy of the dimensions is $\pm 2 \text{ mm}$.
- **Water content.** As in the material ready for compaction ($17 \pm 2\%$).

In order to optimize the design, changes of the reference design have been suggested. In the reference design described in the backfill production report (SKB 2010), there are two sizes of the backfill blocks (see above). In order to facilitate logistic and installation procedure it was desirable to instead only have one block size.

A new block size has been chosen, $500 \times 571 \times 400 \text{ mm}$. The new block size has been optimized with respect to the following:

- Size of the deposition tunnel.
- The developed pattern of the stacked blocks.
- The capacity of the robot that will be used for emplacement.
- The capacity of available press for backfill blocks manufacturing.

This report describes the tests made in order to verify that it is possible to manufacture blocks with the suggested size and quality.



Figure 2-1. Photo showing the different materials used in the tests.

2.2 Materials

In the tests performed at Höganäs Bjuf AB, blocks have been manufactured out of five different materials/batches. Two of the materials, IBECO RWC-BF and Asha NW BFL-L, were chosen since they were judged as possible backfill candidate materials. The Minelco material was introduced late in the process with the purpose to have a backup material since problems were experienced with the quality of the Asha blocks at the initial stage of the project. These problems were, however, later solved.

The MX-80 material is of interest as a sealing material in contact with the deposition tunnel end plug and the tests performed in this scale were performed in order to get input for a later production for the construction of a plug.

The materials tested can be described as follows (Figure 2-1):

1. IBECO RWC-BF 2011 (in the report abbreviated to IBECO) is a material that originates from Milos in Greece. IBECO is the name of the company delivering the material, RWC stands for Radioactive Waste Clay and BF stands for BackFill. It is a natural calcium bentonite with medium montmorillonite content.
2. ASHA NW BFL-L 2010 (in the report abbreviated to ASHA 2010) is produced by Ashapura Minechem Co. The material is quarried in the Kutch area on the northwest coast of India. The material is sodium dominated with a montmorillonite content of about 70%.
3. ASHA NW BFL-L 2012 (in the report abbreviated to ASHA 2012). Same material as described above, but a different batch where the granules had been crushed in order to achieve a more suitable granule size distribution. This material was, as the name implies, delivered in 2012 and has not been a part of all laboratory pre-investigations.
4. MX-80 bentonite from Wyoming, USA. The material is produced by American Colloid Co. It is a natural sodium bentonite with a high content of montmorillonite. MX-80 is SKB's reference material for the buffer. The material tested was taken from the storage at Äspö HRL.
5. MINELCO is a Greece bentonite quarried at the island of Milos. The material is a sodium activated bentonite imported to Sweden by LKAB, who is using it as a binder in the production of iron ore pellets. The material tested was taken from the storage at Äspö HRL.

A characterization of the backfill candidate materials, Asha and Ibeco, regarding hydro mechanical properties together with chemical and mineralogical tests, has also been made within another project (Sandén et al. 2014). Data sheets (Asha and Ibeco) and technical data (MX-80) are provided in Appendix 1–3.

2.3 Backfill block requirements

The block requirements can be divided in two parts, technical and practical. The technical requirements are e.g. the dry density (1,650–1,750 kg/m³) and the montmorillonite content of the material (45–90%).

The practical requirements concern mainly the manageability i.e. the possibility to lift the blocks with the robot without dropping material. If parts of a block fall down on the block stack, there will be problems with the next block layer since the blocks will be inclined. This will not be acceptable since it will affect the quality of the backfill both regarding achieved density but also regarding the possibility to build a stable stack.

The two main practical requirements regarding the blocks are:

1. **Loose material.** If there are loose material on the block after compaction (vertical edges), this has to be removed before the stacking of blocks start. This can be done at the same time as the block is removed from the press e.g. the robot, handling the blocks in the factory, can brush the edges before lifting the block and placing it on a pallet.
2. **Cracks in the blocks.** The blocks should be visually inspected and/or tested regarding the presence of cracks.

The investigations performed on the manufactured blocks, described in this report, have focused on the measurable quality i.e. if there are cracks or loose material, sharpness of edges and the density distribution within the blocks. The strength of the blocks and the possibility to handle them with a vacuum lifting device has been tested and is reported in Sandén et al. (2014).

3 Material properties determined in laboratory

3.1 General

The properties of the raw material influence the achieved block quality strongly. Important material parameters are e.g.:

- **Mineral composition.** Influences the friction during compaction, both internal in the material but also against the steel mould. The mineral composition influences probably also the stiffness of the granules and by that also the sharpness of the block edges. The materials tested in this report have been chosen as backfill candidate materials based on other considerations than the block compaction properties. It has not been an objective to investigate the influence of the mineral composition in this work.
- **Granule size distribution.** A certain granule size distribution is believed to be favorable in order to avoid trapped air in the block and also to increase the bulk density of the filling. This is favorable in order to minimize the filling height of the mould, see Section 4.
- **Water content.** Influences both internal friction of the material and external i.e. against the steel mould. Influences also the materials capability to “glue” together.

It is not fully understood how these parameters influences the achieved block quality and therefore it has been necessary to perform tests with each of the materials.

3.2 Granule size distribution

3.2.1 General

The influence of granule size distribution of the materials regarding the final block quality is not completely clear. It is, however, believed that a certain distribution is necessary in order to facilitate the de-airing during compaction and also to increase the bulk density of the loose filling which is important to minimize the needed filling height of the mould. The tests described in this report have been made with a press where it was not possible to use vacuum during compaction which means that the possibility to get rid of air in the material during compaction was an important factor.

3.2.2 Method

A sample of about 5 kg was taken from each of the big bags selected for this test. In order to get a smaller representative sample for the sieving, a 500 g subsample was obtained by use of a sample splitter.

The sieving was made using standard sieves but instead of using the vibrator the sieving was done manually in order to avoid crushing of the granules. This is not a standard method but since the interesting part was the size of the granules and not of the individual grain, this was judged to be the most suitable method.

3.2.3 Results

The granule size distribution was analyzed for all delivered material. The results from these measurements are provided in Figure 3-1.

As described in Chapter 5 in this report, problems occurred with the block quality when manufacturing blocks with the as-delivered Asha 2010 material. The problems mainly occurred in the block edges which were very brittle. The rather large granules in this material were believed to be the reason to this problem. As part of the trials to improve the block quality, tests were also performed with crushed material, see description in next section. The granule size distribution of the crushed material is also provided in Figure 3-1.

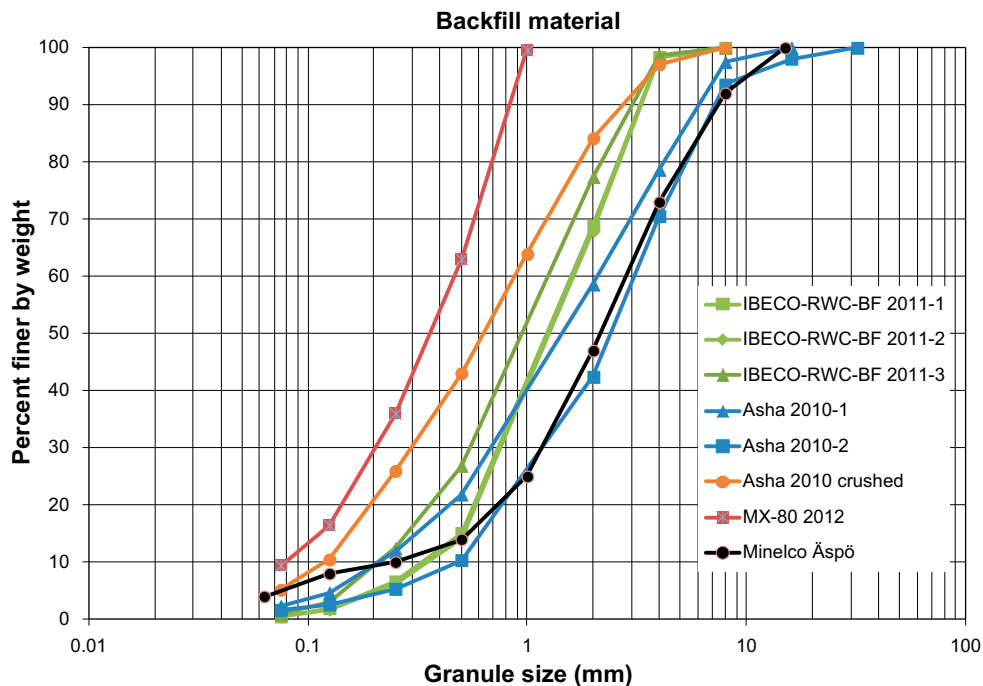

Figure 3-1. Granule size distribution for the materials tested for block compaction.

The granule size distribution of Minelco was very close to the as-delivered Asha 2010. The Minelco material was, however, easier to compact and the blocks had higher quality regarding e.g. the sharpness of the edges. This is believed to depend on the hardness of the granules. It was observed that the Asha 2010 granules seemed to be much harder and was thus not crushed during compaction. This was an observation made during the tests but no further investigation was made regarding this matter.

On the second batch delivered from Asha in 2012, a more extensive investigation of the granule size distribution was made in Sandén et al. (2014). The delivery specification for this batch was that all granules should have a size < 3 mm. In total twenty-five samples were picked out from the delivered big bags and investigated regarding the grain size distribution. The granule size distribution was very similar to that of the batch delivered in 2010. A visual inspection indicated that the material had been crushed between two rollers with a gap spacing of ~3 mm. This procedure had disintegrated, or reshaped, the large granules but at the same time new granules had been formed with a thickness of 3 mm and of various lengths and widths. This is the explanation for the similar granule size distribution determined for the two batches. The newly formed granules seem however, somewhat softer and later compaction tests have shown that the block quality was improved. The data on the granule size distribution have been used for calculating the average percentage finer by weight passing different mesh sizes (Figure 3-2). In addition the maximum and minimum percentage passing the different mesh sizes are presented together with the standard deviation.

3.2.4 Crushing the Asha 2010 material

The two backfill candidate materials, Asha 2010 and IBECO, were ordered with a certain grain size distribution and water content which were believed to be the optimum in order to manufacture block of good quality. The Asha 2010 material contained however a rather large amount of large granules which affected the block quality, especially regarding the edges which become very brittle, see descriptions in Chapter 5. About 20 tons of the Asha 2010 material was therefore crushed in order to get a more suitable grain size distribution.

A pre test was performed at Sandvik Rock Processing in Svedala, see photo of the equipment in Figure 3-3. After the pre test a large scale crushing was performed in a test plant situated in Dalby outside Lund (Figure 3-4). The crushing was made with a VSI crusher, Vertical Shaft Impactor. The crushing to a finer distribution was easy but the problems with dust were severe and it is recommended that this kind of work is performed in closed equipment.

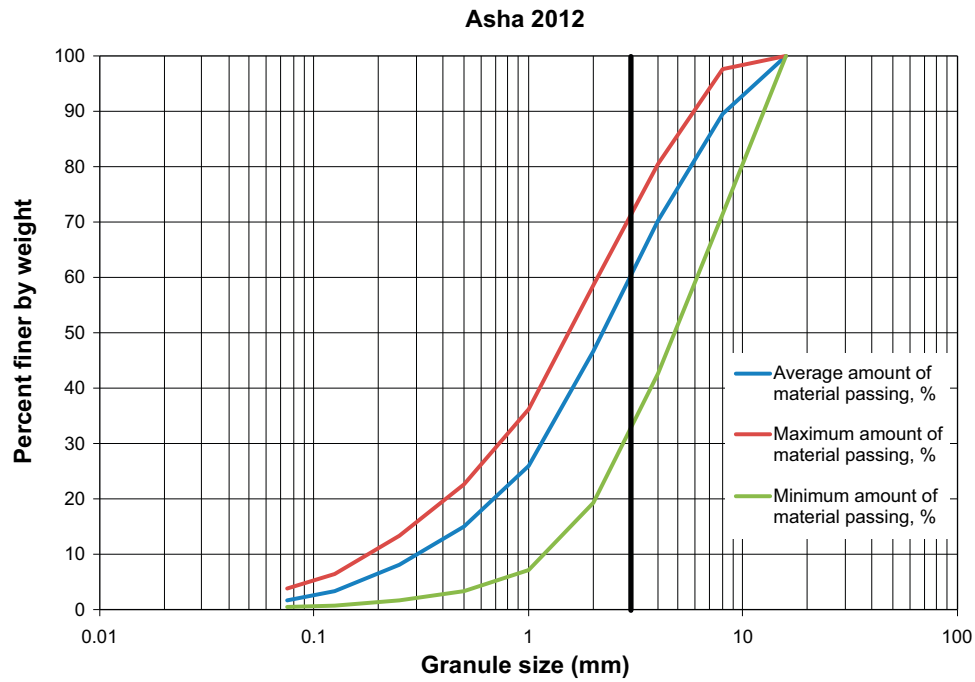

Figure 3-2. Granule size distribution for the materials tested for block compaction.



Figure 3-3. Photo of the equipment used at the laboratory at Sandvik Rock Processing in Svedala.



Figure 3-4. Photo of the large scale crushing of Asha 2010. The work was performed at a test plant in Dalby.

3.3 Compaction properties

In order to achieve information regarding the compaction properties i.e. expected densities and block quality, small scale tests were performed in the laboratory. The tests were prepared and made in the following steps:

- Samples were taken from each of the investigated (Asha 2012 was not a part of this investigation) materials and mixed to different water contents (approximately 8 to 10 different water contents per material).
- The material was placed in a rigid form with an inner diameter of 50 mm. The amount of material was adjusted in order to get a final sample height of about 20 mm.
- The material was compacted at two different compaction pressures (25 MPa and 50 MPa).
- After compaction the density and water content of the samples were determined and the dry density and the void ratio calculated.

The results from the laboratory tests are shown in Figure 3-5. The achieved dry density is plotted as function of the water content. The black line in the figures corresponds to the dry density at full saturation, assuming a density of the solid particles of $\rho_s = 2,780 \text{ kg/m}^3$ (for Asha the density of the solids is $2,890 \text{ kg/m}^3$ and this is the reason for the points on the other side of the saturation line).

None of the materials showed an evident maximum. The expected dry density at a water content of 20% and at a compaction pressure of 50 MPa is about $1,700 \text{ kg/m}^3$ for Minelco and $1,750 \text{ kg/m}^3$ for IBECO and Asha 2010. The compaction properties of MX-80 and Asha 2012 were not determined within this project.

As described in Section 3.2.1, twenty tons of the Asha 2010 material was crushed in order to improve the block quality. A test compaction was made also on this material and the results are presented in Figure 3-6. The chart shows that the achieved dry densities are very similar to what was obtained with the uncrushed material.

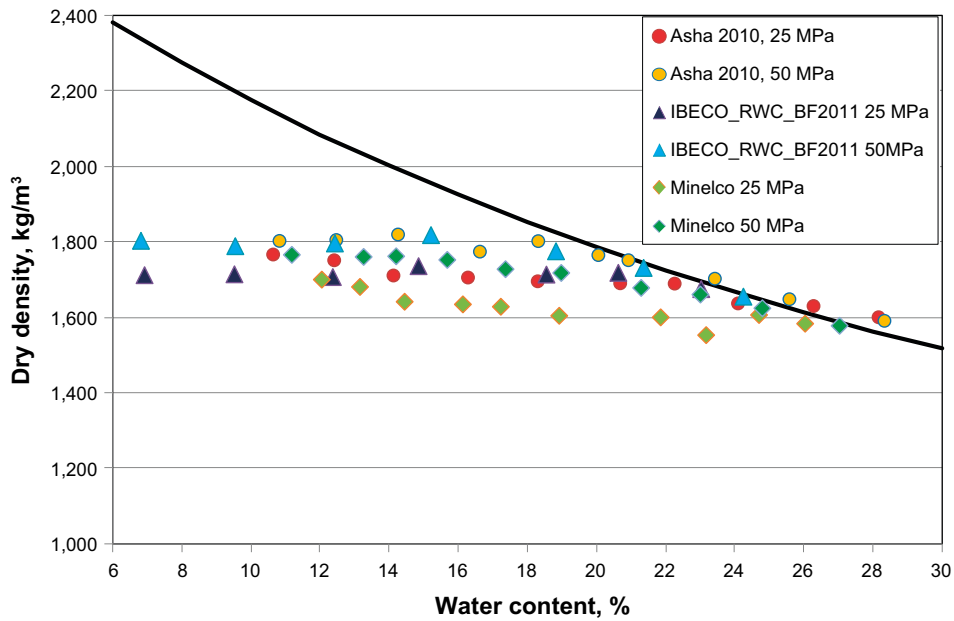

Figure 3-5. The dry density of samples from the three investigated materials compacted with two different compaction pressures (25 and 50 MPa) as function of the water content.

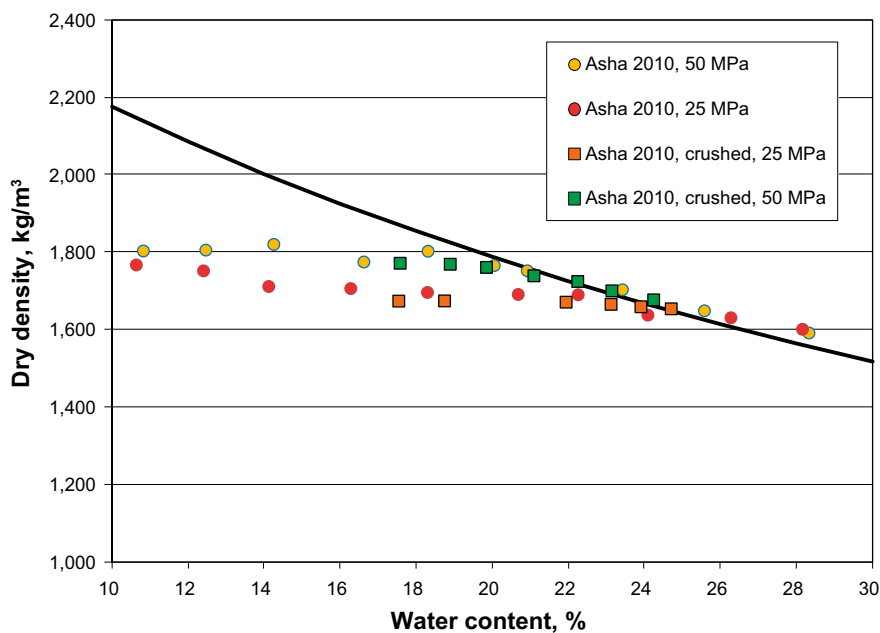

Figure 3-6. The figure shows a comparison of the laboratory compaction tests performed with Asha 2010 material before and after crushing. The dry density of the samples from is plotted as function of the water content.

3.4 Bulk density

The bulk density of the tested materials was determined by pouring the material into a graduated cylinder with a known volume (1 dm³). The sample was then weighed. The results are provided in Table 3-1. The bulk density will vary depending on the water content of the material but this influence has not been investigated.

Table 3-1. Bulk density of the materials tested for full scale block manufacturing.

Material	Bulk density, kg/m ³
Asha 2010 as-delivered (w=approx.16%)	1,207
Asha 2010 crushed (w=approx. 16%)	1,215
Asha 2012 as-delivered (w=approx. 16%)	1,206
lbeco as-delivered (w=approx.20%)	1,128
Minelco as-delivered (w=approx. 16%)	1,082
MX-80 (w=approx.17%)	1,215

3.5 Influence of grain size distribution regarding block quality of the Asha 2010 material-small scale laboratory investigation

The initial block compaction tests in full scale with the as-delivered Asha 2010 material showed that all block edges, and especially the four vertical, were very brittle. It was believed that the problem mainly depended on the granule size distribution of the material, see description in Section 3.2. In order to check the influence of the granule size distribution a small laboratory study was made on the as-delivered Asha 2010 material.

In the study five samples were compacted with a pressure of 30 MPa which is close to what was used in the full scale. The five samples were:

1. The as-delivered material with a water content of 16%.
2. The as-delivered material but conditioned to a water content of 20%.
3. All granules larger than 6 mm were removed before compaction. Water content of the remaining material was 15%.
4. All granules larger than 2 mm were removed before compaction. Water content of the remaining material was 15%.
5. All granules larger than 2 mm were removed before compaction. The material was after sieving conditioned to a water content of 20%.

A photo of the compacted samples is provided in Figure 3-7. The photo shows very clearly the difference in granule size between the different samples. The edges of all these samples were however very good, probably depending on the small scale.



Figure 3-7. Photo showing the samples after compaction.

The five samples were after compaction cut in the middle with a band saw. The five samples were after compaction cut in the middle with a band saw. Two of the samples, number 1 and 3, had very brittle edges while the other samples seemed to hold together better (Figure 3-8). The sawed samples were after inspection roughly broken by hand (Figure 3-9). It was felt that there was a difference in strength between the samples and when studying the surfaces at the break it could be seen that the samples containing large granules were more uneven and also that material fell of easy.

The conclusion from this investigation was:

1. The quality, defined as sharpness and strength of the edges, of the compacted samples increased when the largest granules were removed.
2. Conditioning of the material to a water content of about 20% will increase the quality.

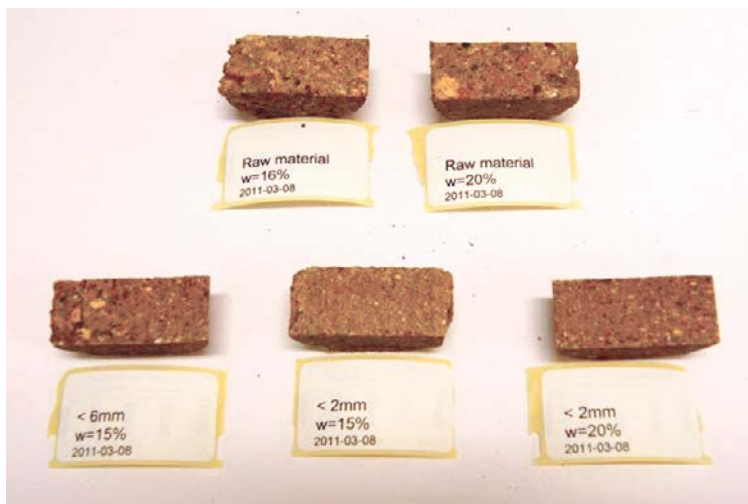

Figure 3-8. Photo showing the samples after division by a band saw.



Figure 3-9. Photo showing the samples after a rough break of the samples.

3.6 Influence of friction

3.6.1 General

A laboratory study has been made in order to study the influence of friction and how it affects the density distribution within the blocks. Another purpose was to investigate the possibility of developing a technique that could be used in laboratory in order to get an indication of how a specific material works when manufacturing in full scale.

3.6.2 Test description

The tests were performed in the same way as the compaction tests described in Section 3.3, but the height of the compacted sample was about five times higher. The compacted samples had a diameter of 50 mm and a height of about 100 mm, see photo provided in Figure 3-10. In order to get a uniform test matrix it was decided to use 400 g material for each of the samples.

The samples were compacted with a pressure of 25 and 50 MPa, and at different water contents (as-delivered, 20, 22 and 24%).

The expected information from these tests was:

1. **Filling factor.** After filling up the mould, the height of the un-compacted powder was measured. Together with the measurement of the compacted sample it was then possible to calculate the ratio between the bulk density of the compacted block and the bulk density of the un-compacted powder. This is an important parameter for the full scale manufacturing.
2. **De-moulding.** The maximum force needed for de-moulding was read (manometer scale) and noted. The read value will provide an indication if problems can be expected in the full scale.
3. **Density distribution.** After compaction each sample was cut in slices and the density and water content were determined at different levels, see description of methods provided in Section 4.6.2.

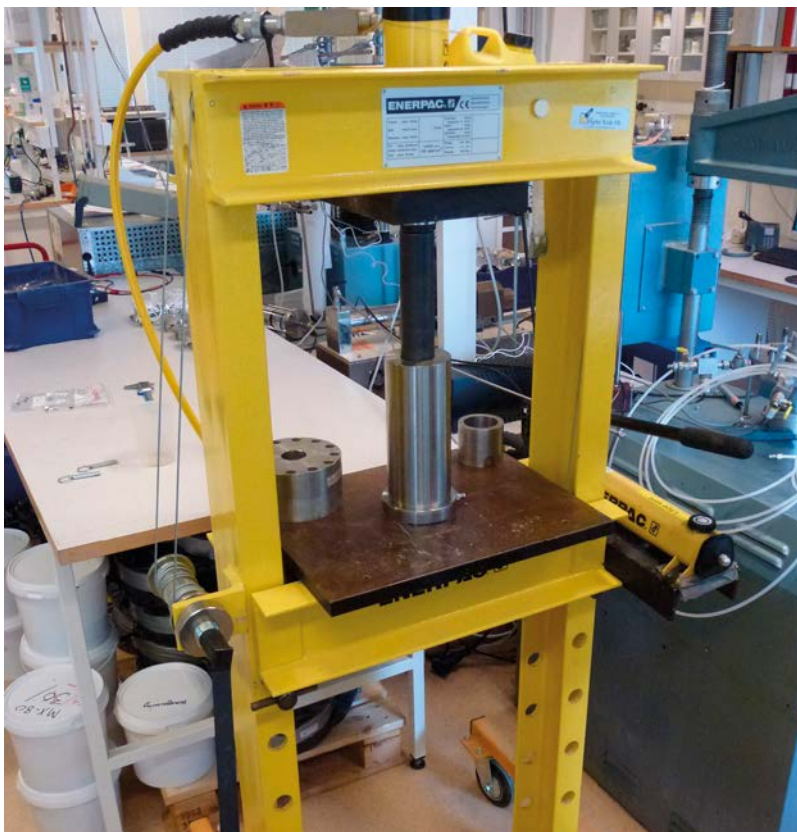

Figure 3-10. Photo of the test equipment and the hydraulic press used for compaction.

3.6.3 Results

Filling factor

The results from these measurements are provided in Figure 3-11. The figure shows clearly the differences between the different materials and the large influence of the water content. The data determined in these laboratory tests does not agree perfectly with what was achieved in the full scale, see Section 4.4.2. The filling factors determined in laboratory are somewhat higher than those determined in the full scale tests. The reason for this is probably the adverse shape of the mould used in laboratory where the ratio height/diameter is about 4 (un-compacted) compared to the full scale where the ratio is about 1.5 (the full scale mould has a rectangular shape which means that the comparison is not entirely correct).

De-moulding

The maximum force needed for de-moulding was read (manometer scale) and noted. In order to compare the values; the noted force was divided with the mantle surface of the compacted sample. The achieved average shear strength was then plotted versus the water content for all materials (Figure 3-12).

The conclusions from these tests can be compiled as follows:

- The influence of compaction pressure is clear. Higher compaction pressure increases the force needed for de-moulding. The drier material the larger difference in shear strength for different compaction pressures.
- No obvious difference between the materials can be observed. There is however a tendency that the shear strength of Asha 2010 samples is higher than of the other materials when compacted at 50 MPa.
- The shear strength dependency of the water content is strong. The shear strength decreases dramatically with increasing water contents.

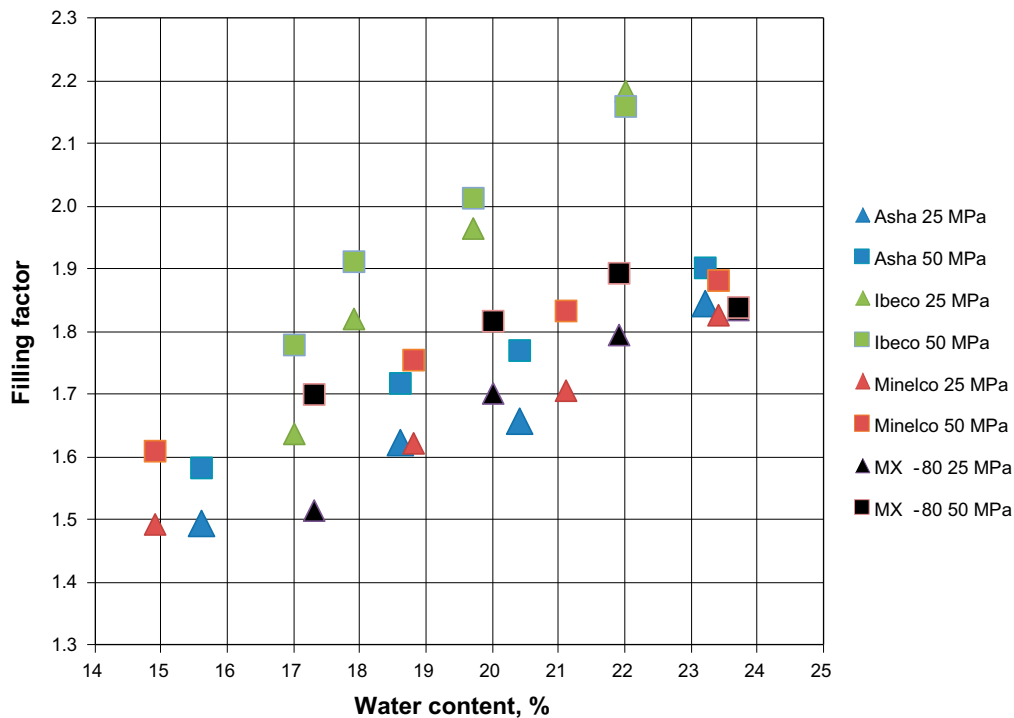

Figure 3-11. The filling factor (the density after compaction divided to the density before compaction) for different materials and compaction pressure plotted versus water content.

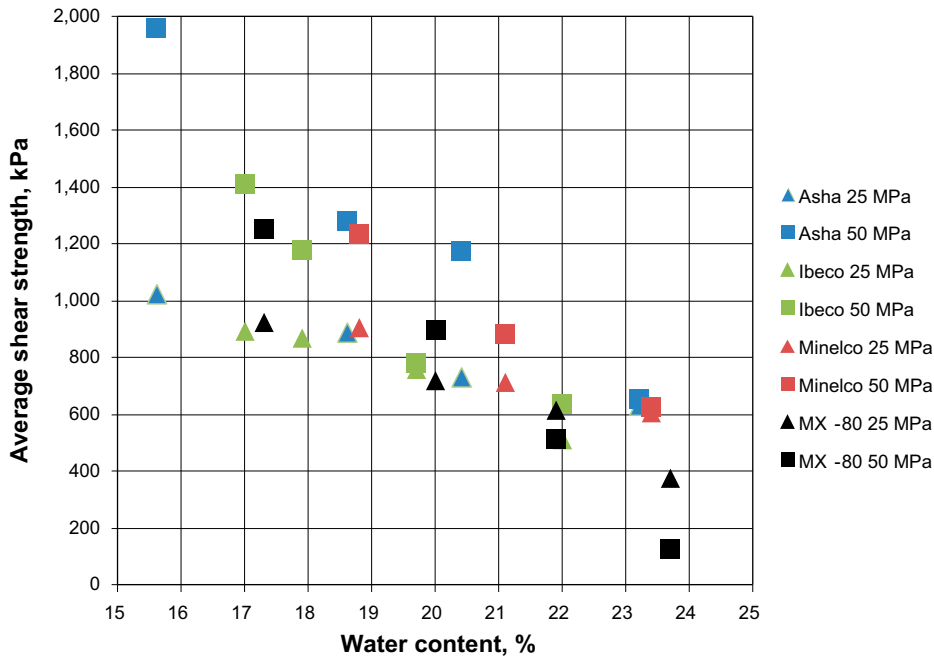

Figure 3-12. The average shear strength determined during de-moulding plotted versus water content.

Density distribution

The results from measurements of the density distribution are provided in Figure 3-13 to 3-16. All materials showed an evident density profile at all water contents except for the highest (24%) where the profiles are more even. The density profiles evaluated for Asha and Minelco are more uneven with jumps in the density measurements compared to MX-80 and Ibeco. The reason for this is probably the granule size distribution of these two materials, see Section 3.2. The amount of large granules is rather high and this in combination with the small scale, affects the quality (sharpness of edges and the possibility to saw out representative samples, see Section 3.4) of the compacted samples and by that also the accuracy of the determined densities.

The density profiles of Ibeco and MX-80 are rather even with smooth curves but the density gradient within the samples is rather high, especially for MX-80 with a water content of 17 and 20%.

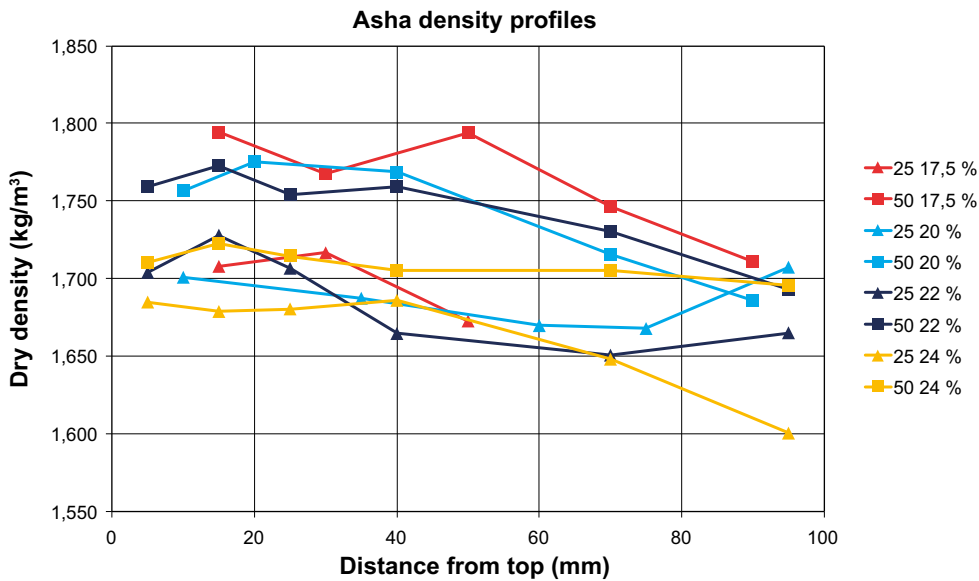

Figure 3-13. Measured dry density plotted versus distance from the top of the Asha 2010 samples.

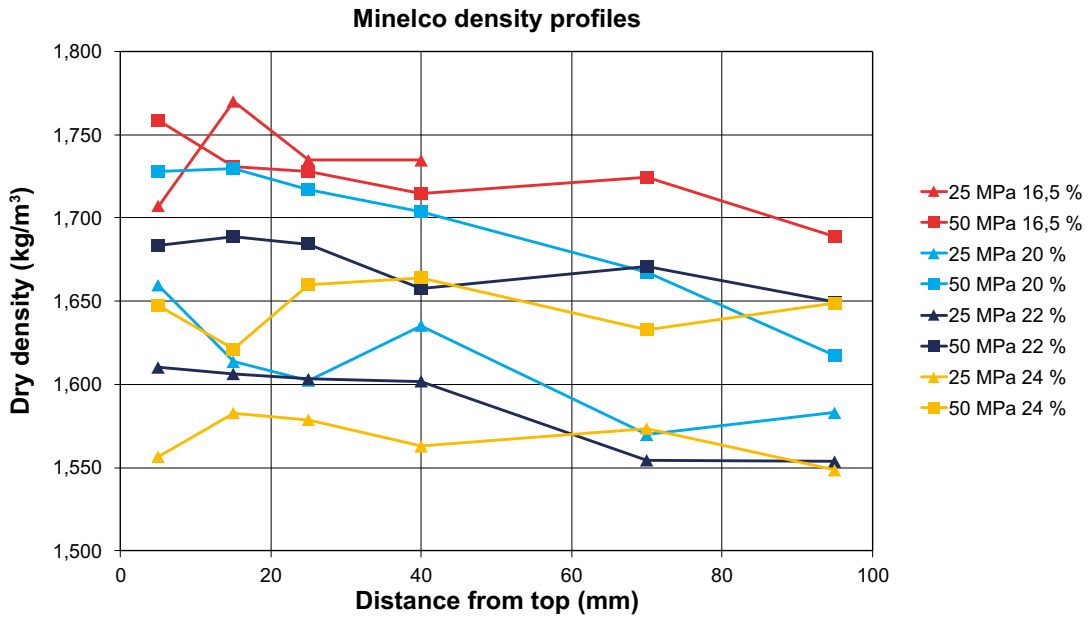

Figure 3-14. Measured dry density plotted versus distance from the top of the Minelco samples.

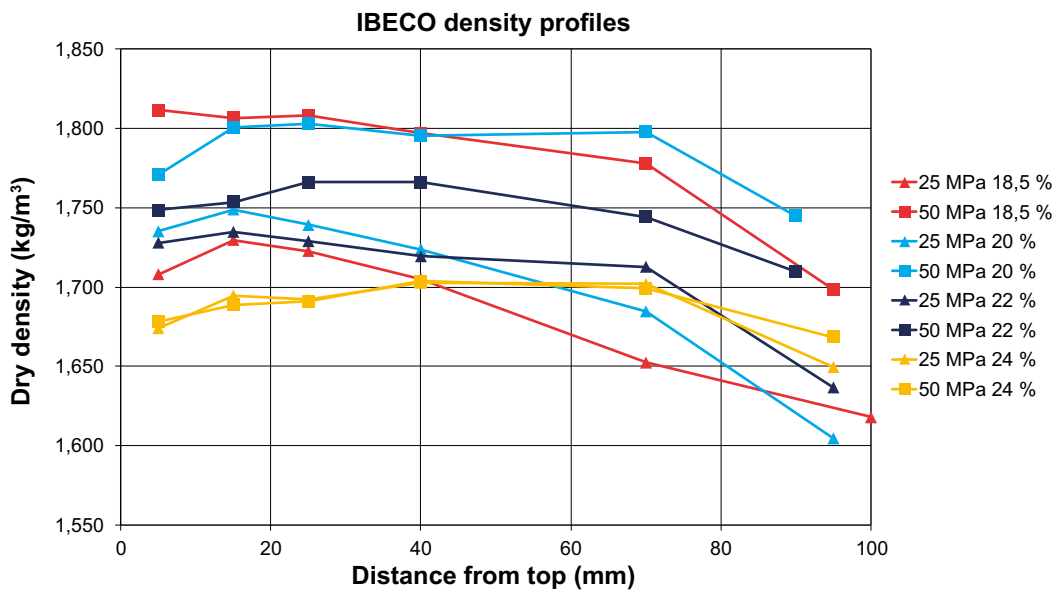

Figure 3-15. Measured dry density plotted versus distance from the top of the Ibeco samples.

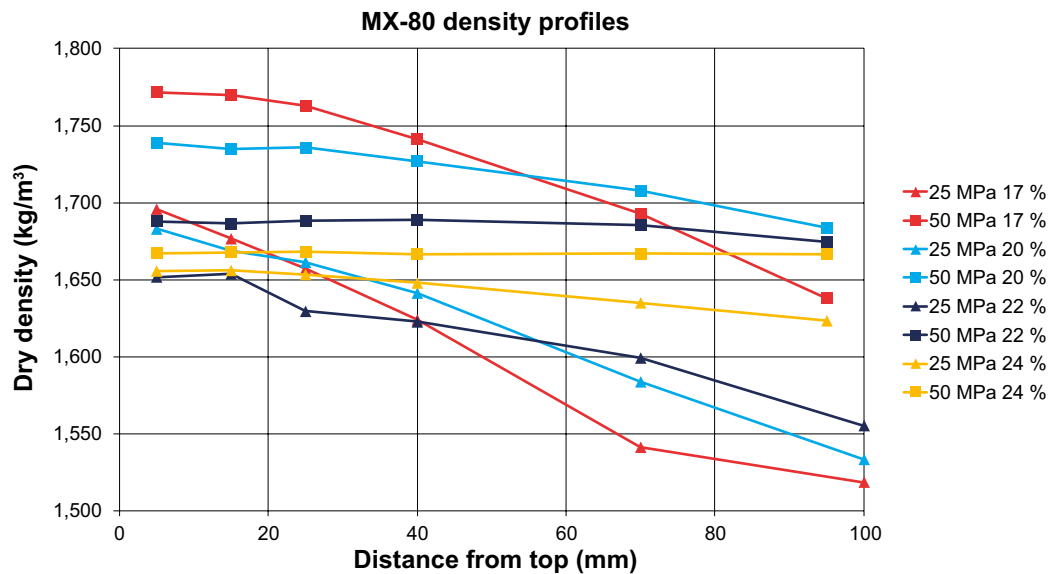

Figure 3-16. Measured dry density plotted versus distance from the top of the MX-80 samples.

3.6.4 Conclusions and comments

The results from these laboratory tests can be concluded as follows:

1. The filling factor of a certain material at certain water content can be determined in laboratory. In order to relate it to block manufacturing it will be necessary to use a mould which is more similar to the one used in full scale (shape and diameter /height ratio).
2. The higher water contents the higher filling factor. The available filling height could be a limitation for backfill block manufacturing in full scale. However, in a future backfill block manufacturing plant, the presses will probably be specially designed in order to achieve the desired filling height.
3. The tests give an indication of the force needed for de-moulding. The lower water contents of the bentonite the higher forces were needed for de-moulding. The highest forces were needed for the Asha material at low water content. This material also contained a lot of large granules which later was found to be the main reason for obtaining blocks with rather bad quality regarding the sharpness of the edges.
4. The influence of wall friction has been excessive i.e. the sample diameter have been small compared to the height (diameter=50 mm and height=160 to 220 mm) for the un-compacted powder. This has resulted in rather high density gradients in the compacted sample. Density gradients have also been measured in the full scale tests, see results provided in Chapter 5, but much less pronounced and especially in the last tests series, see Section 5.7 and 5.8, where the press cycle was optimized to the block size.
5. One objective with the performed laboratory tests was to get information regarding the behavior in full scale. The uneven density profiles of the Asha 2010 and Minelco material could be an indication of quality problems in full scale. However, problems occurred only with the Asha 2010 material but not with Minelco. There are obviously also other parameters affecting the achieved quality e.g. mineral composition and the hardness of the granules.
6. The disturbance from material containing large granules is very evident. This affects the sharpness of the block edges and influences also the sampling and accuracy of the density determinations.

4 Manufacturing description and quality control

4.1 General

The technique used for the full scale backfill block manufacturing is the same as used by the refractory production factory and includes a double sided pressing technique with controlled mould frame movement. The technique is normally used for blocks of brick size and not for the size required for backfilling of deposition tunnels. Two new moulds were manufactured within the project in order to achieve blocks with right dimensions. In addition a special vacuum tool for the block handling was developed.

In a future backfill block manufacturing factory it will be necessary to use specially designed presses which will facilitate the manufacturing and also save time. The special design concerns mainly the available filling height, see description below, the technique for filling up the mould and the access to vacuum in order to de-air the powder before compaction. The block handling in the factory must in the future be made by robots that can lift blocks of this size.

4.2 Block sizes

4.2.1 Brick size

Besides the manufacturing of full scale blocks also blocks of brick size have been manufactured. These blocks were needed for tests planned to be performed in half scale in the steel tunnel at Äspö HRL. The blocks have a size of 300×150×75 mm and a weight of about 6.5 kg. The manufacturing of these blocks was rather easy and the only problem discovered was that at some occasions the raw material stuck to the surface of the pistons which meant that after a certain time the press had to be stopped and the surfaces cleaned. The problem occurred mainly with the Ibeco material and was probably connected to the water content of the material that varied somewhat between the delivered big bags. The problem can probably be solved by choosing somewhat lower water content.

A compilation of data from the manufacturing is provided in Chapter 5.

4.2.2 Full scale

There was earlier a desire that the block height should be 500 mm instead of 400 mm in order to more efficiently fill up the deposition tunnels. The present height of 400 mm was chosen depending on limitations regarding the filling height (the filling height is the height needed in order to fill up a mould with powder and then compact the material to the desired height) of the presses available. When designing a future backfill block manufacturing factory, it will be possible to buy new presses with specific design allowing for these special demands.

The new block size, Figure 4-1, have a weight of about 228 kg (with a bulk density of 2,000 kg/m³). The blocks will be manufactured with a compaction pressure between 20–50 MPa corresponding to a load of 5,700–14,250 kN.

4.3 New mould

4.3.1 General

The development of the backfill design includes a full scale test where a part of a deposition tunnel will be filled with blocks and pellets according to the proposed new design. In order to test the possibility of manufacturing blocks of this size but also to manufacture blocks of the right size for the full scale test a new mould with the right dimensions was built. Later one additional mould equipped with a small radius in the four vertical corners was built in order to improve the block quality.

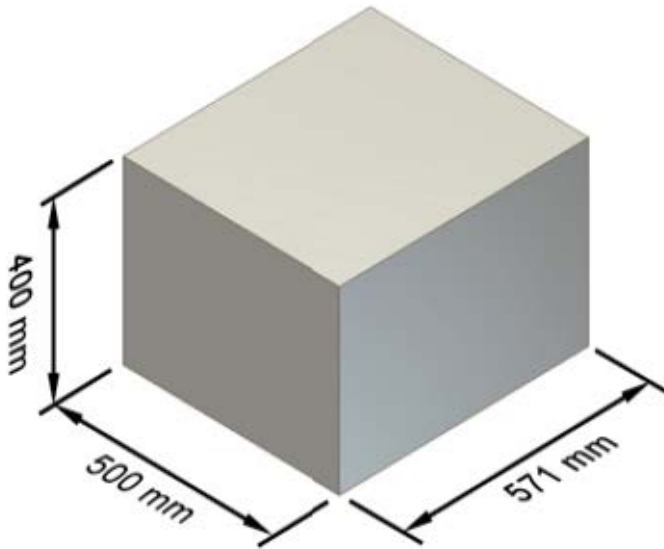

Figure 4-1. Picture showing the new block size.

4.3.2 New mould I

The manufacturing tests were performed at Högånäs Bjuf AB. The press used for the new mould was manufactured by SACMI and had a maximum capacity of 1,600 ton (15,700 kN). Another press with the same capacity but manufactured by LAEIS was also available but it was judged that it was possible to get a higher filling height in the SACMI press. The maximum filling height of the new mould was 560 mm which is too low in order to manufacture blocks with a height of 400 mm. With this limited filling height it was necessary to introduce a two step compaction with an extra filling of material between the compaction steps, see detailed description in Chapter 4.4. The new mould was designed by constructors at Högånäs Bjuf AB (Figure 4-2).

4.3.3 Elastic expansion

Based on results from earlier compaction tests in laboratory scale but also on tests performed at a test plant in LAEIS in Germany it was judged that the elastic expansion of the blocks should be about 1% in all directions which means that the size of the mould was decided to be 495×565 mm. The results from the new tests, see Chapter 5, showed however that the elastic expansion after demoulding was closer to 0.5% for most of the blocks.

4.3.4 New mould II

The first version of the full scale mould had two main disadvantages:

1. The filling height was limited, which resulted in a two step compaction cycle (see Section 4.4.3). With a higher filling height it would be possible to compact blocks without an additional filling of material and this will probably increase the block quality but will also save time.
2. The initial tests showed that the four vertical edges were rather brittle. The reason for this was believed to be the sharp corners in the mould.

Depending on the disadvantages with the mould it was decided to build a new version. The new mould was more complicated and used all available space in the press which made it possible to increase the filling height to 685 mm. In addition the mould was equipped with a radius of 5 mm in the four vertical corners.



Figure 4-2. Photo showing the new mould after installation in the SACMI press.

4.4 Pressing principle

4.4.1 General

The manufacturing technique used within the refractory brick industry includes a double sided pressing principle with controlled mould frame movement (Figure 4-3). The speed of the mould is about half of the speed of the upper die. The friction between the compacted material and the mould is by this technique reduced which results in a more even density distribution in the blocks.

4.4.2 Filling factor

The filling factor is defined as the ratio between the bulk density of the compacted block and the bulk density of the powder or granules when poured into the mould. The filling factor varies for different materials depending on:

- Water content.
- Mineralogical composition.
- Applied load and by that achieved density.

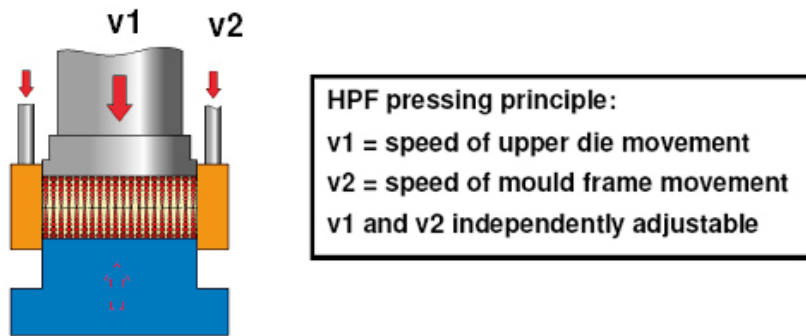

Figure 4-3. Picture showing the principle for HPF pressing. In order to achieve as homogenous blocks as possible, the outer mould is moved during compaction with a speed about half of the speeds of the upper die.

The filling factor was determined for the different materials in a laboratory study but with different mould geometry, see Section 3.6.3. Table 4-1 shows examples of filling factors calculated with data from the performed backfill block manufacturing in full scale that are described in Chapter 5.

4.4.3 Two step compaction

As described in earlier chapter, the maximum filling height of the full scale mould, first version, was 560 mm. In order to produce blocks with a height of 400 mm manufactured with the current materials it is necessary to have a filling height between 568 to 712 mm. With this limited filling height it was necessary to introduce a two step compaction with an extra filling of material between the compaction steps. An example of the procedure is provided below.

Compaction of Asha 2010 material from a powder bulk density of 1,207 kg/m³ to a block bulk density of 1,995 kg/m³:

Calculations

1. The filling factor of this material is 1.65 (calculation based on data from earlier tests).
2. A target block height of 400 mm require a filling height of 660 mm (1.65×400).
3. The maximum filling height of the mould is 560 mm which means that the filling have to be done in two steps; 560 + 100 mm.

Procedure

1. The mould is filled to the maximum filling height, 560 mm. The carriage fetching material from the silo behind the press requires two trips in order to fill up the mould completely.
2. A manually controlled pre-compaction of the material is made (100 mm displacement). This pre-compaction is made with the upper piston and the mould frame standing in a fixed position.
3. The carriage is fetching new material and fills up the mould again.
4. The final compaction of the block can now be made. In order to get rid of trapped air, seven de-airing steps are made during compaction. This means that the upper piston release the pressure for a short time (1–2 seconds), and then continue the compaction.
5. After finalizing the compaction the block is pushed up from the mould.

The extra compaction and filling required, that parts of the press cycle were controlled manually, but the aim was that this procedure, in a production phase, could be performed automatically after re-programming of the press controlling system.

Table 4-1. Examples of filling factors calculated with data from the full scale tests.

Material	Remark	Compaction pressure, MPa	Water content, %	Filling factor
IBECO		27–35	20	1.65–1.78
ASHA 2010	As delivered	27–35	22–24	1.67–1.74
ASHA 2010	Crushed	27–35	20	1.42–1.50
ASHA 2012		18–20	20	1.44–1.48
Minelco		27–35	20	1.50–1.63
MX-80		27–35	17	1.50–1.52

4.4.4 Trapped air

Trapped air in the bentonite filling could affect the block quality. It was not possible to use vacuum in the press used for the tests described in this report but this is an option that should be considered when ordering presses for a future production plant. The introducing of de-airing steps during the compaction, see chapter above, improved the block quality and it was possible to actually hear that compressed air was released during this procedure.

4.5 Block handling

The handling of compacted blocks in a future factory will have to be made with an industrial robot that can take the block from the press table and lift it to a special pallet where they will be stacked. During the test period about 100 blocks were manufactured and for this rather small production it was necessary to develop an easy and cheap system for the block handling. The solution was a steel frame that could be lifted and handled by a forklift (Figure 4-4). On two of the sides pneumatic cylinders were positioned that could be activated via a valve on the side. The cylinders pressed plates equipped with rubber surfaces against the block and when activated it was possible to lift and move the blocks.



Figure 4-4. Photo showing the special lifting equipment used during the block testing.

4.6 Quality control of compacted blocks

4.6.1 General

In order to check the quality of the manufactured blocks some of them were chosen for sampling. The samples were taken out by sawing and drilling. The brick size blocks could be handled quite easily in laboratory but the full scale backfill blocks had to be handled in a special way.

The main reason for the sampling was to get information of the block dry density and if the requirements (see Section 2.3) were fulfilled. Another reason was to study the homogeneity of the blocks. If the blocks are not homogeneous from a density point of view, this may affect the strength which is an important factor when handling the blocks with the robot during emplacement.

4.6.2 Laboratory determinations

Density and water content were determined for all samples drilled or sawed out.

Water content

Half part of each piece was placed in an aluminum baking tin and the bulk mass (m_b) of the specimen determined by use of a laboratory balance. The specimen was dried in an oven for 24 hours at a temperature of 105°C. The dry solid mass (m_s) of the specimen was then determined immediately after removal and the water mass (m_w) was calculated according to Equation 4-1:

$$m_w = m_b - m_s \quad (4-1)$$

The water content (w) of the specimen determined according to Equation 4-2:

$$w = \frac{m_w}{m_s} \quad (4-2)$$

Density

The other half of each piece was used for determining the bulk density. The specimen was weighed, first in air (m_b) and then submerged into paraffin oil (m_{bp}). The volume of the specimen was then calculated.

$$V = \frac{(m_b - m_{bp})}{\rho_p} \quad (4-3)$$

where ρ_p is the paraffin oil density. The bulk density of the specimen was calculated according to Equation 4-4:

$$\rho_b = \frac{m_b}{V} \quad (4-4)$$

After determining the water content and the bulk density of each specimen it was possible to calculate the dry density (ρ_d):

$$\rho_d = \frac{\rho_b}{1 + w} \quad (4-5)$$

4.6.3 Sampling brick size blocks

During manufacturing a number of blocks were taken out for control. The blocks were controlled in two ways:

1. The blocks were measured with calipers and weighed.
2. Pieces of the blocks were sawed out according to Figure 4-5. Sample 1 and 2 are taken in the corner and 3 and 4 on the middle of one of the long sides. Both density and water content were determined in all four positions.

The results from the measurements are presented in Chapter 5.

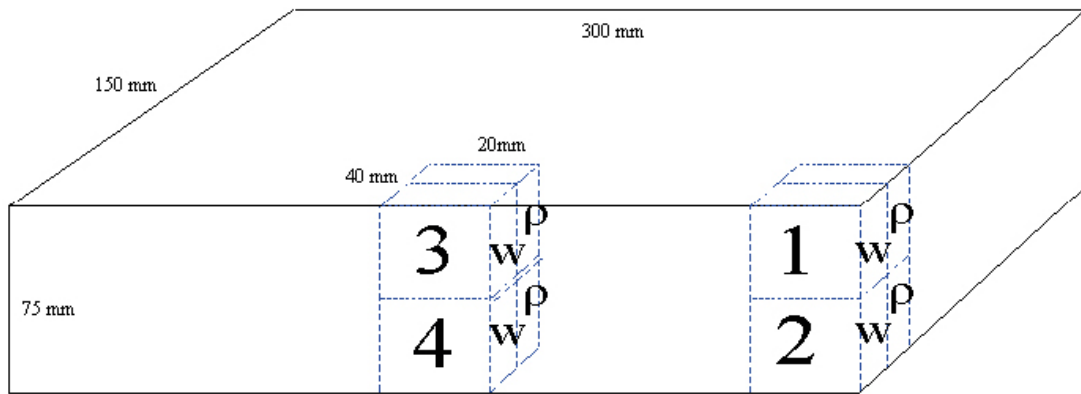

Figure 4-5. Schematic drawing showing the sample positions of the brick size blocks.

4.6.4 Sampling of full scale backfill blocks

The size of these blocks made it difficult to measure, weigh and saw out pieces. Instead a core drilling machine was used (Figure 4-6). Bentonite cores were drilled out at different positions from the upper surface of the block. The cores were then used in order to determine the water content and dry density at different levels (Figure 4-7). A few blocks were completely investigated i.e. nine cores were taken but in the main part of the blocks only three cores were taken (Figure 4-8).



Figure 4-6. Photo showing the core drilling equipment used for the block sampling.

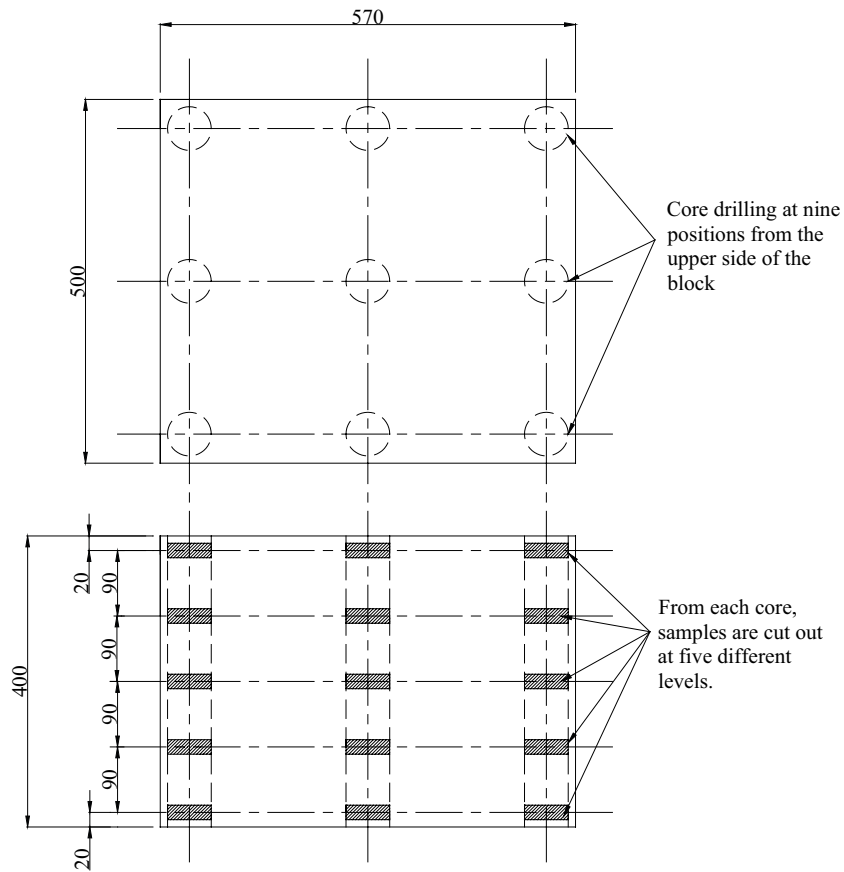

Figure 4-7. Upper: Cores were taken at different positions. Lower: The cores were sliced and samples taken at five levels.



Figure 4-8. Photo showing a block after sampling.

5 Block compaction at Höganäs Bjuf AB

5.1 General

The manufacturing of full scale backfill blocks have been made with the five different material batches described in Chapter 2. In addition to the large scale tests, about 80 ton of brick size blocks (300×150×75 mm) were manufactured in order to be used in different medium scale test at Äspö HRL.

The new backfill block size tested is much larger than what is produced normally at this factory. This in combination with the two step compaction, described in Section 4.4, meant that both block handling and running of the press cycles included manually work which made the tests rather time consuming.

The block tests at Höganäs Bjuf AB can be divided in three phases:

1. Block manufacturing with brick size blocks.
2. Block manufacturing in full scale, new mould I.
3. Block manufacturing in full scale, new mould II.

5.1.1 Block manufacturing with brick size blocks

Brick size blocks were manufactured at three separate occasions during 2011; in January, February and May. The results from these tests are presented in Section 5.2 and 5.3.

5.1.2 Block manufacturing in full scale, new mould I

Backfill block manufacturing in full scale have been made at five different occasions during 2011:

- February 15. Tests with Asha 2010 material as delivered.
- February 19. Tests with IBECO material as delivered.
- February 26. Tests with Asha 2010 material after removal of fractions larger than 6 mm by sieving.
- July 4 and 5. Two materials were tested:
 1. Tests with Asha 2010 material after removal of fractions larger than 3 mm by sieving.
 2. Tests with IBECO as delivered and with conditioned material (dried in the Eirich mixer at Äspö).
- November 14 and 15. Three materials were tested:
 1. Tests with Asha 2010 material after crushing and conditioning to higher water content.
 2. Tests with Minelco as delivered.
 3. Tests with MX-80 conditioned in mixer to higher water content.

The results from these tests are presented in Section 5.4 to 5.8.

5.1.3 Block manufacturing in full scale, new mould II

One test series was performed with the new mould with rounded edges. In total twenty-five blocks were manufactured using the Asha 2012 material. The results from these tests are presented in Section 5.9.

5.2 Höganäs Bjuf AB, January/June 2011, brick size blocks

5.2.1 General test description

Material: ASHA, as delivered

Block size: 300×148×75 mm

Objectives: Manufacturing blocks for steel tunnel tests (1/2 scale tests)

5.2.2 Results

In total about eighty tons of blocks were manufactured. The manufacturing was divided into three separate occasions. For the manufacturing the same press was used which later also was used for the full scale blocks. When manufacturing these smaller brick size blocks, three blocks were compacted at every press cycle (Figure 5-1).

The block quality was judged to be high with no cracks in the blocks and sharp edges. The density of the blocks was within the limits (1,650–1,750 kg/m³). From each of the separate production occasions a number of blocks were chosen and controlled in order to check the block quality and the density. Two types of control were made:

1. Measuring (digital calipers) and weighing of blocks.
2. Tests of homogeneity. Samples were sawed out from one of the corners and at the middle of one long side. The water content was determined by drying in an oven and the density by weighing the sample in air and then submerged in paraffin oil. A description regarding sampling and calculations is provided in Section 4-6.

Blocks were chosen and measured and weighed at two of the manufacturing times. These results are provided in Table 5-1 to 5-2. The second type of control was performed on blocks picked out at all three manufacturing times. The results from these measurements are provided in Figure 5-2.

The results provided in Table 5-1 origins from blocks picked out from the production in the beginning of the manufacturing. The density of these blocks is rather low, but after an increase of the compaction pressure from 25 to 35 MPa the average density was increased, see uppermost chart in Figure 5-2.

The chart shows that there is a similar density distribution trend in all blocks. The density is higher in samples taken on the upper side, position 1 and 3 (see Figure 4-5 for positions), relative the lower side, position 2 and 4. It is however not possible to see any differences between corners (1 and 2) and the middle of the long side (3 and 4).

The average density of the blocks is somewhat higher when determined with paraffin oil compared to weighing and measuring. This depends probably on inaccuracy when measuring the block dimensions.



Figure 5-1. Photo showing the manufacturing of brick size blocks. Three blocks are compacted at every press cycle.

Table 5-1. Test occasion 1. Compilation of results from measuring and weighing of nineteen blocks picked out during production.

Block	m kg	Height mm	Width mm	Length mm	Bulk density kg/m ³	Water content %	Dry density kg/m ³
A	6.49	75.40	148.00	301.40	1,930	16.27	1,660
B	6.47	75.20	148.10	301.80	1,925	16.18	1,657
C	6.58	75.60	148.20	301.30	1,949	16.27	1,676
D	6.59	75.60	148.20	301.20	1,953	15.89	1,685
E	6.44	75.20	148.10	301.50	1,918	16.27	1,650
F	6.50	75.20	148.10	301.40	1,936	16.16	1,667
G	6.46	75.20	148.10	301.80	1,922	16.27	1,653
H	6.57	75.50	148.10	301.10	1,951	16.22	1,679
I	6.58	75.50	148.10	301.80	1,950	16.27	1,677
J	6.58	75.50	148.20	301.40	1,951	16.09	1,681
K	6.46	75.20	148.00	301.70	1,924	16.27	1,655
L	6.54	75.50	148.20	301.20	1,941	15.87	1,675
M	6.46	75.30	148.20	301.30	1,921	16.27	1,652
N	6.60	76.20	148.30	301.40	1,938	16.70	1,661
O	6.65	77.10	148.10	301.50	1,932	16.27	1,661
P	6.39	74.70	148.10	301.60	1,915	16.83	1,639
Q	6.37	74.20	148.20	301.30	1,923	16.27	1,654
R	6.64	76.50	148.20	301.30	1,944	16.35	1,671
S	6.56	77.00	148.30	301.60	1,905	16.27	1,638

Table 5-2. Test occasion 2. Compilation of results from measuring and weighing of eight blocks picked out during production.

Block	m kg	Height mm	Width mm	Length mm	Bulk density kg/m ³	Water content %	Dry density kg/m ³
A	6.55	74.64	147.70	301.00	1,974	15.23	1,713
B	6.60	75.15	147.75	300.80	1,976	14.94	1,719
C	6.55	74.78	147.56	300.90	1,973	15.02	1,715
D	6.51	74.67	147.60	300.90	1,963	14.70	1,711
E	6.58	74.68	147.72	301.00	1,982	15.52	1,715
F	6.53	74.72	147.69	301.20	1,965	15.48	1,701
G	6.59	74.98	147.88	300.90	1,975	15.30	1,713
H	6.57	74.84	147.68	300.00	1,981	15.61	1,714

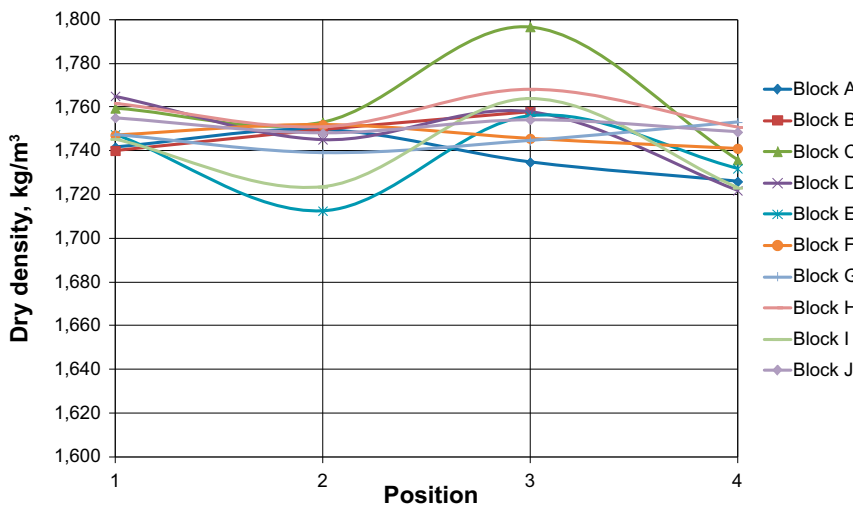
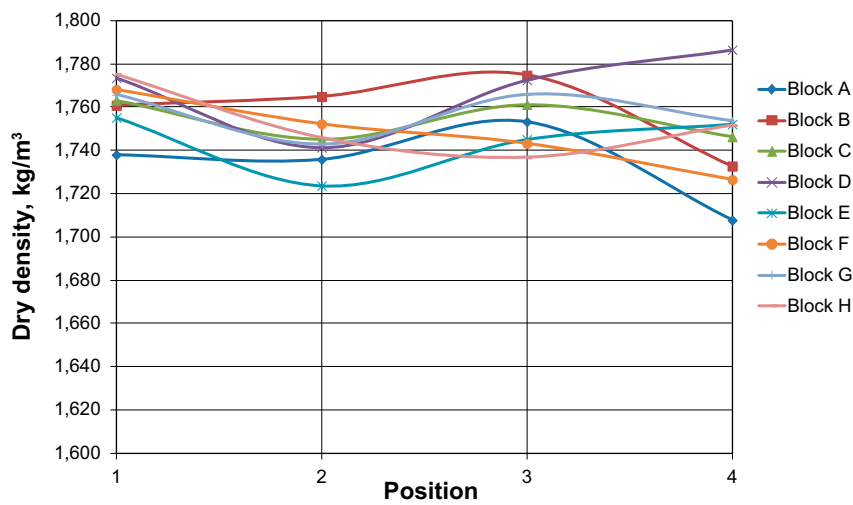
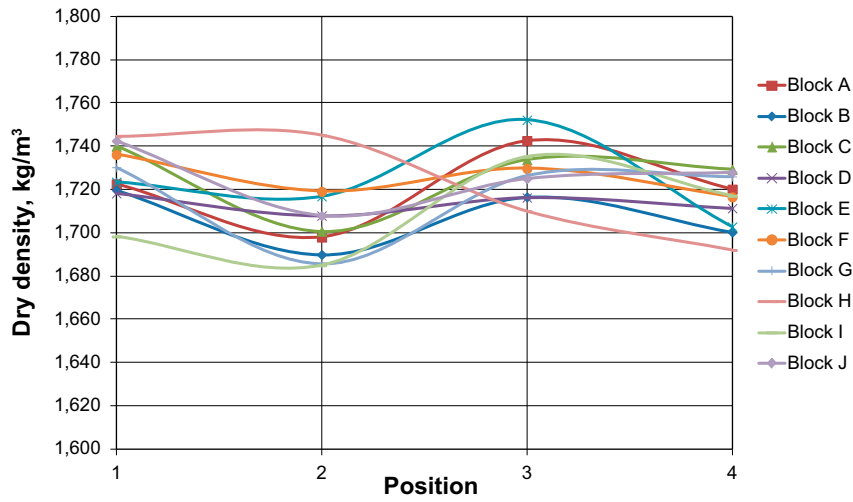

Figure 5-2. Dry density plotted versus block position. Ten blocks were picked out at manufacturing time 1 (upper), eight blocks at manufacturing time two (middle) and ten blocks at manufacturing time three (bottom).

5.3 Höganäs Bjuf AB, June 2011, brick size blocks

5.3.1 General test description

Material: IBECO, as delivered

Block size: 300×148×75 mm

Objectives: Manufacturing blocks for steel tunnel tests (1/2 scale tests)

5.3.2 Results

In total about ten tons of blocks were manufactured of the Ibeco material. Ten blocks were chosen during manufacturing and controlled in order to check the block quality and the density according to description in Section 5.3.1. The results from the control measurements are provided in Table 5-3 and Figure 5-3. The quality of the blocks was high with no cracks and sharp edges. The density of the blocks was within the limits (1,650–1,750 kg/m³).

Table 5-3. Compilation of results from measuring and weighing of ten blocks picked out during manufacturing.

Block	m kg	Height mm	Width mm	Length mm	Bulk density kg/m ³	Water content %	Dry density kg/m ³
A	6.66	75.63	147.23	299.25	1,999	18.21	1,691
B	6.72	75.06	147.15	299.05	2,034	18.07	1,723
C	6.73	75.24	147.20	299.20	2,031	18.06	1,720
D	6.75	75.38	147.12	299.00	2,036	18.35	1,720
E	6.70	75.28	147.31	299.35	2,018	18.21	1,707
F	6.71	75.37	147.27	299.30	2,020	18.12	1,710
G	6.74	75.62	147.30	299.35	2,021	18.40	1,707
H	6.77	75.51	147.47	299.30	2,031	18.57	1,713
I	6.74	75.48	147.33	299.40	2,024	18.28	1,712
J	6.70	75.16	147.19	299.25	2,024	18.29	1,711

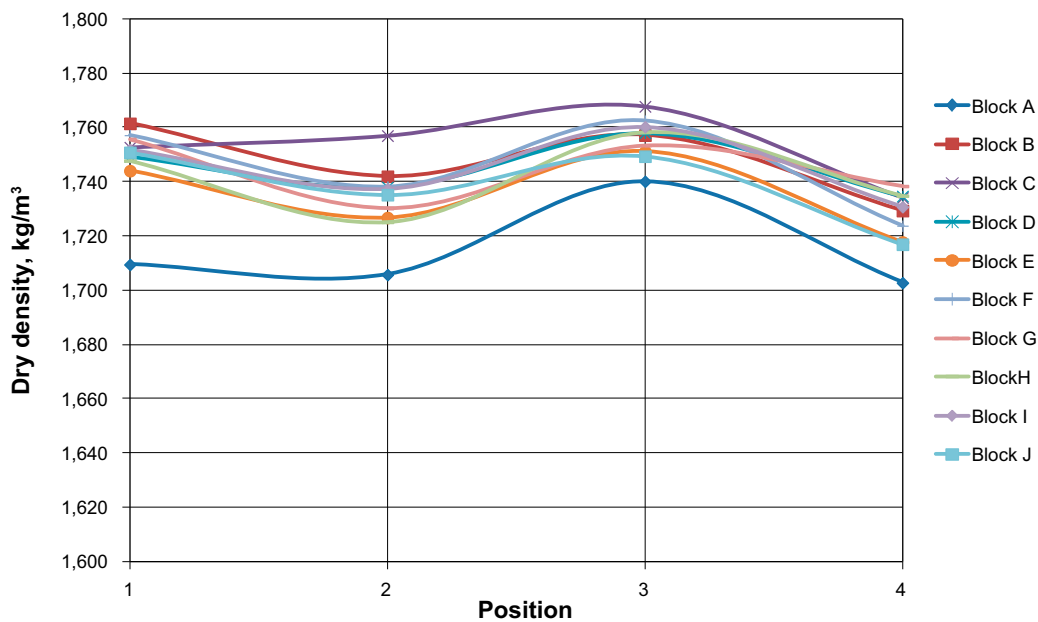

Figure 5-3. Dry density plotted versus block position.

The chart shows that there is a similar density distribution trend in these blocks as in the Asha blocks. The density is higher in samples taken on the upper side, position 1 and 3, relative the lower side, position 2 and 4. The differences between corners (1 and 2) and the middle of the long side (3 and 4) are, however, very small.

A small problem occurred with the Ibeco material. The material was sticking to the upper piston which resulted in stops of the production where the surface of the piston had to be cleaned. The problem was found to occur when big bags containing material with water content higher than the average was used. The sticking problems decreased when instead choosing big bags with somewhat drier material. Because of this problems it was, however, decided to mainly produce brick size blocks with the Asha material (Section 5.2).

5.4 Höganäs Bjuf AB, February 15 2011, full scale blocks

5.4.1 General test description

Material: ASHA NW BFL-L 2010

Block size: 500×571×400 mm

Objective: First attempt to compact block in the new mould. The material was used as delivered.

5.4.2 Results

In total six blocks were compacted. The compaction pressure was set to about 36 MPa and the technique with pre-compaction and additional filling of material was also tested.

The blocks were after compaction measured with a caliper and weighed, see compilation of block data in Table 5-4. The achieved dry density of the blocks varied between 1,598 to 1,732 kg/m³. The large deviation in dry density depended on the new technique with pre-compaction which resulted in a lot of manually operations and there were probably also variations in the compaction pressure. There were also differences regarding the filling of the mould (the number of times the carriage was fetching material) which probably is the explanation for the differences in mass although the filling height was the same, see e.g. data provided for block no. 1:2, 1:3 and 1:4 in Table 5-4.

The block quality was generally bad, with fragile edges, see photos provided in Figure 5-4 and 5-5. The water content of the material in the used big bag, 15%, was lower than the average, 16.3%, for the delivered material, which probably also affected the block quality in a negative way. The technique with pre-compaction and then additional filling of material did, however, not seem to influence the block quality. No cracks could be seen in this region of the blocks.

One conclusion from this first attempt was that the grain size distribution of the material probably was one of the main reasons for the fragile edges (all edges were fragile, but especially the four vertical). The content of coarser particles was rather high, see Figure 3-1, and this in combination with the adverse geometry with sharp edges was believed to result in the fragile edges. Another reason could also be that the settings of the press cycle not were optimized for the block size.

5.4.3 Block investigations

Depending on the bad block quality no further studies regarding block quality and density distribution etc were performed.

Table 5-4. Compilation of tests performed 15th of February. The material tested was ASHA NWL-L 2010 as delivered.

Block no.	m kg	h mm	w mm	l mm	Volume dm ³	Water content % (circa)	Calc. Bulk density kg/m ³	Dry density kg/m ³	Compaction pressure MPa	Filling height mm	Block saved Y/N	Remark
1:1	212	405	497	568	114	15	1,854	1,612	36	560	N	Bad block with very fragile edges.
1:2	236.9	422	497	567	119	15	1,992	1,732	36	560+23	N	Bad block with very fragile edges.
1:3	210.2	406	497	567	114	15	1,837	1,598	36	560+23	N	Pre-compaction with 10 bar. Bad block with very fragile edges.
1:4	223.8	408	497	567	115	15	1,947	1,693	36	560+23	N	Pre-compaction with 10 bar. Bad block with very fragile edges.
1:5	*	*	*	*	*	*	*	*	36	560+31	N	Pre-compaction with 15 bar. Bad block with very fragile edges.
1:6	218.9	410	497	568	116	15	1,891	1,645	36	560+45	N	Pre-compaction with 10 bar. Bad block with very fragile edges.



Figure 5-4. Photo showing one of the first blocks compacted in the new mould.



Figure 5-5. Close up showing one of the block edges. All edges were very fragile and material loosened easy from the block.

5.5 Högånäs Bjuf AB, February 19, 2011, full scale blocks

5.5.1 General test description

Material: IBECO RWC BF 2011

Block size: 500×571×400 mm

Objective: The tests were performed with the material as delivered.

5.5.2 Test description and results

In total 22 blocks were compacted, see compilation of block data in Table 5-5. At this test session the following parameters were changed or varied:

- The compaction pressure was varied between 19 to 36 MPa. The first blocks had some cracks but lowering of the compaction pressure seemed to solve this problem. The lower pressure resulted, as expected, in lower density but it was still within the set limits.
- Another parameter changed, was how the mould was moving relative the bottom piston and also the actual compaction speed.
- One change which turned out to be very important in order to achieve blocks of high quality was the introduction of a number of de-airing steps during the compaction i.e. the upper piston released the pressure for a short time, letting the trapped air out. The control program of the press allowed for a maximum of seven de-airing steps during the compaction cycle.

The work with adjusting of the settings resulted in blocks with varying quality. Figure 5-6 shows a close up of one of the first blocks. The photo shows the problems with fragile edges and also a horizontal crack probably depending on the expansion of trapped air.

The achieved dry density of the blocks varied between 1,654 to 1,724 kg/m³ which is within the defined limits (1,650–1,750 kg/m³). The water content of the as-delivered material was about 20%. Figure 5-7 shows a photo of one of the last blocks produced at this occasion. The quality of this block was judged to be high but work should be done in order to further increase the quality.

Fourteen blocks were saved and sent to Äspö. Two of these were sampled carefully, see results in next section.



Figure 5-6. Close-up photo showing one of the first blocks made of IBECO. The photo shows the fragile edges and a part of a horizontal crack.



Figure 5-7. Photo showing one IBECO block with rather good quality directly after compaction.

Table 5-5. Compilation of tests performed 19th of February. The material tested was IBECO RWC BF 2011 as delivered.

Block no.	m kg	h mm	w mm	l mm	Volume dm ³	Water content % (circa)	Calc. Bulk density kg/m ³	Dry density kg/m ³	Compaction pressure MPa	Filling height mm	Block saved Y/N	Remark
2:1	*	*	*	*	*	*	*	*	36	560	N	De-airing was not good enough. Large crack along front side. The side edges are fragile.
2:2	186.5	320.8	497	567	90	20	2,063	1,719	36	560	N	Large crack along front side. The side edges are fragile.
2:3	*	*	*	*	*	20	*	*	36	560	N	Large cracks, no weighing and measuring.
2:4	183.5	316	497	567	89	20	2,061	1,717	36	560	N	All rates are decreased. Still cracks but less. Three step air-evacuation.
2:5	182.5	313	497	567	88	20	2,069	1,724	36	560	N	De-airing in seven steps. No air-related cracks.
2:6	185.4	319	497	567	90	20	2,062	1,719	36	560	Y	De-airing in seven steps. No air-related cracks. The mould movement is changed, resulting in a deeper block position.
2:7	*	*	*	*	*	*	*	*	36	560	N	The material is evened out between the fillings. Still fragile edges and cracks! Block is loosened above the mould.
2:8	190.1	332	497	567	94	20	2,032	1,693	29	560	Y	Pressure decreased. De-airing in seven steps. No cracks.
2:9	189.2	333	497	567	94	20	2,016	1,680	20	560	Y	Pressure decreased again. The mould is cleaned. Temp material ca 12-13 °C.
2:10	190.6	339	497	567	96	20	1,995	1,663	21	560	Y	Nice block, small crack in front, small damages on the four vertical edges.
2:11	187.4	335	497	567	94	20	1,985	1,654	19	560	Y	The filling is evened out manually. Small crack in front, small damages on the four vertical edges.
2:12	*	*	*	*	*	*	*	*	*	560	N	A test to see the result of increast speed. Largge crack in front! Material is finer in this bag!
2:13	*	*	*	*	*	*	*	*	*	560	N	A number of bad blocks in order to empty the gasket. This finer material is not good for block compaction.
2:14	218	387	497	567	109	20	1,999	1,666	21	560+91	Y	400 mm height as target. 91 mm pre-compaction (5 bar). Nice block, no cracks.
2:15	225.8	401	497	567	113	20	1,998	1,665	21	560+115	Y	400 mm height as target. 115 mm pre-compaction (10 bar). Nice block, no cracks.
2:16	226.6	402	497	567	113	20	2,000	1,667	21	560+115	Y	400 mm height as target. 115 mm pre-compaction (10 bar). Nice block, no cracks.
2:17	224.3	397	497	567	112	20	2,005	1,671	21	560+?	Y	400 mm height as target. Pre-compaction (9 bar). Nice block, no cracks.
2:18	214.5	382	497	567	108	20	1,993	1,661	21	560+?	Y	400 mm height as target. Pre-compaction (10 bar). Nice block, no cracks.
2:19	>300	417	497	567	118	20	*	*	20	560+122	Y	400 mm height as target. Pre-compaction (15 bar). Nice block, no cracks.
2:20	>300	412	497	567	116	20	*	*	21	560+117	Y	400 mm height as target. Pre-compaction (13 bar). Nice block, no cracks.
2:21	225.7	403.5	497	567	114	20	1,985	1,654	21	560+105	Y	400 mm height as target. Pre-compaction (10 bar). Nice block, no cracks.
2:22	225.6	404	497	567	114	20	1,982	1,651	21	560+?	Y	400 mm height as target. Pre-compaction (10 bar). Nice block, no cracks.

5.5.3 Block investigations

Samples were drilled out from two of the compacted blocks, 2:8 and 2:16, according to the description in Section 4.6. From block number 2:8 nine cores were drilled out and from block number 2:16 three cores. The results from these measurements are shown in Figure 5-8.

The charts show that there is a clear density gradient in all corners (red lines) with the lowest density at the middle height of the block. The gradient can be seen also for the samples taken at the short side and at the long side but much less pronounced. The samples cut out from the core that was drilled out at the center of the block showed no density gradient at all.

The four vertical edges were very brittle and one reason for this could be the shape of the mould with square blocks. It is difficult for the compaction pressure to propagate into the bottom of the 90°-corners which is shown very clearly in the investigation of the density distribution.

The average density of the blocks is well within the set density limits even if some single samples taken from the mid height of the corners are below 1,650 kg/m³.

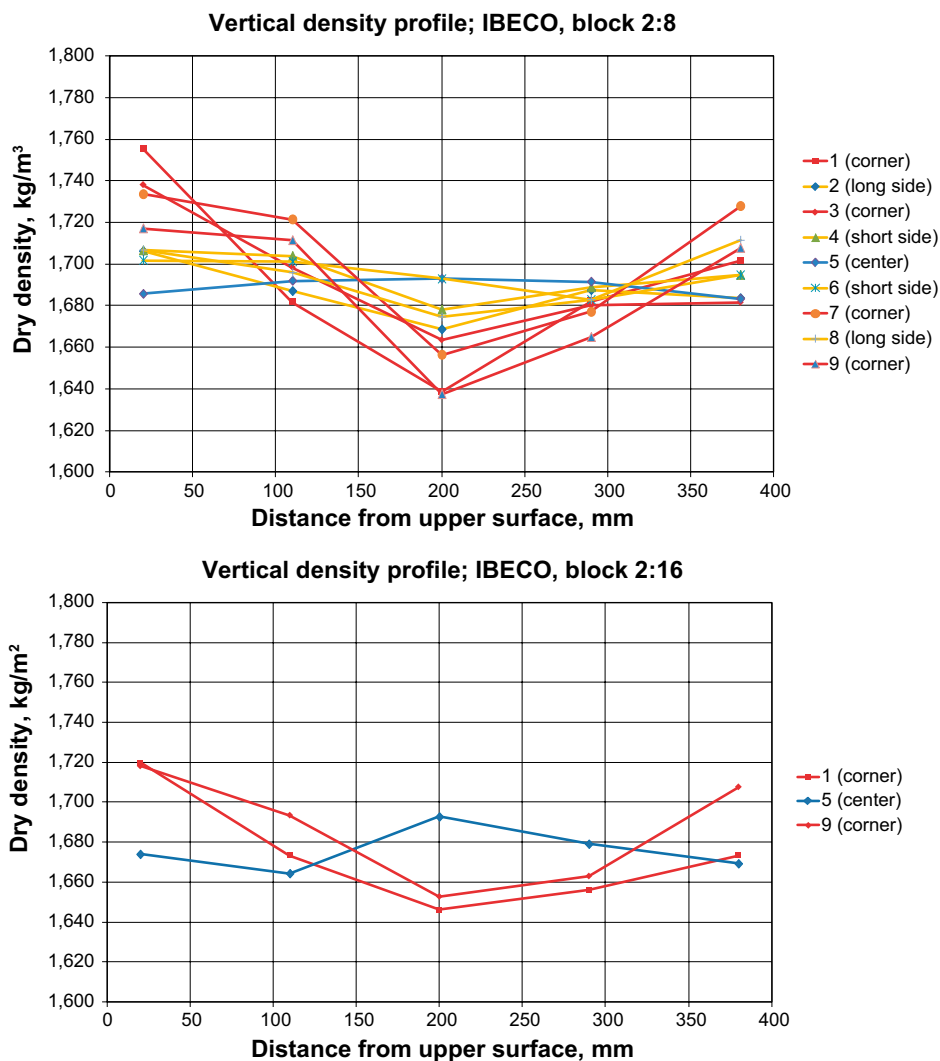

Figure 5-8. Chart showing density profiles determined in two blocks manufactured of Ibeco material. The material was compacted as-delivered.

5.6 Höganäs Bjuf AB, February 26, 2011, full scale blocks

5.6.1 General test description

Material: ASHA NWL BFL-L 2010

Block size: 500×571×400 mm

Objective: Tests with the ASHA material after removal of the fraction larger than six mm by sieving.

5.6.2 Test description and results

The first attempt to manufacture blocks of the as-delivered Asha material resulted in blocks with very fragile edges. One reason for this was believed to be the grain size distribution with a high content of coarser particles. In order to solve this problem it was decided to perform a test where all grains larger than six mm were removed (by sieving). In total thirteen blocks were compacted at this test time, see compilation of block data in Table 5-6.

The test series was done according to the following:

- The compaction pressure was varied between 22 to 35 MPa.
- The technique with pre-compaction was tested (5 or 10 bars pre-compaction pressure).
- All compaction cycles included seven de-airing steps.

The removal of the largest fraction resulted in blocks with higher quality. The horizontal edges were firmer but the vertical edges were, however, still rather fragile, see Figure 5-9, and it was judged that the quality must be further increased in order to be acceptable. It was also noted that the higher pressure resulted in problems with the de-moulding.

The achieved dry density of the blocks varied between 1,647 to 1,686 kg/m³. The water content of the material was about 16% which probably is too low in order to achieve high quality blocks. Figure 5-10 shows a photo of block number six which was one of the blocks with best quality.

Ten blocks were saved and sent to Äspö for sampling, see results in next section.

5.6.3 Block investigations

Samples were drilled out from two of the compacted blocks, 3:6 and 3:7, according to the description in Section 4.6. From block number 3:6 three cores were drilled out and from block number 3:7 three cores. The results from these measurements are shown in Figure 5-11.

The number of samples taken from these blocks was limited but it was possible to get an idea of the average block density which was within the limits.



Figure 5-9. Close up showing one of the vertical edges which still were very fragile.



Figure 5-10. Photo showing one of the blocks with rather high quality.

Table 5-6. Compilation of tests performed 26th of February. The material tested was ASHA after removal of the fraction larger than six mm.

Block no.	m kg	h mm	w mm	l mm	Volume dm ³	Water content % (circa)	Calc. Bulk density kg/m ³	Dry density kg/m ³	Compaction pressure MPa	Filling height mm	Block saved Y/N	Remark
3:1	212.4	384	498	568	109	16	1,955	1,686	28	560	N	First testblock, no cracks, fragile vertical edges, compaction factor 1.46.
3:2	221.3	401.5	497	567	113	16	1,956	1,686	28	560+23	Y	5 bar pre-compaction gave 43 mm, form adjusted to 23 mm.
3:3	218.2	396	497	567	112	16	1,955	1,686	28	560+23	Y	Trying to get 23 mm extra space manually but it is difficult. No cracks, fragile vertical edges and lower corner.
3:4	215.4	391.5	497	567	110	16	1,952	1,683	28	560+23	Y	5 bar pre-compaction then adjusted to 23 mm. No cracks, fragile vertical edges and lower corner.
3:5	209.5	385	497	567	108	16	1,931	1,665	28	560+31	Y	Nice block. No cracks, fragile vertical edges and lower corner.
3:6	211.4	388	497	567	109	16	1,933	1,667	28	560+45	Y	5 bars pre-compaction, no adjustment. No cracks, fragile vertical edges and lower corner.
3:7	217.3	401	497	567	113	16	1,923	1,658	28	560+75	Y	10 bars pre-compaction (75 mm extra), no adjustment. Nice block, No cracks, fragile vertical edges and lower corner.
3:8	220.6	404	497	567	114	16	1,938	1,670	28	560+75	Y	10 bars pre-compaction (75 mm extra), no adjustment. Nice block, No cracks, fragile vertical edges and lower corner.
3:9	*	*	*	*	*	*	*	*	35	560+70	N	Testing a higher compaction pressure. Difficult to re-mould. Large crack. Drier material?
3:10	*	*	*	*	*	*	*	*	27	560+65	N	Difficult to re-mould. Large crack. Drier material?
3:11	>300	442	497	567	125	16	*	*	22	560+65	Y	10 bars pre-compaction (75 mm extra), no adjustment. Difficult to remould, drier material?
3:12	>300	435	497	567	123	16	*	*	22	560+60	Y	10 bars pre-compaction (75 mm extra), no adjustment. Difficult to remould, drier material?
3:13	212.6	395	497	567	111	16	1,910	1,647	22	560	Y	Compaction in one step. Nice block, the vertical edges are better than earlier blocks.

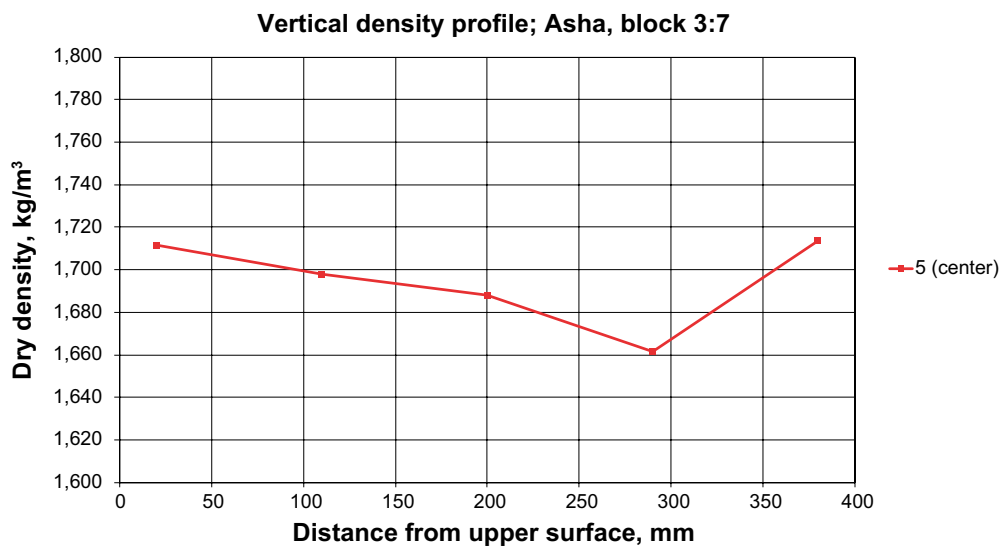
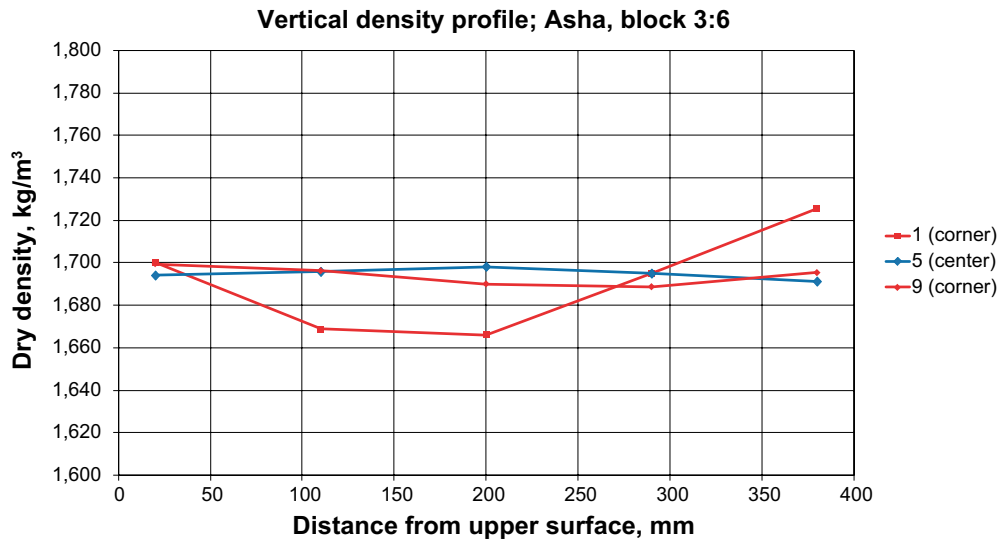

Figure 5-11. Chart showing density profiles determined in two blocks manufactured of Asha material. The material was compacted after removal of the fraction larger than six mm.

5.7 Höganäs Bjuf AB, July 4–5, 2011, full scale blocks

5.7.1 General test description

Material: ASHA 2010 and IBECO

Block size: 500×571×400 mm

- Objectives:
1. Tests with the ASHA 2010 material after removal of the fraction larger than three mm by sieving.
 2. Tests with IBECO as delivered and with material conditioned at Äspö (dried in the Eirich mixer).

5.7.2 Test description and results

This test session included tests with both Asha 2010 and Ibeco materials, see compilation in Table 5-7 and 5-8. The session can be divided in four parts regarding testing. Part one and two were performed the first day and part three and four the next day:

1. In order to further study the influence of the coarser particles in the Asha 2010 material about two tons were sieved and all particles larger than three mm removed. After sieving, the material was sent to Äspö where it was conditioned to a water content of about 19%. After having compacted four blocks (block 4:1 to 4:4) with this material with rather bad results it was decided to instead test the Ibeco material.
2. The water content of the Ibeco material as-delivered was about 20%. In order to test if it was possible to increase the block quality having lower water content, about one ton was dried in the mixer at Äspö. The material was mixed in an Eirich mixer and the increasing temperature resulted in loss of water. Four blocks were manufactured with the dried material; all of them having a rather low quality i.e. there were fragile edges and also some cracks. (Block 4:5 to 4:8).
3. The second day, a specialist from Sacmi (the press manufacturer) joined in order to optimize the press cycle and also to look at the possibility to automatize the press cycle including the two step compaction with an extra filling between, see description in Section 4.4.3 and photo provided in Figure 5-12. The parameters changed were e.g. compaction rate, the ratio between the movement of the upper piston and the simultaneous movement downwards of the mould, the filling process of the mould and also the de-moulding of the block. After a number of bad blocks, there was a significant increase of the quality, see photo provided in Figure 5-13. (Block 4:14 to 4:23).
4. The new press cycle developed with the Ibeco material was now tested with the sieved Asha 2010 material. Also with this material it was possible to see a significant increase of the block quality, even if the four vertical edges still were somewhat fragile, see photo provided in Figure 5-14. (Block 4:24 to 4:25).

In total twenty-five blocks were compacted during these two days and twenty of them were saved and sent to Äspö for sampling, see next section.

5.7.3 Block investigations

The blocks compacted at this two day session included a lot of testing with the different materials and changing of the press cycle. In order to decrease the number of blocks chosen for a more detailed investigation two of the best blocks made of Asha 2010 and five of the best Ibeco blocks were picked out. Blocks that had a lower quality (visually assessed) were not further investigated.

The two Asha 2010 blocks further investigated were 4:24 and 4:25, see Figure 5-15. Three cores were drilled out from block 4:24 and nine from 4:25. The determined density gradients within the blocks are very similar to the earlier measurements i.e. the large differences are in the corners while samples taken at the middle of long sides and short sides shows much less differences in density. The samples taken at the center of the blocks shows almost no differences in density. If comparing the results from block 4:25 with block 2:8, see Figure 5-8, it can be noted that the profile has moved and the lowest density is now 100–150 mm down from the upper surface while it was in the mid height earlier. This depends on the new improved press cycle resulting in blocks with higher quality. Both investigated blocks had dry densities well within the set limits.

Five Ibeco blocks were investigated more carefully, 4:18, 4:19, 4:20, 4:21 and 4:22, see Figure 5:16 and 5:17. Nine cores were drilled out from block 4:21 and three from each of the others. All five investigated Ibeco blocks had dry densities within the set limits.

Table 5-7. Compilation of tests performed 4–5 July with ASHA. The Table shows the results from the tests performed with ASHA material where the fraction larger than three mm has been removed. The material was after the sieving conditioned at Äspö to higher water content.

Block no.	m kg	h mm	w mm	l mm	Volume dm ³	Water content % (circa)	Calc. Bulk density kg/m ³	Dry density kg/m ³	Compaction pressure MPa	Filling height mm	Block saved Y/N	Remark
4:1	238	399	497	567	112	18.8	2,117	1,781.8	34	560+48	N	5 bar pre-compaction resulting in 48 mm compaction. Cracks and fragile vertical edges.
4:2	*	401	497	567	113	18.8	*	*	36	560+50	N	5 bar pre-compaction resulting in 50 mm compaction. Deairing steps every fifth bar (totally seven). Cracks and fragile vertical edges.
4:3	*	395	497	567	111	18.8	*	*	44	560+50	N	5 bar pre-compaction resulting in 50 mm compaction. Deairing steps every fifth bar (totally seven). Cracks and fragile vertical edges.
4:4	*	394	497	567	111	18.8	*	*	44	560+50	N	5 bar pre-compaction resulting in 50 mm compaction. Deairing steps every fifth bar (totally seven). Cracks and fragile vertical edges.
4:24	*	448	497	567	126	18.8	*	*	27	560+83	Y	Block compacted with improved press cycle (from the IBECO tests) technique. Best Asha block so far, but still fragile corners.
4:25	223.1	390	497	567	110	18.8	2,030	1,709	27	560+52	Y	As above!

Table 5-8. Compilation of tests performed 4–5 July with IBECO. The Table shows the results from the tests performed with IBECO material. Block 5 to 8 were manufactured by material that has been dried to about 17%.

Block no.	m kg	h mm	w mm	l mm	Volume dm ³	Water content % (circa)	Calc. Bulk density kg/m ³	Dry density kg/m ³	Compaction pressure MPa	Filling height mm	Block saved Y/N	Remark
4:5		405			0	16.9			38	560+52	Y	Same technique as earlier (feb.19), but bad block with cracks and fragile corners.
4:6		407			0	16.9			36	560+50	Y	As above.
4:7		418			0	16.9			27	560+50	Y	As above.
4:8		419			0	16.9			27	560+50	Y	As above.
4:9		392			0	16.9/20			27	560+62	Y	Same technique as earlier (feb.19), but bad block with cracks and fragile corners. Old material (w=20%) mixed with the dryer (16.9%).
4:10		392	498	568	111	20			24	560+76	Y	Same technique as earlier (feb.19), but bad block with cracks and fragile corners. Old material (w=20%).
4:11		392			0	20			36	560+78	Y	Same technique as earlier (feb.19), but bad block with cracks and fragile corners. Lamell cracks and fragile corners.
4:12		383	567	497	108	20			28	560+75	Y	As above.
4:13		327	498	568	92	20			29	560	Y	As above.
4:14	215.5	375	498	568	106	20	2,032	1,693	27	560+65	Y	The technician from Sacmi is adjusting the press cycle (this block and forward). Bad block.
4:15	229.1	398	498	568	113	20	2,035	1,696	27	560+98	Y	First compaction is set to 100 mm, then de-airing steps. Best block so far.
4:16	231.7	404	498	568	114	20	2,028	1,690	27	560+95	Y	Trying to adjust the filling process in order to get a more homogenous filling. The possibilities are however limited.
4:17	231.7	408	498	568	115	20	2,008	1,673	27	560+90	Y	Different pressycle and de-moulding. Not better! Crack in the bottom depending on the de-moulding.
4:18	224.1	392	498	568	111	20	2,021	1,684	27	560+60	Y	Different pressycle and de-moulding. Nice block, good corners!
4:19	230.9	402	498	568	114	20	2,031	1,692	27	560+92	Y	As above. Only small damages on the corners. Acceptable?
4:20	232.7	407	498	568	115	20	2,021	1,684	27	560+95	Y	As above!
4:21	232.7	412	498	568	117	20	1,997	1,664	27	560+100	Y	As above!
4:22	230.1	400	498	568	113	20	2,034	1,695	27	560+100	Y	As above!
4:23											N	Bad material (rest) from silo.



Figure 5-12. Photo showing the Sacmi technician during work.



Figure 5-13. Photo showing one of the best Ibeco blocks manufactured.



Figure 5-14. Photo showing one of the best Asha 2010 blocks manufactured.

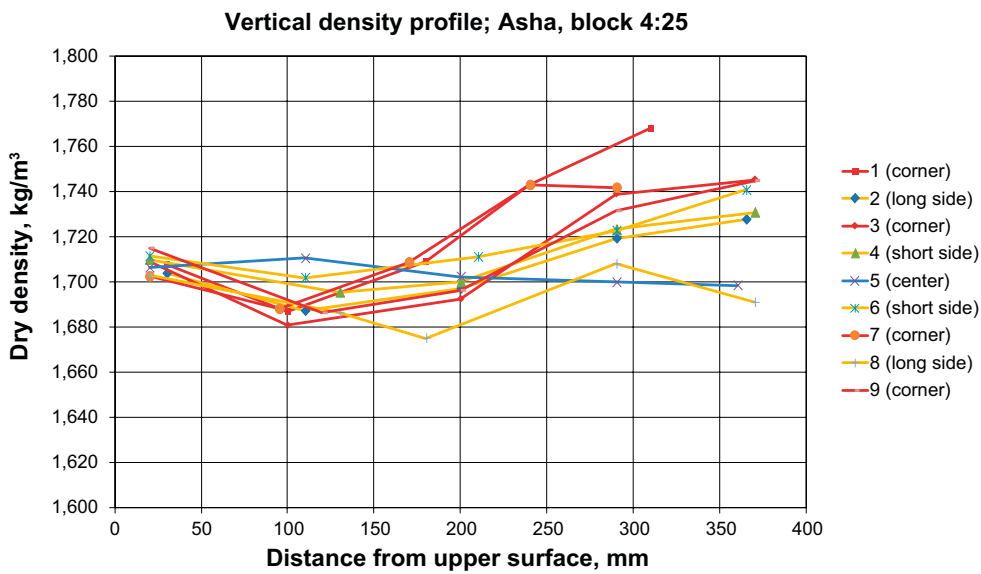
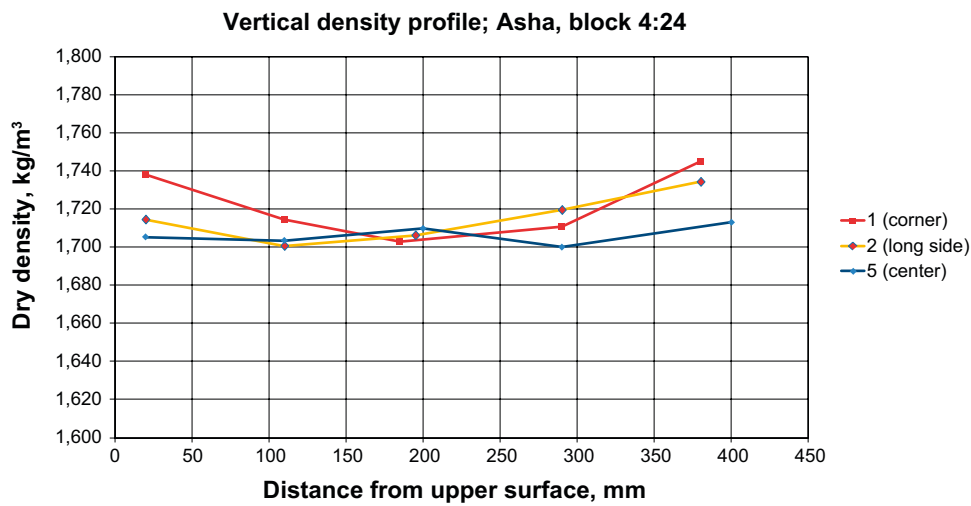

Figure 5-15. Charts showing density profiles determined in two blocks manufactured of Asha material. The fraction larger than three mm was removed and the material conditioned to a water content of 19% before block compaction.

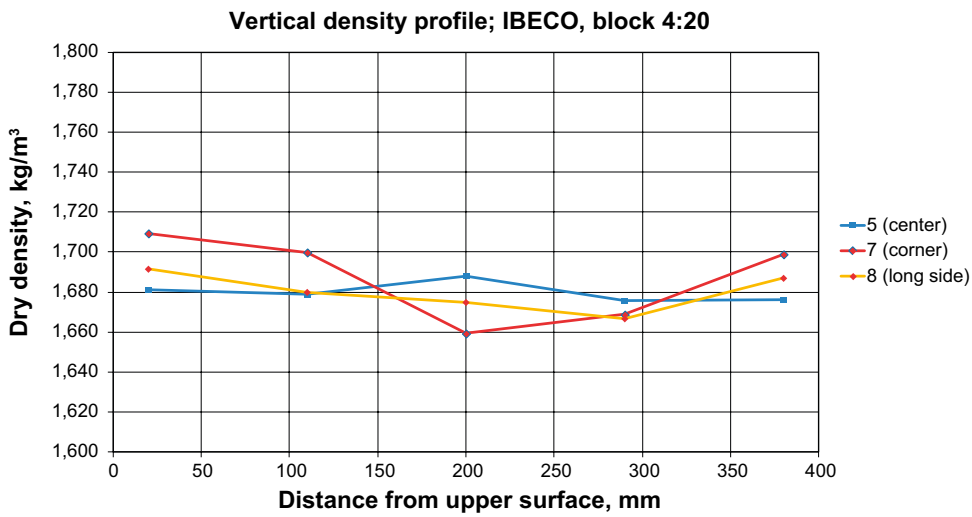
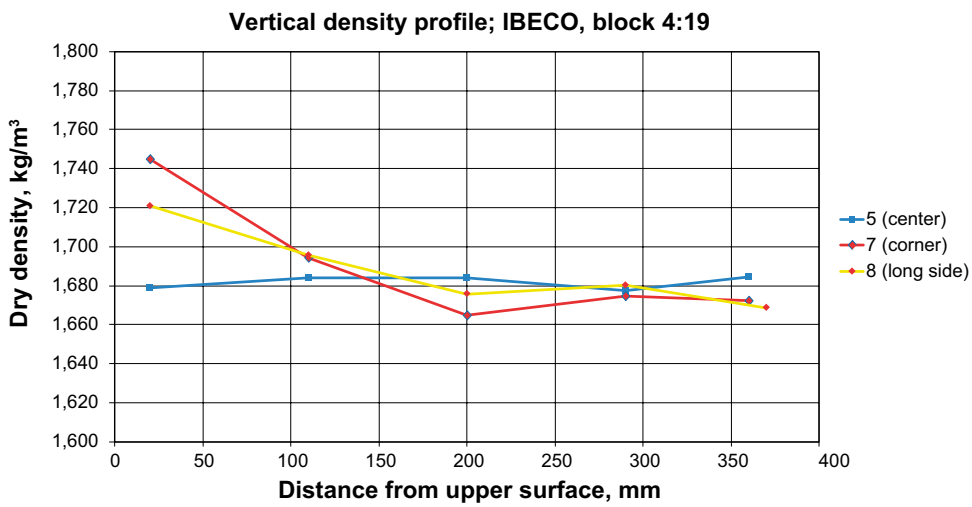
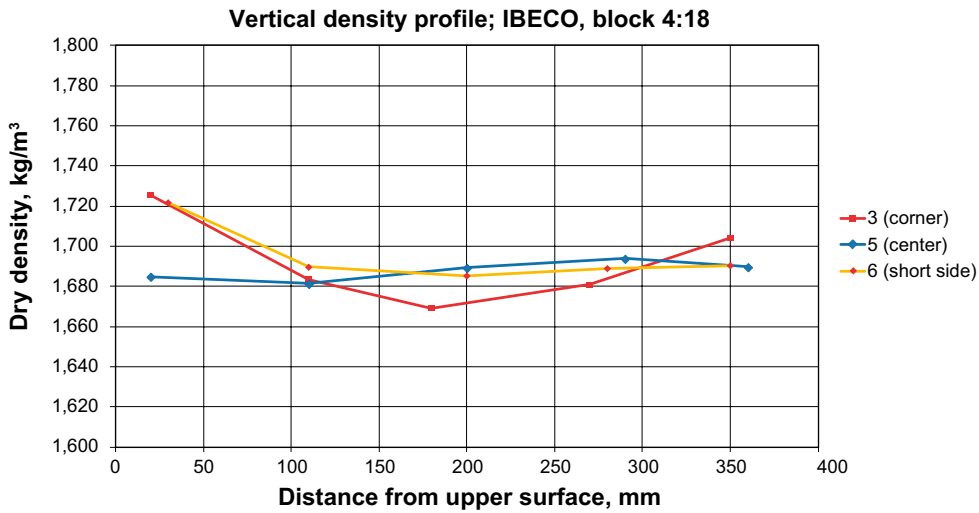

Figure 5-16. Charts showing density profiles determined in three blocks manufactured of Ibeco material. The material was compacted both as-delivered.

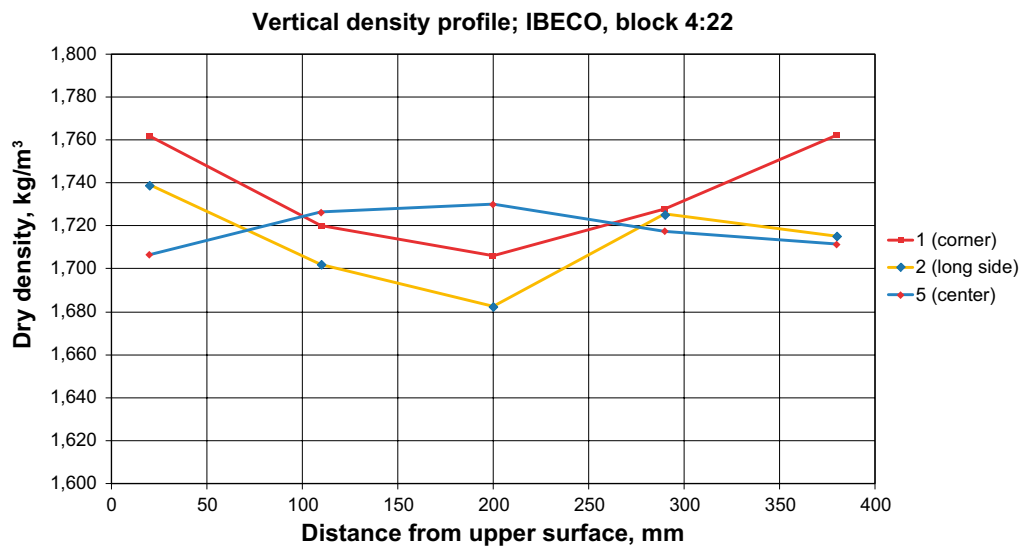
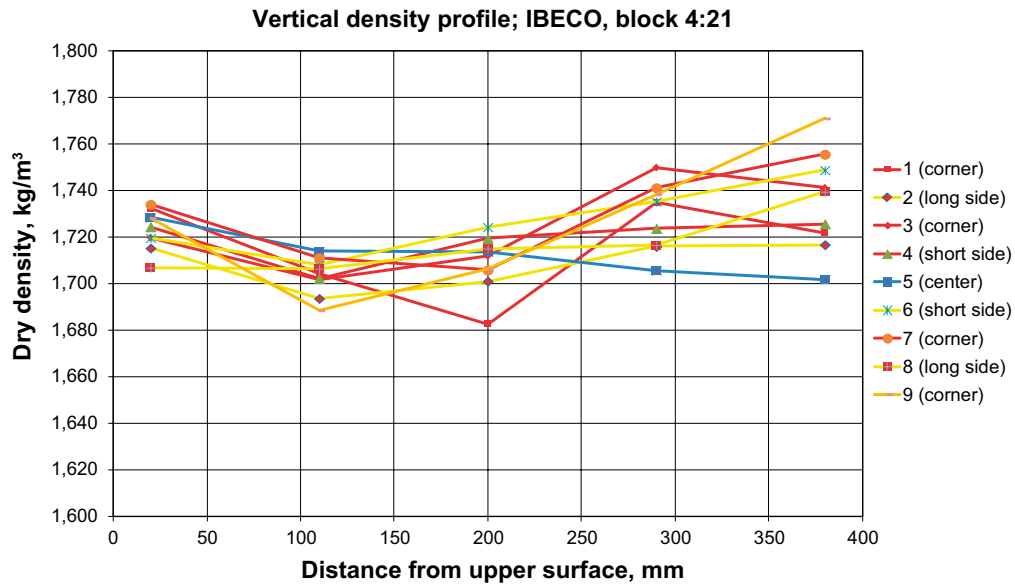

Figure 5-17. Charts showing density profiles determined in two blocks manufactured of Ibeco material. The material was compacted both as-delivered.

5.8 Höganäs Bjuf AB, November 14–15, 2011, full scale blocks

5.8.1 General test description

Material: ASHA 2010, Minelco and MX-80

Block size: 500×571×400 mm

- Objectives:
1. Tests with the ASHA 2010 as-delivered material and crushed material, both conditioned to higher water content.
 2. Tests with Minelco, both as-delivered but also conditioned to higher water content.
 3. Tests with MX-80 conditioned at Äspö (water content set to 17% in the Eirich mixer).

5.8.2 Test description and results

Asha 2010 raw material conditioned to higher water content

In total nine blocks were compacted, four with a water content of 22.5% and five with a water content of 24%, see compilation in Table 5-9. The blocks with the lower water content had a rather good quality even if the four vertical edges were somewhat fragile. In three of the five blocks with water content of 24% a small crack occurred, see photo in Figure 5-18. The reason is probably that the higher water content makes it more difficult to de-air the material and the compressed air expands after de- moulding which results in a crack.

All nine blocks were saved and sent to Äspö for sampling, see next section.

Asha 2010 crushed and conditioned to higher water content

In order to get a more suitable grain size distribution about twenty tons of the Asha 2010 material was crushed, see description in Section 3.2.1. After crushing, the material was sent to Äspö in order to be conditioned i.e. increase the water content. Three batches with 20, 22 and 24% water content respectively were mixed. Tests were made with two of the materials; 20 and 24%.

A compilation of the results is provided in Table 5-9 and 5-10. The achieved block quality was judged to be good, see Figure 5-19. The four vertical edges were still somewhat fragile but not as much as in earlier tests.

In total twelve blocks were compacted with this material and ten of them were saved and sent to Äspö for sampling, see next section.

Minelco as-delivered and conditioned to higher water content

The Minelco material available at Äspö was a part from an old batch used within other tests. The reason for testing Minelco was to have it as an option if the quality of the Asha 2010 blocks shouldn't be good enough.



Figure 5-18. Photo showing an example of the crack that occurred in the blocks with the highest water content, 24%.

Table 5-9. Compilation of tests performed November 14–15 with ASHA 2010. The Table shows the results from the tests performed with the uncrushed material. The material was conditioned at Äspö to higher water content.

Block no.	m kg	h mm	w mm	l mm	Volume dm ³	Water content % (circa)	Calc. Bulk density kg/m ³	Dry density kg/m ³	Compaction pressure MPa	Filling height mm	Block saved Y/N	Remark
5:1	226.9	385	497	567	108	22.5	2,091	1,707.3	29	560+90	Y	90 mm pre-compaction. Rather good block, the four vertical edges are somewhat fragile.
5:2	228.3	390	497	567	110	22.5	2,077	1,695.8	27	560+90	Y	90 mm pre-compaction. Rather good block, the four vertical edges are somewhat fragile.
5:3	233.4	398	497	567	112	22.5	2,081	1,698.8	27	560+?	Y	5 bar pre-compaction. Rather good block, the four vertical edges are somewhat fragile.
5:4	218.6	375	497	567	106	22.5	2,069	1,688.7	27	560+?	Y	5 bar pre-compaction. Rather good block, the four vertical edges are somewhat fragile.
5:5	217	370	497	567	104	24	2,081	1,678.4	27	560+70	Y	5 bar pre-compaction. Rather good block, the four vertical edges are somewhat fragile. Mixed with material with 22.5% water content?
5:6	214.2	367	497	567	103	24	2,071	1,670.3	36	560+70	Y	5 bar pre-compaction. Rather good block, the four vertical edges are somewhat fragile.
5:7	219	366	497	567	103	24	2,123	1,712.4	44	560+75	Y	10 bar pre-compaction. Small crack! Too high load or water content? The four vertical edges are somewhat fragile.
5:8	214	366	497	567	103	24	2,075	1,673.3	36	560+75	Y	12 bar pre-compaction. Small crack! Too high load or water content? The four vertical edges are somewhat fragile.
5:9	188.1	323	497	567	91	24	2,067	1,666.6	27	560	Y	No pre-compaction. Small crack! Too high load or water content? The four vertical edges are somewhat fragile.

Table 5-10. Compilation of tests performed November 14–15 with ASHA. The Table shows the results from the tests performed with the crushed material. The material was after crushing conditioned at Äspö to higher water content.

Block no.	m kg	h mm	w mm	l mm	Volume dm ³	Water content % (circa)	Calc. Bulk density kg/m ³	Dry density kg/m ³	Compaction pressure MPa	Filling height mm	Block saved Y/N	Remark
5:10	215.9	372	497	567	105	20	2,060	1,716.3	27	560	Y	No pre-compaction. Small crack! Mixed with previous material? The four vertical edges are somewhat fragile.
5:11	196.4	340	497	567	96	20	2,050	1,708.2	27	485	Y	No pre-compaction. Rather good block, the four vertical edges are somewhat fragile.
5:12	185.8	325	497	567	92	20	2,029	1,690.6	27	465	Y	No pre-compaction. Rather good block, the four vertical edges are somewhat fragile.
5:13	186.3	320	497	567	90	20	2,066	1,721.6	36	465	Y	No pre-compaction. Rather good block, the four vertical edges are somewhat fragile.
5:14	199.1	345	497	567	97	24.7	2,048	1,642.3	27	510	Y	No pre-compaction. Rather good block, the four vertical edges are somewhat fragile.
5:15	*	*	*	*	*	24.7	*	*	5	500	N	Unsuccessful test! Maximum compaction pressure too low.
5:16	*	*	*	*	*	24.7	*	*	5	500	N	Unsuccessful test! Maximum compaction pressure too low.
5:17	186.1	320	497	567	90	24.7	2,064	1,655.0	38	530	Y	No pre-compaction. Rather good block, the four vertical edges are somewhat fragile.
5:31	*	*	*	*	*	20	*	*	27	560	Y	Unsuccessful test! Mixed material!
5:32	220.1	391	497	567	110	20	1,998	1,664.6	27	560	Y	Test with "vacuum-plate". No pre-compaction. Rather good block, the four vertical edges are somewhat fragile.
5:33	229.8	400	497	567	113	20	2,039	1,698.9	27	*	Y	Test includes three filling with one pre-compaction after two step. Rather good block, the four vertical edges are somewhat fragile.
5:34	236.4	412	497	567	116	20	2,036	1,696.8	27	*	Y	Test includes three filling with one pre-compaction after two step. Rather good block, the four vertical edges are somewhat fragile.



Figure 5-19. Photo showing an Asha 2010 block manufactured with the crushed material and with a water content of 20%.



Figure 5-20. Photo of one of the blocks manufactured with Minelco material.

A compilation of the results is provided in Table 5-11. The achieved block quality was good even if the blocks also for this material had somewhat fragile vertical edges. The achieved dry density of the blocks was rather high, 1,716 to 1,735 kg/m³, when compacting with a pressure of 36 MPa. When the pressure was lowered to 27 MPa, the dry density decreased to 1,610–1,660 kg/m³, which is too low compared to the requirements. However the visual quality increased and the vertical edges were of good quality.

In total eight blocks were compacted with this material and all of them were saved and sent to Äspö for sampling, see next section.

MX-80 conditioned to higher water content

The main reason for testing MX-80 was that blocks made of this material should be used for the construction of a plug. The blocks made of MX-80 will be piled inside the concrete plug and serve as an extra sealing. Another reason was to get more information regarding how different materials and different grain size distributions affects the achieved quality of blocks in this size.

One big bag, about 1,000 kg, of MX-80 was conditioned at Äspö to a water content of 17%. The quality of the compacted blocks was high even if also these blocks had somewhat fragile vertical edges, see Figure 5-21.

A compilation of the results is provided in Table 5-12. The blocks had a dry density of 1,693 to 1,704 kg/m³ with a compaction pressure of 27 MPa. In total five blocks were compacted with this material and all of them were saved and sent to Äspö for sampling, see next section.

5.8.3 Block investigations

Asha

There was a major difference in quality between blocks manufactured with the as-delivered material compared to when manufactured with the crushed material, and after a visual inspection it was decided that only blocks manufactured with the crushed material should be of interest for further investigation. Three blocks were chosen: 5:13, 5:17 and 5:33. Three cores were drilled out from each of the blocks, one at a corner, one from the middle of a long side and one from the center. The results from the investigation are presented in Figure 5-22. The charts show that the determined densities are well within the set limits. All blocks are quite homogeneous but a small density gradient can be seen in the corners.



Figure 5-21. One of the blocks manufactured with MX-80. The block quality was high even if the four vertical edges were somewhat fragile.

Table 5-11. Compilation of tests performed November 14–15 with Minelco. The tests included both the material as-delivered but also when conditioned to a water content of 20%.

Block no.	m kg	h mm	w mm	l mm	Volume dm ³	Water content % (circa)	Calc. Bulk density kg/m ³	Dry density kg/m ³	Compaction pressure MPa	Filling height mm	Block saved Y/N	Remark
5:18	205.8	356	496	566	100	20	2,059	1,716.0	27	560	Y	Nice block! Small damages on the four vertical edges.
5:19	205.2	351	496	566	99	20	2,082	1,735.4	36	560	Y	Nice block! As above!
5:20	229.8	395	496	566	111	20	2,072	1,726.9	36	560+69	Y	10 bar pre-compaction. Nice block! Small damages on the four vertical edges.
5:21	226.2	389	496	566	109	20	2,071	1,726.1	36	560+75	Y	10 bar pre-compaction. Nice block! Small damages on the four vertical edges.
5:22	202	360	496	566	101	16	1,999	1,723.0	36	560	Y	The best vertical edges so far! Small crack!
5:23	187.9	345.5	498	568	98	16	1,923	1,657.5	27	520	Y	Best block so far! No cracks and the vertical edges are quite nice!
5:24	222.9	412	496	566	116	16	1,927	1,661.3	27	560+65	Y	65 mm pre-compaction. Nice block, crack at the bottom? Nice edges!
5:25	180.4	332	496	566	93	16	1,936	1,668.6	27	500	Y	Nice block! No cracks and the vertical edges are quite nice!

Table 5-12. Compilation of tests performed November 14–15 with MX-80. The Table shows the results from the tests performed with material conditioned to a water content of 17%.

Block no.	m kg	h mm	w mm	l mm	Volume dm ³	Water content % (circa)	Calc. Bulk density kg/m ³	Dry density kg/m ³	Compaction pressure MPa	Filling height mm	Block saved Y/N	Remark
5:26	207.1	371	497	567	105	17	1,981	1,693.1	27	560	Y	Nice block! Small damages on the four vertical edges. Small crack!
5:27	181.7	324.5	497	567	91	17	1,987	1,698.3	27	490	Y	Nice block!
5:28	221.1	396	497	567	112	17	1,981	1,693.4	27	560+42	Y	5 bar pre-compaction. Nice block! Small damages on the four vertical edges.
5:29	181.5	323	497	567	91	17	1,994	1,704.3	27	490	Y	No pre-compaction. Nice block! Small damages on the four vertical edges.
5:30	*	323	497	567	91	17	*	*	27	490	Y	No pre-compaction. Nice block! Small damages on the four vertical edges.

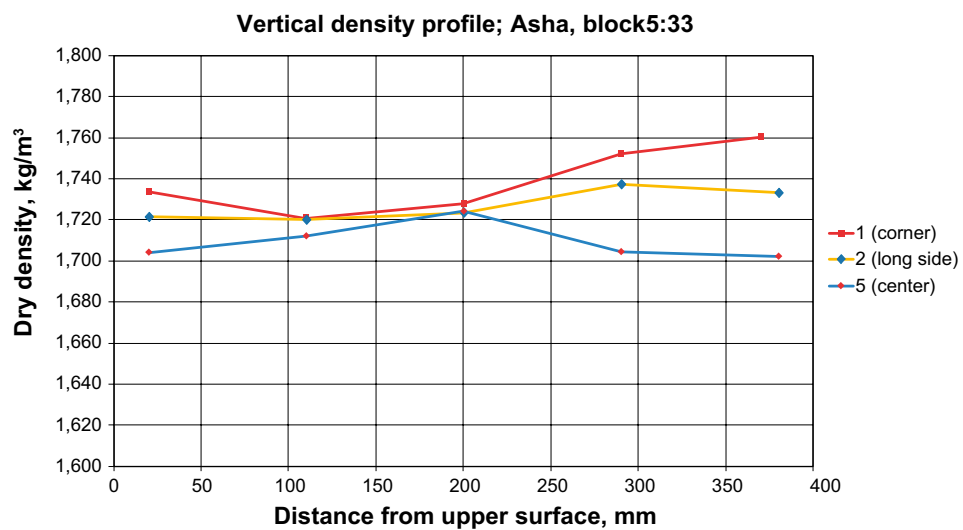
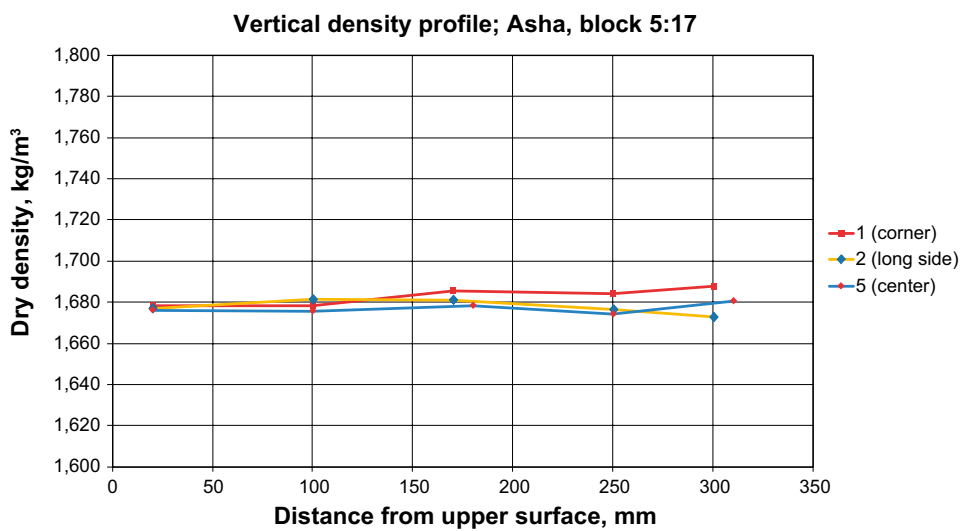
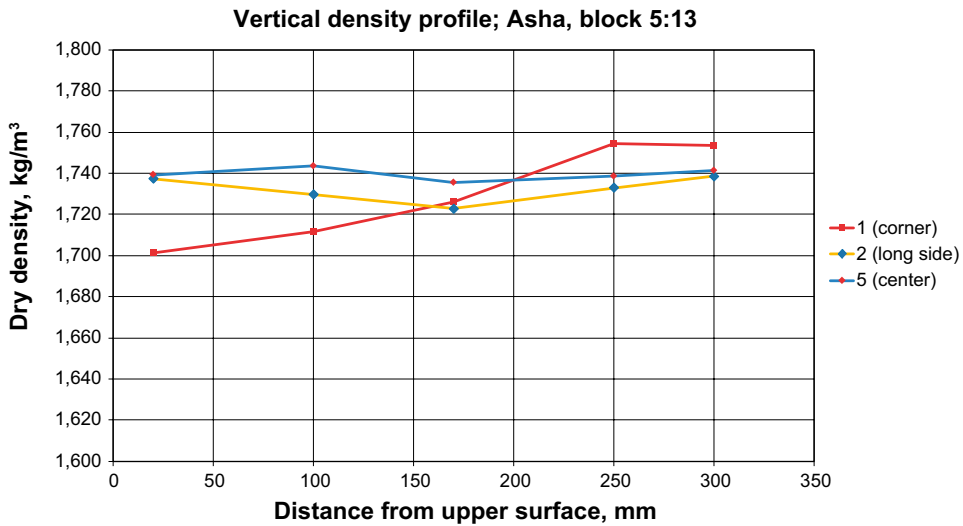

Figure 5-22. Chart showing density profiles determined in three blocks manufactured of Asha 2010 material, crushed and conditioned to higher water content.

Minelco

Three blocks were chosen for investigation of homogeneity: 5:20, 5:23 and 5:25, see results provided in Figure 5-23. Three cores were drilled out from each of the blocks one at a corner, one from the middle of a long side and one from the center. All Minelco blocks manufactured had a visually high quality with nice edges. Some loose material could, however, be seen at the outermost parts of the four vertical edges. The average dry density was high, about 1,740 kg/m³ in block 5:20. This block was compacted with 36 MPa at a water content of 20%. The two other blocks investigated were compacted with a pressure of 27 MPa and a water content of 16%. The average dry density of these two blocks was considerably lower, about 1,620–1,640 kg/m³.

MX-80

Three blocks out of five manufactured were chosen for investigation of homogeneity; block 5:27, 5:28 and 5:29. Three cores were drilled out from each of the blocks one at a corner, one from the middle of a long side and one from the center. All blocks had a visually high quality, similar to what was achieved with the Minelco material. The average dry density in the three investigated blocks was close to 1,700 kg/m³. A small density gradient could be seen in the corners and at the long sides.

5.9 Höganäs Bjuf AB, Februari 18, 2013, full scale blocks

5.9.1 General test description

Material: ASHA 2012

Block size: 500×571×400 mm

Objectives: Tests with the as-delivered ASHA 2012 material conditioned to higher water content (approx. 20%).

5.9.2 Test description and results

Asha 2012 raw material conditioned to higher water content

This was the first test with the new mould with rounded corners. In total twenty-five blocks were compacted, see compilation in Table 5-13. The material was conditioned at Äspö HRL, to a water content of approx. 20%.

The blocks were compacted with a rather low pressure, about 20 MPa. The achieved density was about 1,670 kg/m³ which are within the set limits. The block quality was very high i.e. there were no cracks and all edges were very stable and smooth. The new batch (Asha 2012) of material was obviously more adapted for block manufacturing and together with the new design of the mould, with rounded corners; it was possible to manufacture blocks with smooth and stable edges (Figure 5-25 and 5-26). The filling factor of the new material was 1.45. This in combination with the new mould made it possible to manufacture the blocks in one step i.e. no additional filling was necessary.

Six of the blocks (6:19 to 6:25) were sent to Clay Technology AB, Lund in order to test the stability when exposed for different relative humidities and the other 19 blocks were sent to Äspö HRL.

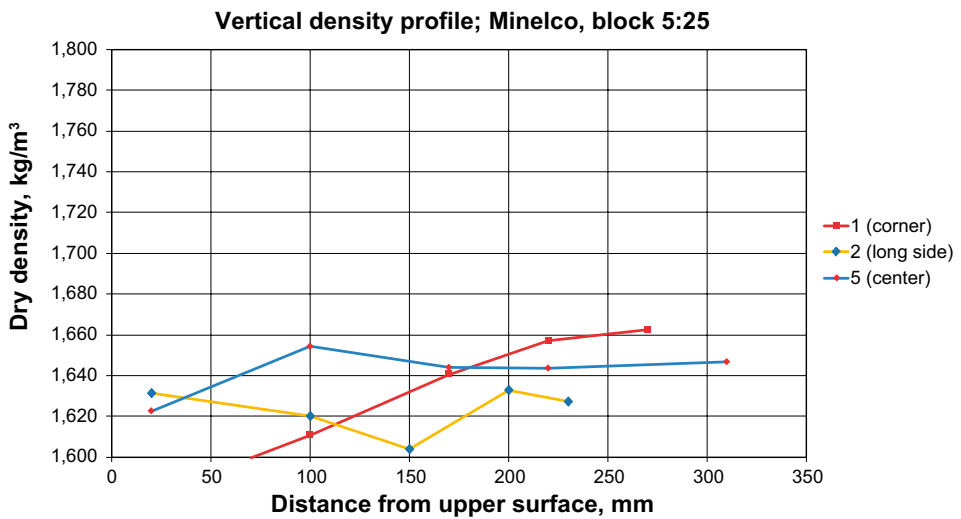
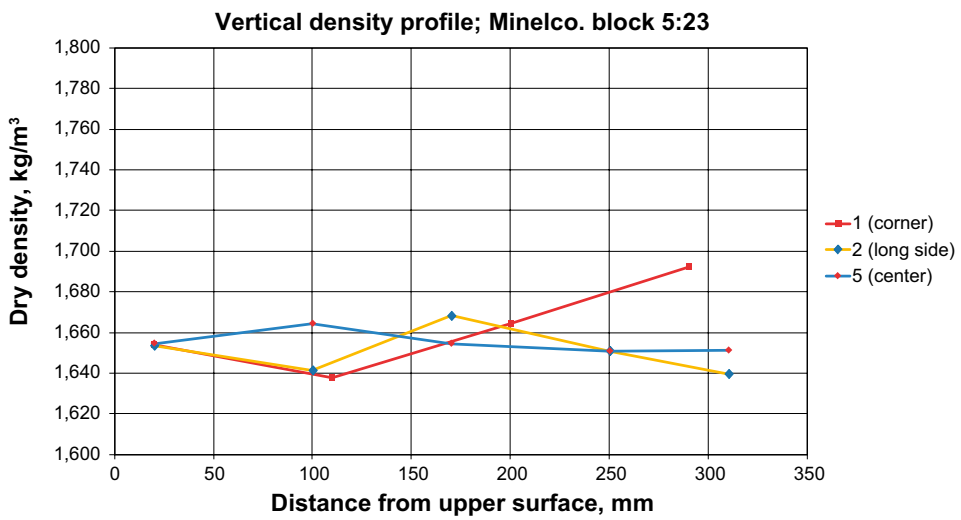
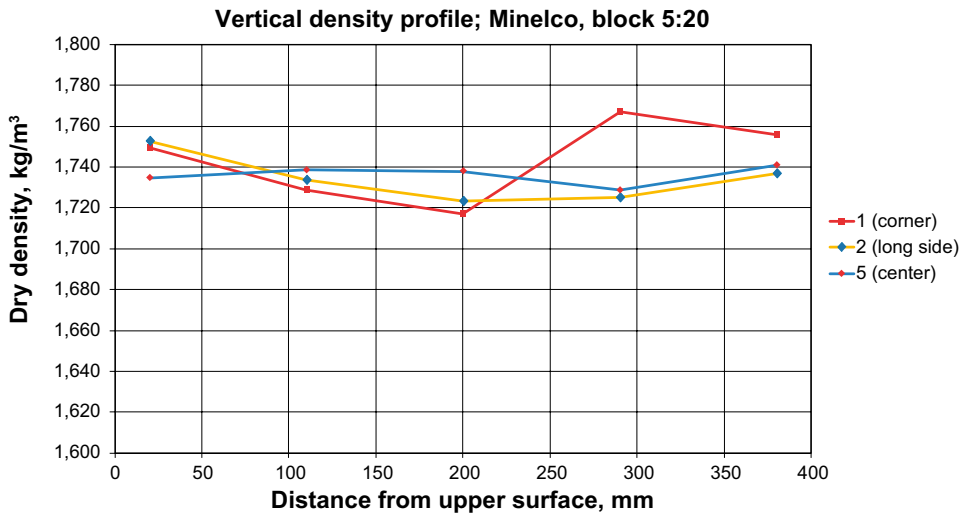

Figure 5-23. Chart showing density profiles determined in three blocks manufactured of Minelco material. Block compaction was made both with material as-delivered but also when conditioned to higher water content (20%).

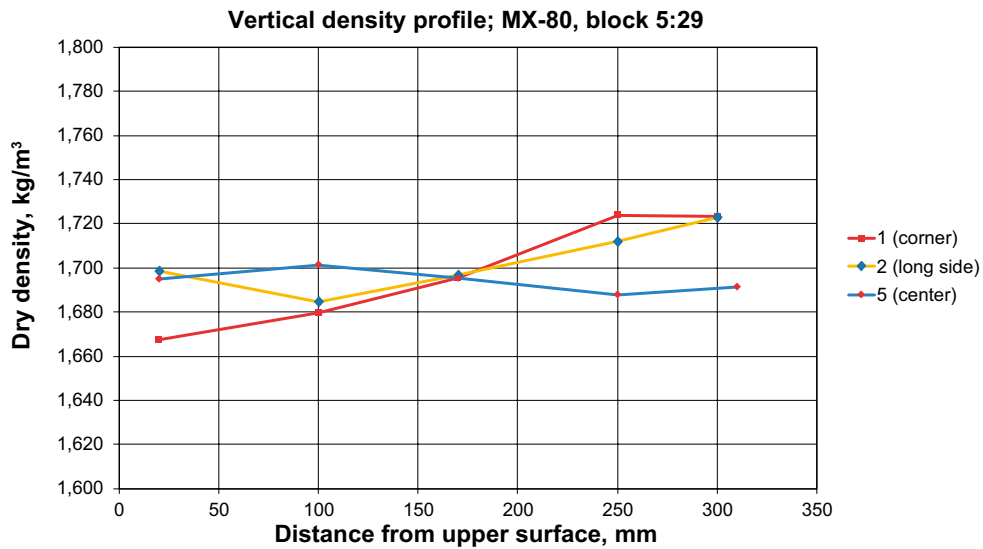
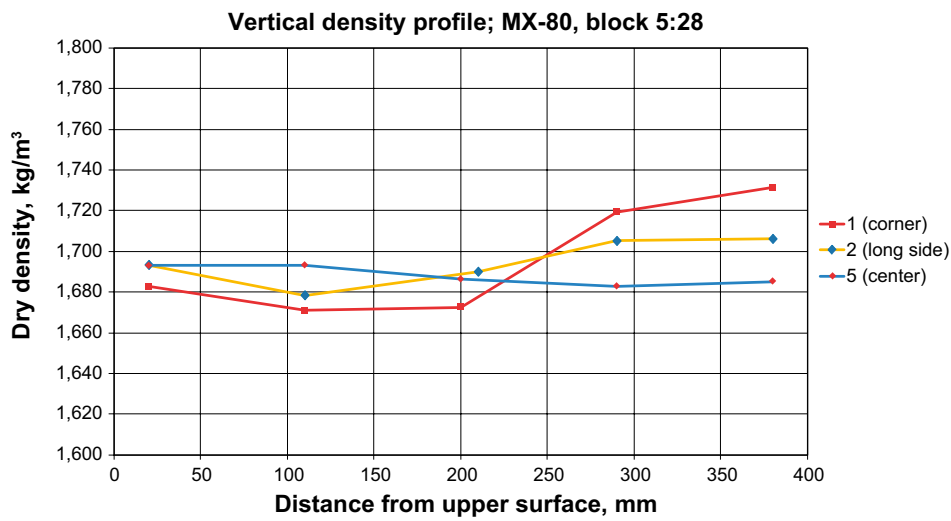
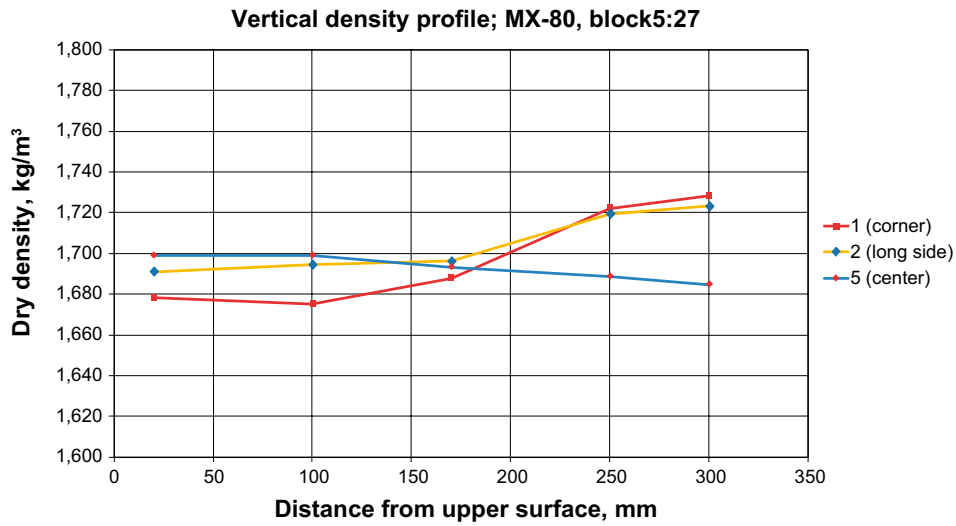

Figure 5-24. Chart showing density profiles determined in three blocks manufactured of MX-80 material. The material was before compaction conditioned to higher water content (17%).



Figure 5-25. Photo showing a block manufactured of Asha 2012 material.



Figure 5-26. Close-up of one of the vertical edges.

Table 5-13. Compilation of tests performed February 18, 2013, with Asha 2012. The table shows the results from the tests performed with material conditioned to a water content of 20%.

Block no.	m kg	h mm	w mm	l mm	Volume dm ³	Water content % (circa)	Calc. Bulk density kg/m ³	Dry density kg/m ³	Compaction pressure MPa	Filling height mm	Block saved Y/N	Remark
6:1	223.5	392	499	570	111	19.6	2,005	1,676.0	18	580	Y	Nice block, the four vertical edges are smooth and seems to be stable.
6:2	231.9	399	499	570	113	19.6	2,043	1,708.5	25	600	Y	As above, some small fractures (depending on the higher pressure?)
6:3	231.7	404	499	570	115	19.6	2,016	1,685.9	20	600	Y	Nice block, smooth and stable edges.
6:4	*	408	499	570	116	19.6	*	*	20	600	Y	Nice block, smooth and stable edges.
6:5	*	399.5	499	570	114	19.6	*	*	19	575	Y	Nice block, smooth and stable edges.
6:6	227.9	399.5	499	570	114	19.6	2,006	1,677.0	19	575	Y	Nice block, smooth and stable edges.
6:7	228.6	401.8	499	570	114	19.6	2,000	1,672.5	20	*	Y	Nice block, smooth and stable edges.
6:8	*	401.8	499	570	114	19.6	*	*	20	*	Y	Nice block, smooth and stable edges.
6:9	227.3	401	499	570	114	19.6	1,993	1,666.3	19	*	Y	Nice block, smooth and stable edges.
6:10	227.3	400.1	499	570	114	19.6	1,997	1,670.0	20	*	Y	Nice block, smooth and stable edges.
6:11	*	400.5	499	570	114	19.6	*	*	19	*	Y	Nice block, smooth and stable edges.
6:12	*	400.8	499	570	114	19.6	*	*	20	*	Y	Nice block, smooth and stable edges.
6:13	*	400	499	570	114	19.6	*	*	19	*	Y	Nice block, smooth and stable edges.
6:14	*	398.5	499	570	113	19.6	*	*	18	*	Y	Nice block, smooth and stable edges.
6:15	*	400.5	499	570	114	19.6	*	*	19	*	Y	Nice block, smooth and stable edges.
6:16	*	400.5	499	570	114	19.6	*	*	21	*	Y	Nice block, smooth and stable edges.
6:17	*	402	499	570	114	19.6	*	*	19	*	Y	Nice block, smooth and stable edges.
6:18	*	400.5	499	570	114	19.6	*	*	19	*	Y	Nice block, smooth and stable edges.
6:19	*	400	499	570	114	19.6	*	*	18	*	Y	Nice block, smooth and stable edges.
6:20	*	395	499	570	112	19.6	*	*	18	*	Y	Nice block, smooth and stable edges.
6:21	*	395	499	570	112	19.6	*	*	18	*	Y	Nice block, smooth and stable edges.
6:22	*	396.2	499	570	113	19.6	*	*	18	*	Y	Nice block, smooth and stable edges.
6:23	*	396.3	499	570	113	19.6	*	*	18	*	Y	Nice block, smooth and stable edges.
6:24	*	396	499	570	113	19.6	*	*	18	*	Y	Nice block, smooth and stable edges.
6:25	*	390.8	499	570	111	19.6	*	*	16	*	Y	Nice block, smooth and stable edges.

6 Summary and conclusions

6.1 General

The work described in this report was made in order to investigate the possibility to manufacture backfill blocks in full scale. The performed work can be divided into the following parts:

- Laboratory investigations of the tested materials.
- Adaptation of one of the materials (crushing to another granule size distribution) in order to increase the block quality.
- Manufacturing of blocks in brick size to be used in tests performed in scale 1:2.
- Test the technique for manufacturing blocks in full scale (500×571×400 mm) with a number of different materials.
- Extensive sampling of manufactured blocks in order to control the homogeneity and possible presence of cracks.

This section summarizes the main conclusions from the performed work.

6.2 Material tests in laboratory

6.2.1 General

Five different materials have been tested; two from Asha 2010 and one from Ibeco, Minelco and MX-80 respectively. Asha and Ibeco were the main backfill candidate materials while Minelco was added later as an option because of the initial problems that occurred with the Asha material in the full scale manufacturing tests. MX-80 was added in the test series mainly because it was of interest for the construction of the plug.

A number of different laboratory tests were performed:

- Determination of the grain size distribution of the as-delivered material. The granule size distribution is an important factor that affects the quality of the blocks.
- Tests to investigate the compaction properties. Samples were compacted with different pressures at different water contents. This investigation gives information regarding the optimum water content in order to reach as high density as possible.
- Tests to investigate the influence of friction (compaction under adverse conditions). These tests show the effect of friction between the bentonite and the mould on the density distribution within the compacted blocks. The tests also yield information regarding the filling factor and the force needed for de-moulding.

6.2.2 Grain size distribution

The influence of granule size distribution of the materials regarding the final block quality is not completely clear. It is, however, believed that the granule size affects the de-airing during compaction and also the bulk density of the loose filling and by that also the final block density.

Two of the backfill candidate materials tested, Asha 2010 and Ibeco, were ordered with the following rather vague requirements:

- Granule size distribution between 0–5 mm.
- Maximum 20% < 0.063 mm.

The as-delivered Asha 2010 material contained, however, a lot of coarser material, see Figure 3-1, which influenced the block quality in a negative way i.e. the block edges become very brittle and material from the edges and corners fell off during handling. After crushing of the material to a grain size distribution similar to the Ibeco material, the quality of the blocks increased considerably. A new

batch from Ashapura was delivered in 2012. This material was ordered with the specification, that all granules should be finer than 3 mm. A visual inspection indicated, however, that the material had been crushed between two rollers with a gap spacing of ~3 mm. This procedure had disintegrated, or reshaped, the large granules but at the same time new granules had been formed with a thickness of 3 mm and of various lengths and widths. The granule size distribution of the 2012 batch was therefore very similar to the 2010 batch. The 2012 batch had, however, much better compression properties and it was therefore possible to manufacture blocks with high quality.

The Minelco material had a granule size distribution similar to the as-delivered Asha 2010. The blocks manufactured with this material were, however, of good quality. The reason for this is probably that the Minelco granules were softer than the Asha granules and due to this could be formed during the compaction.

The MX-80 material has a different granule size distribution compared with the other material since all granules are smaller than one mm. In spite of this it was possible to manufacture blocks of high quality.

6.2.3 Compaction properties

Tests were made at two different compaction pressures, 25 and 50 MPa. None of the tested materials, Asha 2010, Ibeco and Minelco (the compaction properties of MX-80 and Asha 2012 was not tested within this project) showed any clear optimum water content. The densities achieved were similar to what later was achieved in the full scale.

Earlier investigations have shown that the achieved block quality increases at a water content of about 17–20%. The block stability when exposed to relative humidity similar to what is expected in deposition tunnels is also higher at these water contents. At lower water contents all edges become very brittle and the blocks more sensitive to the climate expected in the tunnels.

Based on experience from earlier tests both Asha 2010 and Ibeco were ordered with a water content of $16\% \pm 1.5$. Asha was delivered with an average water content of 16.3% and Ibeco with an average of 20.2%. The tests showed that the best quality was achieved at about 20% for both materials which means that the Asha material had to be conditioned in a mixer. The Minelco material was tested at both 16% and 20%, and it was possible to manufacture blocks with high quality with both water contents. MX-80 was only tested with a water content of 17%. A decision had been made earlier that this was the water content of interest for this material.

6.3 Manufacturing of brick size blocks

About 90 tons of brick size blocks (300×150×75 mm) were manufactured, 80 tons of Asha 2010 and 10 tons of Ibeco. The blocks were manufactured at three different occasions during January to June 2011. The objective with this manufacturing was to produce blocks for a number of tests planned to be performed at Äspö HRL (steel tunnel tests in ½ scales).

Blocks were chosen during manufacturing in order to control the achieved density and the homogeneity of the blocks. The first blocks manufactured (Asha) had somewhat low dry density, 1,638 to 1,685 kg/m³, but after increasing of the pressure from 25 to 35 MPa the dry density increased to between 1,700 to 1,750 kg/m³. The homogeneity of the blocks were investigated by taking samples at different positions, two samples at the upper side and two from the bottom side. The dry density was found to be somewhat higher at the top side compared to the bottom side, but no large differences were found between corners and the middle of the long side.

A small problem occurred with the Ibeco material. The material stuck to the upper piston which resulted in production stop and the surface of the piston had to be cleaned. The problem was found to occur when big bags containing material with water content higher than the average was used. The sticking problems decreased when big bags with somewhat drier material was used. Because of this problems it was, however, decided to mainly produce brick size blocks of the Asha 2010 material.

The manufactured brick size blocks had an overall high quality and were judged to be suitable for the planned scale tests.

6.4 Manufacturing of full scale blocks

6.4.1 General

Blocks have been produced in full scale with all tested materials. The main problems were related to the as-delivered Asha 2010 material. This material contained a rather large amount of coarser material which affected the block quality in a negative way. All edges and corners become very brittle and material fell off during handling of the blocks. After having crushed the material to a more suitable granule size distribution the block quality increased significantly.

6.4.2 Press cycle and moulds

The first full scale mould had a limited filling height, 560 mm, which resulted in that a so-called two step compaction (after the initial filling of the mould a pre-compaction with low pressure was made and after that a new filling before the final compaction could start) had to be done in order to manufacture blocks with a height of 400 mm. Since it was found that an automation of this press cycle would lead to major up-dating of the press control system, the press cycle was performed partly by manual control during the test time with this mould.

As a second step, a new full scale mould was manufactured. This mould had a filling height of 685 mm and was equipped with a radius of 5 mm in the four vertical corners. With this mould it was possible to manufacture the blocks in one step. The small radius in the corners resulted in stable block corners.

6.4.3 Block quality

The block quality has been assessed regarding the following parameters:

1. Achieved dry density.
2. Homogeneity (density distribution within the blocks).
3. The presence of cracks and/or loose material.
4. The sharpness and stability of the block edges.

The tests have shown that it is possible to manufacture full scale backfill blocks with an average dry density between 1,650–1,750 kg/m³ which is the set limits.

The homogeneity of the blocks has been investigated by drilling cores at different positions. The cores have then been cut in slices and the water content and density determined at different levels. The investigations showed that there are density gradients in the blocks especially along the four vertical corners. The density is higher at top and bottom and the lowest densities were found at mid height in the corners. The largest differences in dry density are in the order of 50 to 60 kg/m³. Samples taken from the block center and along the middle point of the long sides are considerably more homogeneous. The density distribution within the blocks is not expected to influence the block handling or the final density distribution within the tunnel.

During the initial tests some cracks occurred, see example in Figure 5-6. After optimizing of the compaction cycle and introducing of the de-airing steps, this problem disappeared. The cores drilled from the blocks, were visually judged to be of high quality, and did not show any cracks or other weaknesses. The two step compaction with an extra filling did not seem to result in any weaknesses either. The biggest problem has been the stability of the four vertical edges of the blocks. Especially the first batch from Asha delivered in 2010 resulted in very brittle edges, where loose material fell off. After adjustment of the material specification regarding granule size distribution and optimization of the water content, the quality of the edges increased remarkably and the latest tests, which were performed with the new mould with rounded corners, resulted in blocks with very stable edges.

6.4.4 Technical aspects

The elastic expansion of the block manufactured in full scale has been in the order of 0.5% (at water contents around 20%). The expansion varied somewhat for different water contents and for different materials. This has to be taken into account when deciding the size of a new mould.

The tests have also shown that it is possible to manufacture blocks with the right density and the right height. The compaction process will, however, be simplified if the compaction can be done in one step.

6.5 Recommendations and conclusions

One of the main outcomes from the performed tests is that it is possible to manufacture full scale backfill blocks with high quality. The tests have been made in an existing press at Höganäs Bjuf AB. New moulds were built in order to produce blocks with right dimensions. In a future block manufacturing plant the press should be designed with:

1. The right filling height of the mould. A press designed for a suitable filling height will simplify the manufacturing significantly. Manufacturing blocks with a height of 400 mm will need a filling height of at least 600–640 mm for Asha/Minelco and 720 mm for Ibeco. (The second mould constructed for the press at Höganäs Bjuf AB worked well for the Asha material).
2. Equipment for de-airing. The present tests have been made without vacuum equipment. Instead a number of de-airing steps were made during the manufacturing. This means that the upper piston releases the pressure for a short time (1–2 seconds) and during this time trapped air can flow out. This procedure was repeated seven times during the compaction of one block and was found to markedly improve the block quality. In a future manufacturing plant it is recommended that the press is equipped with a vacuum device, making it possible to de-air the powder before compaction. This will probably increase the block quality, decrease the risk of cracking and also increase the block manufacturing rate.

The tests have also shown that the material properties are important in order to achieve blocks with high quality. It is necessary to perform laboratory tests in order to get information of the expected behavior in full scale. Important material properties are:

1. Water content. Influences both internal friction of the material and also the external i.e. between the bentonite and the steel mould. This is a parameter that quite easy can be adjusted before block compaction by use of large mixers.
2. Granule size distribution.
 - This is important for the de-airing of the material in order to avoid trapped air. A press equipped with vacuum will probably improve the block quality.
 - The granule size distribution affects also the bulk density of the loose filling and decreases by that the need of a high mould (decreases the filling factor).
 - The materials tested within this project have very different granule size distribution. E.g. in the MX-80 material all granules are finer than 1 mm while for Asha approximately 60–70% of the granules are larger than 1 mm. It is therefore difficult to recommend a granule size distribution that is working for all backfill candidate materials. The recommendation is instead to perform tests with all materials before starting manufacturing in large scale.
 - If material with a certain granule size distribution is transported in for example big bags, problems with separation could occur. This means that the material has to be mixed again before starting the block manufacturing. It was also discovered that there in some cases were large differences between different big bags (Asha 2010 and 2012). Some big bags seemed to contain a lot of fines while other only contained large granules. In order to avoid this kind of problem it will be necessary to have the possibility to adjust the granule size distribution of a material in connection to the block manufacturing factory (crushing, sieving and mixing equipment).
3. Mineral composition. Influences the friction during compaction, both internal in the material but also against the steel mould. The mineral composition influences probably also the stiffness of the granules and by that also the sharpness of the block edges. The performed tests with the as-delivered Asha material have shown that material including large and hard granules affect the quality of the block edges strongly. After crushing of the material to a more suitable granule size distribution the block quality increased.

In a future backfill block manufacturing factory it will be necessary to have the possibility to adjust the water content (large mixers) and the granule size distribution (crushing equipment) of the delivered materials. It is recommended to perform a number of pre-tests in laboratory e.g. determination of compaction properties and investigation of friction and how it influences the density distribution and the quality of the compacted blocks.

References

SKB's (Svensk Kärnbränslehantering AB) publications can be found at www.skb.se/publications.

Sandén T, Olsson S, Andersson L, Dueck A, Jensen V, Hansen E, Johnsson A, 2014.
Investigation of backfill candidate materials. SKB R-13-08, Svensk Kärnbränslehantering AB.

SKB, 2010. Design, production and initial state of the backfill and plug in deposition tunnels.
SKB TR-10-16, Svensk Kärnbränslehantering AB.

Ibeco RWC-BF 2010

Data sheet

S&B Industrial Minerals GmbH

IBECO®**IBECO RWC-BF**

Beschreibung	Description	Description
Natürlicher Calziumbentonit mit mittlerem Montmorillonitgehalt	Calcium bentonite natural with a medium montmorillonite content	Bentonite calcique naturelle à moyen teneur en montmorillonite

Anwendung	Application	Application
Als Dicht- und Versatzmaterial für Untertage-Deponien	As sealing and backfilling material for underground repositories	Comme cachetage et matériel de remblai pour les dépôts souterrains

	Technische Durchschnittswerte	Technical values (average)	Valeur techniques (moyenne)		
w	Wassergehalt ISO 787/2	Water content	Teneur d'eau	16 ± 1,5	%
ρ _s	Dichte DIN 51057	Specific density	Poids spécifique	2,65	g/cm ³
	Schüttdichte DIN 53466	Bulk density	Densité apparente tassée	1020 ± 50	g/l
	Körnung	Grain size	Granulation	0 - 5	mm
	Siebrückstand auf Sieb 0,063 mm DIN 53734	Dry screen residue on sieve 0,063 mm	Refus au tamis (voie sèche) 0,063 mm	> 80	%
	Methylenblau-Adsorption VDG P69	Methylen-blue-adsorption	Adsorption du bleu de méthylène	300 ± 30	mg/g
CEC	Kationenaustauschkapazität	Cation exchange capacity	Capacité d'échange de cations	60 ± 10	mval/100g
w _A	Wasseraufnahmevermögen Enslin-Neff, DIN 18132	Water absorption capacity	Capacité d'absorption d'eau	150± 30	%
	Quellvolumen	Swelling index	Gonflement	≥ 7	ml/2g
w _L	Fließgrenze DIN 18122	Liquid limit	Limite de liquidité	115	%
w _P	Ausrollgrenze DIN 18122	Plastic limit	Limite de plasticité	33	%
I _p	Plastizitätszahl (errechnet)	Plasticity index (calculated)	Indice de plasticité (calculée)	82	%

Lieferform	Delivery	Livraison
<ul style="list-style-type: none"> • Lose per Silo-Lkw • In Säcken, auf Paletten, geschrumpft • In Big Bags 	<ul style="list-style-type: none"> • Bulk per road tanker • In bags on pallets, shrink wrapped • In big bags 	<ul style="list-style-type: none"> • Vrac en camion-silo • En sacs sur palette filmée • En big bags

Da wir auf die Verwendung unseres Produktes keinen Einfluss nehmen können, beschränkt sich unsere Haftung auf diese Produktinformation.	The values listed are indicative and are not to be construed as rigid specifications.	Les renseignements contenus dans cette fiche technique sont fournis à titre indicatif et ne peuvent engager notre responsabilité.
---	---	---

S&B Industrial Minerals GmbH - Geschäftsbereich IBECO - Ruhrorter Straße 72 • D – 68219 Mannheim • Tel.+49 6 21 / 8 04 27-0 • Fax +49 6 21 / 8 04 27-50
--

DKOC 08.12

Asha NW BFL-L 2010**Data sheet**

Note: Under the heading "Description of goods" the wrong material is described. The right material is within parenthesis.

**ASHAPURA MINECHEM LIMITED**

LABORATORY TEST REPORT OF
FINAL INSPECTION REPORT

QR/AIL/QA/22
REV. 0

CERTIFICATE OF ANALYSIS

INVOICE NO. : AML/CONT/0192/2010-11 Date: 26.10.2010
 BUYER : SVENSK KARNBRANSLEHANTERING AB
 ASPOLABORATORIET
 BOX 929, SE-572 29 OSKARSHAMN.
 DESCRIPTION OF GOODS : 12.500 MT ATTAPULGITE POWDER .
 (ASHA NW BFL-L)
 PACKING : 200 BAGS X 1.25 MT JUMBO BAGS 2 BAGS ON 1 PALLETT.
 LOADING PORT : MUNDRA, INDIA
 DISCHARGE PORT : MALMO PORT, SWDEN
 MARKING : FRONT SIDE: FOR ASHA NW BFL-L. BACKSIDE: POUCH MARKING REQUIRED
 AS ASHA NW BFL-L. BAG NO. LOT NO.

Parameters	Requirement	Results
Moisture Content	15 - 17 %	15.40%
Montmorillonite	55% Min	69.20%
Granules Size	0.5 --- 10 mm	OK

For ASHAPURA MINECHEM LTD.



[Signature]
 AUTHORIZED SIGNATORY

Volclay MX-80

Technical data



AMERICAN COLLOID COMPANY

Industrial Specialties

Technical Data

General Purpose
Granular

Revised 8/28/09

VOLCLAY® MX-80

General Description	Fine granular sodium bentonite with an average particle size ranging between 40 and 200 mesh.																		
Functional Use	Multi-purpose product noted for rapid dispersion in water. Employed in a wide variety of industrial applications.																		
Purity	Hydrous aluminum silicate comprised principally of the clay mineral montmorillonite. Contains minor amounts of feldspar, calcite, and gypsum.																		
Chemical Formula	Diocahedral smectite, an expanding layer silicate: $(\text{Na,Ca})_{0.33}(\text{Al}_{1.57}\text{Mg}_{0.33})\text{Si}_4\text{O}_{10}(\text{OH})_2 \cdot n\text{H}_2\text{O}$																		
Elemental Composition	Typical analysis – moisture free. <table> <tr><td>SiO₂</td><td>63.02 %</td></tr> <tr><td>Al₂O₃</td><td>21.08 %</td></tr> <tr><td>Fe₂O₃</td><td>3.25 %</td></tr> <tr><td>FeO</td><td>0.35 %</td></tr> <tr><td>MgO</td><td>2.67 %</td></tr> <tr><td>Na₂O</td><td>2.57 %</td></tr> <tr><td>CaO</td><td>0.65 %</td></tr> <tr><td>Trace</td><td>0.72 %</td></tr> <tr><td>LOI</td><td>5.64 %</td></tr> </table>	SiO ₂	63.02 %	Al ₂ O ₃	21.08 %	Fe ₂ O ₃	3.25 %	FeO	0.35 %	MgO	2.67 %	Na ₂ O	2.57 %	CaO	0.65 %	Trace	0.72 %	LOI	5.64 %
SiO ₂	63.02 %																		
Al ₂ O ₃	21.08 %																		
Fe ₂ O ₃	3.25 %																		
FeO	0.35 %																		
MgO	2.67 %																		
Na ₂ O	2.57 %																		
CaO	0.65 %																		
Trace	0.72 %																		
LOI	5.64 %																		
Moisture	Maximum 12% as shipped.																		
Dry Particle Size	Maximum 20% retained on 40 mesh. Maximum 12% passing 200 mesh.																		
Wet Particle Size	Minimum 94% finer than 200 mesh (74 microns). Minimum 92% finer than 325 mesh (44 microns).																		
pH	8.0 - 10.5 @ 5% solids.																		
Viscosity	8 - 30 cps @ 6.25% solids.																		
Packaging	50 or 100 pound multi-wall paper bags, or bulk.																		

Disclaimer: The information and data contained herein are believed to be accurate and reliable. ACC makes no warranty of any kind and accepts no responsibility for the results obtained through application of this information.

American Colloid Company 2870 Forbs Avenue Hoffman Estates, IL 60192 847.851.1700 800.426.5564 Fax 847.851.1699 www.colloid.com