

**International
Progress Report**

IPR-03-45

Äspö Hard Rock Laboratory

Backfill and Plug test

**Sensors data report
(Period 990601-030701)
Report No:7**

Reza Goudarzi
David Gunnarsson
Lennart Börgesson
Clay Technology AB

July 2003

Svensk Kärnbränslehantering AB

Swedish Nuclear Fuel
and Waste Management Co
Box 5864
SE-102 40 Stockholm Sweden
Tel +46 8 459 84 00
Fax +46 8 661 57 19



**Äspö Hard Rock
Laboratory**

| | |
|-------------------|------------|
| Report no. | No. |
| IPR-03-45 | F61K |
| Author | Date |
| Reza Goudarzi | July 2003 |
| David Gunnarsson | |
| Lennart Börgesson | |
| Checked by | Date |
| Approved | Date |
| Christer Svemar | 2003-12-16 |

Äspö Hard Rock Laboratory

Backfill and Plug test

Sensors data report (Period 990601-030701) Report No:7

Reza Goudarzi
David Gunnarsson
Lennart Börgesson
Clay Technology AB

July 2003

Keywords: Backfill, plug, instrumentation, data, measurements, in situ, water pressure, total pressure, suction, moisture, unsaturated, bentonite, crushed rock

This report concerns a study which was conducted for SKB. The conclusions and viewpoints presented in the report are those of the author(s) and do not necessarily coincide with those of the client.

Abstract

This report presents data from the measurements in the Backfill and Plug Test during the period 99-06-01 to 03-07-01. Water pressure in the rock is measured in 73 points, pore water pressure in the backfill is measured in 33 points, total pressure is measured in 20 points and water pressure in the drainage layers of filter mats is measured in all 12 layers. The water saturation process in the backfill is checked in 57 measuring points.

The positions of the measuring points in the backfill are related to the backfill section, the number of the compacted layer, the tunnel axis, and the rock surface. The positions of the measuring points in the rock are related to the backfill section where the hole enters and the measuring section in the borehole.

Water pressure in the mats was increased from about 50 kPa to about 500 kPa during the period 2001-10-03 to 2002-01-21 in order to reach saturation within reasonable time. The increase in water pressure had the intended effect, since the saturation rate increased and all relative humidity sensors seemed to indicate full water saturation at the turn of the year. The conclusion is that the backfill is water saturated and that the flow testing can start.

Measurement of the water inflow to the neighbouring Demonstration Tunnel (K-tunnel) started 02-09-19 and the results are presented in this report. The measurements with the local permeability probes supplied and installed by Aitemin are not evaluated in this report.

Sammanfattning

I denna rapport presenteras data från mätningar i Backfill and Plug Test under period 99-06-01 till 03-07-01. Vattentryck i berget mäts i 73 punkter, porvattentryck i återfyllningen mäts i 33 punkter, totaltryck i 20 punkter och vattentryck i permeabla skikt av filtermattor mäts i alla 12 sektioner. Vatteninnehållet i återfyllningen mäts eller indikeras i 57 punkter.

Mätpunkternas positioner anges för återfyllningen i relation till återfyllningssektion, packningslager, tunnelcentrum och bergyta. För mätpunkterna i berget anges återfyllningssektionen som borrhålet mynnar i, var på bergytan hålet mynnar och mätsektionen i borrhålet.

Vattentrycket i mattorna har ökats från ca 50 kPa till 500 kPa under perioden 2001-10-03 till 2002-01-21 för att få vattenmättnad i rimlig tid. Tryckökningen hade avsedd effekt, vattenmättnadstakten ökade och vid årsskiftet 2002 / 2003 så verkade alla psychrometerar indikera full vattenmättnad. Slutsatsen är att återfyllnaden är vattenmättad och att flödestesterna kan påbörjas.

Mätning av inflödet av vatten till en närliggande, parallell tunnel (K-tunneln) startade 2002-09-19 och resultaten presenteras i denna rapport. Mätningarna av lokal permeabilitet som görs av Aitemin utvärderas inte i denna rapport.

Contents

| | | |
|----------|---|-----------|
| 1 | Introduction | 9 |
| 2 | Comments | 11 |
| 2.1 | General | 11 |
| 2.2 | Total Pressure, Glötzl | 11 |
| 2.3 | Total pressure, Roctest | 11 |
| 2.4 | Suction, Wescore Psychrometers | 12 |
| 2.5 | Resistivity, resistivity probe | 12 |
| 2.6 | Indication of saturation, CT tube | 13 |
| 2.7 | Pore water pressure in backfill, Glötzl | 13 |
| 2.8 | Pore water pressure in the backfill, Druck | 13 |
| 2.9 | Water flow into permeable sections | 13 |
| 2.10 | Water pressure in permeable mats, Druck | 14 |
| 2.11 | Water flow past the plug | 14 |
| 2.12 | Water flow from the inner part of the drift. | 14 |
| 2.13 | Water flow into neighbouring drifts | 14 |
| 2.14 | Water pressure in the rock, Druck | 15 |
| 3 | Geometry | 17 |
| 4 | Location of instruments in the backfill | 19 |
| 4.1 | Brief description of the instruments | 19 |
| 4.1.1 | Measurement of total pressure in the backfill | 19 |
| 4.1.2 | Measurement of pore water pressure in the backfill | 19 |
| 4.1.3 | Measurement of the water saturation process in the backfill | 19 |
| 4.1.4 | Measurement of temperature | 20 |
| 4.1.5 | Other measurements | 20 |
| 4.2 | Strategy for describing the position of each device | 20 |
| 4.3 | Position of each instrument in the backfill | 23 |
| 5 | Location of instruments in the rock | 27 |
| 5.1 | Brief description of the instruments and the packers | 27 |
| 5.2 | Position of each measuring section | 27 |
| 6 | Data from measurements | 31 |
| 7 | Quick guide | 71 |

1 Introduction

The installation of the Backfill and Plug Test was made during spring 1999. The different measurements started at different times as the transducers were connected to their data acquisition systems. In this report the data acquired until 2003-07-01 are presented. In general the data in this report are presented in diagrams covering the time period 1999-06-01 to 2003-07-01. The time axis in the diagrams represents days from 1999-06-01 except for readings from the flow meters.

A test overview with the positions of the permeable sections, the positions of the measuring points and a brief description of the instruments is also included in this report. A quick guide to the positions of all instruments in the backfill that can be unfolded to A3 format is enclosed as the last page. Explanation of denominations is presented in Chapter 4.

General comments concerning the collection of the data are also given.

2 Comments

2.1 General

In this chapter short comments on general trends in the measurements are given. Sensors that are not delivering reliable data or no data at all are noted and comments on the data collection in general are given.

The sixth report covered the period up to 030101. This report is the seventh one and covers the results up to 030701, which corresponds to day 1491 on the time axis in the diagrams.

The plug was grouted on June 27 2001 and the water pressure in the permeable mats and in the drained inner part of the drift was increased in steps of 100 kPa to 500 kPa at the following times:

100 kPa: 2001-10-03 (day 854)
200 kPa: 2001-11-14 (day 896)
300 kPa: 2001-11-28 (day 910)
400 kPa: 2001-12-10 (day 922)
500 kPa: 2002-01-21 (day 965)

2.2 Total Pressure, Glötzl

Data are presented on pages 33-34.

The Glötzl Data Acquisition system broke down once again in the very end of 2002 when some of the sensors started to give unrealistic readings. This was confirmed by manual readings and the system was taken off line. It was decided that the readings will be made manually once a week.

All pressure cells seem to work well except for P58 that has never been connected to the DAS and P59 that was disconnected after the first DAS breakdown. The manual readings show a general increase in total pressure but this is based on rather few measurements and will have to be confirmed in the next data report.

2.3 Total pressure, Roctest

Data are presented on page 35.

All cells seem to deliver reliable data except P51, which stopped functioning at the end of the latest measuring period. All of the sensors, except for P61 (located in the 20 % bentonite blocks at the plug) that has increased from 600 to 770 kPa, have been stable ever since the increase in saturating water pressure to 500 kPa.

2.4 Suction, Wescore Psychrometers

Data are presented on pages 36-39.

The Psychrometers are mainly placed in the 30/70 backfill. The exceptions are W67 and W77 that are placed in the 0/100 backfill, and W83 and W84 that are placed among the bentonite blocks in B6. In the first material the water saturation was quick and the psychrometers were drowned. The psychrometers are not designed for measuring suction in the latter material until very close to water saturation. Data from the sensors in these materials are not presented in this data report.

The suction of 30/70 is about 3000 kPa at the initial water content and decreases with increasing degree of saturation. At complete saturation the suction is about 1000 kPa or lower.

The measured values show that most sensors behave in a rational manner indicating that they function in a proper way. The following exceptions can be noted:

1. At some periods the scatter of measured values is rather high for a few transducers, especially at a period around 400 days. Some of this scatter is probably caused by outer disturbances. The problems have been overcome and good results are received after that period.
2. When the backfill is water saturated the transducers may give unreliable measurements, especially if free water has entered. This would explain the scatter in the late measurements of some transducers. The readings from sensors after the backfill has been saturated are not presented in the diagrams

In general the readings from the psychrometers have been logical. The sensors placed in the layer closest to the permeable mats and close to the rock were the first to indicate an increase in water ratio and saturation. After this water saturation was indicated by the sensors placed two layers from the saturating mats and finally, in the readings presented in this report, all sensors indicate saturation.

2.5 Resistivity, resistivity probe

Data are presented on pages 40-41.

The purpose of using resistivity probes is to measure change in water content and to indicate when the bentonite free backfill (0/100) is saturated. Seven of the nine probes were installed in the 0/100 and the other two were installed in section A6. The probes were not originally designed for the 30/70 backfill. It has not been possible to evaluate the readings from the two probes placed in this material and these data are not presented.

The effect of the stepwise increase in water pressure is registered as a decrease in resistivity, which indicates that the 0/100 backfill was not completely water saturated before the pressure increase. The curves seem to approach the resistivity 10-30 Ω m, which correspond to full saturation. This means that the 0/100 backfill is close to saturation in all the measuring points except perhaps one. W72, W73 and W 74 have failed.

2.6 Indication of saturation, CT tube

In the 0/100 backfill all CT tubes have carried water all the way to the measuring house and have been plugged. Water has also come through all of the tubes in the 30/70 backfill.

2.7 Pore water pressure in backfill, Glötzl

Data are presented on pages 42-45.

In the end of 2002 the data acquisition system once again broke down. It was decided that the readings will until further notice be made manually. U1 and U3 has been disconnected and plugged since they leaked water to the Data Acquisition System. The readings from U2 were not logical and it was suspected that it was leaking oil so it was disconnected and plugged. All of the remaining sensors but two, U15 and U17, deliver logical readings. Both U15 and U17 are placed close to the roof and indicate water pressures that are irregular and considerably higher than the pressure applied in the permeable sections. However the readings from both sensors seem to have stabilised at more realistic levels during the actual measuring period.

2.8 Pore water pressure in the backfill, Druck

Data are presented on pages 46 and 47.

The principle of this measurement is to lead water from the test volume to the measuring house in a tube, connect it to the Druck transducer and measure the pressure.

So far water has come through from measuring points U13, U 52,U5,U4 and U23 in the 30/70 backfill (no water in 3 out of 8 points) and through U53, U55,U58,U54,U57 and U56 in the 0/100 backfill (all points). There are also two measuring points among the blocks and pellets in section B6. No water has come through these. The readings from all of the 10 connected pore water pressure cells correspond quite well to the increase in saturating water pressure.

The pressure readings from the Druck transducers are related to the Z co-ordinate of the transducer in the measuring house. They are placed 0.5 – 1.5 m. below the centre point of the tunnel.

2.9 Water flow into permeable sections

Data are presented on page 48.

Water flow into the permeable sections is only measured by four flow meters, which means that several mats were connected to the same flow meter in different patterns during the first year. The flow data on page 36 is presented as flow to the different mats for the constellation after 340 days after which the same constellation has been used. Since there is flow out through the plug and there is also a free connection to the inner drained part of the drift, the measured flow does not tell anything about the water mass balance in the backfill at this stage.

2.10 Water pressure in permeable mats, Druck

Data are presented on pages 49 and 50.

The pressures in the permeable layers are measured in the tubes leading to the centre positions of the centre mats. The pressure is related to the Z coordinate of the Druck pressure transducers in the measuring house. This corresponds well with the Z coordinate of the centre line of the tunnel. Since the tunnel is slightly inclined the centre point is about 3 dm above the level of the Druck sensors in D1 and about 1 dm below the sensors in D10.

The measured pressure in the mats in the 0/100 backfill reflects very well the stepwise water pressure increase, while the response in two mats in the 30/70 backfill is lower than expected.

2.11 Water flow past the plug

Data are presented on page 51.

The water is collected in a sump outside the plug. Once a day the water is pumped from the sump through a flow meter and the volume and time is registered.

The measurement of water flow past the plug started 02-10-08 (day 860). At this time the water pressure behind the plug was 100 kPa. Each time the water pressure behind the plug was increased the flow past the plug increased substantially only to, in a short time, decrease to a level close to the one before the pressure increase. The flow past the plug was about 0.02 l/min when the pressure behind the plug was 100 kPa. When the pressure was raised to 500 kPa the flow past the plug increased to 0.05 l/min and has since decreased at a slow rate. The flow past the plug was about 0.02 l/min in June 2003.

2.12 Water flow from the inner part of the drift.

Data are presented on page 52.

The flow from the inner part is high, about 1 l/min. Compared to the flow injected in the permeable sections and the flow past the plug and it is irregular.

In order to keep the water pressure at a constant level one of the tubes leading water from the inner part of the drift is led higher up in the tunnel to an open vessel so that the difference in elevation together with the flow resistance in the pipe amounts to the desired water pressure (500 kPa). From the open vessel the water is led through a flow meter and the volume and time is registered.

2.13 Water flow into neighbouring drifts

The water flow into the neighbouring demonstration drift started 02-09-19 and is presented on page 53.

2.14 Water pressure in the rock, Druck

Data are presented on pages 55-69.

The pressure in the bore holes range from 0 to 3300 kPa. The highest pressures are found in the long boreholes. The pressure in the short bore holes in general range from 0 to 600 kPa. The exception is UR63 (left wall in section A1) that shows a pressure of 1600 kPa.

It is interesting to study the reaction of the water pressure increase in the mats on the measured pressure in the boreholes. All short boreholes in the floor yield immediate response and thus have a direct connection with the tunnel except for UR42, which is situated in the carefully blasted part (section 0). Most of the short boreholes in the roof and walls of the tunnel also yield a quick response to the pressure increase in the tunnel.

One sensor, UR168 is not delivering data.

3 Geometry

The backfilled part is divided into backfill sections separated by drainage layers of permeable mats. The backfill sections are named 0, A1-A6 and B2-B6 and the mats are named D1-D12 according to Fig 3-1.

ÄSPÖ HARD ROCK LABORATORY- BACKFILL AND PLUG TEST IN ZEDEX DRIFT

Layout of the test
Numbering of backfill sections and permeable mats

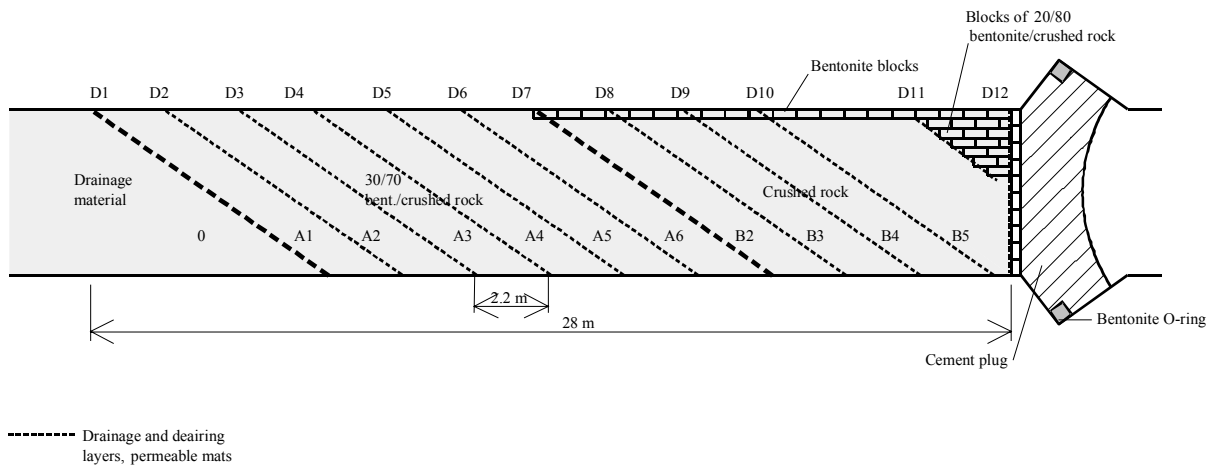

Figure 3-1 Numbering of backfill sections and drainage layers (permeable mats).

The permeable mats have been placed according to Fig 2-2. If the tunnel is supposed to be cylindrical the sections are elliptical with the large axis 8.7 m and the small axis 5.0 m. The tunnel axis is made the centre of a co-ordinate system with x and y co-ordinates. The drainage layer is divided into 3 parts with one upper, one central and one lower filter.

- The upper filter starts at $y=3.3$ m and fills the tunnel above that level. At the contact with the rock 0.2 m of filter mat is folded and attached to the rock surface in order to have a good hydraulic interaction with the rock.
- The central filter is placed at $-2.5 < y < 3.0$ and $-2.2 < x < 2.2$ as shown in Fig 3-2. The central filters have at least 0.3 m distance to the walls otherwise it has been cut to fulfil that demand.
- The lower filter has been placed between $y=-2.8$ and the floor with 0.2 m folded and attached to the floor. Since the floor is horizontal the ellipse is cut at about $y = -3.85$.

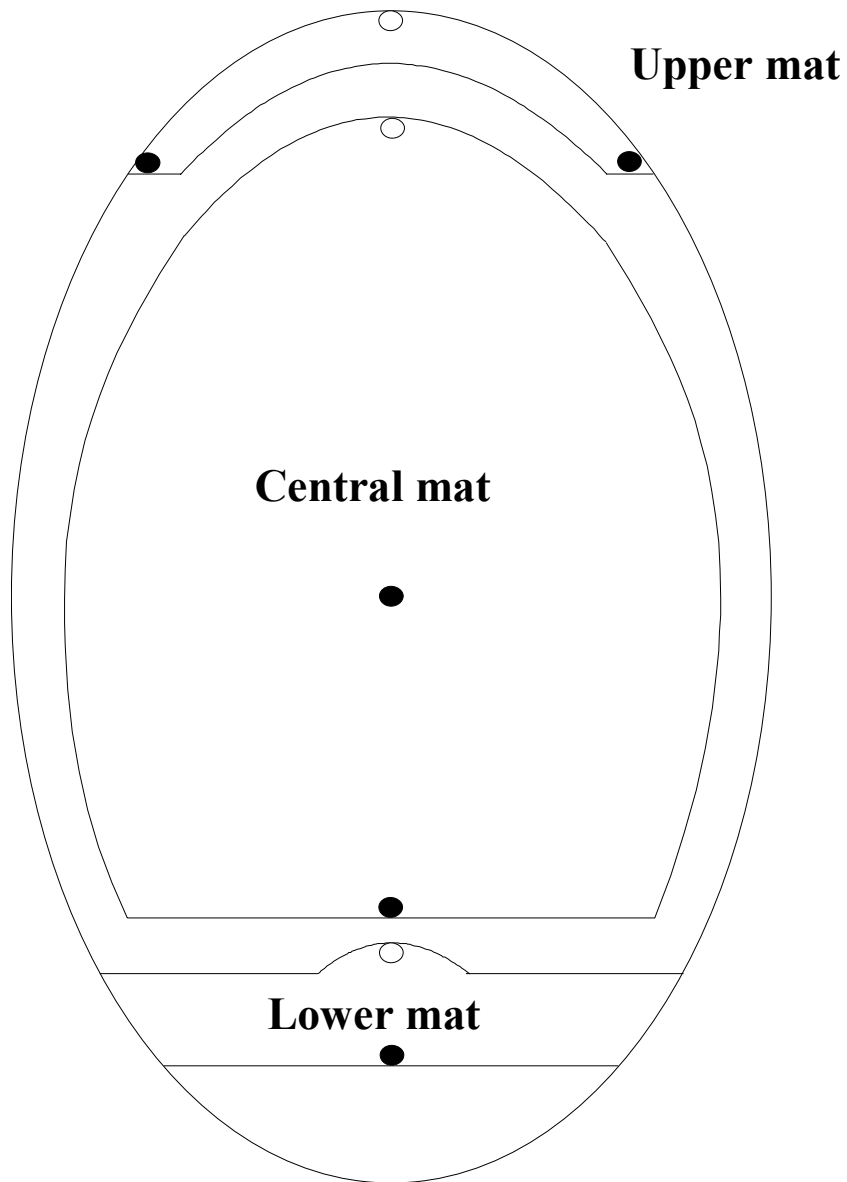

Figure 3-2. Location of the filters in a drainage layer.

Drainage layer D01 and D11 does not reach the floor. The central filter is cut 0.3 m from filter D12. Drainage layer D12 is made as the circular projection of the other drainage layers.

4 Location of instruments in the backfill

4.1 Brief description of the instruments

The different instruments that are used for measurements in the backfill are briefly described in this chapter.

4.1.1 Measurement of total pressure in the backfill

Total pressure is the sum of the swelling pressure (or effective stress) and the pore water pressure. It is measured with the following two instrument types:

- Glötzl total pressure cells of the hydraulic type. Two models have been used: E 10/20 KF 50 VA24 model A (Glötzl A) and model F (Glötzl B). The measuring range is 0-5 MPa. Type A is used for measurement in the soil while type B will be fixed to the rock surface with concrete. 9 cells of type A and 4 cells of type B are installed.
- Roctest total pressure cell with vibrating wire transducer model TPC-0 (0-4 MPa). 8 cells of this type are installed in the backfill.

4.1.2 Measurement of pore water pressure in the backfill

The pore water pressure in the backfill is measured with the following two instrument types:

- Glötzl pore pressure cells of the hydraulic type. 18 pore pressure cells of model P4 S 50L VA with the measuring range 0-5 MPa are installed.
- Filter tips connected to Druck pore water pressure cells model PTX 1400 with tecalan tubes. The pore water pressure cells are located outside the test area. 16 devices with the measuring range 0-4 MPa are installed.

4.1.3 Measurement of the water saturation process in the backfill

The water saturation process is followed by the following three different techniques:

- Wescor psychrometers model PST-55. These devices measure the relative humidity in the pore system, which can be converted into water ratio or total suction (negative water pressure). The measuring range is 95.5-99.6 RH corresponding to the pore water pressure -0.5 to -6 MPa or the water ratio 11-25% of backfill with the composition 30/70 bentonite/ballast mixture. 27 psychrometers have been installed.
- Resistivity probes developed and built by Clay Technology and the University of Lund are used in the bentonite free backfill. The measuring principle is to apply an electrical current between two outer electrodes with the relative distance 30 cm and measure the drop in potential between two inner electrodes with the relative distance 10 cm. The devices have been calibrated for different densities and water ratios of the backfill intended to be used. The measuring range is water ratios between 5 and 12%. 10 devices are installed.

- Filter tips connected to thin tecalan tubes. These filters, which mainly have been installed in the bentonite free backfill, are simple devices for indicating when water saturation has occurred in the measuring point.

4.1.4 Measurement of temperature

Since no heat is generated in the experiment, temperature can be measured in two points for the purpose of general information. Thermocouples of type K from Heraeus Electro-Nite AB have been used. Temperature can also be measured by the psychrometers and by the devices for measuring hydraulic conductivity installed by Aitemin (ENRESA).

4.1.5 Other measurements

After water saturation local hydraulic conductivity will be measured in section A4 with devices developed and installed by Aitemin in 13 points. The sensors also register the pore water pressure.

4.2 Strategy for describing the position of each device

Each instrument is named with a short unique name consisting of 1-2 letters describing the type of measurement and 1-3 figures numbering the device. In addition to the name a short description of the position is added.

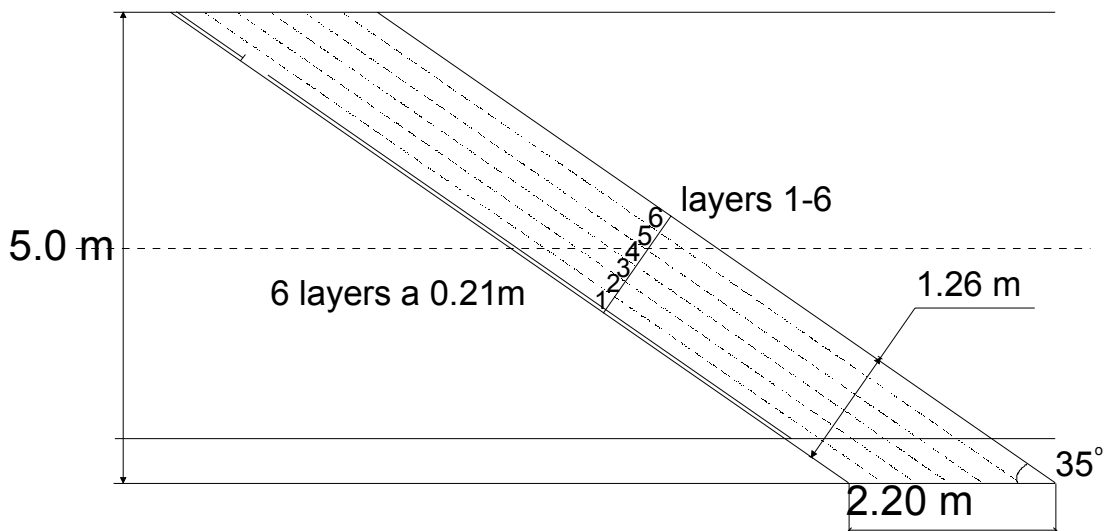

Figure 4-1. Subdivision of a backfill section into backfill layers.

The sections, separated by drainage layers, were shown in Fig 1-1. Sections A1-A6 and B2-B4 are divided into 6 layers with the thickness 0.21 m according to Fig 4-1. Each layer corresponds to one compaction sequence, which means that the backfill will be placed with a thickness before compaction that yields a thickness after compaction of 0.21 m. The layers are numbered 1-6.

The instruments have been placed in the layers after compaction and are related to those layers. Each measuring point is also defined by the co-ordinates in the layer in a co-ordinate system equal to the one shown in Fig 4-2. The x -coordinate is the horizontal distance from the centre of the tunnel and the y -coordinate is the distance perpendicular to the x -axis. Some of the instruments are more important to place at a specified distance from the rock surface. For those cases the co-ordinate begins with the letter R and is given the co-ordinate with the intersection with the rock surface as centre. An instrument in the backfill will thus be named in the following way:

1. Type of measurement (1 letter)
2. Serial number (1-2 figures)
3. Section (1 letter, 1 figure)
4. Layer (1 figure)
5. x -coordinate
6. y -coordinate

Items 1 and 2 identifies the device and items 3-6 describes the location. A pore water pressure transducer (number 8) located in section A2, layer 3, 0.5 m left of the centre line and 0.3 m below the roof in the y -direction will be named:

W8 (A2/3/-0.5/R-0.3)

Instrument locations

Sections A & B

Layers 1-6

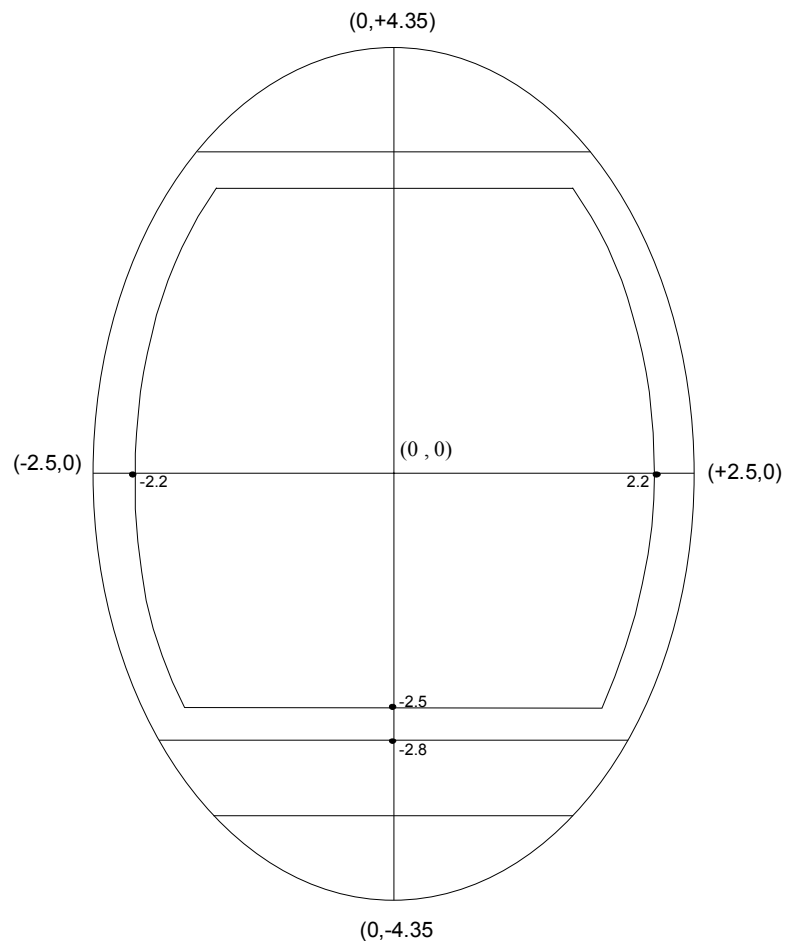

Figure 4-2. Co-ordinate system for measuring point in each sections and layers

4.3 Position of each instrument in the backfill

All instruments are placed in layers 1-4 in order to leave the two upper layers unaffected by transducers and cables. Another reason is that the entrance plate where the tubes are attached to the through connections are placed in layers 1-4, which means that the two final layers could be compacted without considering the problems of compacting around the through connections.

The positions of the instruments (the positions of ENRESA's hydraulic conductivity devices are shown on page 64) are described in Tables 4-1 to 4-4.

Table 4-1 Numbering and position of instruments for measuring total pressure

| Type and number | Section | Layer | X | Y | Fabricate | Remarks |
|-----------------|---------|-------|---|--------|-----------|----------------|
| P1 | A3 | 1 | 0 | R+0.2 | Glötlz A | Horisontal |
| P2 | A1 | 5 | 0 | R-1.1 | Glötlz A | Parallel |
| P3 | A2 | 3 | 0 | 0,6 | Rocktest | Parallel |
| P4 | A2 | 3 | 0 | R+0.65 | Rocktest | Parallel |
| P5 | A2 | 1 | 0 | R-0.2 | Rocktest | Parallel |
| P6 | A2 | 6 | 0 | -3,15 | Glötlz A | Horisontal |
| P7 | A4 | 3 | 0 | R-0 | Glötlz B | At rock |
| P8 | A4 | 3 | 0 | R+0 | Glötlz B | At rock |
| P9 | A5 | 3 | 0 | R-0.2 | GlötlzA | At rock |
| P51 | A6 | 3 | 0 | R-0.3 | Rocktest | Under blocks |
| P52 | B2 | 3 | 0 | R-0 | Glötlz A | Under blocks |
| P53 | B2 | 3 | 0 | 0,2 | Glötlz B | Horisontal |
| P54 | B2 | 6 | 0 | -2,78 | Rocktest | Horisontal |
| P55 | B3 | 3 | 0 | 0,3 | Glötlz A | Parallel |
| P56 | B3 | 3 | 0 | R+0.65 | Glötlz A | Parallel |
| P57 | B2 | 7 | 0 | R+1.1 | Rocktest | Parallel |
| P58 | B4 | 3 | 0 | R-0 | Glötlz A | Under blocks |
| P59 | B3 | 5 | 0 | R-1.1 | Glötlz A | Parallel |
| P60 | B4 | 1 | 0 | R-0.2 | Rocktest | Parallel |
| P61 | B6 | 10 | 0 | R-0 | Rocktest | Between blocks |
| P62 | B6 | 10 | 0 | P | Glötlz B | At wall |

Table 4-2 Numbering and position of instruments for measuring pore water pressure (U)

| Type and number | Section | Layer | X | Y | Fabricate | Remarks |
|-----------------|---------|-------|-------|--------|-----------------|------------------|
| U1 | A1 | 3 | 0 | 0,3 | Glötzi | |
| U2 | A1 | 3 | 0 | 3,1 | Glötzi | |
| U3 | A1 | 3 | 0 | -2,6 | Glötzi | |
| U4 | A1 | 3 | 2 | 0 | CT Tube + Druck | Twin tubes |
| U5 | A1 | 3 | -2 | 0 | CT Tube + Druck | Twin tubes |
| U6 | A2 | 1 | 0 | 0,3 | Glötzi | |
| U7 | A2 | 6 | 0,2 | 3,15 | Glötzi | |
| U8 | A3 | 1 | 0,25 | -2,8 | Glötzi | |
| U9 | A1 | 5 | -0,2 | R-1.1 | Glötzi | |
| U10 | A2 | 3 | 0 | 0,3 | Glötzi | |
| U11 | A2 | 3 | -0,2 | R+0.65 | Glötzi | |
| U12 | A2 | 3 | 1,3 | 0 | CT Tube + Druck | |
| U13 | A2 | 3 | -1,3 | 0 | CT Tube + Druck | |
| U14 | A2 | 6 | -0,15 | -0,1 | Glötzi | |
| U15 | A2 | 1 | -0,2 | R-0.2 | Glötzi | |
| U16 | A4 | 3 | 0 | 0,3 | Glötzi | |
| U17 | A4 | 3 | 0 | R-0 | Glötzi | |
| U18 | A4 | 3 | 0 | R+0 | Glötzi | |
| U19 | A4 | 3 | R-0 | 0 | Glötzi | |
| U20 | A4 | 3 | R+0 | 0 | Glötzi | |
| U21 | A5 | 3 | 0 | 0,3 | Glötzi | |
| U22 | A5 | 3 | 1,3 | 0 | CT Tube + Druck | Twin tubes |
| U23 | A5 | 3 | -1,3 | 0 | CT Tube + Druck | Twin Tubes |
| U24 | A5 | 3 | -0,2 | R-0.2 | Glötzi | |
| U51 | A6 | 3 | -0,2 | R-0.3 | CT Tube + Druck | Under the Blocks |
| U52 | A6 | 3 | -0,2 | -2 | CT Tube + Druck | Twin Tubes |
| U53 | B3 | 1-2 | 0 | R+0.05 | CT Tube + Druck | |
| U54 | B2 | 5 | -0,2 | R+0.2 | CT Tube + Druck | marked as w66 |
| U55 | B2 | 6 | -0,2 | R+0.65 | CT Tube + Druck | marked as w63 |
| U56 | B4 | 3 | 0 | R-0 | CT Tube + Druck | |
| U57 | B3 | 5 | -0,2 | R-1.1 | CT Tube + Druck | |
| U58 | B4 | 1 | -0,2 | R-0.2 | CT Tube + Druck | |
| U59 | B6 | 10 | 0 | R-0.05 | CT Tube + Druck | |
| U60 | B6 | 10 | 0 | R-C-C | CT Tube + Druck | Twin Tubes |

Table 4-3 Numbering and position of instruments for measuring water content (W)

| Type and number | Section | Layer | X (m) | Y (m) | Fabricate | Remarks |
|-----------------|---------|-------|-------|-------|---------------------|------------------|
| W1 | A1 | 1 | 0 | 0 | Wescor Psychrometer | |
| W2 | A1 | 3 | 0 | 0 | Wescor Psychrometer | |
| W3 | A1 | 5 | 0 | 0 | Wescor Psychrometer | |
| W4 | A2 | 1 | 0 | 0 | Wescor Psychrometer | |
| W5 | A2 | 3 | 0 | 0 | Wescor Psychrometer | |
| W6 | A2 | 4 | 0 | 0 | Wescor Psychrometer | |
| W7 | A3 | 1 | 0 | 0 | Wescor Psychrometer | |
| W8 | A3 | 3 | 0 | 0 | Wescor Psychrometer | |
| W9 | A3 | 3 | 0 | 2,5 | CT Tube | |
| W10 | A3 | 3 | 0 | R-0.5 | Wescor Psychrometer | |
| W11 | A3 | 3 | 0 | -2 | CT Tube | |
| W12 | A3 | 3 | 0 | R+0.5 | Wescor Psychrometer | |
| W13 | A3 | 3 | 1,2 | 0 | CT Tube | |
| W14 | A3 | 3 | R-0.3 | 0 | Wescor Psychrometer | |
| W15 | A3 | 3 | -1,2 | 0 | CT Tube | |
| W16 | A3 | 3 | R+0.3 | 0 | Wescor Psychrometer | |
| W17 | A3 | 4 | 0 | 0 | Wescor Psychrometer | |
| W18 | A4 | 1 | 0 | 0 | Wescor Psychrometer | |
| W19 | A4 | 3 | 0 | 0 | Wescor Psychrometer | |
| W20 | A4 | 4 | 0 | 0 | Wescor Psychrometer | |
| W21 | A5 | 1 | 0 | 0 | Wescor Psychrometer | |
| W22 | A5 | 3 | 0 | 0 | Wescor Psychrometer | |
| W23 | A5 | 3 | 0 | 2.5 | Wescor Psychrometer | |
| W24 | A5 | 3 | 0 | -2 | Wescor Psychrometer | |
| W25 | A5 | 4 | 0 | 0 | Wescor Psychrometer | |
| W51 | A6 | 1 | 0 | 0 | Wescor Psychrometer | |
| W52 | A6 | 3 | 0 | 0 | CT Res. Probe | |
| W53 | A6 | 3 | 0 | R-0.4 | Ct Tube | |
| W54 | A6 | 3 | 0 | -2 | Ct Tube | |
| W55 | A6 | 3 | -1,3 | 0 | Ct Tube | |
| W56 | A6 | 3 | 1,3 | 0 | Ct Tube | |
| W57 | A6 | 4 | 0 | 0 | CT Res. Probe | |
| W58 | B2 | 1 | 0 | 0 | CT Res. Probe | |
| W59 | B2 | 3 | 0 | 0 | CT Res. Probe | |
| W60 | B2 | 3 | 0 | 2,5 | Ct Tube | |
| W61 | B2 | 3 | 0 | R-0.3 | Ct Tube | Under the Blocks |
| W62 | B2 | 3 | 0 | -2 | Ct Tube | |
| W64 | B2 | 3 | -1,3 | 0 | Ct Tube | |
| W65 | B2 | 3 | 1,3 | 0 | Ct Tube | |
| W67 | B3 | 1 | 0 | 0 | Wescor Psychrometer | |
| W68 | B3 | 3 | 0 | 0 | CT Res. Probe | |
| W69 | B3 | 3 | 0 | R-0.3 | CT Tube | Under the Blocks |
| W70 | B3 | 3 | 1,3 | 0 | CT Tube | |
| W71 | B3 | 3 | -1,3 | 0 | CT Tube | |
| W72 | B3 | 4 | 0 | 0 | CT Res. Probe | |

| | | | | | | |
|-----|----|----|------|-------|---------------------|--|
| W73 | B4 | 1 | 0 | 0 | CT Res. Probe | |
| W74 | B4 | 3 | 0 | 0 | CT Res. Probe | |
| W75 | B4 | 3 | 1,3 | 0 | CT Tube | |
| W76 | B4 | 3 | -1,3 | 0 | CT Tube | |
| W77 | B5 | 2 | 0 | 0 | Wescor Psychrometer | |
| W78 | B5 | 5 | 0 | 0 | CT Res. Probe | |
| W79 | B5 | 8 | 0 | 2 | CT Res. Probe | |
| W80 | B5 | 8 | 2 | 2 | Ct Tube | |
| W81 | B5 | 8 | -2 | 2 | Ct Tube | |
| W82 | B5 | 11 | 0 | 2 | Ct Tube | |
| W83 | B6 | 5 | 0 | R-C-C | Wescor Psychrometer | |
| W84 | B6 | 15 | 0 | R-C-C | Wescor Psychrometer | |

5 Location of instruments in the rock

5.1 Brief description of the instruments and the packers

Only water pressure is measured in the rock. The measurements are made in core-drilled boreholes sealed with bentonite packers with the following measuring technique:

Tecalan tubes from the packer are connected to Druck pore water pressure cells model PTX 1400. The pore water pressure cells are located in the measuring house. Measurements are made in 79 borehole sections (measuring range 0-4 MPa).

Measurements are made in 1-3 sections in the boreholes. Most of the holes are only 1 m long with 1 packer installed in the outer 0.5 m. Two tubes are lead into each measuring section for de-airing purpose. The measuring sections are sealed with packers with bentonite rings surrounded by rubber sealings.

5.2 Position of each measuring section

The measuring sections are identified with two letters and 2-3 figures. The letters are U (for pore water pressure) and R (for rock). The numbers are given in the following way:

Short holes in roof: 1-12

Long holes in the roof: 101-107

Short holes in the right wall (seen from the entrance of the drift): 21-32

Long holes in the right wall: 121-129

Short holes in floor: 41-52

Long holes in the floor: 141-147

Short holes in left wall: 61-72

Long holes in the roof: 161-167

Long hole in the end of the drift: 121

Table 5-1 shows the location of the measuring section for each instrument and the corresponding bore hole number. The backfill section in where the bore hole starts is also given

Figs 5-1 and 5-2 show the location of the measuring sections in vertical and horizontal cross

sections.

Table 5-1 Numbering and positions of instruments for measuring pore water pressure in the rock

| Type and number | Location | Measuring sect. (m) | Bore hole number | Section (TC) | Fabricate | Diameter (mm) | Remarks |
|-----------------|------------|------------------------|------------------|-----------------|-----------|------------------|----------|
| UR1 | Roof | 0.5-1.0 | KZ0065I01 | A1 | Druck | 56 | |
| UR2 | Roof | 0.5-1.0 | KZ0063I01 | A2 | Druck | 56 | |
| UR3 | Roof | 0.5-1.0 | KZ0061I01 | A3 | Druck | 56 | Closed ? |
| UR4 | Floor | 0.5-1.0 | KZ0052G01 | A4 | Druck | 56 | |
| UR5 | Roof | 0.5-1.0 | KZ0057I01 | A5 | Druck | 56 | |
| UR6 | Roof | 0.5-1.0 | KZ0054I01 | B1 | Druck | 56 | |
| UR7 | Roof | 0.5-1.0 | KZ0052I01 | B2 | Druck | 56 | |
| UR8 | Roof | 0.5-1.0 | KZ0050I01 | B3 | Druck | 56 | |
| UR9 | Roof | 0.5-1.0 | KZ0048I01 | B4 | Druck | 56 | |
| UR10 | Roof | 0.5-1.0 | KZ0046I01 | B5 | Druck | 56 | |
| UR11 | Roof | 0.5-1.0 | KZ0043I01 | B5 | Druck | 56 | |
| UR12 | Roof | 0.5-1.0 | KZ0041I01 | B5 | Druck | 56 | |
| | | | | | | | |
| UR21 | Right wall | 0.5-1.0 | KZ0066B01 | O | Druck | 56 | |
| UR22 | Right wall | 0.5-1.0 | KZ0064B01 | O | Druck | 56 | |
| UR23 | Right wall | 0.5-1.0 | KZ0061B01 | A1 | Druck | 56 | |
| UR24 | Floor | 0.5-1.0 | KZ0057B01 | A2 | Druck | 56 | |
| UR25 | Right wall | 0.5-1.0 | KZ0057B01 | A3 | Druck | 56 | |
| UR26 | Right wall | 0.5-1.0 | KZ0055B01 | A4 | Druck | 56 | |
| UR27 | Right wall | 0.5-1.0 | KZ0053B01 | A5 | Druck | 56 | |
| UR28 | Right wall | 0.5-1.0 | KZ0050B01 | B1 | Druck | 56 | |
| UR29 | Right wall | 0.5-1.0 | KZ0048B01 | B2 | Druck | 56 | |
| UR30 | Right wall | 0.5-1.0 | KZ0046B01 | B3 | Druck | 56 | |
| UR31 | Right wall | 0.5-1.0 | KZ0044B01 | B4 | Druck | 56 | |
| UR32 | Right wall | 0.5-1.0 | KZ0042B01 | B5 | Druck | 56 | |
| | | | | | | | |
| UR41 | Floor | 0.5-1.0 | KZ0065G01 | O | Druck | 56 | |
| UR42 | Floor | 0.5-1.0 | KZ0063G01 | O | Druck | 56 | |
| UR43 | Floor | 0.5-1.0 | KZ0061G01 | O | Druck | 56 | |
| UR44 | Floor | 0.5-1.0 | KZ0059G01 | A1 | Druck | 56 | |
| UR45 | Right wall | 0.5-1.0 | KZ0059G01 | A2 | Druck | 56 | One tube |
| UR46 | Floor | 0.5-1.0 | KZ0054G01 | A3 | Druck | 56 | plugged |
| UR47 | Roof | 0.5-1.0 | KZ0059I01 | A4 | Druck | 56 | |
| UR48 | Floor | 0.5-1.0 | KZ0050G01 | A5 | Druck | 56 | |
| UR49 | Floor | 0.5-1.0 | KZ0048G01 | B1 | Druck | 56 | |
| UR50 | Floor | 0.5-1.0 | KZ0046G01 | B2 | Druck | 56 | |
| UR51 | Floor | 0.5-1.0 | KZ0043G01 | B3 | Druck | 56 | |
| UR52 | Floor | 0.5-1.0 | KZ0041G01 | B4 | Druck | 56 | |

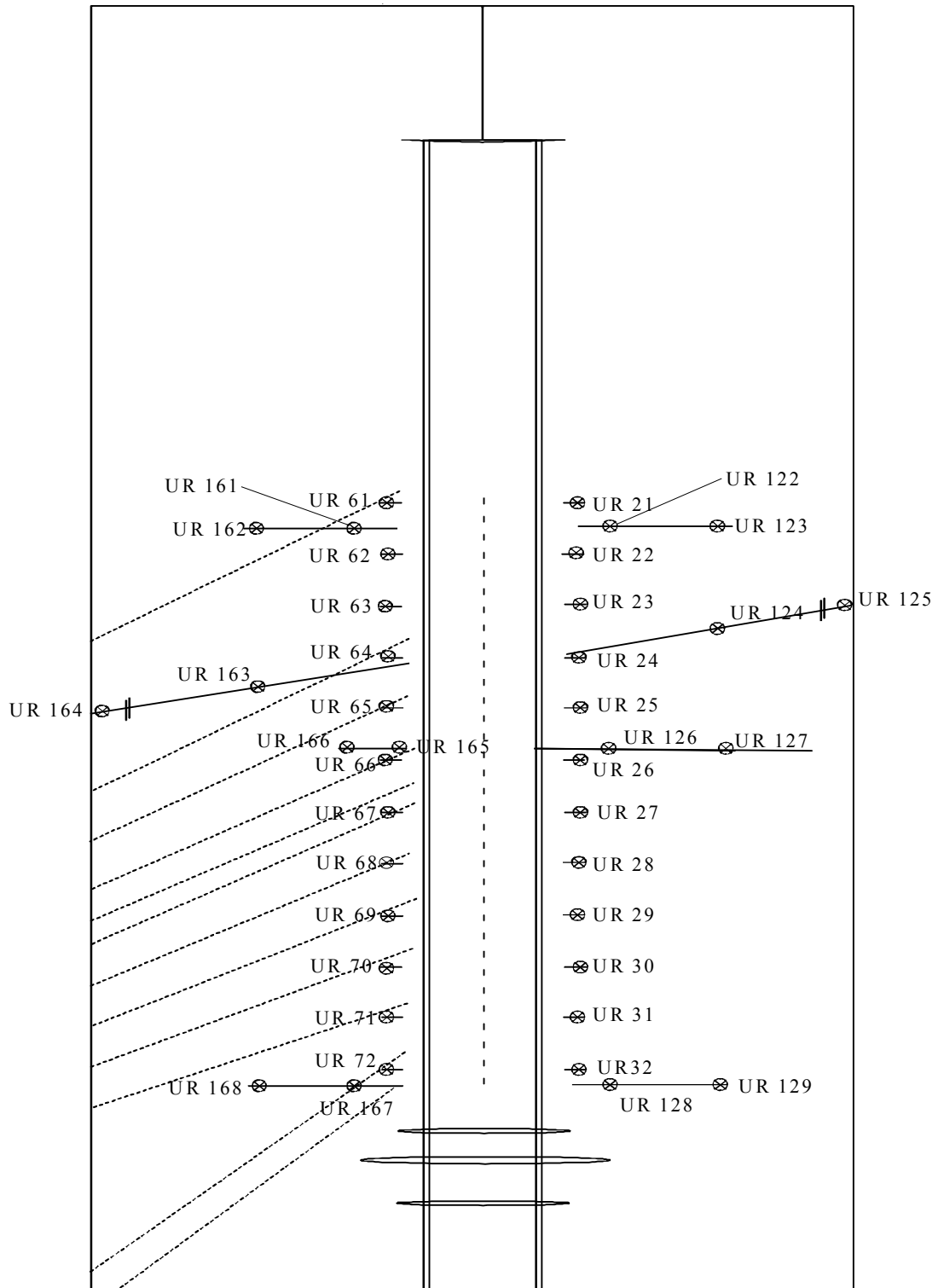
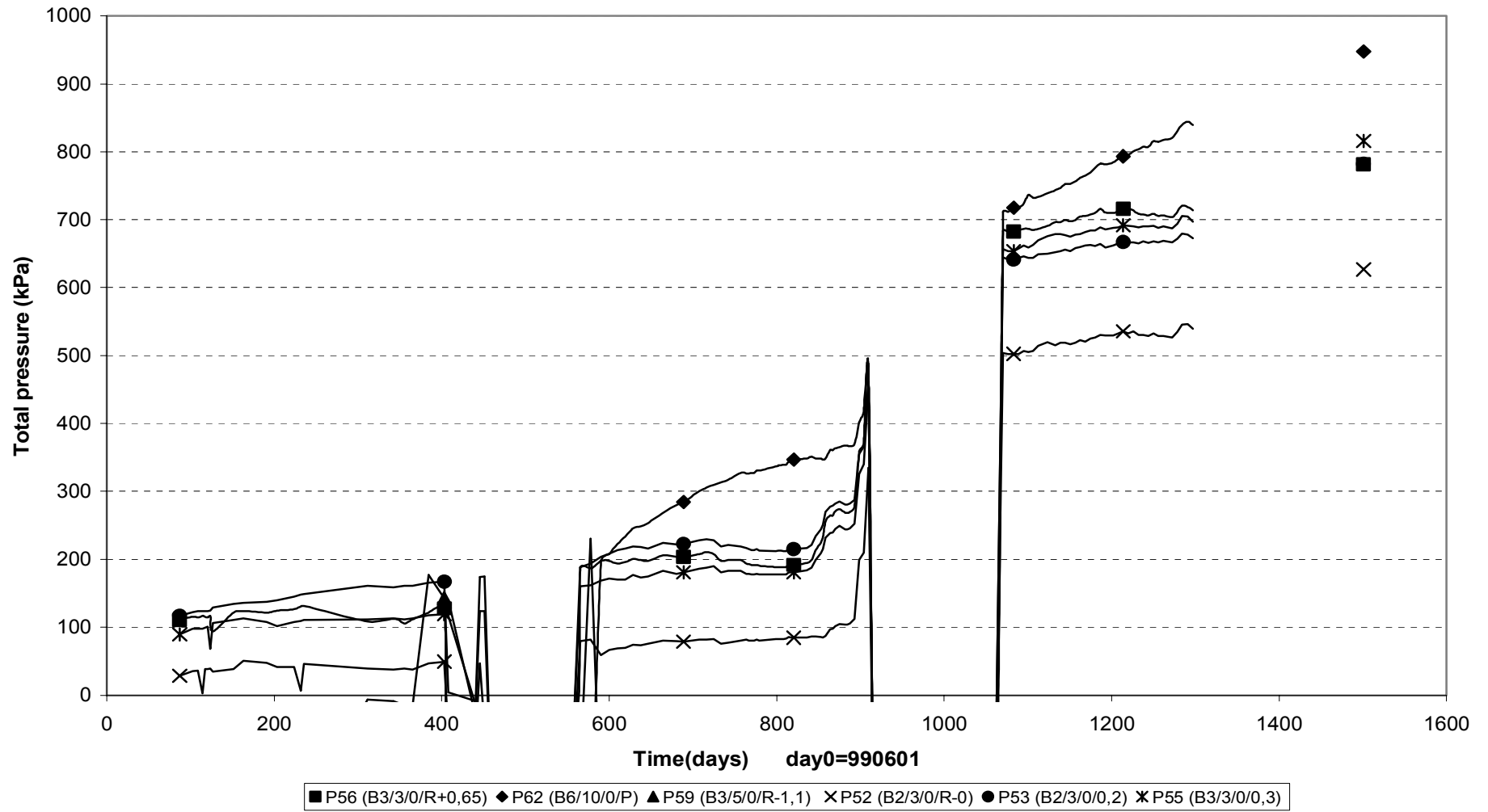

Figure 5-2 Position of measuring points in the boreholes of the rock in the walls.
Horizontal section

6 Data from measurements

**Total pressure sections B2-B6 (990601-030701)
GLÖTZL**



**Total pressure sections A1-A5 (990601-030701)
GLÖTZL**

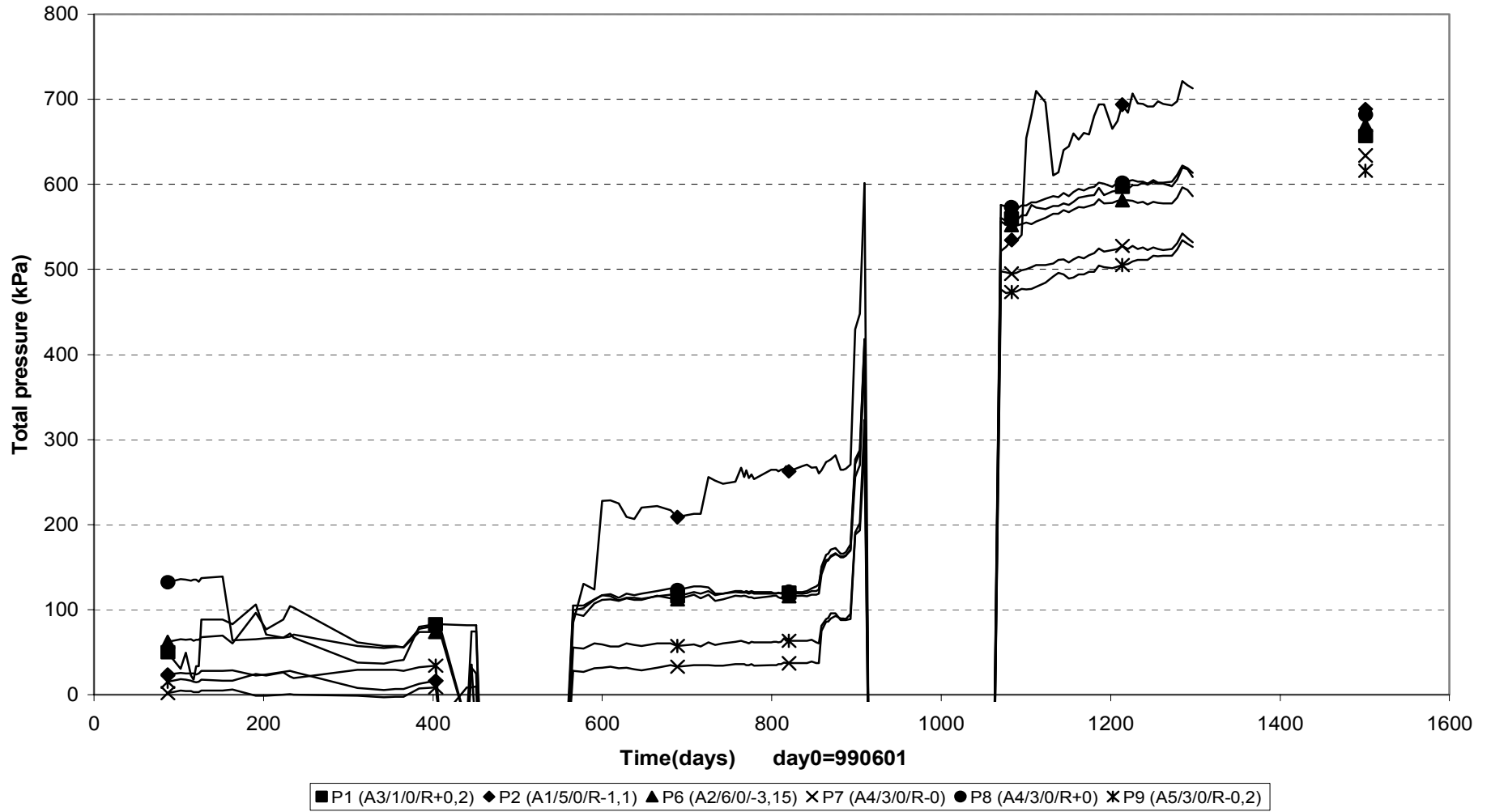

**Total pressure (990601-030701)
Rocktest**

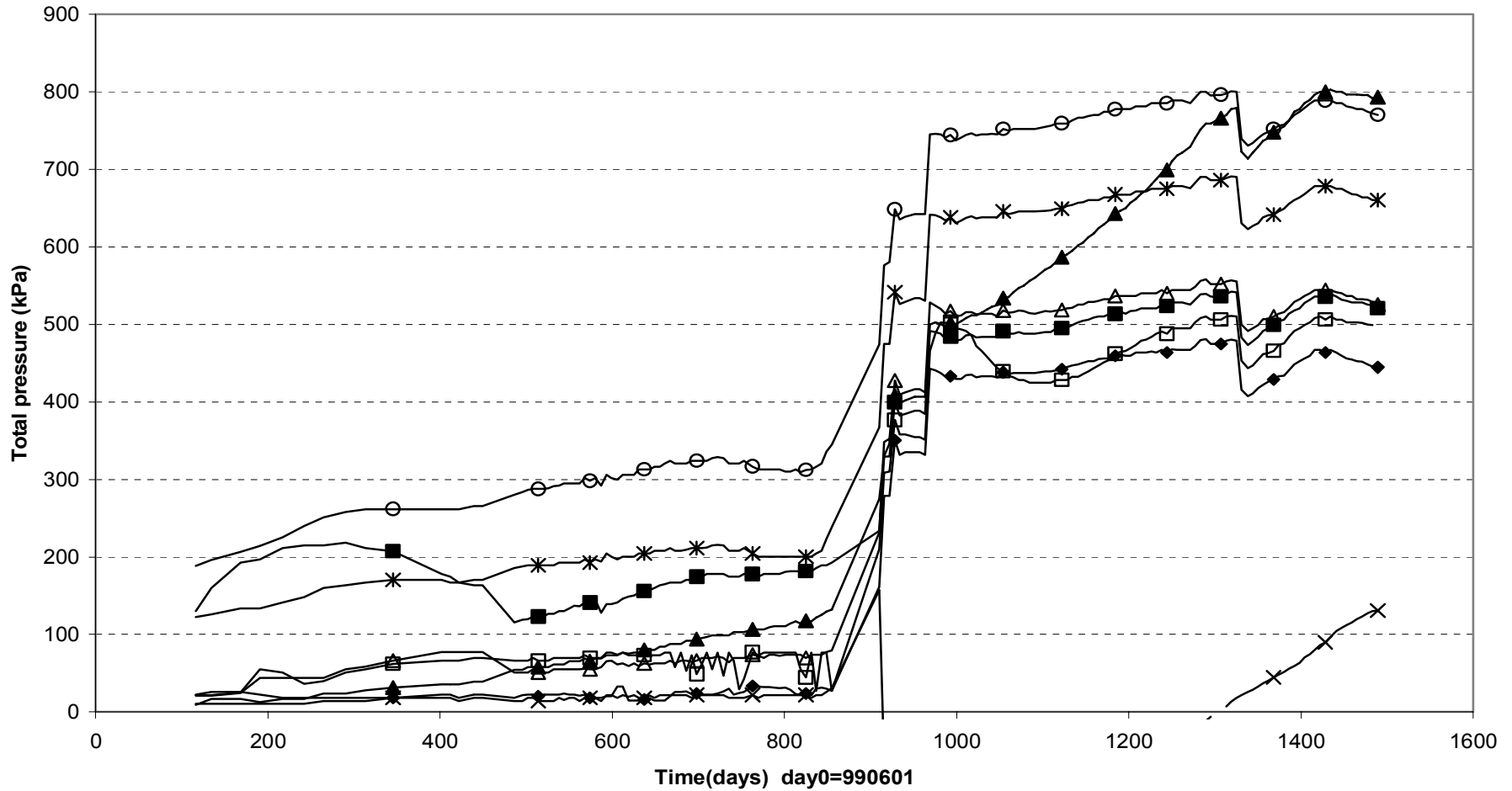

| | | | | |
|----------------------|----------------------|---------------------|----------------------|-----------------------|
| □ P3 (A2/3/0/0,6) | △ P4 (A3/3/0/R+0,65) | ◆ P5 (A2/1/0/R-0,2) | × P51 (A6/3/0/R-0,3) | * P54 (B2/6/0/ -2,78) |
| ○ P57 (B2/7/0/R+1,1) | ■ P60 (B4/10/R-0,2) | ▲ P61 (B6/10/0/R-0) | | |

Suction in backfill sections A1&A2 (990601-030701)
WESCOR

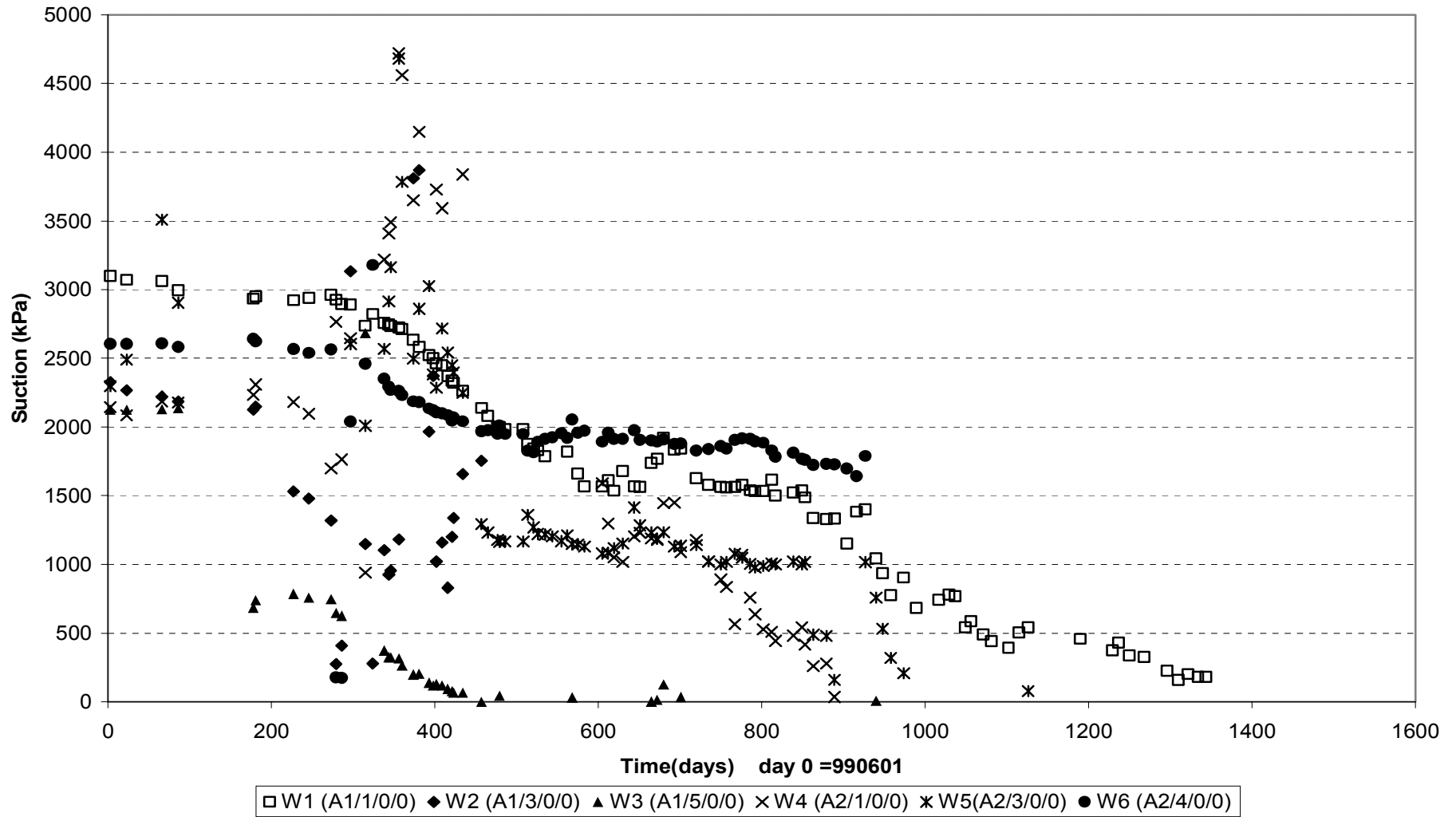

Suction in backfill section A3 (990601-030701)
WESCOR

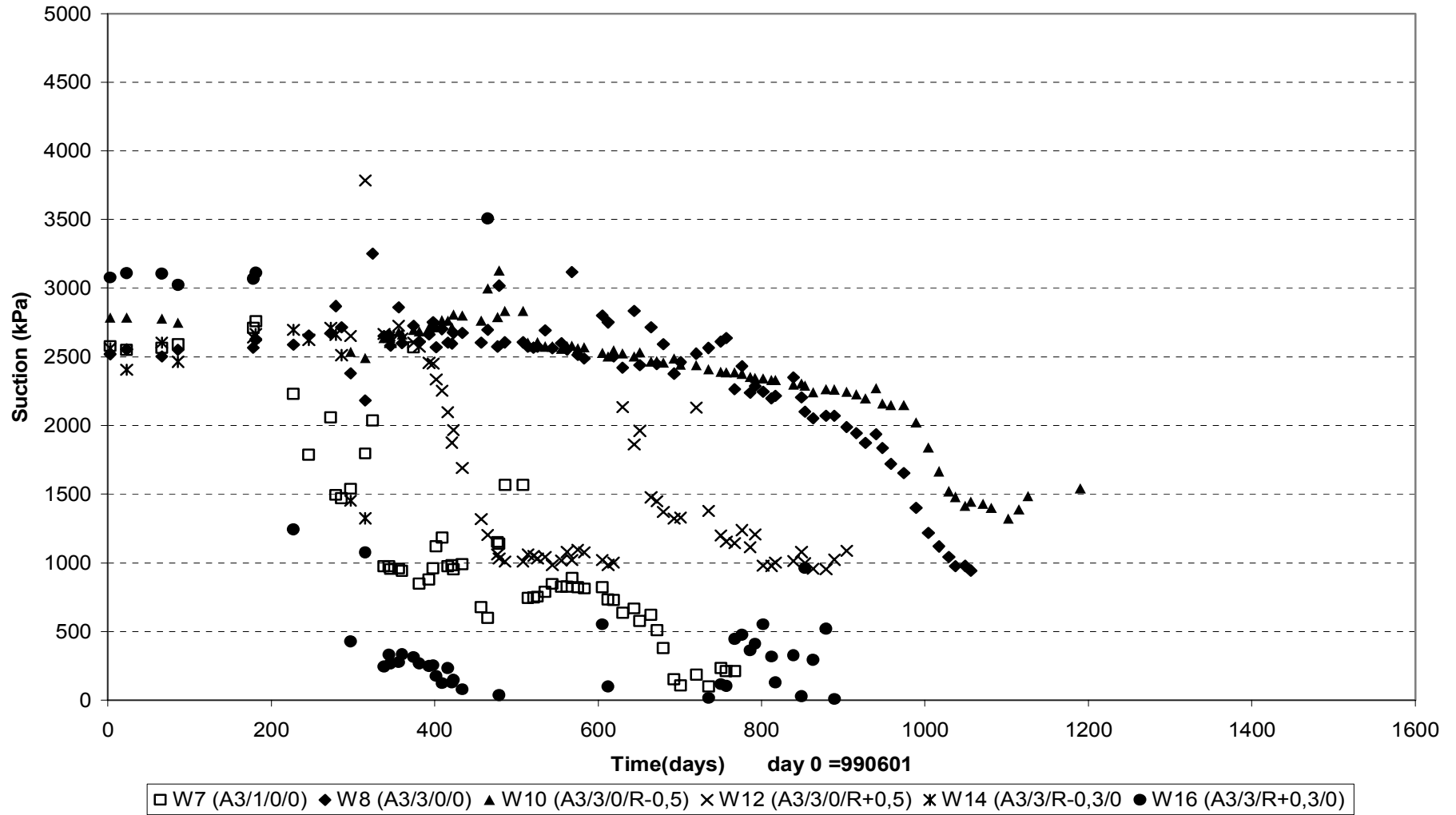

Suction in backfill sections A4&A5 (990601-030701)
WESCOR

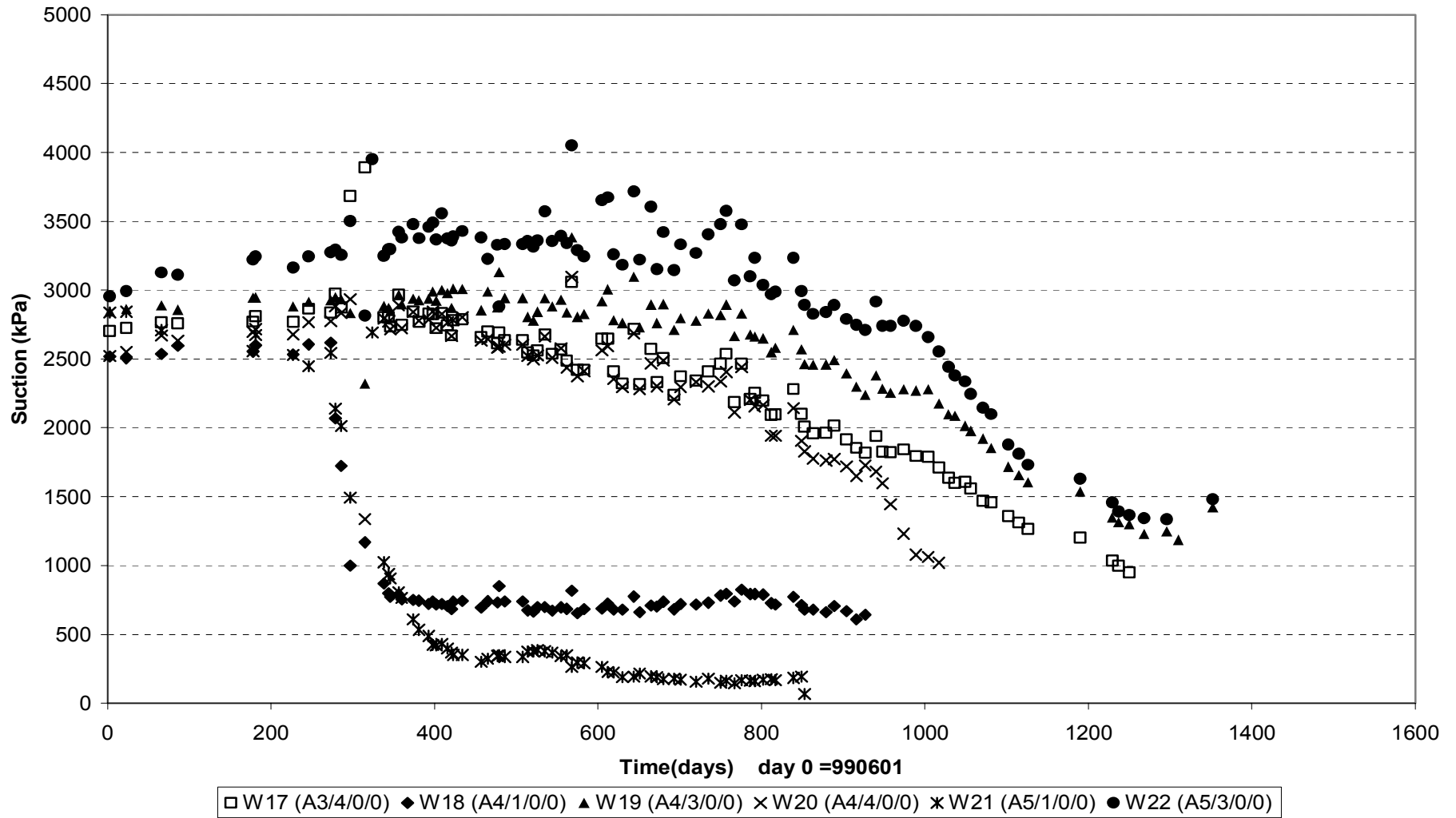

Suction in backfill sections A5&A6 (990601-030701)
WESCOR

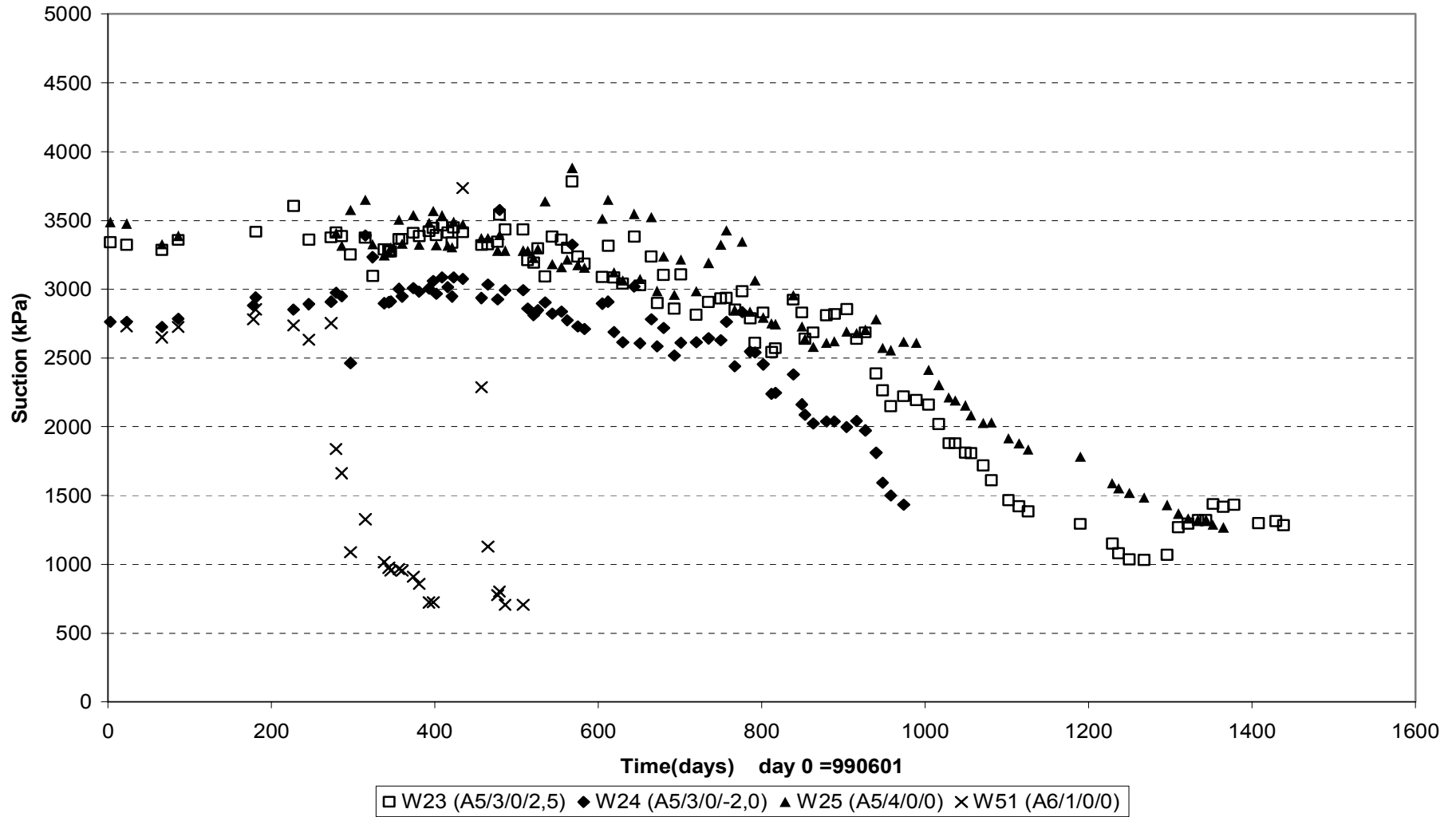

Resistivity in backfill sections B3, B4&B5 (990601-030701)
LTH-probe

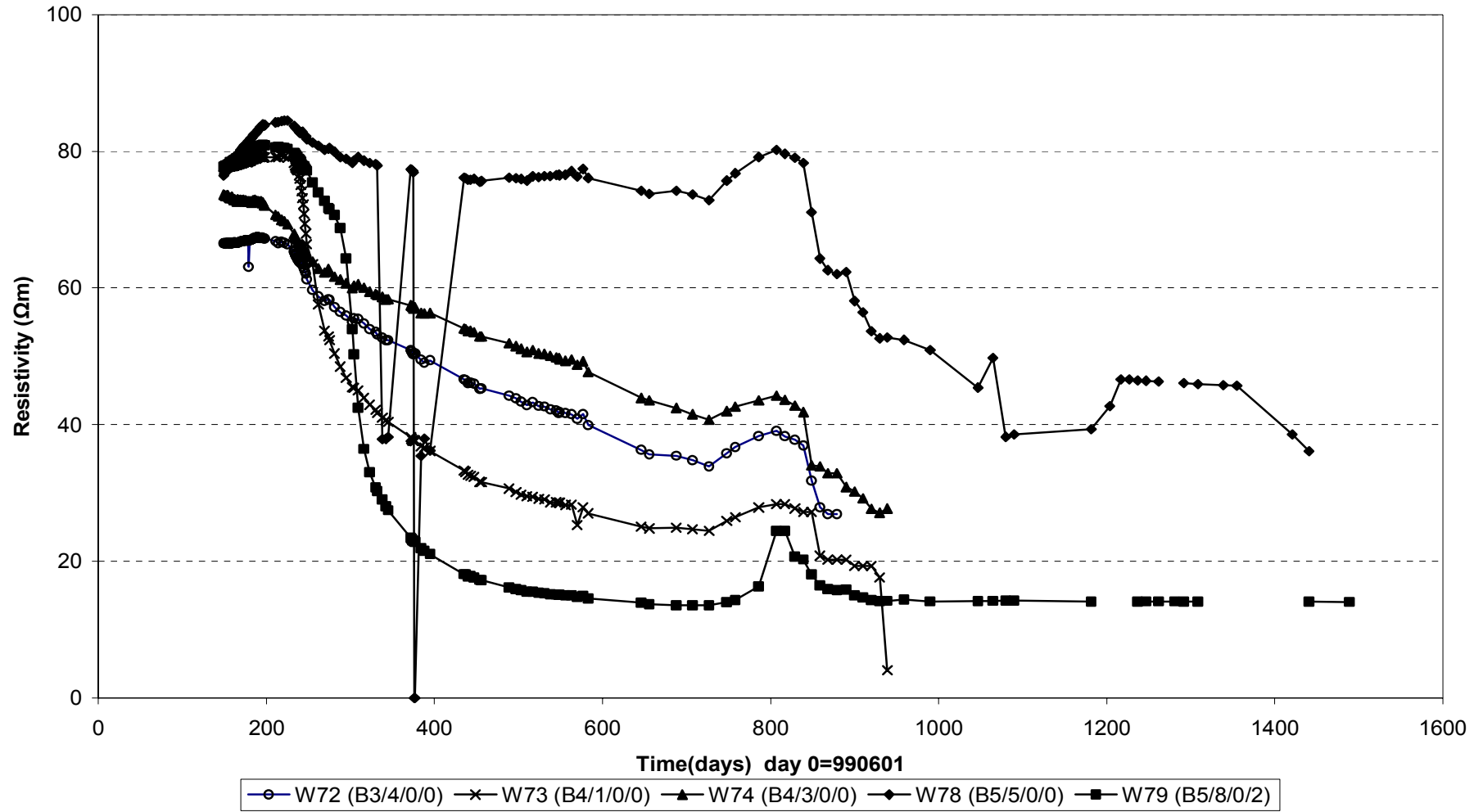

Resistivity in backfill sections B2,B3 (990601-030701)
LTH-probe

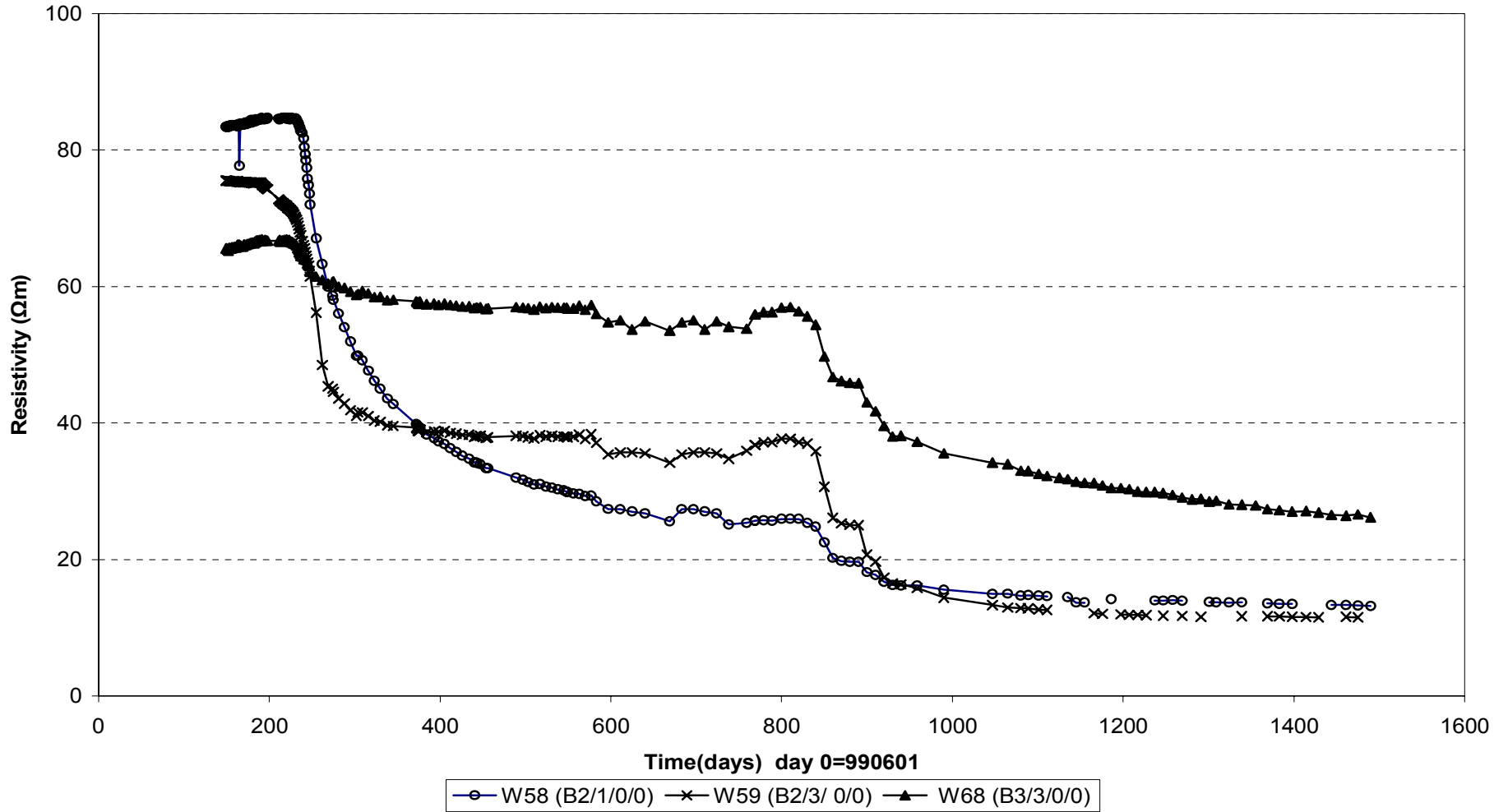

Pore water pressure sectionA1(990601-030701)
GLÖTZL

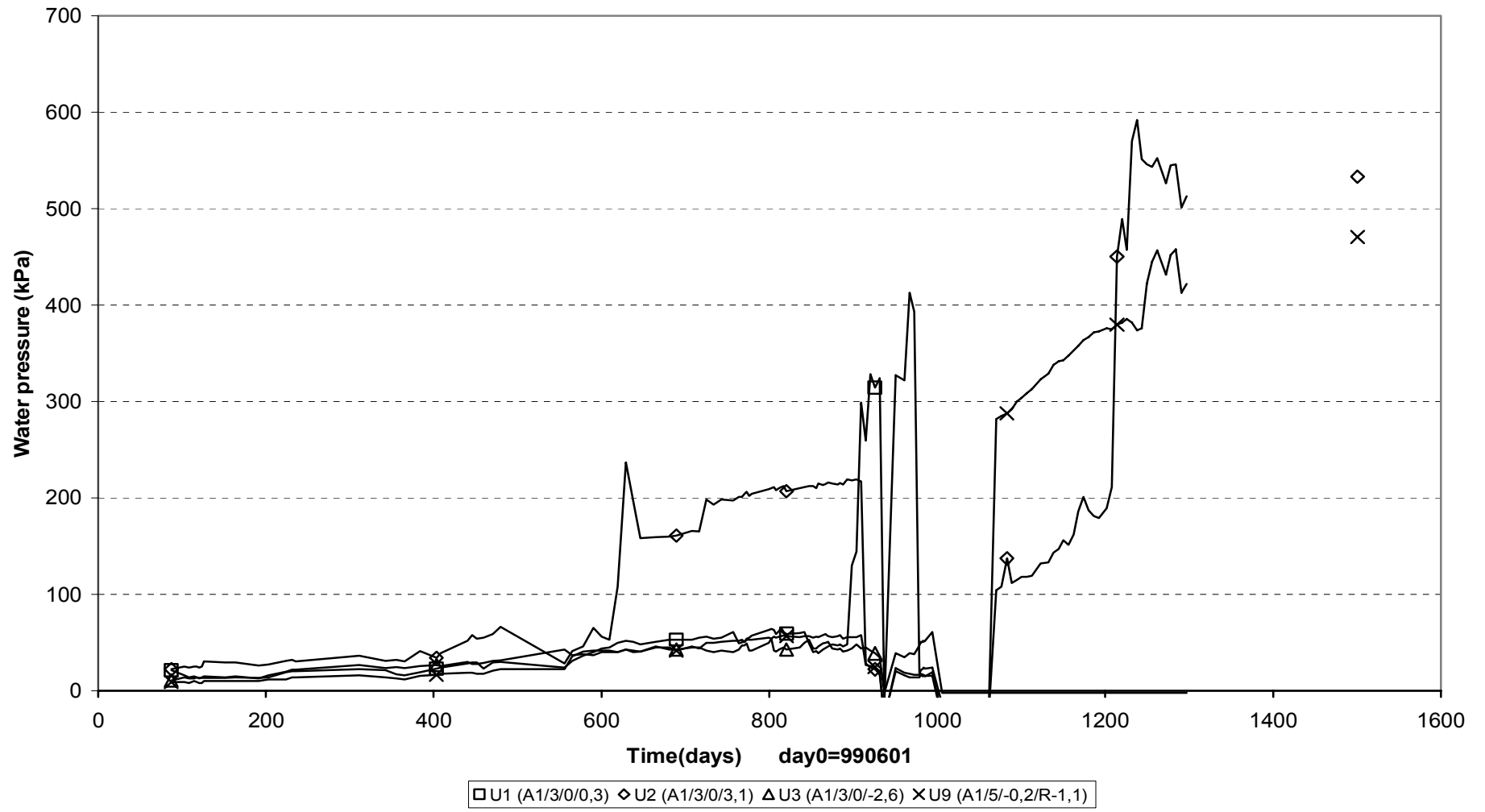

Pore water pressure section A2(990601-030701)
GLÖTZL

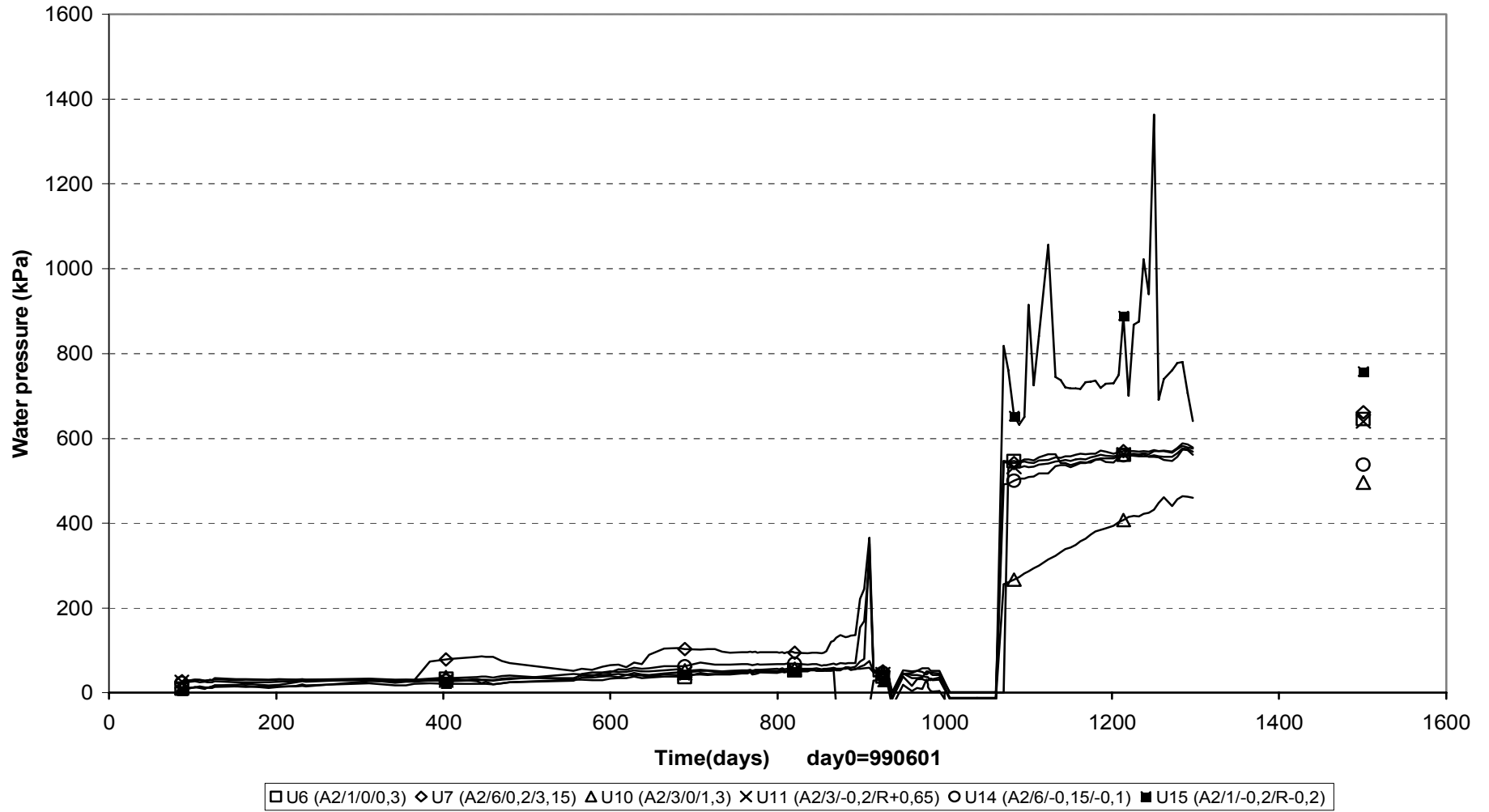

Pore water pressure section A3&A4(990601-030701)
GLÖTZL

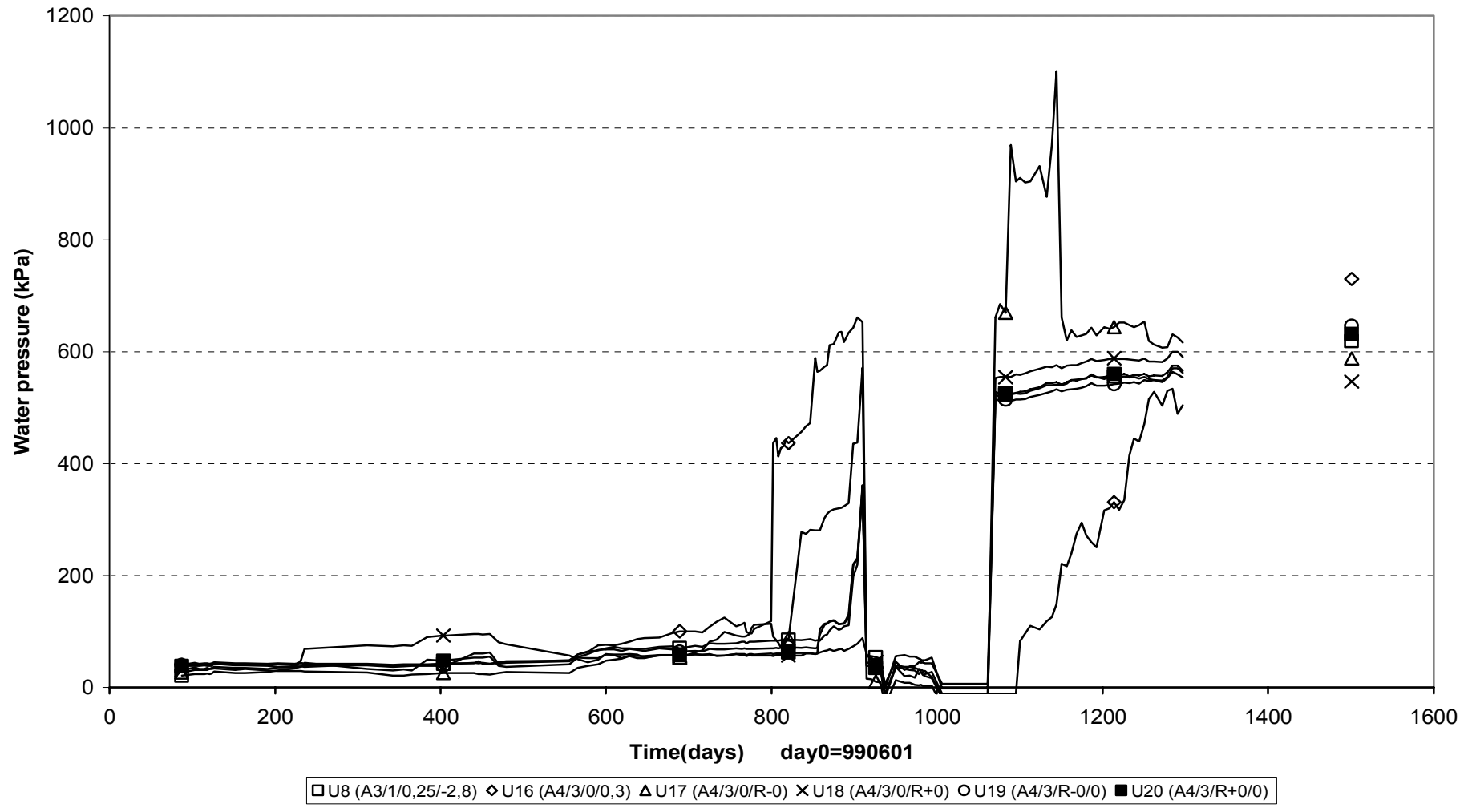

Pore water pressure sectionA5(990601-030701)
GLÖTZL

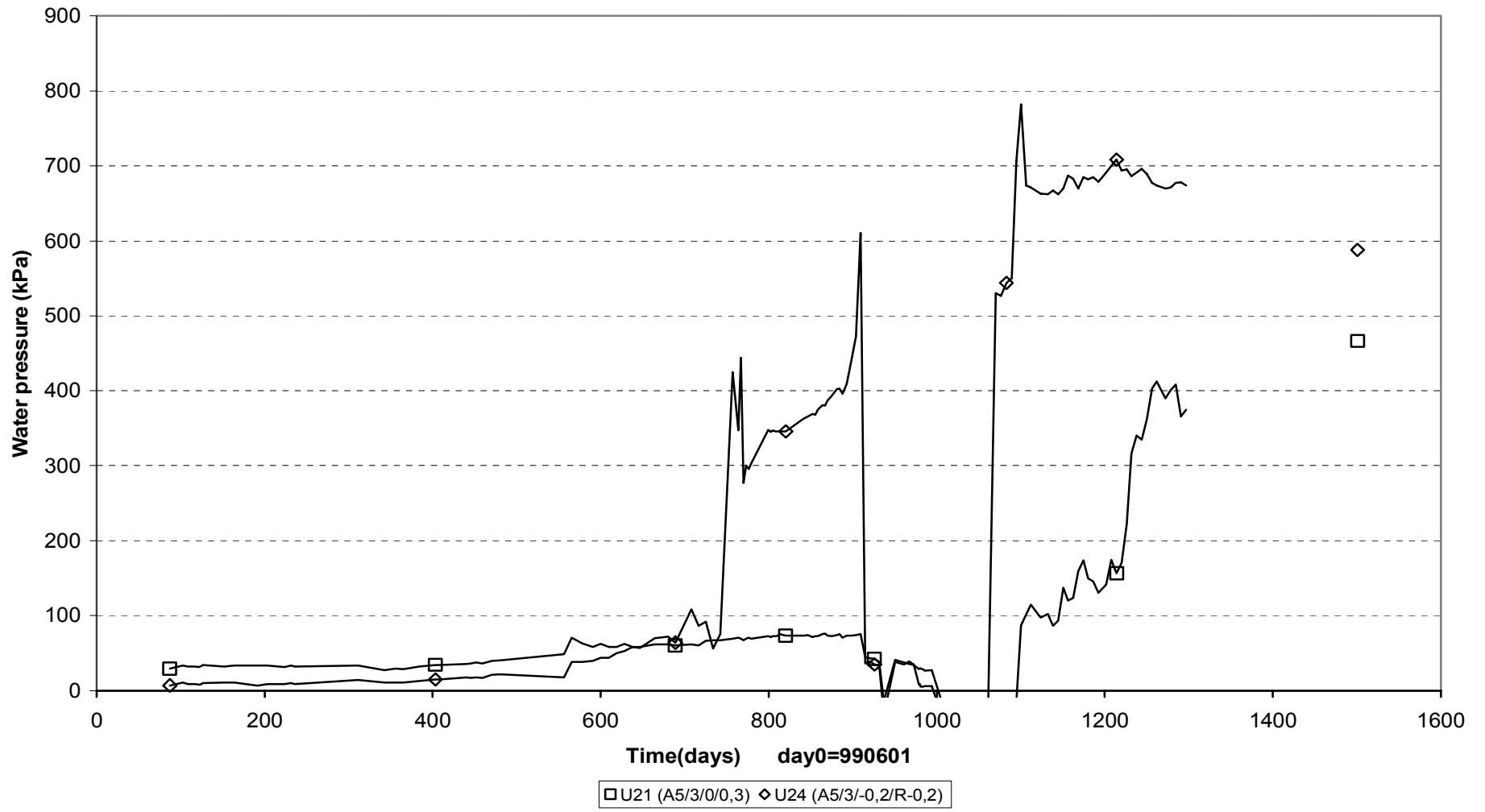

Water pressure in backfill sections A1- A6 (990601-030701)
DRUCK

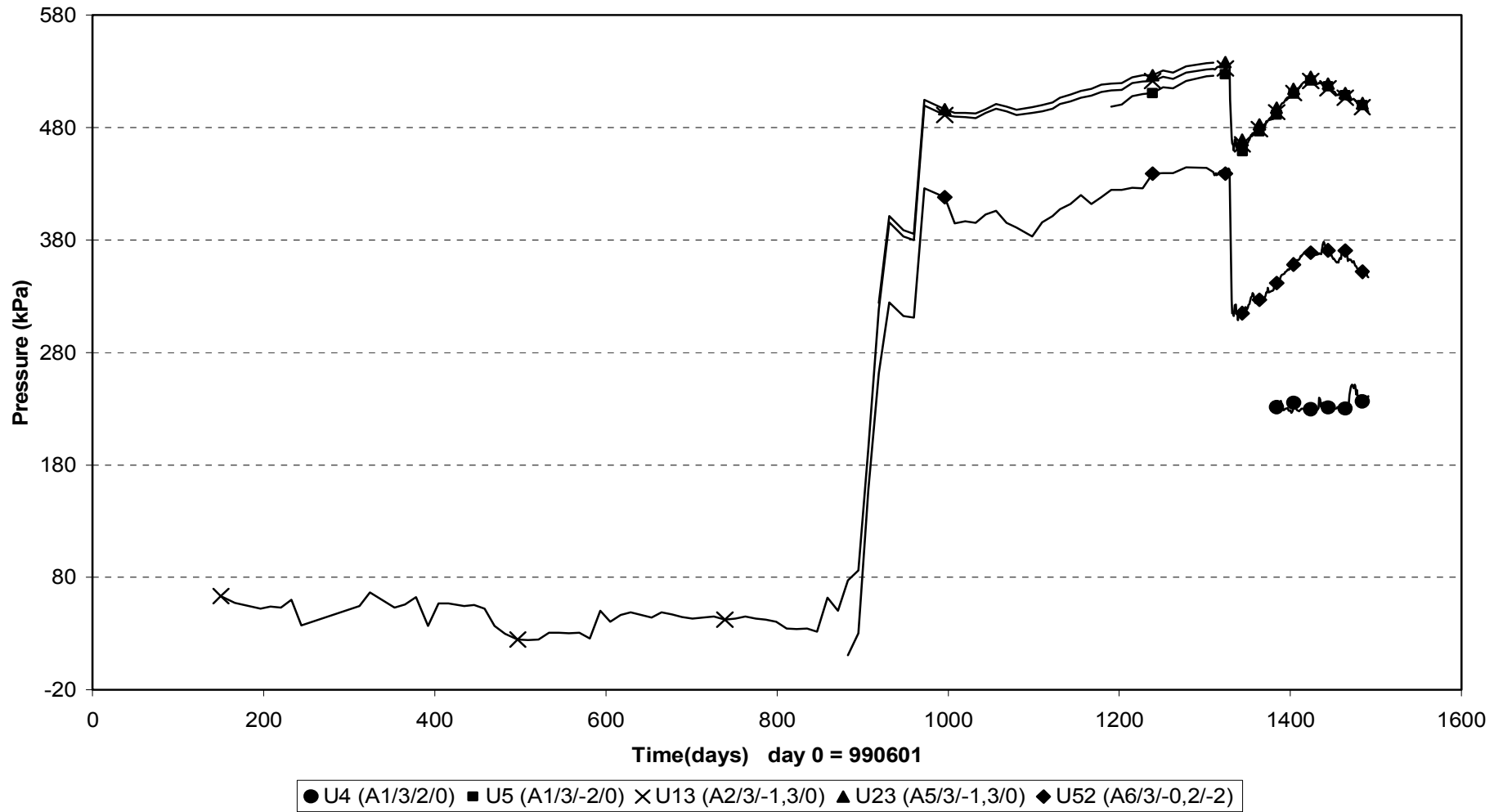

**Water pressure in backfill sections B2&B3&B4 (990601-030701)
DRUCK**

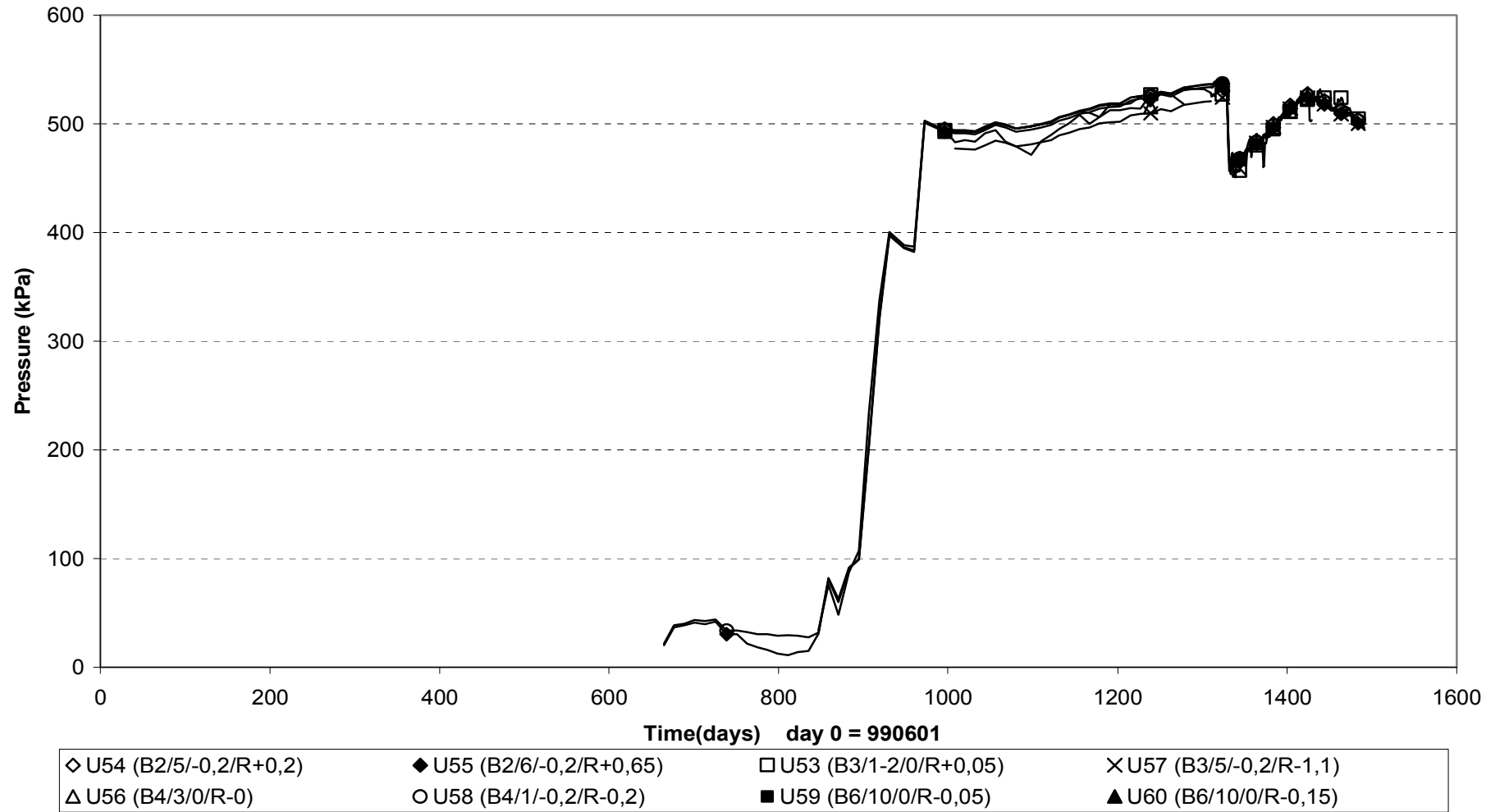

Flowmeter(000601-030701)

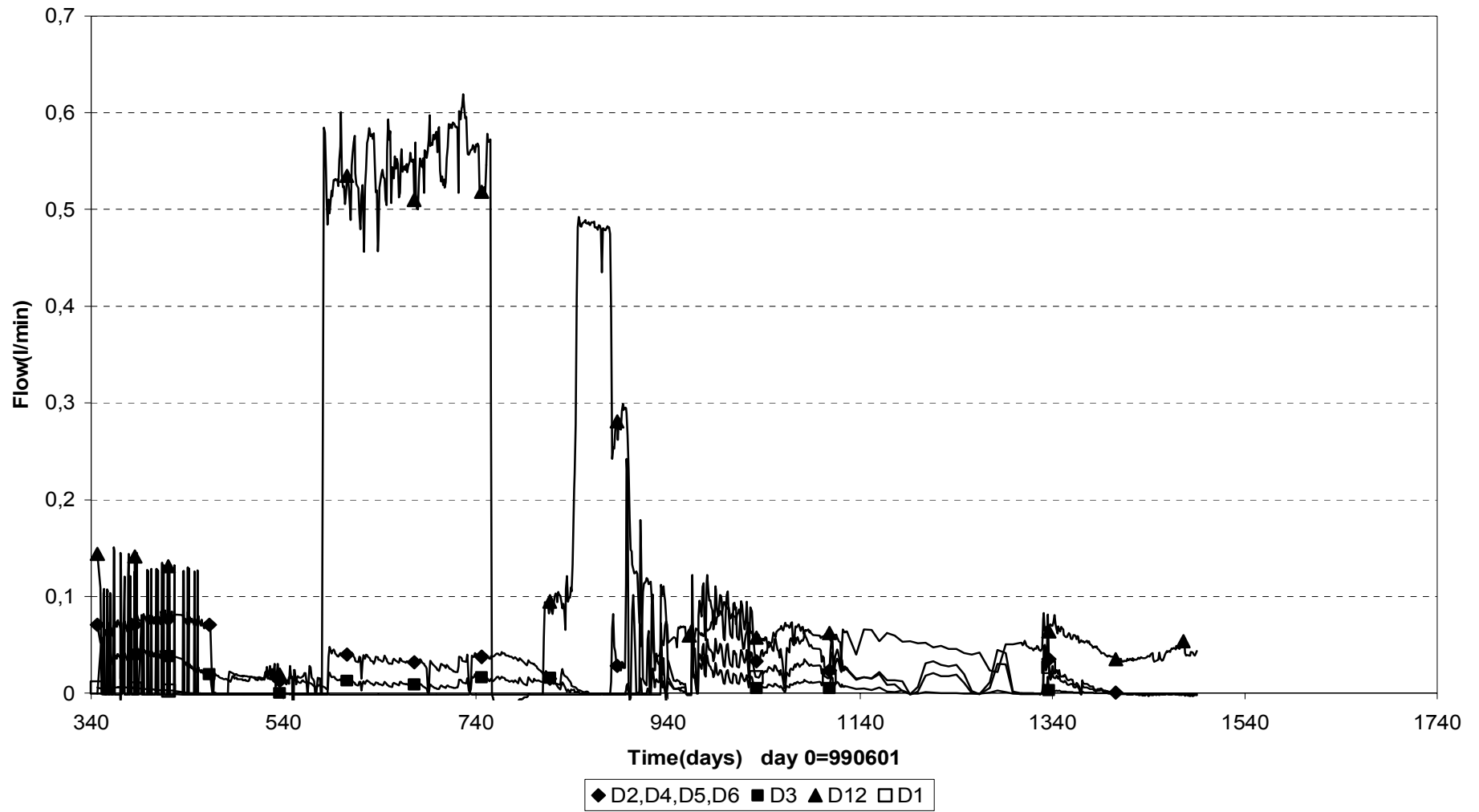

Water pressure in permeable mats D1-D6 (990601-030701)
Druck

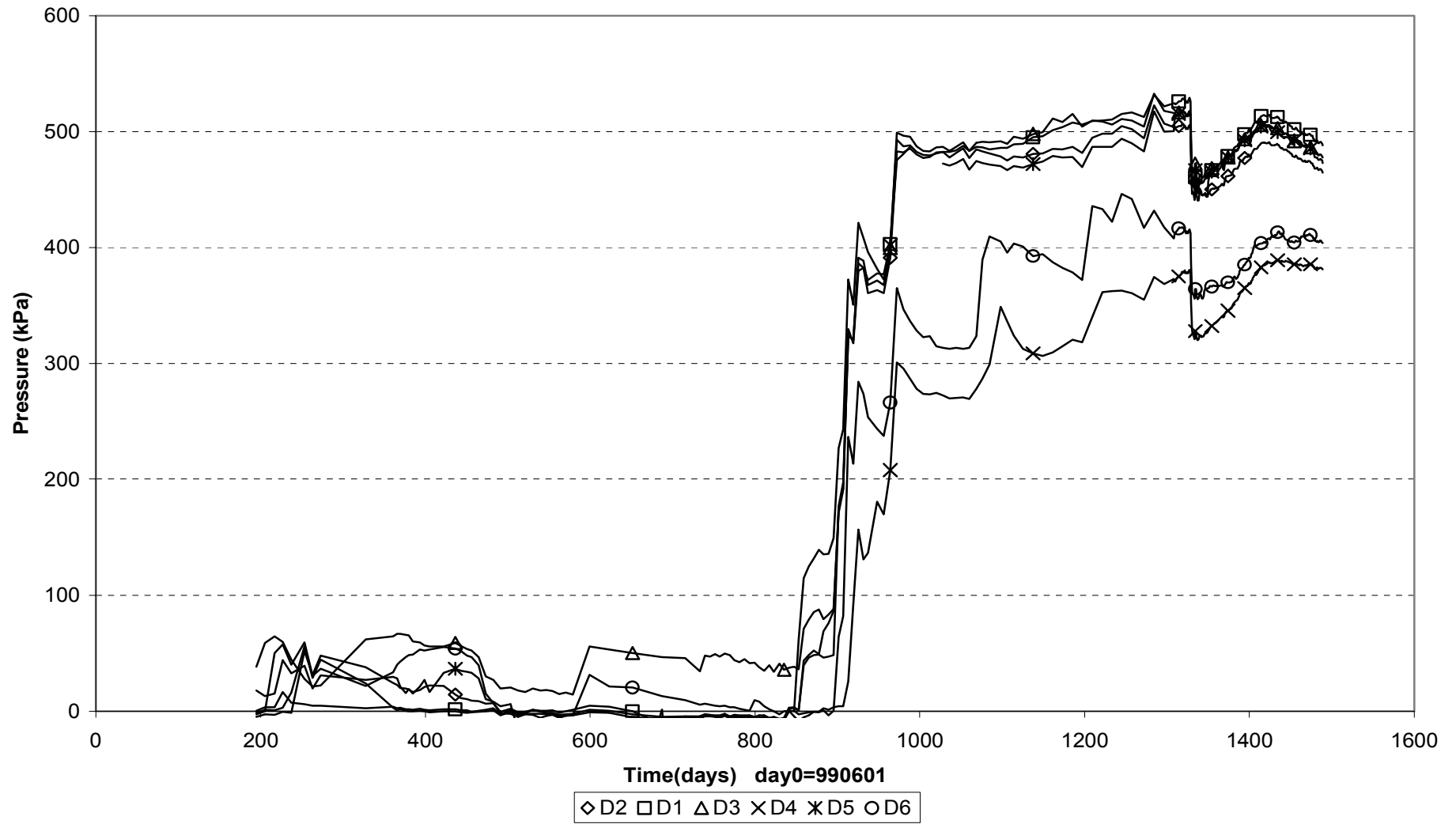

Water pressure in permeable mats D7-D12 (990601-030701)
DRUCK

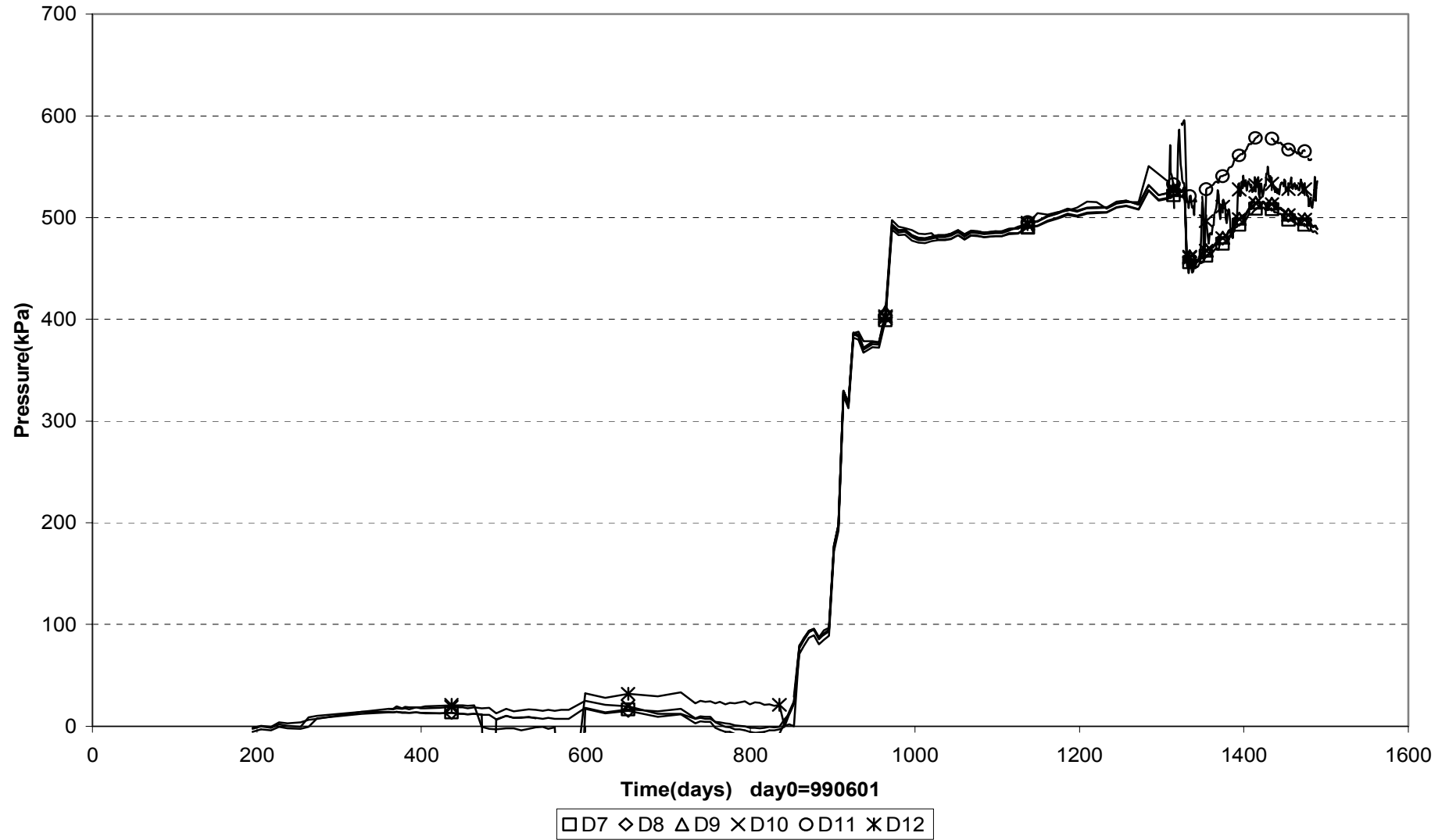

Water flow past plug (010809-030701)

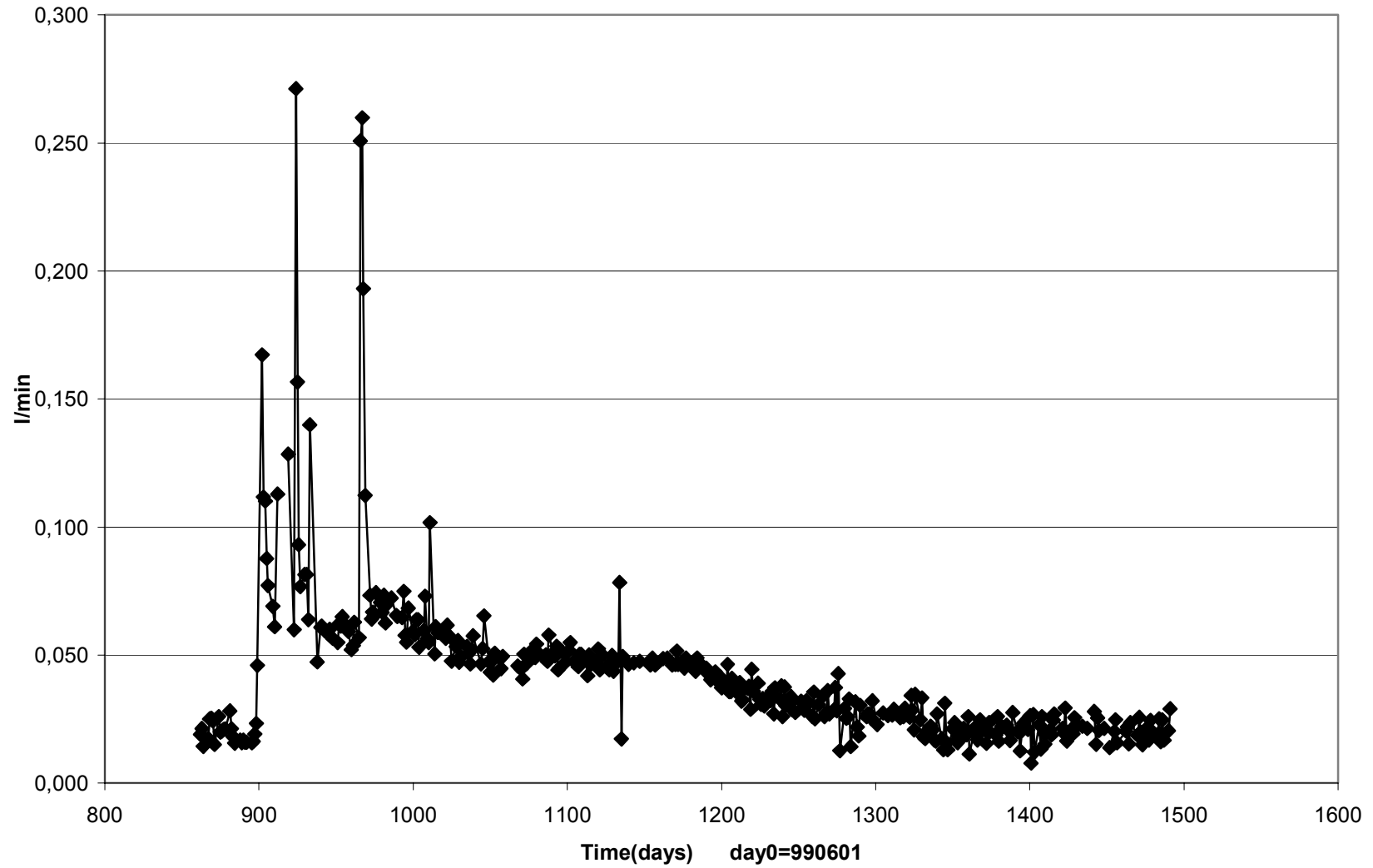

Water flow from inner part (010809-030701)

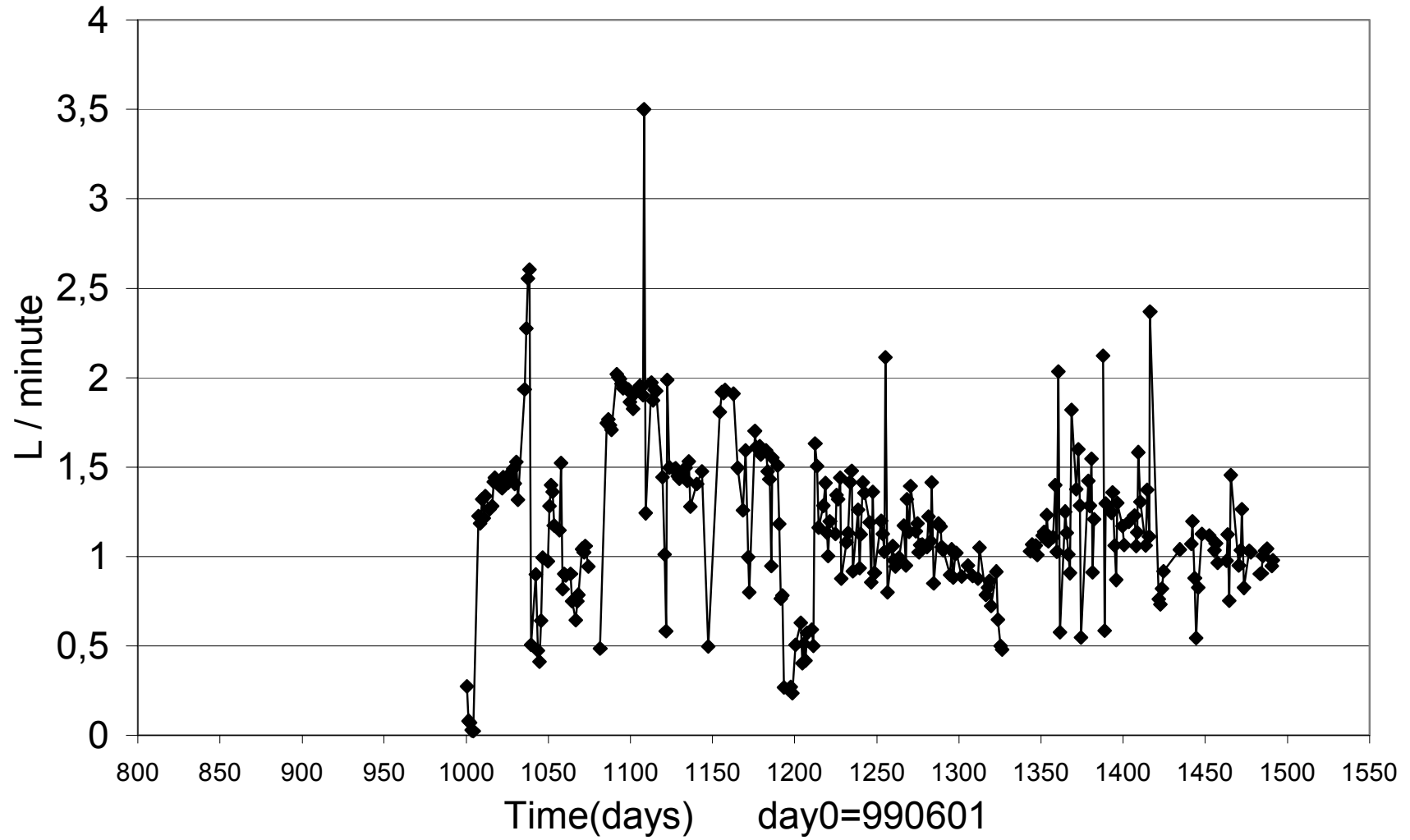

Inflow DEMO-tunnel (010919-030701)

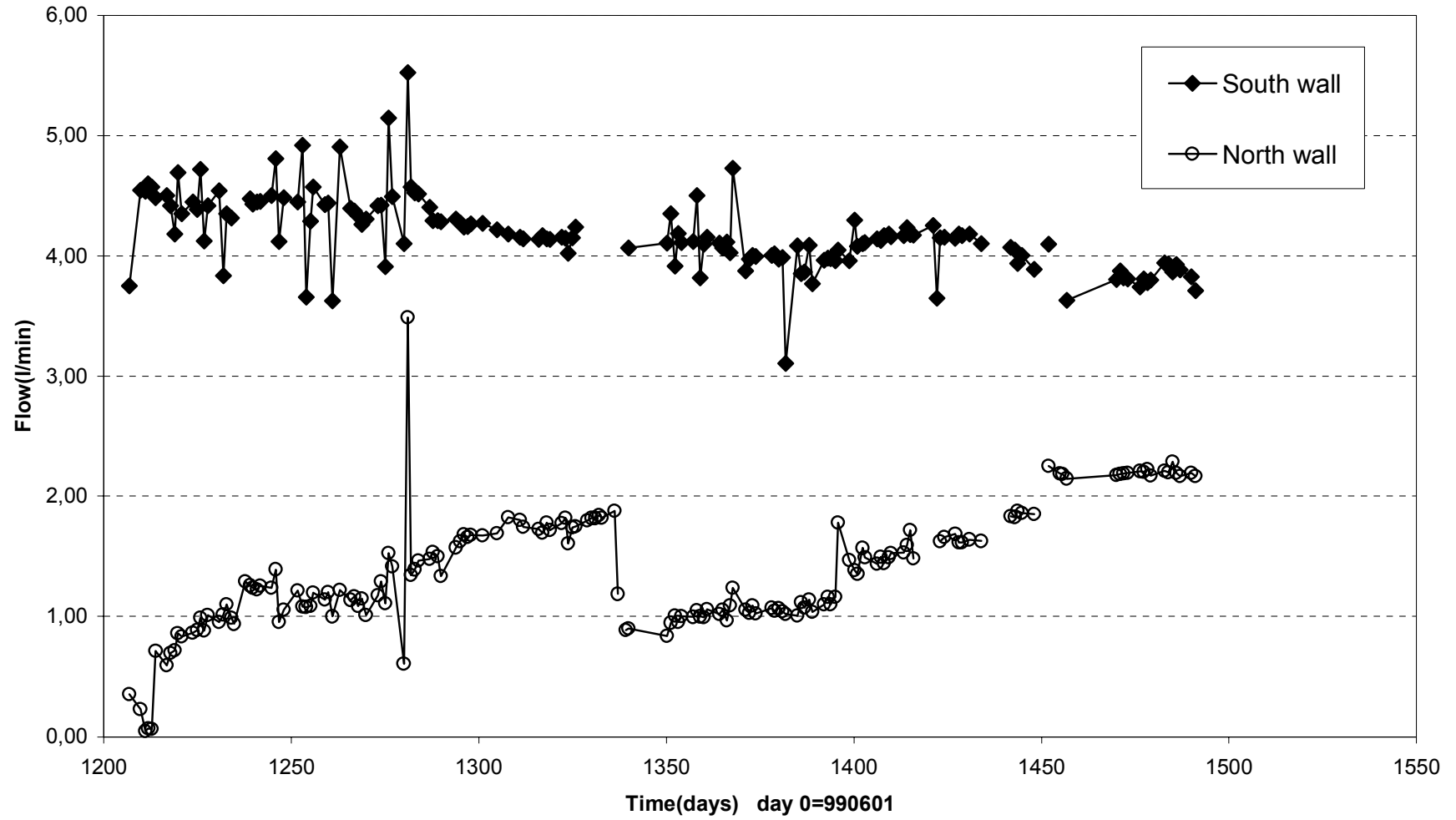

Water pressure in bore holes section 0(9906-030701)
DRUCK

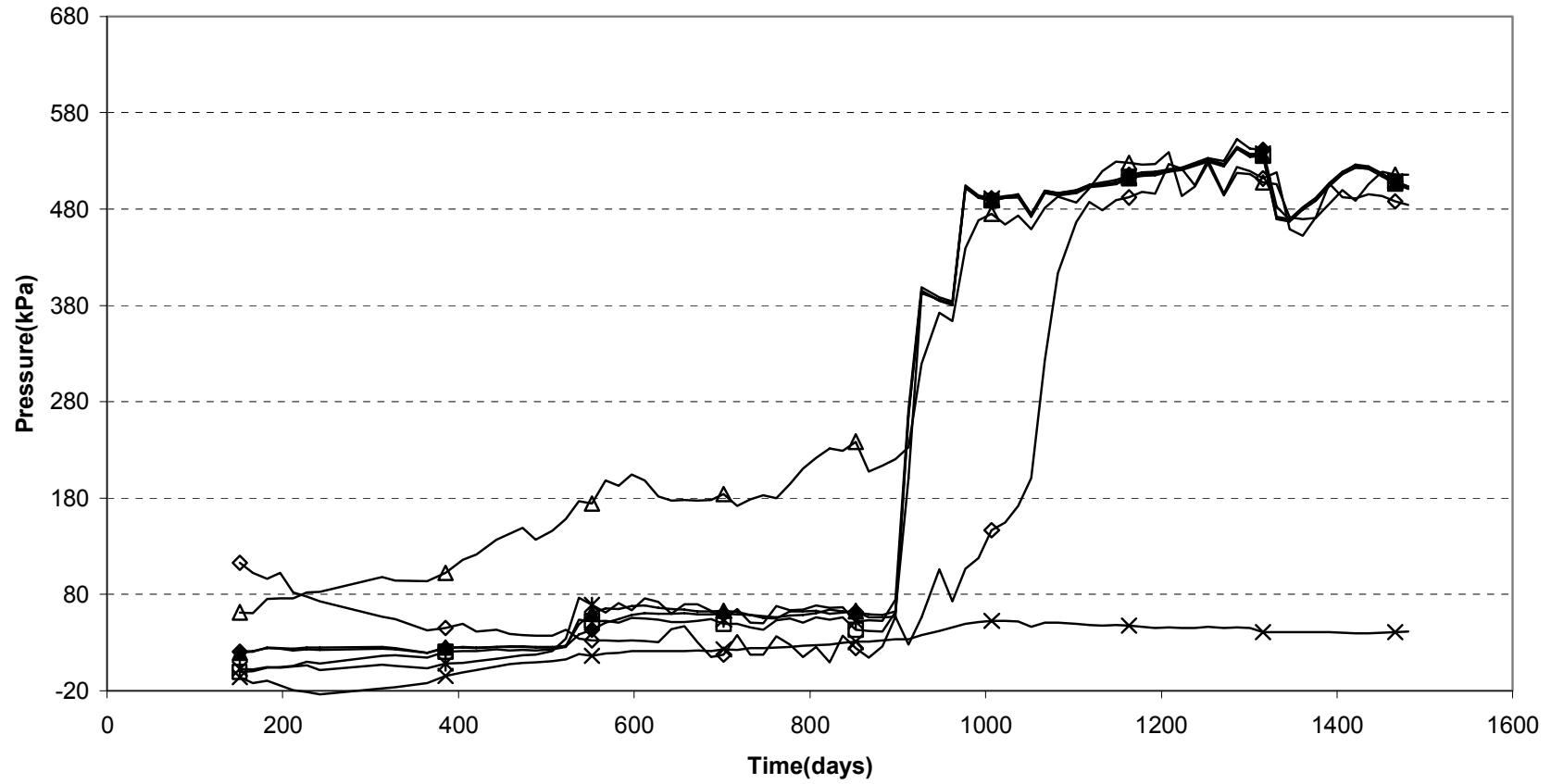

| | | |
|-----------------------|----------------------|-----------------------|
| □ UR21 (0/RW/0,5-1,0) | ◇ UR22(0/RW/0,5-1,0) | △ UR41(0/F/0,5-1,0) |
| × UR42(0/F/0,5-1,0) | × UR43(0/F/0,5-1,0) | ◆ UR61 (0/LW/0,5-1,0) |
| ▲ UR62(0/LW/0,5-1,0) | | |

Water pressure in bore holes section 0(9906-030701)
DRUCK

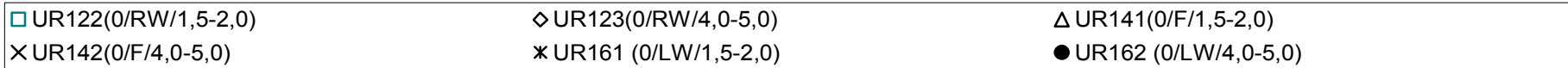
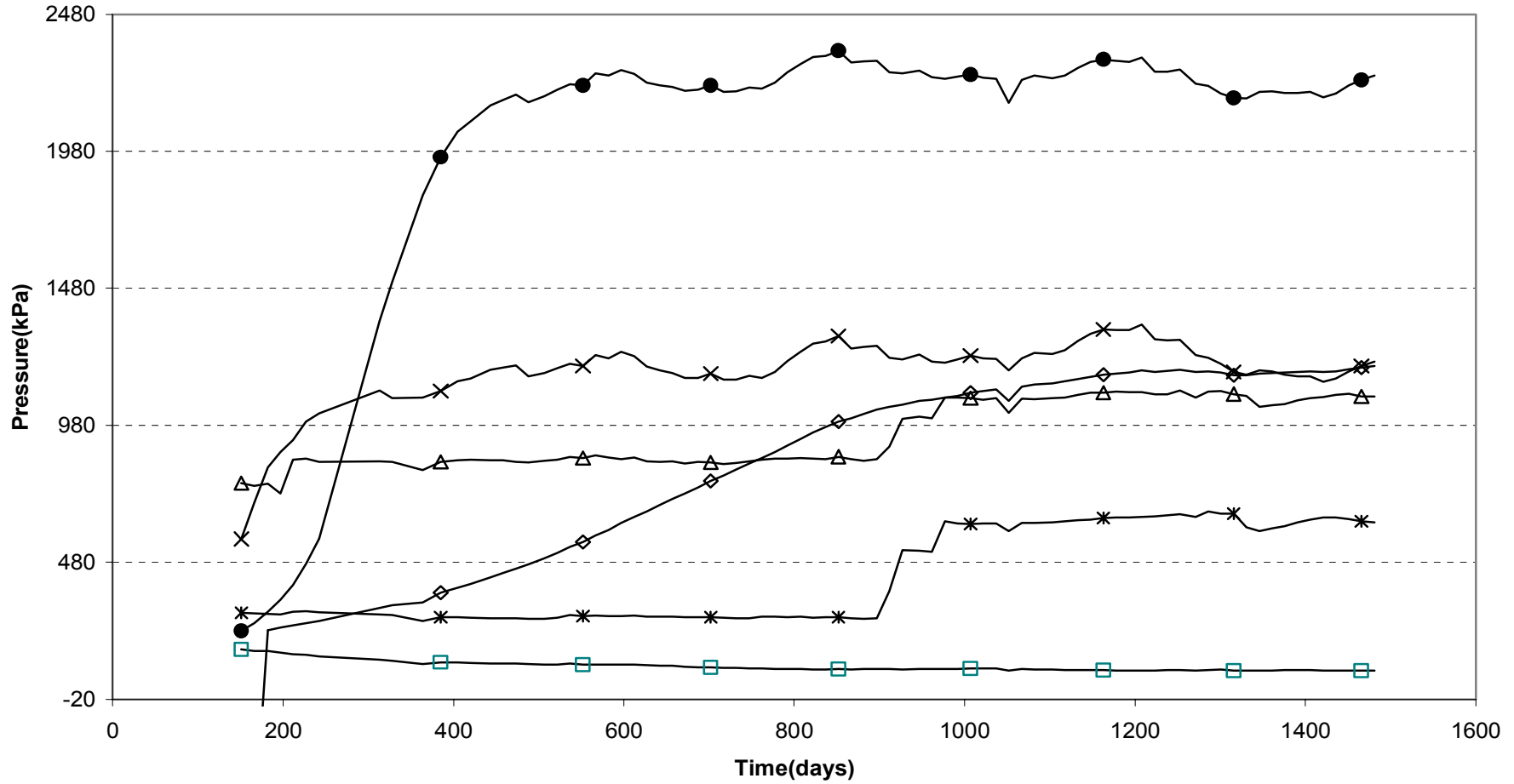

Water pressure in bore holes sectionA1 (9906-030701)
DRUCK

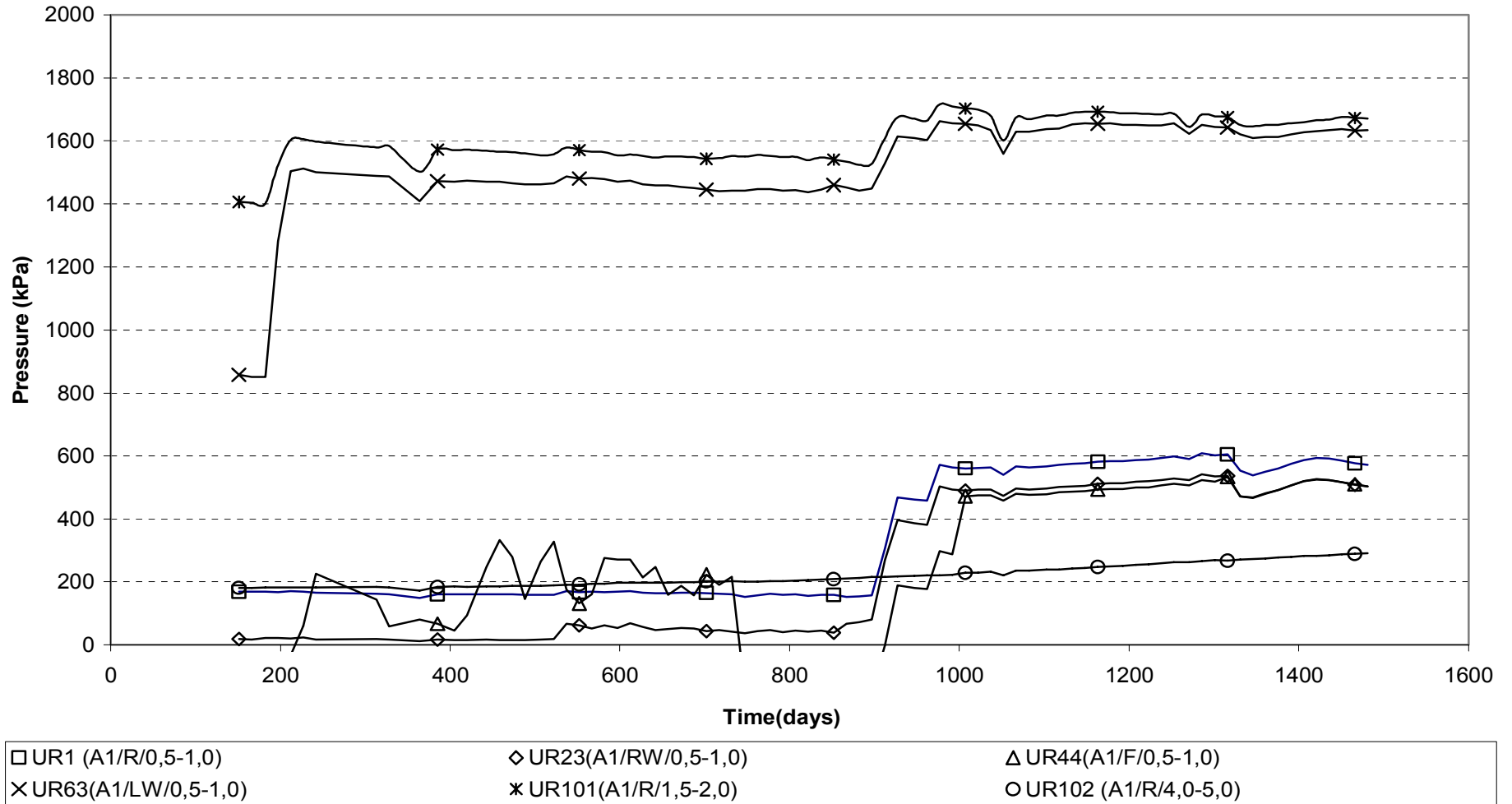

Water pressure in bore holes section A2 (9906-030701)
DRUCK

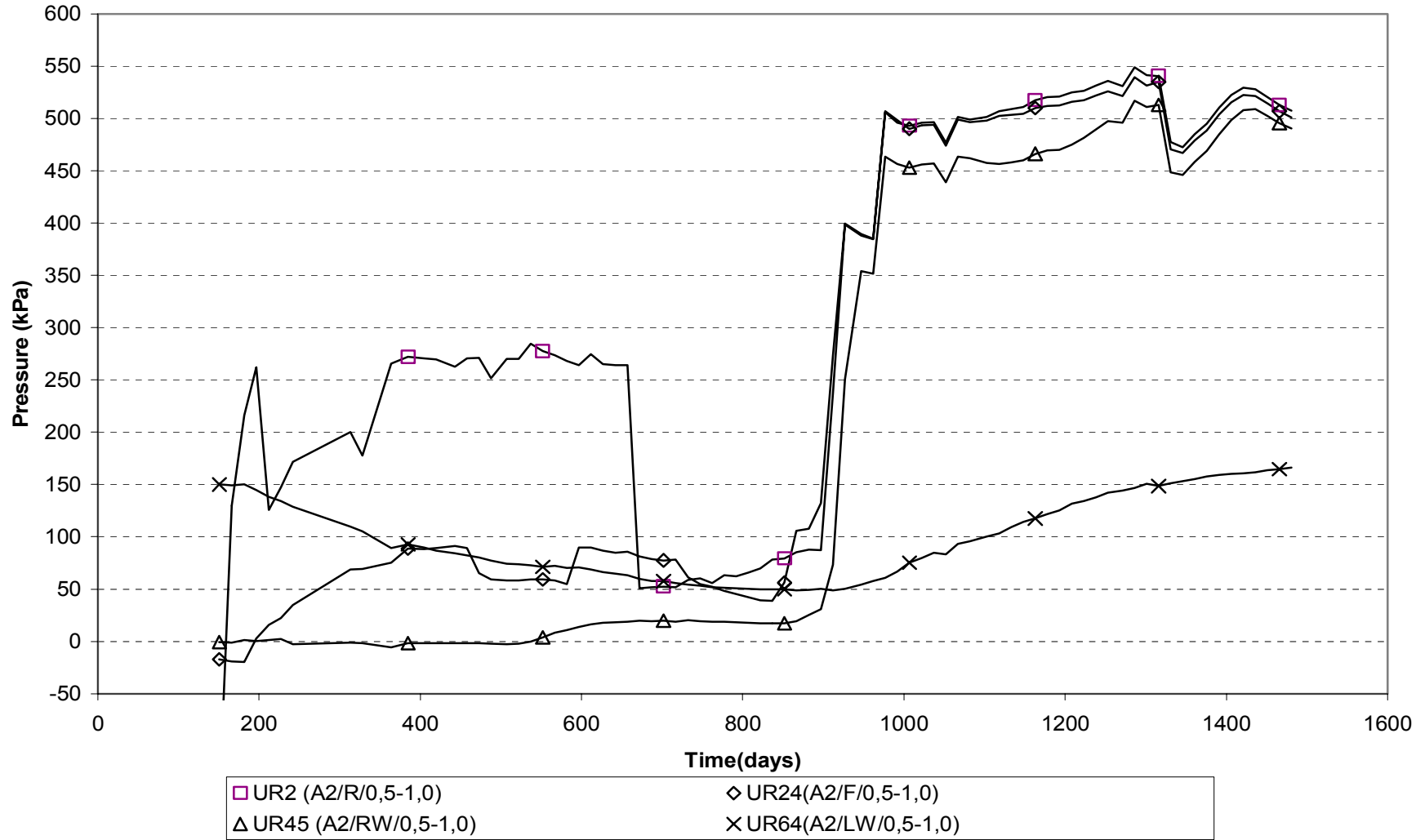

Water pressure in bore holes sectionA2 (9906-030701)
DRUCK

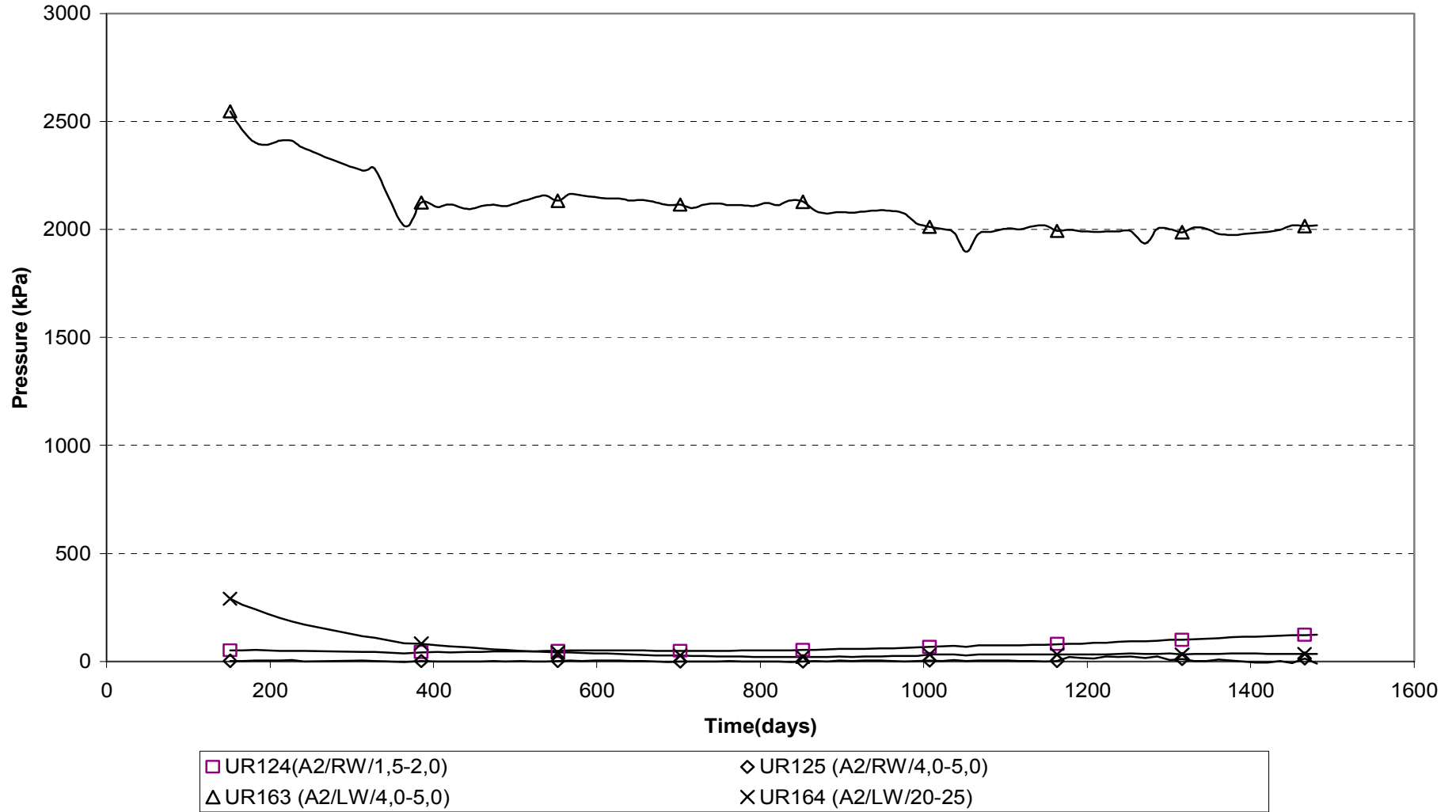

Water pressure in bore holes section A3 (9906-030701)
DRUCK

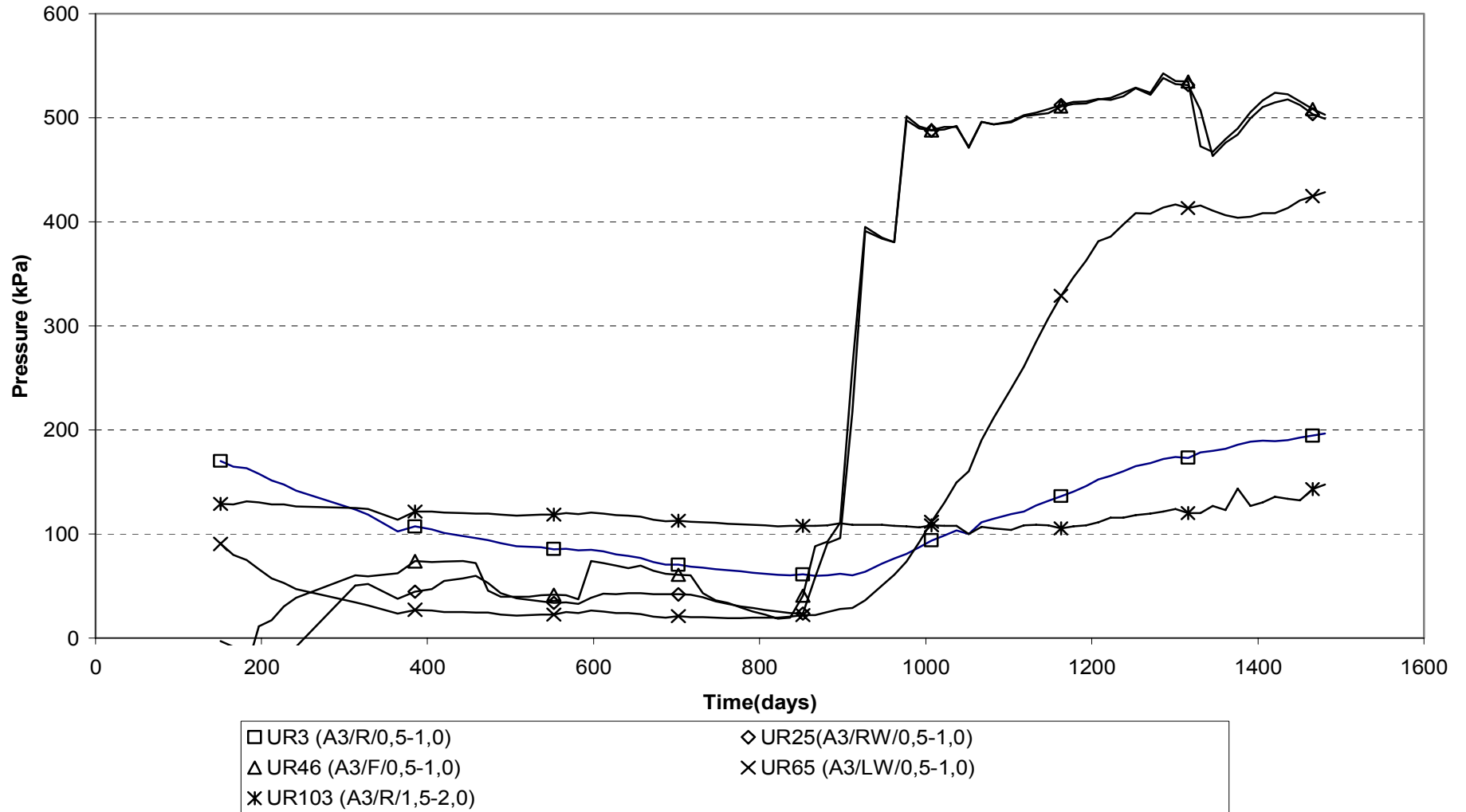

**Water pressure in bore holes section A3(9906-030701)
DRUCK**

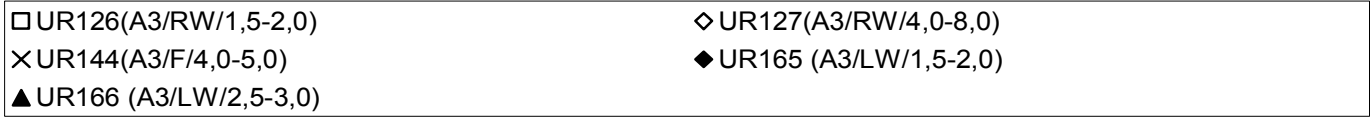
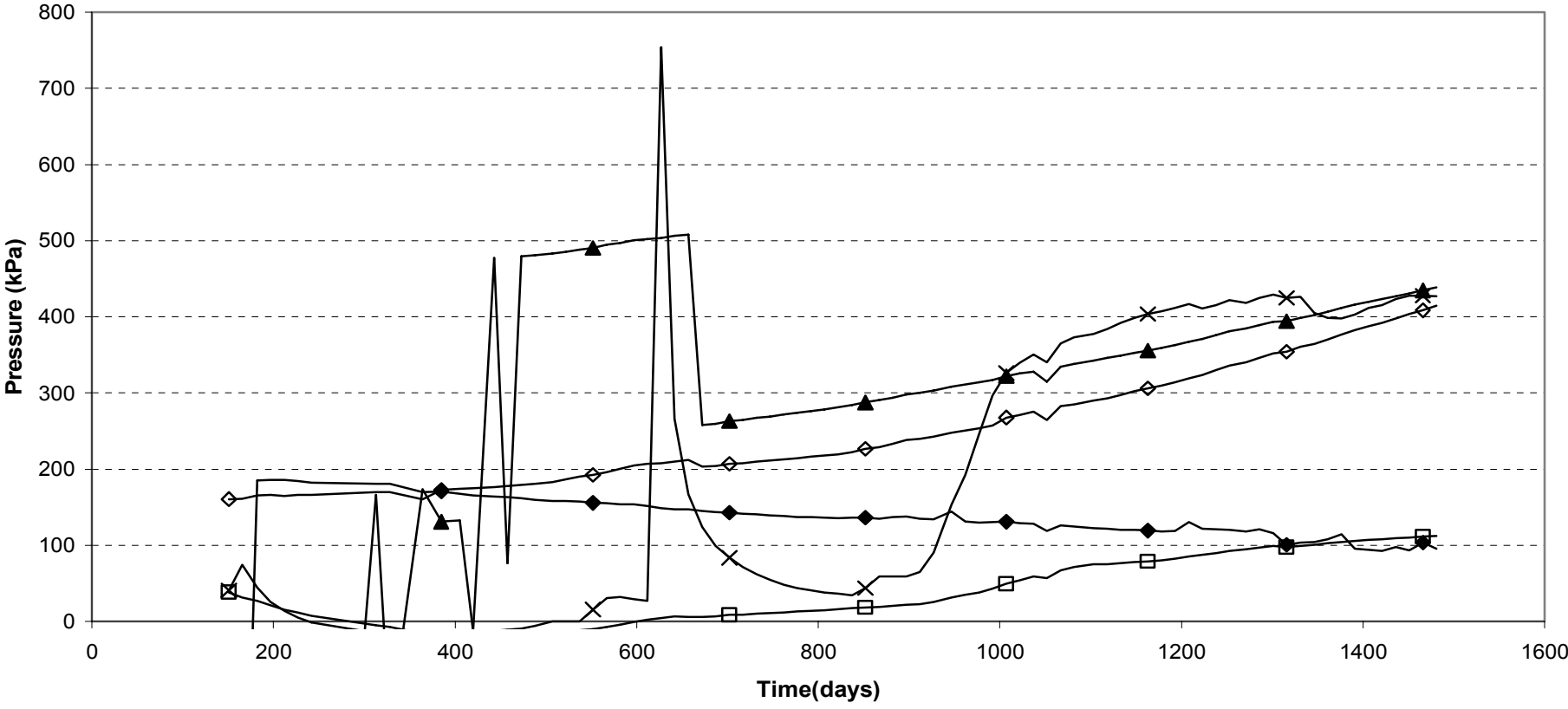

Water pressure in bore holes sectionA3(9906-030701)
DRUCK

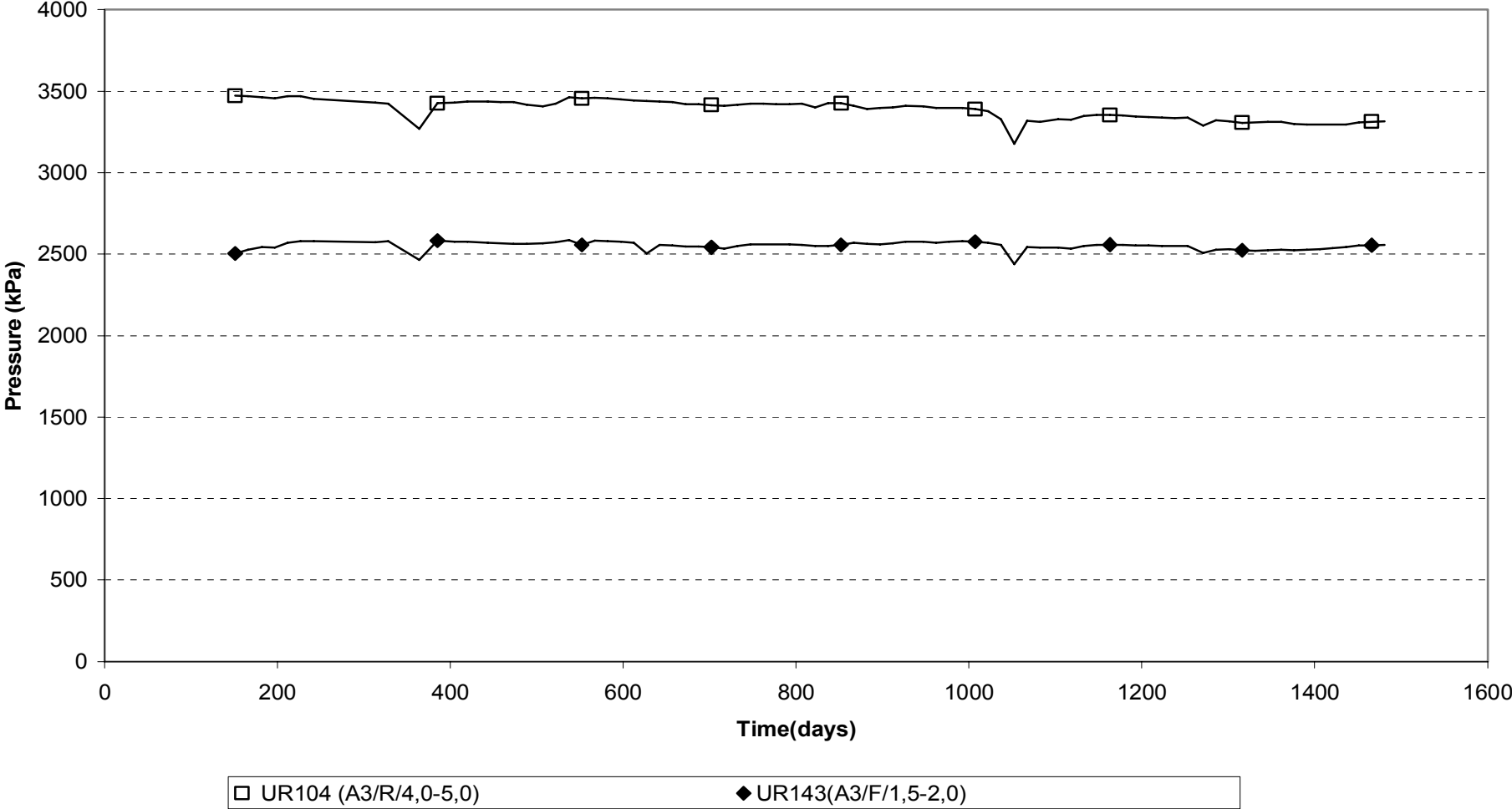

Water pressure in bore holes sectionA4 (9906-030701)
DRUCK

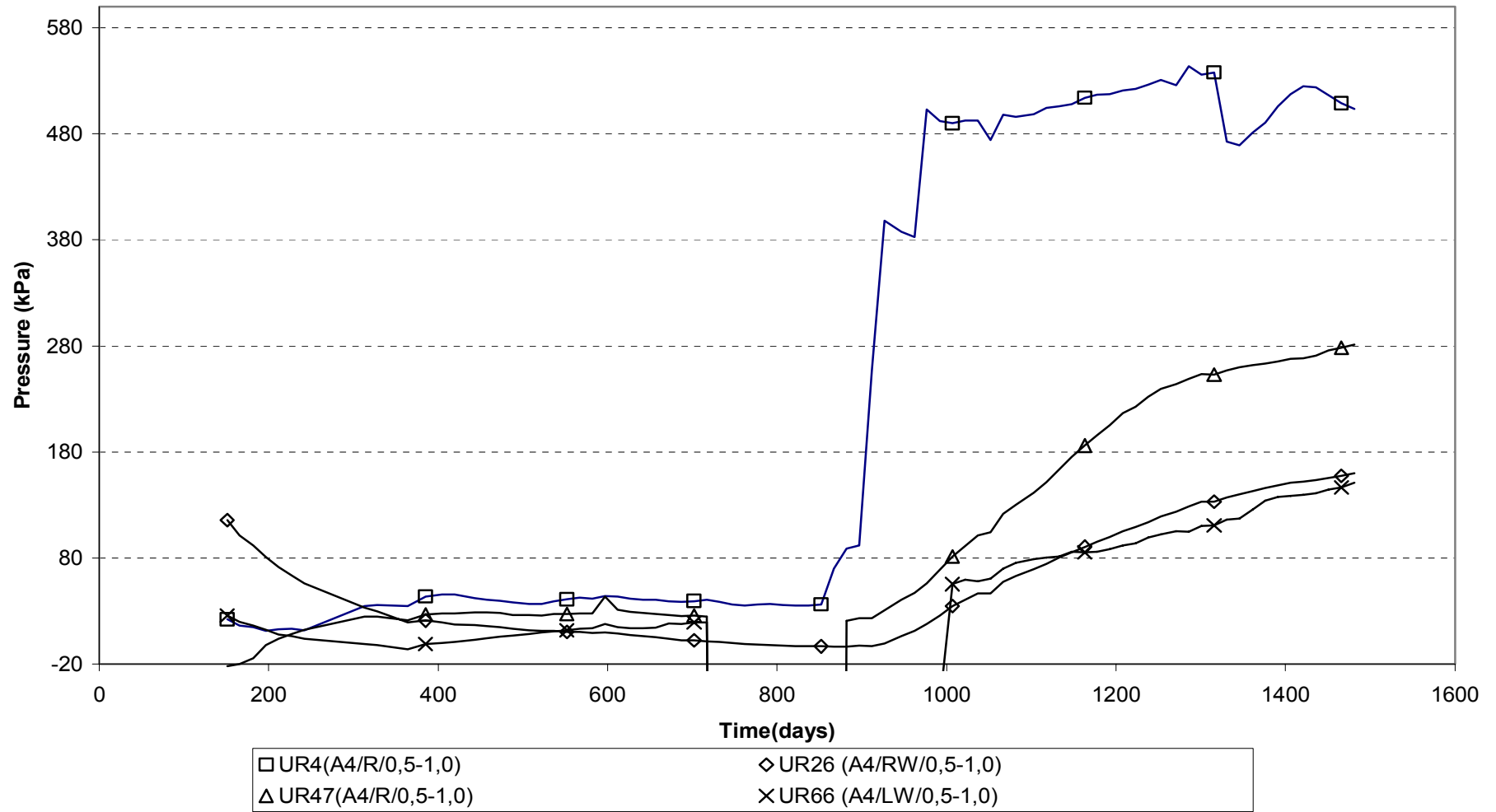

Water pressure in bore holes section A5 (9906-030701)
DRUCK

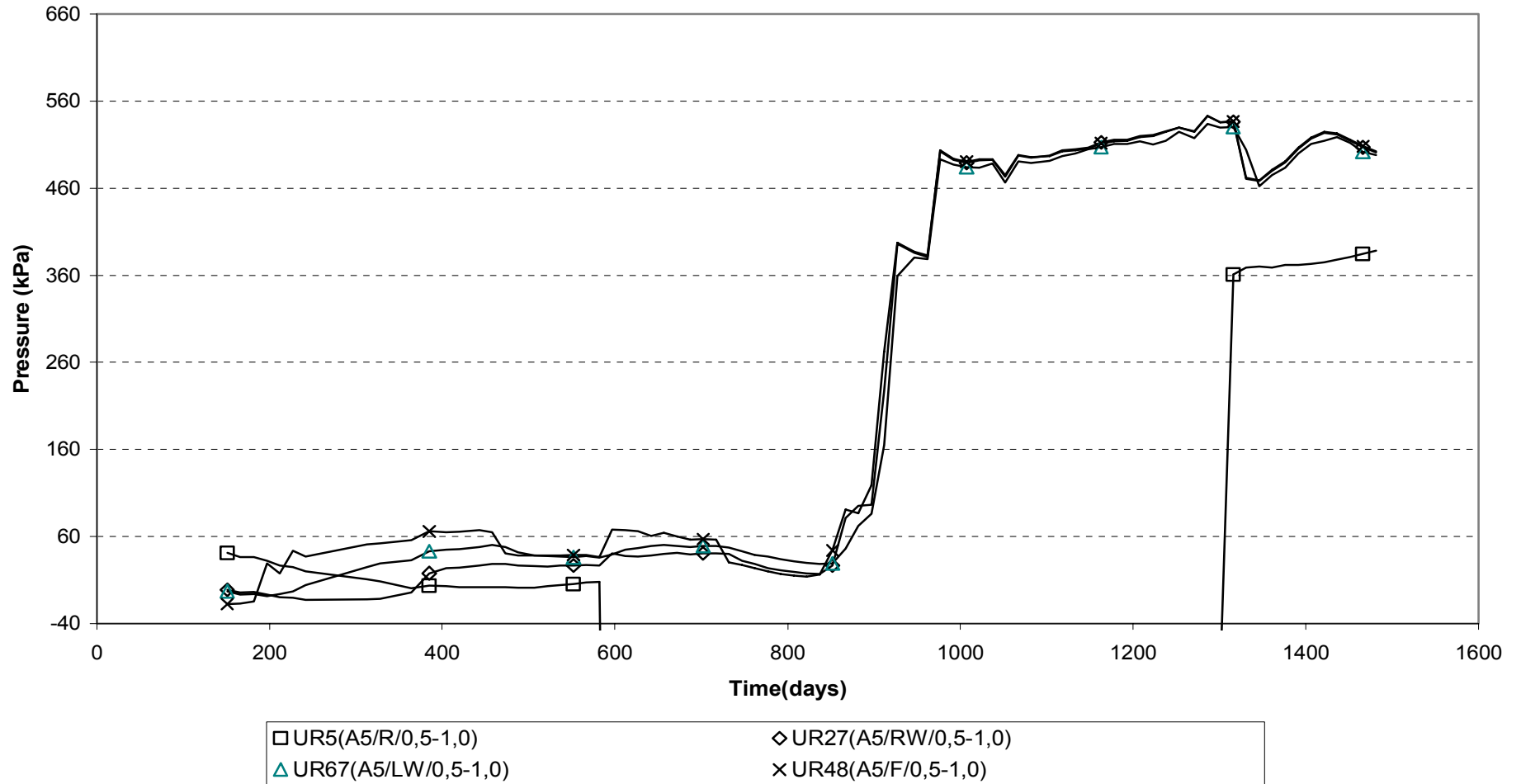

Water pressure in bore holes section B1 (9906-030701)
DRUCK

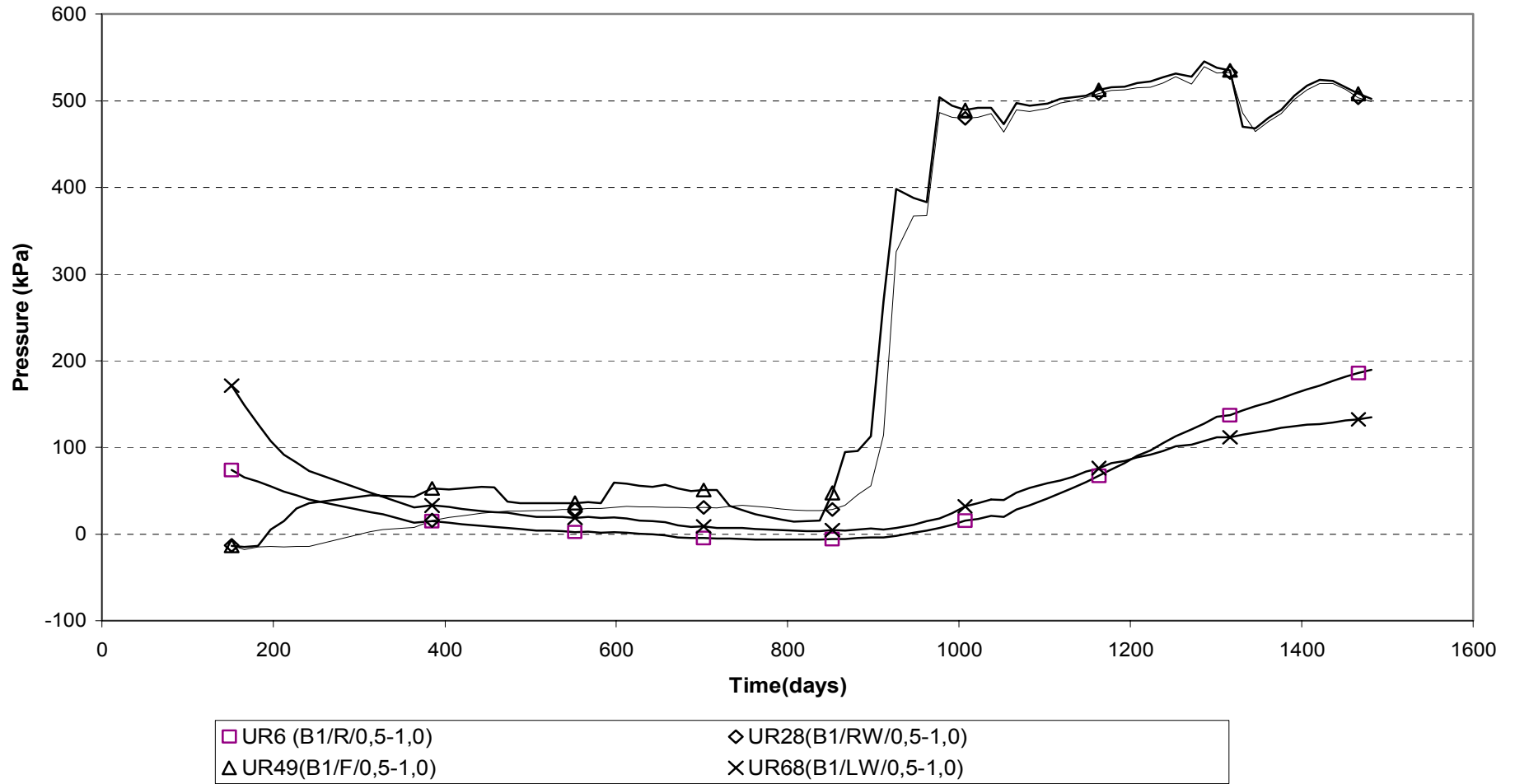

**Water pressure in bore holes section B2(9906-030701)
DRUCK**

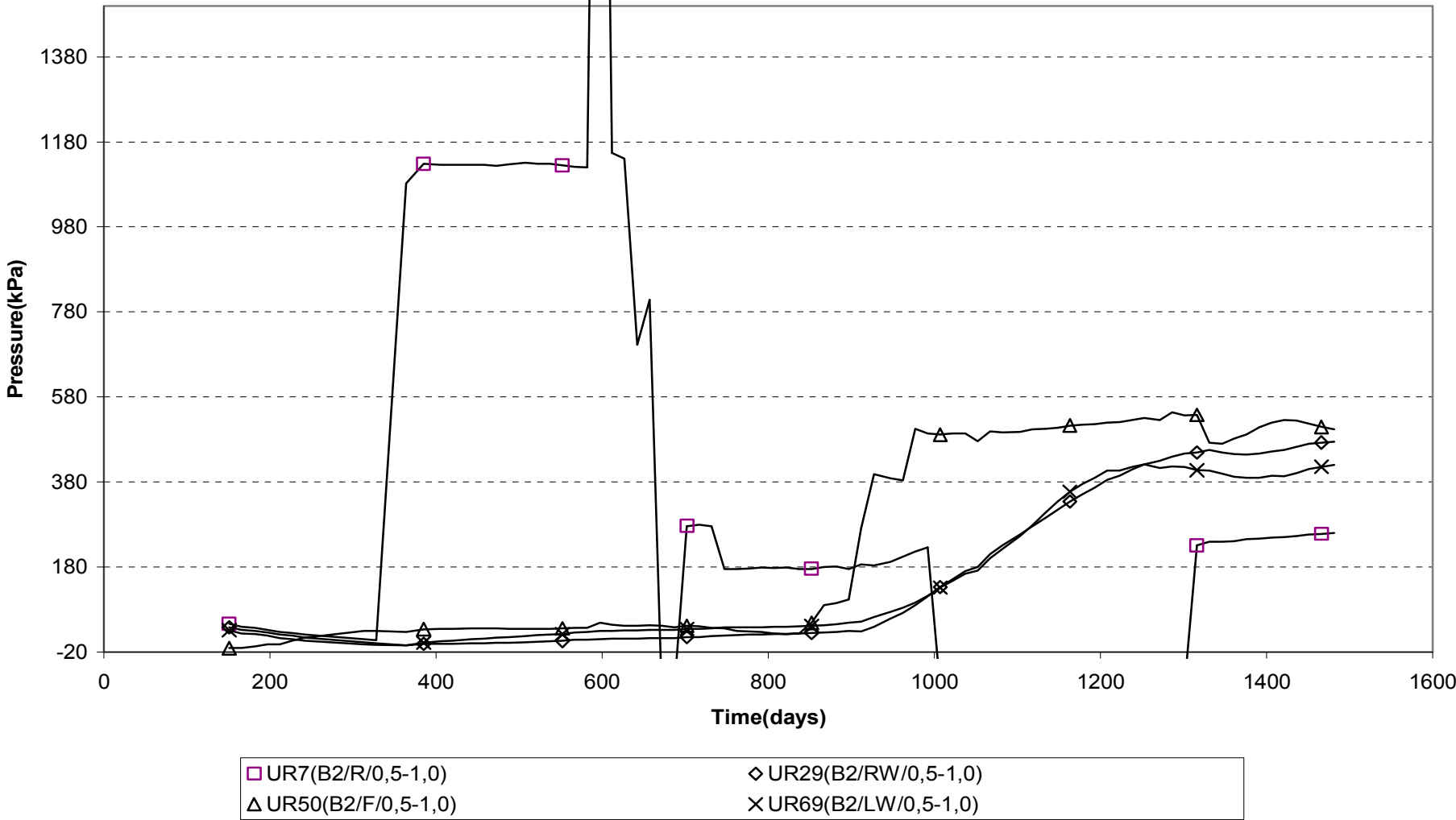

Water pressure in bore holes section B3 (9906-030701)
DRUCK

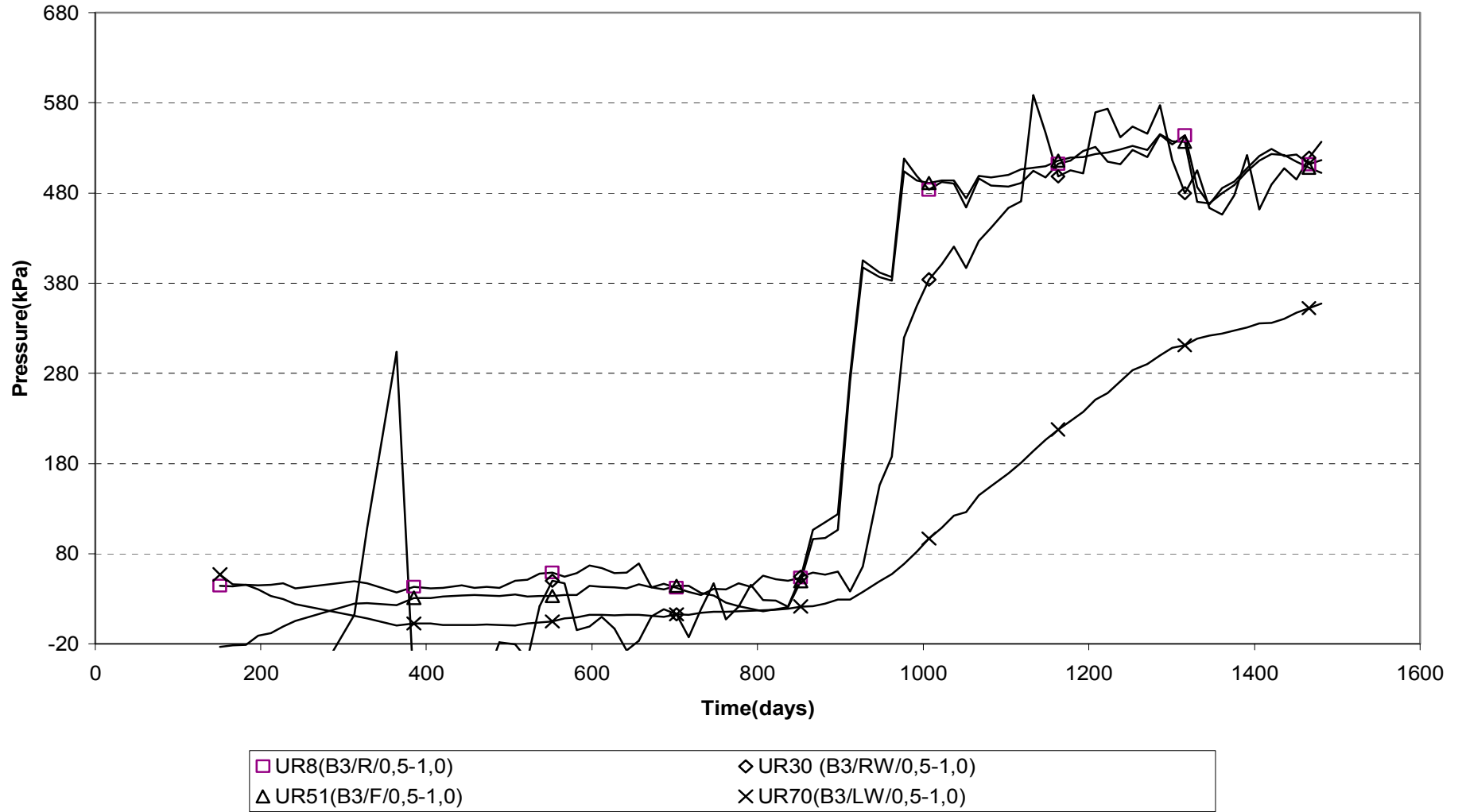

Water pressure in bore holes section B4 (9906-030701)
DRUCK

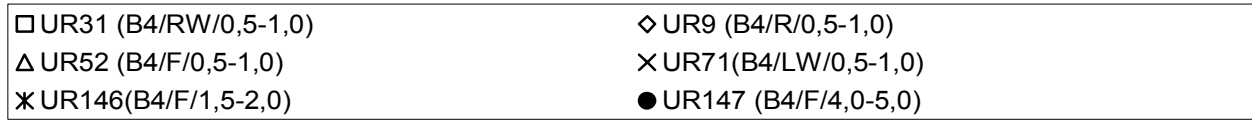
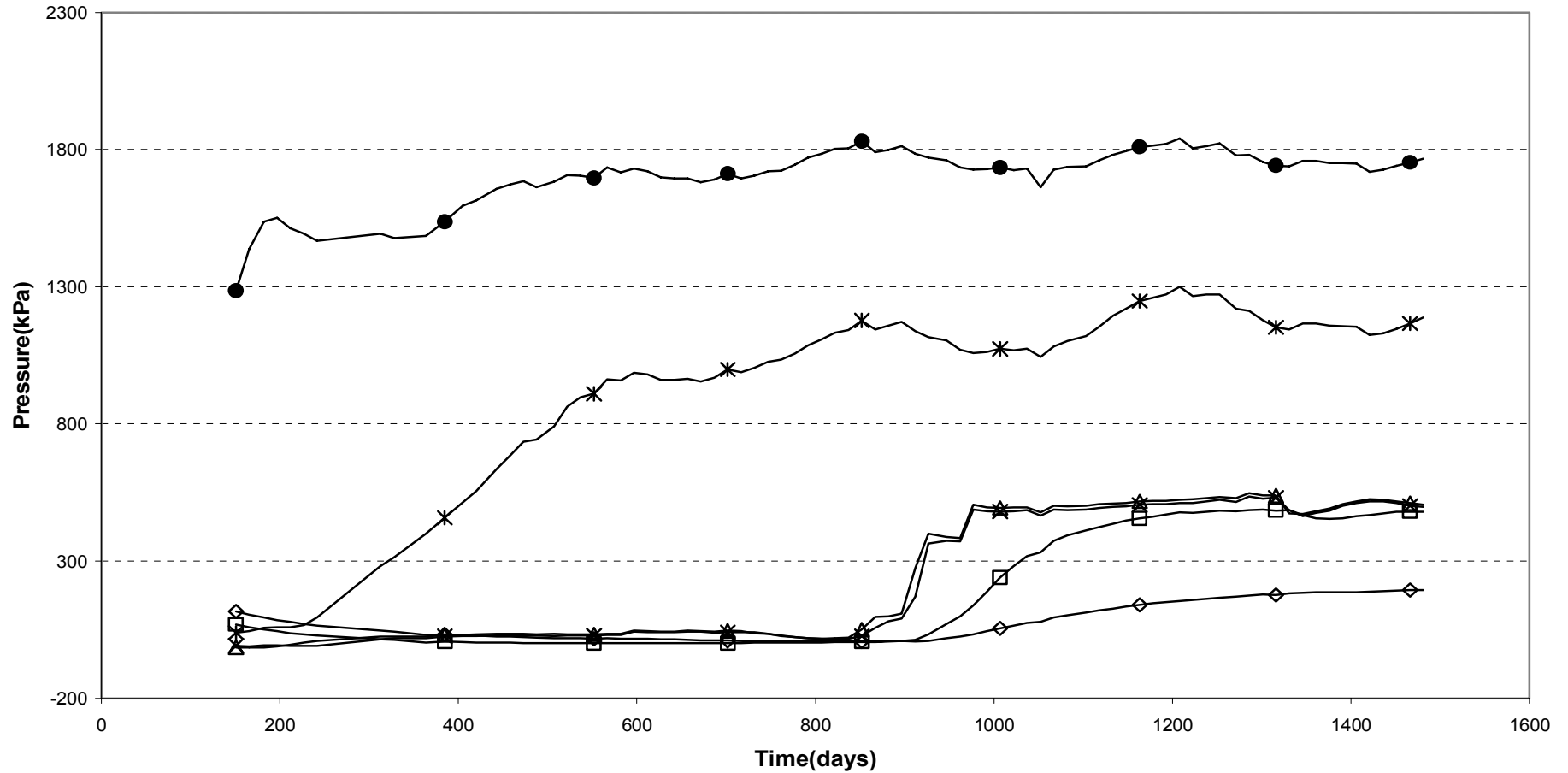

**Water pressure in bore holes section B5(9906-030701)
DRUCK**

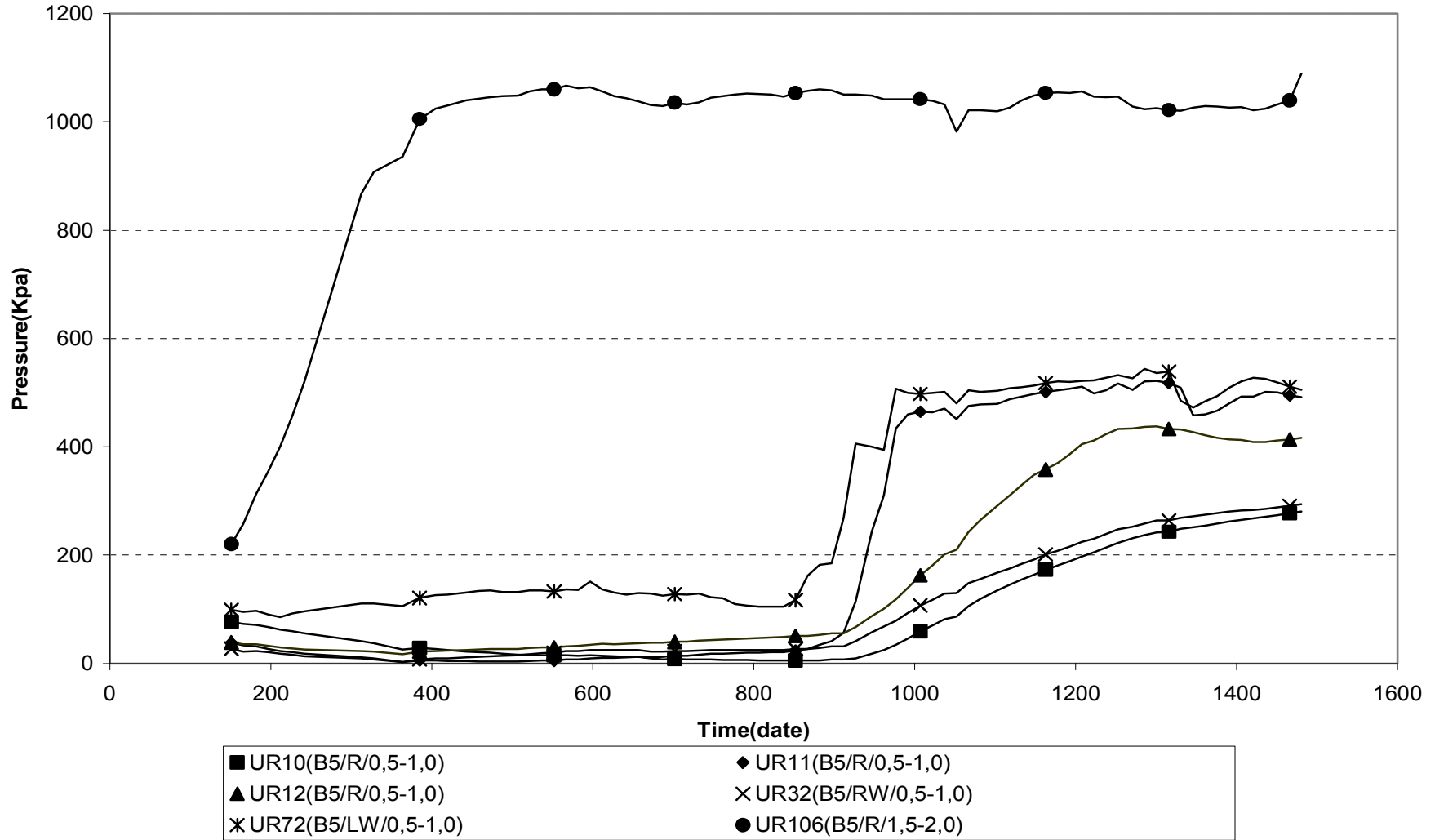

Water pressure in bore holes section B5(9906-030701)
Druck

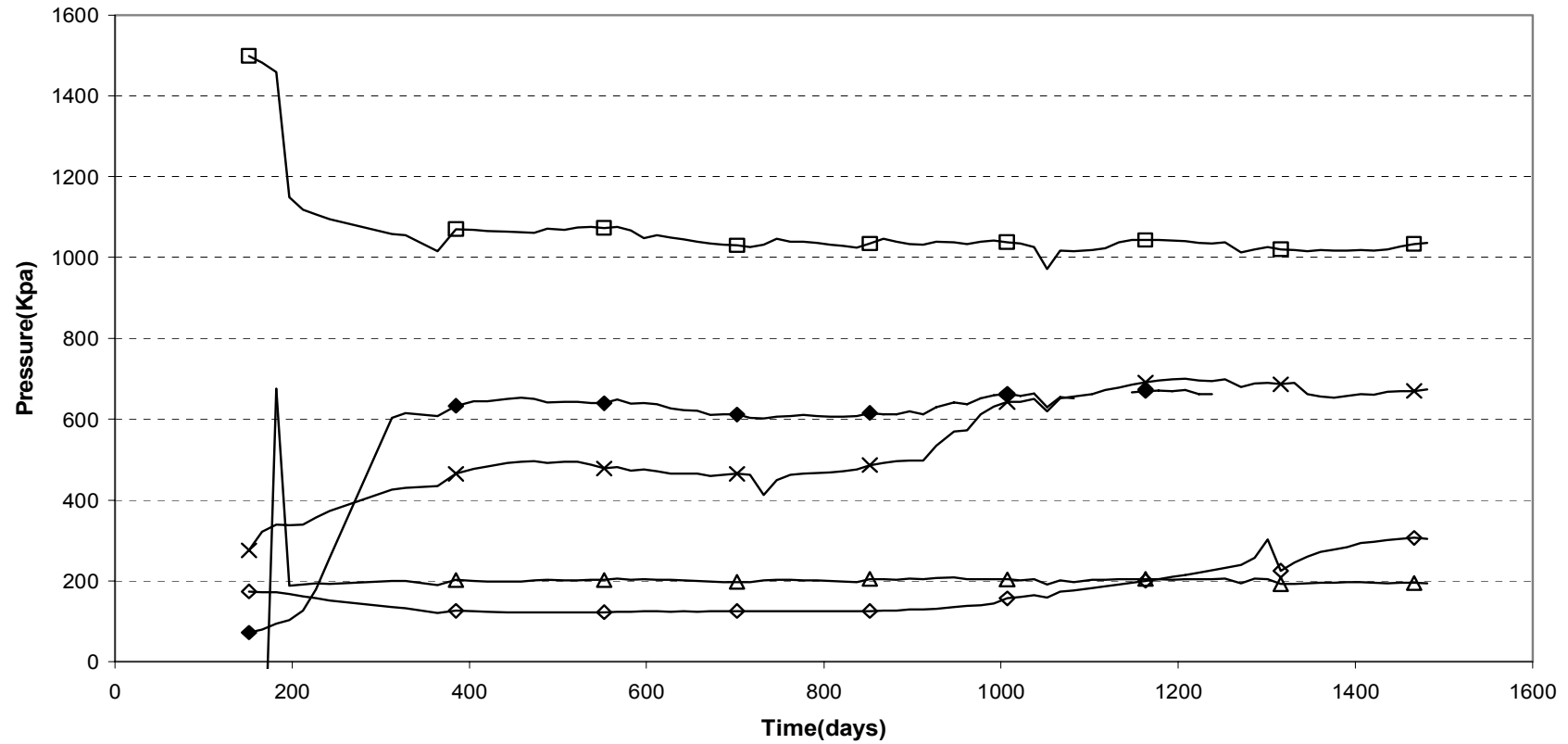

7 Quick guide

Layout of the test
 Numbering of backfill sections and permeable mats

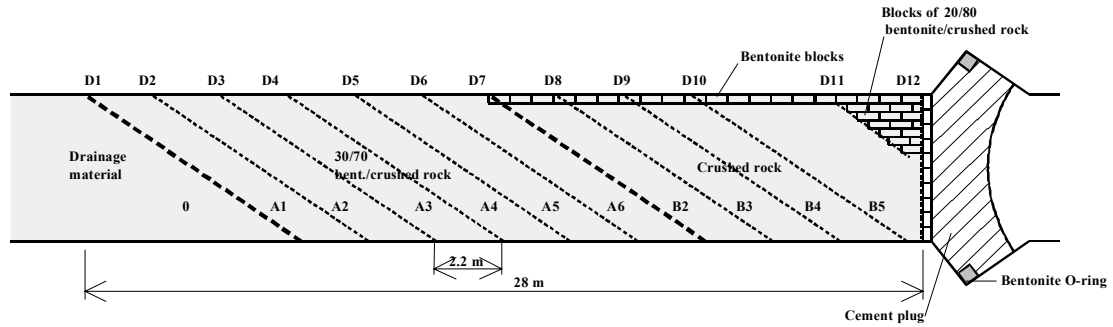

----- Drainage and deairing layers, permeable mats

Backfill transducer

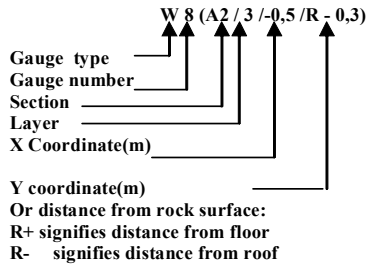

Rock transducer

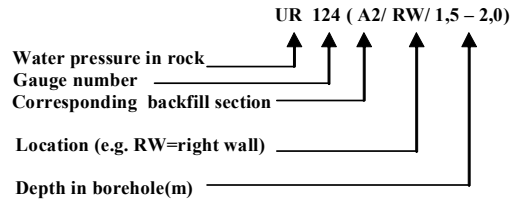

Gauge types:
 W=Water ratio
 U=Water pressure
 P=Total pressure

Co-ordinate system

