

**International  
Progress Report**

**IPR-03-14**

**Äspö Hard Rock Laboratory**

**Backfill and Plug test**

**Sensors data report  
(Period 990601-030101)  
Report No:6**

Reza Goudarzi  
David Gunnarsson  
Lars-Erik Johannesson  
Lennart Börgesson  
Clay Technology AB

January 2003

**Svensk Kärnbränslehantering AB**

Swedish Nuclear Fuel  
and Waste Management Co  
Box 5864  
SE-102 40 Stockholm Sweden  
Tel +46 8 459 84 00  
Fax +46 8 661 57 19



**Äspö Hard Rock  
Laboratory**

Report no.	No.
IPR-03-14	F61K
Author	Date
Goudarzi, Gunnarsson, Johannesson, Börgesson	03-02-28
Checked by	Date
Approved	Date
Christer Svemar	03-03-24

# Äspö Hard Rock Laboratory

## Backfill and Plug test

### Sensors data report (Period 990601-030101) Report No:6

Reza Goudarzi  
David Gunnarsson  
Lars-Erik Johannesson  
Lennart Börgesson  
Clay Technology AB

January 2003

*Keywords:* Backfill, plug, instrumentation, data, measurements, in situ, water pressure, total pressure, suction, moisture, unsaturated, bentonite, crushed rock

This report concerns a study which was conducted for SKB. The conclusions and viewpoints presented in the report are those of the author(s) and do not necessarily coincide with those of the client.

# Abstract

This report presents data from the measurements in the Backfill and Plug Test during the period 99-06-01 to 03-01-01. Water pressure in the rock is measured in 73 points, pore water pressure in the backfill is measured in 33 points, total pressure is measured in 20 points and water pressure in the drainage layers of filter mats is measured in all 12 layers. The water saturation process in the backfill is checked in 57 measuring points.

The positions of the measuring points in the backfill are related to the backfill section, the number of the compacted layer, the tunnel axis, and the rock surface. The positions of the measuring points in the rock are related to the backfill section where the hole enters and the measuring section in the borehole.

Water pressure in the mats was increased from about 50 kPa to about 500 kPa during the period 2001-10-03 to 2002-01-21 in order to reach saturation within reasonable time. The increase in water pressure had the intended effect, since the saturation rate increased and all relative humidity sensors seemed to indicate full water saturation at the turn of the year. The conclusion is that the backfill is very close to complete saturation.

Measurement of the water inflow to the neighbouring Demonstration Tunnel started 02-09-19 and the results are presented in this report. The measurements with the local permeability probes supplied and installed by Aitemin have not yet been started but the probes are measuring the pore water pressure and the results are presented in this report.



# Sammanfattning

I denna rapport presenteras data från mätningar i Backfill and Plug Test under period 99-06-01 till 03-01-01. Vattentryck i berget mäts i 73 punkter, porvattentryck i återfyllningen mäts i 33 punkter, totaltryck i 20 punkter och vattentryck i permeabla skikt av filtermattor mäts i alla 12 sektioner. Vatteninnehållet i återfyllningen mäts eller indikeras i 57 punkter.

Mätpunkternas positioner anges för återfyllningen i relation till återfyllningssektion, packningslager, tunnelcentrum och bergyta. För mätpunkterna i berget anges återfyllnings sektion som borrhållet mynnar i, var på bergytan hålet mynnar och mätsektion i borrhålet.

Vattentrycket i mattorna har ökats från ca 50 kPa till 500 kPa under perioden 2001-10-03 till 2002-01-21 för att få vattenmättnad i rimlig tid. Tryckökningen hade avsedd effekt, vattenmättnadstakten ökade och vid årsskiftet 2002 / 2003 så verkade alla psychrometerar indikera full vattenmättnad. Slutsatsen är att återfyllnaden är mycket nära full vattenmättnad.

Mätning av inflödet av vatten till en närliggande parallell tunnel (DEMO-tunneln) startade 2002-09-19 och resultaten presenteras i denna rapport. Mätningarna av lokal permeabilitet som görs av Aitemin har inte startats ännu men porvattentrycket registreras och presenteras i denna rapport.



# Contents

<b>1</b>	<b>INTRODUCTION</b>	<b>9</b>
<b>2</b>	<b>COMMENTS</b>	<b>11</b>
2.1	General	11
2.2	Total Pressure, Glötzl	11
2.3	Total pressure, Roctest	12
2.4	Suction, Wescore Psychrometers	12
2.5	Resistivity, resistivity probe	13
2.6	Indication of saturation, CT tube	13
2.7	Pore water pressure in backfill, Glötzl	13
2.8	Pore water pressure in the backfill, Druck	13
2.9	Water flow into permeable sections	14
2.10	Water pressure in permeable mats, Druck	14
2.11	Water flow past the plug	14
2.12	Water flow from the inner part of the drift.	15
2.13	Water flow into neighbouring drifts	15
2.14	Water pressure in the rock, Druck	15
2.15	Pore water pressure in section A4, Local permeability probes	15
<b>3</b>	<b>GEOMETRY</b>	<b>17</b>
<b>4</b>	<b>LOCATION OF INSTRUMENTS IN THE BACKFILL</b>	<b>19</b>
4.1	Brief description of the instruments	19
4.2	Strategy for describing the position of each device	20
4.3	Position of each instrument in the backfill	23
<b>5</b>	<b>LOCATION OF INSTRUMENTS IN THE ROCK</b>	<b>27</b>
5.1	Brief description of the instruments and the packers	27
5.2	Position of each measuring section	27
<b>6</b>	<b>DATA FROM MEASUREMENTS</b>	<b>31</b>
	Total pressure, Glötzl	33
	Total pressure, Roctest	35
	Suction, Wescore Psychrometers	36
	Resistivity, resistivity probes	40
	Pore water pressure, Glötzl	42
	Pore water pressure, Druck	46
	Flow into permeable sections	48
	Water pressure in permeable sections	49
	Water flow past the plug	51
	Water flow from the inner part of the tunnel	52
	Water flow into neighbouring drifts	53
	Water pressure in the rock	54
	Water pressure in the backfill, local permeability probes	70
	Location of local permeability probes	72
<b>7</b>	<b>QUICK GUIDE</b>	<b>73</b>





# 1 Introduction

The installation of the Backfill and Plug Test was made during spring 1999. The different measurements started at different times as the transducers were connected to their data acquisition systems. In this report the data acquired until 2003-01-01 are presented. In general the data in this report are presented in diagrams covering the time period 1999-06-01 to 2003-01-01. The time axis in the diagrams represents days from 1999-06-01 except for readings from the flow meters.

A Test overview with the positions of the permeable sections, the positions of the measuring points and a brief description of the instruments is also included in this report. A quick guide to the positions of all instruments in the backfill that can be unfolded to A3 format is enclosed as the last page. Explanation of denominations is presented in Chapter 4.

General comments concerning the collection of the data are also given.



## 2 Comments

### 2.1 General

In this chapter short comments on general trends in the measurements are given. Sensors that are not delivering reliable data or no data at all are noted and comments on the data collection in general are given.

The fifth report covered the period up to 020701. This report is the sixth one and covers the results up to 030101, which corresponds to day 1310 on the time axis in the diagrams.

The plug was grouted on June 27 2001 and the water pressure in the permeable mats and in the drained inner part of the drift was increased in steps of 100 kPa to 500 kPa at the following times:

100 kPa: 2001-10-03 (day 854)

200 kPa: 2001-11-14 (day 896)

300 kPa: 2001-11-28 (day 910)

400 kPa: 2001-12-10 (day 922)

500 kPa: 2002-01-21 (day 965)

### 2.2 Total Pressure, Glötzl

Data are presented on pages 33-34.

After repairing the Data Acquisition System (DAS) it was re-installed (day 1061) and has been working well since. The reason for the breakdown was most probable that saltwater leaked through tubes from two gauges and into the oil tank of the oil pump. The salt corroded the oil pump and caused it to break down. The leaking gauges U1 and U3 were located and plugged.

As an effect of the increase in saturating water pressure the registered total pressure increased accordingly.

All pressure cells seem to work well except for P58 that has never been connected to the DAS and P59 that was disconnected after the first DAS breakdown. Only one cell in section A (P2) yields a higher total pressure than what corresponds to the own weight of the backfill plus applied water pressure. In section B most cells yield a higher pressure due to swelling of the bentonite blocks at the roof.

## 2.3 Total pressure, Roctest

Data are presented on page 35.

All cells seem to deliver reliable data except P51, which stopped functioning at the end of the latest measuring period. The same trends can be observed as for the Glötzl cells; higher pressure is registered in the B section. All of the sensors, except for P61 that has increased from 600 to 770 kPa, have been stable ever since the increase in saturating water pressure to 500 kPa.

## 2.4 Suction, Wescore Psychrometers

Data are presented on pages 36-39.

The Psychrometers are mainly placed in the 30/70 backfill. The exceptions are W67 and W77 that are placed in the 0/100 backfill, and W83 and W84 that are placed among the bentonite blocks in B6. In the first material the water saturation was quick and the psychrometers were drowned. The psychrometers are not designed for measuring suction in the latter material until very close to water saturation. Data from the sensors in these materials are not presented in this data report.

The suction of 30/70 is about 3000 kPa at the initial water content and decreases with increasing degree of saturation. At complete saturation the suction is about 1000 kPa or lower.

The measured values show that most sensors behave in a rational manner indicating that they function in a proper way. The following exceptions can be noted:

1. At some periods the scatter of measured values is rather high for a few transducers, especially at a period around 400 days. Some of this scatter is probably caused by outer disturbances. The problems have been overcome and good results are received after that period.
2. When the backfill is water saturated the transducers may give unreliable measurements, especially if free water has entered. This would explain the scatter in the late measurements of some transducers. The readings from sensors after the backfill has been saturated are not presented in the diagrams

All sensors but one (w25) indicate water saturation.

In general the readings from the psychrometers have been logical. The sensors placed in the layer closest to the permeable mats and close to the rock were the first to indicate an increase in water ratio and saturation. After this water saturation was indicated by the sensors placed two layers from the saturating mats and finally, in the readings presented in this report, all but one of the sensors placed three layers from the saturating mats indicate saturation. The conclusion is that the 30/70 backfill is very close to full saturation.

The effect of the increase in saturating water pressure in the permeable sections during the time period 2001-10-03 to 2002-01-21 can be observed for all of the sensors that were still delivering data.

## **2.5 Resistivity, resistivity probe**

Data are presented on pages 40-41.

The purpose of using resistivity probes is to measure change in water content and to indicate when the bentonite free backfill (0/100) is saturated. Seven of the nine probes were installed in the 0/100 and the other two were installed in section A6. The probes were not originally designed for the 30/70 backfill. It has not been possible to evaluate the readings from the two probes placed in this material and the data from these are not presented.

The effect of the stepwise increase in water pressure is registered as a decrease in resistivity, which indicates that the 0/100 backfill was not completely water saturated before the pressure increase. The curves seem to approach the resistivity 10-30  $\Omega\text{m}$ , which correspond to full saturation. This means that the 0/100 backfill is close to saturation in all the measuring points except perhaps one. W72, W73 and W 74 have failed.

## **2.6 Indication of saturation, CT tube**

No water has come through the tubes placed in the 30/70 backfill. In the 0/100 backfill all CT tubes have carried water all the way to the measuring house and have been plugged.

## **2.7 Pore water pressure in backfill, Glöztl**

Data are presented on pages 42-45.

After repairing the data acquisition system it was re-installed (day 1061) and has been working well since. U1 and U3 has been disconnected and plugged since they leaked water to the Data Acquisition System. All of the remaining sensors but two, U15 and U17, deliver logical readings. Both U15 and U17 are placed close to the roof and indicate water pressures that are considerably higher than the pressure applied in the permeable sections. A pressure increase is seen in some of the sensors in the end of the measuring period. This increase is not seen in any other type of sensors and has not yet been explained.

## **2.8 Pore water pressure in the backfill, Druck**

Data are presented on pages 46-47.

The principle of this measurement is to lead water from the test volume to the measuring house in a tube, connect it to the Druck transducer and measure the pressure.

So far water has come through from measuring points U13, U 52,U5 and U23 in the 30/70 backfill (no water in 4 out of 8 points) and through U53, U55,U58,U54,U57 and U56 in the 0/100 backfill (all points). There are also two measuring points among the

blocks and pellets in section B6, no water has come through these. The readings from all of the 10 connected pore water pressure cells correspond quite well to the increase in saturating water pressure.

The pressure readings from the Druck transducers are related to the Z co-ordinate of the transducer in the measuring house. They are placed 0.5 – 1.5 m. below the centre point of the tunnel.

## **2.9 Water flow into permeable sections**

Data are presented on page 48.

Water flow into the permeable sections is only measured by four flow meters, which means that several mats were connected to the same flow meter in different patterns during the first year. The flow data on page 36 is presented as flow to the different mats for the constellation after 340 days after which the same constellation has been used. Since there is flow out through the plug and there is also a free connection to the inner drained part of the drift, the measured flow does not tell anything about the water mass balance in the backfill at this stage.

## **2.10 Water pressure in permeable mats, Druck**

Data are presented on pages 49 and 50.

The pressures in the permeable layers are measured in the tubes leading to the centre positions of the centre mats. The pressure is related to the Z co-ordinate of the Druck pressure transducers in the measuring house. This corresponds well with the Z co-ordinate of the centre line of the tunnel. Since the tunnel is slightly inclined the centre point is about 3 dm above the level of the Druck sensors in D1 and about 1 dm below the sensors in D10.

The measured pressure in the mats in the 0/100 backfill reflects very well the stepwise water pressure increase, while the response in two mats in the 30/70 backfill is lower than expected.

## **2.11 Water flow past the plug**

Data are presented on page 51.

The water is collected in a sump outside the plug. Once a day the water is pumped from the sump through a flow meter and the volume and time is registered.

The measurement of water flow past the plug started 02-10-08 (day 860). At this time the water pressure behind the plug was 100 kPa. Each time the water pressure behind the plug was increased the flow past the plug increased substantially only to, in a short time, decrease to a level close to the one before the pressure increase. The flow past the plug was about 0.02 l/min when the pressure behind the plug was 100 kPa. When the pressure was raised to 500 kPa the flow past the plug increased to 0.05 l/min and has since decreased at a slow rate. The flow past the plug was about 0.03 l/min in the end of 2002.

## **2.12 Water flow from the inner part of the drift.**

Data are presented on page 52.

The flow from the inner part is high, about 1,5 l/min. Compared to the flow injected in the permeable sections and the flow past the plug and it is irregular.

In order to keep the water pressure at a constant level one of the tubes leading water from the inner part of the drift is led higher up in the tunnel to an open vessel so that the difference in elevation together with the flow resistance in the pipe amounts to the desired water pressure (500 kPa). From the open vessel the water is led through a flow meter and the volume and time is registered.

## **2.13 Water flow into neighbouring drifts**

The water flow into the neighbouring demonstration drift started 02-09-19 and is presented on page 53.

## **2.14 Water pressure in the rock, Druck**

Data are presented on pages 54-69.

The pressure in the bore holes range from 0 to 3300 kPa. The highest pressures are found in the long boreholes. The pressure in the short bore holes in general range from 0 to 600 kPa. The exception is UR63 (left wall in section A1) that shows a pressure of 1600 kPa.

It is interesting to study the reaction of the water pressure increase in the mats on the measured pressure in the boreholes. All short boreholes in the floor yield immediate response and thus have a direct connection with the tunnel except for UR42, which is situated in the carefully blasted part (section 0). Most of the short boreholes in the roof and walls of the tunnel also yield a quick response to the pressure increase in the tunnel.

One sensor, UR168 seems to have stopped working during the period since the previous report.

## **2.15 Pore water pressure in section A4, Local permeability probes**

Data are presented on pages 70-71 and the positions of the sensors are given on page 72.

The readings represent absolute pressure and this means that the readings should be reduced with 100 kPa when comparing to other pressures presented in the report. The sensors showing zero pressure are thus probably out of order.





### 3 Geometry

The backfilled part is divided into backfill sections separated by drainage layers of permeable mats. The backfill sections are named 0, A1-A6 and B2-B6 and the mats are named D1-D12 according to Fig 3-1.

#### ÄSPÖ HARD ROCK LABORATORY- BACKFILL AND PLUG TEST IN ZEDEX DRIFT

##### Layout of the test

##### Numbering of backfill sections and permeable mats

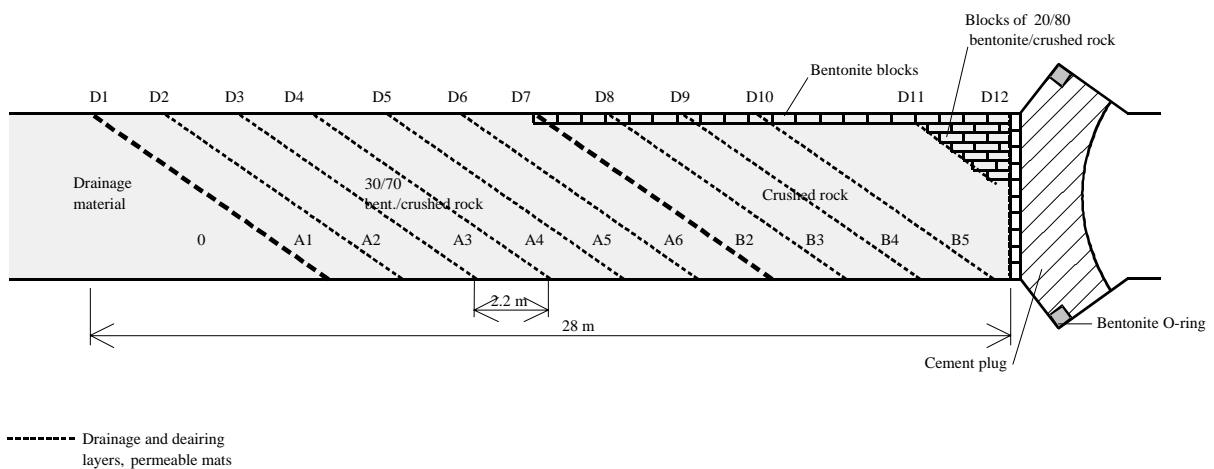

**Figure 3-1.** Numbering of backfill sections and drainage layers (permeable mats).

The permeable mats have been placed according to Fig 2-2. If the tunnel is supposed to be cylindrical the sections are elliptical with the large axis 8.7 m and the small axis 5.0 m. The tunnel axis is made the centre of a co-ordinate system with  $x$  and  $y$  co-ordinates. The drainage layer is divided into 3 parts with one upper, one central and one lower filter.

- The upper filter starts at  $y=3.3$  m and fills the tunnel above that level. At the contact with the rock 0.2 m of filter mat is folded and attached to the rock surface in order to have a good hydraulic interaction with the rock.
- The central filter is placed at  $-2.5 < y < 3.0$  and  $-2.2 < x < 2.2$  as shown in Fig 3-2. The central filters have at least 0.3 m distance to the walls otherwise it has been cut to fulfil that demand.
- The lower filter has been placed between  $y=-2.8$  and the floor with 0.2 m folded and attached to the floor. Since the floor is horizontal the ellipse is cut at about  $y = -3.85$ .

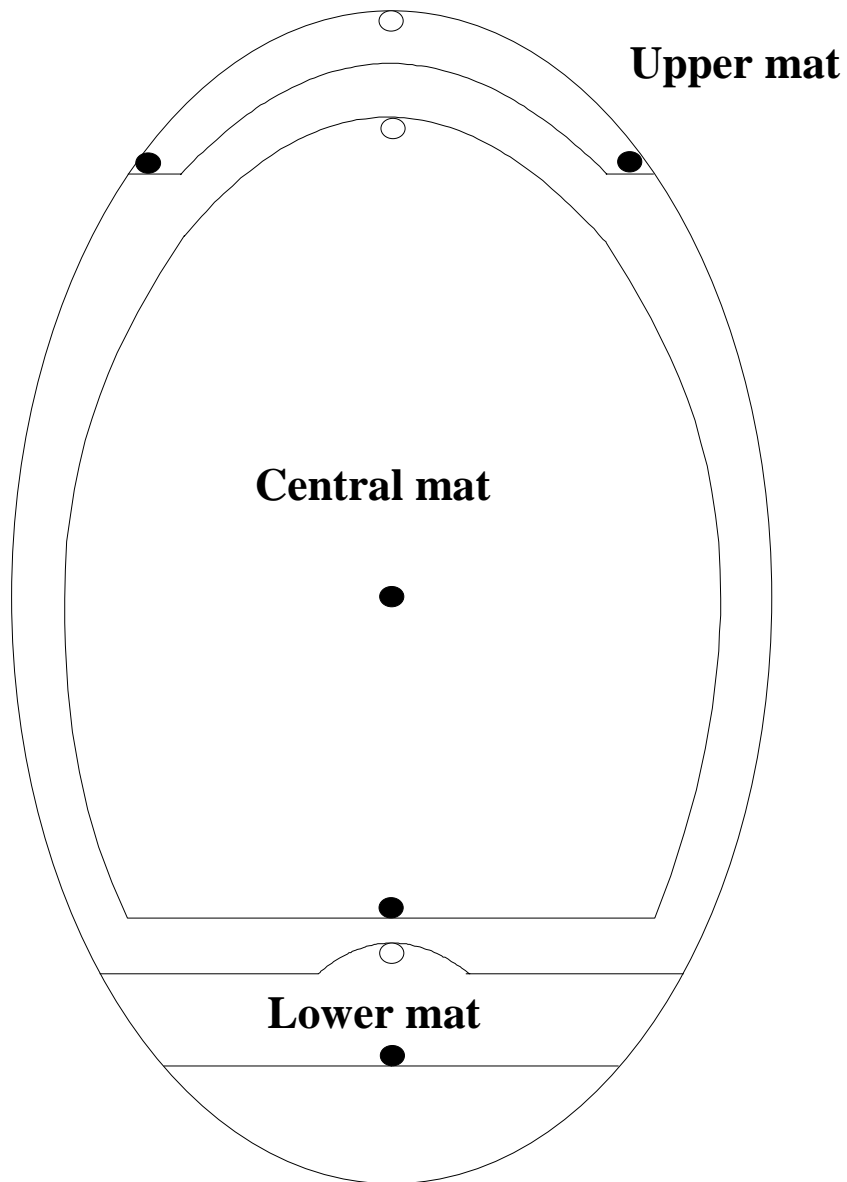

**Figure 3-2.** Location of the filters in a drainage layer.

Drainage layer D01 and D11 does not reach the floor. The central filter is cut 0.3 m from filter D12. Drainage layer D12 is made as the circular projection of the other drainage layers.

## **4 Location of instruments in the backfill**

### **4.1 Brief description of the instruments**

The different instruments that are used for measurements in the backfill are briefly described in this chapter.

#### **4.1.1 Measurement of total pressure in the backfill**

Total pressure is the sum of the swelling pressure (or effective stress) and the pore water pressure. It is measured with the following two instrument types:

- Glötzl total pressure cells of the hydraulic type. Two models have been used: E 10/20 KF 50 VA24 model A (Glötzl A) and model F (Glötzl B). The measuring range is 0-5 MPa. Type A is used for measurement in the soil while type B will be fixed to the rock surface with concrete. 9 cells of type A and 4 cells of type B are installed.
- Roctest total pressure cell with vibrating wire transducer model TPC-0 (0-4 MPa). 8 cells of this type are installed in the backfill.

#### **4.1.2 Measurement of pore water pressure in the backfill**

The pore water pressure in the backfill is measured with the following two instrument types:

- Glötzl pore pressure cells of the hydraulic type. 18 pore pressure cells of model P4 S 50L VA with the measuring range 0-5 MPa are installed.
- Filter tips connected to Druck pore water pressure cells model PTX 1400 with tecalan tubes. The pore water pressure cells are located outside the test area. 16 devices with the measuring range 0-4 MPa are installed.

#### **4.1.3 Measurement of the water saturation process in the backfill**

The water saturation process is followed by the following three different techniques:

- Wescor psychrometers model PST-55. These devices measure the relative humidity in the pore system, which can be converted into water ratio or total suction (negative water pressure). The measuring range is 95.5-99.6 RH corresponding to the pore water pressure -0.5 to -6 MPa or the water ratio 11-25% of backfill with the composition 30/70 bentonite/ballast mixture. 27 psychrometers have been installed.

- Resistivity probes developed and built by Clay Technology and the University of Lund are used in the bentonite free backfill. The measuring principle is to apply an electrical current between two outer electrodes with the relative distance 30 cm and measure the drop in potential between two inner electrodes with the relative distance 10 cm. The devices have been calibrated for different densities and water ratios of the backfill intended to be used. The measuring range is water ratios between 5 and 12%. 10 devices are installed.
- Filter tips connected to thin tecalan tubes. These filters, which mainly have been installed in the bentonite free backfill, are simple devices for indicating when water saturation has occurred in the measuring point.

#### 4.1.4 Measurement of temperature

Since no heat is generated in the experiment, temperature can be measured in two points for the purpose of general information. Thermocouples of type K from Heraeus Electro-Nite AB have been used. Temperature can also be measured by the psychrometers and by the devices for measuring hydraulic conductivity installed by Aitemin (ENRESA).

#### 4.1.5 Other measurements

After water saturation local hydraulic conductivity will be measured in section A4 with devices developed and installed by Aitemin in 13 points. The sensors also register the pore water pressure.

### 4.2 Strategy for describing the position of each device

Each instrument is named with a short unique name consisting of 1-2 letters describing the type of measurement and 1-3 figures numbering the device. In addition to the name a short description of the position is added.

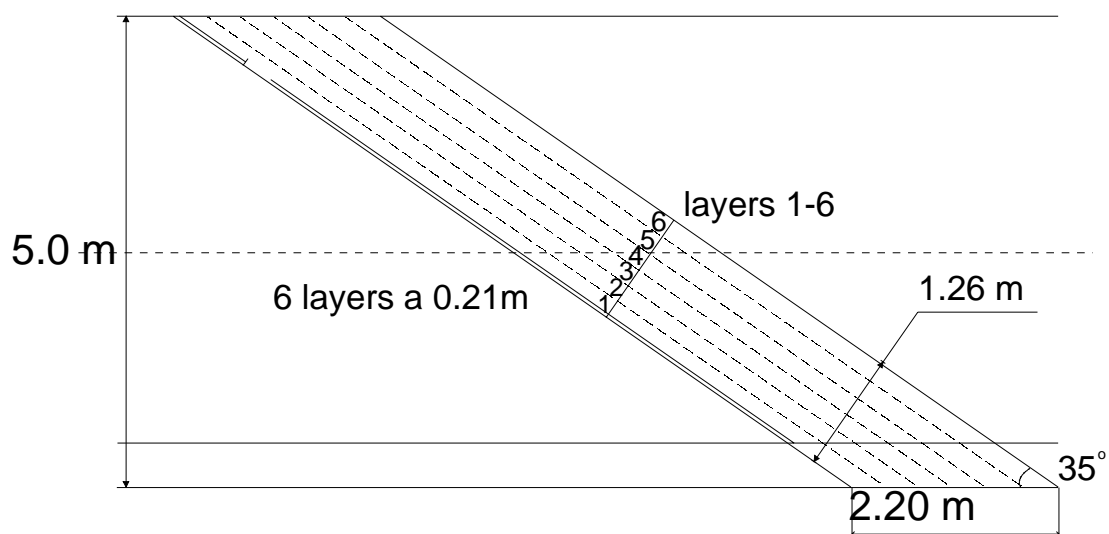

*Figure 4-1. Subdivision of a backfill section into backfill layers.*

The sections, separated by drainage layers, were shown in Fig 1-1. Sections A1-A6 and B2-B4 are divided into 6 layers with the thickness 0.21 m according to Fig 4-1. Each layer corresponds to one compaction sequence, which means that the backfill will be placed with a thickness before compaction that yields a thickness after compaction of 0.21 m. The layers are numbered 1-6.

The instruments have been placed in the layers after compaction and are related to those layers. Each measuring point is also defined by the co-ordinates in the layer in a co-ordinate system equal to the one shown in Fig 4-2. The  $x$ -coordinate is the horizontal distance from the centre of the tunnel and the  $y$ -coordinate is the distance perpendicular to the  $x$ -axis. Some of the instruments are more important to place at a specified distance from the rock surface. For those cases the co-ordinate begins with the letter R and is given the co-ordinate with the intersection with the rock surface as centre. An instrument in the backfill will thus be named in the following way:

1. Type of measurement (1 letter)
2. Serial number (1-2 figures)
3. Section (1 letter, 1 figure)
4. Layer (1 figure)
5.  $x$ -coordinate
6.  $y$ -coordinate

Items 1 and 2 identifies the device and items 3-6 describes the location. A pore water pressure transducer (number 8) located in section A2, layer 3, 0.5 m left of the centre line and 0.3 m below the roof in the  $y$ -direction will be named:

W8 (A2/3/-0.5/R-0.3)

## Instrument locations

Sections A & B

Layers 1-6

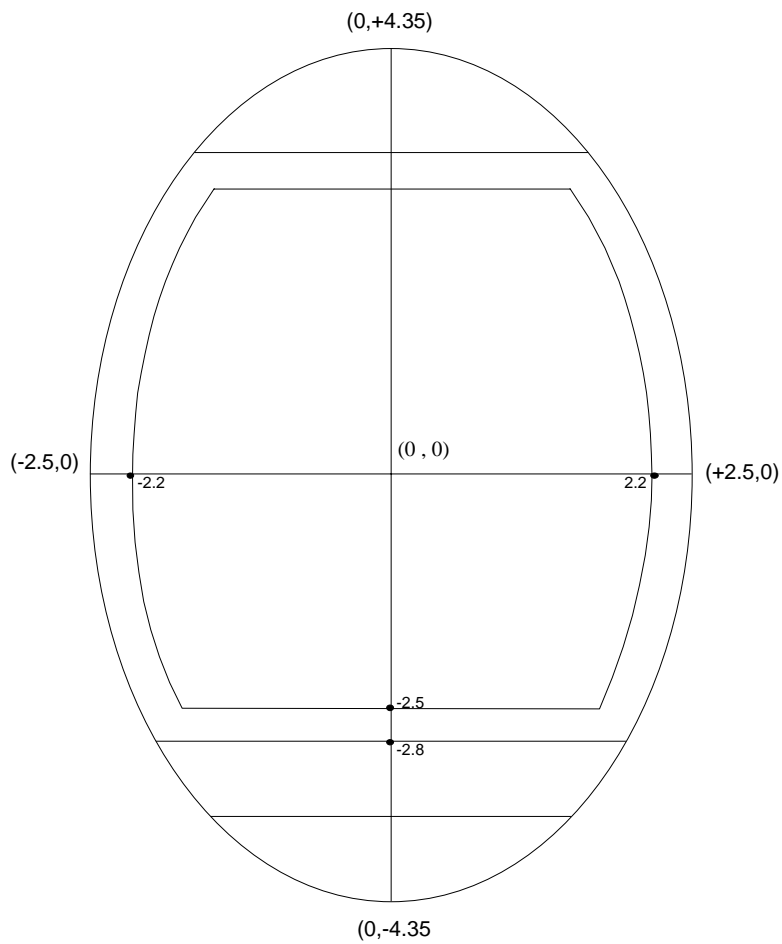

*Figure 4-2. Co-ordinate system for measuring point in each sections and layers*

### 4.3 Position of each instrument in the backfill

All instruments are placed in layers 1-4 in order to leave the two upper layers unaffected by transducers and cables. Another reason is that the entrance plate where the tubes are attached to the through connections are placed in layers 1-4, which means that the two final layers could be compacted without considering the problems of compacting around the through connections.

The positions of the instruments (the positions of ENRESA's hydraulic conductivity devices are shown on page 64) are described in Tables 4-1 to 4-4.

**Table 4-1 Numbering and position of instruments for measuring total pressure**

Type and number	Section	Layer	X	Y	Fabricate	Remarks
P1	A3	1	0	R+0.2	Glötlz A	Horisontal
P2	A1	5	0	R-1.1	Glötlz A	Parallel
P3	A2	3	0	0,6	Rocktest	Parallel
P4	A2	3	0	R+0.65	Rocktest	Parallel
P5	A2	1	0	R-0.2	Rocktest	Parallel
P6	A2	6	0	-3,15	Glötlz A	Horisontal
P7	A4	3	0	R-0	Glötlz B	At rock
P8	A4	3	0	R+0	Glötlz B	At rock
P9	A5	3	0	R-0.2	GlötlzA	At rock
P51	A6	3	0	R-0.3	Rocktest	Under blocks
P52	B2	3	0	R-0	Glötlz A	Under blocks
P53	B2	3	0	0,2	Glötlz B	Horisontal
P54	B2	6	0	-2,78	Rocktest	Horisontal
P55	B3	3	0	0,3	Glötlz A	Parallel
P56	B3	3	0	R+0.65	Glötlz A	Parallel
P57	B2	7	0	R+1.1	Rocktest	Parallel
P58	B4	3	0	R-0	Glötlz A	Under blocks
P59	B3	5	0	R-1.1	Glötlz A	Parallel
P60	B4	1	0	R-0.2	Rocktest	Parallel
P61	B6	10	0	R-0	Rocktest	Between blocks
P62	B6	10	0	P	Glötlz B	At wall

**Table 4-2 Numbering and position of instruments for measuring pore water pressure (U)**

Type and number	Section	Layer	X	Y	Fabricate	Remarks
U1	A1	3	0	0,3	Glötzl	
U2	A1	3	0	3,1	Glötzl	
U3	A1	3	0	-2,6	Glötzl	
U4	A1	3	2	0	CT Tube + Druck	Twin tubes
U5	A1	3	-2	0	CT Tube + Druck	Twin tubes
U6	A2	1	0	0,3	Glötzl	
U7	A2	6	0,2	3,15	Glötzl	
U8	A3	1	0,25	-2,8	Glötzl	
U9	A1	5	-0,2	R-1.1	Glötzl	
U10	A2	3	0	0,3	Glötzl	
U11	A2	3	-0,2	R+0.65	Glötzl	
U12	A2	3	1,3	0	CT Tube + Druck	
U13	A2	3	-1,3	0	CT Tube + Druck	
U14	A2	6	-0,15	-0,1	Glötzl	
U15	A2	1	-0,2	R-0.2	Glötzl	
U16	A4	3	0	0,3	Glötzl	
U17	A4	3	0	R-0	Glötzl	
U18	A4	3	0	R+0	Glötzl	
U19	A4	3	R-0	0	Glötzl	
U20	A4	3	R+0	0	Glötzl	
U21	A5	3	0	0,3	Glötzl	
U22	A5	3	1,3	0	CT Tube + Druck	Twin tubes
U23	A5	3	-1,3	0	CT Tube + Druck	Twin Tubes
U24	A5	3	-0,2	R-0.2	Glötzl	
U51	A6	3	-0,2	R-0.3	CT Tube + Druck	Under the Blocks
U52	A6	3	-0,2	-2	CT Tube + Druck	Twin Tubes
U53	B3	1-2	0	R+0.05	CT Tube + Druck	
U54	B2	5	-0,2	R+0.2	CT Tube + Druck	marked as w66
U55	B2	6	-0,2	R+0.65	CT Tube + Druck	marked as w63
U56	B4	3	0	R-0	CT Tube + Druck	
U57	B3	5	-0,2	R-1.1	CT Tube + Druck	
U58	B4	1	-0,2	R-0.2	CT Tube + Druck	
U59	B6	10	0	R-0.05	CT Tube + Druck	
U60	B6	10	0	R-C-C	CT Tube + Druck	Twin Tubes



**Table 4-3 Numbering and position of instruments for measuring water content (W)**

Type and number	Section	Layer	X (m)	Y (m)	Fabricate	Remarks
W1	A1	1	0	0	Wescor Psychrometer	
W2	A1	3	0	0	Wescor Psychrometer	
W3	A1	5	0	0	Wescor Psychrometer	
W4	A2	1	0	0	Wescor Psychrometer	
W5	A2	3	0	0	Wescor Psychrometer	
W6	A2	4	0	0	Wescor Psychrometer	
W7	A3	1	0	0	Wescor Psychrometer	
W8	A3	3	0	0	Wescor Psychrometer	
W9	A3	3	0	2,5	CT Tube	
W10	A3	3	0	R-0.5	Wescor Psychrometer	
W11	A3	3	0	-2	CT Tube	
W12	A3	3	0	R+0.5	Wescor Psychrometer	
W13	A3	3	1,2	0	CT Tube	
W14	A3	3	R-0.3	0	Wescor Psychrometer	
W15	A3	3	-1,2	0	CT Tube	
W16	A3	3	R+0.3	0	Wescor Psychrometer	
W17	A3	4	0	0	Wescor Psychrometer	
W18	A4	1	0	0	Wescor Psychrometer	
W19	A4	3	0	0	Wescor Psychrometer	
W20	A4	4	0	0	Wescor Psychrometer	
W21	A5	1	0	0	Wescor Psychrometer	
W22	A5	3	0	0	Wescor Psychrometer	
W23	A5	3	0	2.5	Wescor Psychrometer	
W24	A5	3	0	-2	Wescor Psychrometer	
W25	A5	4	0	0	Wescor Psychrometer	
W51	A6	1	0	0	Wescor Psychrometer	
W52	A6	3	0	0	CT Res. Probe	
W53	A6	3	0	R-0.4	Ct Tube	
W54	A6	3	0	-2	Ct Tube	
W55	A6	3	-1,3	0	Ct Tube	
W56	A6	3	1,3	0	Ct Tube	
W57	A6	4	0	0	CT Res. Probe	
W58	B2	1	0	0	CT Res. Probe	
W59	B2	3	0	0	CT Res. Probe	
W60	B2	3	0	2,5	Ct Tube	
W61	B2	3	0	R-0.3	Ct Tube	Under the Blocks
W62	B2	3	0	-2	Ct Tube	
W64	B2	3	-1,3	0	Ct Tube	
W65	B2	3	1,3	0	Ct Tube	
W67	B3	1	0	0	Wescor Psychrometer	
W68	B3	3	0	0	CT Res. Probe	
W69	B3	3	0	R-0.3	CT Tube	Under the Blocks
W70	B3	3	1,3	0	CT Tube	
W71	B3	3	-1,3	0	CT Tube	
W72	B3	4	0	0	CT Res. Probe	

W73	B4	1	0	0	CT Res. Probe	
W74	B4	3	0	0	CT Res. Probe	
W75	B4	3	1,3	0	CT Tube	
W76	B4	3	-1,3	0	CT Tube	
W77	B5	2	0	0	Wescor Psychrometer	
W78	B5	5	0	0	CT Res. Probe	
W79	B5	8	0	2	CT Res. Probe	
W80	B5	8	2	2	Ct Tube	
W81	B5	8	-2	2	Ct Tube	
W82	B5	11	0	2	Ct Tube	
W83	B6	5	0	R-C-C	Wescor Psychrometer	
W84	B6	15	0	R-C-C	Wescor Psychrometer	

## **5 Location of instruments in the rock**

### **5.1 Brief description of the instruments and the packers**

Only water pressure is measured in the rock. The measurements are made in core-drilled boreholes sealed with bentonite packers with the following measuring technique:

Tecalan tubes from the packer are connected to Druck pore water pressure cells model PTX 1400. The pore water pressure cells are located in the measuring house. Measurements are made in 79 borehole sections (measuring range 0-4 MPa).

Measurements are made in 1-3 sections in the boreholes. Most of the holes are only 1 m long with 1 packer installed in the outer 0.5 m. Two tubes are lead into each measuring section for de-airing purpose. The measuring sections are sealed with packers with bentonite rings surrounded by rubber sealings.

### **5.2 Position of each measuring section**

The measuring sections are identified with two letters and 2-3 figures. The letters are U (for pore water pressure) and R (for rock). The numbers are given in the following way:

Short holes in roof: 1-12

Long holes in the roof: 101-107

Short holes in the right wall (seen from the entrance of the drift): 21-32

Long holes in the right wall: 121-129

Short holes in floor: 41-52

Long holes in the floor: 141-147

Short holes in left wall: 61-72

Long holes in the roof: 161-167

Long hole in the end of the drift: 121

Table 5-1 shows the location of the measuring section for each instrument and the corresponding bore hole number. The backfill section in where the bore hole starts is also given

Figs 5-1 and 5-2 show the location of the measuring sections in vertical and horizontal cross sections.

**Table 5-1 Numbering and positions of instruments for measuring pore water pressure in the rock**

Type and number	Location	Measuring sect. (m)	Bore hole number	Section (TC)	Fabricate	Diameter (mm)	Remarks
UR1	Roof	0.5-1.0	KZ0065I01	A1	Druck	56	
UR2	Roof	0.5-1.0	KZ0063I01	A2	Druck	56	
UR3	Roof	0.5-1.0	KZ0061I01	A3	Druck	56	Closed ?
UR4	Floor	0.5-1.0	KZ0052G01	A4	Druck	56	
UR5	Roof	0.5-1.0	KZ0057I01	A5	Druck	56	
UR6	Roof	0.5-1.0	KZ0054I01	B1	Druck	56	
UR7	Roof	0.5-1.0	KZ0052I01	B2	Druck	56	
UR8	Roof	0.5-1.0	KZ0050I01	B3	Druck	56	
UR9	Roof	0.5-1.0	KZ0048I01	B4	Druck	56	
UR10	Roof	0.5-1.0	KZ0046I01	B5	Druck	56	
UR11	Roof	0.5-1.0	KZ0043I01	B5	Druck	56	
UR12	Roof	0.5-1.0	KZ0041I01	B5	Druck	56	
UR21	Right wall	0.5-1.0	KZ0066B01	O	Druck	56	
UR22	Right wall	0.5-1.0	KZ0064B01	O	Druck	56	
UR23	Right wall	0.5-1.0	KZ0061B01	A1	Druck	56	
UR24	Floor	0.5-1.0	KZ0057B01	A2	Druck	56	
UR25	Right wall	0.5-1.0	KZ0057B01	A3	Druck	56	
UR26	Right wall	0.5-1.0	KZ0055B01	A4	Druck	56	
UR27	Right wall	0.5-1.0	KZ0053B01	A5	Druck	56	
UR28	Right wall	0.5-1.0	KZ0050B01	B1	Druck	56	
UR29	Right wall	0.5-1.0	KZ0048B01	B2	Druck	56	
UR30	Right wall	0.5-1.0	KZ0046B01	B3	Druck	56	
UR31	Right wall	0.5-1.0	KZ0044B01	B4	Druck	56	
UR32	Right wall	0.5-1.0	KZ0042B01	B5	Druck	56	
UR41	Floor	0.5-1.0	KZ0065G01	O	Druck	56	
UR42	Floor	0.5-1.0	KZ0063G01	O	Druck	56	
UR43	Floor	0.5-1.0	KZ0061G01	O	Druck	56	
UR44	Floor	0.5-1.0	KZ0059G01	A1	Druck	56	
UR45	Right wall	0.5-1.0	KZ0059G01	A2	Druck	56	One tube
UR46	Floor	0.5-1.0	KZ0054G01	A3	Druck	56	plugged
UR47	Roof	0.5-1.0	KZ0059I01	A4	Druck	56	
UR48	Floor	0.5-1.0	KZ0050G01	A5	Druck	56	
UR49	Floor	0.5-1.0	KZ0048G01	B1	Druck	56	
UR50	Floor	0.5-1.0	KZ0046G01	B2	Druck	56	
UR51	Floor	0.5-1.0	KZ0043G01	B3	Druck	56	
UR52	Floor	0.5-1.0	KZ0041G01	B4	Druck	56	

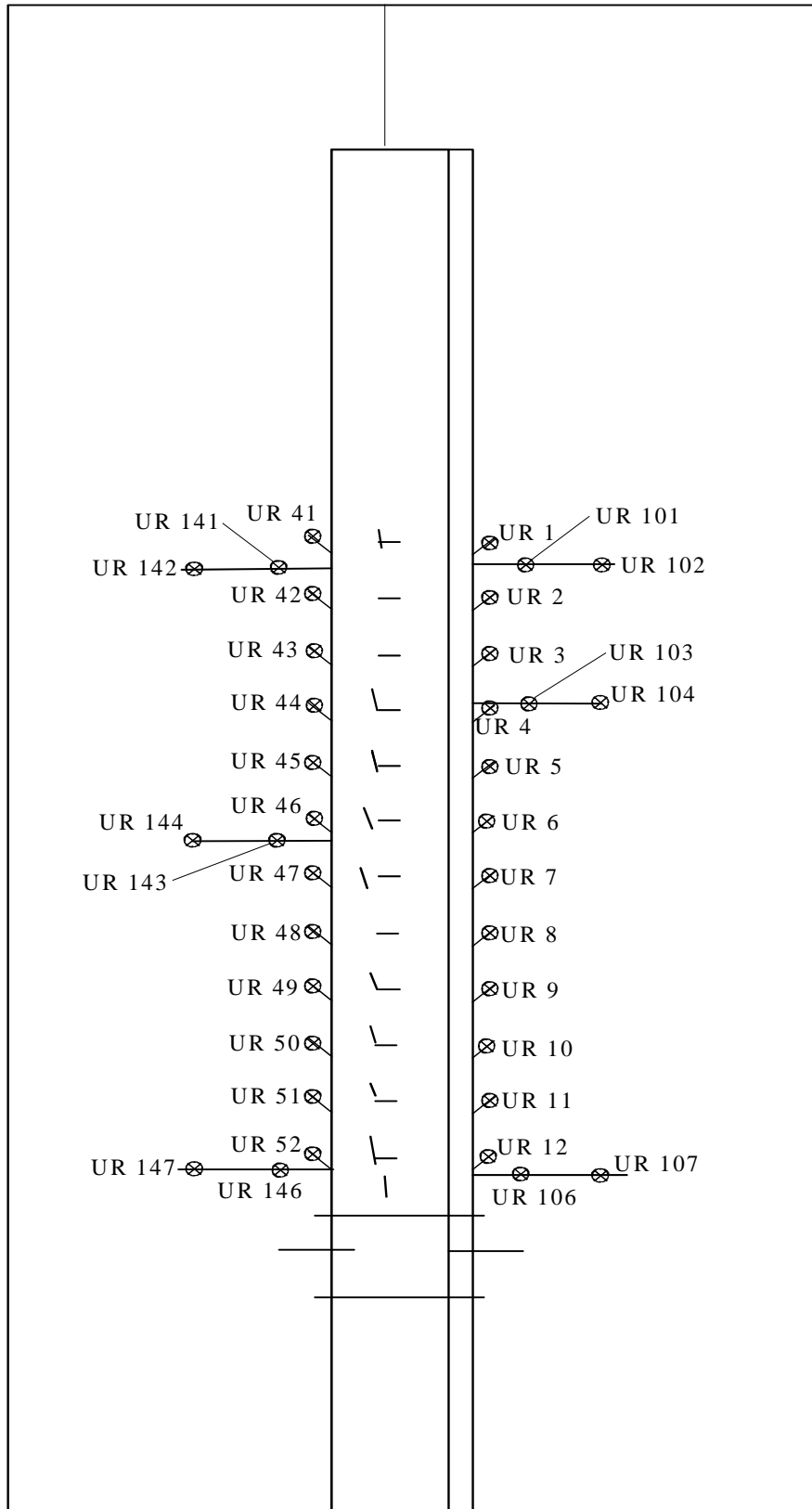

**Figure 5-1.** Position of measuring points in the boreholes of the rock in the floor (left part) and the roof. Vertical section.

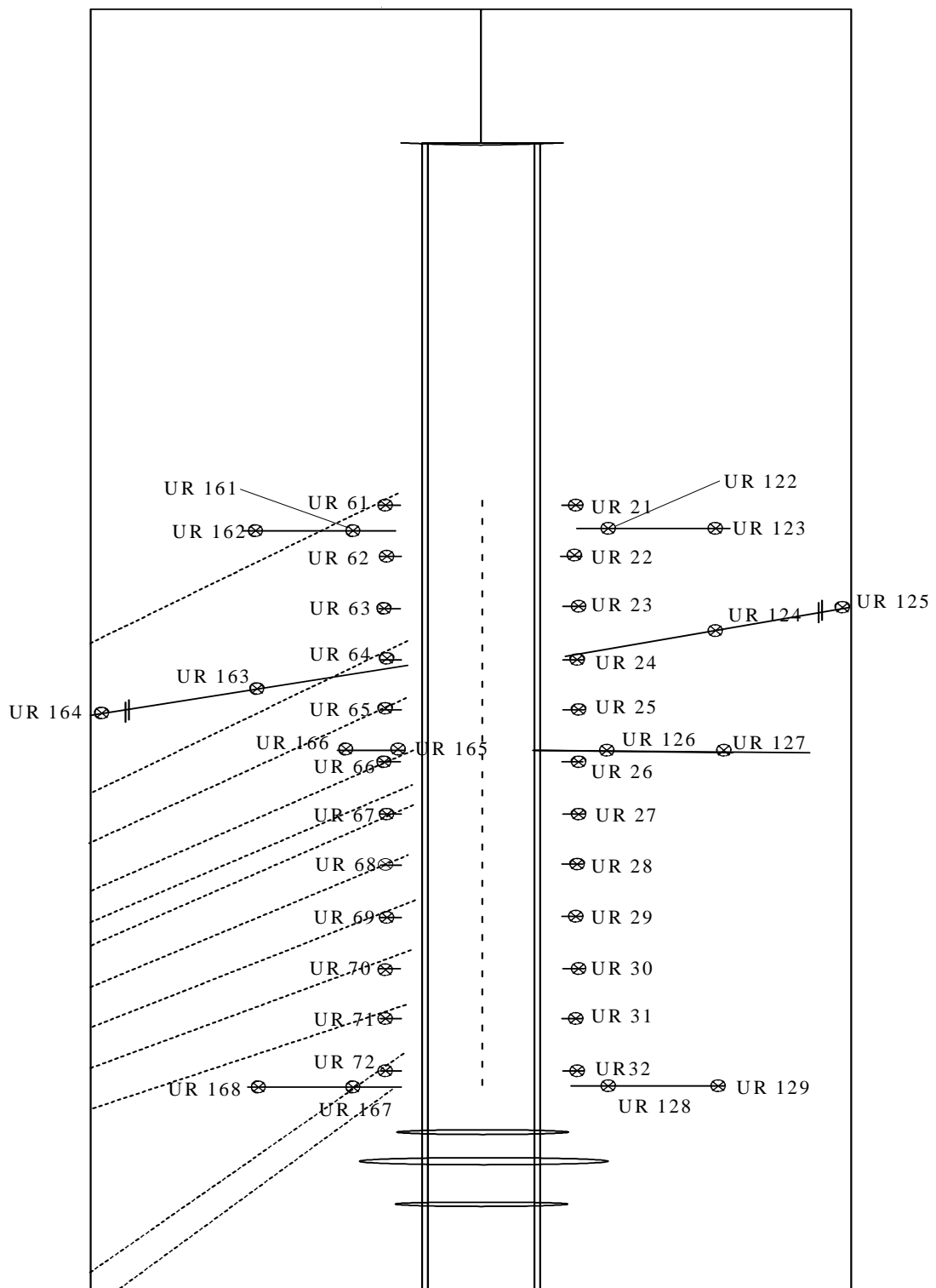

**Figure 5-2** . Position of measuring points in the boreholes of the rock in the walls.  
Horizontal section

## 6 Data from measurements





Total pressure sections B2-B6 (990601-030101)  
GLÖTZL

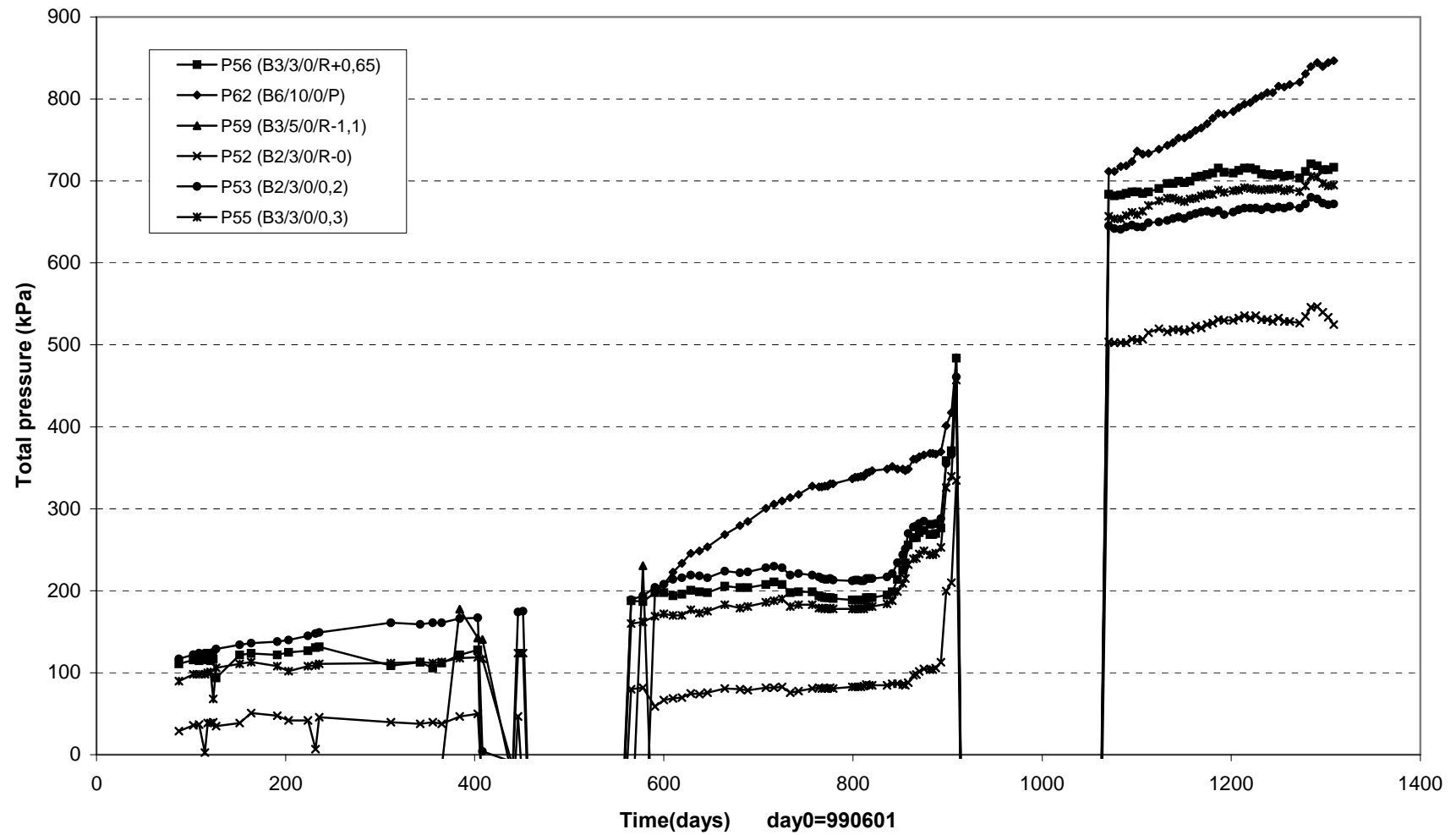

Total pressure sections A1-A5 (990601-030101)  
GLÖTZL

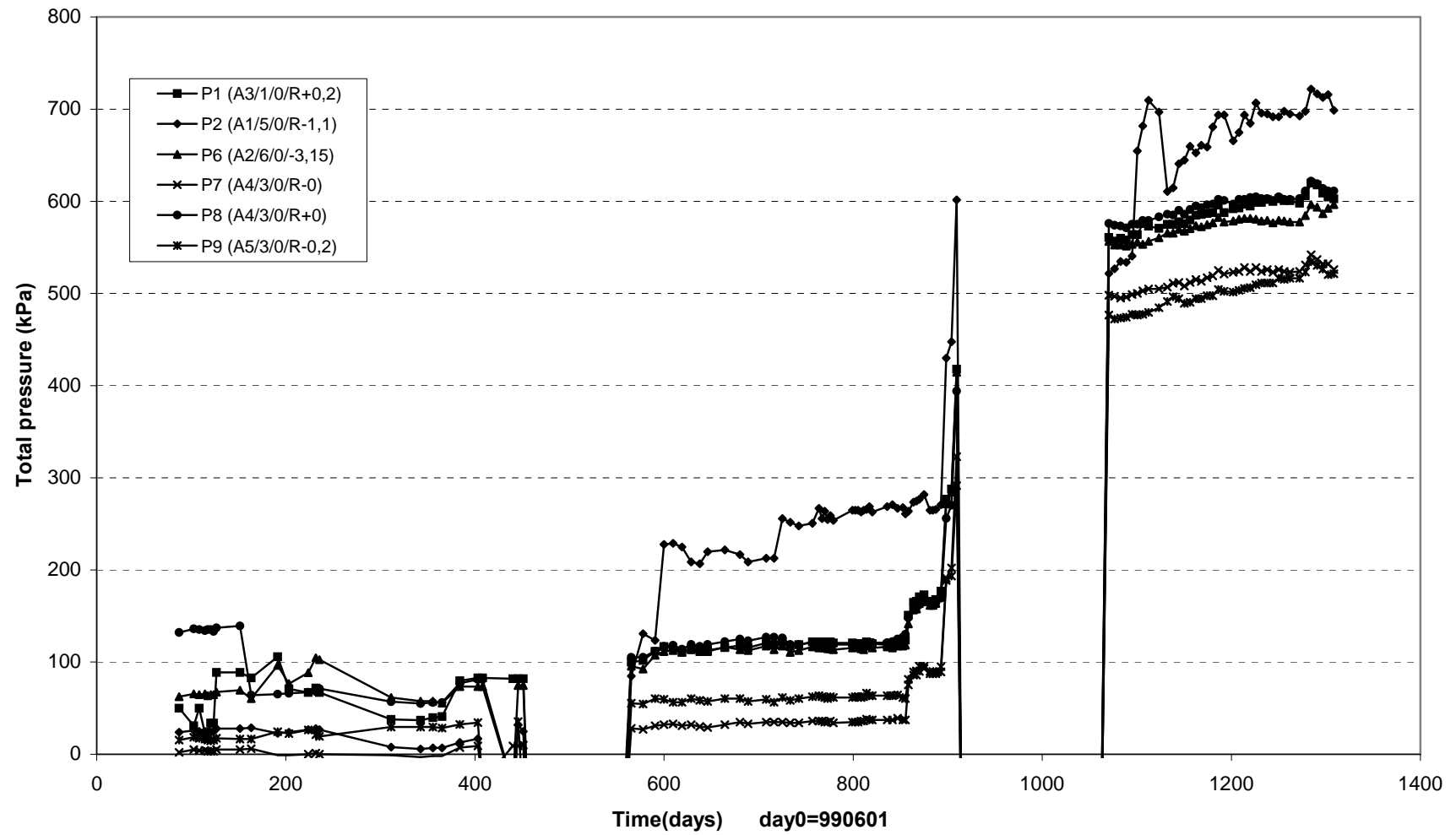

Total pressure (990601-030101)  
Rocktest

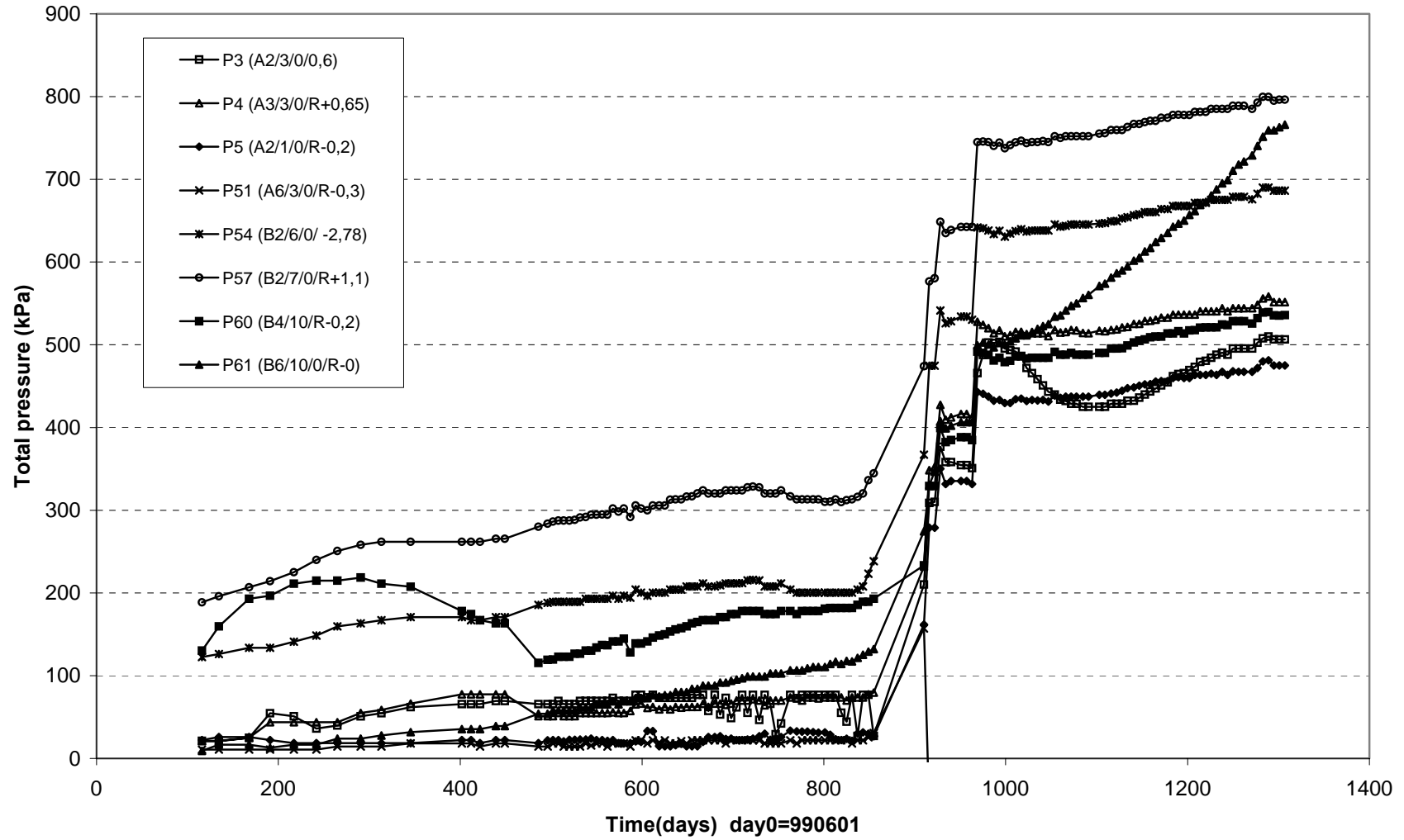

Suction in backfill sections A1&A2 (990601-030101)  
WESCOR

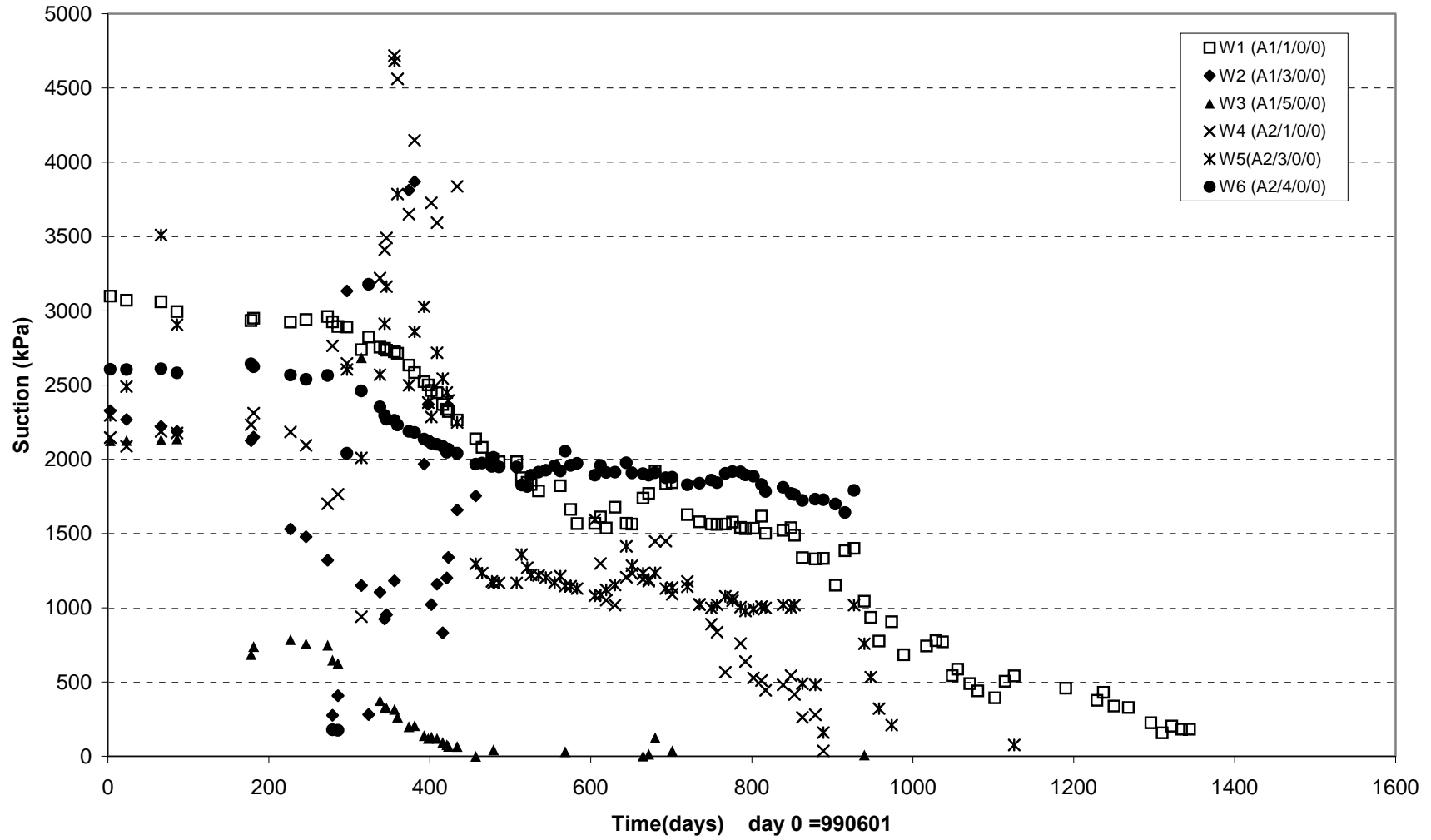

Suction in backfill section A3 (990601-030101)  
WESCOR

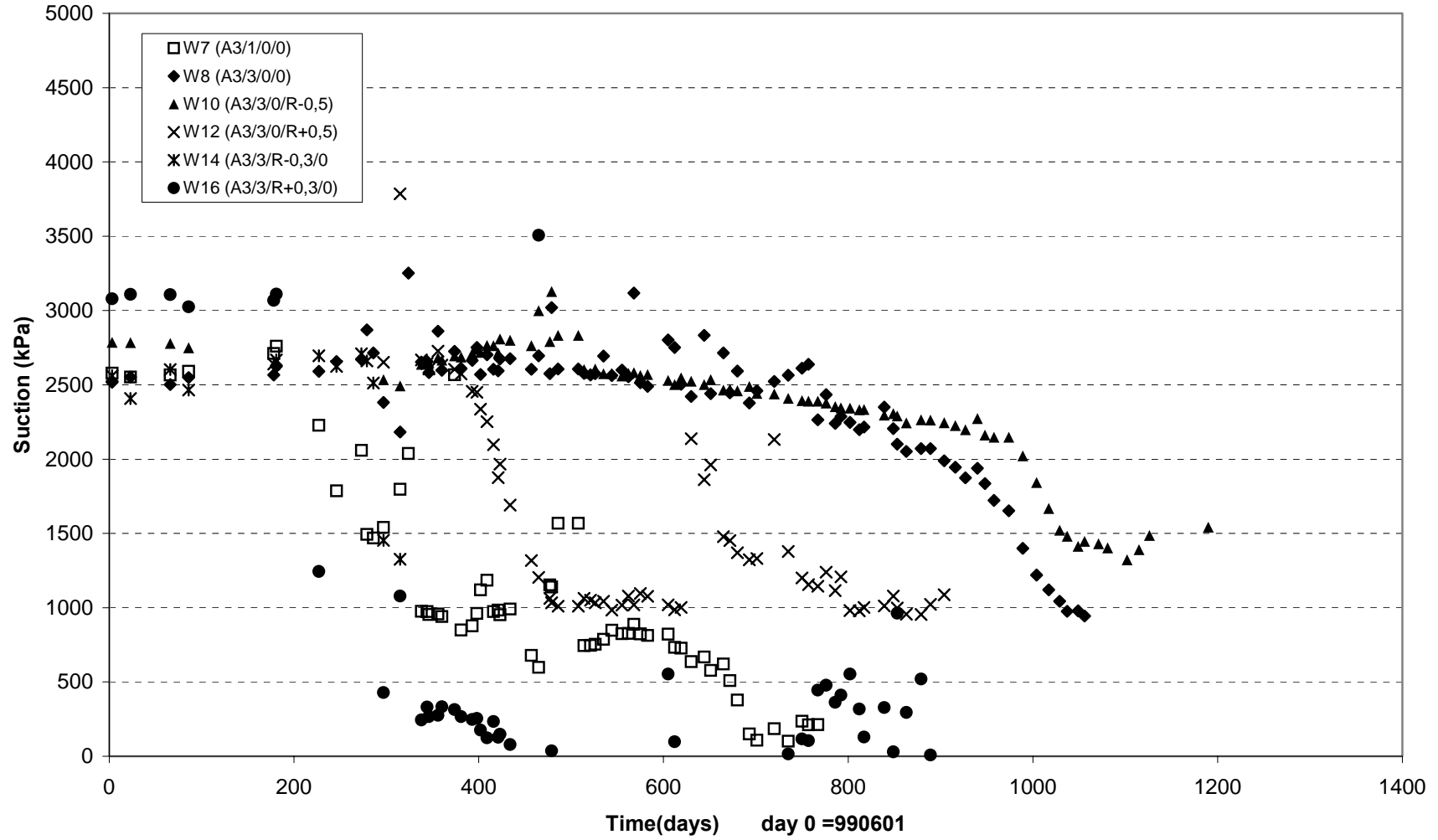

Suction in backfill sections A4&A5 (990601-030101)  
WESCOR

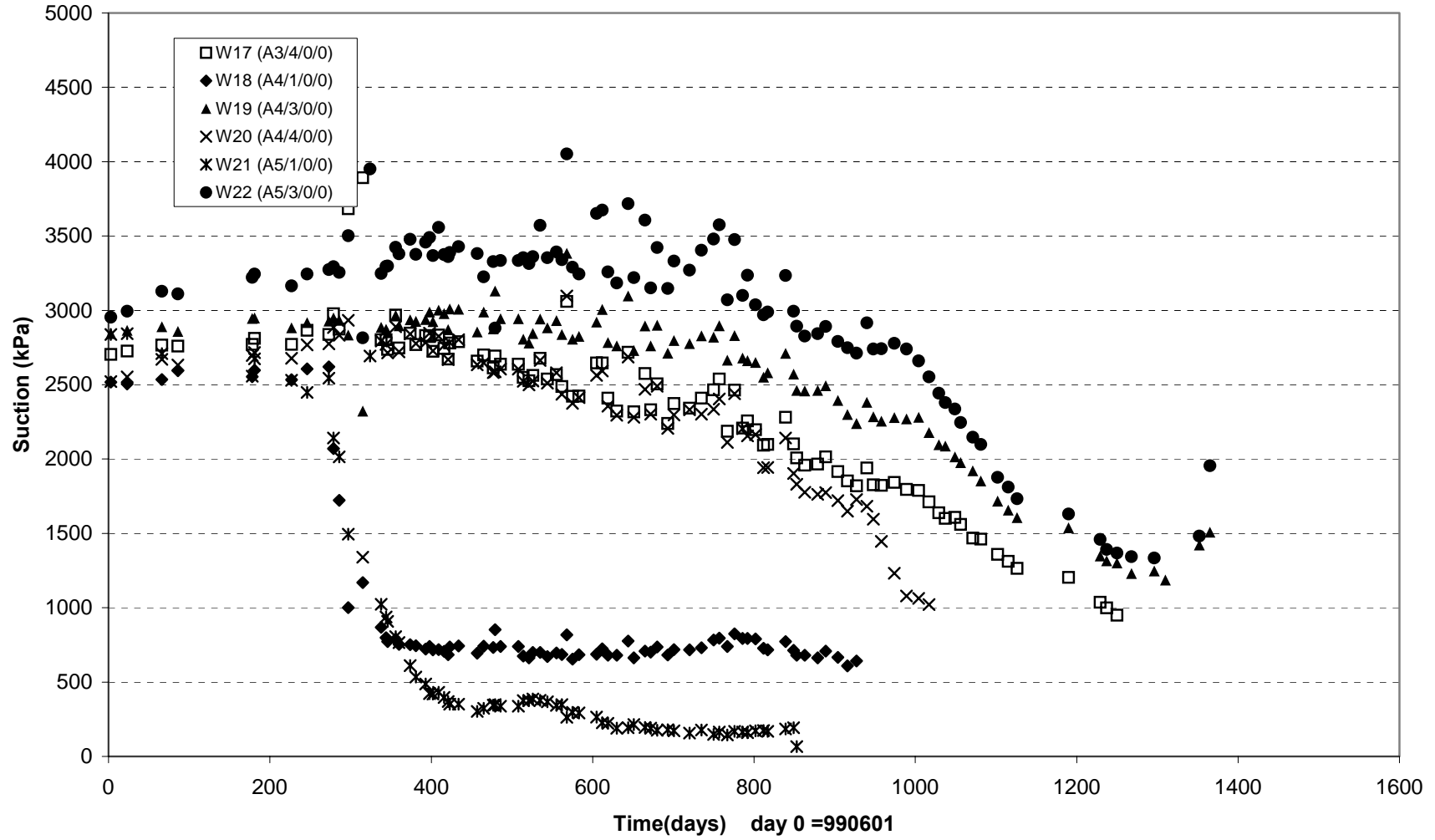

Suction in backfill sections A5&A6 (990601-030101)  
WESCOR

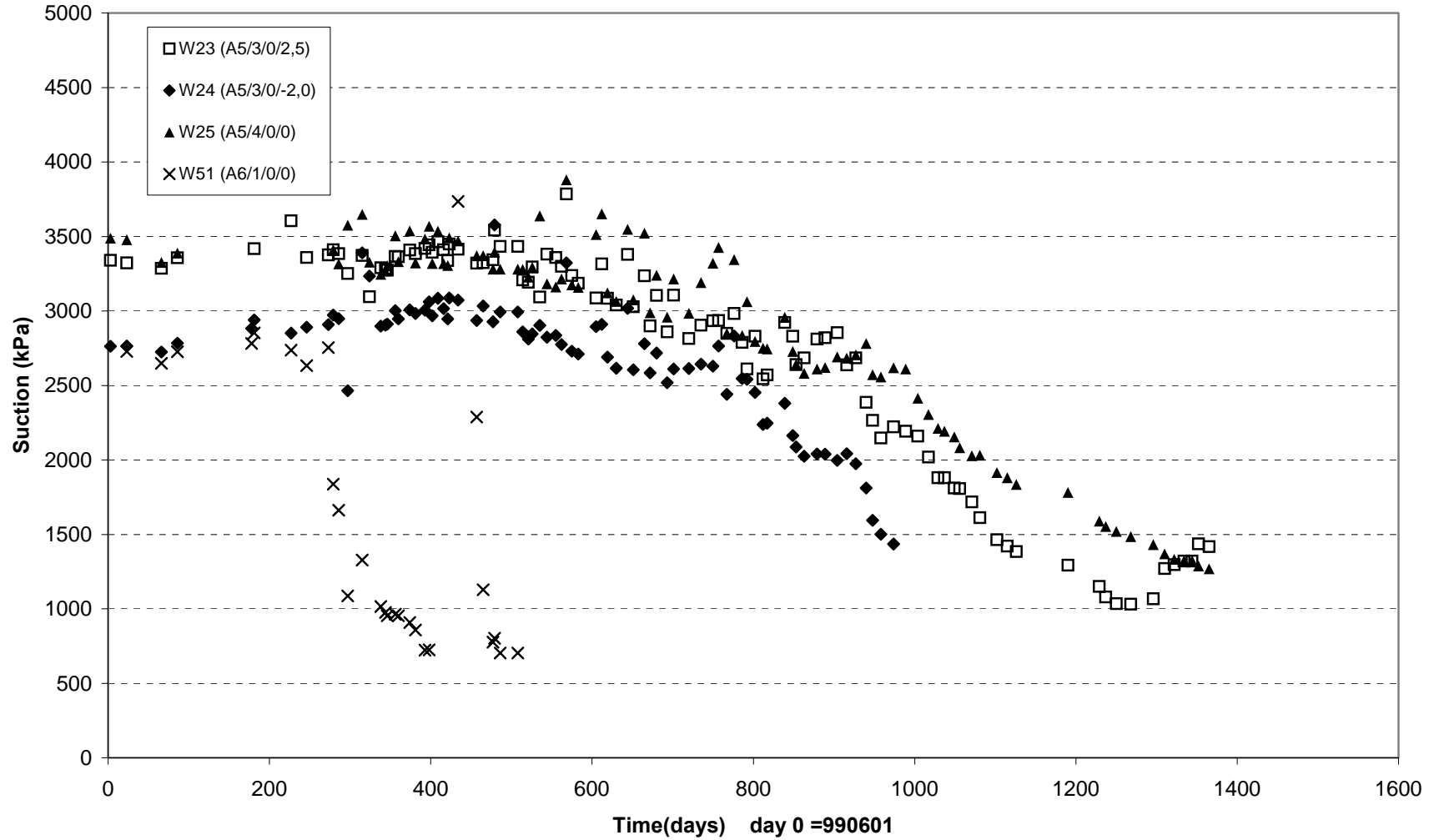

Resistivity in backfill sections B3, B4&B5 (990601-030101)  
LTH-probe

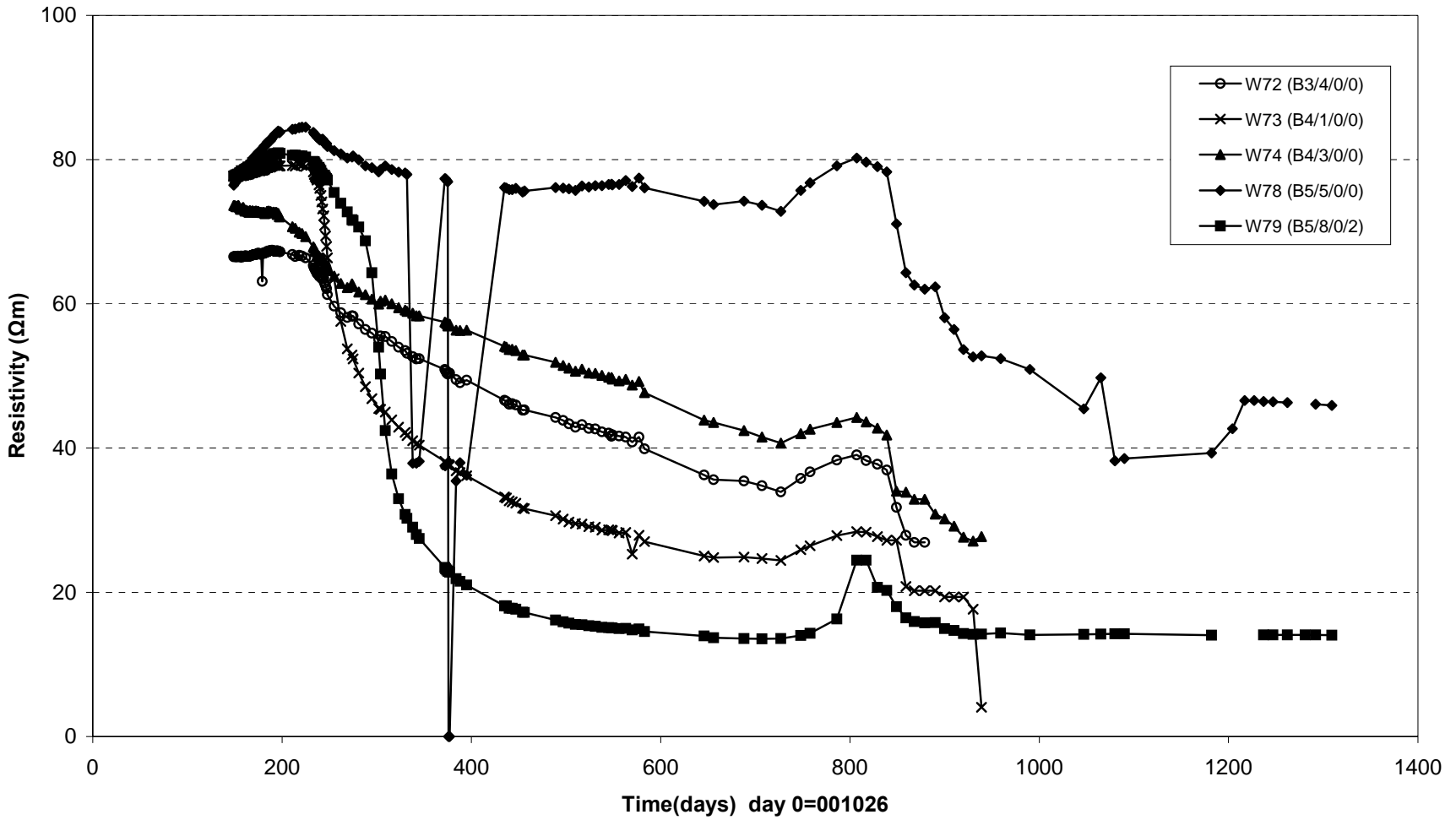



Resistivity in backfill sections B2,B3 (990601-030101)  
LTH-probe

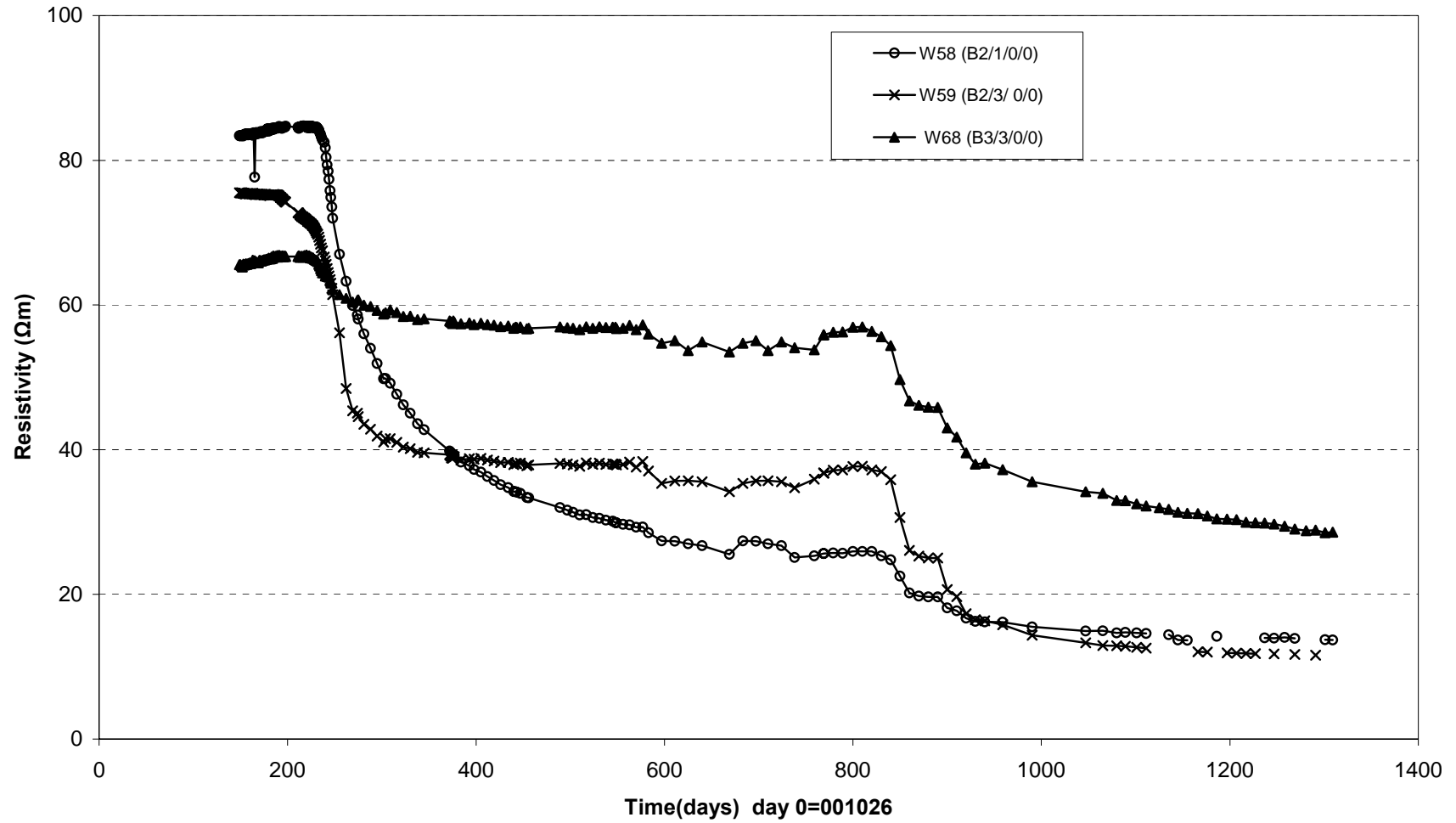

Pore water pressure section A1(990601-030101)  
GLÖTZL

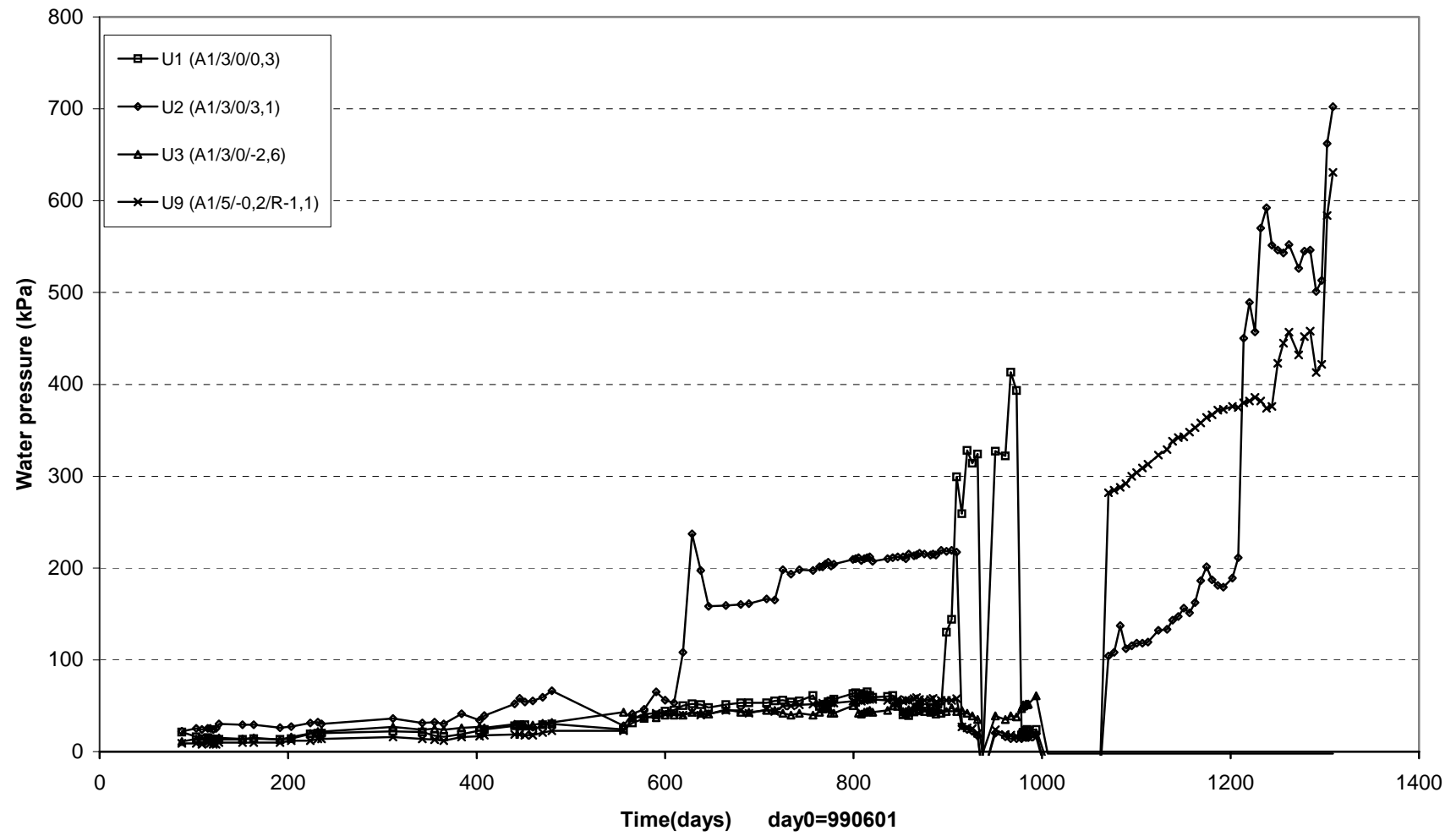

Pore water pressure section A2(990601-030101)  
GLÖTZL

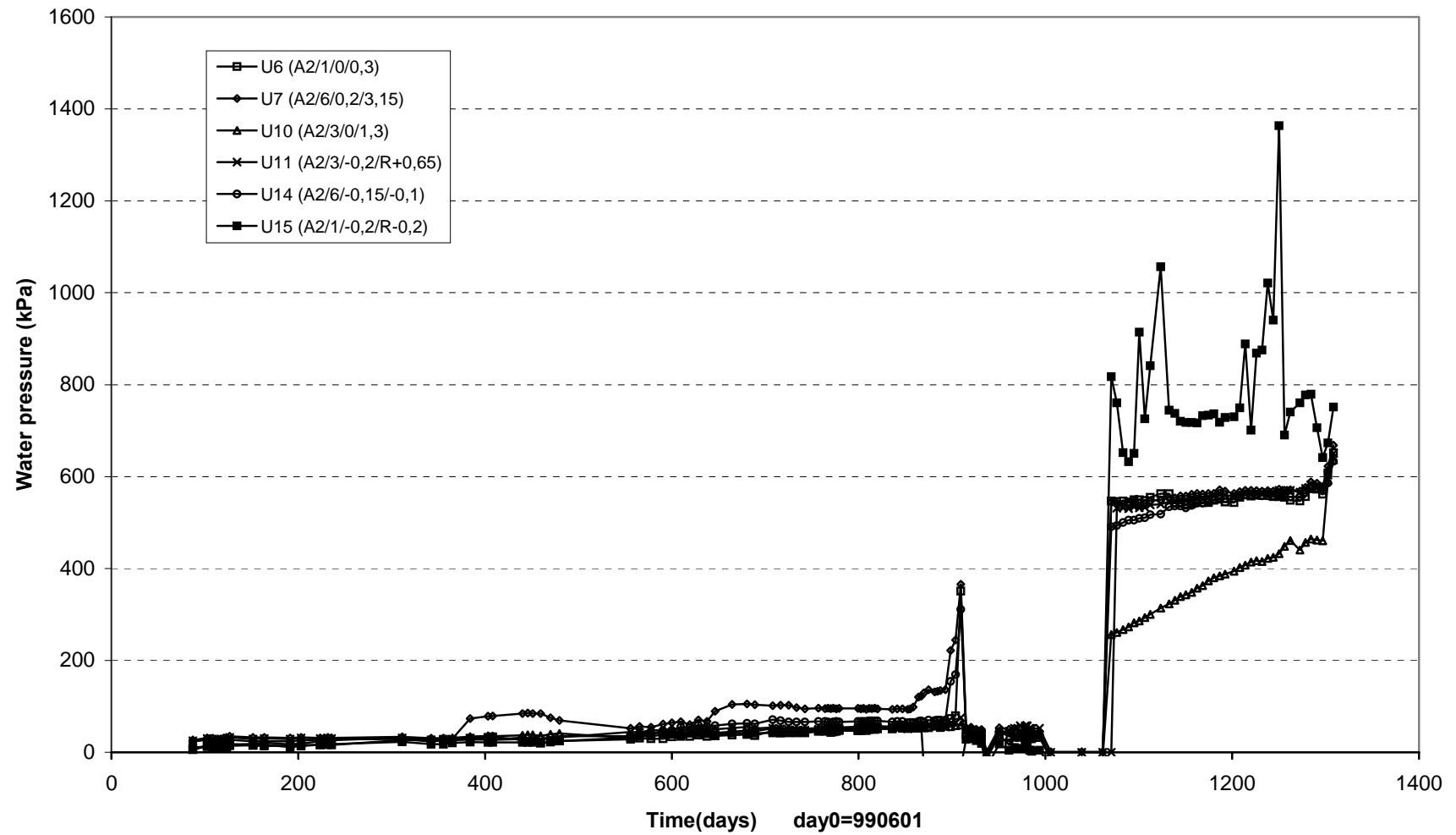

Pore water pressure section A3&A4(990601-030101)  
GLÖTZL

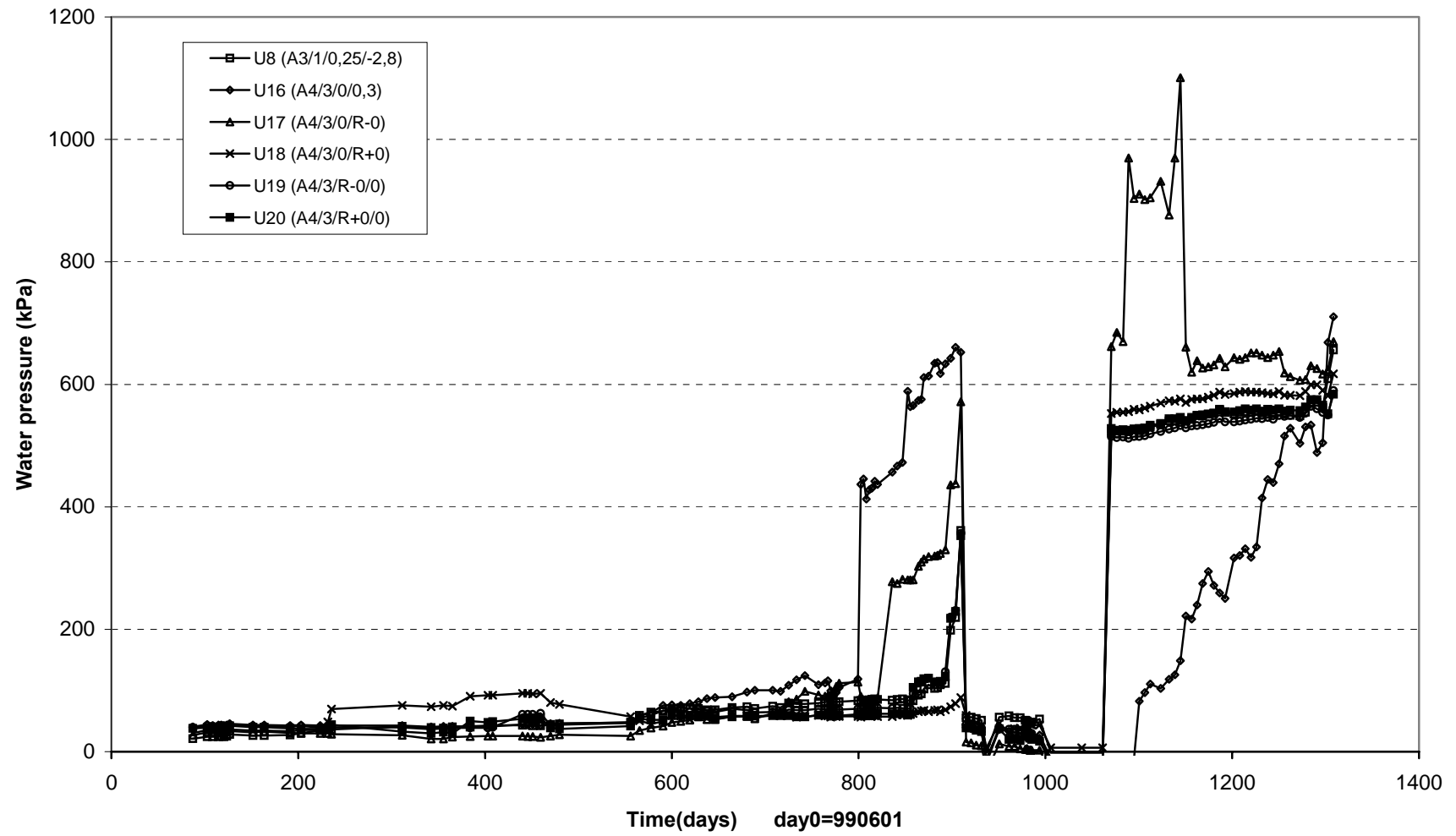

Pore water pressure section A5(990601-030101)  
GLÖTZL

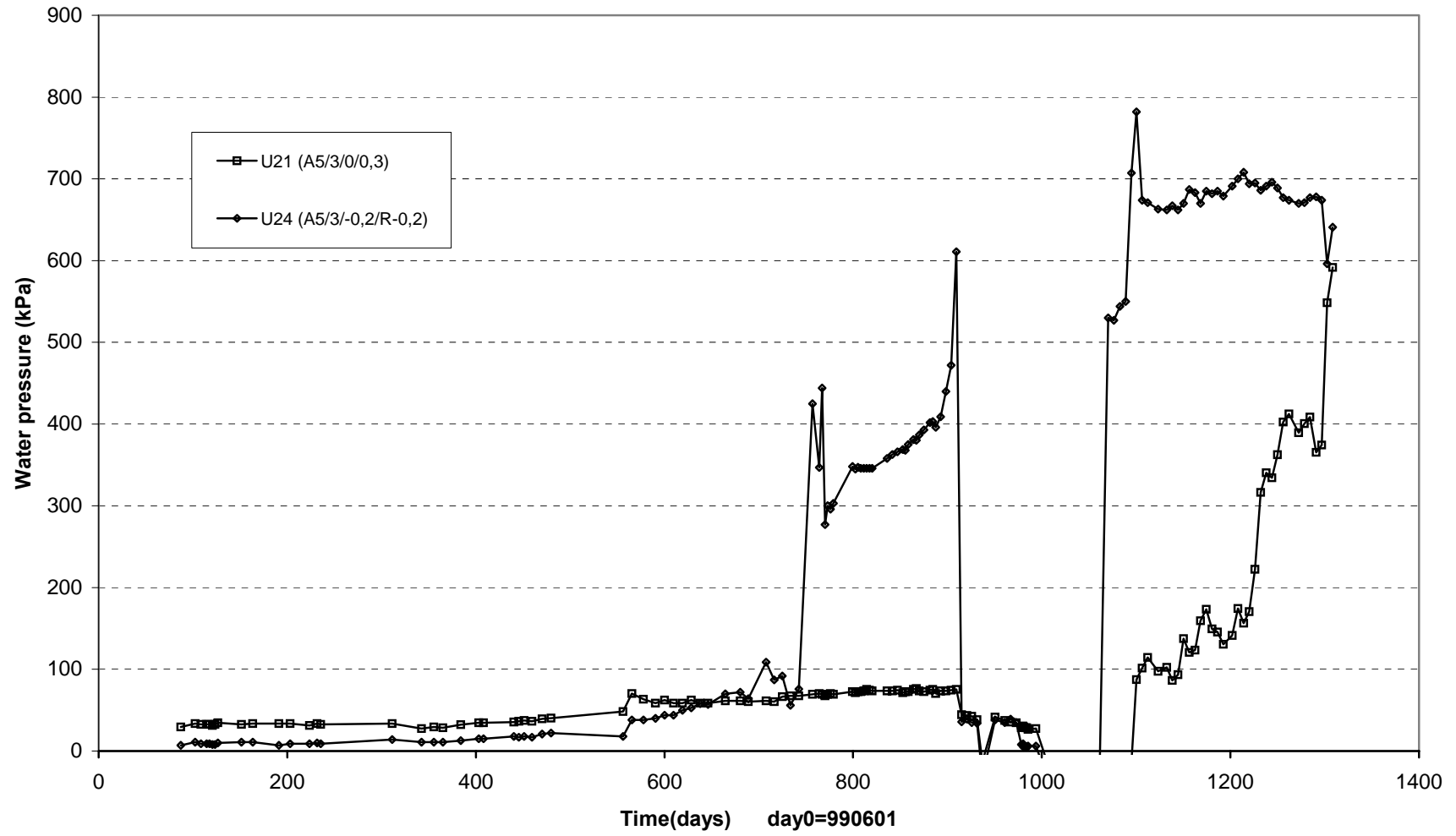

Water pressure in backfill sections A1- A6 (990601-030101)  
DRUCK

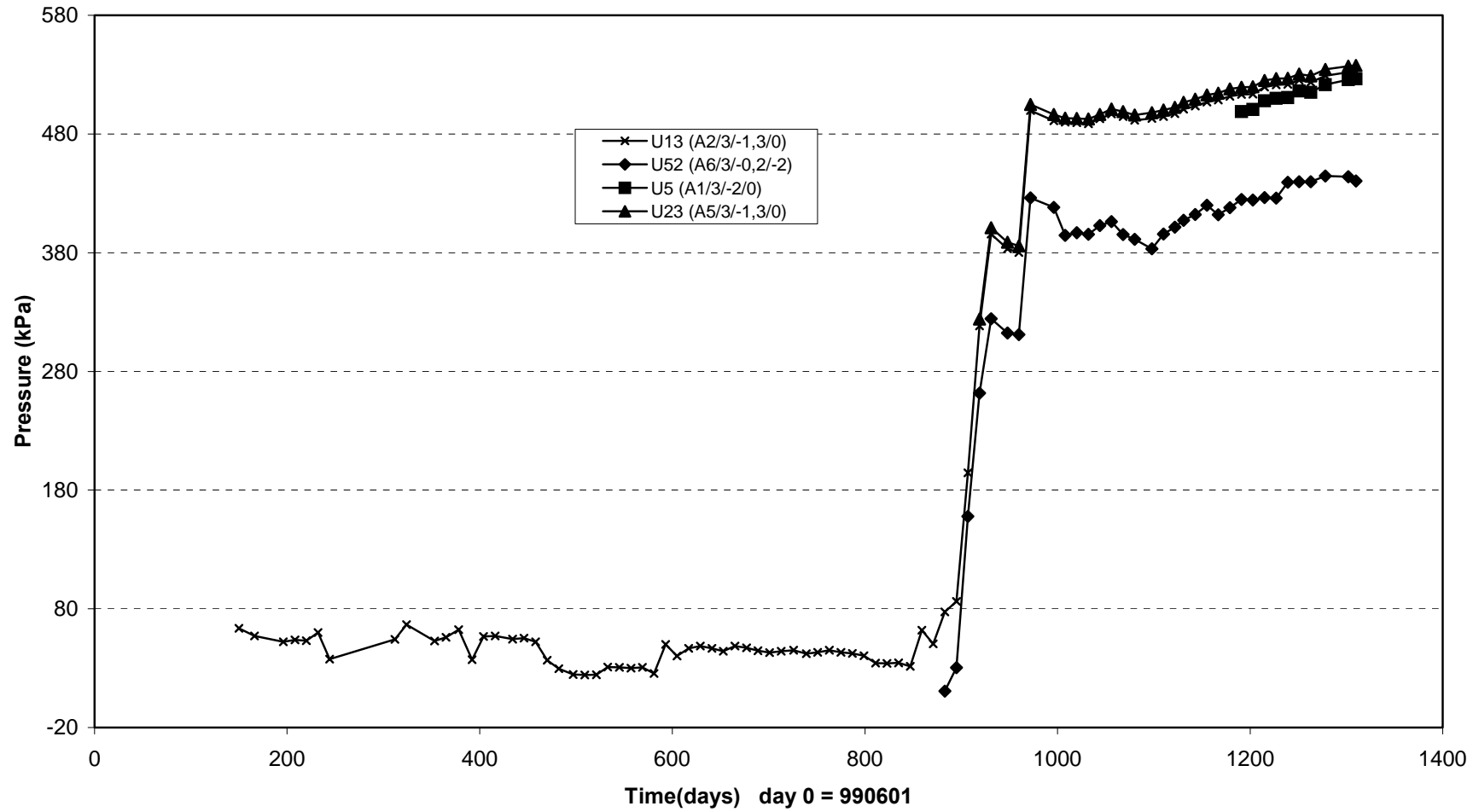

Water pressure in backfill sections B2&B3&B4 (990601-030101)  
DRUCK

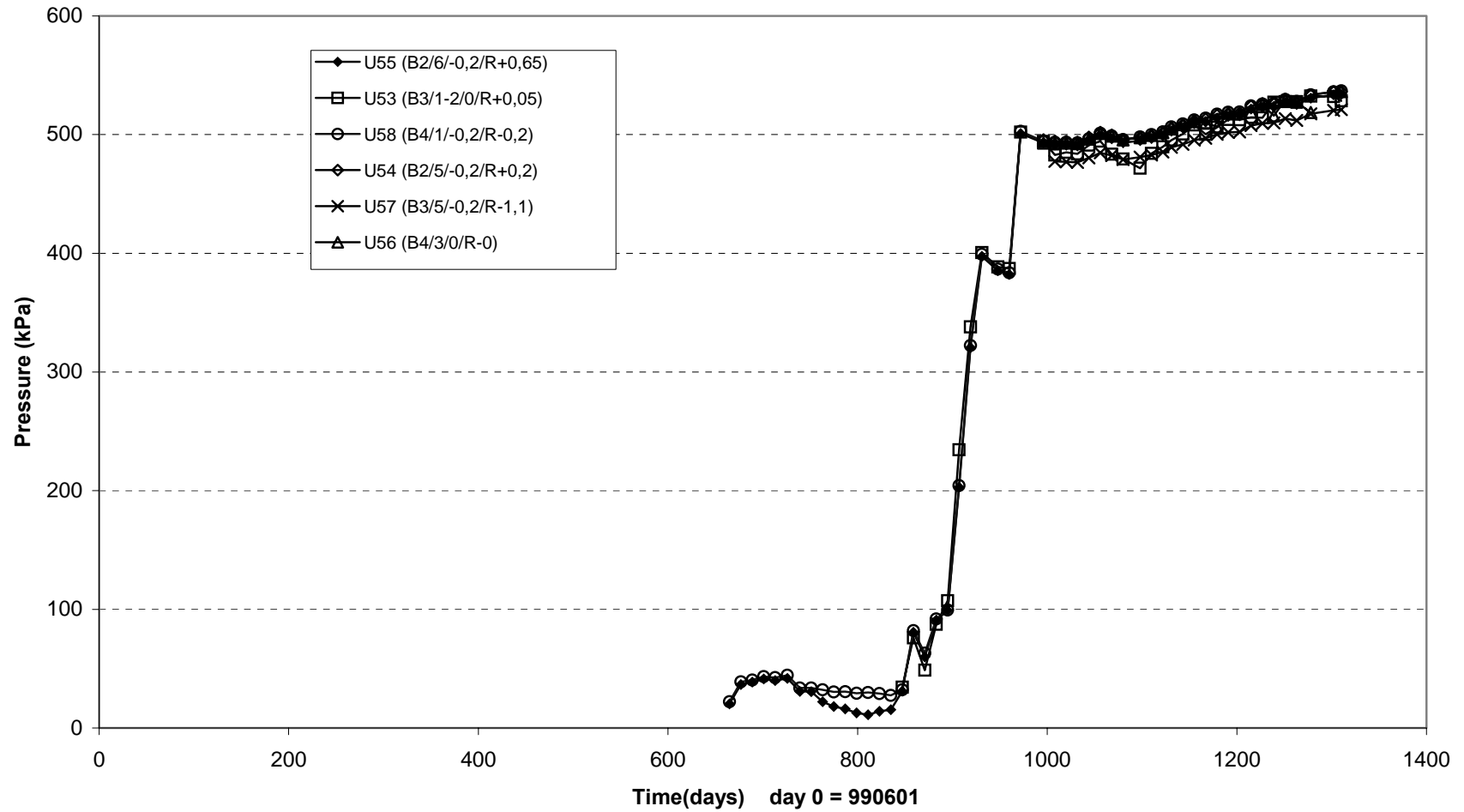

### Flowmeter(000601-030101)

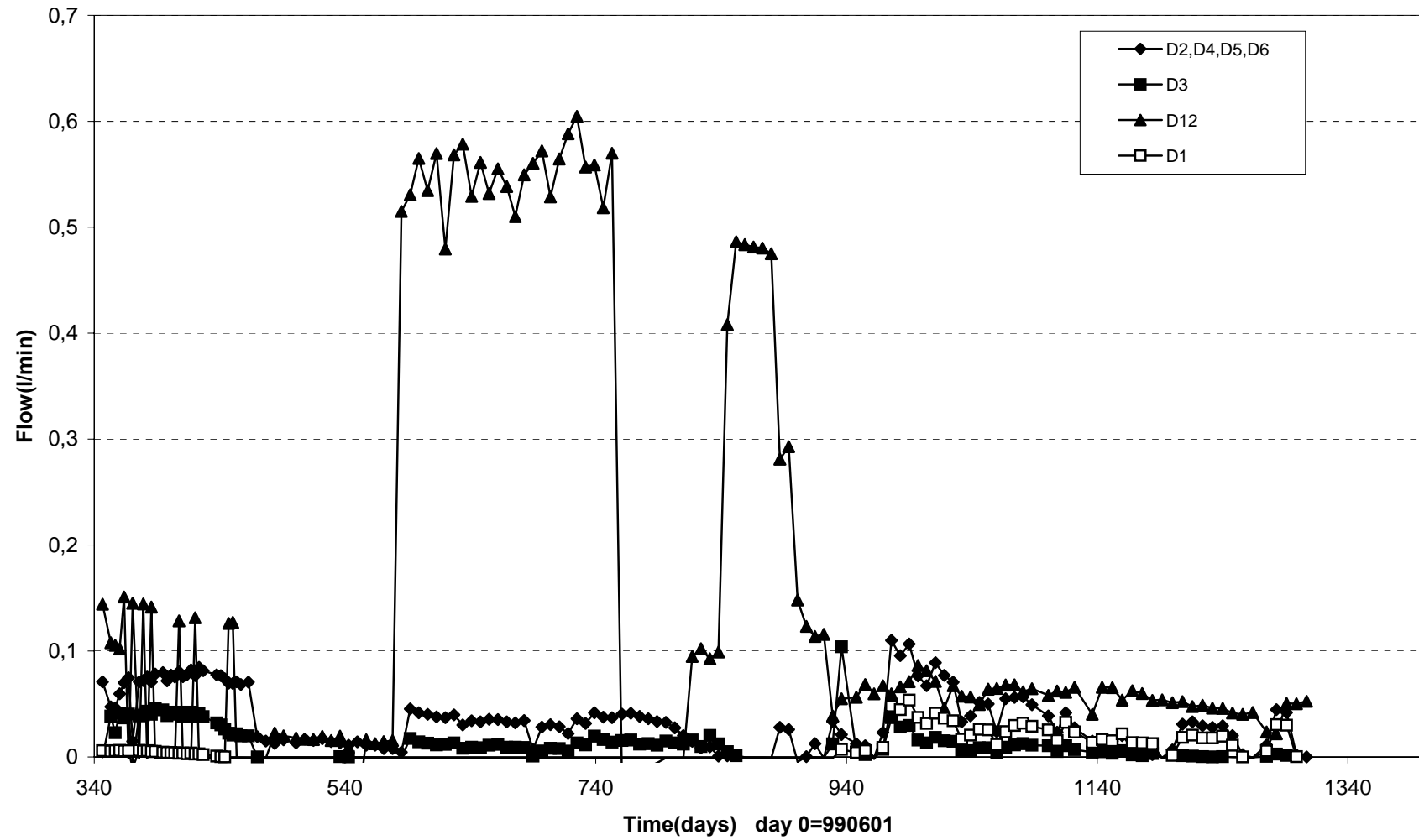



Water pressure in permeable mats D1-D6 (990601-030101)  
Druck

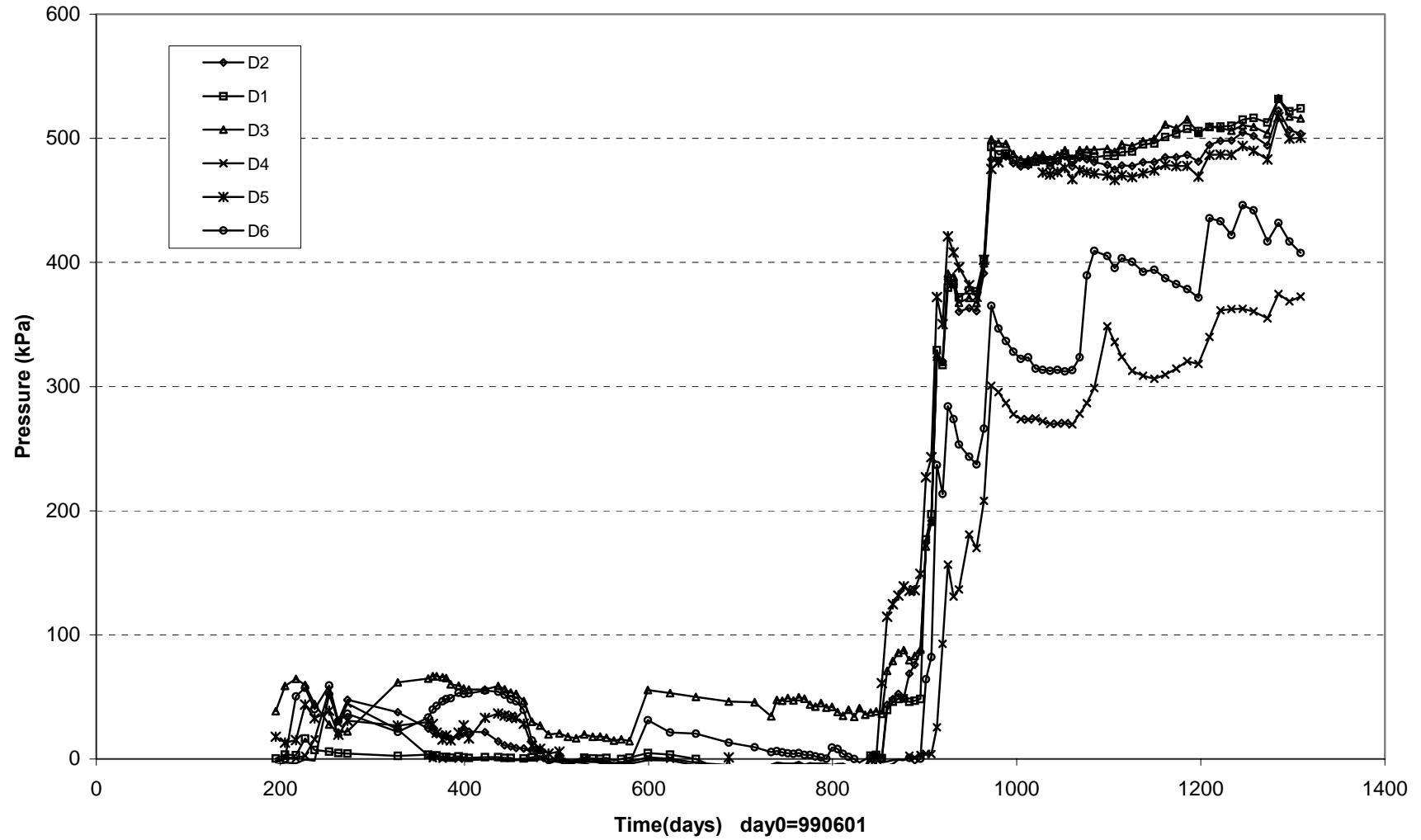

Water pressure in permeable mats D7-D12 (990601-030101)  
DRUCK

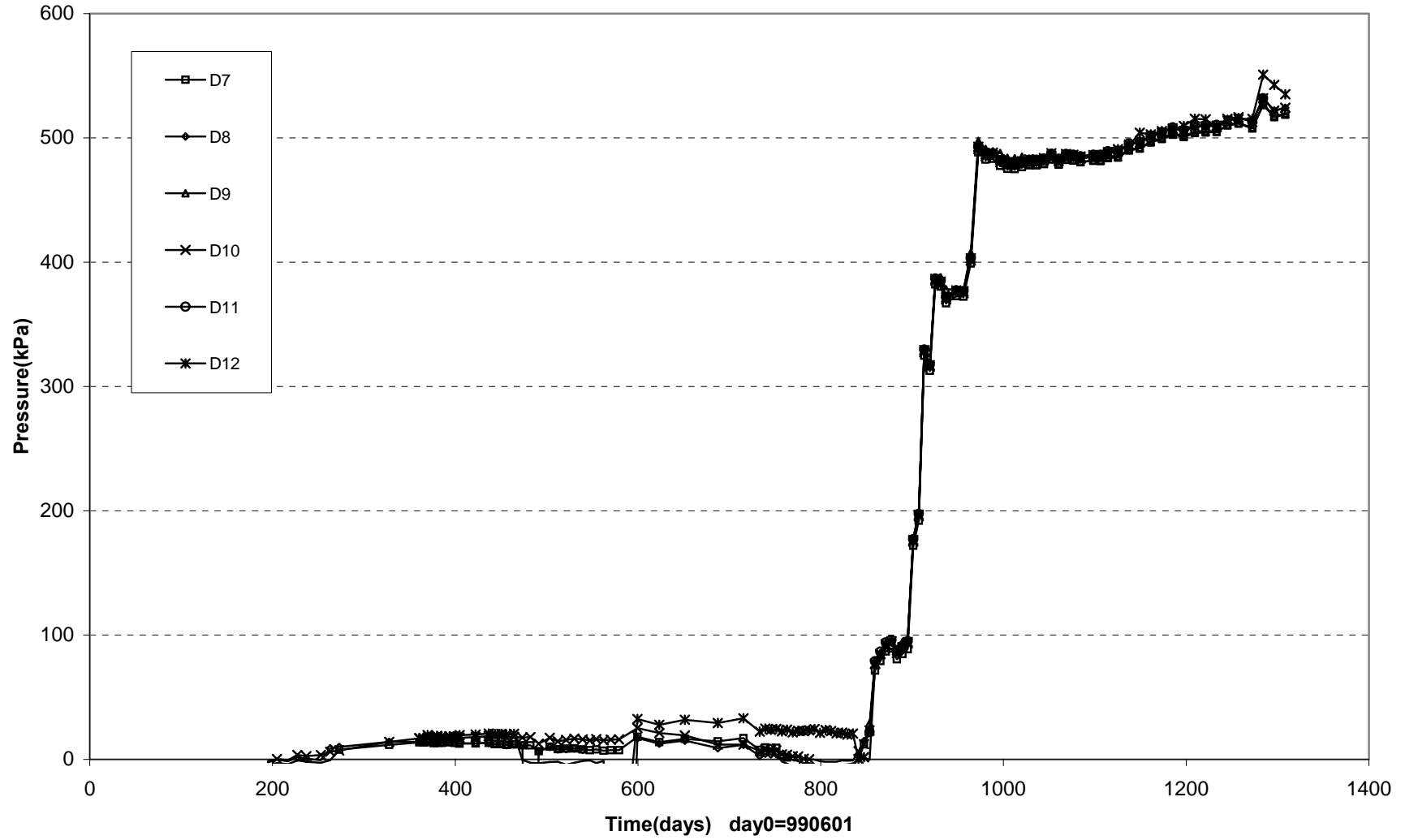

Water flow past plug (010809-030101)

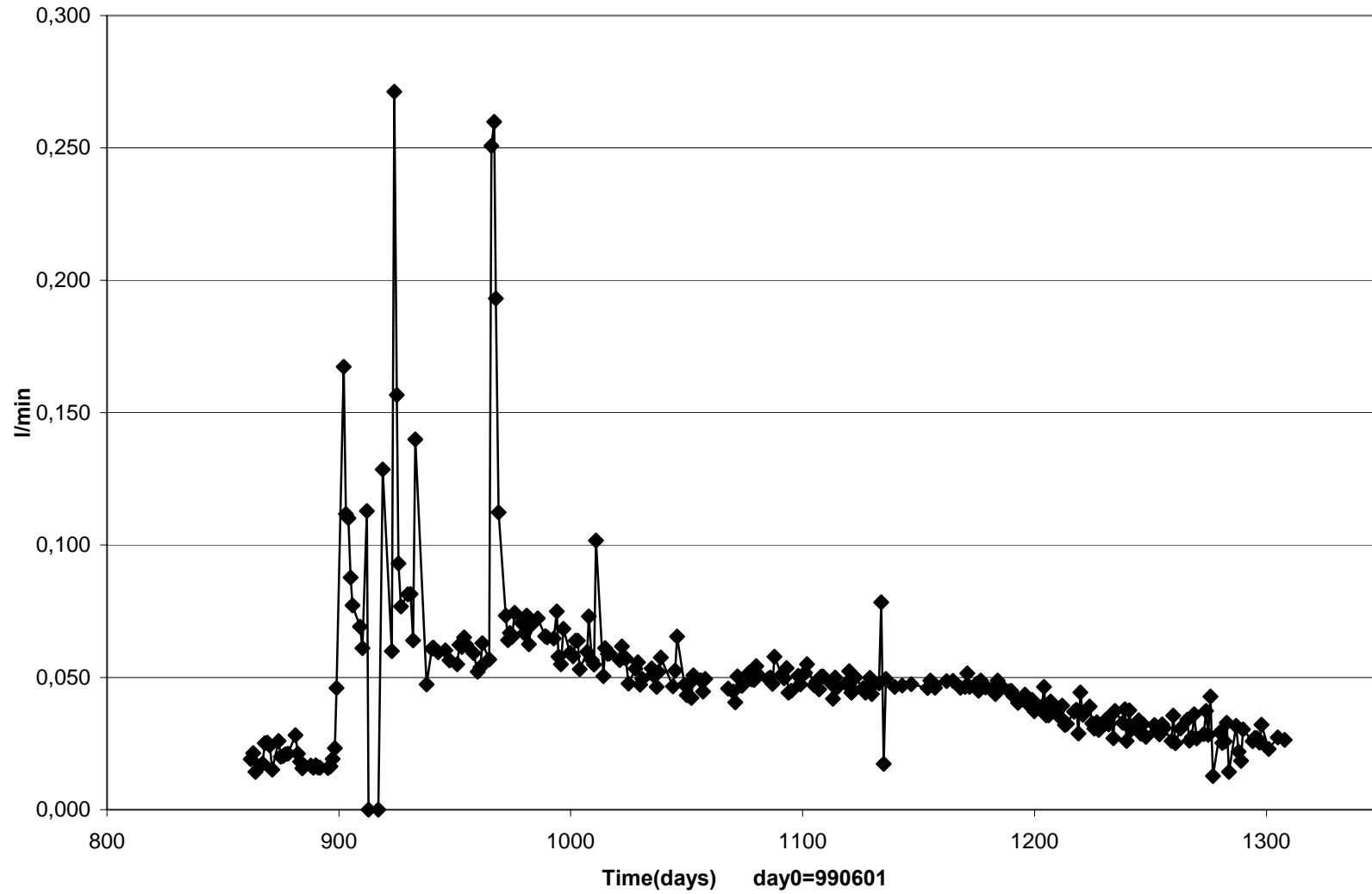

Water flow from inner part (010809-030101)

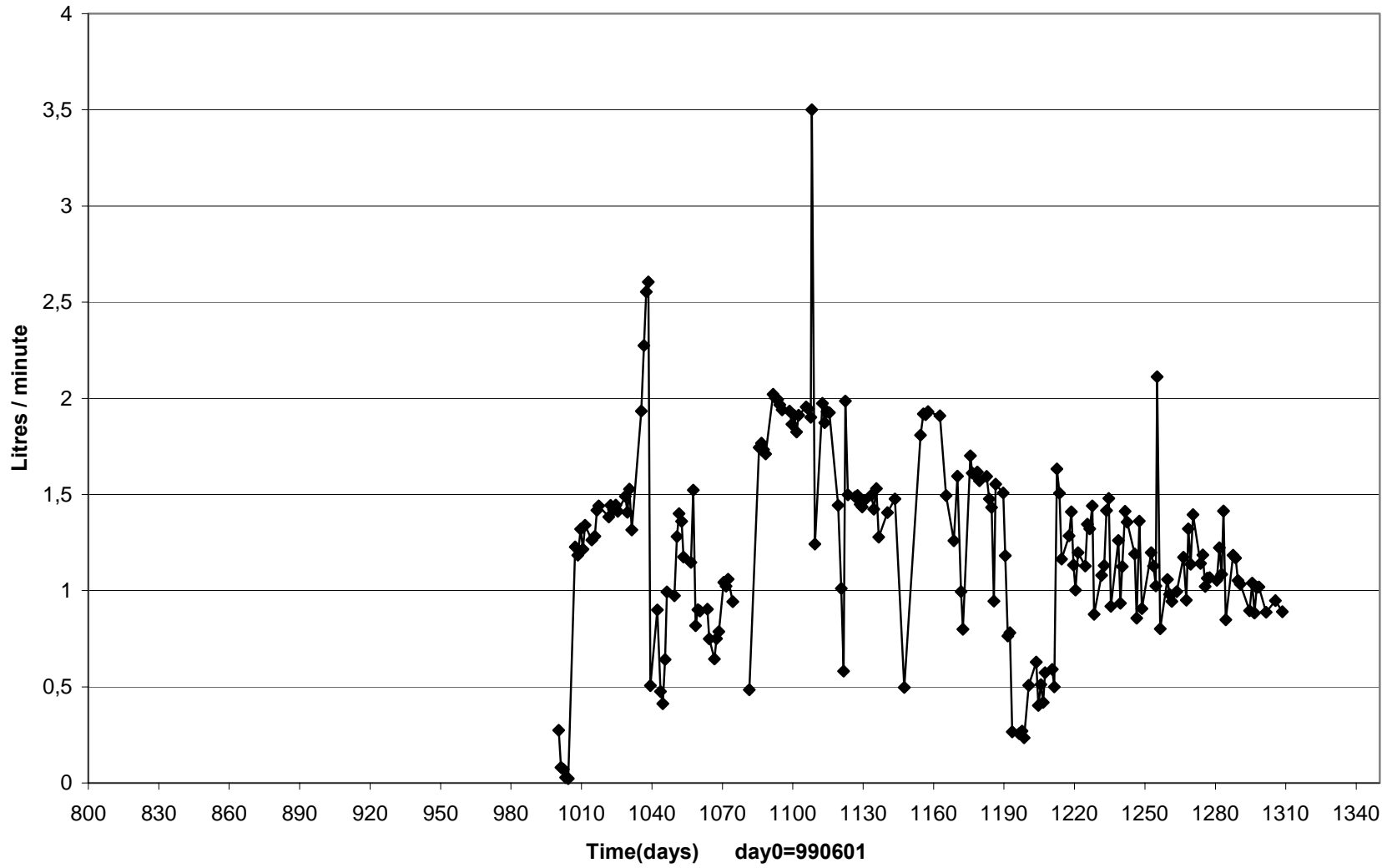

### Inflow DEMO-tunnel (010919-030101)

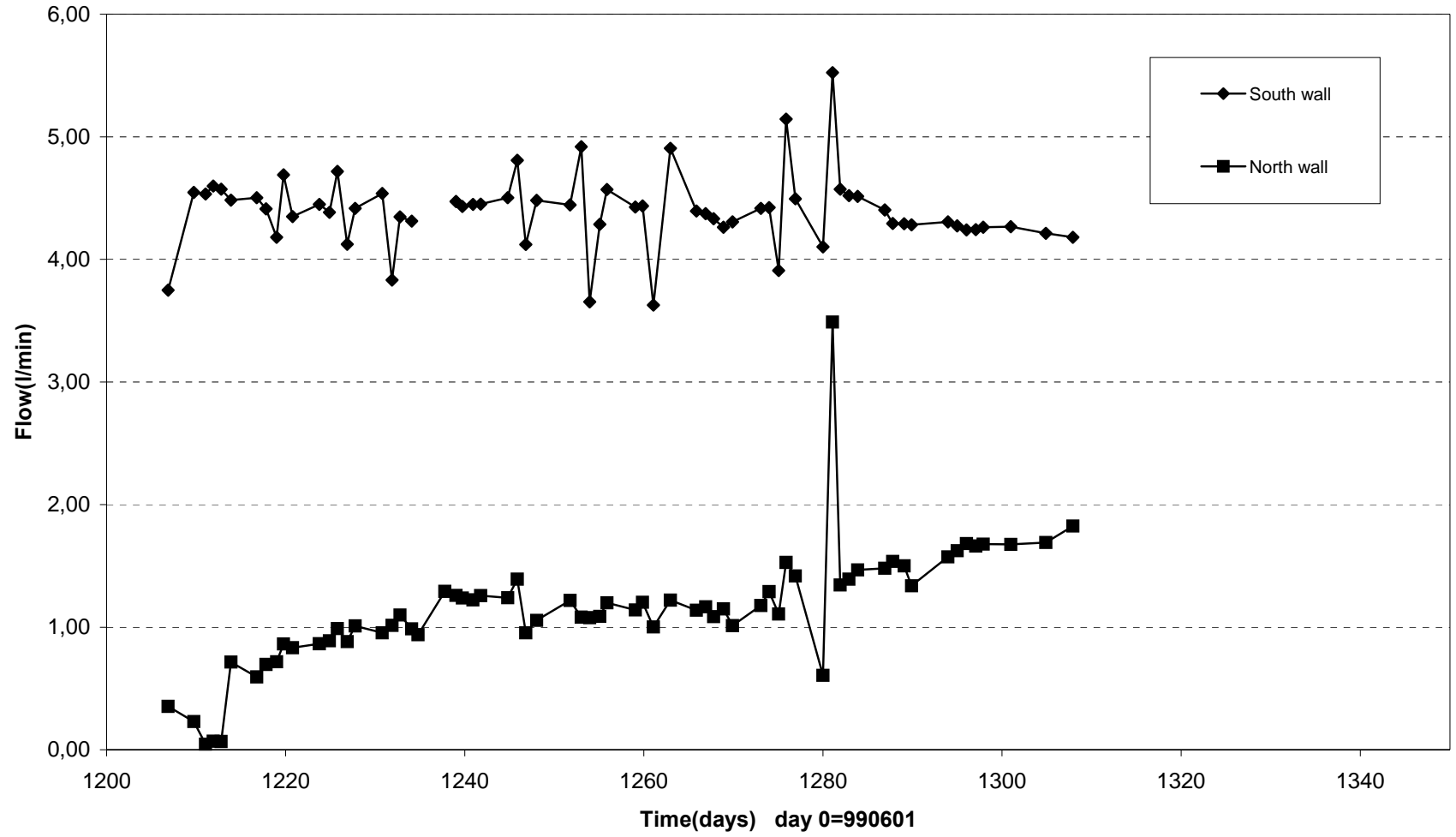

Water pressure in bore holes section 0 (990601-030101)  
DRUCK

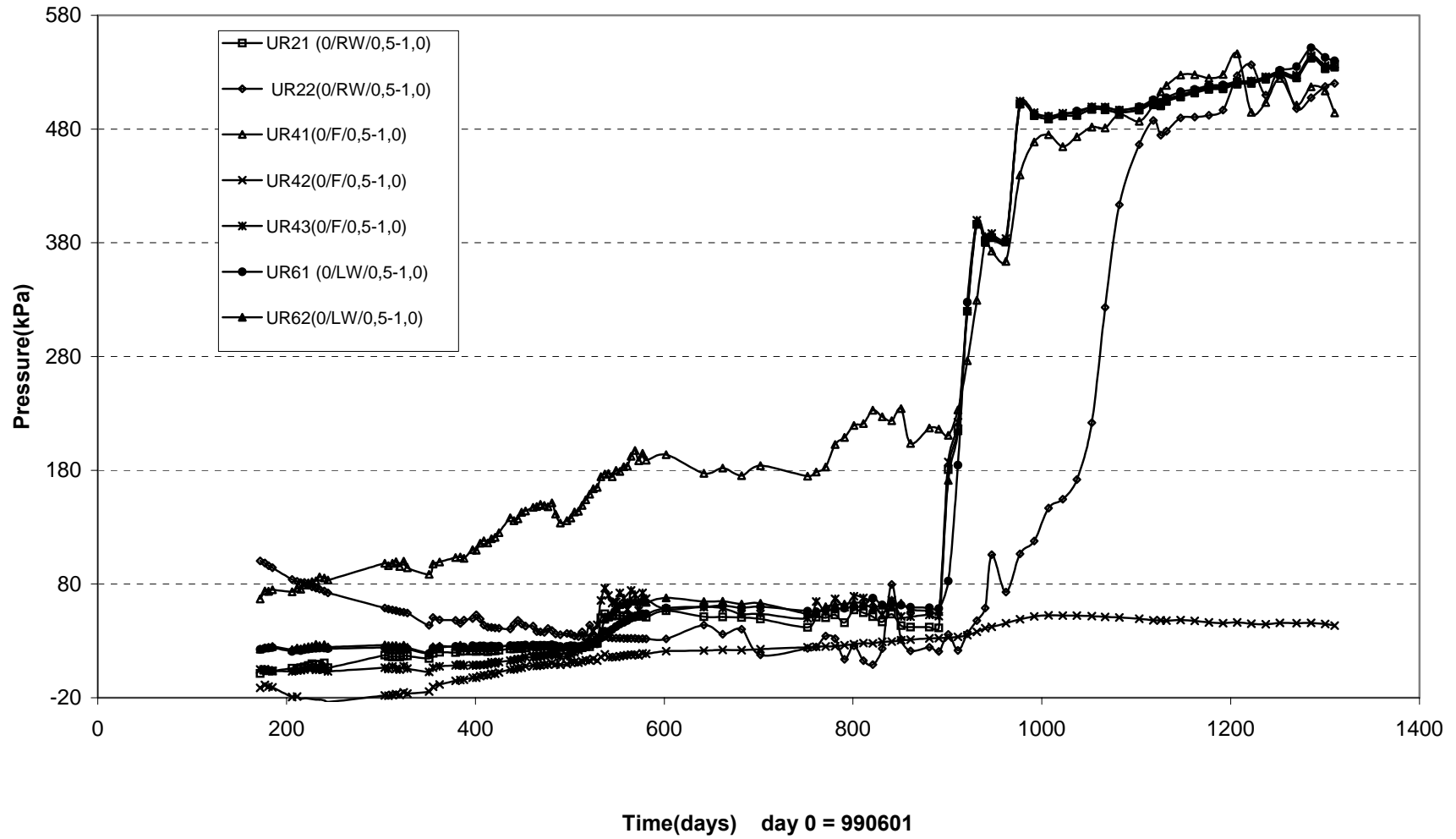

Water pressure in bore holes section 0 (990601-030101)  
DRUCK

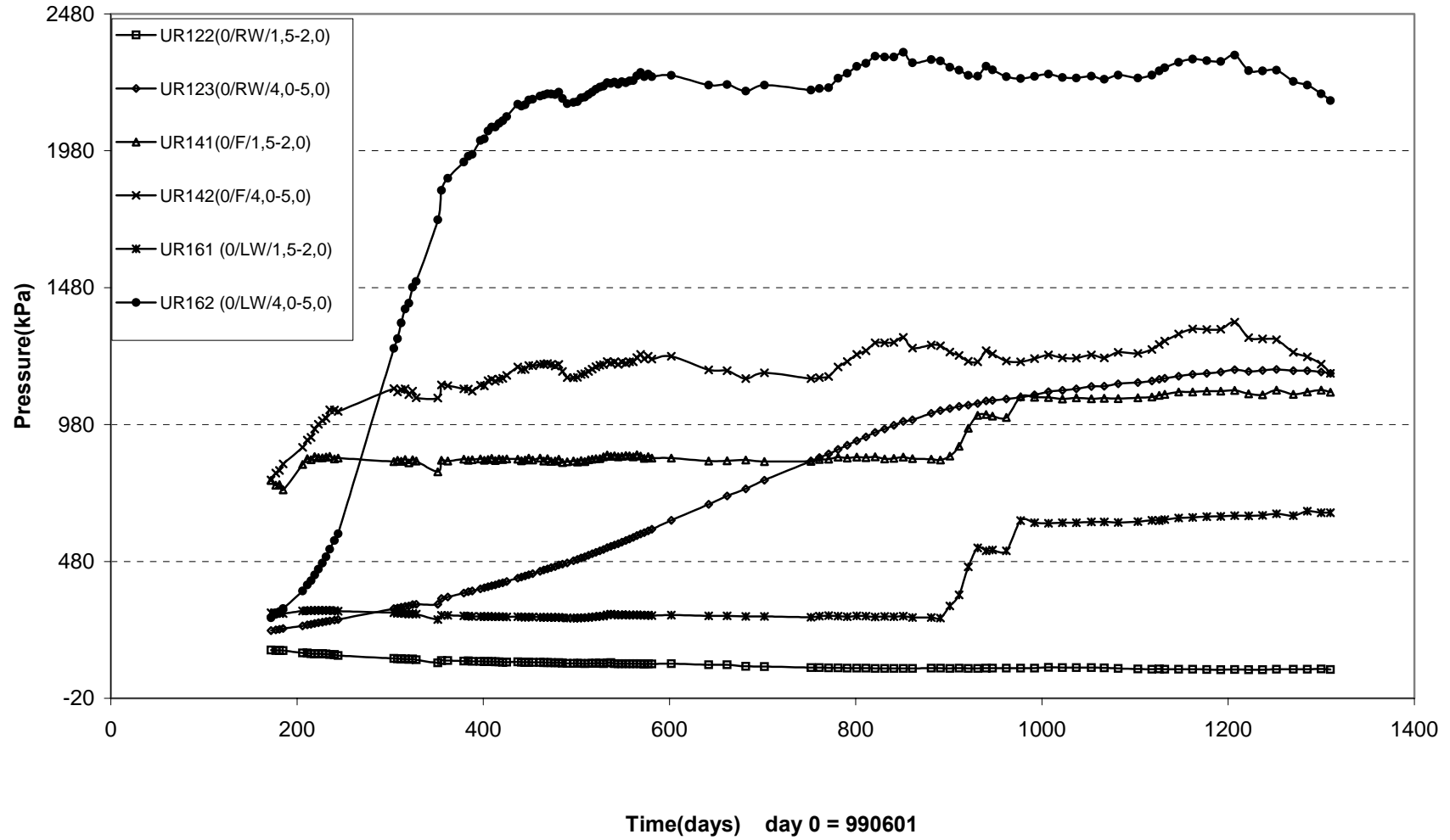

Water pressure in bore holes section A1 (990601-030101)  
DRUCK

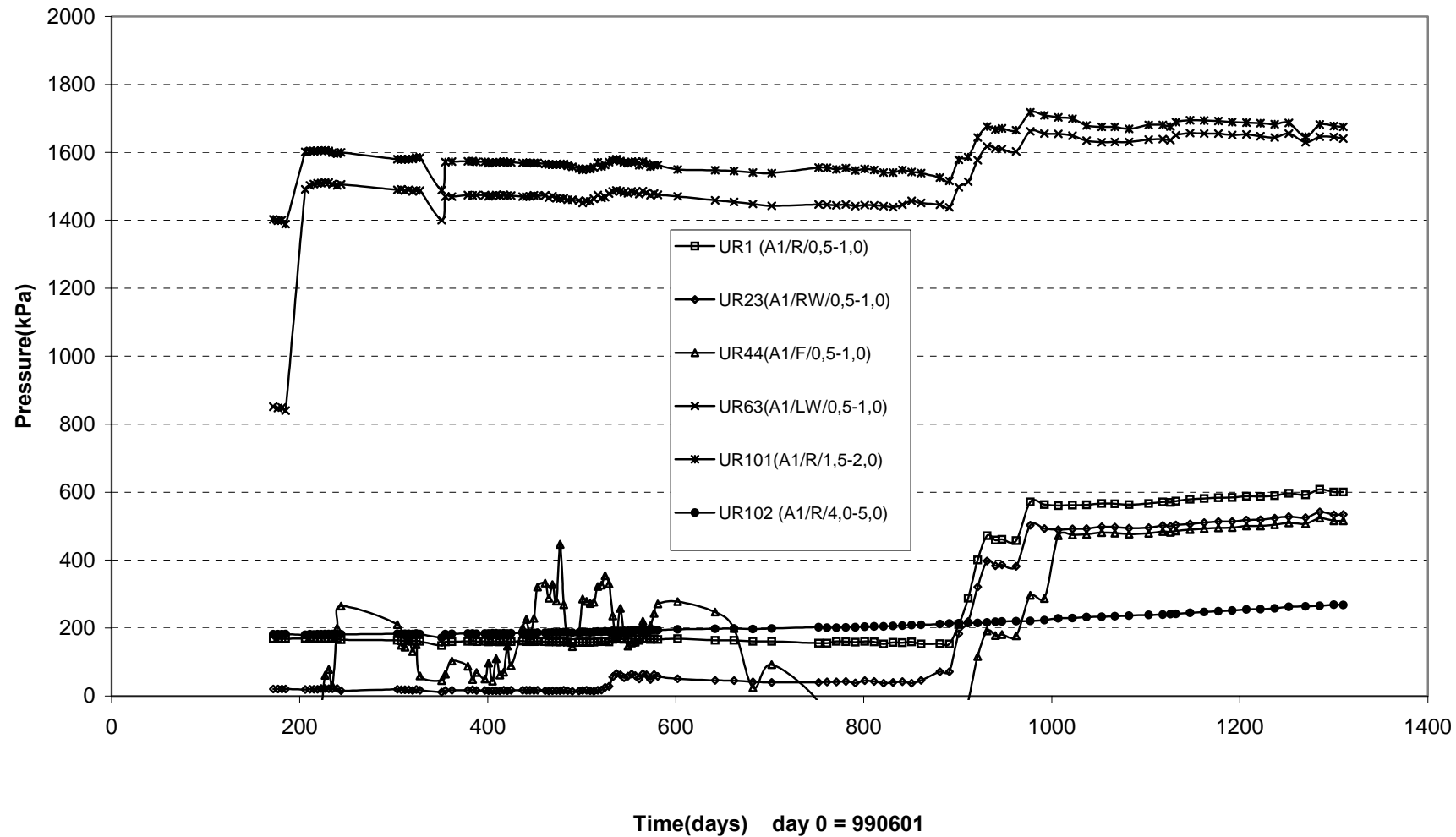



Water pressure in bore holes section A2 (990601-030101)  
DRUCK

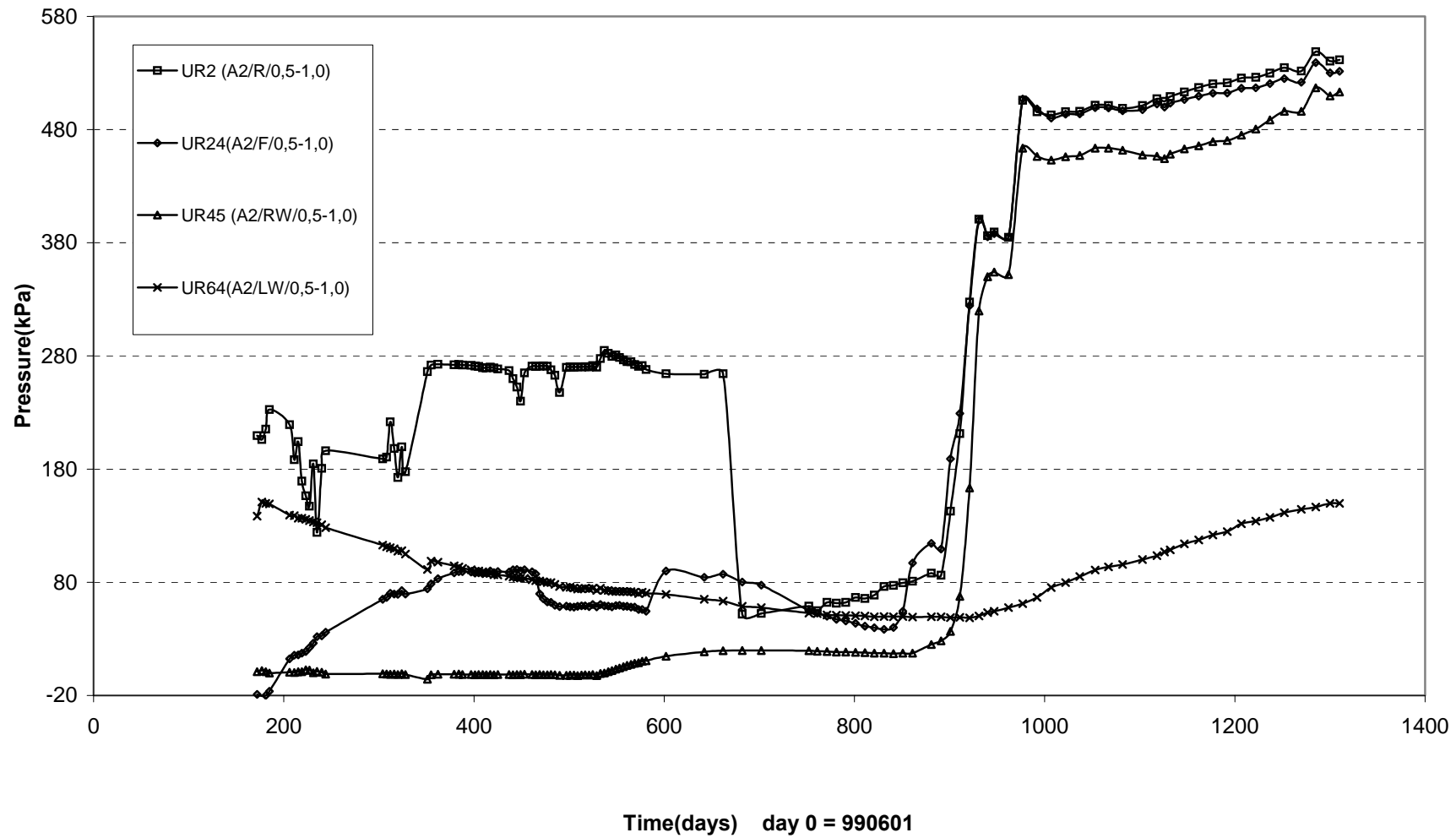

Water pressure in bore holes section A2 (990601-030101)  
DRUCK

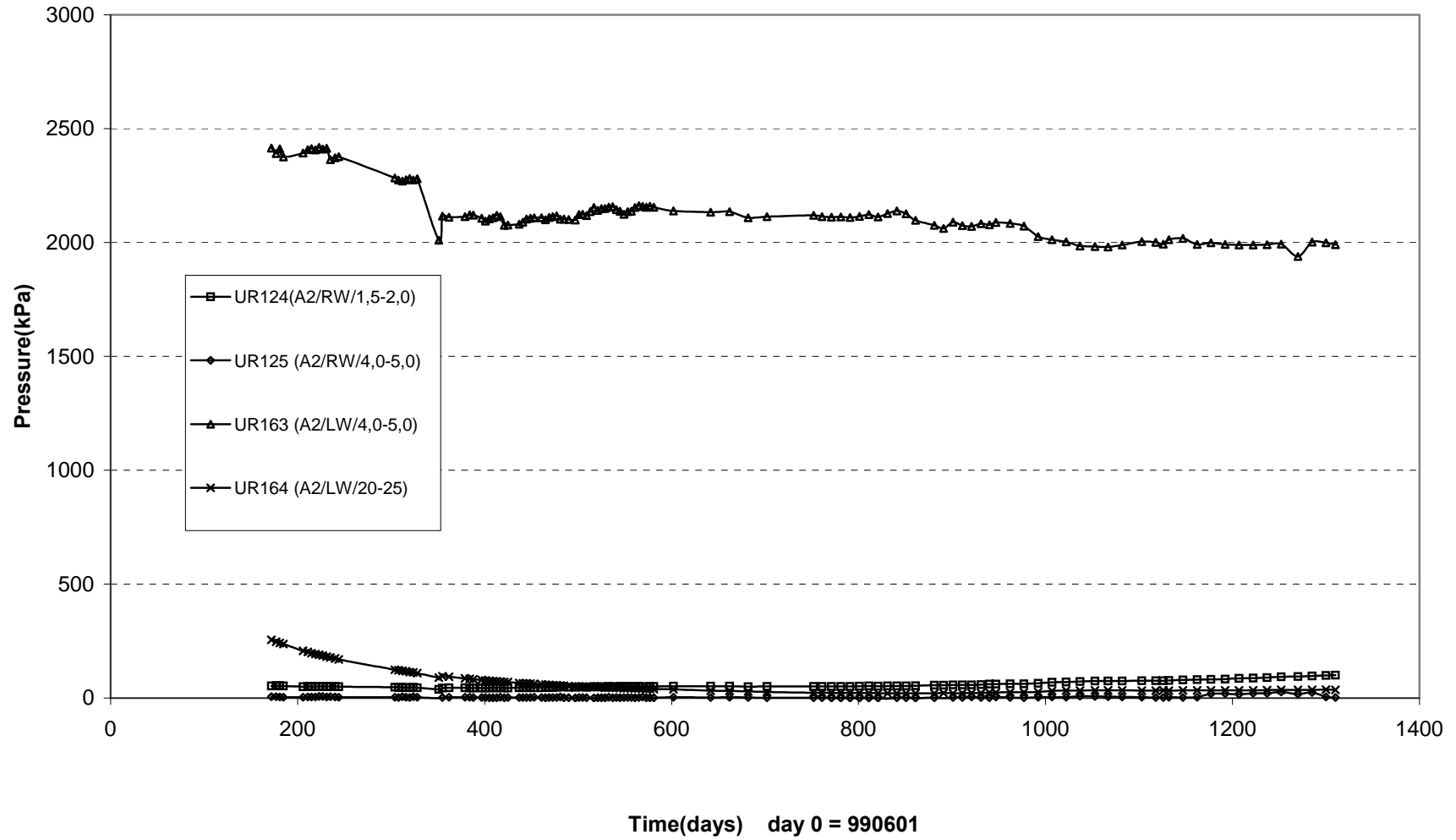

Water pressure in bore holes section A3 (990601-030101)  
DRUCK

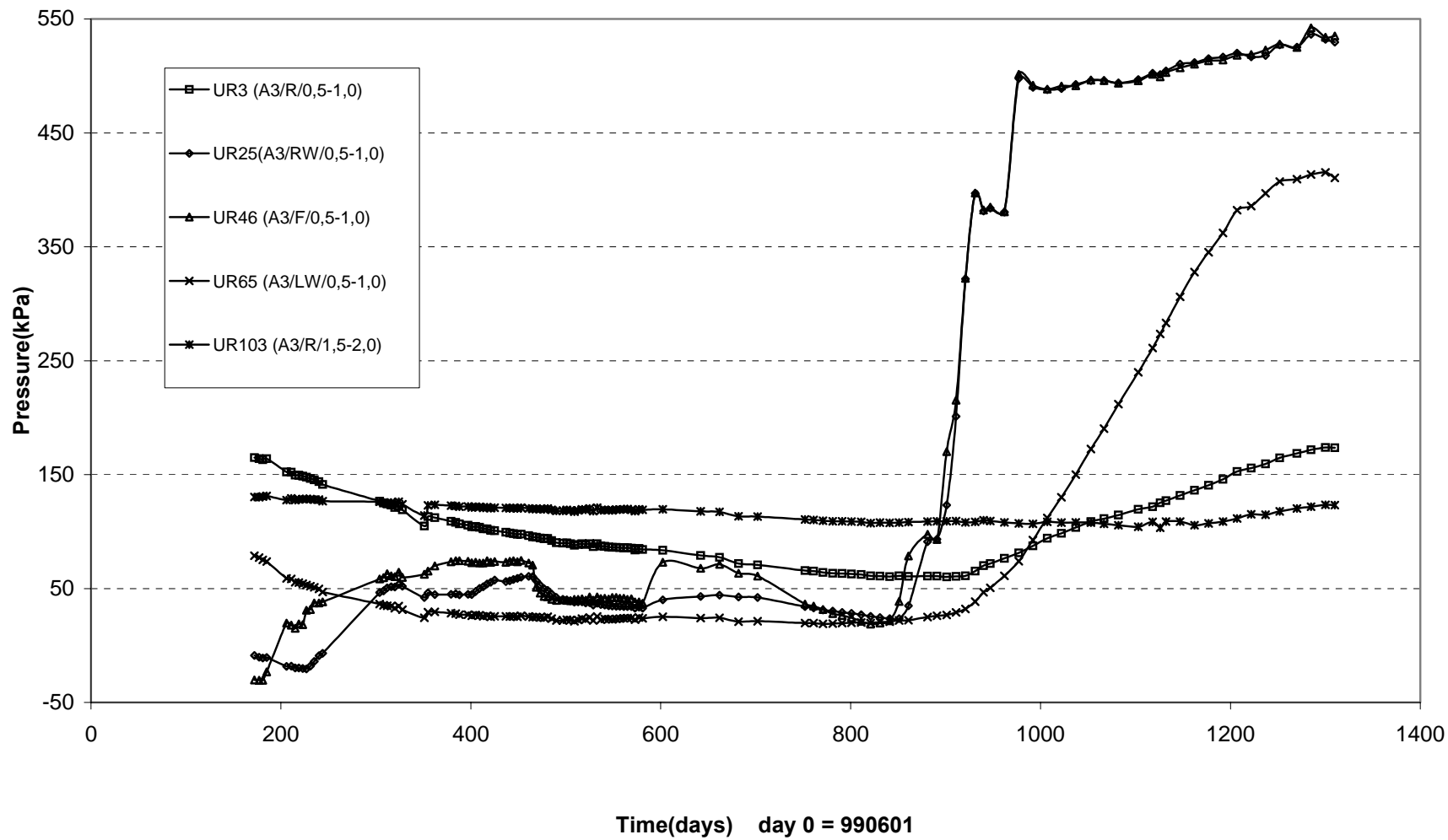

Water pressure in bore holes section A3 (990601-030101)  
DRUCK

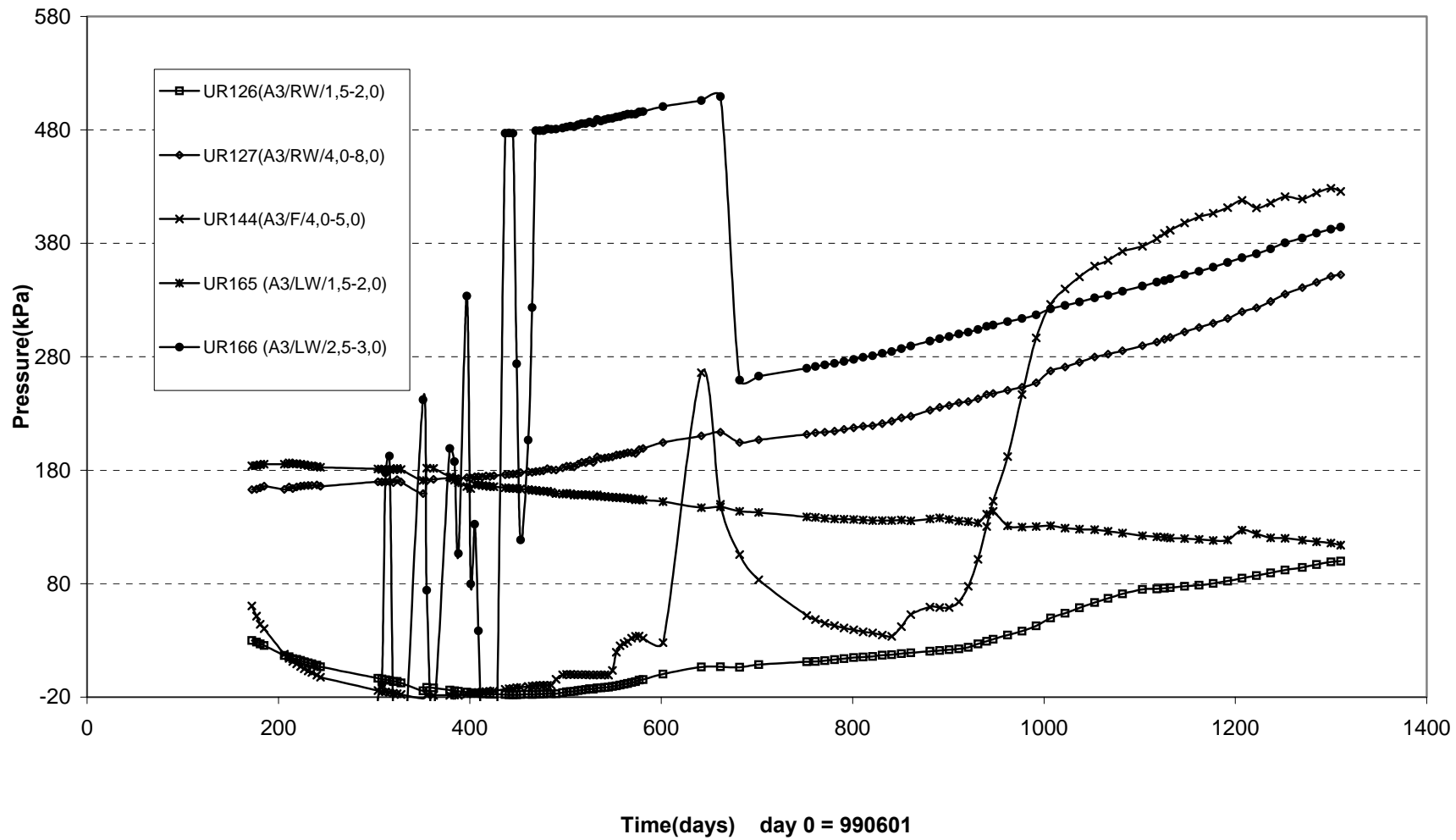

Water pressure in bore holes section A3 (990601-030101)  
DRUCK

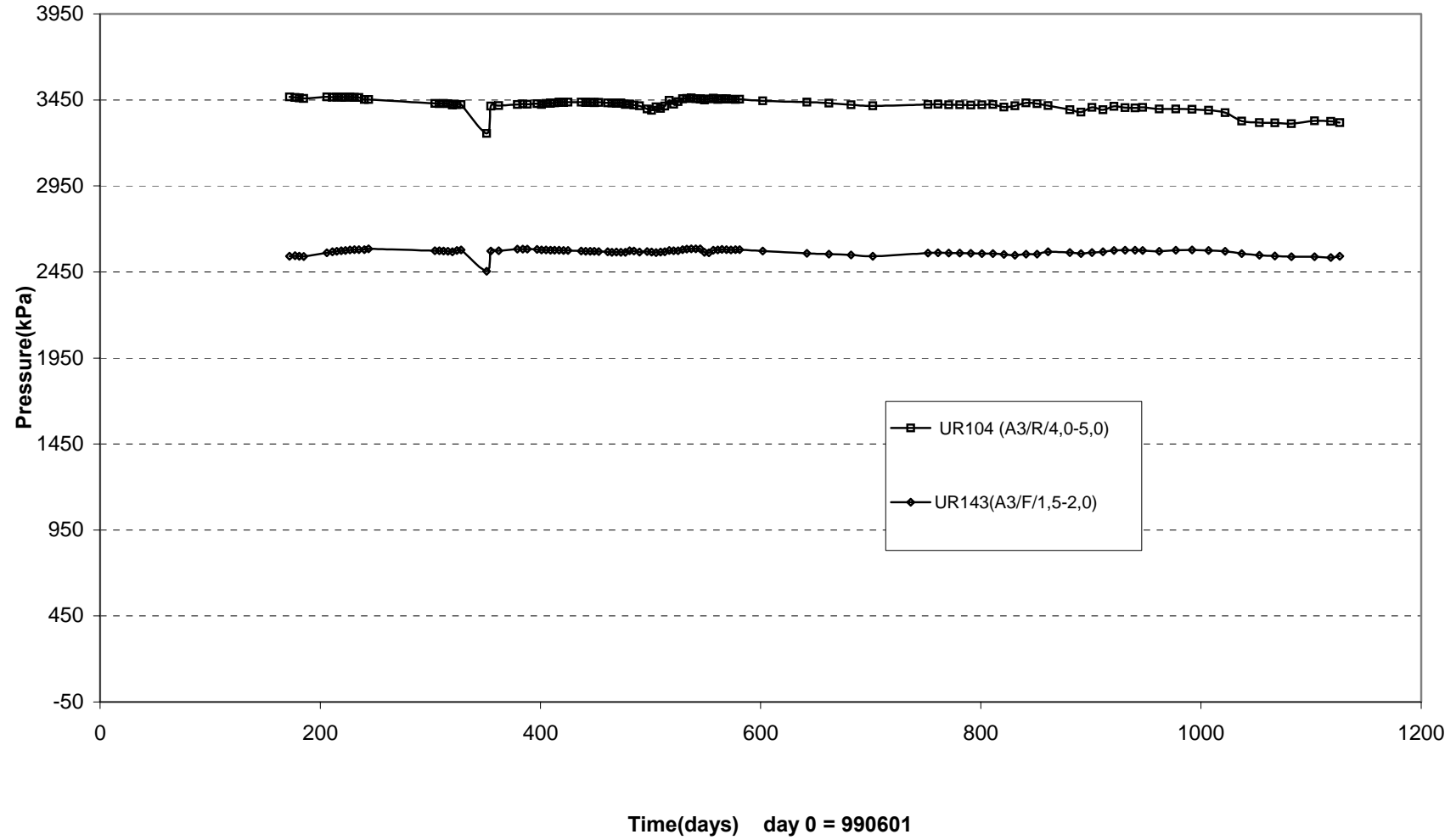

Water pressure in bore holes section A4 (990601-030101)  
DRUCK

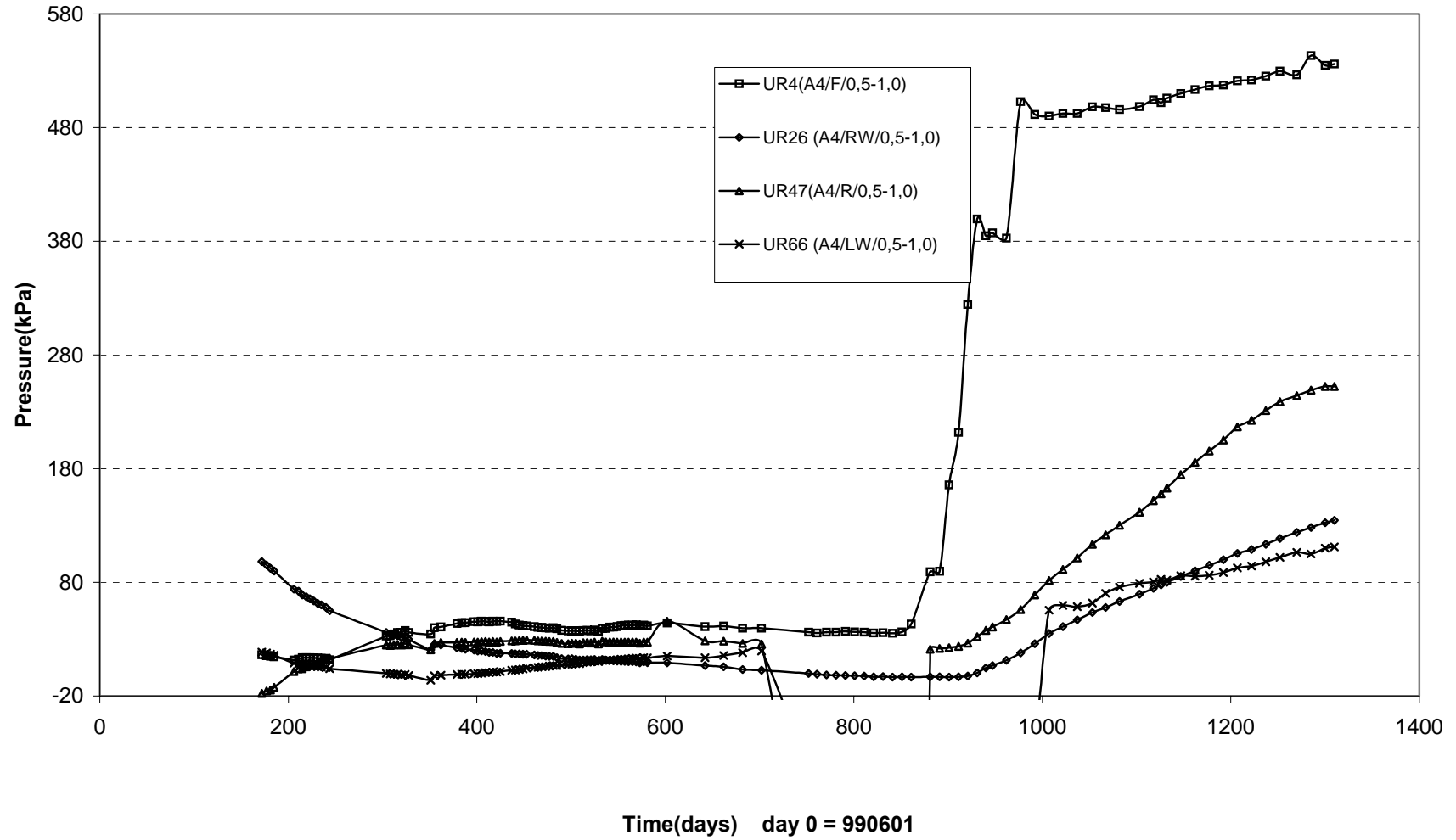

**Water pressure in bore holes section A5 (990601-030101)**  
**DRUCK**

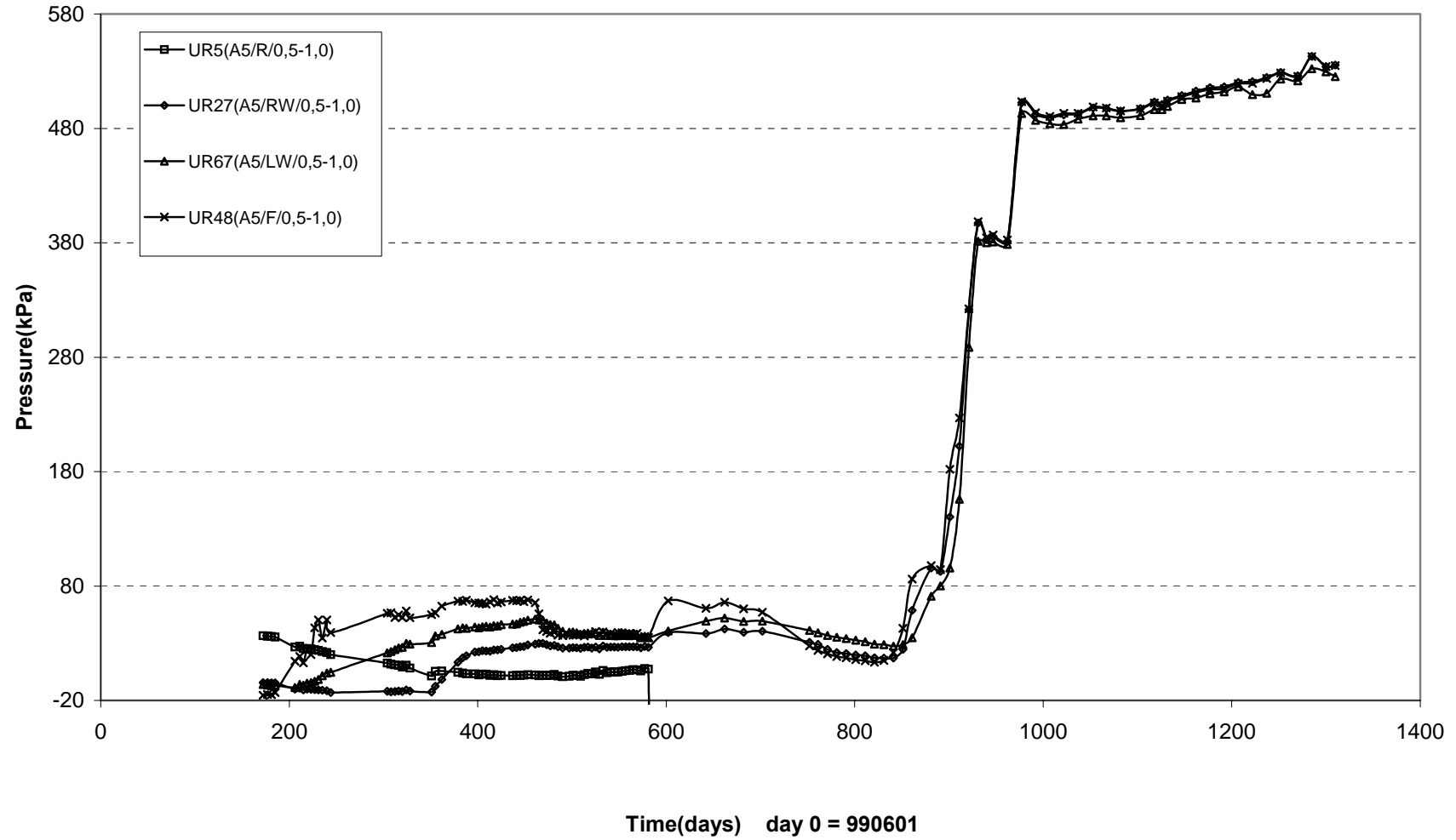

Water pressure in bore holes section B1 (990601-030101)  
DRUCK

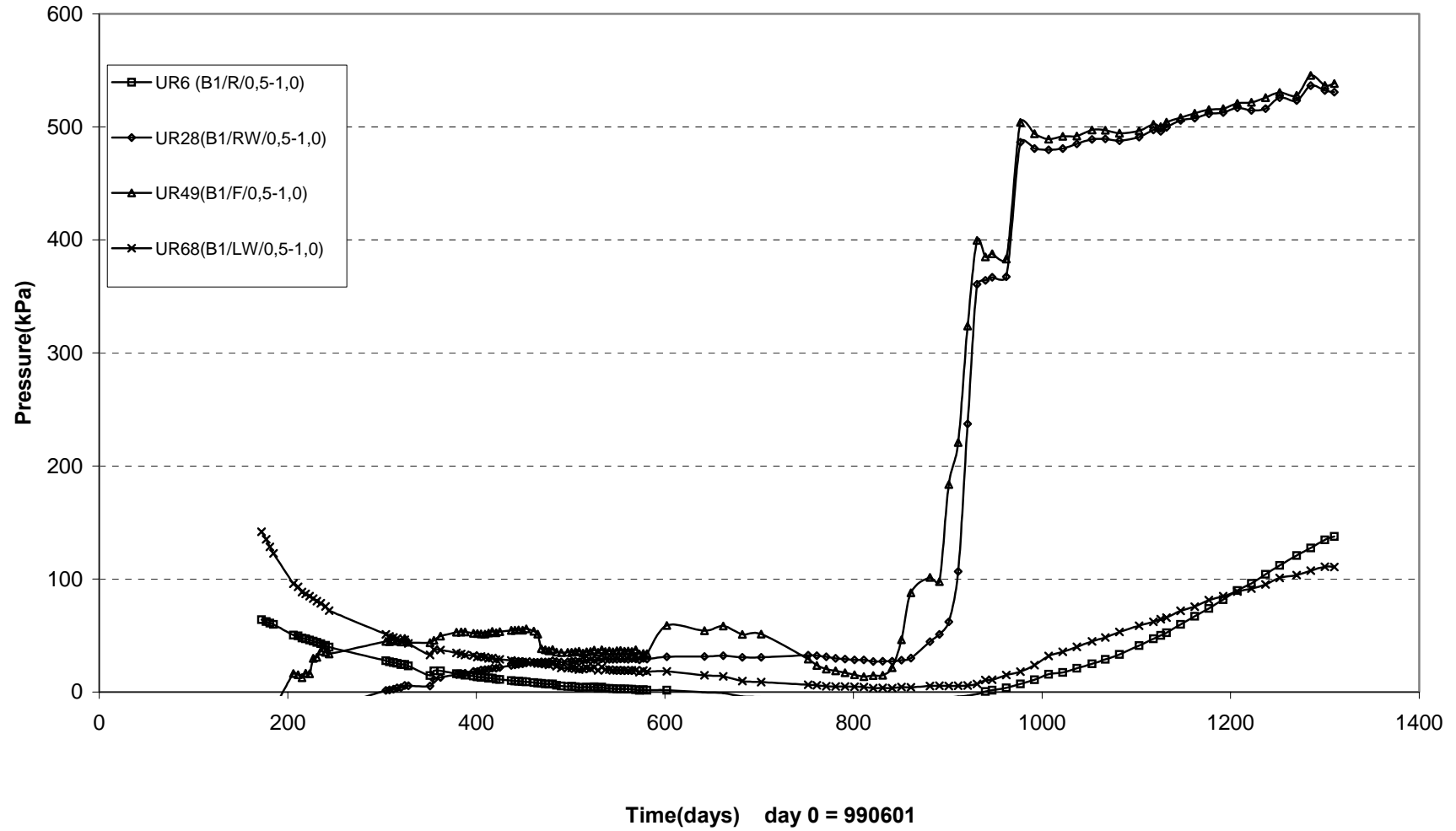



Water pressure in bore holes section B2 (990601-030101)  
DRUCK

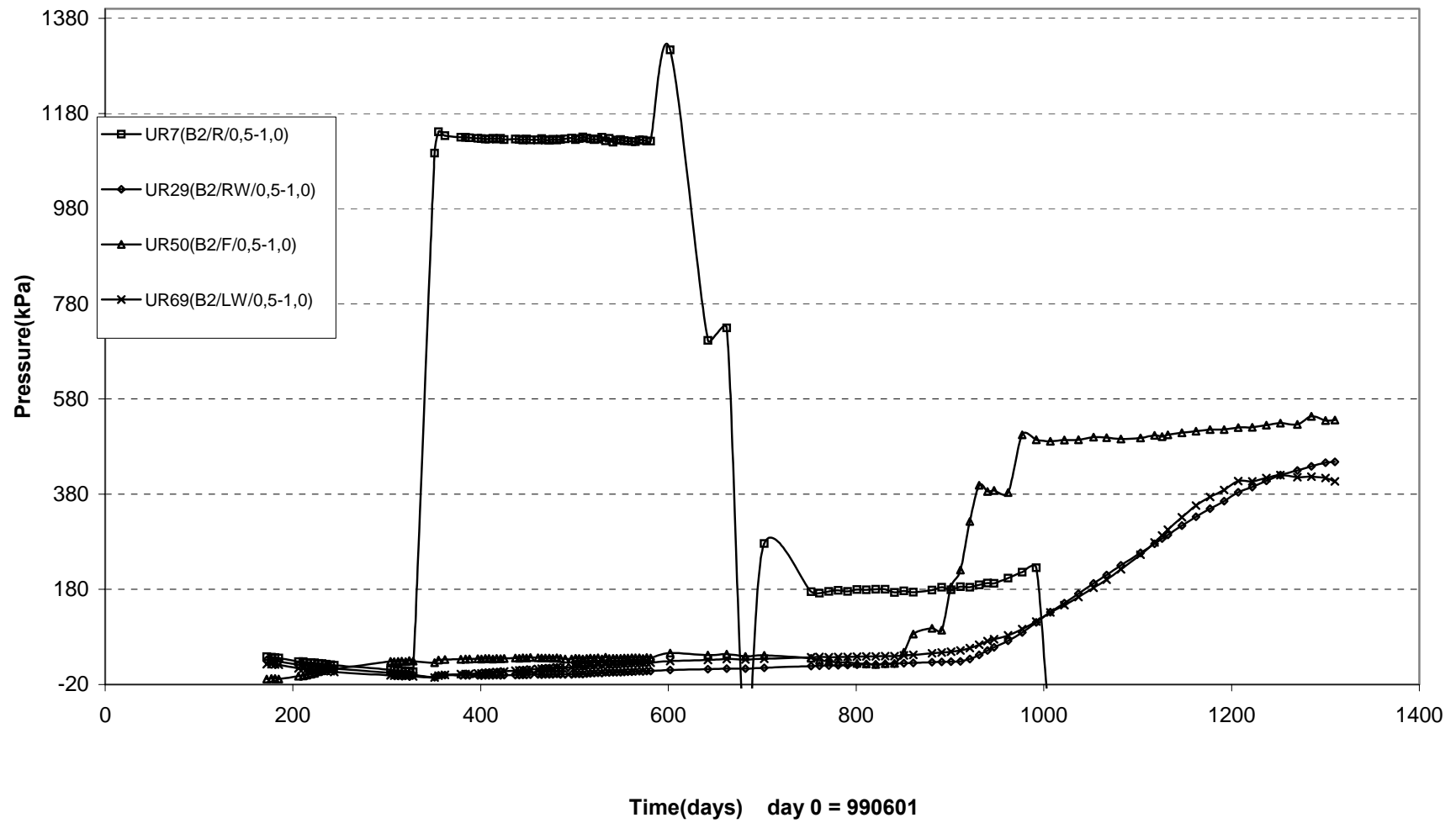

**Water pressure in bore holes section B3 (990601-030101)**  
**DRUCK**

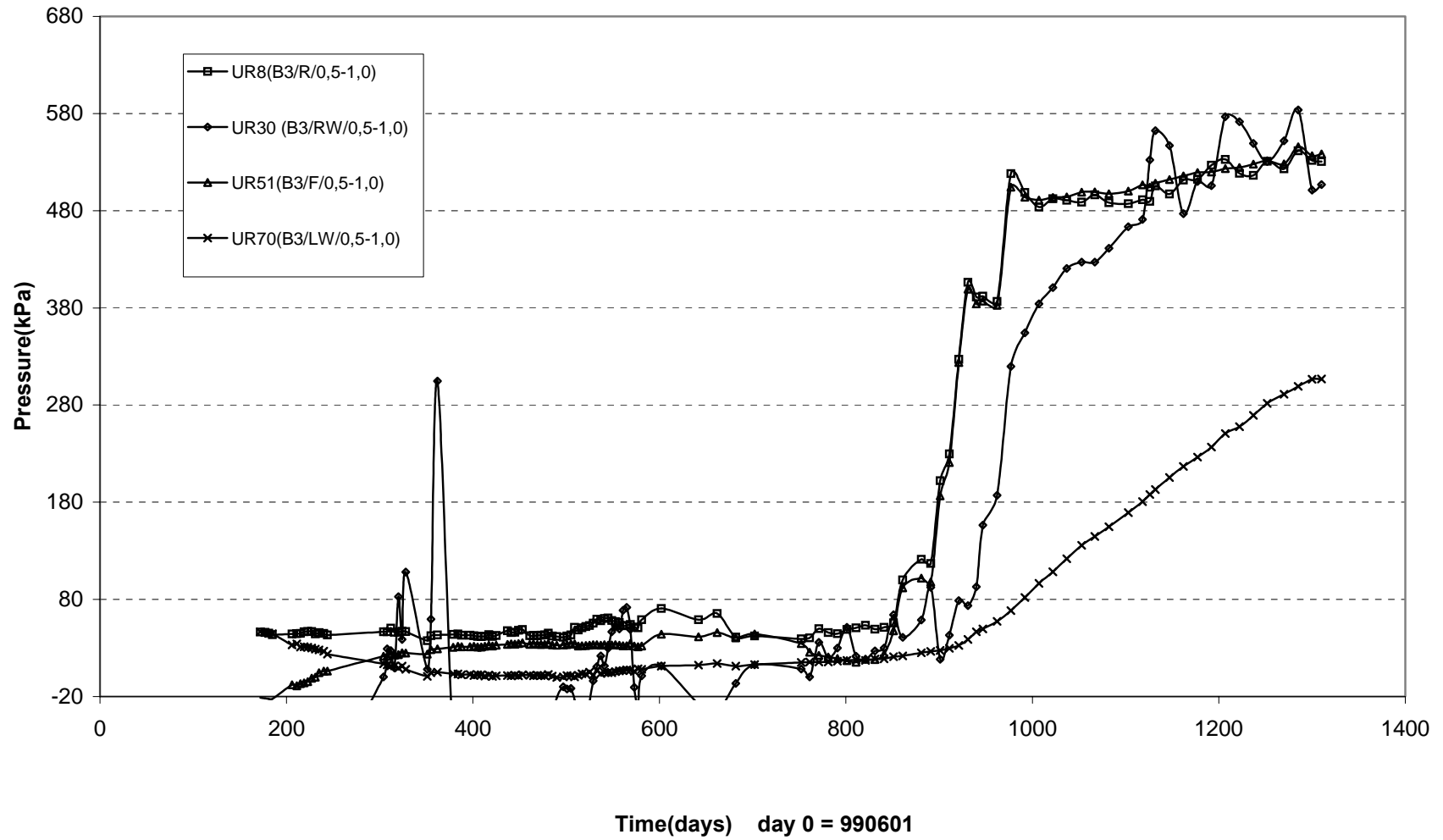

Water pressure in bore holes section B4 (990601-030101)  
DRUCK

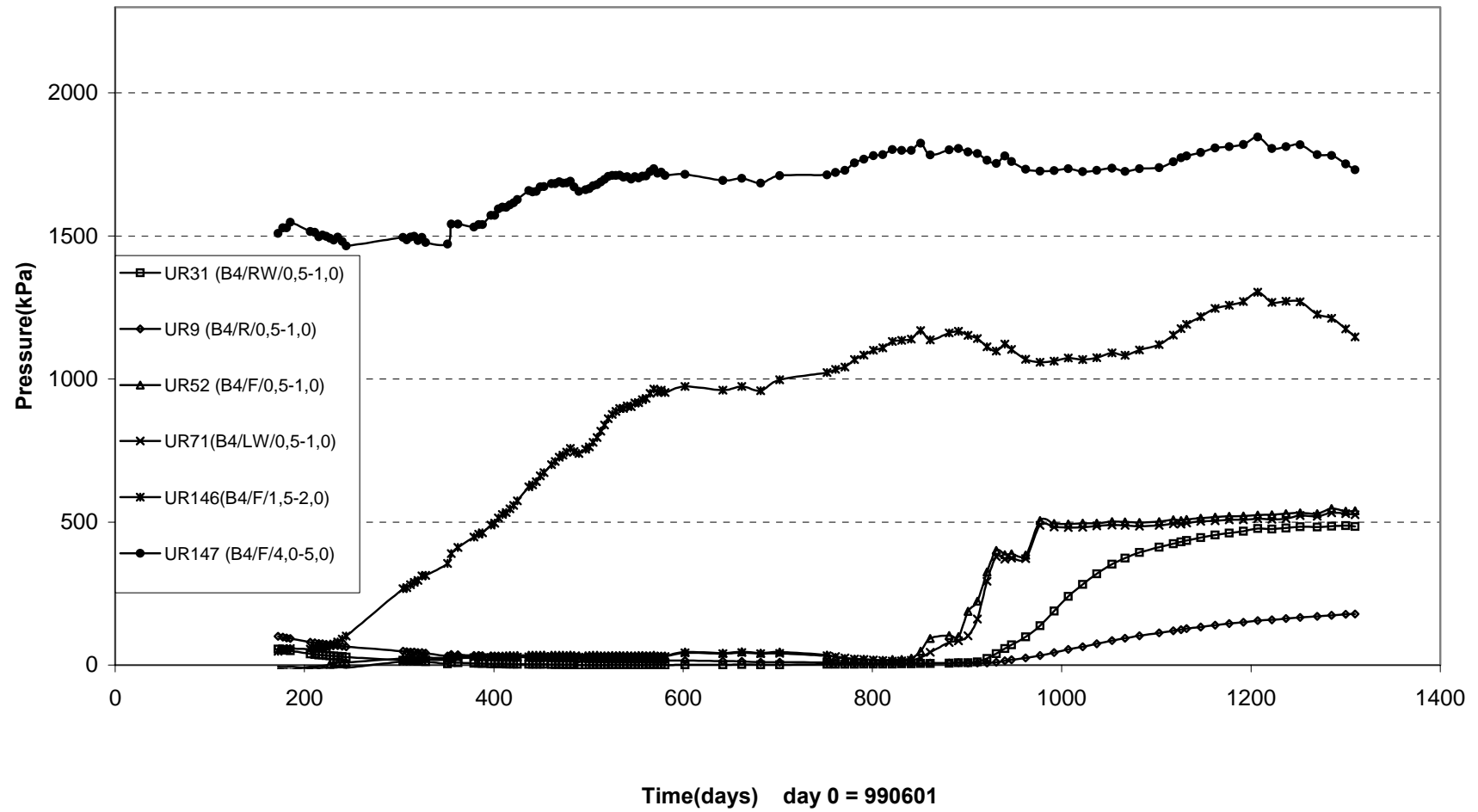

Water pressure in bore holes section B5 (990601-030101)  
DRUCK

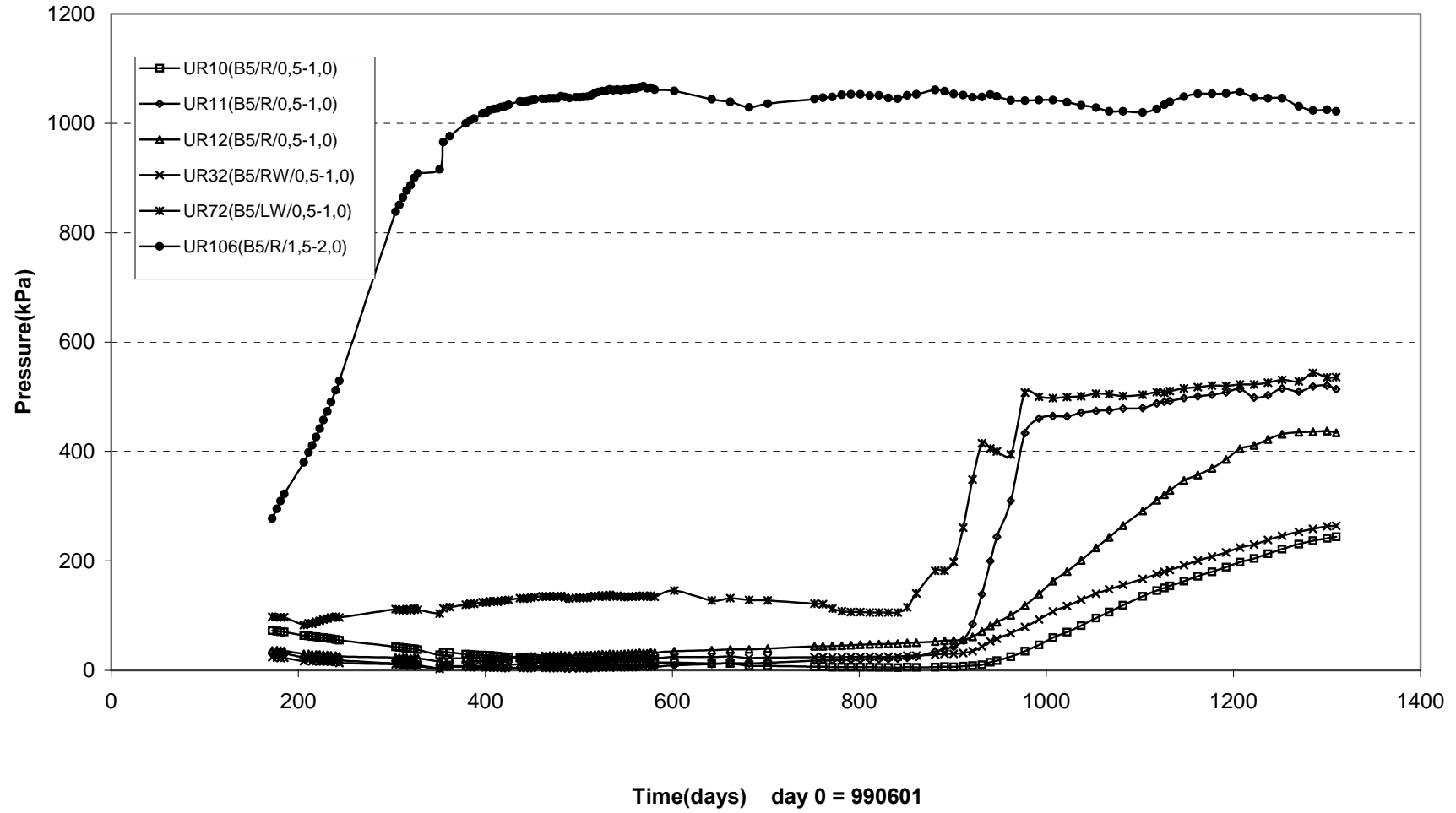

Water pressure in bore holes section B5 (990601-030101)  
DRUCK

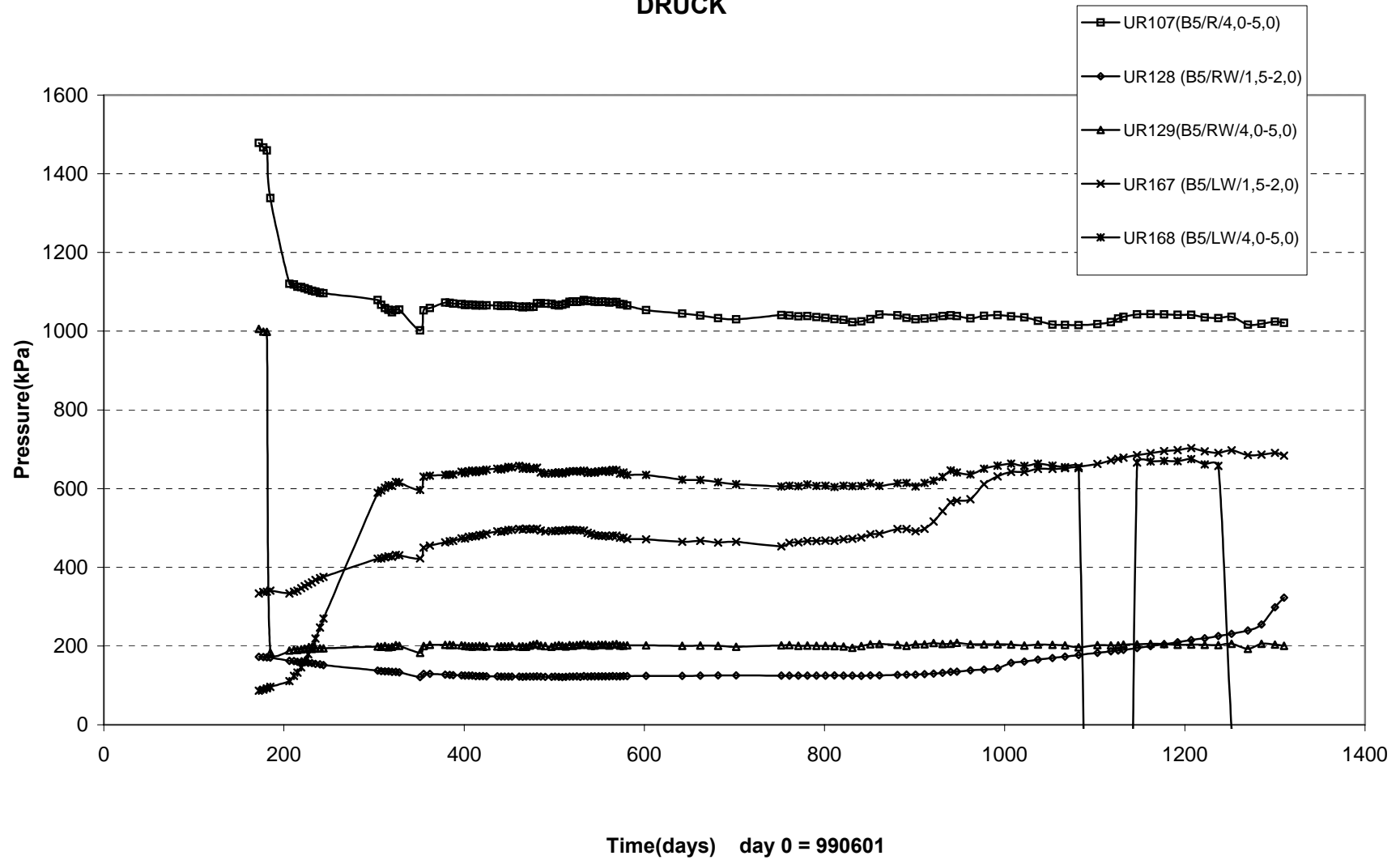

Water pressure in section A (990601-030101)  
Local Permeability Probes

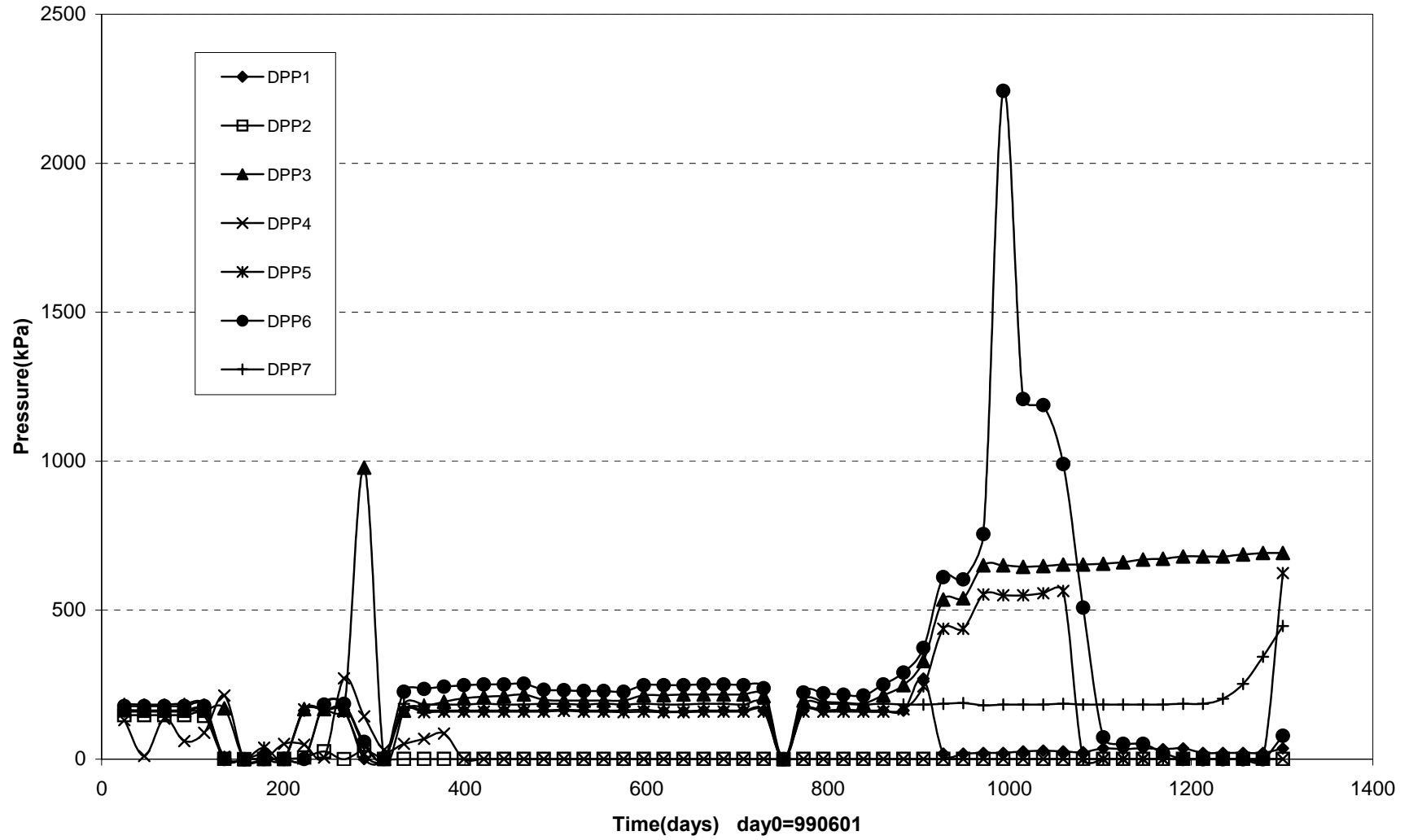

Water pressure in section A (990601-030101)  
Local Permeability Probes

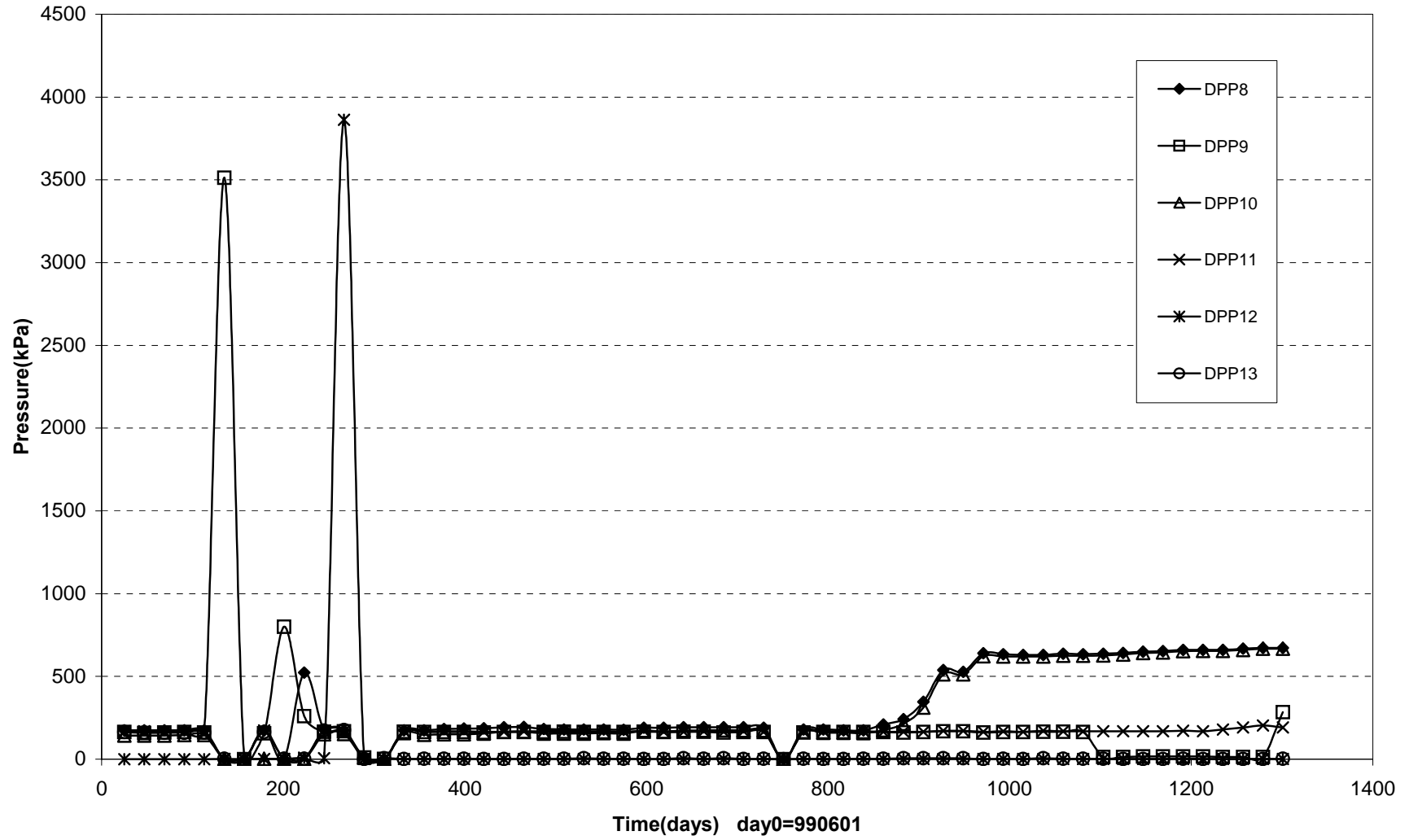

Section A4:

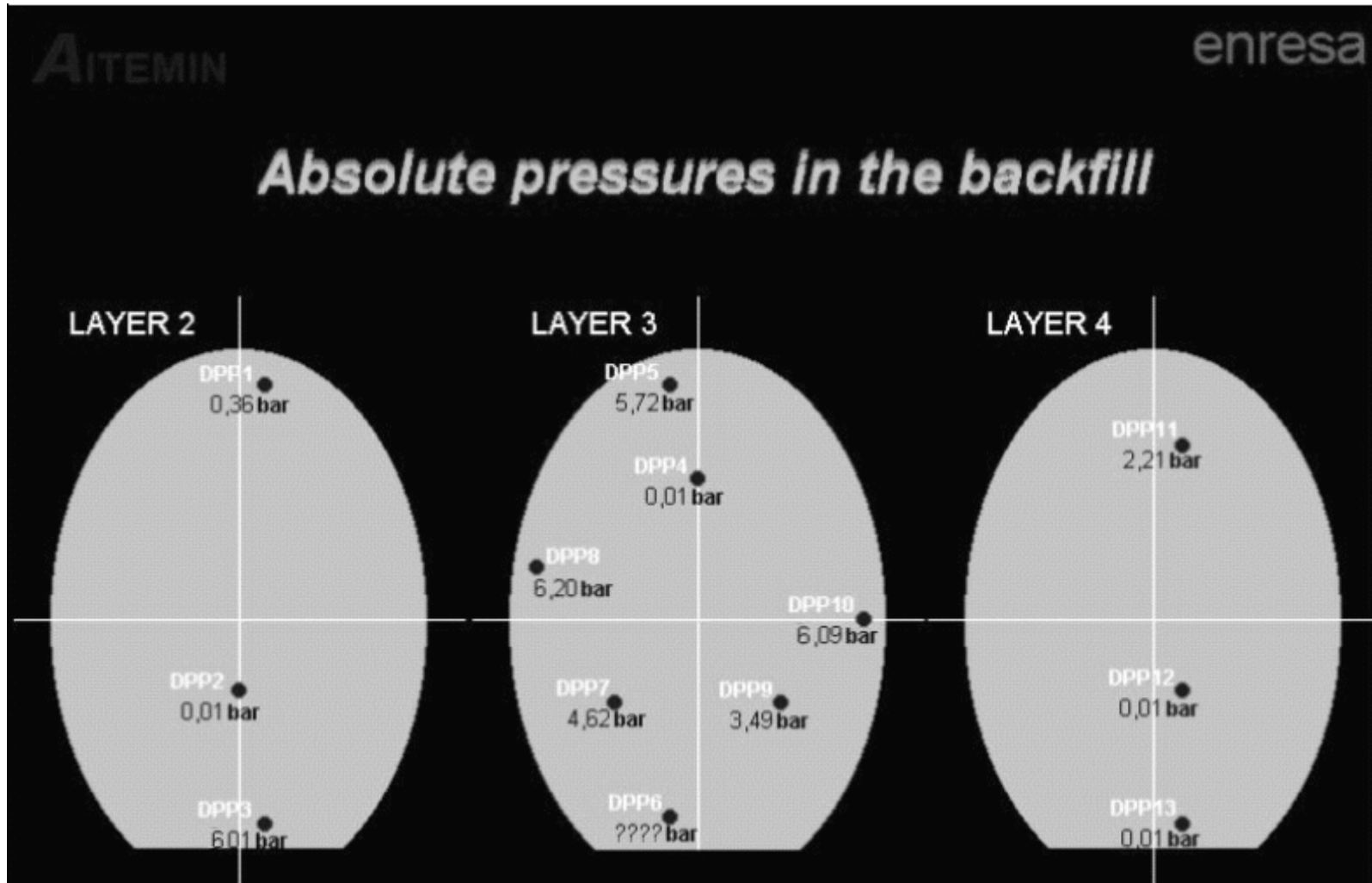



# 7 Quick guide

Layout of the test  
Numbering of backfill sections and permeable mats

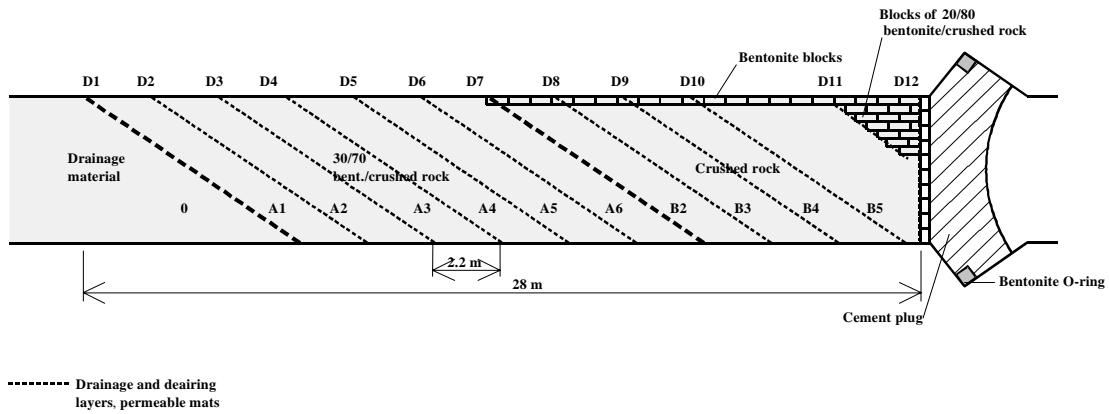

## Backfill transducer

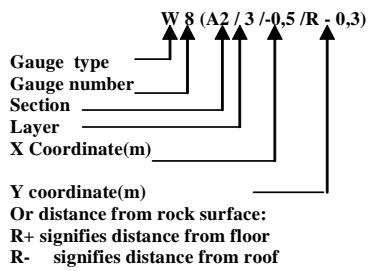

## Rock transducer

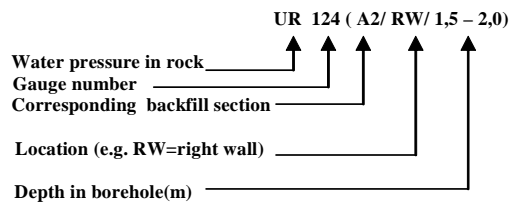

Gauge types:  
W=Water ratio  
U=Water pressure  
P=Total pressure

## Co-ordinate system

