

R-09-49

Experiences from the design and construction of plug II in the Prototype Repository

Prototype Repository

Lars-Olof Dahlström, NCC Teknik

December 2009

Svensk Kärnbränslehantering AB

Swedish Nuclear Fuel
and Waste Management Co

Box 250, SE-101 24 Stockholm
Phone +46 8 459 84 00



ISSN 1402-3091

SKB Rapport R-09-49

Experiences from the design and construction of plug II in the Prototype Repository

Prototype Repository

Lars-Olof Dahlström, NCC Teknik

December 2009

This report concerns a study which was conducted for SKB. The conclusions and viewpoints presented in the report are those of the author. SKB may draw modified conclusions, based on additional literature sources and/or expert opinions.

A pdf version of this document can be downloaded from www.skb.se.

Summary

The intention with this document is to summarise the comprehensive documentation and experience that was gained during the design and construction of the temporary plugs in the Prototype Repository experiment at Aspo HRL.

The Prototype Repository experiment was designed to in full scale test the engineered barriers and their function, including the plug that separate the deposition tunnel from the temporary access- and transportation tunnels that are at atmospheric pressure. This plug is designed and constructed as a concrete plug with a spherical front side and a flat pressurised side.

This report presents the processes and operations that were considered when developing the “plug”, design, construction and verification.

In the Prototype Repository the demand of leakage control is very high and the maximum length of the plugs is constrained due to available clearance space, experimental set-up and configuration. Therefore a typical “friction plug” normally used to block waterways in connection with hydropower plants, is not suitable. Instead a plug constructed as an “arch plug” with abutments was considered.

In order to minimize the Excavation Disturbed Zone (EDZ) the abutments, in which the plug is inserted, was excavated by seam drilling with coring technique.

The steel formwork was pre-assembled at the ground surface before taken down to the tunnel. The steel was bolted and welded together and crossbars and plywood were mounted on top. Before taken down to the tunnel, the formwork was separated into smaller pieces that were easier to transport down the tunnel but easy to assembly at the Prototype Repository experiment.

Before assembling the formwork, a retaining wall was installed to resist the earth and compaction pressure developed from the backfill material. The retaining wall consists of pre-fabricated concrete beams that were installed parallel with the installation of the backfill.

Reinforcement was cut and bent at the factory and was ready for installation when arrival on site. Parallel to the installation of the reinforcement bars, the cooling system was installed together with measurement gauges and cables.

The plug was casted with Self Compacting Concrete (SCC) mixed at the factory and continuously delivered on site. Mixing and Casting SCC is more complex than standard concrete and requires experienced and accurate personnel and a well developed control program. It is important to use correct procedures and well known ingredients when mixing SCC.

After a controlled curing, the plug was cooled down to a temperature about 10 degrees below the ambient temperature in order to facilitate better penetration and filling of grout during contact grouting process. Contact grouting is performed through pre-installed grouting tubes.

Mechanical measurements have been performed in order to monitor and verify the function and the behaviour of the plug. Stresses and deformations are not perfectly correlated between the calculated and the measured. However, the measurements show that the plug behaves as expected and that the entire plug is compressed, which was the purpose of its design.

Sammanfattning

Intentionen med detta dokument är att sammanställa och sammanfatta den omfattande dokumentation och erfarenhet som erhöles under konstruktions- och byggprocessen av den yttre temporära pluggen i Prototypförvaret vid Äspö HRL.

Prototypförvaret är ett experiment som konstruerats för att i full skala testa de barriärer som ingår i KBS-3-konceptet, inklusive den plugg som skiljer deponeringstunneln från transporttunnlarna som är under atmosfärstryck. Pluggen är konstruerad som en betongplugg med en sfärisk utsida och en flat trycksida.

Rapporten presenterar den process och det arbete som beaktades under utvecklingen av pluggen; konstruktion, byggnation och verifiering.

I prototypförvaret är kravet på inläckagekontroll mycket högt och den maximala längden på pluggen är begränsad på grund av begränsat utrymme, experimentets utformning och konfiguration. Därför fungerar inte en typisk ”friktionsplugg” som man normalt använder för att blockera vattenvägar i vattenkraftsanläggningar. Istället beaktades en plugg som utformas som en båge med upplag.

För att begränsa den störda zonen runt tunnelperiferin i samband med uttag av slitsen i vilken pluggen skall gjutas, skedde losshållningen av slitsen genom sömborring med kärnborringsteknik

Stålet i gjutformen förmonterades på markytan innan formen togs ner i tunnel. Stålet bultades och svetsades samman med fördelningsbalkar och plywood monterades på ovansidan. Därefter delades formen i ett antal tårtbitar som var lättare att transportera. Nere på experimentplatsen monterades tårtbitarna ihop.

Innan armering och form kunde sättas på plats måste en vägg monteras som fungerar som mothåll mot återfyllnadsmaterialet. Både kompakteringstrycket och jordtrycket beaktades. Väggen består av förtillverkade betongplankor som installerades parallellt med att återfyllnadsmaterialet installerades.

Armeringen kapades och böjdes i fabrik och var förberedd för direkt installation när den var på plats. Samtidigt som armeringen installerades, installerades även kylrör, instrument och kablar för mätning.

Pluggen blev gjuten med självkompakterande betong som blandades på fabrik och kontinuerligt levererades till plats. Blandning och gjutning av SCC är mer komplicerad än vanlig betong och erfordrar därför erfaren och noggrann personal och ett väl utarbetat kontrollprogram. Det är viktigt att man använder en korrekt procedur och väl kända ingredienser när man blandar SCC.

Efter en temperaturkontrollerad härdning, kylde pluggen ner till en temperatur på ca 10 grader lägre än omgivningstemperaturen för att underlätta för injekteringsmedlet att tränga in och fylla ut alla öppningar mellan betong och berg.

Mekaniska mätningar har utförts under försöksperioden för att verifiera pluggens funktion och beteende. Spänningar och deformationer är inte perfekt korrelerade vid en jämförelse mellan mätningar och beräkningar. Men mätningarna visar att pluggen beter sig som förväntat och att pluggen endast utsätts för tryckspänningar för belastningen.

Contents

1	Background	7
2	Objectives	9
3	Design of plugs	11
3.1	Design specifications of temporary plugs	11
3.1.1	Typical design criteria for pressure tunnels and shafts	11
3.1.2	Required function of the plug	12
3.1.3	Design properties	12
3.2	Construction procedures	16
3.3	Slots	16
3.4	Grouting	17
3.4.4	Curtain grouting	17
3.4.5	Contact grouting	18
3.5	Bentonite seal	18
3.6	Lead-through	18
3.7	Calculations and dimensioning	18
3.7.1	Prerequisite for the calculation and dimensioning	19
3.7.2	Numerical analyses	20
3.8	Drawings	25
3.9	Analyses of concrete cracking during casting and curing	26
3.9.1	Temperature cracks in concrete	26
3.9.2	Temperature and strength development	26
3.9.3	Calculation of cooling water temperature and effect	28
3.9.4	Procedures for temperature control	30
3.10	Construction procedures	30
3.10.1	Excavation of the insert slot	30
3.10.2	Prefabrication of concrete beams and preparations in the tunnel	30
3.10.3	Formwork and casting of plug	31
3.10.4	Environment and safety	31
3.10.5	Controlling activities with risk analyses	32
4	Construction of the slot insert	33
4.1	Prerequisite for tendering	34
4.2	Drilling and alignment control	34
4.3	Time schedule	35
4.4	Use of explosives	35
4.5	Mapping of the plug seat after extraction of rock	35
5	Plug construction	39
5.1	Work operations	39
5.2	Preparatory works	39
5.2.1	Safety course at SKB	39
5.2.2	Pre-assembly of the formwork	39
5.2.3	Installation of the retaining wall	40
5.2.4	Installation of grouting tubes	40
5.3	Formwork and casting	42
5.3.1	Reinforcement	42
5.3.2	Installation of measurement gauges	43
5.3.3	Transportation of the formwork	43
5.3.4	Reassembly of the formwork	44
5.3.5	The cooling machine	44
5.3.6	Concrete pump	45
5.3.7	Casting	45
5.3.8	Stripping of the formwork	46

5.4	Cast report	46
5.4.1	Concrete recipe	46
5.4.2	Test program	47
5.4.3	Cast methodology	49
5.4.4	Casting process	49
5.4.5	Cooling process	49
5.4.6	Inflow of water	50
5.5	Times and experiences	51
5.5.1	Time schedule	51
5.5.2	Experiences and conclusions	51
6	Contact grouting	53
6.1	Cooling procedure	53
6.2	Work procedure	53
6.2.1	Grout material	53
6.2.2	Sequence	54
6.2.3	Grout take	54
6.3	Leakage control	54
7	Instrumentation and measurements	55
7.1	Introduction	55
7.2	Objectives of instrumentation	55
7.3	Selection and installation of instrumentation	56
7.3.1	Instruments at the concrete-rock interface	56
7.3.2	Strain gauges within the concrete plug	57
7.4	Summary of selected instruments and locations	58
7.4.1	Joint meters	58
7.4.2	Embedded strain gauges	59
7.5	Rebar strain meters	60
7.6	Evaluation of raw data	61
7.6.1	Evaluation of strain from strain gauge	61
7.6.2	Evaluation of deformation	61
7.6.3	Evaluation of strain from rebar strain meter	61
7.7	Results from measurements	61
7.7.1	Joint meters and adjacent strain gauges at rock interface	62
7.7.2	During casting	62
7.7.3	During cooling	62
7.7.4	Permanent deformation of the interface at the end of 2007	63
7.7.5	Rebar strain gauges within the plug	64
7.7.6	After casting	64
7.7.7	Strain and stresses during cooling	64
7.7.8	Permanent strain at the end of 2007	65
7.8	Comparison with calculated results and verifying of construction	66
7.8.1	Maximum stress and strain	67
7.8.2	Interface deformation	67
8	References	69
Appendix I	Drawings	71
Appendix II		83

1 Background

This document will summarize the work, documentation and experiences that were gained during the design and construction of the temporary plugs in the Prototype Repository. This is done since the documentation that was produced during the design and construction period is unfortunately not properly referable according to SKB standards.

The Prototype Repository was designed to test in full scale the engineered barriers and their interaction with the host rock. The experiment was designed to the extent possible, simulating the situation for a real repository according to the SKB-3 concept /1/. All material and scale are perfectly equal to the SKB-3 concept. The radioactive waste, generating heat, was however exchanged with electrical heaters. The experiment is located at the Äspö Hard Rock Laboratory at a depth of 450 m, in the inner part of the TBM tunnel, which has a total length of about 90 m, see Figure 1-1. The length of the experiment is about 65 m.

The Prototype experiment consists of two sections for deposition of canisters. Temporary plugs were constructed to separate the two sections, in order to achieve mechanical support to the backfill material, facilitate to enhance the water pressure around the experiment and separate the experiment from the surrounding tunnel system that is operated at atmospheric pressures. The inner section contains four deposition holes with installed canisters. This section was planned to be retrieved after 20 years. The outer section contains two deposition holes with installed canisters that were planned to be retrieved after 5 years. A conceptual overview of the Prototype Repository experiment is shown in Figure 1-2. Plug II, the outer plug was comprehensively instrumented to investigate its mechanical response to the unidirectional pressure load.

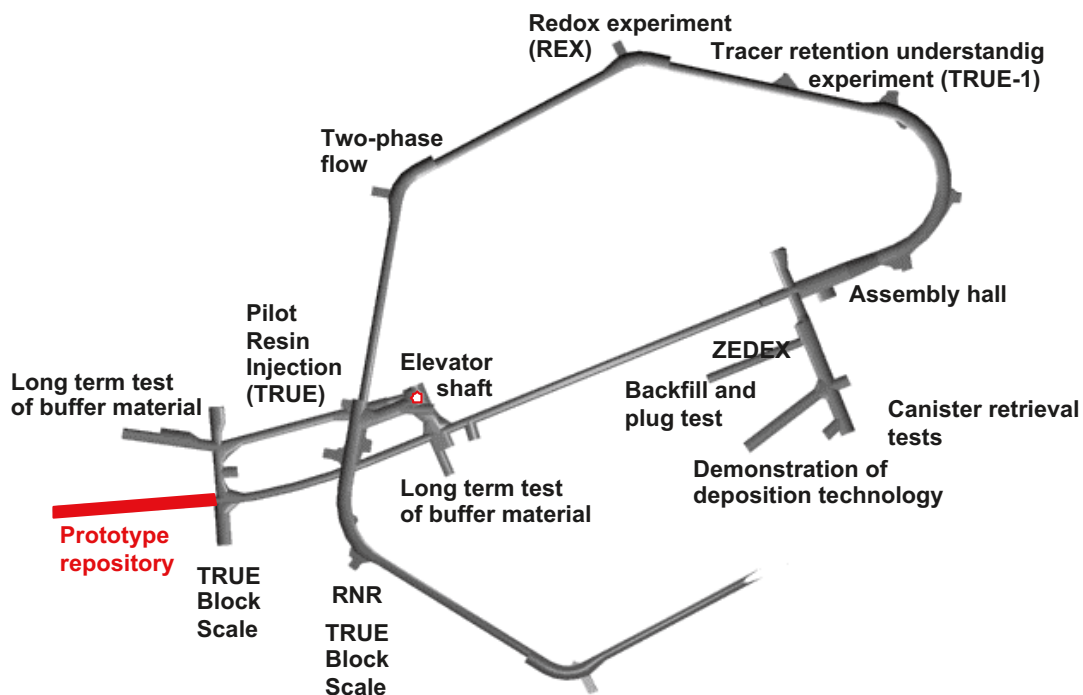

Figure 1-1. Location of the Prototype Repository.

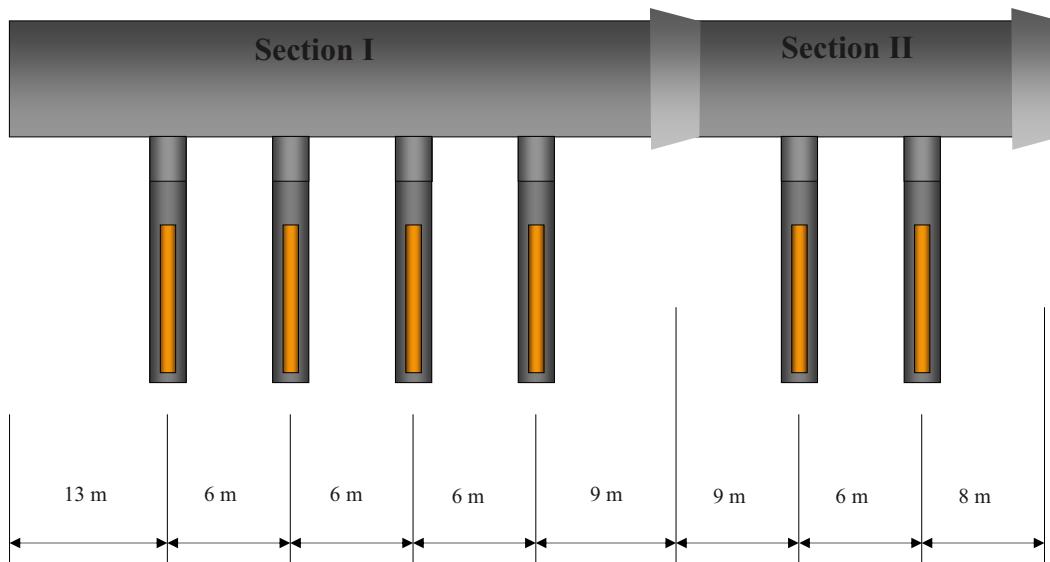

Figure 1-2. A longitudinal layout of the Prototype Repository illustrating six deposition holes with canisters embedded in buffer clay.

2 Objectives

The main objective with this document is to summarize the work that was performed in the Prototype Repository regarding design, construction and follow-up of the plug in section II that secludes the experiment from the tunnel system, in order to gather experience for the construction of the future repository.

The comprehensive documentation that was produced during the work with the Prototype Repository and in the backfill and plug experiment is reported in /2/. Since it is considered as vitally important that the design and construction experience from the Prototype Repository Experiment is secured for further work, it is important to extract valuable information regarding the temporary plugs installed in the Prototype Repository, this information is reported here.

3 Design of plugs

3.1 Design specifications of temporary plugs

The detailed plug design was preceded by a general investigation of typical plug constructions and the prerequisite for the plugs in the Prototype Repository. What are the requirements that are needed in order to fulfil the objectives of the Prototype Repository Experiment?

Even though the requirements may differ between plugs in hydro power pressure tunnels compared to plugs in a repository for radioactive waste, the principle is the same, to block water from entering areas at atmospheric pressure. However, in a repository, the tightness demand is much greater and it should also sustain the pressures that are built up by the backfill material.

3.1.1 Typical design criteria for pressure tunnels and shafts

The function of the temporary plugs in a deep repository is comparable to plugs in waterway tunnels for hydropower constructions. The plugs are located in atmospheric tunnels, such as construction access tunnels, at their intersection with unlined or concrete lined pressurized waterways, in order to control leakage. These plugs are typically constructed with mass concrete and function as “friction plugs”. They often contain a gallery to provide access for grouting and inspection. Typical design criteria for determining the required dimensions of plug according to “Design guidelines for pressure tunnels and Shafts” /3/.

- Minimum length of 1.5–2 times the plug diameter.
- Minimum length of 4.6 m.
- Maximum perimeter shear strength between concrete and rock is 0.4–1.7 MPa.

Compared to plugs in the repository for radioactive waste, some leakages in water pressure tunnels are normally accepted. Leakage around plugs is usually handled by pumping from sumps. For ease of future inspections and maintenance work, it is advisable to maintain working construction utilities, such as air, water and electricity at the plug.

Some main points to take into consideration /4/.

- The shape of the plug should have a favourable geometry as to further secure the plug into position. The abutments are recommended to have an inclination of 1:3.
- If the ratio between the minimum span and the thickness of the plug is less or equal to four, the calculations can take advantage of the compressive strength of the concrete as the load is carried purely as compressive forces in the concrete. In this way, the concrete is used most favourable while the structure at the same time through its mechanical behaviour naturally seals the support in the rock.
- The abutment should be symmetric to allow a positive structural behaviour when subjected to impact loading.

These main points are reported by the Swedish Fortification Agency; hence impact loading from weapon and explosions are considered in the barrier or plug design.

As mentioned, normal design criteria used in hydropower constructions to seal off waterways, in order to control leakage do not apply in the Prototype Repository or a future real repository. In the Prototype Repository the demand of leakage control is very high and the maximum length of the plugs is constrained due to available clearance space, experimental set-up and configuration. Therefore a typical “friction plug” is not suitable. Instead a plug constructed as an “arch plug” with abutments is considered.

3.1.2 Required function of the plug

The plugs in the Prototype Repository are designed to provide a sealing of axial water flow, to facilitate that sufficiently high water pressure could develop in the backfilled deposition tunnels.

This function requires that the plugs have low hydraulic permeability, the interface between the concrete plug and the rock is sufficiently sealed and that unfavourable orientated structures are avoided at the location for the plug or that these structures are sealed by grouting.

The Prototype Repository is located in a deposition tunnel that is excavated by a TBM, which induce fracturing around the periphery of the tunnel, and thus an increased hydraulic conductivity. However, compared to drill and blast techniques, this fractured zone (Excavation Disturbed Zone, EDZ) is very small. For a TBM excavated tunnel the EDZ, based on experiments, is estimated to about 0.03 m.

In order to cut off water flow through this EDZ-zone, the plugs shall be inset in a slot with a minimum depth of about 0.1 m. For a TBM excavated tunnel, the depth of the slot is instead a question of the required mechanical support. For a deposition tunnel excavated by drill and blast the slot to cut off water flow must be much deeper (1 to 2 m) depending on blasting techniques and design.

The plugs will also serve as mechanical support for the backfill material. However, the concrete plug is constructed after backfilling, which requires a retaining wall on the inside of the plug to be constructed. This retaining wall should be designed to handle the earth pressures that can be developed during backfilling and swelling during the construction period and the time that must pass before you can allow the plug to take load. In the Prototype Repository, the required earth pressure was concluded to about 100 kPa.

3.1.3 Design properties

Localization of plugs within the deposition tunnel and with requirements according to the KBS-3 concept requires an accurate investigation. Good rock condition is essential, no loose rock and no or only a few small water bearing fractures can be allowed. Therefore certain flexibility in the localization is required. In the Prototype Repository the location of the two plugs were very much constrained due to the lay out of the prototype experiment and only minor flexibility (a few meters) was allowed to locate the plug in an area of suitable rock condition. The centres of the two plugs are located at section 3/560 and 3/537, respectively. The geological conditions at these locations are displayed in Figure 3-1, a drawing that present the geological features achieved from tunnel mapping.

In order to achieve sufficient water pressure over all deposition holes and provide space for grouting without affecting the fractures in the deposition area, the distance between the centre of the plugs and closest deposition hole was determined to be ≥ 8 m.

Numerical analyses were performed in order to calculate stresses for dimensioning and to study the behaviour and verify the design of the concrete plugs. Two models were considered early in the design process.

1. The plug is assumed to be ideal supported by hard rock. In this case the inclined support is simply a fixed support.
2. The plug is assumed to interact with the rock and the contact between the plug and the rock is frictional.

Design pressures

The test site is located at about 450 m depth, and the maximum water pressure, i.e. the undisturbed ground water pressure is about 4.5 MPa. The test site is surrounded by tunnels that during the test period will be under atmospheric pressures, and thereby affect the ground water pressure, thus lower hydrostatic pressures acting against the plug may be expected. However, in boreholes at and close to the tests site, a pressure of about 3.8 to 4.3 MPa had been registered close to the tunnel wall. This demonstrates that water pressure does not necessarily reduce close to the tunnel surface at atmospheric pressure. Instead the water and pressures is constrained to certain fractures. Therefore a design pressure of 4.5 MPa was considered.

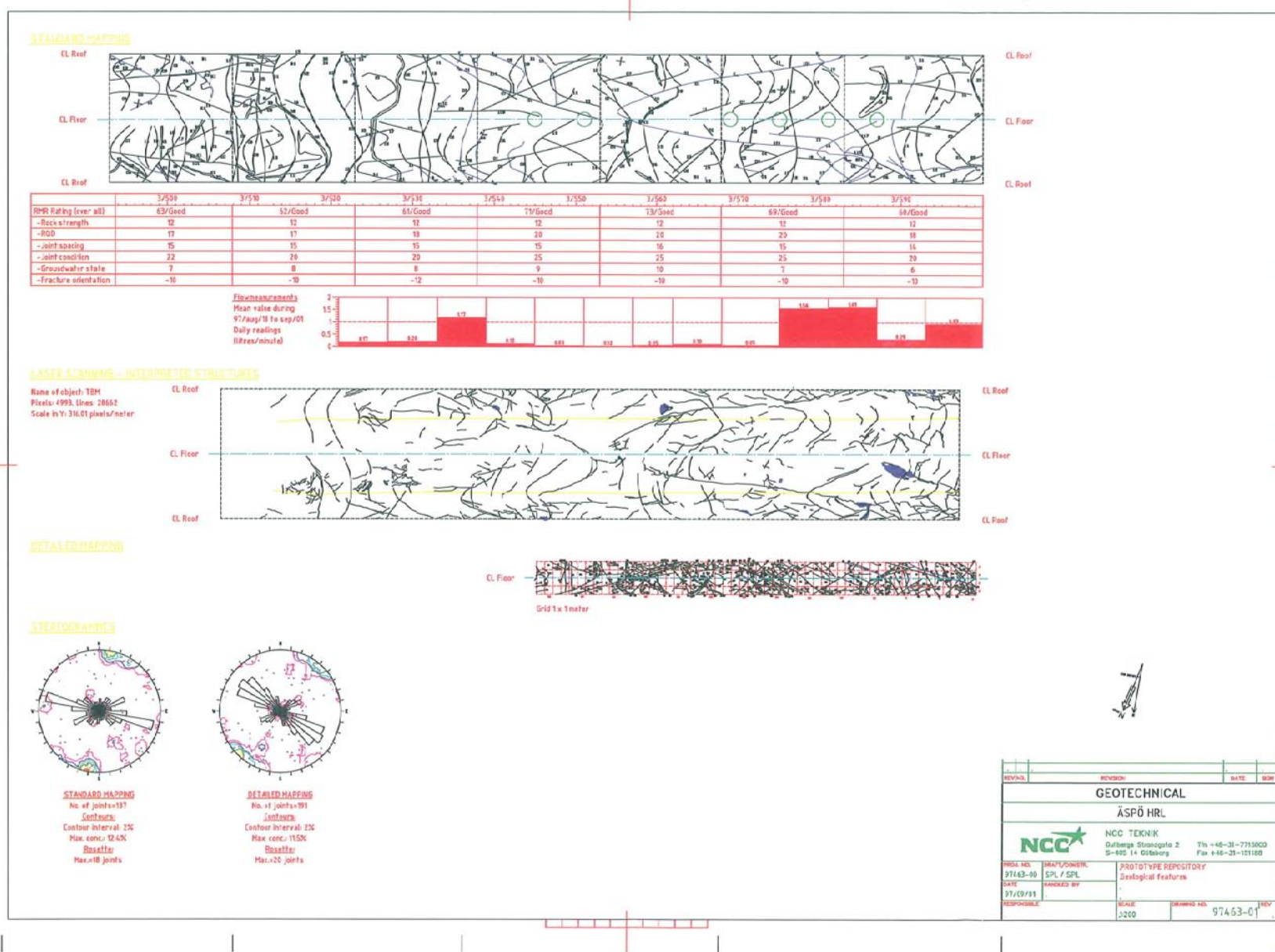

Figure 3-1. Geological features at the Prototype Repository Experiment location /5/. Plug I and II are located at chainage 3/560 and 3/537, respectively.

Retaining wall

In the Prototype Repository experiment, backfilling of the deposition tunnel was performed by compacting a mixture of bentonite and crushed rock. This requires, in order to achieve a vertical wall of backfill material that perfectly fill the area from bottom to roof, a retaining wall of concrete beams to be installed parallel to compaction of the backfill when finish backfilling at the plug location. Figure 3-2; shows an early principle outline of a plug, including the concrete beams.

The requirement was that the retaining wall supporting the backfill should be designed to handle an estimated earth pressure of 100 kPa that may develop during backfilling and construction of the plug. Water pressure will not affect the retaining wall since water is allowed to path through the contact between the concrete beams.

Time consideration

The Prototype Repository experiment was well defined in time. Section I was supposed to be excavated after 20 years and section II after 5 years. Therefore, the requirement was that the plugs should be designed for a minimum of 20 years and considerations were also taken that the plugs should be removed after 5 and 20 years respectively. However, these requirements had little effect on the design. With the design chosen the plugs could as well sustain a period of hundreds of years.

Mechanical properties of rock at Äspö

Results from laboratory testing of intact core samples taken from the TBM tunnel are given in Table 3-1 and Table 3-2. The properties presented below shall be considered as characteristic values.

Table 3-1. Mean values of mechanical properties from laboratory testing of rock specimens taken from the TBM tunnel, ÄSPÖ Hard Rock Laboratory /5/.

Parameter	Mean value	Std. Dev.
Uniaxial compressive strength (MPa)	195	31
Young's modulus (GPa)	69	5
Poisson's ratio	0.25	0.03
Tensile strength (MPa)	16	3
Internal friction (°)	45	3
Cohesion (MPa)	47	4

Retaining wall of
concrete beams

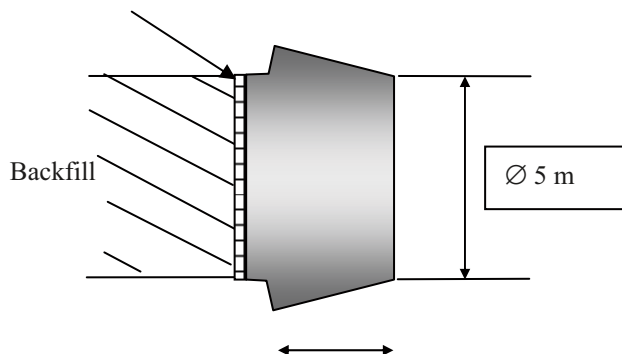

Figure 3-2. Outline of the plug including the retaining beam wall.

Table 3-2. Mean values of mechanical properties from laboratory testing of rock specimens taken from the Prototype Repository test site.

Parameter	Mean value
Uniaxial compressive strength (MPa)	219
Young's modulus E_{ini} (GPa)	80
Young's modulus E_{50} (GPa)	73
Poisson's ratio, ν_{ini}	0.21
Poisson's ratio, ν_{50}	0.28
Tensile strength (MPa)	14.7
Internal friction (°)	44
Cohesion (MPa)	49

Table 3-1 and 3-2 represent the strength and deformation properties of intact rock samples, however, when designing the plug and its abutment the strength and deformation of a greater rock volume must be considered.

According to classification of the lower part of the TBM tunnel (the Prototype Repository tunnel), the RMR (Rock Mass Rating) value varies between 60 and 75, i.e. rock mass class II described as good rock. Guideline properties of rock mass classes, after Waltham /6/ give a friction angle of the rock mass of 34–45°.

For RMR values > 50, the in-situ deformability of rock masses may be estimated by using the following correlation, after Bienawski, /7/:

$$E_m = 2 \times RMR - 100 \Rightarrow 20 - 50 \text{ GPa}$$

Young's modulus of rock masses (RMR ≤ 50) may be estimated by using the correlation proposed by Serafim and Pereira /8/

$$E_m = 10^{(RMR - 10)/40} \Rightarrow E_m = 18 - 30 \text{ GPa.}$$

According to RMR classification at the Prototype Repository, the inner and outer plug will be located in an area where RMR is about 70 and 60, respectively. This corresponds to a characteristic Young's modulus of 50 and 20 GPa.

The safe bearing capacity or safe rock mass strength, to be used in the design work is about 10 MPa, based on Waltham /6/ and Hoek and Brown /9/.

The friction coefficient (μ) between rock and concrete is given in "Byggtabeller MO2", to 0.75.

Design Guidelines for Pressure Tunnels and Shafts published by EPRI /3/, state the maximum perimeter shear stress between concrete and rock to 0.4–1.7 MPa.

A summary on estimated characteristic data on rock mass properties are given in Table 3-3.

Table 3-3. Determined characteristic properties of rock mass conditions used in the design.

Parameter	Value
Uniaxial compressive strength (MPa)	10
Tensile strength (MPa)	0
Young's modulus (GPa)	25
Poisson's ratio	0.25
Friction angle of the rock mass	40
Cohesion (MPa)	5
Friction coefficient between rock and concrete	0.75
Maximum perimeter shear stress between rock and concrete (MPa)	1.5
Water pressure (MPa)	4.5

3.2 Construction procedures

To meet the function requirements of the plug, a number of technical aspects have to be considered, where the main concerns refer to leakage:

- Prevent leakage through the adjacent rock encircle the plug location, by careful excavation of the disturbed zone.
- Prevent leakage through the plug or the interface between the plug and the rock.
- Prevent leakage through intersecting conductive discontinuities that have direct contact with the tunnel at atmospheric pressure.
- The plug shall be designed for hydraulic pressures up to 4.5 MPa and a backfill pressure of 100 kPa.
- Minimum of reinforcement, in order to simplify the removal of the plug after operation.

To prevent leakage through the Excavation Disturbed Zone (EDZ) the plugs are inserted in carefully excavated (by seam coring) slots. These slots also function as mechanical support/abutments that transfer and distribute loads to the rock and prevent slip. Leakage through conductive discontinuities is prevented by curtain grouting at the plug location.

To prevent leakage through the plugs and/or the interface between the plugs and the rock, the plugs must be in contact with the rock over its full length and cracks in the mass concrete can not be allowed to act as hydraulic paths.

Alternative measures to handle this were considered and may be summarized as follows. The alternatives are just concepts, and can only be considered as possible methods.

1. Casting by conventional method. The plug is cooled during curing to a temperature; about 10°C below the environmental temperature to reach a target temperature of about 5°C. Contact grouting is performed after required curing time. The cooling procedure is closed after grouting and the plug is let to expand. The plug will in this way be pre-stressed, and compensate for eventual further shrinkage.
2. Concrete casting by conventional methods. Curing temperature is controlled by cooling as above, in order to secure against cracking. After required curing time the cooling is continued, to allow for further contraction before contact grouting is performed. Grouting is performed in tubes that are installed before casting. After grouting the plug is let to expand. Grouting at this lower temperature will facilitate a better filling of grout and to a greater extent a pre-stressed plug. Both effects greatly influence the tightness of the plug.
3. Cast the plug extremely slow, about 0.1 to 0.2 m/hour in several steps and cool before casting the next step. Alternatively the procedure can be complemented with tubes for circulation of cooling water. When the casting procedure is completed the temperature has to decrease to the ambient temperature. This may take several months. The temperature is controlled by temperature gauges installed during casting. Contact grouting is performed according to 2. Several separated systems with tubes for grouting are installed during casting. Separate systems allow for pre-grouting in several steps.

The third concept may be less costly but take much longer time.

A thorough description of the performed construction procedure is given in section 5.

3.3 Slots

The slots have to be excavated with great care in order to minimize fracturing in the tunnel periphery. Blasting techniques are only acceptable if the technique do not affect the remaining periphery, i.e. induce fracturing that may act as potential flow paths.

The slots may be excavated with coring or percussion drilling. However, deviation must be considered. Alternative, as sawing, or any other method may be used, but cost and fracturing of the periphery must be considered.

When designing the slot depth and angle, an optimization procedure is required that considers “minimum slip” condition and a minimum of reinforcement. Further, the depth of the slot should be such that the EDZ is cut off.

Finally core drilling with a developed rig was chosen as the best economically and controllable alternative. The circular shape made it difficult to saw the slot, and percussion drilling may cause deviation problem.

3.4 Grouting

Both curtain and contact grouting was considered in order to seal off unfavourable orientated fractures that may work as axial flow paths and to seal off eventual flow paths between the plug and the rock surface.

3.4.4 Curtain grouting

Figure 3-3 illustrates the principle of a typical systematic configuration of boreholes for producing a grouting curtain for leakage control. However, if curtain grouting is needed, the final configuration, length and orientation, will be determined at site, after construction of the slot. Typical length of holes is between 3 and 5 m. Grouting pressure is limited, since the grouting will be performed against a free surface.

It is important that the grouting is performed in a very controlled way, since the grouting curtain should be very limited in space. Fractures in the area of the deposition holes shall not be sealed and disturbed by the grouting. In order to gain good control, stable grout should be used.

After construction of the plug, high pressure grouting may be performed in boreholes drilled from outside of the plug. In the Prototype all curtain grouting was supposed to be performed with cement based grout.

Curtain grouting was later never executed. It was considered that there was a considerable risk that curtain grouting in a not acceptable degree could change the assessed hydro geological condition and disturb the experiment. It was also concluded that contact grouting should have an adequate effect by also grouting the rock close to the plug and not only fill the contact between the rock and the plug.

The leakage of water that was considered to disturb the casting process and deteriorate the concrete quality was drained through holes drilled in the adjacent rock encircled the plug location.

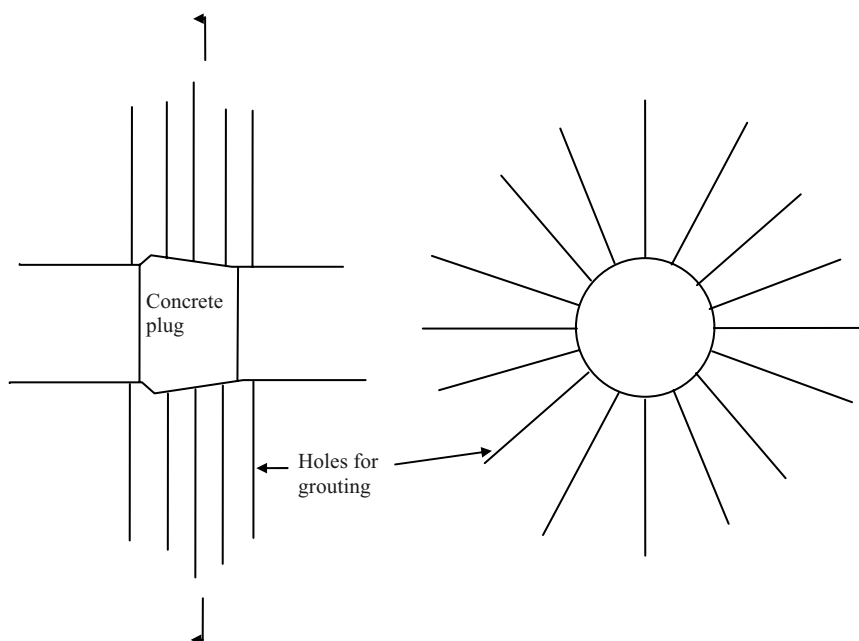

Figure 3-3. Principle layout of a typical grouting curtain for leakage control.

3.4.5 Contact grouting

Contact grouting is performed between the rock surface and the plug. Normally, if the plug is equipped with a manhole, contact grouting around a plug is performed by drilling grouting holes perpendicular to the interface between concrete and rock. However, since the plug will be constructed as a homogenous body and no entrance possibilities are required, this is not possible. Instead, inclined holes may be drilled from outside and through the plug and the interface between the plug and rock. As an alternative to grout holes, tubes for injection of grout may be installed against the rock before construction of the formwork. This alternative was finally chosen for the plugs in the Prototype. Several separate tube system should be placed and the system may also be used for sealing off possible leakage after the operation of the Prototype Repository has started. Contact grouting is preferable performed by micro cement. If the result with the cement product is questionable, contact grouting procedure can eventually be performed by using chemical products. For Plug II, in the prototype a combination of micro cement and silica sol was used. If a chemical product is used it shall be accepted by the client, organic material is not favourable in conjunction with a “deep repository” and must be handled with care. Material that may contaminate the environment shall not be used.

3.5 Bentonite seal

Experience from several cases has shown difficulties to perfectly seal off water flow in the interface between rock and concrete. This fact has been considered in the design of the plug for the Backfill and Plug Test, in which case a seal of compacted bentonite has been placed around the periphery at the pressurized side. However, it is believed that in the Prototype Repository required seal-off may be handled without the bentonite O-ring, by pre-shrinking the plug, carefully perform the contact grouting and afterwards stop the cooling procedures and allow the plug to expand.

3.6 Lead-through

The Prototype Repository experiment will be equipped with a great amount of instruments for monitoring of processes and the heat produced by the radioactive waste will be simulated by electrical heaters. The instruments and the heater system require cables and tubes to be lead out from the test sections and out to the tunnel system. Most cables and tubes are fed through boreholes in the rock and in to a parallel tunnel. However, a minor number of tubes for sampling of water, for chemical analyses, are fed through the outer plug. In the case when tubes and cables are fed through the plug, it is required that the lead-through is sealed off from axial water flows between the lead trough pipe and the concrete. The lead-through must be designed to perfectly seal-off water flow.

The lead-through aggravating circumstances in the prototype repository is not required in a real repository since its only purpose is to seal off the backfilled tunnels from the outer tunnel system.

3.7 Calculations and dimensioning

The final appearance of the plug is shown schematically in Figure 3-4 and in drawings presented in Appendix I. The pressure side of the plug has a plane surface whereas the side facing the outer tunnel system with atmospheric pressure is concave with a rotational parabolic shape. The thickness of the plug at the symmetric axel is 1.2 m.

The parabolic shape together with the resilient and elastic support, give a construction with absolute dominantly compressive stresses, when loaded.

3.7.1 Prerequisite for the calculation and dimensioning

Regulations

The plug is designed according to following regulations

Boverket: Byggregler, BBR 7, BFS 1993:57

Konstruktionsregler, BKR 3, BFS 1993:58

Handbok om betongkonstruktioner, BBK 94, band 1 och 2

Handbok om stålkonstruktioner, BSK 99

Loads

Unidirectional water pressure

$$Q_k=4.5 \text{ MPa}$$

Corresponding to an Ultimate Limit State according to BKR 3 2:321

$$Q_d=1.3 \times 4.5=5.85 \text{ MPa}$$

Earth pressure

The prefabricated wall is dimensioned to withstand a pressure from the backfilling material.

$$Q_k=100 \text{ kPa}$$

Corresponding to an Ultimate Limit State according to BKR 3 2:321.

$$Q_d=1.15 \times 100=115 \text{ kPa}$$

Material

General classes

Table 3-4 shows the dimensioning classes considering safety, environmental aggressiveness and life time aspects.

Concrete

The concrete class is BTG I K50 VT corresponding to concrete characteristics according to BKR 7:221, Table 3-5.

Table 3-4. Material classes.

Class		Comment
Safety class	SK3	
Environmental class	B4	very aggressive condition for concrete
	A3	Very aggressive for reinforcement steel
Life time	L2	≥ 100 year

Table 3-5. Concrete characteristics.

Compressive strength	$F_{\text{ccd}}= 35.5$
Tensile strength	$F_{\text{ctd}} = 2.25$
Young's modulus	$E_d = 34.0$
Poisson's ratio	$\nu = 0.2$
Considering the safety class 3 these values correspond to	
Compressive strength	$F_{\text{ccd}} = 35.5 / (1.5 \times 1.2) = 19.7 \text{ MPa}$
Tensile strength	$F_{\text{ctd}} = 2.25 / (1.5 \times 1.2) = 1.25 \text{ MPa}$
Young's modulus	$E_d = 34.0 / (1.2 \times 1.2) = 23.6 \text{ MPa}$
Poisson's ratio	$\nu = 0.2$

Reinforcement

Reinforcement Ks500T

According to BKR3 7:231 Ks500T has a characteristic tensile strength of

$$F_{yk} = 500 \text{ MPa}$$

Corresponding to a ultimate limit strength of

$$F_{st} = 500 / (1.15 \times 1.2) = 362 \text{ MPa}$$

Concrete cover = 40 mm, Table 3-4

Host rock

See Table 3-3.

3.7.2 Numerical analyses

Stresses, displacements and deformations of the plug are calculated by a finite element analyses. The plug is typical rotational symmetric and allow for an axial symmetric model. The element configuration in the rotational plane is shown in Figure 3-4. The analysis uses four nodal elements.

The calculations were made by using the finite element program ABAQUS version 5.7.

As discussed earlier, the intersection between the concrete plug and the rock support may either ideal supported as a fixed support, i.e. the plug is perfectly fixed to the hard rock wall, and alternatively the plug is assumed to interact with the rock and the contact between the plug and the rock is frictional.

The characteristic Young's moduli of the rock, used in the calculations are 25, 50 and 75 GPa.

Results from the calculations are given in Appendix I, and is presented with reference to the rotational plane.

Reinforcement

The calculations show that only a minimum reinforcement is required, since the plug is only affected by compressive stresses. Minimum reinforcement is required according to codes to control cracking and minimize fracture width.

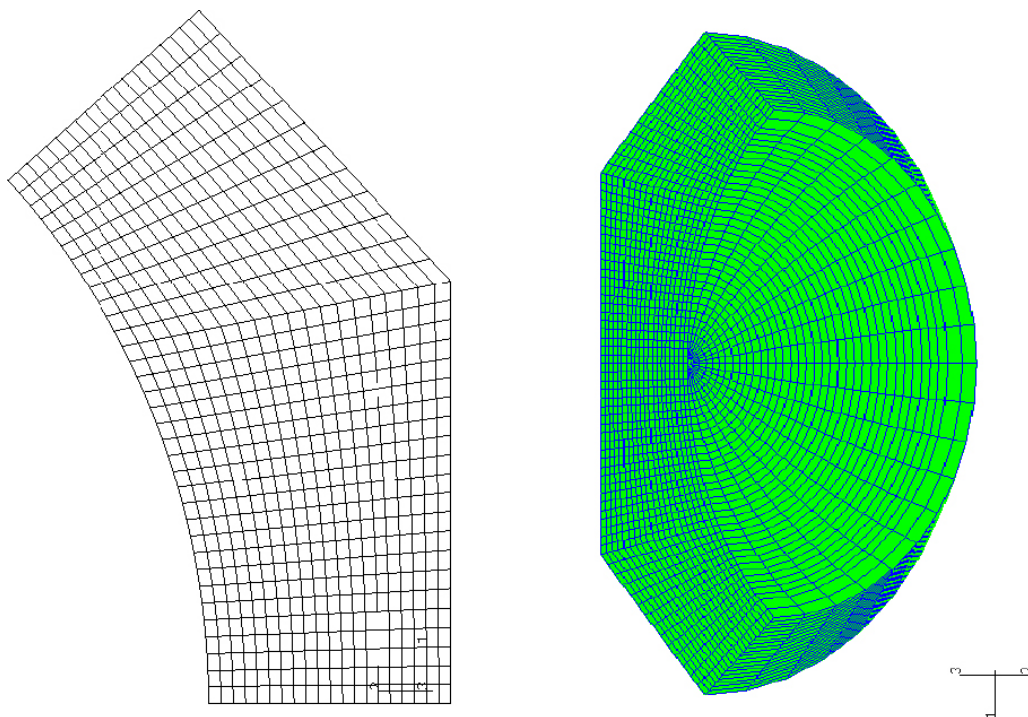

Figure 3-4. The element configuration in the rotational plane.

The pressurised side of the plug is reinforced, Ø25 s 300 conically, and radially Ø25 s_{max} 300.

The concave surface and the support surface against the rock are reinforced conically, Ø25 s 200 and radially Ø25 s_{max} 200.

Results

Except load conditions, it may be expected that the influence of the type of attachment between the concrete plug and the rock support. It may either be ideal supported as a fixed support, i.e. the plug is perfectly fixed to the hard rock wall, and alternatively the plug is assumed to interact with the rock and the contact between the plug and the rock is frictional.

Model 1

In model 1, the concrete and the rock are assumed to interact, i.e. the contact between concrete and rock is frictional and the plug is allowed to slip against the support. In order to study the influence of the rock Young’s modulus, three modulus’s where tested (25, 50 and 75 GPa). Also the case with an infinite stiff rock support was studied.

The result indicates that when the stiffness of the rock increases, the deformation and slip between the rock and concrete at the support decreases. Tables 3-6 to 3-9 show the deformations and the principal stresses obtained from the analyses. Calculated major principle stress in the plug of varying Young’s modulus is shown in Figure 3-5 to 3-7.

Table 3-6. Results, Young’s modulus 25 GPa.

Young’s modulus rock	25 GPa
Deformation in the direction of the load	2.76 mm centre deformation, 1.45 mm slip
Major principal stress	Compressive stresses between –9 and –15 MPa
Intermediate principal stress	Compressive stresses between –7 and –15 MPa
Minimum principal stress	Compressive stresses between –0.35 and –6 MPa

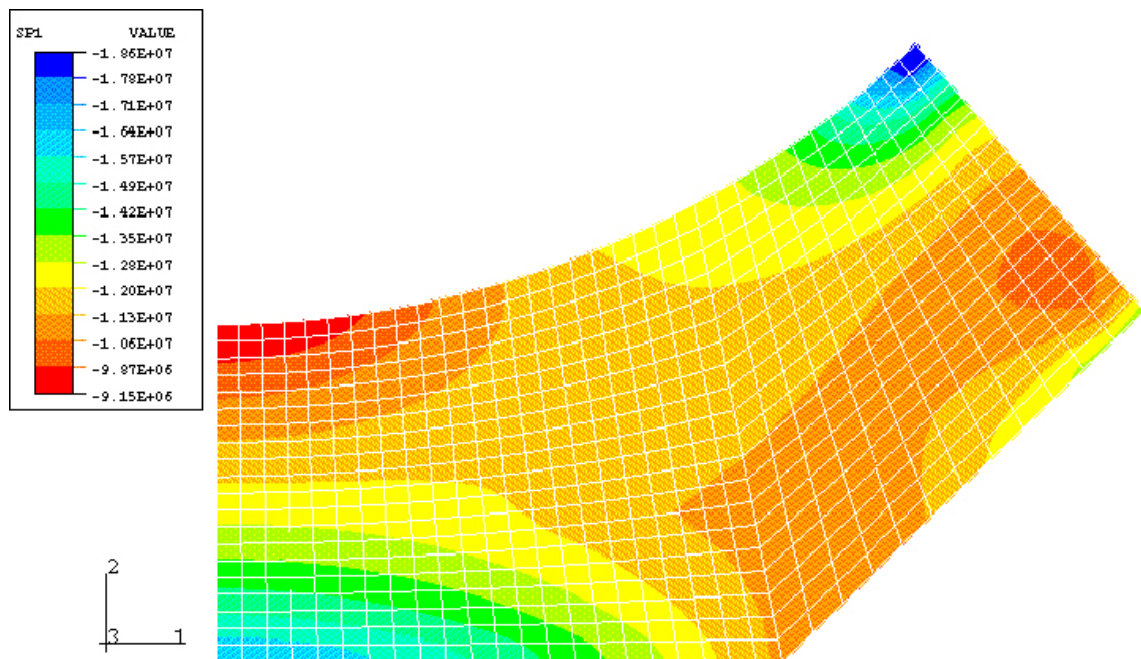

Figure 3-5. Major principle stress with a frictional contact, Young’s modulus 25 GPa.

Table 3-7. Results, Young's modulus 50 GPa.

Young's modulus rock	50 GPa
Deformation in the direction of the load	2.41 mm centre deformation, 1.25 mm glidning
Major principal stress	Compressive stresses between -9 and -16 MPa
Intermediate principal stress	Compressive stresses between -7 and -16 MPa
Minimum principal stress	Compressive stresses between -0.44 and -6 MPa

Table 3-8. Results Young's modulus 75 GPa.

Young's modulus rock	75 GPa
Deformation in the direction of the load	2.29 mm centre deformation, 1.18 mm slip
Major principal stress	Compressive stresses between -9 and -16 MPa
Intermediate principal stress	Compressive stresses between -7 and -16 MPa
Minimum principal stress	Compressive stresses between -0.6 and -6 MPa

Table 3-9. Results, infinite stiff rock support.

Young's modulus rock	∞
Deformation in the direction of the load	2.05 mm centre deformation, 1 mm gliding
Major principal stress	Compressive stresses between -9 and -16 MPa
Intermediate principal stress	Compressive stresses between -7 and -16 MPa
Minimum principal stress	Compressive stresses between 0.14 and -6 MPa

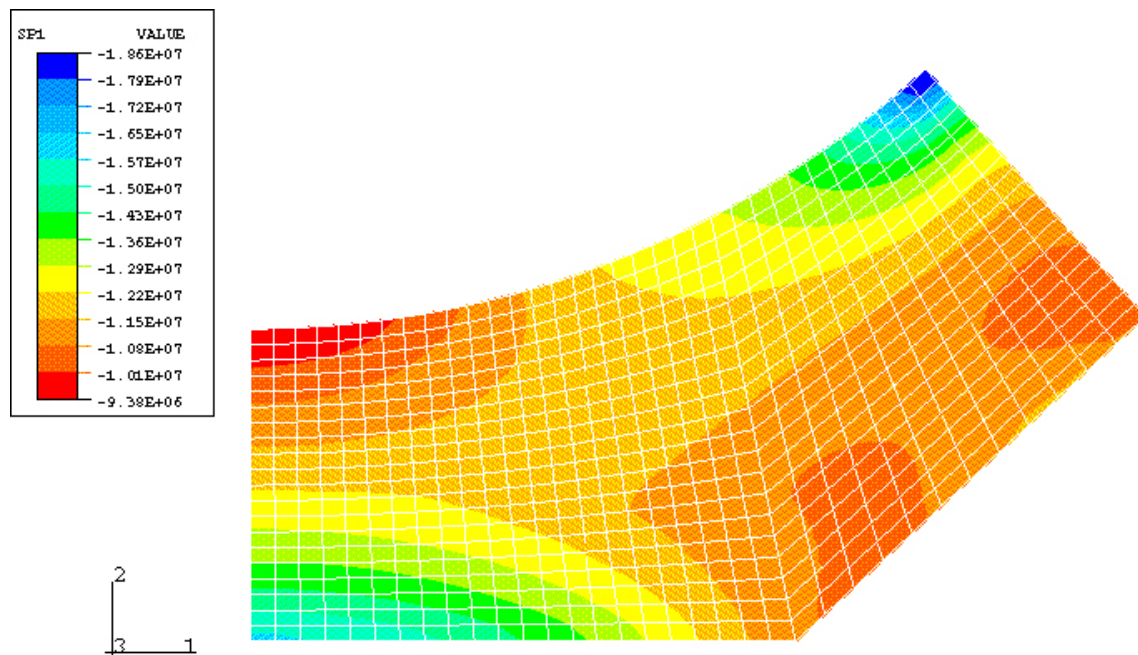

Figure 3-6. Major principle stress with a frictional contact, Young's modulus 50 GPa.

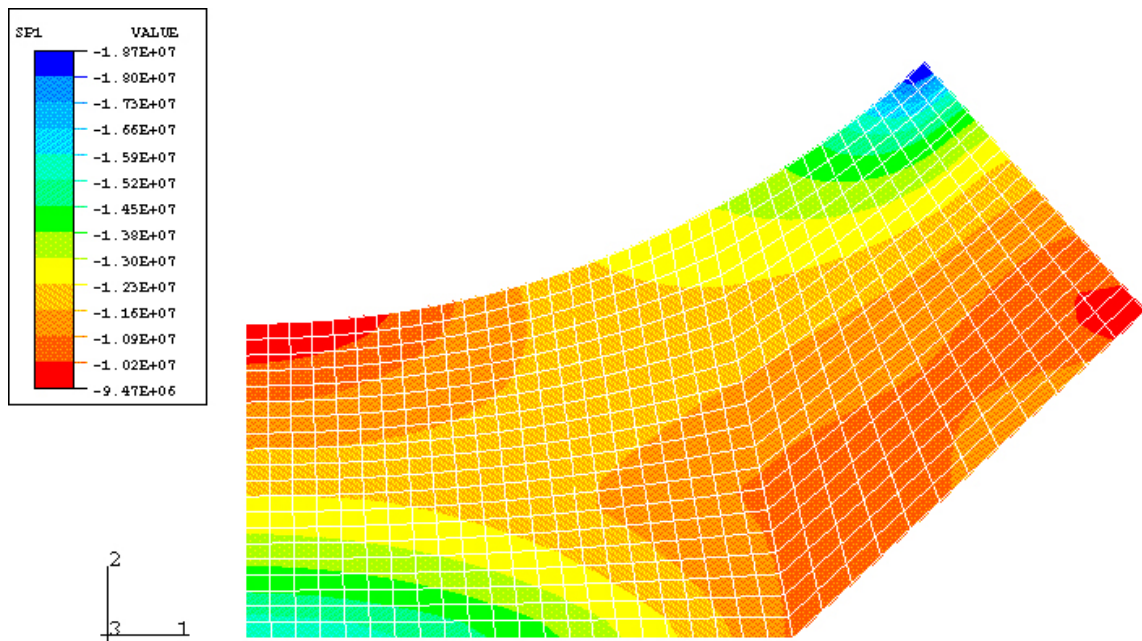

Figure 3-7. Major principle stress with a frictional contact, Young’s modulus 75 GPa.

Conclusion: The minimum reinforcement at all surfaces of the plug is sufficient and the contact pressure against the rock varies from 5 MPa to 20 MPa. The entire plug is in compressive state (Figure 2-7) except for the case with infinitive stiff rock support (Table 3-9). In this case very small tensile stresses may develop in the narrow notch at the bottom of the slot. These small tensile stresses are, however, most probably errors shown in the model due to element structure and boundary condition.

Model 2

In this model the rock and the concrete is completely attached to each other, and no slip is allowed. The calculations are carried out as in model 1, with varying Young’s modulus. Table 3-10 to 3-12 show, from the calculations, obtained deformations and the principal stresses.

Table 3-10. Results Young’s modulus 25 GPa.

Young’s modulus rock	25 GPa
Deformation in the direction of the load	2.9 mm centre deformation
Major principal stress	Compressive stresses ca 0–18 MPa
Intermediate principal stress	Tensile stresses 0.01 MPa, compressive stresses max 20 MPa
Minimum principal stress	Compressive stresses between 0 and –6 MPa. Local tensile stresses at the rock support

Table 3-11. Results Young’s modulus, 50 GPa.

Young’s modulus rock	50 GPa
Deformation in the direction of the load	2.6 mm centre deformation
Major principal stress	Compressive stresses, peaks locally at corners in connections, –26 MPa, in general average –19 MPa
Intermediate principal stress	Tensile stresses 0.02 MPa, Compressive stresses max –19 MPa
Minimum principal stress	Compressive stresses up to –6 MPa. Locally at the connection concrete-rock 4.6 MPa

Table 3-12. Results, Young's modulus, 75 GPa.

Young's modulus rock	75 GPa
Deformation in the direction of the load	2.46 mm centre deformation
Major principal stress	Compressive stresses, locally peaks at the connection rock and concrete -28 MPa, generally average -19 MPa
Intermediate principal stress	Tensile stresses 0.028 MPa, compressive stresses max -19 MPa
Minimum principal stress	Compressive stresses up to -6 MPa. Locally at the connection concrete-rock 7 MPa

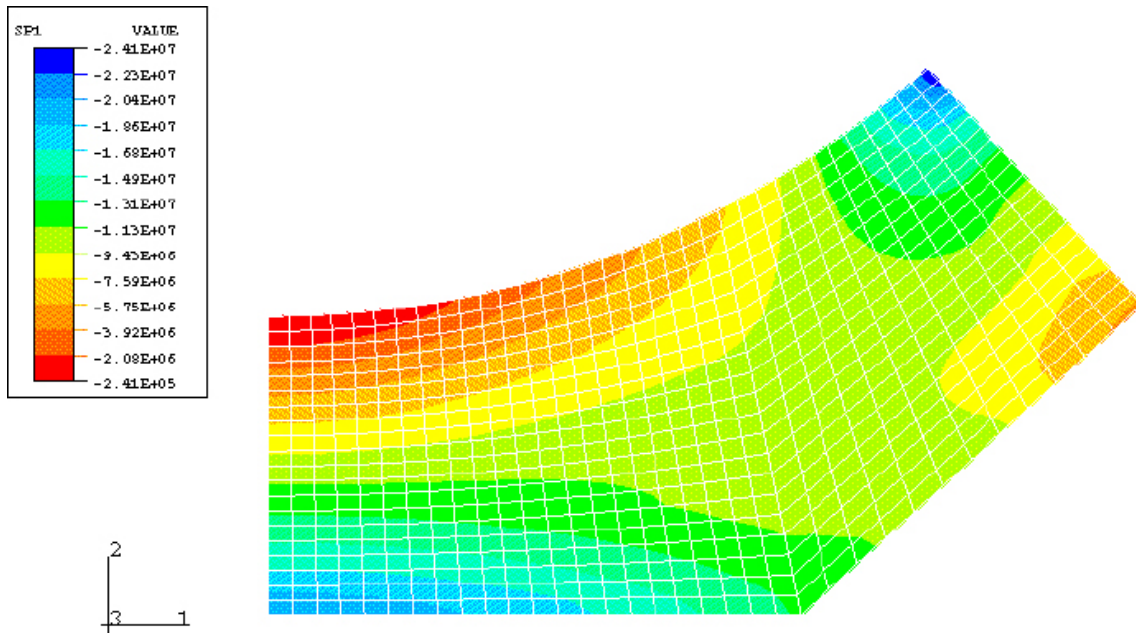

Figure 3-8. Major principle stress with completely attached contact, Young's modulus 25 GPa.

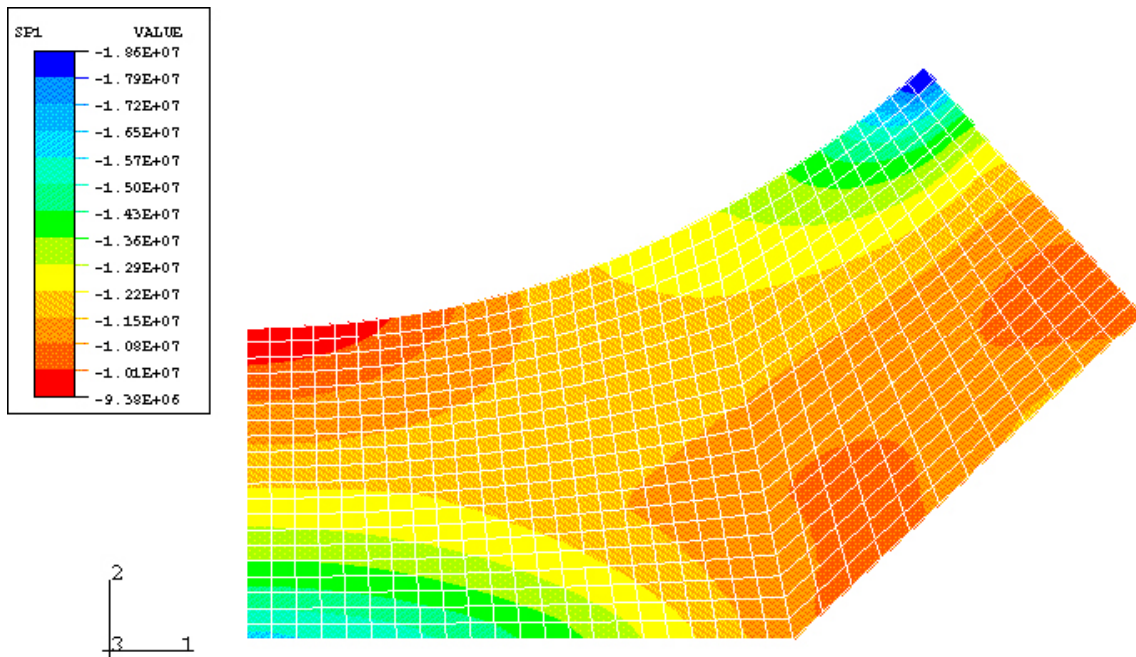

Figure 3-9. Major principle stress with completely attached contact, Young's modulus 50 GPa.

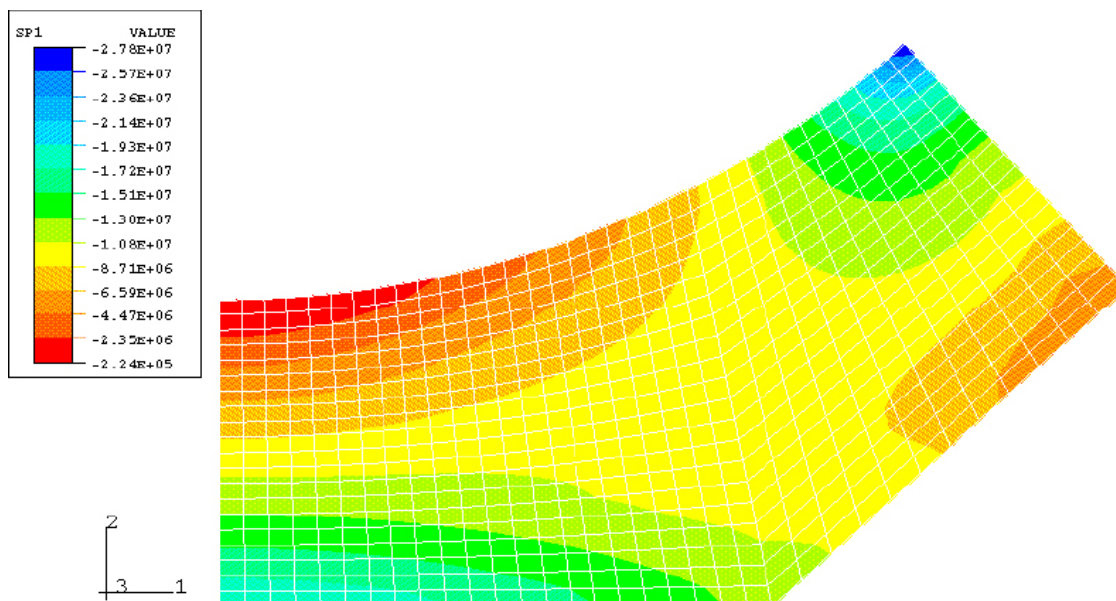

Figure 3-10. Major principle stress with completely attached contact, Young's modulus 75 GPa.

Conclusions: Since slip between the concrete and the rock is not allowed, the centre deformation increase a little, hence the stresses will increase. The local tensile stresses at the connection concrete and rock are probably due to the element size and number. However, the minimum reinforcement is adequate.

Comments

The calculation based on the characteristic load 4.5 MPa and only a frictional interaction between rock and concrete, indicate a slip of about 0.7 mm.

3.8 Drawings

Working drawings that were produced during the design are listed in Table 3-13. The drawings are presented and displayed in Appendix I. Text on drawings is in Swedish, but the context shall be fully understandable.

Table 3-13. List of drawings.

Drawing No.	Content	Rev.	Date	Rev. date
Pro. Type -201	Comprehensive compilation	B	020418	020508
Pro. Type -211	Slot in rock	B	020418	020508
Pro. Type -212	Vacant	B		
Pro. Type -213	Prefabricated beams, dimension and reinforcement	B	020222	020508
Pro. Type -214	Plug, dimension and reinforcement	B	020418	020508
Pro. Type -215	Grouting system	B	020418	030325
Pro. Type -216	Cooling system	B	020418	020508
Pro. Type -221	Formwork, compilation	B	020222	020508
Pro. Type -222	Formwork, type 1 and 2	B	020418	021024
Pro. Type -223	Formwork type 4, 5 and 6	B	020418	021024
Pro. Type -231	Bracing and lead through	B	020417	021024

3.9 Analyses of concrete cracking during casting and curing

The plug is designed to have a very low hydraulic conductivity. The conductivity should be less than the conductivity of the backfill since the plug supposes to function as a hydraulic barrier. Therefore it is important to control the development of cracks during casting and curing and since cracking is most of all affected by the temperatures that are developed, the cracking is controlled by controlling the curing temperature. The interface between the concrete and the rock is also a potential flow path and is affected by the magnitude of shrinkage of the concrete monolith and special consideration is required.

The bases for the calculations are: BBK 94, Betonghandbok and Concrete Temperatures & stresses, Con Te St R&D Version 1.2, JEJMS Concrete AB

3.9.1 Temperature cracks in concrete

Development of cracks

During hydration of the concrete a considerable amount of heat is generated which cause an increase of volume and the hardening concrete plug will expand. When the hydration is ceasing the temperature will decrease and the plug will contract.

All displacements during the expansion phase are constrained by the surrounding rock and the young concrete will be squeezed and cause remaining plastic deformations. When the plug later start to contract, it is no longer constrained, since the bond strength between the plug and the rock is less then the tensile strength of the concrete. The plastic deformations that where developed during the expansion phase will at this stage cause remaining deformations and leave a narrow opening between the concrete plug and the rock.

Persistent and consistent cracks with an extension length greater than the length of the plug which can act as flow paths are almost negligible. However, the opening between the plug and rock must be handled.

Methods to handle cracks

To secure required tightness at the interface between concrete and rock, a system of grouting tubes are installed around the periphery of the rock surface before casting. During the hardening the development of plastic deformations are limited by using a preinstalled cooling system. When the strength of the plug reaches its expected strength, the cooling process is continued. This cooling will contract the plug and the width of the joint between the concrete and the rock will increase. When the plug has contracted, the joint is grouted trough the pre-installed grouting tubes. The cooling is halted when the grout is hardened and the plug is allowed to expand. However, since the plug is constrained there is no space for expansion; instead the plug will be pre-stressed.

3.9.2 Temperature and strength development

Calculated results of average temperature- and strength development during curing are shown in Figures 3-11 and 3-12. The characteristics and the conditions for the calculation are given in Table 3-14.

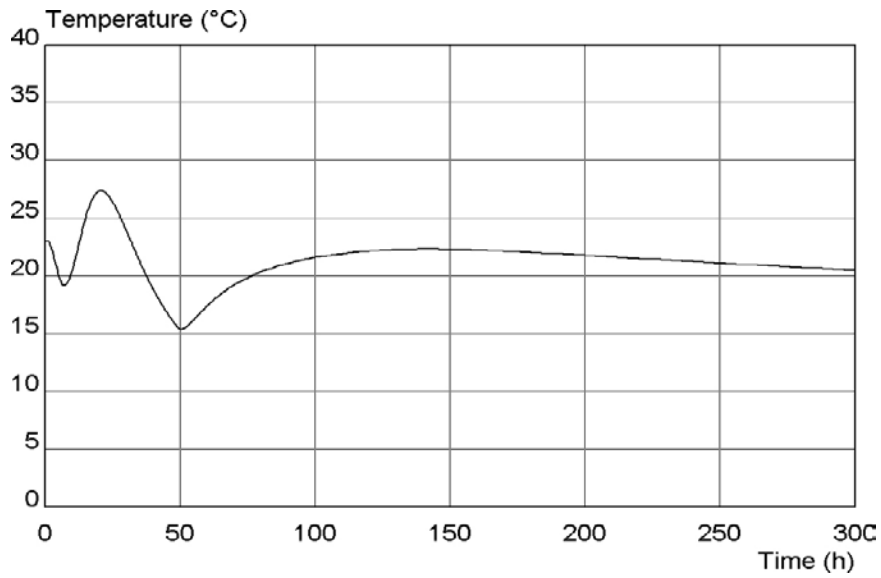

Figure 3-11. Development of temperatures in the centre of the plug during the first 300 hours. Cooling is stopped after 50 hour.

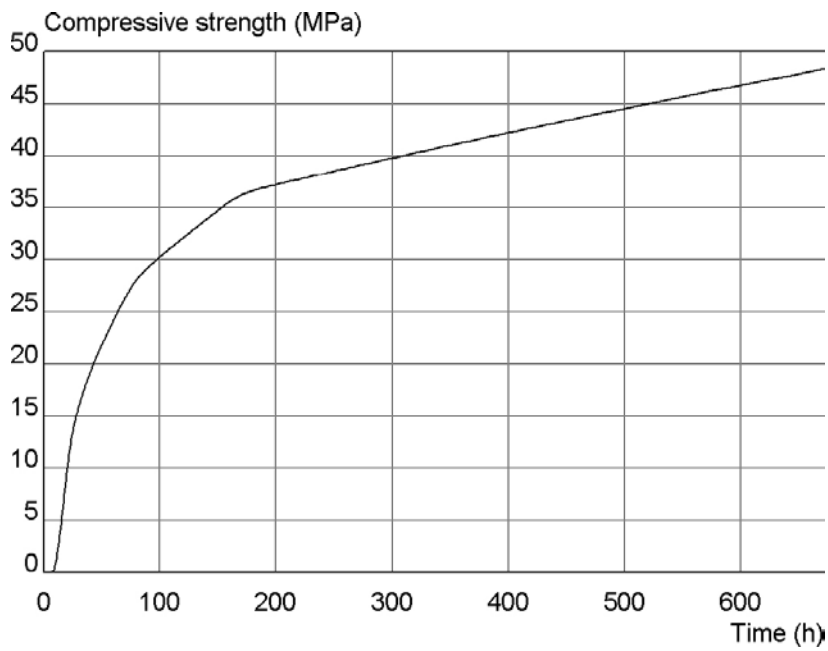

Figure 3-12. Strength development of the concrete during the 650 first hours. Cooling is stopped after 50 hours.

Table 3-14. Characteristics and conditions for the temperature and strength development calculations.

Concrete mixture			
Strength	K 50		
Portland cement	400 kg/m ³		
wct	0.40		
Boundary conditions			
Climate			
Ambient temperature, rock	[°C]	16	
Temperature in retaining wall, clay and air	[°C]	20	
Cooling water temperature	[°C]	8	
Coefficient of thermal conductivity	[W/m ² K]		
Free surface		10	
Formwork (12.5 mm plywood, wind 1 m/s)		5 (0–120 h) 10 (> 120 h)	
Cooling tubes (steel, outer diameter: 25 mm)		1,000 (0–40 h) 0 (> 40 h)	
Start values			
Cast temperature (initial concrete temp)	[°C]	23	

3.9.3 Calculation of cooling water temperature and effect

Required cooling effect

The cooling effect during the concrete hardening process per meter cooling pipe is shown in Figure 3-13. Maximal required cooling effect is about 110 W/m cooling pipe. Two pipes, each 65 m, are installed to circulate the cooling water which gives a total cooling effect of 14.3 kW.

Cooling temperatures

The in- and out temperature of the cooling water in the cooling circuit may be expressed according to:

$$P = (T_{out} - T_{in}) \cdot c_{water} \cdot Q$$

$$T_{average} = (T_{out} + T_{in}) / 2$$

P required cooling effect for each circuit

$T_{average}$ average temperature of the cooling water

c_{water} specific heat of water (4,192 kJ/m³°C)

Q flow rate in each circuit (0.00075 m³/s)

Based on the conditions above the in- and out temperature is calculated to 6.8°C and 9.1°C respectively.

Widening of joint between concrete and rock

In order to ensure a good seal after the contact grouting, the potential or extremely narrow openings or gaps between rock and concrete are widened by shrinking the plug by cooling. Calculated average temperature within the concrete plug during cooling that precedes the contact grouting is shown in Figure 3-14.

By shrinking the plug by cooling before contact grouting, the grout will penetrate openings or gaps that otherwise was too narrow for grouting. After the grouting process the temperature is allowed to rise to the ambient temperature, and the plug will be pre-stressed due to expansion and thereby contribute to the tightness.

Based on a concrete plug diameter of 5 m and a coefficient of thermal contraction of $1 \cdot 10^{-5}$ the opening between the rock and concrete is estimated according to Table 3-15.

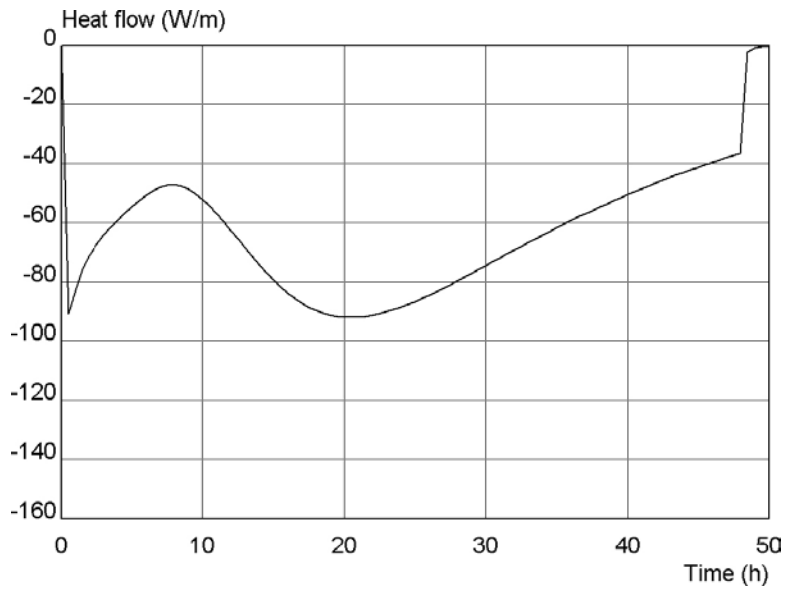

Figure 3-13. Required cooling effect during curing per meter cooling pipe.

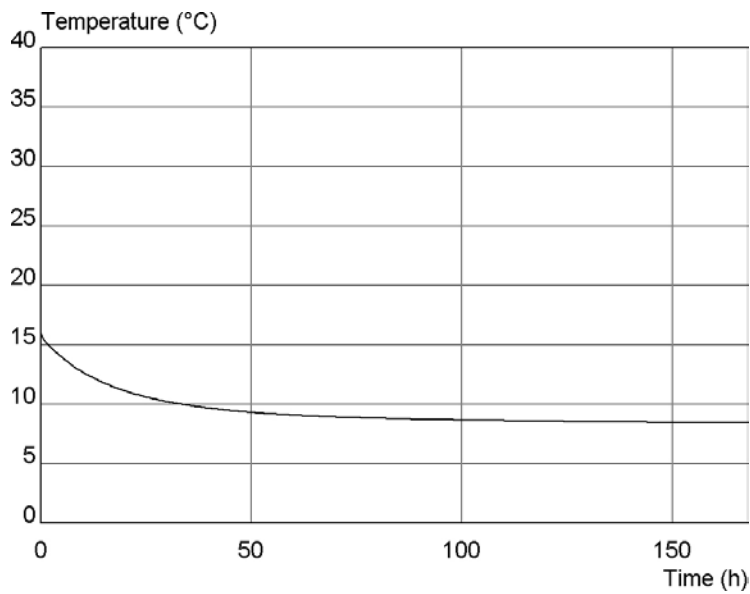

Figure 3-14. Calculated average temperature within the concrete plug during the cooling process that precedes contact grouting.

Table 3-15. Estimated opening width between rock and concrete at lowered temperatures.

Decreased temperature [°C]	Width [mm]
5	0.25
10	0.50
15	0.75
20	1.00

3.9.4 Procedures for temperature control

In order to control the development of cracks and to secure a tight attachment between concrete and rock, it is important to establish a clear and distinct construction procedure how to control the temperature development during casting and curing. The construction procedures to control the temperature development in the plug in the prototype repository were basically as follows.

1. The cooling system is installed in the insert slot according to drawing Pro.type-215, Appendix I.
2. Installation of cooling pipes (Ø25 mm) and C/C about 300 mm according to drawing Pro.type 216, Appendix 1. The two circuits are evenly distributed on the rock surface.
3. Maximum temperature during casting and curing is 23°C.
4. During the hardening process the concrete is cooled by the cooling system. Cooling using circuit 1 and 2 starts when the concrete covers the top pipe in each circuit, respectively. Maximum allowed temperature entering each circuit is 6°C, and the flow ≥ 0.75 l/s. Cooling is continued until the maximum temperature has developed and the temperature has decreased about 5–10°C. The development of temperature is measured by temperature sensors. The calculated temperatures of sensor P, P1 and P2 are given in Figure 3-11 and the measured temperature should roughly equal these temperatures. Location of P, P1 and P2 are given in Appendix I, drawing Pro.type-216.
5. The formwork should at least remain until the concrete has reached about 75% of its final strength. However, the minimum time before removal of the formwork is 5 days.
6. When full strength of the concrete plug has developed (50 Mpa) the cooling procedure should continue until the temperature of the plug has reached $\leq 8^\circ\text{C}$. Grouting is performed according to drawing Pro.type-215. Cooling is stopped when the contact grouting is finished and the grout has reached its maximum strength.
7. Finally the cooling pipes are drained and grouted.

During the casting and curing process, temperatures etc, are documented.

3.10 Construction procedures

The construction of the plug is divided in three phases

1. Excavation of the insert slot.
2. Prefabrication of concrete beams and preparations in the deposition tunnel.
3. Formwork and casting of plug.

3.10.1 Excavation of the insert slot

Insert is excavated at section 3/560 (plug 2) and 3/537 (plug 1), see Figure 4-1 and drawing Pro.type-211, Appendix I. The slot shall be excavated with a minimum of disturbance of the rock. Excavating by blasting techniques is not allowed, i.e. the slot has to be excavated mechanically by sawing or/and drilling.

3.10.2 Prefabrication of concrete beams and preparations in the tunnel

The retaining wall that supports the backfill material during backfilling and compaction is built up by concrete beams; see drawing Pro.type-213, Appendix I. The bottom beam will be installed when the backfill is approximately 9 m away from the location of the retaining wall.

The beams are prefabricated in accordance to drawing Pro.type-213. The time delay between casting of the beams and installation should be such that full strength is achieved before installation, since the strength of the beam must be sufficient to sustain its dead weight during lifting and transportation.

Location of the retaining wall is marked accurately on the rock wall, including location of boreholes for installation of bolts, drawing Pro.type-213. The holes are drilled very accurate to ensure easy handling during installation. Installation of bolts is performed in good time before installation of the concrete beams.

3.10.3 Formwork and casting of plug

1. Before any work at the plug location starts, the plug seat is investigated to localize potential water bearing structures that may require grouting.
2. Minor slots are produced around the periphery for the installation of grouting tubes.
3. The plug seat is cleaned and the grouting tubes installed according to drawing Pro.type-215, Appendix I.
4. The reinforcement is performed according to drawing Pro.type-214, in parallel to the installation of the cooling system, drawing Pro.type-216, Appendix I.
5. The mold is prefabricated in accordance to drawing Pro.type-221 and -223, Appendix I. The same formwork has been used in the “back fill and plug test experiment” and when casting Plug I in the prototype. The formwork accessibility for vibrating etc was considered in the design. However, this is not required when casting Plug II, since self compacting concrete is used. One of the last formwork element is prepared for an access for tubes for grouting and air evacuation.
6. The program for concrete work shall be documented by the contractor and shall include such as equipment for temperature control, concrete cover, cooling equipment, concrete recipe, monitoring and testing.
7. The formwork is dismantled, see 3.9.4.
8. Before contact grouting, the cooling process will continue until the plug has reached a temperature below the ambient temperature, see 3.9.4.
9. Contact grouting.
10. Cooling shut off.

3.10.4 Environment and safety

During construction it should be understood that it is of the utmost importance that SKB’s operations are carried out with adequate human and environmental safety. This applies both to SKB’s own personnel and other personnel who participate or come into contact with the operations.

Responsibility for compliance with relevant regulations, for limitation of environmentally hazardous substances, for adequate supervision of all handling, and for minimizing other safety risks normally rests with the contractor/consultant in charge of execution. As far as SKB’s own safety instructions are concerned, the project manager/coordinator/purchaser is responsible for making them known.

In the case of field work, a special SHE (safety, health and environment) protocol shall be appended to the Activity Plan. This protocol shall contain a list of environmentally hazardous substances that will be handled, possible safety risks, and other vital SHE information associated with the activity. It is up to the contractor to prepare this protocol in advance so that it is included as an appendix in the approved Activity Plan.

If other environmentally hazardous substances are then used or other SHE-related conditions arise during the conduct of the activity, this shall be recorded in the SHE protocol and reported as a non-conformance to SKB for approval.

The SHE protocol shall be well known and be kept on hand at the workplace. It must be produced on demand by the person executing the work.

3.10.5 Controlling activities with risk analyses

The plug construction, as all activities at Äspö Hard Rock Laboratory are preceded by a checking program to be scrutinized and accepted before the activity is allowed to start. The program shall present all activities that are included in the total job to be performed. The activity should be described and potential risks evaluated.

4 Construction of the slot insert

In order to minimize the excavation disturbed zone (EDZ) around the plug, only mechanical excavation of the slot was allowed, such as seam drilling with coring technique or sawing. The circular shape makes the sawing alternative complicated, and finally the slot was excavated by seam drilling with coring equipment. In Figure 4-1 the requirements and tolerances are given. The figures are taken from drawing no. Pro.type-211, Appendix I.

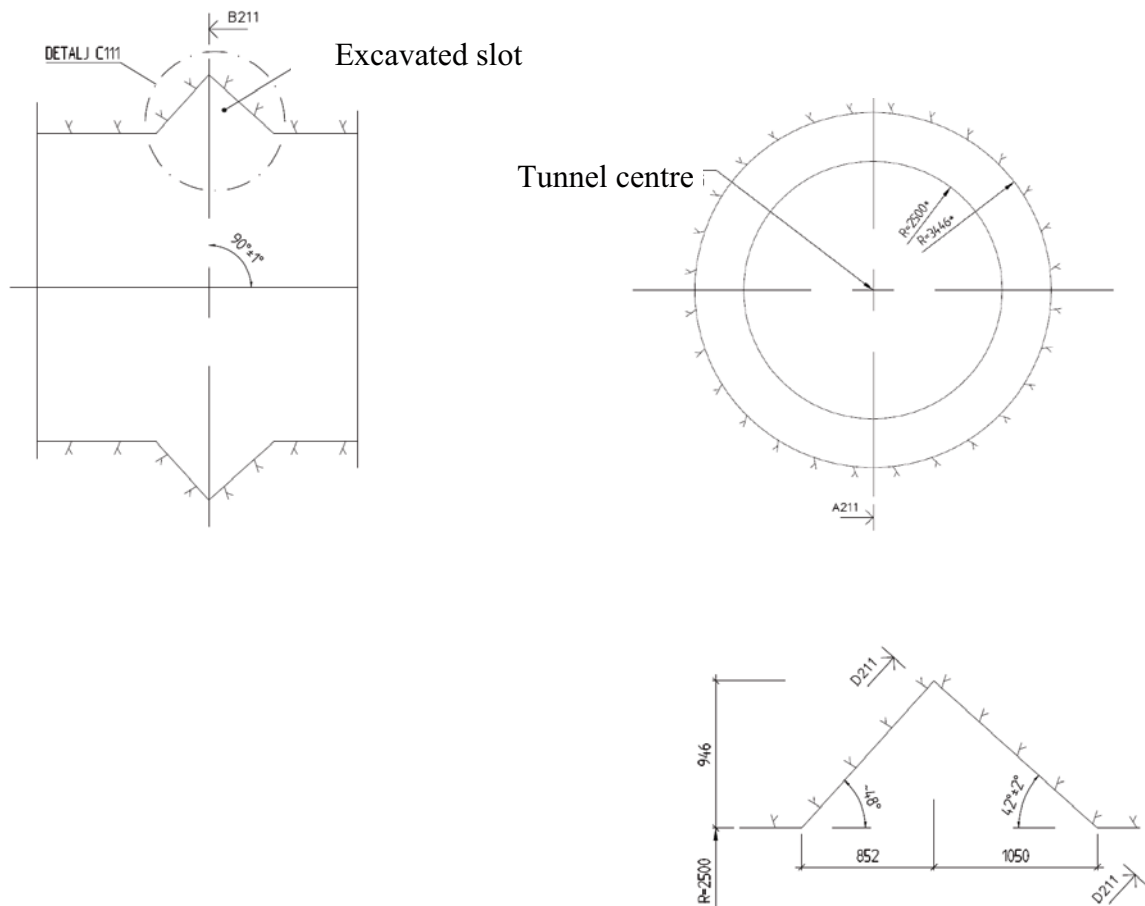

Figure 4-1. Dimensional requirements of the plug seat.

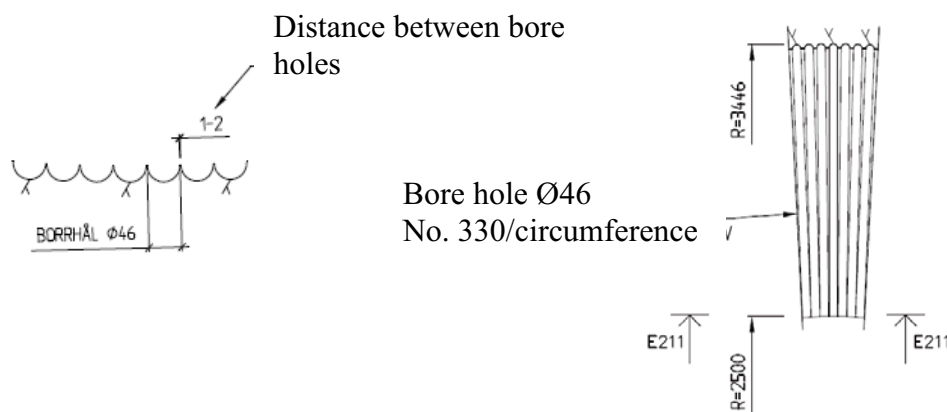

Figure 4-2. Detailed requirements of the seam drilling.

4.1 Prerequisite for tendering

The contract comprises excavation of a slot in an existing tunnel, according to drawing Pro.type-211, Appendix I. The excavation shall be performed in the most careful way. The purpose of the slots is to provide a support for the plug and to prevent water seepage in axial fractures. In order to minimise damage to the rock, which can create new water seepage possibilities, the excavation must be performed with a very careful method. Cautious blasting may be accepted at certain circumstances. For example, if necessary after coring, when extracting the bottom/invert part. The contractor had to consider and thoroughly describe in his offer:

- Excavation according to drawing no. Pro.type-211, Appendix I.
- Method of staking out and proper alignment.
- All equipment required to execute the contract.
- Mucking arrangement.

4.2 Drilling and alignment control

Altogether 660 holes, diameter 46, were drilled for each slot. In order to drill all these holes rationally and to secure the correct alignment, a special rig was constructed; Figure 4-3 and 4-4. The rig was first installed to drill all holes outward the tunnel with an inclination of 42°, according to drawing Pro.type-211 and Figure 4-1. After all the 330 holes were drilled, the rig was installed to drill the inward holes with an inclination of 48°. In general, the drilling procedures operated very well and with good results. However the operation is very time-consuming. Possibly the accuracy demands were unnecessary high.

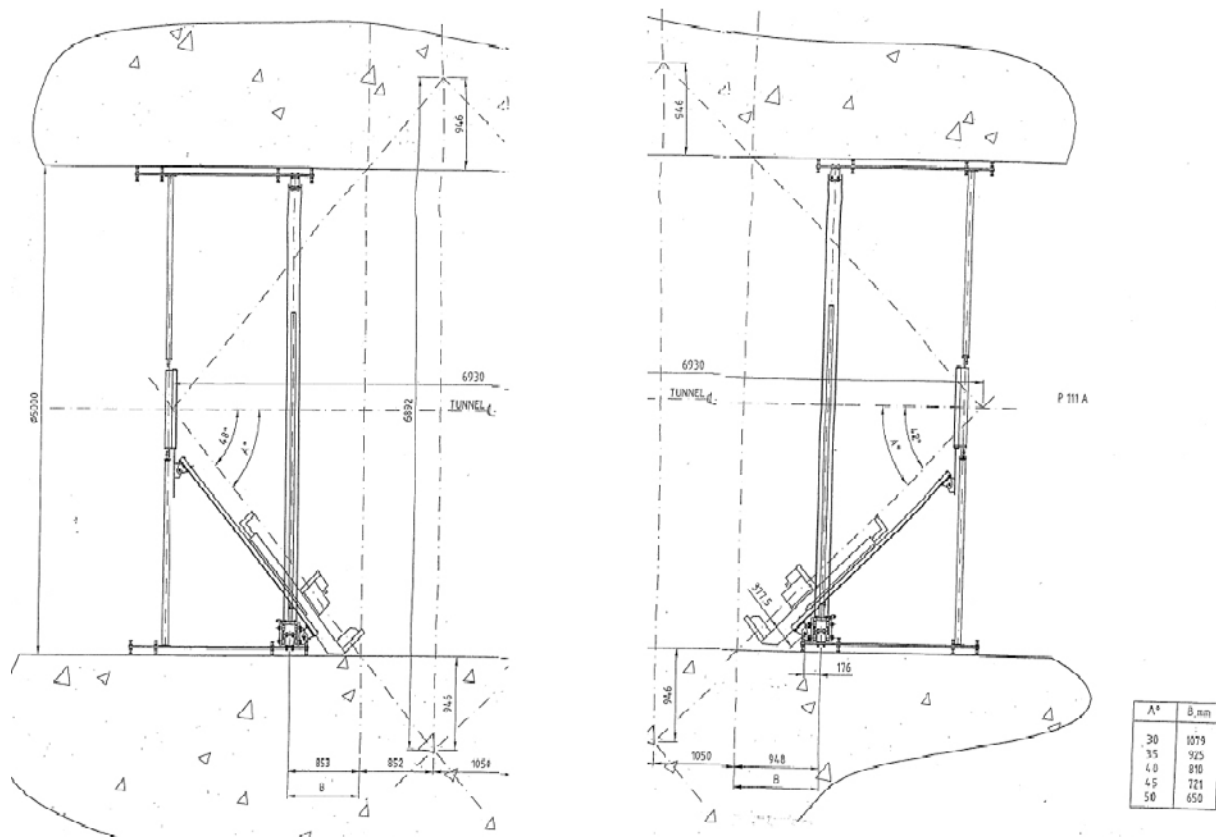

Figure 4-3. A special rig was constructed to allow for efficient drilling and to ensure the alignment.



Figure 4-4. Installation of the rig to the rock wall.

4.3 Time schedule

The Prototype Repository experiment contains two plugs and it was decided that, even though the second plug was going to be constructed more than a year after the first, both inserts were to be excavated in the same campaign.

Assembling and alignment of the rig took about five days. After the alignment control was finished, the drilling started and continued for about five weeks until all holes were drilled. The experience from the first slot gained time when drilling the second slot, about three days.

4.4 Use of explosives

The demands for tightness of the plug require an excavation method that produces none or minor damage to the rock, and therefore a mechanical excavation method was suggested and executed. However, in order to simplify the final extraction of the rock, very light and careful blasting was allowed. Since a slot was produced between the intact rock and the rock to be extracted, no high destructive pressures were expected to develop against the rock that could induce fracturing. Figure 4-5 shows the seam drilling holes before and after extraction of rock.

4.5 Mapping of the plug seat after extraction of rock

Before any work at the plug location could start, the plug seat was accurately investigated to localize fractures, loose rock and water- or potential water bearing structures that might require grouting or drainage. Leakage of water may obstruct the casting and deteriorate the concrete quality. Grouting was never executed; instead leakage water was drained by drilling holes from outside the plug location and into water bearing structures. Figure 4-6 shows the mapping configuration and result from the investigation of the plug seat condition. As can be seen in Figure 4-6, several fractures where water bearing. Only a few of these fractures were considered to require grouting. However, water bearing fractures that could jeopardize the concrete quality during casting, was instead drained and the water let out, outside the plug location. However, minor inflow remained, which negatively affected the casting procedure.



Figure 4-5. The seam drilling pipes before (upper) and half pipes after rock extraction (lower).

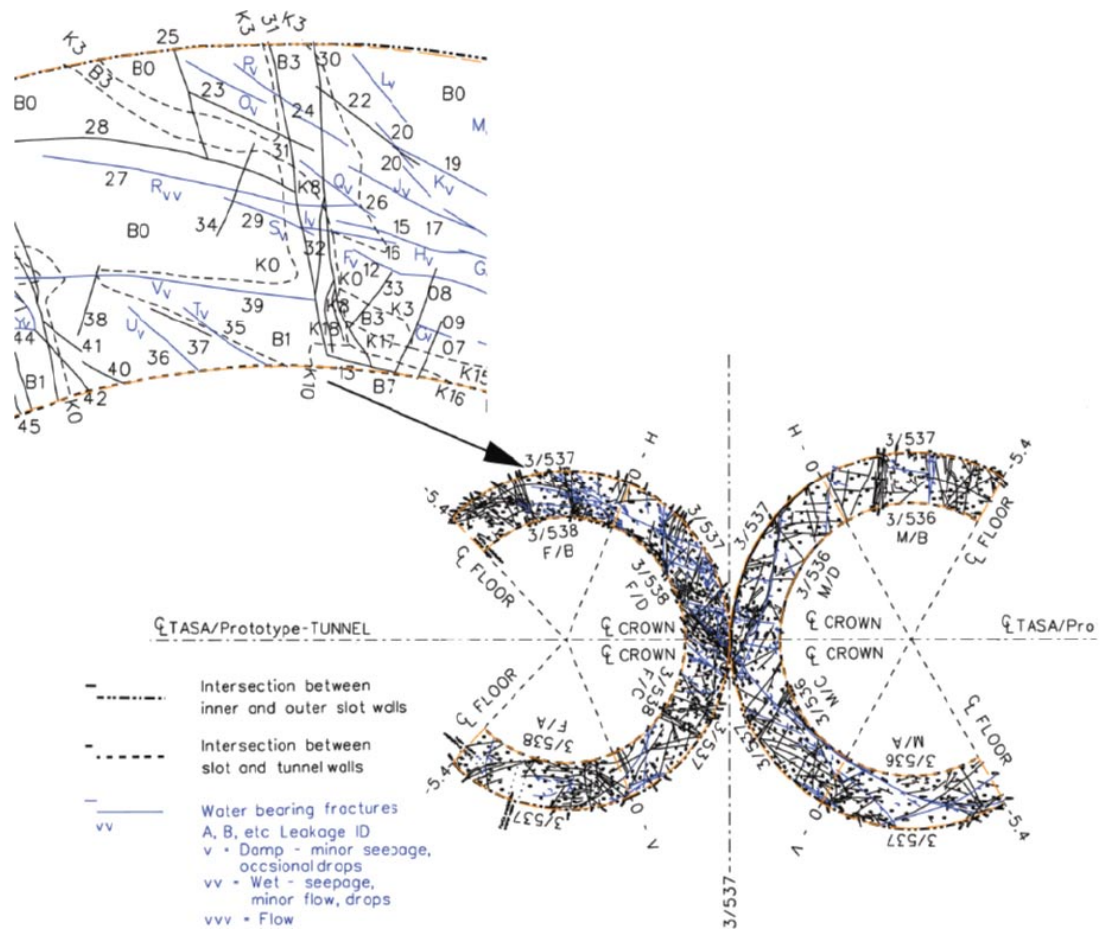

Figure 4-6. Mapping results from the investigation of the plug seat conditions.

5 Plug construction

5.1 Work operations

All works were performed as two-shift and were carried out parallel at the ground surface and down the tunnel. The different operation sequences are shown in Table 5-1. The operations are divided in preparatory works, casting including formwork and finally the contact grouting.

5.2 Preparatory works

5.2.1 Safety course at SKB

As at most underground construction sites, all works to be performed below ground, is preceded by a safety course.

5.2.2 Pre-assembly of the formwork

The formwork has earlier been used in the “backfill and plug test experiment” and since this experiment was performed in a drill and blast tunnel, the formwork required minor adjustments to fit in the bored tunnel. The steel formwork was pre-assembled at the ground surface before taken down to the tunnel. This was considered to be more efficient and with better possibility to check the function and easier to adjust. Further, on the surface it’s much better space and it is possible to reassemble the formwork lying down horizontally. The steel was bolted and welded together and crossbars and plywood mounted on the top see Figure 5-1. Before the formwork was taken down in the tunnel to the final installation location, it was separated into smaller pieces that were easier to handle. At the final location, the formwork was easy to assembly again. Some of the plywood slabs were replaced by Plexiglass to facilitate the possibility to visually control the casting.

Table 5-1. Operation sequences.

At the ground surface	Down the tunnel
Preparatory work	
Safety course	Installation of the pre-fabricated beam wall
Pre-assembly of the formwork at surface	Thoroughly cleaning of the slot
	Installation of grouting tubes
	Installation of reinforcement
	Installation of cooling system (pipes)
	Installation of measurement gauges
The formwork is separated in manageable pieces for transportation down the tunnel	
Formwork and casting	
	Reassembling of the formwork at the plug location
	Installation of bucket
	Connecting the cooling machine to the cooling system
	Erecting the casting pump
	Casting
	Dismantling of the formwork
Conclusive works	
	Continues cooling before grouting



Figure 5-1. The steel is bolted and welded together and crossbars and plywood mounted on the top.

5.2.3 Installation of the retaining wall

Prefabricated concrete beams are used to build a wall aimed to resist the developed earth and compaction pressure of 100 kPa. In Figure 5-2, the construction of the prefabricated concrete beams is shown. The installation of the concrete beams is proceeding parallel with the installation of the backfill.

Experience gained during the installation show that it is important to control water flow from the backfilled sections. This water together with water inflow directly from the rock surface affects the casting procedure and may cause piping through the concrete.

5.2.4 Installation of grouting tubes

Grouting tubes for contact grouting are installed around the periphery of the plug seat. The rock surface after the seam coring is rough due to all half pipes and since this roughness may obstruct the grouting process and the grouting result, three notch lines were cut along the periphery to fit the grouting tubes and thereby get a good fit to the rock wall, see Figure 5-3.



Figure 5-2. The concrete beams are installed successively along with the backfill compaction. The beams are anchored to the rock wall by bolts that are installed in advance of the beam installation.



Figure 5-3. Three notches were cut to fit the grouting tubes.

5.3 Formwork and casting

5.3.1 Reinforcement

The reinforcement was cut and bent at the factory and was ready for installation when arriving to the plug location. The reinforcement was clenched together at determined c-c distances; see Figure 5-4 and 5-5. Totally 4,344 kg of reinforcement steel was used, which result in $4,344 \text{ kg}/55 \text{ m}^3 = 59 \text{ kg}$ steel per cubic meter of concrete.

Cooling pipes were installed within the reinforcement cage. Distance between the pipes was about 30 cm. In order to control the distances a special rig was used. In total it was about 400 meter of pipes installed in the plug.

The concave shape of the plug leads to more troublesome and time consuming reinforcement and formwork procedures.



Figure 5-4. Installation of reinforcement.



Figure 5-5. Installation of the cooling pipes within the reinforcement cage.

5.3.2 Installation of measurement gauges

Strain gauges and thermo couples were installed at the plug location, Figure 5-6. The thermo couples allow the possibility to measure and to control the concrete temperature during casting. Strain gauges and joint meters were installed to verify the plug function during operation. Details of the instrumentation are given in chapter 7.

5.3.3 Transportation of the formwork

Before the formwork was transported down the tunnel to the plug location it is separated to manageable pieces, see Figure 5-7. The total eight pieces were transported by truck down to the Prototype Repository. See Figure 5-8.



Figure 5-6. Monitoring instruments and cooling pipes are installed within the reinforcement cage.



Figure 5-7. Loading of formwork parts for transportation down the tunnel.

5.3.4 Reassembly of the formwork

When finally all pieces were transported down to its final destination, the eight pieces were reassembled by assistance of a mechanical loader, see Figure 5-8. The first seven pieces were easy to erect. In order to make it fit, the last piece at the top had to be dismantled into smaller pieces.

Two H-beams were installed vertically as a support to the formwork, see Figure 5-9. Complementary support was provided by dowels installed in bore holes around the periphery about 1 meter outside the formwork.

5.3.5 The cooling machine

The cooling machine was connected to the cooling circuit and tested. The configuration of the cooling circuit is shown in drawing Pro.type-216, Appendix I. The machine was supposed to cool the water down to a temperature of about 0°C and the water temperature was estimated to increase about 3°C to 4°C on its way through the concrete. Figure 5-10 show the cooling machine in front of the formwork.



Figure 5-8. Reassembling the formwork at the location of the plug.



Figure 5-9. Two vertical beams were installed as struts to support the formwork.



Figure 5-10. The cooling machine.

5.3.6 Concrete pump

The concrete pump was reassembled at its location and tested the day before casting, Figure 5-11.

5.3.7 Casting

The casting process took about 8 hours. The Self Compacting Concrete (SCC) was pumped continuously with only minor disruptions between truck deliveries of concrete. Figure 5-12 shows a truck delivery of concrete. The fresh concrete was tested first at the factory, secondly when it arrived to Äspö Figure 5-13 and finally down in the tunnel.

The concrete was pressed into the formwork from below through four levels of valves to be connected as the concrete passes each level. The concrete level was also visually registered through the installed plexiglass windows, Figure 5-14. The temperatures were measured by the temperature wires installed, which now are connected to a PC for read outs. The cooling machine was started to control the temperature of the concrete. Maximum estimated temperature is about 27°C. Slump tests were continuously taken to control the concrete condition.



Figure 5 -11. Assembling and testing of the concrete pump.



Figure 5-12. The fresh concrete viscosity condition was continuously checked.



Figure 5-13. Slump tests at arrival to Äspö.

5.3.8 Stripping of the formwork

In order to avoid plastic shrink cracks, the formwork was not stripped until the concrete had reached a compressive strength of about 75% of its final strength. Minimum time before stripping is 5 days. Final strength 50 MPa, is estimated to be reached after about 28 days.

5.4 Cast report

5.4.1 Concrete recipe

Normally, when casting a massive concrete monolithic construction, such as the plugs in the Prototype Repository, thorough vibrating is required. Since this thorough and controlled vibrating process was difficult to perform, Self Compacting Concrete (SCC) was considered for Plug II. Manufacturing and casting of this type of concrete requires special concrete knowledge, and all procedures require accurate handling. The concrete recipe used is given in Table 5-2.



Figure 5-14. The concrete was pumped into the formwork. Lower: The concrete level can be seen through the Plexiglas window. Upper: Pipe connection to the formwork.

Table 5-2. The SC-concrete recipe.

Substance	Quantity [kg]
Portland cement	400
Gravel 0–8 (pit run)	746
Coarse aggregate 8–16 (pit run)	668
Filler	289
Limus 40 (additive)	100
Water	192

5.4.2 Test program

When using SCC concrete it is very important to use correct recipes that are developed for the correct function and conditions. It is also important to develop a relevant control program and it is also important that the process is assisted by people with knowledge and experience of using SCC.

The concrete was tested and samples were taken several times before it was poured. It was first tested at the factory where it was produced, secondly when it arrived to Äspö and finally down the tunnel at the casting location. Several types of tests were performed.

Slump test

All batches of concrete were tested by Slump test on its arrival to Äspö. The required Slump value was 720 +30/-20 mm, and the time for the concrete to reach a circle with the diameter of 50 cm should be T-50 = 4 +2/-2 seconds. A Slump test can be seen in Figure 5-13.

If the slump value was between 650 mm and 700 mm, the additives were allowed to be added to the concrete so that the slump- and the T50 value were corrected to be within the acceptable range.

Separation

No separation was allowed

Temperature before casting

The temperature of the concrete was measured at arrival and should never exceed 20°C. The concrete temperature, measured at Äspö was between 16 and 20°C.

Correction measurers if required

A slump value between 650 mm and 700 mm is corrected by adding plasticizer to control the T50 within the required tolerances. If the slump value is below 690 mm after the pump, the pump operator shall be contacted and reason shall be investigated. Check pump pressure and pump rate.

If the slump value is greater than 750 mm but the separation less than 20 mm, contact the factory immediately so action can be taken before mixing of the next batch. Take the delivery a side and wait 10 to 30 minutes, slowly rotating. Alternatively, plastic fibre is added to the concrete. The plastic fibre has an ability to bind water to its surface. Rotate the concrete with high speed for three minutes, and check the requirements. If all tolerance requirements are not fulfilled after these measures, the batch is rejected.

The concrete batch tested on site was rejected if:

- Slump value < 650 mm.
- Slump value < 700 mm and separation > 20 mm.
- All requirements are not fulfilled within 30 minutes after correction measurers.

Compressive strength

Finally, concrete cubes with dimension 15 cm x 15 cm were casted for tests of the compressive strength. The test specimens were stored at 20°C for 28 days before testing. Table 5-3 show the compressive strength after 28 days, together with measured density

Cubes were also tested during the first 6 days in order to register the development of strength, see Figure 5-15. The strength development is in quite good agreement with the estimated, Figure 3-12. However, the calculated strength development is however a little slower. This is probably due to that the plug maximum acceptable temperature (27°C) was exceeded by 5°C, i.e. the maximum temperature during curing was 32°C and that the cooling machine was not sufficient to keep the inlet water temperature to the required 6°C, Figure 5-15.

Table 5-3. Compressive strength after 28 days.

Test no.	Delivery batch	Density [kg/litre]	Strength [MPa]
111	3	2.41	76.4
112	6	2.39	76.0
113	8	2.4	73.6

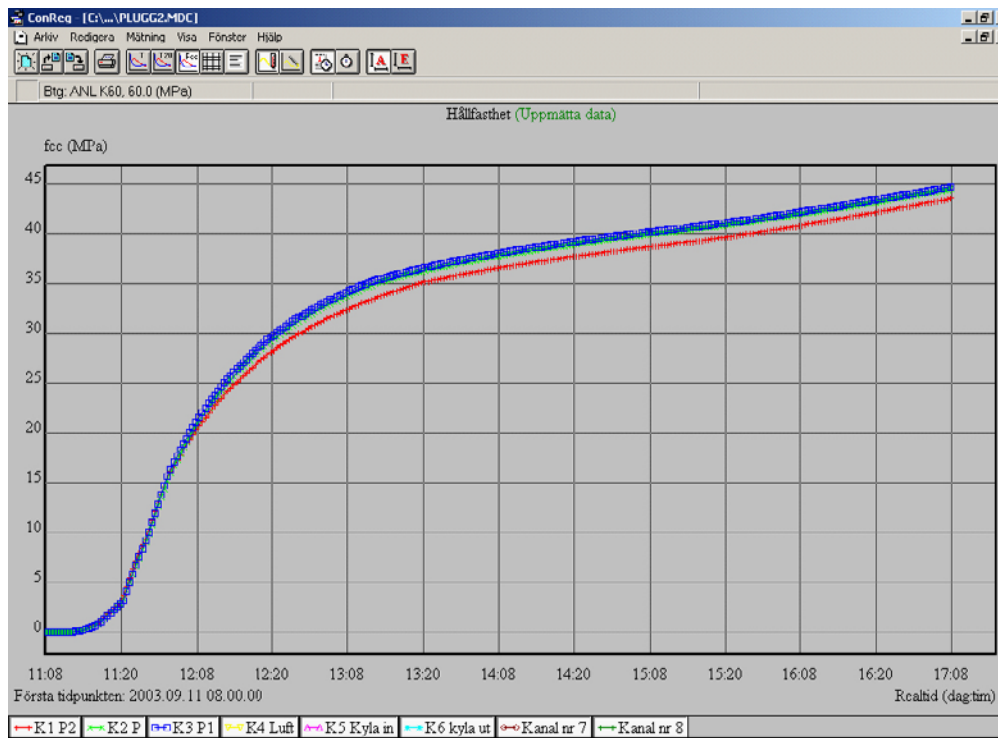

Figure 5-15. Development of strength during the first 6 to 7 days. Time is given in 12 hours interval.

5.4.3 Cast methodology

Before casting water at the bottom of the slot was thoroughly drained off. Pumping started from the first valve from bottom and the concrete was allowed to flow and fill the bottom of the slot. When the concrete level reached the bottom valve, the pumping continued and the concrete was pressed upwards, pushing (lifting) the dribbled water covering the concrete surface. At the final casting, the water was drained through the installed vent pipe, with one end at the top of the formwork and the other end at the very top of the slot.

5.4.4 Casting process

The first truck load with concrete arrived at the tunnel entrance at 07.00. The first load exhibited a good slump flow but unfortunately the separation value was a little high and the concrete had to be corrected with plastic fibres to get stability and to be within given tolerances. With the exception of minor separation (which was accepted) the concrete had good flow (750 mm) when it arrived at the site. Casting started at 07.50, after the water in the slot had been removed (about 500 l). Truck load 2, 3, 4 had the same consistence as the first. However, after truck load 4, the concrete factory succeeded to correct the problems, and the remaining concrete loads had a very good consistence. The casting was finished at 14.45 hours.

According to the concrete factory, Swerock, the consistence deviation of the delivered four first concrete loads, was due to a new delivery of additives which had a greater effect than the additive used at the pre-testing.

5.4.5 Cooling process

The cooling machine did not function perfectly at start up and several disruptions occurred. In order to handle this, a mechanics changed cooling medium and replaced the drying filter. This work was performed between 15.15 and 19.15 hours day 11, see Figure 5-16. During this period the temperature in the concrete developed freely without any control, which possible led to a maximum temperature of 32°C, i.e. 5 degrees higher than the theoretically estimated temperature of 27°C, see Figure 3-11.

The effect of the cooling machine was not sufficient; since it had difficulties to deliver water chilled to a temperature of 6°C, as required. The water temperature after circulation increased about 2.5°C, Figure 5-16, which is in agreement with calculations.

5.4.6 Inflow of water

Before casting, an inflow of water was noted at the invert surface below the concrete beams and during casting this water was supposed to be collected on the surface of the concrete. The water was collected in a much smaller amount than was expected. It seems like the water has been able to seek other paths. Most probably the water was pushed back towards the concrete beams and seeped into the openings between the beams.

When the concrete started to reach the top of the formwork, water was expected to be evacuated through the vent pipe installed at the very top of the plug contour, still no water was visible. In order to evacuate potential water on top of the concrete, the concrete pipe was moved from a valve at lower level to a valve at higher level. The valve was opened and about 100 litre of concrete was taken out. When the pumping work was recommenced about 20 litre of water was evacuated.

It is possible that smaller amount of water may have been trapped. It was considered that such possible location was able to be filled during the grouting process.

Grout consumption indicated later that no or very small open spaces was left after casting.

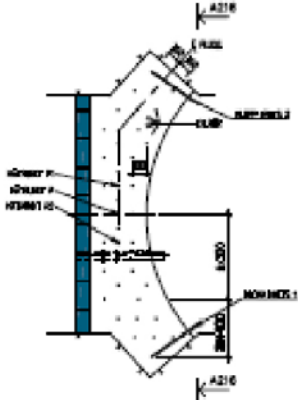
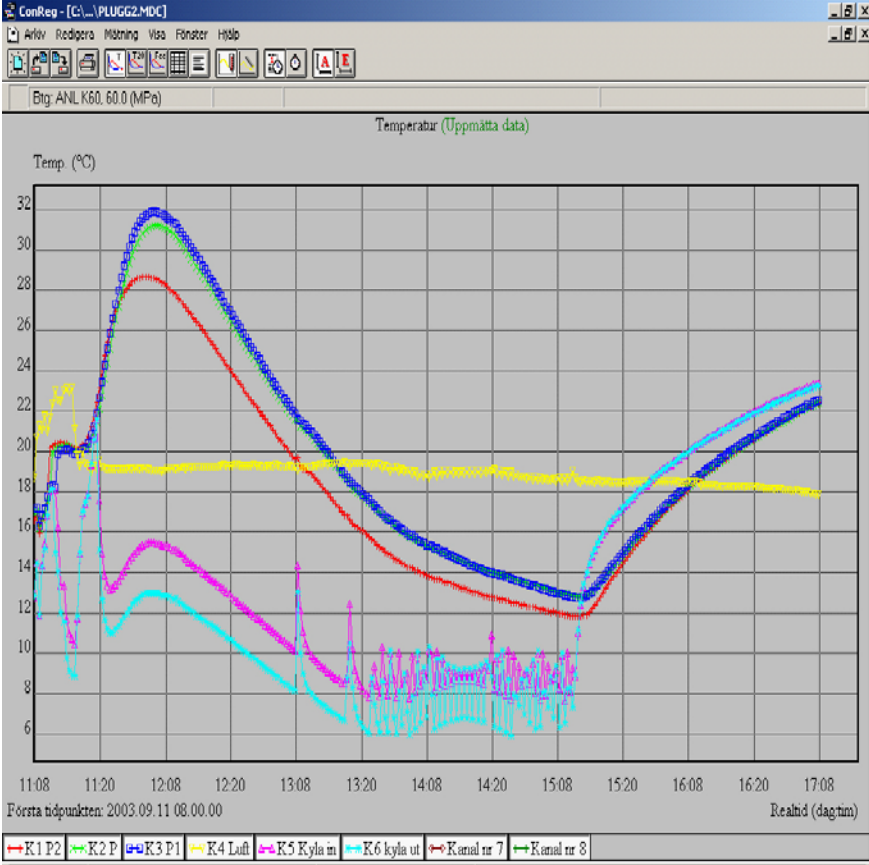

Figure 5-16. Temperature development the first six days. The temperatures in the plug were measured in the centre according to the figure on the side (K2P in the centre, K1P2 lower and K3P1 upper). Time is given in 12 hours interval.

5.5 Times and experiences

5.5.1 Time schedule

Preparatory work, formwork and casting were performed in a two shift set-up, and four men each shift. In all, the time required for preparatory work, formwork, installations and casting was estimated to 204 hours which correspond perfectly to the real outcome. Also, the allocations of time for different work operations correspond perfectly well. The reinforcement work was estimated to 72 hours, and actual time was 72 hours. Preparatory formwork was estimated to 27 hours and equals also perfectly to the actual time. The formwork at the final destination down the tunnel was estimated to 44 hours which also equals perfectly to the actual time.

After a breaking-in period and optimization of working procedures it should be possible to cut the time schedule quite extensively.

5.5.2 Experiences and conclusions

The need for reinforcement could be investigated further in order to see if it would be possible to design a concrete plug without reinforcement. The design is based on standards and regulations that suggest a certain minimum reinforcement, necessary or not. If these standards are not required in the design, but only know-how, calculations, engineering experience and judgments, it is possible that any reinforcement not is required since the plug is designed to only be subjected to compression forces.

The formwork and the reinforcement workability would be simpler if the concave side is replaced with just a vertical flat side. With such design some very small tensile stresses may develop on the flat side (at the side of atmospheric pressure) depending of the thickness of the plug. The cracks that will possible be produced by these small tensile stresses will not jeopardize the plug function (support as well as water barrier), since they will be very limited in range. Of cosmetic reasons the outer side may be covered.

If reinforcement still will be required in the future developed plugs, it would be very efficient to use prefabricated reinforcement cages instead of separate reinforcement bars.

Inflow of water from the rock periphery and from backfilled sections may affect the quality of the concrete, if the water is not evacuated properly. Piping affected the concrete quality occurred at several places at the bottom during casting of plug II.

It is important to use correct procedures and well known ingredients when Mixing Self Compacting Concrete.

6 Contact grouting

A massive concrete construction as the plugs in the Prototype Repository will shrink during the curing process and it may be expected that a gap will develop in the interface between rock and concrete. These gaps will later, during operation, act as small channels for water transportation. Therefore, in order to fulfil the water barrier function these gaps must be grouted. The gaps are varying in width and some are so narrow that it's difficult to penetrate them with grout. Therefore the plug is cooled to a temperature lower than ambient in order to contract the plug and thereby increase the width of gaps. After grouting the plug will expand and tighten up the gaps even further. The plug will be favourable constrained.

Drawing Pro.type-215, Appendix I, shows in detail the grouting system. Three lines of grouting tubes were installed along the periphery of the bearing or support side of the plug. In order to achieve a good contact, the tubes were inserted in the rock in a sawn slot around the rock contour. Each circuit line was divided in three parts, with possibility to feed at clock positions 10, 2 and 6.

6.1 Cooling procedure

The plug was cooled using the same cooling circuit as used during the curing period of the plug, but with an updated cooling machine. Figure 6-1 shows the temperature development in three points close to the centre of the plug; see drawing Pro.type-216, Appendix I.

Grouting was performed between 2004.10.06 and 2004.10.08. During this period the centre temperature of the plug was about 4.5°C. The temperature at the interface between concrete and rock was about 7°C, see Figure 7-9. The cooling contracts the plug and allow for better filling of grout materials. The width of the joint between rock and concrete was measured at three locations perpendicular to the surfaces. At the period of grouting the width was measured to 0.15 to 0.24 mm, which facilitate for easy penetration and filling with UF 16.

6.2 Work procedure

6.2.1 Grout material

It was planned to primary use cement grouting, with Ultrafine 16 (UF16), vct 0.8–1.0, and plasticizer, Cementsa Setcontrol. Silica Sol was considered as a complement.

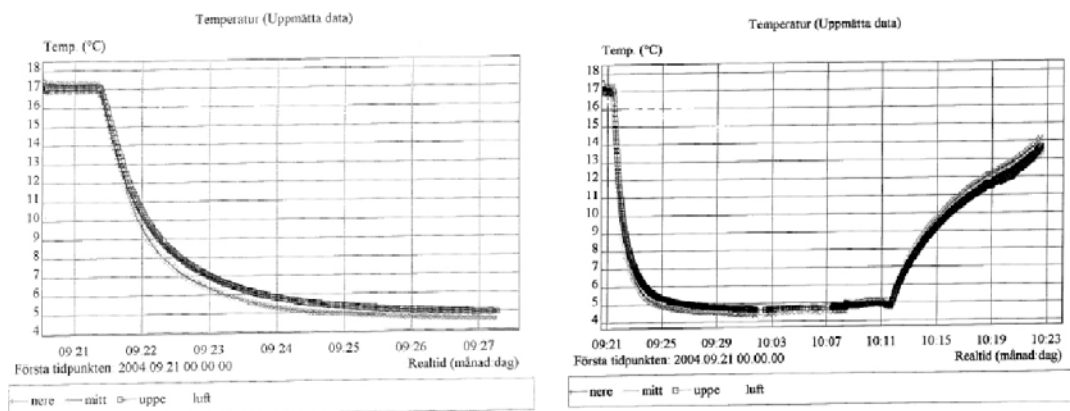

Figure 6-1. Temperature development between, left 2004.09.21–2008.09.27 and right 2004.09.21–2004.10.23.

6.2.2 Sequence

During the cooling procedures, it is checked that the temperature in the interface concrete/rock don't drop below +2°C.

The grouting procedure starts with grouting the inner tube, no. 1 with UF16. When the tube is full, the free end is blocked and grouting is continued, with a maximum pressure of 4 MPa.

Grouting of the outer tube no. 3 starts at the earliest twelve hours after grouting of the inner tube. Final maximum pressure is 4 MPa.

The middle tube, no. 2, is grouted with Silica Sol. The same procedures and stop criterion as tube 1 and 3.

The outer periphery of the led through pipes are grouted with UF16, see drawing Pro.type-215, Appendix I. Maximum pressure about 0.5 MPa.

The holes drilled earlier around the periphery to drain water (instead of grouting) in the plug seat are filled with UF16. The holes are filled from bottom with grout, vct 0.3.

6.2.3 Grout take

Grout take in tube 1 and 3 were 18.4 and 8.7 litre. Tube 2, was grouted with totally 26.5 litre of Silica Sol. Based on assumptions, it was expected the grout take to be somewhat greater.

6.3 Leakage control

The intentional function of the plug was to provide a sealing of axial water flow, to facilitate that sufficiently high water pressures could develop in the backfilled deposition tunnels. Unfortunately, due to other reasons than the plug, full pressure has not been allowed to develop. But it is clear, from monitoring, that the plug is sufficient to enable steady pressure built up, at least up to 1.6 MPa. Several weirs have been installed outside the plug in order to control leakage.

The inflow to the plug seat was about 0.8 litre/min from start. Instead of leakage control by grouting, this water was drained by drilling. The leakage after these drainage holes were drilled was 0.16 litre/min and 98 days later only 0.11 litre/min.

After casting of the plug, leakage was measured in weirs located at chainage 3535, 3525 and 3515, where 3535 is located just one metre in front of the plug. The measured inflow to weir 3535 was before grouting, 0.175 litre/minute. Most of this water was coming from the rock and very little water was coming from the intersection between concrete and rock.

After grouting the inflow to weir 3535 was measured to 0.025 litre/min. Unfortunately, no measurements were registered directly after grouting, but first 4.5 years later (2008.03.13). During this period the inflow has decreased about 86%. The corresponding inflow decrease in weirs 3525 and 3515 are 70% and 87%, respectively.

Today, the pressure behind the plug is about 1 MPa, and no visual leakage can be observed through the plug or through the interface between concrete and rock.

7 Instrumentation and measurements

7.1 Introduction

Mechanical measurements have been performed in the outer plug of the Prototype Repository since the construction in 2003. The measurements are performed in order to monitor and verify the function and the behaviour of the plug. Measurement data from September 2003 to September 2007 are presented as graphs in Appendix II

Selection of installed instruments as well as the results and a comparison with expected, calculated results, are presented in this section. The results are divided into three phases:

1. Results from casting 2003-09-10
2. Results from cooling 2004-09-21
3. Results for the whole period 2003–2008

7.2 Objectives of instrumentation

As described earlier, the primary function of the outer plug is to isolate the test area from the tunnel system by acting as a mechanical restraint against the backfill material. In addition it must permit adequately high groundwater pressures to build up behind the plug. The pressure gradients within the test area should be kept to a minimum so that the deposition hole nearest to the plug will have essentially the same pressures as the other deposition holes. For this reason, there is a requirement that the ‘tightness’ of the plug should be extremely high.

The potential seepage routes were primarily expected within the contact between the plug and the rock surface, as well as through fractures in the rock surrounding the plug. Little to no seepage was expected to occur through the plug itself.

When a concrete plug is constructed, the contact between the plug and the rock is typically good. However, certain difficulties are normal where air openings are located at the top, and the plug will experience shrinkage as a result of the hardening process. This shrinkage effect can be reduced with appropriate concrete techniques and additives. However a certain amount of shrinkage will occur and it can not be anticipated that there will be perfect contact between concrete and rock at all points.

In order to improve the contact and to block the seepage paths, contact grouting was conducted. To increase the effectiveness of the contact grouting the plug was chilled prior to the grouting operations. This facilitated the grouting by maximising the opening between the rock and concrete and thereby allowing the grout to more fully penetrate into any void spaces. Following the grouting, the cooling system was turned off, and the plug expanded to be in tight contact with the rock.

In order to monitor the width of the opening between the plug and to the rock, joint meters have been installed at the interface during construction of the plug. Strain gages have also been installed adjacent to each joint meter so that compression of the concrete itself can be determined separately from the crack width.

In addition to the instrumentation installed at the perimeter of the concrete plug, sensors have also been installed with the interior portions of the plug. These sensors, which are built into lengths of reinforcement steel, were installed to allow comparison of actual and calculated stresses in the structure which will result from the build up of pressures on the back side of the plug.

7.3 Selection and installation of instrumentation

Three types of instruments are installed in the plug. Joint meters were installed at the interface of the rock and the concrete in order to monitor the width of the opening. Strain gages were installed adjacent to each joint meter so that compression of the concrete itself can be determined separately from the crack width. Finally in addition to the instrumentation installed at the perimeter of the concrete plug, sensors were also installed within the interior portions of the plug. These sensors, which are built into lengths of reinforcement steel, were installed to allow comparison of actual and calculated stresses in the structure which will result from the build up of pressures on the back side of the plug.

7.3.1 Instruments at the concrete-rock interface

Joint meters

The Geokon model 4400 vibrating wire embedment joint meter was installed for monitoring deformations at the concrete-rock interface. The instrument is shown below in Figure 7-1. A total of six of the transducers were installed at the locations shown in Figure 7-4 (referred to as 09:00, 12:00 and 03:00, as on a clock face). At each of these locations a pair of joint meters was installed; one installed parallel to the tunnel axis, and the other perpendicular to the rock surface.

The joint meters are designed to measure displacements across joints and cracks in concrete, rock, soil and structural members. The transducer consists of a vibrating wire in series with a tension spring, and displacements are accommodated by stretching of the tension spring, which produces an associated increase in wire tension.

The sensors were installed by first boring holes into the rock at each installation locations. These holes were 120 mm deep and 80 mm in diameter. The socket, seen to the right in Figure 7-1, was then fixed into the borehole using Hilti Hit-Hy 150/330 adhesive anchor system, with the injection proceeding from the base of the borehole outward. After the adhesive compound had hardened, the instrument was screwed into the socket threads found at the far end of the socket. The gages were then adjusted to allow measurement of both elongation and compression by gently pulling the gage body away from the socket and temporarily fixing it with electrical tape which will give way under forces resulting from the concrete.

A thermistor was located inside the vibrating wire transducer housing so that the temperature can be measured at the instrument location. These temperature measurements can be used in the data reduction to correct for the effects of thermal expansion of the gauge itself.

These gauges were further modified with an additional Swage loc fitting to permit additional protective polyamide tubing attached to the gauge. This tubing was fastened to the sensor and a 10 m length was placed over the standard instrument cable to provide additional protection to the length of cable embedded within concrete.



Figure 7-1. Geokon Model 4400 joint meter.

Strain gauges

The Geokon model 4200 concrete embedment strain gauge was installed parallel to each joint meter. A total of six of these strain gauges were installed for the purpose of measuring the strain within the concrete. By using these measurements the total deformation measured in the joint meters could be separated into movements across the joint, and strains within the concrete mass along the length of the 400 mm length of the joint meter.

The gauge is shown in Figure 7-2.

The model 4200 strain gauge is designed for direct embedment in concrete, and has a 153 mm gauge length. It is commonly used for strain measurements in foundations, piles, bridges, dams, etc. Strains are measured using the vibrating wire principle where a length of steel wire is tensioned between two end blocks that are embedded directly in the concrete. Deformations of the concrete mass will cause the two end blocks to move relative to each other thus altering the tension in the steel wire. Each gauge also contains a thermistor so that temperatures can be read at the gauge location.

The strain gauges were installed by fixing additional angled sections of reinforcing steel to the existing reinforcement details. These small diameter rebar sections were placed in such a way that the strain gauges could be loosely suspended with plastic tie-wires from each end of the gauge at the desired location. The gages were placed parallel to the associated joint meter, however at a distance of about 250 mm so that each instrument would not influence the measurements taken at the adjacent sensor.

7.3.2 Strain gauges within the concrete plug

In addition to the instrumentation installed at the interface between the concrete plug and rock, sensors have also been installed with the interior portions of the plug. These sensors, which are built into lengths of reinforcement steel, were installed to allow confirmation of stresses that will be induced within the structure when pressures build up on the backside of the plug.

The Geokon Model 4911A Vibrating wire rebar strain meter was used to measure strains within the concrete, and to allow comparison of calculated to measured concrete stresses as pressures build up behind the plug.

The rebar strain meter is shown in Figure 7-3

The reinforcing steel sections on either side of the central strain gauge area are long enough to provide adequate contact with the surrounding concrete so that the measured strains inside the steel are equal to the strains in the surrounding concrete. Thermistors are also built into the instruments so that an evaluation of thermally induced strains can be made. The gauges installed in the plug were modified slightly from the manufacturer's standard detail in that an additional fitting was connected at the compression fitting to allow placement of a polyamide tube over the instrument cable over the length embedded within concrete to provide additional protection to the cable.



Figure 7-2. Geokon Model 4200 embedded strain gauge.



Figure 7-3. Geokon Model 4911A rebars strain gauge.

The gauges installed were manufactured from sections of No.8 reinforcing steel which have a diameter of 25.4 mm (1 inch) and the total length of each instrumented section of reinforcing steel is 1,105 mm. The gages are made of steel having f_y of 414 MPa and a Young's modulus of E-value of $2 \cdot 10^5$ MPa.

These lengths of instrumented reinforcing steel were placed into the plug in addition to the originally designed reinforcement steel. There were no sections of the existing steel removed and replaced, but rather there are additional reinforcing bars within the instrumented zone of the plug. The rebar strain meters were welded at each end to sections of standard 25 mm diameter steel bars, as shown in Figure 7-3. A total of six length of steel were fabricated (with two gauges on each of the 3.5 m lengths) and installed within the plug.

7.4 Summary of selected instruments and locations

In Table 7-1 the numbers and types of instruments were selected for installation to allow monitoring of the concrete plug.

7.4.1 Joint meters

Figure 7-4 shows the location of the joint meters in the plug. As can be seen they are all installed over the interface between rock and concrete. They are installed to measure width of opening over the interface and potential shear displacements.

Table 7-1. Summary of plug instruments.

Instrument location	Instrument type	Total number installed
Joint meter perpendicular to concrete-rock contact	Geokon model 4400	3
Joint meter parallel to tunnel axis	Geokon model 4400	3
Strain gauge perpendicular to concrete-rock contact	Geokon model VCE-4200	3
Strain gauge parallel to tunnel axis	Geokon model VCE-4200	3
Rebar strain gauges in plug	Geokon model 4911A	12

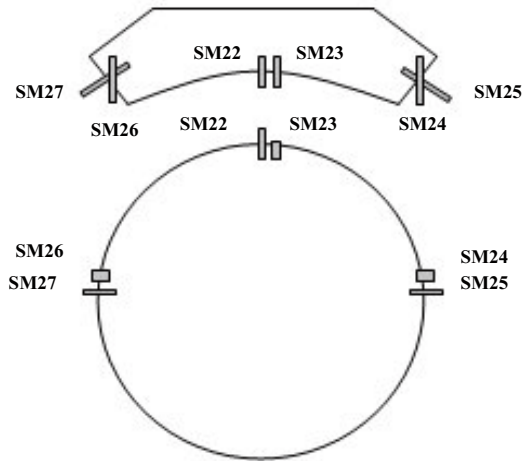

Figure 7-4. Plan and elevation view of plug with joint meter identification numbers.

Table 7-2. Summary of joint meters.

Serial number	SICADA ID code	Location/orientation	x	y	z
03-47726 (SM26)	PXPPL2001	Left side; 09:00; parallel to tunnel axis	7,265.440	1,928.665	-446.445
03-47727 (SM27)	PXPPL2004	Left side; 09:00; perpendicular to contact	7,265.390	1,928.564	-446.688
03-47723 (SM23)	PXPPL2002	Roof; 12:00; parallel to tunnel axis	7,268.272	1,929.140	-443.835
03-47722 (SM22)	PXPPL2005	Roof; 12:00; perpendicular to contact	7,268.174	1,929.031	-443.803
03-47724 (SM24)	PXPPL2003	Right side; 03:00; parallel to tunnel axis	7,271.107	1,929.478	-446.238
03-47725 (SM25)	PXPPL2006	Right side; 03:00; perpendicular to contact	7,271.205	1,929.409	-446.499

7.4.2 Embedded strain gauges

Location of the embedded instruments is shown in Figure 7-5.

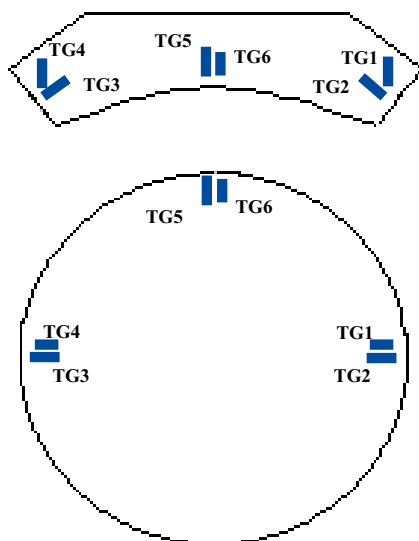

Figure 7-5. Plan and elevation view of the plug and the embedded instruments with identification number.

Table 7-3. Summary of embedment strain gauges.

Cable marking	SICADA ID code	Location/orientation	x	y	z
TG 4	PXPPL2007	Left side; 09:00; parallel to tunnel axis	7,265.610	1,928.538	-446.445
TG 3	PXPPL2010	Left side; 09:00; perpendicular to contact	7,265.434	1,928.364	-446.688
TG 6	PXPPL2008	Roof; 12:00; parallel to tunnel axis	7,268.452	1,929.014	-443.863
TG 5	PXPPL2011	Roof; 12:00; perpendicular to contact	7,268.056	1,928.872	-443.875
TG 1	PXPPL2009	Right side; 03:00; parallel to tunnel axis	7,270.930	1,929.301	-446.238
TG 2	PXPPL2012	Right side; 03:00; perpendicular to contact	7,271.267	1,929.167	-446.499

7.5 Rebar strain meters

Table 7-4. Summary of rebar strain gauges.

Cable marking	Serial number	SICADA ID code	x	y	Z
AJ 1	25652	PXPPL2024	7,270.481	1,927.754	-446.703
AJ 2	25653	PXPPL2023	7,269.246	1,927.579	-446.697
AJ 3	25654	PXPPL2022	7,269.906	1,927.689	-445.284
AJ 4	25655	PXPPL2021	7,269.018	1,927.573	-446.166
AJ 5	25656	PXPPL2020	7,268.465	1,927.509	-444.697
AJ 6	25657	PXPPL2019	7,268.478	1,927.499	-445.947
AJ 7	25658	PXPPL2018	7,270.364	1,928.652	-446.728
AJ 8	25659	PXPPL2017	7,269.148	1,928.411	-446.748
AJ 9	25660	PXPPL2016	7,269.731	1,928.562	-445.373
AJ 10	26046	PXPPL2015	7,268.828	1,928.344	-446.18
AJ 11	25662	PXPPL2014	7,268.404	1,928.303	-444.71
AJ 12	25663	PXPPL2013	7,268.389	1,928.279	-445.959

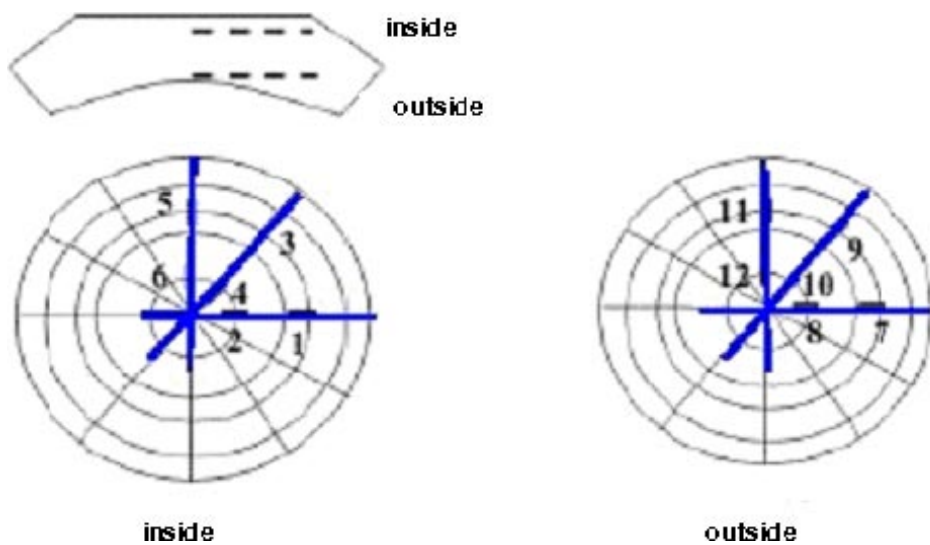

Figure 7-6. Plan and elevation view of plug with rebar strain gauge identification numbers and dimensions.

7.6 Evaluation of raw data

7.6.1 Evaluation of strain from strain gauge

Strain measurements taken with the Geokon Model 4200 gauges were calculated as temperature compensated strain with the following equation:

$$\mu\epsilon_{true} = (R_1 - R_0) * GF * B + (T_1 - T_0)(C_1 - C_2)$$

$\mu\epsilon_{true}$ = temperature compensated microstrain

R_1 and R_0 = digits reading

GF = theoretical gauge factor

B = batch calibration factor

C_1 and C_2 are the coefficients of expansion of steel and concrete, 12.2 microstrain/C° and 8.5 microstrain/C°.

7.6.2 Evaluation of deformation

Deformation measurements taken with the Geokon Model 4400 joint meters were calculated as temperature compensated deformation with the following equations:

$$\text{Deformation}_{corr} = ((R_1 - R_0) * C) + ((T_1 - T_0) * K) + L_c$$

Where R_1 and R_0 are the current and initial readings respectively, in units of digits (frequency² / 1,000),

T_1 and T_0 are the current and initial temperatures respectively in °C,

C is the gauge specific calibration factor,

K is the thermal coefficient based on the following equation:

$$K = ((R_1 * M) + B) * C$$

Where $M = 0.000295$, and $B = 1.724$,

L_c is the gauge length correction based on the following equation:

$$L_c = (17.3 * 10^{-6}) * (\text{Length of the deformation meter} - \text{transducer length}) * (T_1 - T_0).$$

7.6.3 Evaluation of strain from rebar strain meter

The Rebar strain meter is designed to be wire tied in parallel with the structural rebar.

The measurements taken with the Geokon Model 4911A were calculated with the following equations:

$$\epsilon_{corrected} = ((R_1 - R_0) * C) + ((T_1 - T_0)) * K_{concrete}$$

Where R_1 and R_0 are the current and initial readings respectively, in units of digits (frequency² / 1,000),

C is the calibration factor in microstrain/digit,

T_1 and T_0 are the current and initial temperatures respectively in C°,

K is the thermal coefficient from Table.

7.7 Results from measurements

Presented here are a summary of the results from the measurements in the plug. All results are presented graphically in Appendix II.

7.7.1 Joint meters and adjacent strain gauges at rock interface

Six joint meters (SM) were installed across the interface of the rock and concrete plug together with six adjacent strain gages (TG) in the concrete, see Figure 7-7 below. This installation was done so that the compression of the concrete itself could be determined separately from the interface aperture.

The width of the opening between rock and concrete could then be calculated as:

$$\Delta Width_{mm} = [deformation\ of\ joint\ meter] + [strain \cdot length\ along\ joint\ meter]$$

7.7.2 During casting

The joint meters and adjacent strain gauges indicate that the plug is forced tight to the rock interface after construction (casting). The joint meters show a compression and the adjacent strain gauges indicate that the compression is due to the expansion in the concrete due to the heating, see Figure 7-8 and Table 7-5.

7.7.3 During cooling

During the cooling in September 2004 the temperature in the plug was lowered about 10°C. This was done for the purpose of facilitating grouting in the space between rock and concrete. The measured results from the cooling show that the interface width increases at the location of the instruments installed perpendicular to the rock. This increase of the interface width is the result of shrinkage of the plug due to the decreased temperature. The instruments installed parallel to the tunnel axis show no increase in intersection width, probably due to the pressure from the backfill behind the plug. The greatest change of intersection width during the cooling is on the right side of the plug looking from the outside with a 0.24 mm increase. This corresponds well with the estimated opening width. The true radial contraction is somewhat greater than the measured since the gauge is installed perpendicular to the abutment and not and not radial the plug and perpendicular to the tunnel wall.

Table 7-5. Estimated maximum change of interface aperture between plug and rock during casting, calculated from joint meters and embedded strain gauges.

Instrument	Location in plug	Δ width [mm]
SM22, TG5	Roof perpendicular to contact	-0.08
SM23, TG6	Roof parallel to tunnel axis	0.02
SM24, TG1	Right side, parallel to tunnel axis	-0.1
SM25, TG2	Right side, perpendicular to contact	-0.32
SM26, TG4	Left side, parallel to tunnel axis	-0.2
SM27, TG3	Left side, perpendicular to contact	-0.46

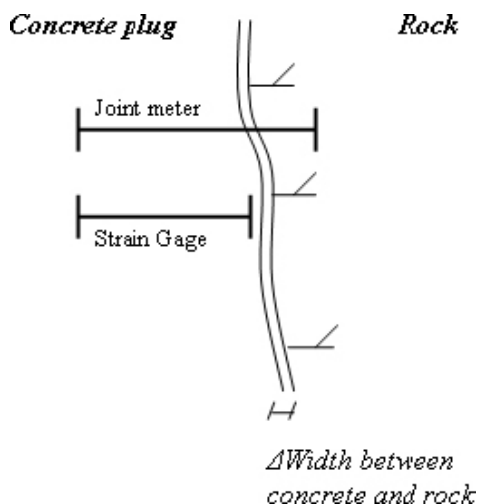

Figure 7-7. Installation of joint and strain gauge meter at the interface of the rock and concrete.

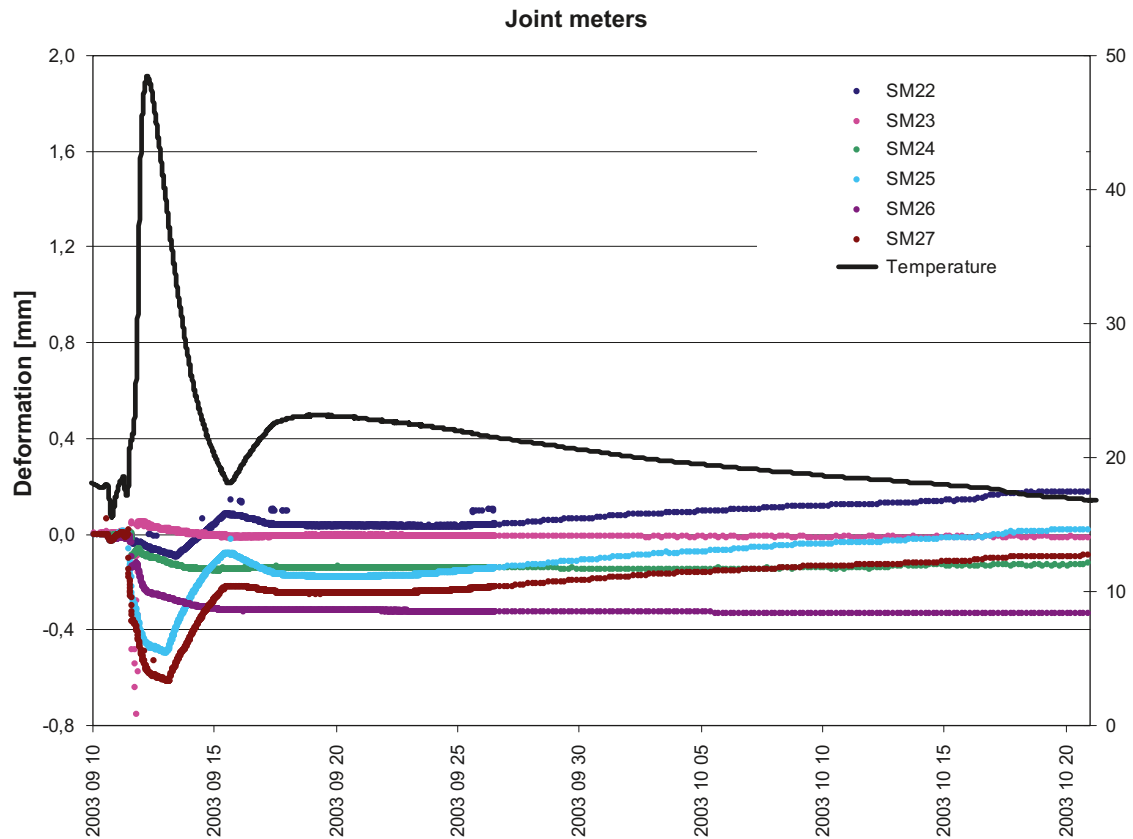

Figure 7-8. Joint meters during casting of the plug plotted with temperature.

Table 7-6. Maximum change of interface aperture between plug and rock due to the cooling that preceded grouting.

Instrument	Location in plug	Δ width [mm]
SM22, TG5	Roof perpendicular to contact	0.19
SM23, TG6	Roof parallel to tunnel axis	-0.01
SM24, TG1	Right side, parallel to tunnel axis	-0.02
SM25, TG2	Right side, perpendicular to contact	0.24
SM26, TG4	Left side, parallel to tunnel axis	-0.01
SM27, TG3	Left side, perpendicular to contact	0.15

7.7.4 Permanent deformation of the interface at the end of 2007

The results of the measurements at the end of 2007 are shown below in Table 7-7. The three instruments installed perpendicular to the rock surface all show an increase of interface width which essentially is a result of the contraction during the cooling period in 2004. This gap was intended and was probably filled and sealed by grout. The other Joint meter instruments installed parallel to the tunnel axis show a compression across the interface. Their adjacent strain gages are not being compressed, some even tensioned and that indicates that the plug has been deformed or has slipped due to the pressure from the back fill. As an exception SM23 also parallel to the tunnel axis but located at the top of the plug shows a small increase of crack width of 0.05 mm but that might be due to shrinkage of the concrete.

Table 7-7. Total width between plug and rock at the end of 2007.

Instrument	Location in plug	width [mm]
SM22, TG5	Roof perpendicular to contact	0.33
SM23, TG6	Roof parallel to tunnel axis	0.05
SM24, TG1	Right side, parallel to tunnel axis	-0.08
SM25, TG2	Right side, perpendicular to contact	0.33
SM26, TG4	Left side, parallel to tunnel axis	-0.47
SM27, TG3	Left side, perpendicular to contact	0.11

7.7.5 Rebar strain gauges within the plug

The rebar strain gauges were calculated with a temperature correction as actual strain. With the assumption that concrete is a linear-elastic material and that the plug is under one-dimensional state of stress the strain could be converted to stress with:

$$\sigma = \varepsilon \cdot E_{Concrete}$$

Where $E_{Concrete}$ is the elastic modulus of the concrete and ε is the measured strain.

7.7.6 After casting

During casting the temperature rises at first and the strain gauges show a little tension before being compressed as the temperature is lowered. After casting the instruments installed at the outside of the plug show the largest values of compression.

With a characteristic Young's modulus of the concrete of 34.0 GPa (section 3.7.1) the maximum stress change measured perpendicular to the tunnel axis in the direction of the instrument would be:

$$\sigma = -115 \cdot 10^{-6} \cdot 34.0 \cdot 10^9 \approx -3.8 \text{ MPa}$$

and with the lower presented Young's modulus

$$\sigma = -115 \cdot 10^{-6} \cdot 23.6 \cdot 10^9 \approx -2.7 \text{ MPa}$$

The results from the strain gauges measured after casting are presented below in Table 7-8.

7.7.7 Strain and stresses during cooling

During cooling of the plug the concrete shrink and the compressive strain rises for a while, see Figure 7-9. The change in stresses during cooling is relatively equal across the plug ranging from 1.4 to 2.2 MPa, Table 7-9.

Table 7-8. Maximum strain change during casting.

Instrument	Location in plug	$\Delta\mu\text{strain [-]}$	ΔMPa
AJ1	Inside of plug, outer	-48	-1.2
AJ2	Inside of plug, central	-60	-1.5
AJ3	Inside of plug, outer	-67	-1.6
AJ4	Inside of plug, central	-55	-1.4
AJ5	Inside of plug, outer	-78	-1.9
AJ6	Inside of plug, central	-55	-1.4
AJ7	Outside of plug, outer	-115	-2.8
AJ8	Outside of plug, central	-108	-2.7
AJ9	Outside of plug, outer	-60	-1.5
AJ10	Outside of plug, central	-100	-2.5
AJ11	Outside of plug, outer	-30	-0.7
AJ12	Outside of plug, central	-80	-2

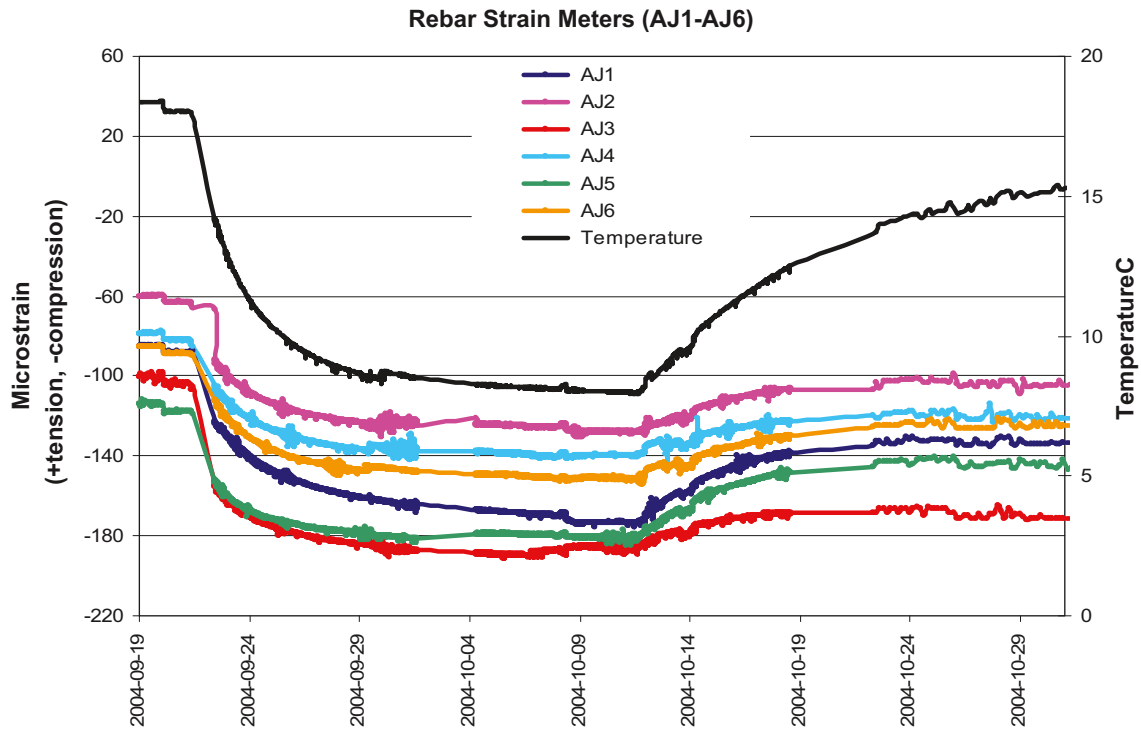

Figure 7-9. Rebar strain gauges on the inside of the plug during cooling plotted with temperature.

Table 7-9. Maximum strain change during cooling.

Instrument	Location in plug	$\Delta\mu\text{strain [-]}$	ΔMPa
AJ1	Inside of plug, outer	-85	-2.1
AJ2	Inside of plug, central	-60	-1.5
AJ3	Inside of plug, outer	-90	-2.2
AJ4	Inside of plug, central	-60	-1.5
AJ5	Inside of plug, outer	-65	-1.6
AJ6	Inside of plug, central	-65	-1.6
AJ7	Outside of plug, outer	-70	-1.7
AJ8	Outside of plug, central	-60	-1.5
AJ9	Outside of plug, outer	-65	-1.6
AJ10	Outside of plug, central	-55	-1.4
AJ11	Outside of plug, outer	-70	-1.7
AJ12	Outside of plug, central	-55	-1.4

7.7.8 Permanent strain at the end of 2007

The results of the strains in the plug are presented below in Table 7-10. The maximum stress perpendicular to the tunnel axis is approximately -4.9 MPa. What is most important in the results is that that whole plug is under compression. The results of the inner instruments for the whole measuring period between 2003–2007 are presented below in Figure 7-10. The irregular values in the beginning are due to disturbance/electrical noise during the casting process.

Table 7-10. Strains at the end of 2007.

Instrument	Location in plug	$\Delta\mu\text{strain [-]}$	ΔMPa
AJ1	Inside of plug, outer	-130	-3.2
AJ2	Inside of plug, central	-140	-3.4
AJ3	Inside of plug, outer	-175	-4.3
AJ4	Inside of plug, central	-140	-3.4
AJ5	Inside of plug, outer		
AJ6	Inside of plug, central	-160	-3.9
AJ7	Outside of plug, outer	-170	-4.2
AJ8	Outside of plug, central		
AJ9	Outside of plug, outer	-160	-3.9
AJ10	Outside of plug, central	-200	-4.9
AJ11	Outside of plug, outer	-115	-2.8
AJ12	Outside of plug, central	-200	-4.9

7.8 Comparison with calculated results and verifying of construction

When the plug was designed, stresses, strain and deformations were estimated with a 3D numerical model where the plug was exposed to a pressure of 4.5 MPa, and the measurements in the plug were performed to be able to compare the results and to verify the construction of the plug. However, the plug was for a certain reason (problems with heaters) never exposed to the design load. Instead, the maximum pressure acting on the plug was 1.6 MPa, see Figure 7-11.

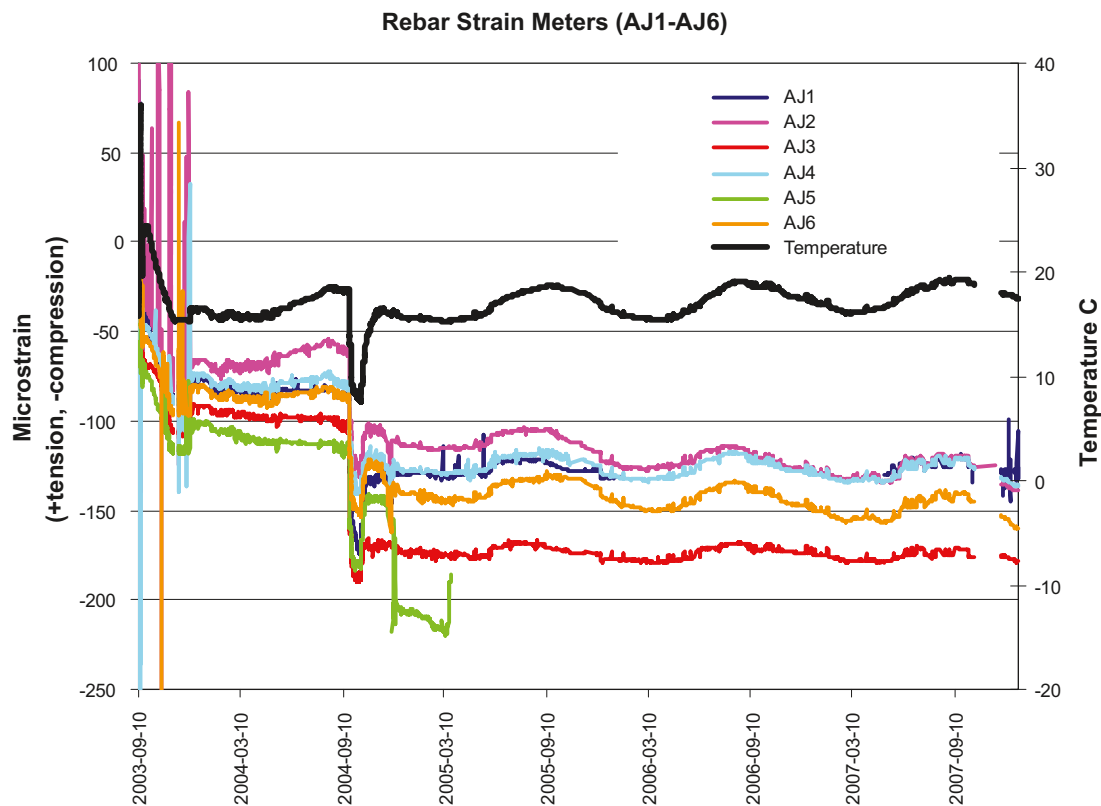

Figure 7-10. Results from 2003–2007 of rebar strain gauges situated on the inside of the plug plotted with temperature.

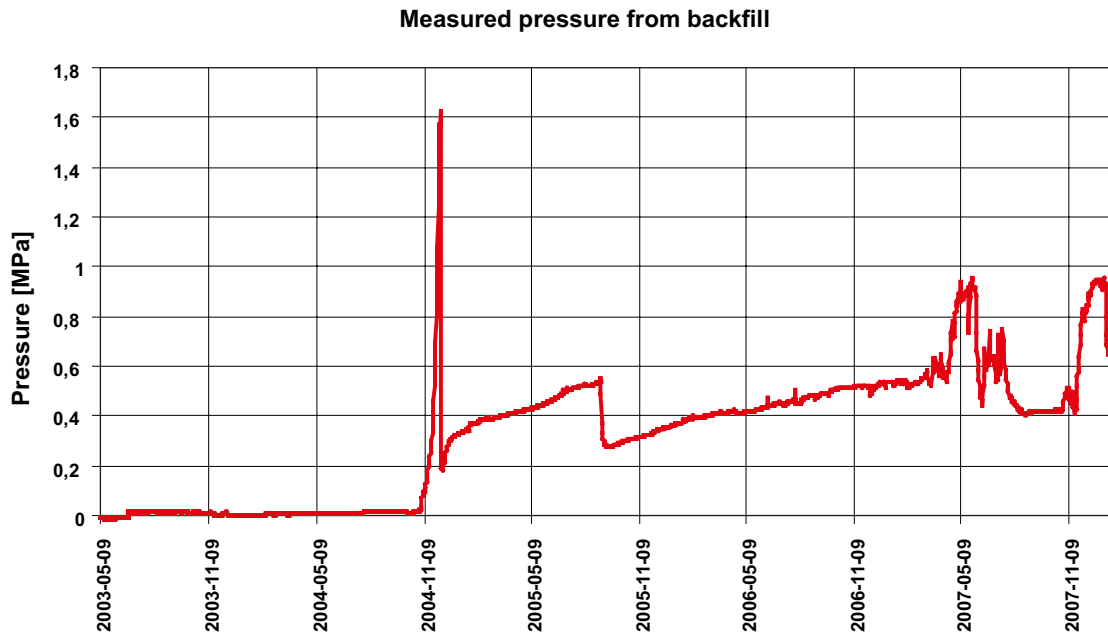

Figure 7-11. Measured pressure from Kulite instrument PFA16 located on the inside surface of the plug.

7.8.1 Maximum stress and strain

Strains were only measured in the direction of the instruments, perpendicular to the tunnel axis and are only compared to strains calculated in that direction. When the measured strains are converted to stresses it is assumed that the concrete in the plug is a linear-elastic material.

The maximum stress measured in the plug is:

$$\sigma = -200 \cdot 10^{-6} \cdot 24.6 \text{ GPa} \approx -5 \text{ MPa}$$

While the maximum calculated stress in the plug was:

-9 to -16 MPa depending on rock properties.

The locations of the maximum stresses are not perfectly correlated between the calculated and measured methods but the measurements show that the whole plug is compressed which was the purpose of its design.

7.8.2 Interface deformation

As shown in section 3.9.3 the theoretically increase of the width between the rock and the concrete is about 0.25 mm on both sides of the plug when the temperature is lowered with 10°C. This correlates well to the measured values.

The results from the measurements show that the maximum increase was 0.24 mm on the rights side of the plug measured perpendicular to the rock. The left side shows an increase of joint width of 0.15 mm which means the measured values are in well agreement with predicted results.

Shear movement

The plug was also predicted to slip a little at the contact between the rock and the concrete. At the end of 2007, a compression of the interface aperture is noticed on the instruments installed parallel to the tunnel axis. Their adjacent strain gauges are not being compressed, some even tensioned and that indicates that the plug has been deformed or has slipped due to the pressure from the back fill. The largest decrease of interface aperture is 0.47 mm on the left side of the plug measured parallel to the tunnel axis.

8 References

- /1/ **Dahlström L O, 1998.** Test plan for the Prototype Repository. SKB Progress Report HRL-98-24, Svensk Kärnbränslehantering AB.
- /2/ **IPR-01-17.** Report on the installation of back fill and plug test. Svensk Kärnbränslehantering AB.
- /3/ **Electric Power Research Institute, EPRI, 1987.** Design Guidelines for Pressure Tunnels and Shafts.
- /4/ **Publ no. 35 BK/1972/ Rev 78.** Konstruktionsanvisningar för skyddsbarriär, Fortifikationsförvaltningen (the Swedish Fortifications Agency), in Swedish.
- /5/ **Patel S, Dahlström L O, Stenberg L, 1997.** Characterisation of the rock mass in the Prototype Repository at Äspö HRL, Stage 1. SKB Progress Report HRL-97-24, Svensk Kärnbränslehantering AB.
- /6/ **Waltham A C, 1994.** Foundations of Engineering Geology. Blackie Academic & Professional, Glasgow, UK.
- /7/ **Bienawski Z T, 1988.** The Rock Mass Rating (RMR) System (Geomechanics Classification) in Engineering Practice. ASTM report STP 984. Editor Kirkaldie L.
- /8/ **Serafim J L, Pereira J P, 1983.** Considerations of the Geomechanics Classification of Bienawski, in Proceedings, International Symposium on Engineering Geology and Underground Construction, LNEC, Lisbon, Portugal, vol. 1, pp. 59–68.
- /9/ **Hoek E, Brown E T, 1980.** Underground Excavation in Rock. Institute of Mining and Metallurgy, London.

Drawings

Project Prototype Repository, Concrete Plug 2

Pro.type- 201, compilation

Pro.type- 211, slot in rock/ plug seat

Pro.type- 213, prefabricated elements: dimensions and reinforcement

Pro.type- 214, plug: dimensions and reinforcement

Pro.type- 215, grouting system

Pro.type- 216, cooling system

Pro.type- 221, mould: compilation

Pro.type- 222, mould type 2 and 3: steel details

Pro.type- 223, mould type 4, 5, and 6: steel details

Pro.type- 231, anchoring of lead-through

Text on drawings is in Swedish. However, the context is considered to be fully understandable also for those who not read Swedish.

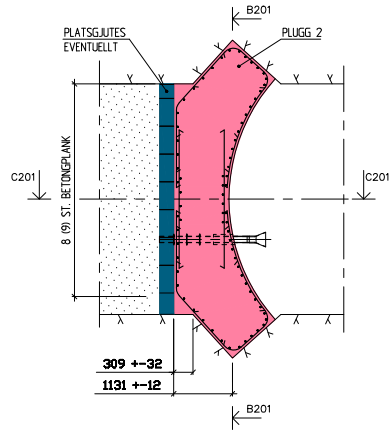

SEKTION A201 150

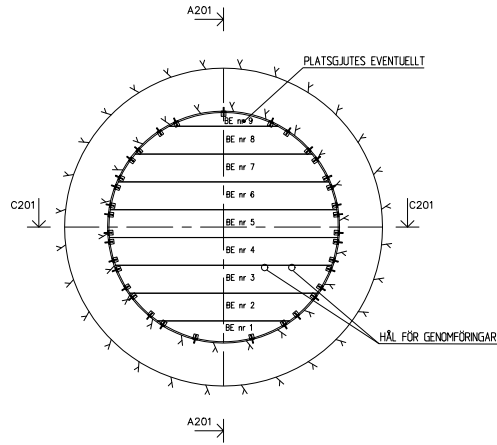

ELEVATION B201 150

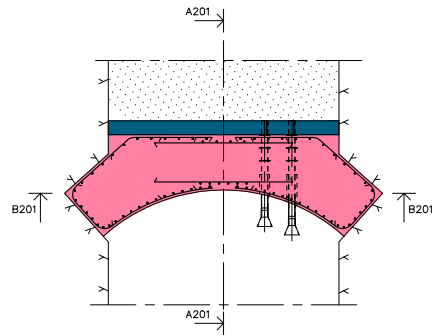

SEKTION C201 150

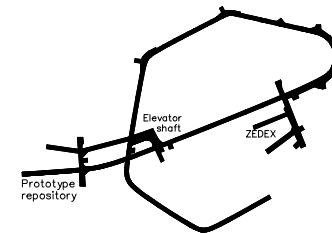

ORIENTERINGSPLAN

HÄNVISNINGAR

SLOTS I BERG	SE RITN. Pro.type-211
VAKANT	Pro.type-212
PREFABLEMENT	SE RITN. Pro.type-213
PLUGG, MÄTT/ÄRMERING	SE RITN. Pro.type-214
INJEKTIONSSYSTEM	SE RITN. Pro.type-215
KYLSYSTEM	SE RITN. Pro.type-216
FORM	SE RITN. Pro.type-221
FORM TYP 2 OCH 3	SE RITN. Pro.type-222
FORM TYP 4, 5 OCH 6	SE RITN. Pro.type-223
FÖRANKRING PÅ GENOMFÖRING	SE RITN. Pro.type-231

A	BYGGHANDLING	02-05-08	
BET	ANT	INOMRÅNS AVGR	DATUM
BYGGHANDLING			
ÄSPÖ HARD ROCK LABORATORY			
NCC		NCC TEKNIK	
		205 47 MALMÖ	
		(Thomsons väg 40)	
		Tfn 040-31 70 00	
		Fax 040-21 67 02	
UPPRÅD NR	02/2020	REDA/ÄRSKRIV AV	LNy / ET
MALMÖ	HANDLÄGGARE	PROJECT PROTOTYPE REPOSITORY	
02-04-1B	LARS-ERIK NYDAHL	CONCRETE PLUG 2	
ANSVARS		SKALA	150
		NUMMER	Pro.type-201 A

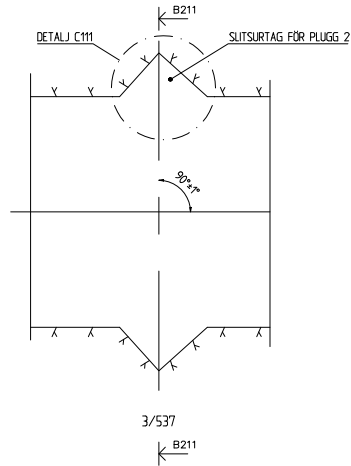

SEKTION A211 150

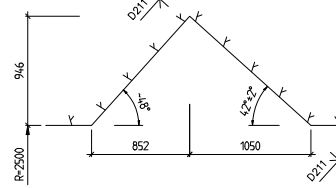

DETALJ C211 120

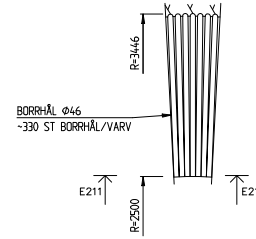

DETALJ D211 120

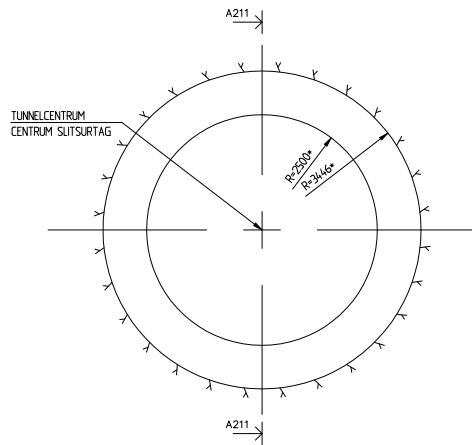

ELEVATION B211 150
*) TEORETISKT MÅTT

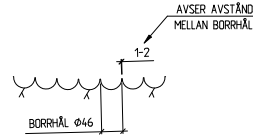

DETALJ E211 15

TOLERANSER

SLITSEN UTFÖRD ENLIGT RITNING PRO.TYPE-111.

HÄNVISNINGAR

SAMMANSTÄLLNING	SE RITN. Pro.type-201.
VAKANT	Pro.type-212.
PREFABELEMT	SE RITN. Pro.type-213
PLUGG: MÅTT/ARMERING	SE RITN. Pro.type-214
INJEKTERINGSSYSTEM	SE RITN. Pro.type-215
KLITSYSTEM	SE RITN. Pro.type-216
FORM	SE RITN. Pro.type-221
FORM TYP 2 OCH 3	SE RITN. Pro.type-222
FORM TYP 4, 5 OCH 6	SE RITN. Pro.type-223
FÖRANKRING PÅ GENOMFÖRING	SE RITN. Pro.type-231

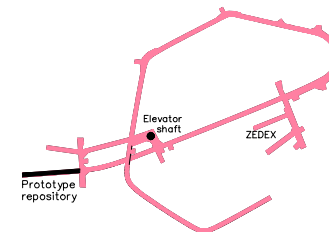

ORIENTERINGSPLAN

A	BYGGHANDLING	02-05-08	
BET	ANT	ZÄRRÖREN AVSER	DATUM
BYGGHANDLING			
ÄSPÖ HARD ROCK LABORATORY			
NCC		NCC TEKNIK	
		205 47 MALMÖ	
		(Thomsons väg 40)	
		Tfn 040-31 70 00	
		Fax 040-21 67 02	
UPPDRAG NR	RITAD/KONSTR. AV	PROJEKT PROTOTYPE REPOSITORY	
02/2020	LNy / CT	CONCRETE PLUG 2	
TITEL	TEKNIKENSURE		
02-04-18	LARS-ERIK NYDAHL	SLITS I BERG	
ZÄNSVARG	SKALA	MÄNNER	I BET
	150, 120, 15		Pro.type-211 A

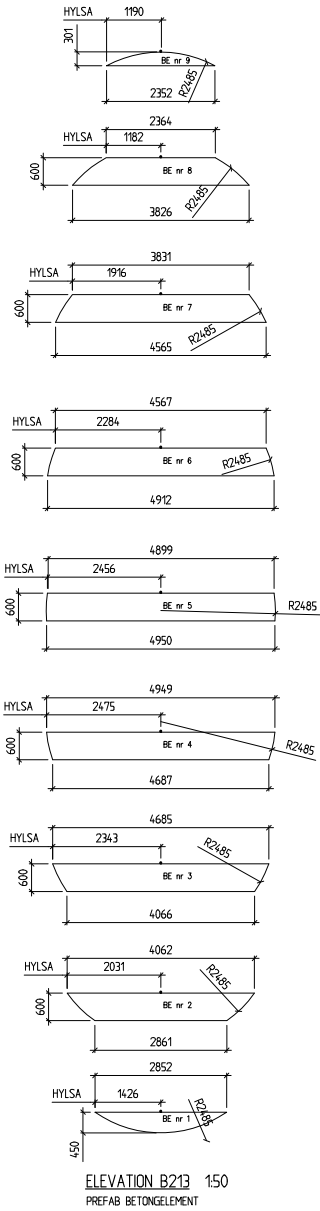

ELEVATION B213 150
PREFAB BETONGELEMANT

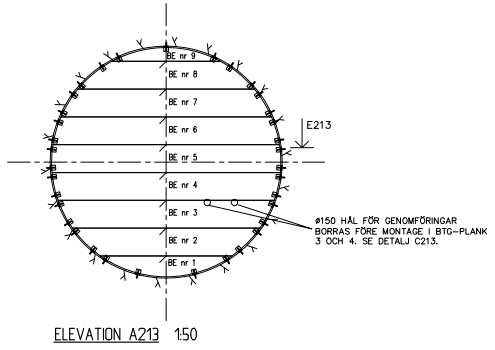

ELEVATION A213 150

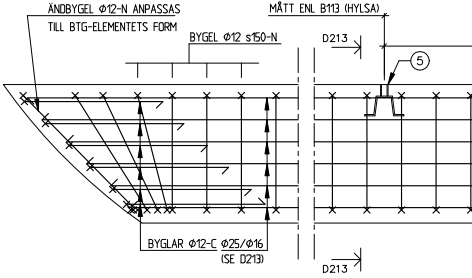

DETALJ C213 1:10
PREFAB BETONGELEMANT

SEKTION D213 1:10
PREFAB BETONGELEMANT

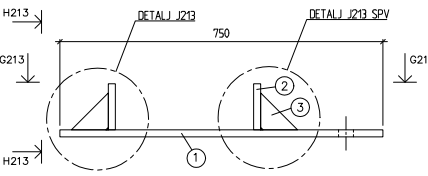

DETALJ F213 15
MOTHÅLL FÖR BETONGPLANK

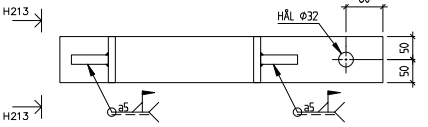

DETALJ G213 15

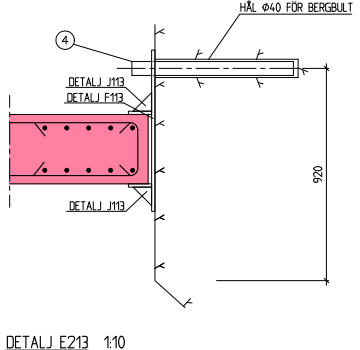

DETALJ E213 1:10

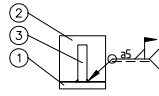

SEKTION H213 15

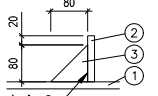

DETALJ J213 15

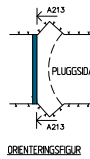

FÖRESKRIFTER

REGLER
BOVERKETS BYGGREGLER BFS 1993:57 MED ÄNDRINGAR BFS 1995:17, BBR 94, BOVERKETS KONSTRUKTIONSGREGLER BFS 1993:58 MED ÄNDRINGAR BFS 1995:18, BKR 94.

LASTER
BETONGPLANKEN DIMENSIONERAS FÖR EN HORIZONTALT BELASTNING FRÅN PÅGÅENING AV BENFOTEN SAMT FÖR ATT LIFTAS IN PÅ PLATS MED EN LYFTPLANK.
UTBREDD BUNDEN LAST q_B = 100 kN/m²

KLASSER
SKERHETSKLASS SK 3
LIVSLÄNGDKLASS L1 (30 år)
MÅLKLASSER B4/A3

BETONG
BTC I, STD K40, VCT <0,45, LUFT 6,0%
STENSTÖRLEK 16 mm

ARMERING
K500ST
BÖCKNINGSRADIER VID BÖCKNINGSVINKEL 90°

STÅNG-DIAM.	K500ST	BYGL.
Ø10	100 mm	24 mm
Ø12	125 mm	32 mm
Ø16	160 mm	64 mm

SKARVNING UTFÖRES ENLIGT BKR 94 KAP. 3.9.3
SKARVLÅNGDER Ø10 500 mm
Ø12 600 mm
Ø16 800 mm
Ø25 1250 mm

TÄCKANDE BETONGSKIKT
40 mm

TOLERANSER
ENLIGT HUS-AMA 83 AVSNITT 3 SAMT BKR 94 2.6 OCH 8.9.

FORM
BETONGPLANKEN GJUTS LIGGANDE PÅ EN PLAN AV SLÅTT FORM. KANTFORMEN UTFÖRS MED SLÅTT FORM MED RADIE 2485 = 15 mm KORTARE ÄN TUNNPLÅNSRADIEN. MÅTTET KONTROLLERAS PÅ PLATS. UTÅTGÅENDE SYNLIGA HÖRN AVFASAS MED 19 x 19 mm TREKANTSLIST. HORIZONTALA VIKOR FINGÅTTAS I SAMBAND MED GÅTTRINGEN FÖRST GJUTS BE1, BE3, BE5, BE7 OCH BE9 MED MELLANLIGGANDE FORM PÅ PLATS FÖR MELLANLIGGANDE ELEMENT, BE2, BE4, BE6 OCH BE8 GJUTS DÄREFTER MELLAN DE FÄRDIGA ELEMENTEN MED 3 mm MELLANLÅGG.

KONTROLL
GRUNDKONTROLL ENLIGT BKR 94 7.6 OCH BKR 94 9.6.3 UTFÖRES.

MÄTTSÄTTNING
MÄTTSÄTTNING FÖR PREFABRICERADE BETONGELEMANT KONTROLLERAS PÅ PLATS. FÖR ELEMENT INNAN TILLVERKNING AV FORM STARTAR.

HÄNVISNINGAR

SAMMANSTÄLLNING	SE RITN. Pro.type-201.
SLOTS I BERG	SE RITN. Pro.type-211.
VÄKANT	Pro.type-212.
PLUGG, MÅTT/ARMERING	SE RITN. Pro.type-214
INJEKTERINGSSYSTEM	SE RITN. Pro.type-215
KYLSYSTEM	SE RITN. Pro.type-216
FORM	SE RITN. Pro.type-221
FORM TYP 2 OCH 3	SE RITN. Pro.type-222
FORM TYP 4, 5 OCH 6	SE RITN. Pro.type-223
FÖRANKRING PÅ GENOMFÖRNING	SE RITN. Pro.type-231

POS	ANT	BENÄMNING	MATERIAL	ANM
1	35	PL 100x15 L= 750	SS 1411	
2	70	PL 100x100x15	SS 1411	
3	70	PL 80x80x20	SS 1411	
4	70	Ø30 L= 400	SS 1411	
5	9	MEMO HYLSA 1969, M16	-	
6	9	MEMO LYFTÖGLA 2100, M16	-	
-	-	-	-	
-	-	-	-	

A	BYGGHANDLING	02-05-08	
BET	ANT	DATUM	BLAD
BYGGHANDLING			
ÄSPÖ HARD ROCK LABORATORY			
NCC TEKNIK		Tfn 040-31 70 00	
205 47 MALMÖ		Fax 040-21 67 02	
(Thorsens väg 40)			
UPPGÅR NR	RTAD/KONSTR AV	PROJECT PROTOTYPE REPOSITORY	
021020	LNY / CT	CONCRETE PLUG 2	
WALMO	HÄNELGGÄRE	PREFABELEMANT	
02-02-22	LARS-ERIK NYDAHL	MÅTT OCH ARMERING	
ANSVARS	SKALA	NUMMER	1 BET
-	150, 110, 15	Pro.type-213 A	

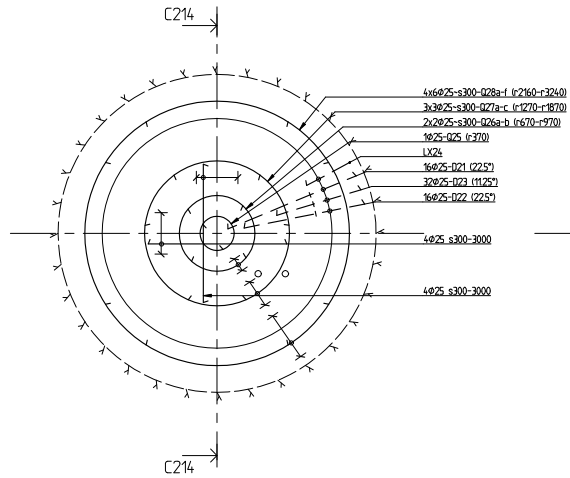

ELEVATION A214 150

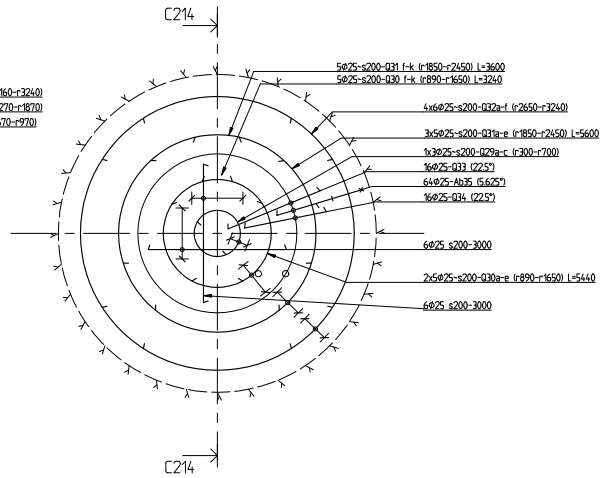

ELEVATION B214 150

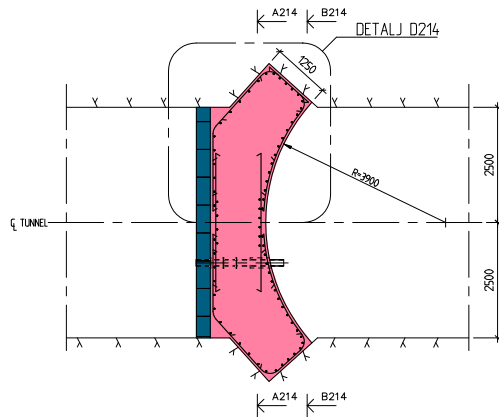

SEKTION C214 150

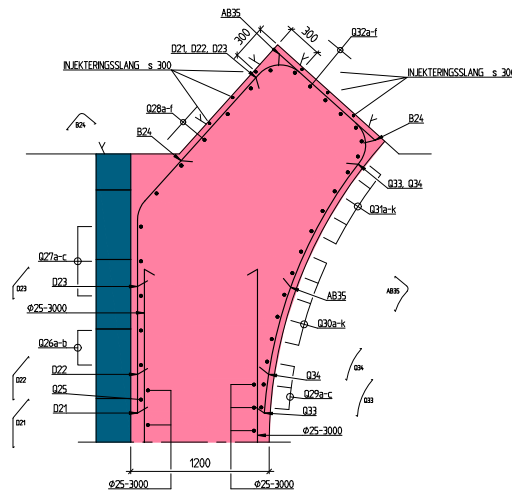

DETALJ D214 1:20

FÖRESKRIFTER

REGLER

BOVERKETTS BYGGREGLER BFS 1993:57 MED ÄNDRINGAR BFS 1995:17, BBR 94
BOVERKETTS KONSTRUKTIONSGREGLER BFS 1993:58 MED ÄNDRINGAR
BFS 1995:18, BKR 94.

LASTER

BETONGPLUGGEN ÄR DIMENSIONERAD FÖR EN JÄMNT FÖRDELAD
LAST $q = 3200 \text{ kN/m}^2$

KLASSER

SÄKERHETSKLASS SK 3
LIVSLÄNGDSKLASS L1 (50 år)
MILJÖKLASSER B4/A3

BETONG

BTO I K50 VT

ARMERING

K500ST

TÄCKANDE BETONGSKIKT 40 mm

BOCKNINGSRADIER
VID BOCKNINGSVINKEL 90°

STÅNG-	Ks500ST	BYGL
DIAM.		
#16	160 mm	64 mm
#25	250 mm	

SKARVNING UTFÖRES ENL. BKK 94 KAP. 3.9.3

SKARVNINGDER	#16	800 mm
	#25	1250 mm

TOLERANSER

ENLIGT HUS-AMA 83 AVSNITT 3 SAMT BKK 94 2.6 OCH 8.9.

INJEKTERING

INJEKTERINGSSYSTEM SE RITNING Pro.type-215

FORM

SYNLIGA YTOR FORMSÄTTES MED SLÅT FORM.

KONTROLL

GRUNDKONTROLL ENL. BKR 94 7:6 OCH BKK 94 9.6.3 UTFÖRES.

BERÄKNINGAR

STATISKA BERÄKNINGAR: Dok nr 1915029/SRA-01

HÄNVISNINGAR

SAMMANSTÄLLNING	SE RITN. Pro.type-201.
SLUTS I BERG	SE RITN. Pro.type-211.
PREFABELEMT	SE RITN. Pro.type-213
INJEKTERINGSSYSTEM	SE RITN. Pro.type-215
KYLSYSTEM	SE RITN. Pro.type-216
FORM	SE RITN. Pro.type-221
FORM TYP 2 OCH 3	SE RITN. Pro.type-222
FORM TYP 4, 5 OCH 6	SE RITN. Pro.type-223
FÖRANKRING PÅ GENOMFÖRNING	SE RITN. Pro.type-231

A	BYGGHANDLING	02-05-08
BET	ANT	SN
BYGGHANDLING		
ÄSPÖ HARD ROCK LABORATORY		
NCC		
NCC TEKNIK 205 47 MALMÖ (Thomsons väg 40)		
Tfn 040-31 70 00 Fax 040-21 67 02		
UPPGRAV NR	RITAD/KONTR AV	PROJECT PROTOTYPE REPOSITORY
0212020	LNY / CT	CONCRETE PLUG 2
MALMÖ	HANDLAGGARE	PLUGG
02-04-18	LARS-ERIK NYDAHL	MÄTT OCH ARMERING
ANSVARS	SKALA	NUMMER
	150, 120	Pro.type-214 A

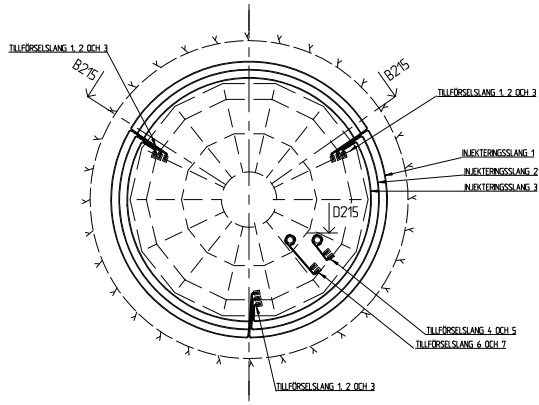

ELEVATION A215 1:50

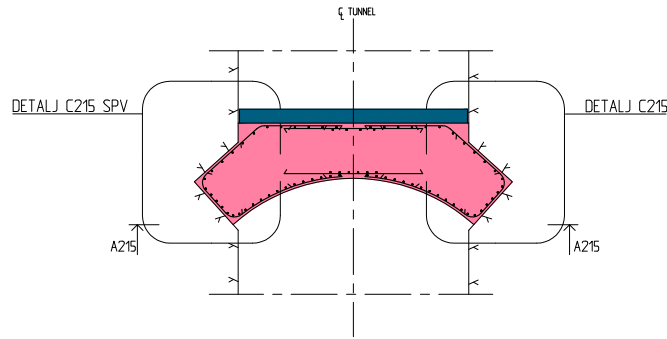

SEKTION B215 1:50

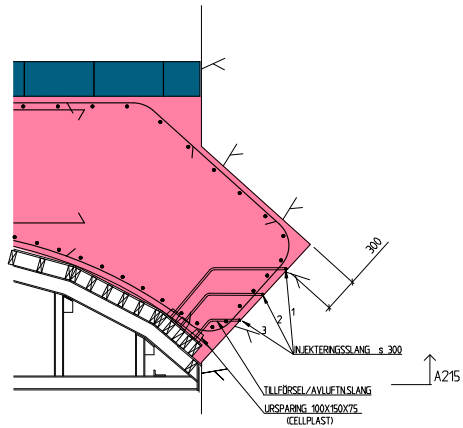

DETALJ C215 1:20

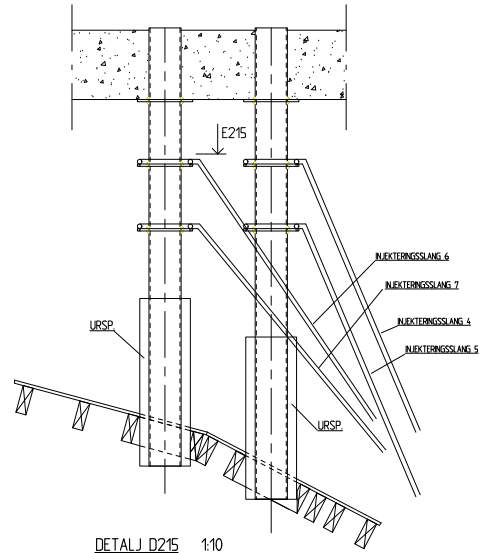

DETALJ D215 1:10

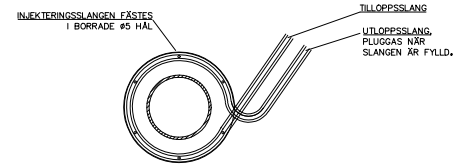

DETALJ E215 1:5

ARBETSBEKRIVNING

INJEKTERINGSSYSTEM FUKO ELLER LIKVÅRDIGT

SLANG FOR INJEKTERING MONTERES ENLIGT TILLVERKARENS ANVISNINGAR. INNAN INJEKTERINGSSLANG MONTERAS SKALL RYGGAR EFTER SÄMNINGSDRNING BILAS BORT SA EN SLATT YTA ERHÅLLES.

- SLANG 1 = 3 st 6,7,0 m.
- SLANG 2 = 3 st 6,6,7 m.
- SLANG 3 = 3 st 6,6,4 m.
- SLANG 4 RESP. 5 L = 5 m.
- SLANG 6 RESP. 7 L = 5 m.

INJEKTERING

INJEKTERINGEN UTFÖRS ENLIGT SPRÖCKLTPROGRAM UPPRITTAT AV ENTREPRISET. ENLIGT SPRÖCKLTPROGRAMET VÄRDERAS ENLIGT SPRÖCKLTPROGRAMET.

TILL INJEKTERINGSDRNING BEHÖVS STRÖM MED DEN TILFØRSELSSLANG NR 3. EFTER INJEKTERING AV SLANG NR 1 INJEKTERAS SLANG NR 3. DREFTER DÅRS ETT UPPEHÅLL I ~18H FÖR ATT SPRÖCKSTÄLLA HÖRNING I INJEKTERINGSBRUKET.

MITTLSLANG NR 2 INJEKTERAS MED ULTRAFIN 16 VCT 0,-10 MED TRYCKET MAX 1,5 MPa OCH RENPOLAS INTE.

KONTROLL

GRUNDKONTROLL ENL. BKR 94 7:6 OCH BKK 94 9:6.3 UTFÖRES.

HÄNVISNINGAR

- | | |
|--------------------------|------------------------|
| SAMMANSTÄLLNING | SE RITN. Pro.type=201. |
| SLITS I BERG | SE RITN. Pro.type=211. |
| VAKANT | Pro.type=212. |
| PREFABELEMNT | SE RITN. Pro.type=213. |
| PLUGG, MATT/ARMERING | SE RITN. Pro.type=214. |
| KYLSYSTEM | SE RITN. Pro.type=216. |
| FORM | SE RITN. Pro.type=221. |
| FORM TYP 2 OCH 3 | SE RITN. Pro.type=222. |
| FORM TYP 4, 5 OCH 6 | SE RITN. Pro.type=223. |
| FÖRANKRING PÅ GENOMDRING | SE RITN. Pro.type=231. |

C	ARBETSBEKRIVNINGEN KOMPLETTERAD	03-03-26	
B	INJEKTERINGSSYSTEM MODIFIERAT	03-02-18	LIN-FES
A	BYGGHANDLING	02-05-08	LIN-ÅHN
BET	ART	DORRKEN AVSER	DATUM
BYGGHANDLING			
ÄSPÖ HARD ROCK LABORATORY			
NCC		NCC TEKNIK	
		205 47 MALMÖ (Thomsons väg 40)	
		Tfn 040-31 70 00 Fax 040-21 67 02	
UPPDRAG NR	BETÄNDRING AV	PROJECT PROTOTYPE REPOSITORY	
0212020	LIN / CT	CONCRETE PLUG 2	
MÅLNO	HANDLEGGARE		
02-04-18	LARS-ERIK NYDAHL	INJEKTERINGSSYSTEM	
ANSVARIG	SKALA	NUMMER	BET
Anders Hagman	150,120,110,15	Pro.type=215 C	

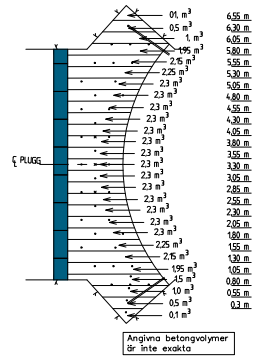
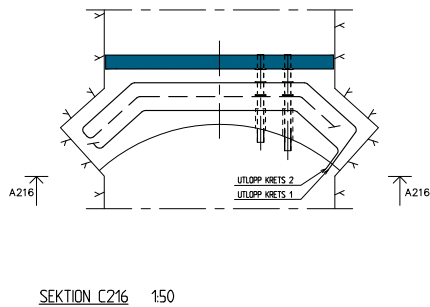
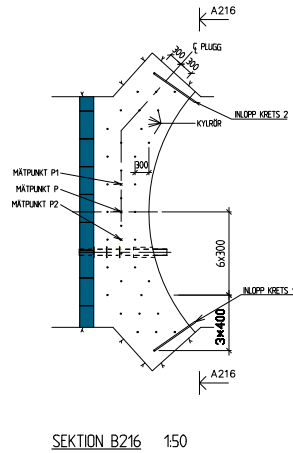
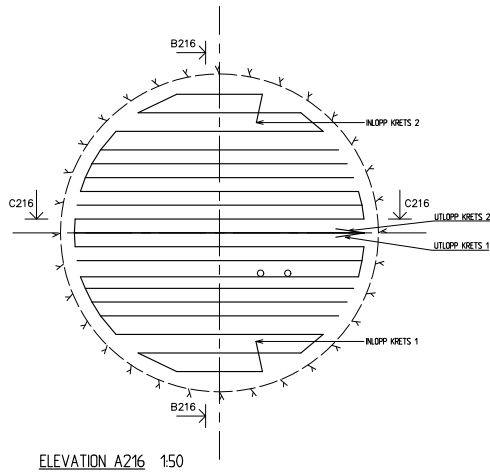

Angivna betongvolym
är inte exakta

FÖRESKRIFTER

ARBETSBEKRIVNING

ENLIGT DOK NR: 1915029/AB-01

SERICKANALYS

ENLIGT DOK NR:1915029/SRA-01

UPPGIFTER FÖR DIMENSIONERING AV KYLANLÄGGNING

ERFORDERLIG KYLEFFEKT: 30 Kw
 KYLIRR AV STÅL: # 25
 KYLSLINGA: Totalt 194m (2*97m)
 FLÖDE: Totalt 1,5 l/s (2*0,75 l/s)
 KYLVATTENTEMPERATUR: MAX 5,6°C

HÄNVISNINGAR

SAMMANSTÄLLNING SE RITN. Pro.type-201.
 SLITS I BERG SE RITN. Pro.type-211.
 VÄRANT SE RITN. Pro.type-212.
 PREFABELEMT SE RITN. Pro.type-213.
 PLUGG, MÄTT/ARMERING SE RITN. Pro.type-214.
 INJEKTERINGSSYSTEM SE RITN. Pro.type-215.
 FORM SE RITN. Pro.type-221.
 FORM TYP 2 OCH 3 SE RITN. Pro.type-222.
 FORM TYP 4, 5 OCH 6 SE RITN. Pro.type-223.
 FÖRANKRING PÅ GENOMFÖRING SE RITN. Pro.type-231.

A	BYGGHANDLING	02-05-08	
BET	ART	ANDRINGEN AVSE	DATE
BYGGHANDLING			
ÄSPÖ HARD ROCK LABORATORY			
NCC		NCC TEKNIK 205 47 MALMÖ (Telefon: 040-31 70 00) Fax: 040-21 67 02	
UPPDRAG NR	BYGGHANDLING AV	PROJECT PROTOTYPE REPOSITORY	
0212020	Utv / M.L.A	CONCRETE PLUG 2	
MALMÖ	HANDELSNAMN		
02-04-18	LARS-ERIK NYDAHL	KYLSYSTEM	
ANSVARIG	SKALA	NUMMER	T BET
	150	Pro.type-216 A	

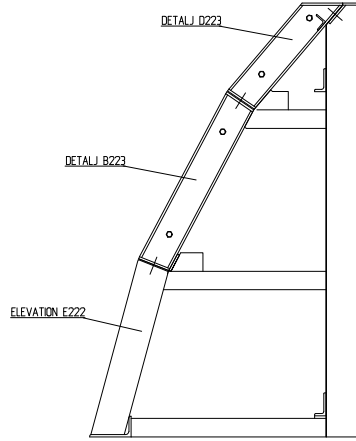

ELEVATION A223 1:10

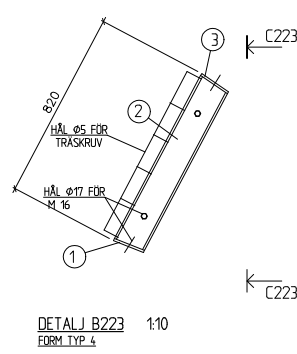

DETALJ B223 1:10
FORM TYP 4

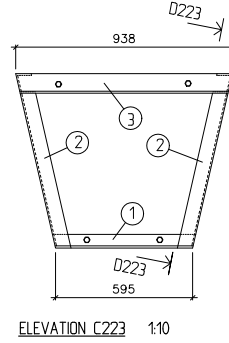

ELEVATION C223 1:10

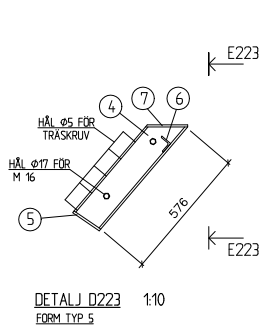

DETALJ D223 1:10
FORM TYP 5

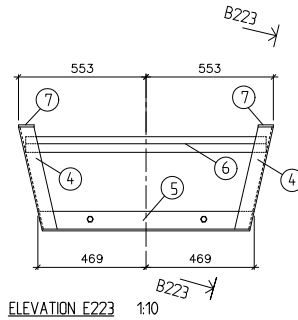

ELEVATION E223 1:10

FORM TYP	POS	ANT*	BENÄMNING	MATERIAL	ANM
FORM TYP 4	1	5	PL 10x70-587	S 275 JR	--
	2	10	UPE 140, L=801	--	--
	3	5	PL 10x140-587	--	--
FORM TYP 5	4	8	UPE 140, L=576	--	--
	5	4	PL 10x140-938	--	--
FORM TYP 6	6	4	L 50x50x6, l=1085	--	--
	7	8	PL 10x60 L=184	--	--
	8	2	UPE 140, L=576	--	--
	--	--	--	--	--

*OBS! ANTAL = TOTALT PER POS. I RESP. FORMTYP.

TABELL ÖVER ANTAL SKRUVHÅL FÖR TRÄREGLAR OCH DERAS INBÖRDES AVSTÅND

POS	ANTAL	FRÅN ÄNDE	S/S AVSTÅND
2	6	25	155
4	5	25	247
8	5	25	247
--	--	--	--

FÖRESKRIFTER

ENIGT RITNING Pro.type-221

SVEITSNING

ALL SAMMANSVEITSNING UTFÖRS MED KÄLSVETS MED α -MÅTT 4.

HÄNVISNINGAR

- SAMMANSTÄLLNING SE RITN. Pro.type-201
- SUTS I BERG SE RITN. Pro.type-211
- VÄRKANT SE RITN. Pro.type-212
- PREFABELEMANT SE RITN. Pro.type-213
- PLUGG, MÅTT/ARMERING SE RITN. Pro.type-214
- INJEKTIONSSYSTEM SE RITN. Pro.type-215
- KYLSYSTEM SE RITN. Pro.type-216
- FORM SE RITN. Pro.type-221
- FORM TYP 2 OCH 3 SE RITN. Pro.type-222
- FÖRANKRING PÅ GENOMFÖRING SE RITN. Pro.type-231

B	OMSKALNING MÄTTSTÄTTNING	02-10-24	
A	BYGGHANDLING	02-05-08	UNY-ASIN
RET	ANT	ÄNDRINGEN AVSER	DATUM
BYGGHANDLING			
ÄSPÖ HARD ROCK LABORATORY			
NCC		NCC TEKNIK 205 47 MALMÖ (Thorsens väg 40)	
LUPPORD NR 0212020		PROJECT PROTOTYPE REPOSITORY	
MÄLMÖ HANDLÄGGARE 02-04-18		CONCRETE PLUG 2	
ANSVARIG LARS-ERIK NYDAHL		FORM TYP 4, 5 OCH 6	
		SKALA 1:10	NUMMER Pro.type-223 B

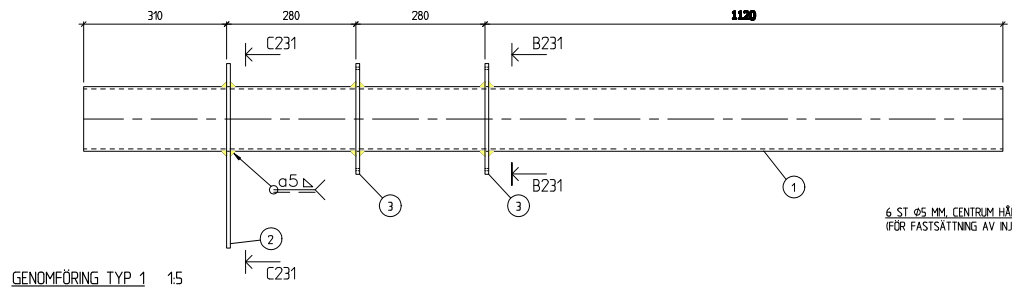

6 ST. Ø5 MM. CENTRUM HÅL 10 MM FRÅN KANT.
(FÖR FASTSÄTTNING AV INJEKTERINGSSLANG)

- HÄNVISNINGAR**
- SAMMANSTÄLLNING SE RITN. Pro.type-201.
 - SLITS I BERG SE RITN. Pro.type-211.
 - VAKANT Pro.type-212.
 - PREFABELEMENT SE RITN. Pro.type-213.
 - PLUGG, MÅTT/ARMERING SE RITN. Pro.type-214.
 - INJEKTERINGSSYSTEM SE RITN. Pro.type-215.
 - KYLSYSTEM SE RITN. Pro.type-216.
 - FORM SE RITN. Pro.type-221.
 - FORM TYP 2 OCH 3 SE RITN. Pro.type-222.
 - FORM TYP 4, 5 OCH 6 SE RITN. Pro.type-223.

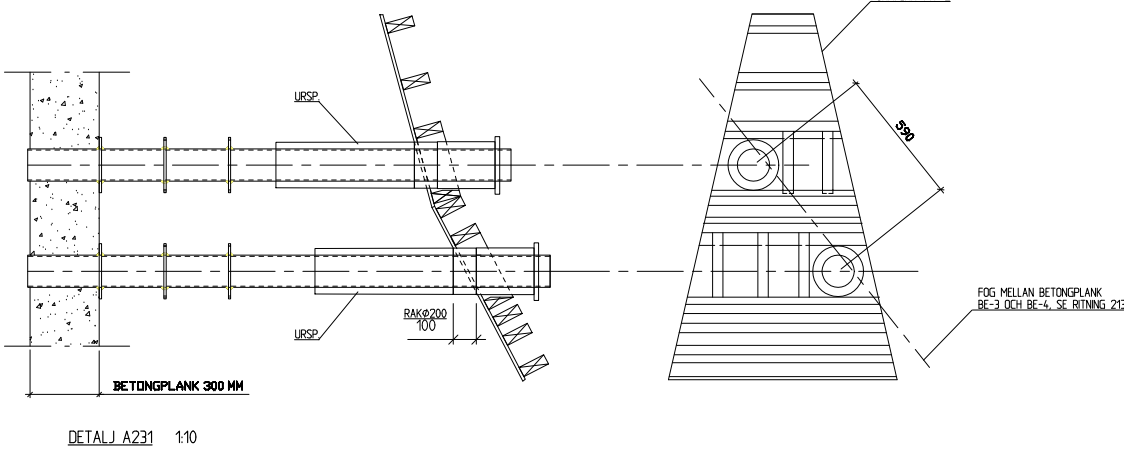
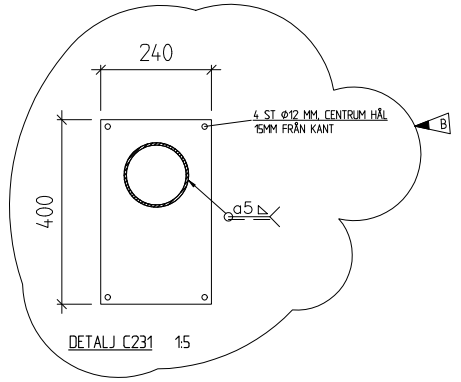
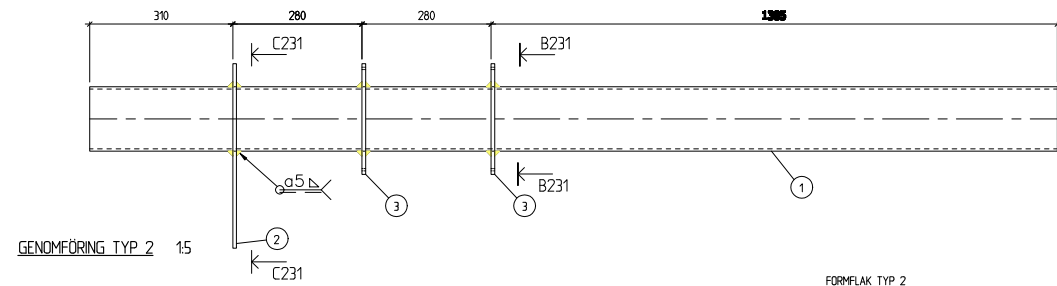

POS	ANT	BENÄMNING	MATERIAL	ANM
1	2	INGJUTNINGSRÖR, DIAM 139.7x5	SS2343	RITN. SKB AB L23014-002
2	2	PLÅT, t=8 MM	SS2343	BORRA HÅL Ø12 DETALJ C231
3	4	PLÅT, t=8 MM	SS2343	BORRA HÅL Ø5, DETALJ B231

B	FÖRANKRINGSPLÅTAR	03-04-01	
A	BYGGHANDLING	02-05-08	LNJ/AHN
BET	AVT	ÄNDERSEN AVTAV	DATUM
BYGGHANDLING			
ÄSPÖ HARD ROCK LABORATORY			
NCC		NCC TEKNIK 205 47 MALMÖ Tfn 040-31 70 00 (Thomsons väg 40) Fax 040-21 67 02	
UPPDRAG NR	RITAD/KONSTR AV	PROJEKT PROTOTYPE REPOSITORY	
0212020	LNJ / THS	CONCRETE PLUG 2	
MALMÖ	HANDELSGÄRE		
02-04-18	LARS-ERIK NYDAHL	FÖRANKRINGS PÅ GENOMFÖRING	
ANSVARIG	SKALA	NUMMER	TITEL
Anders Hagman	1:10, 15		Pro.type-231 B

Rebar strain gages 2003-2007:

Rebar Strain Meters (AJ1-AJ6)

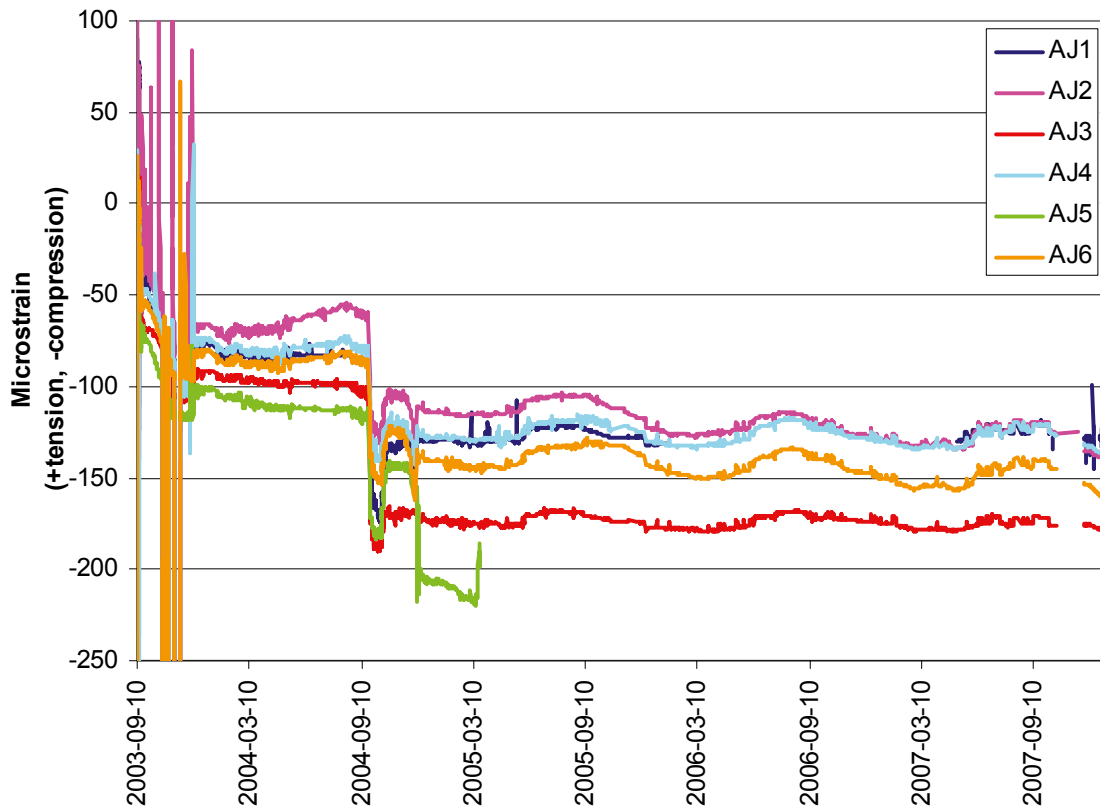

Rebar Strain Meters (AJ7-AJ12)

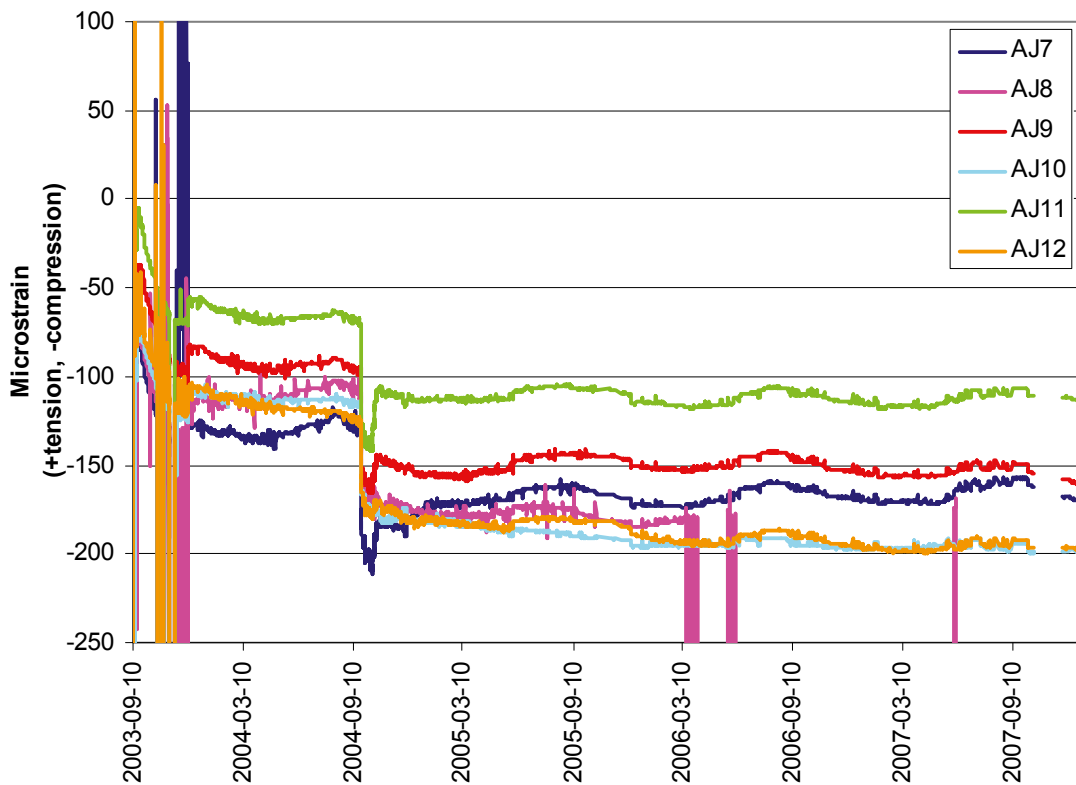

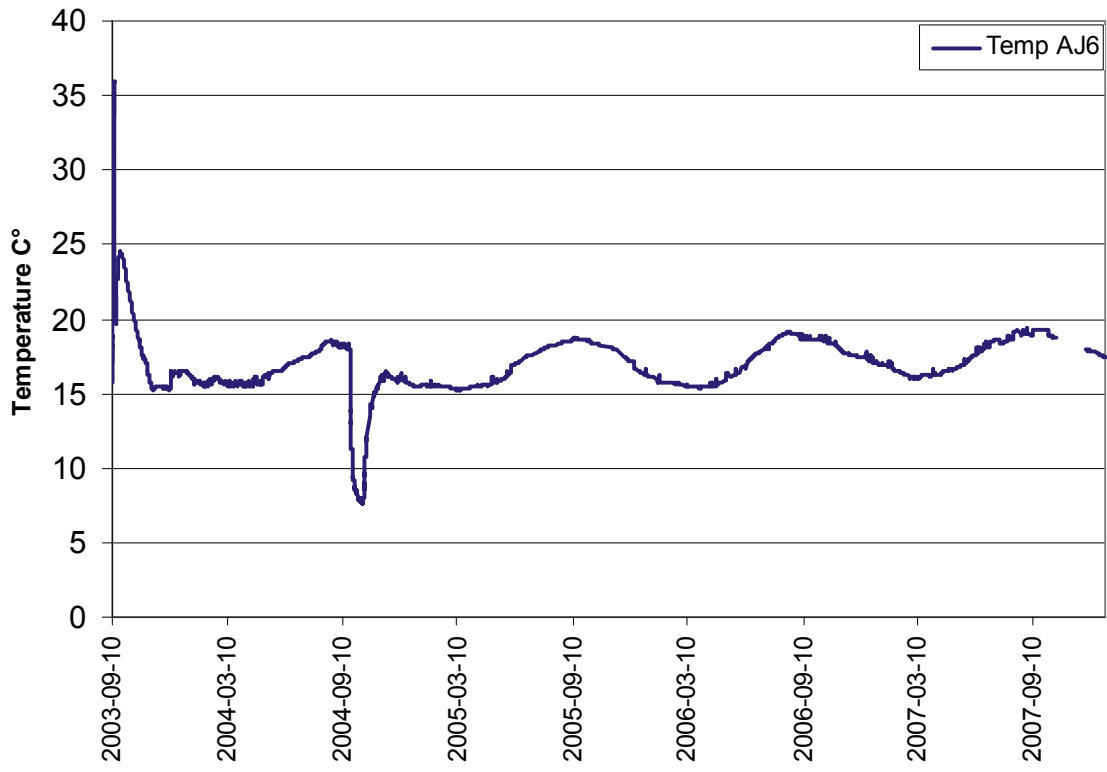

Rebar strain gages during casting:

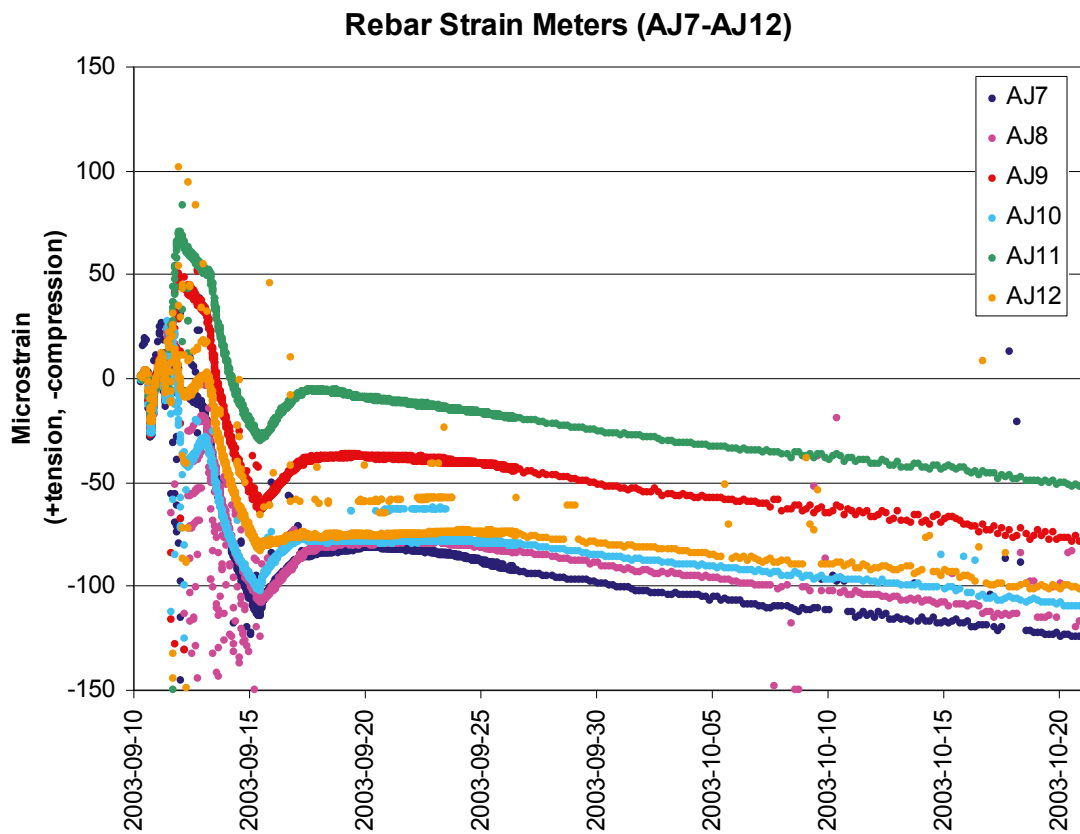
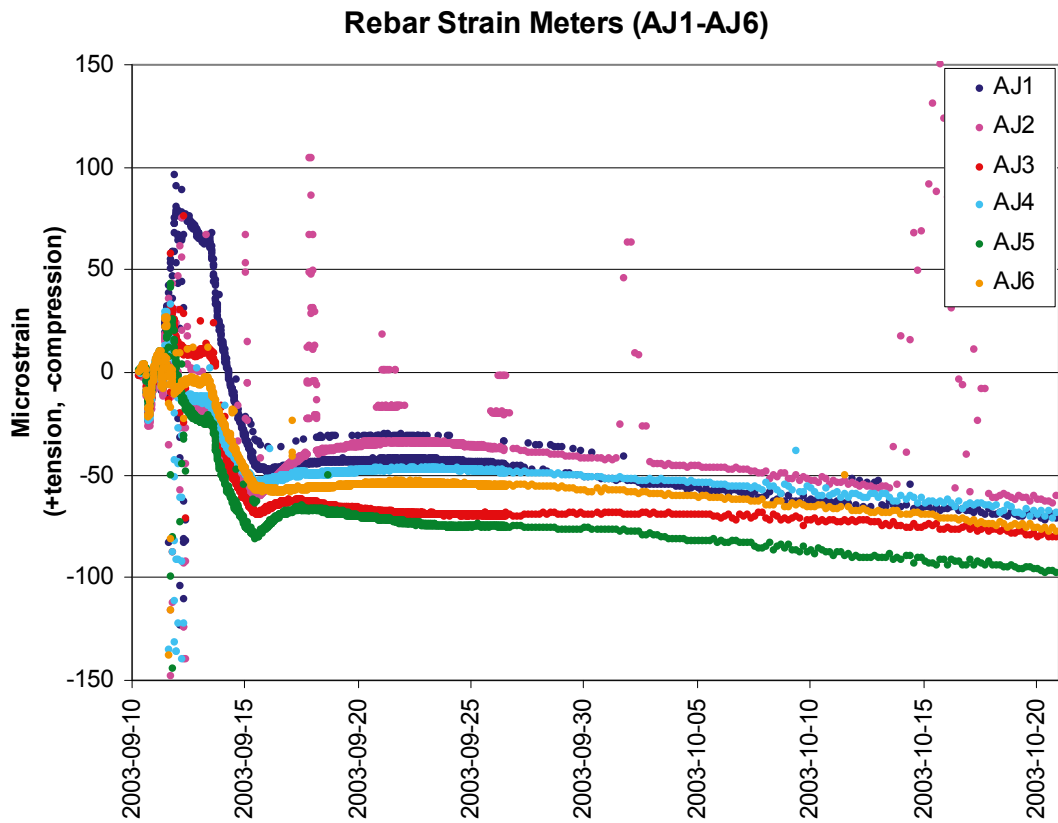

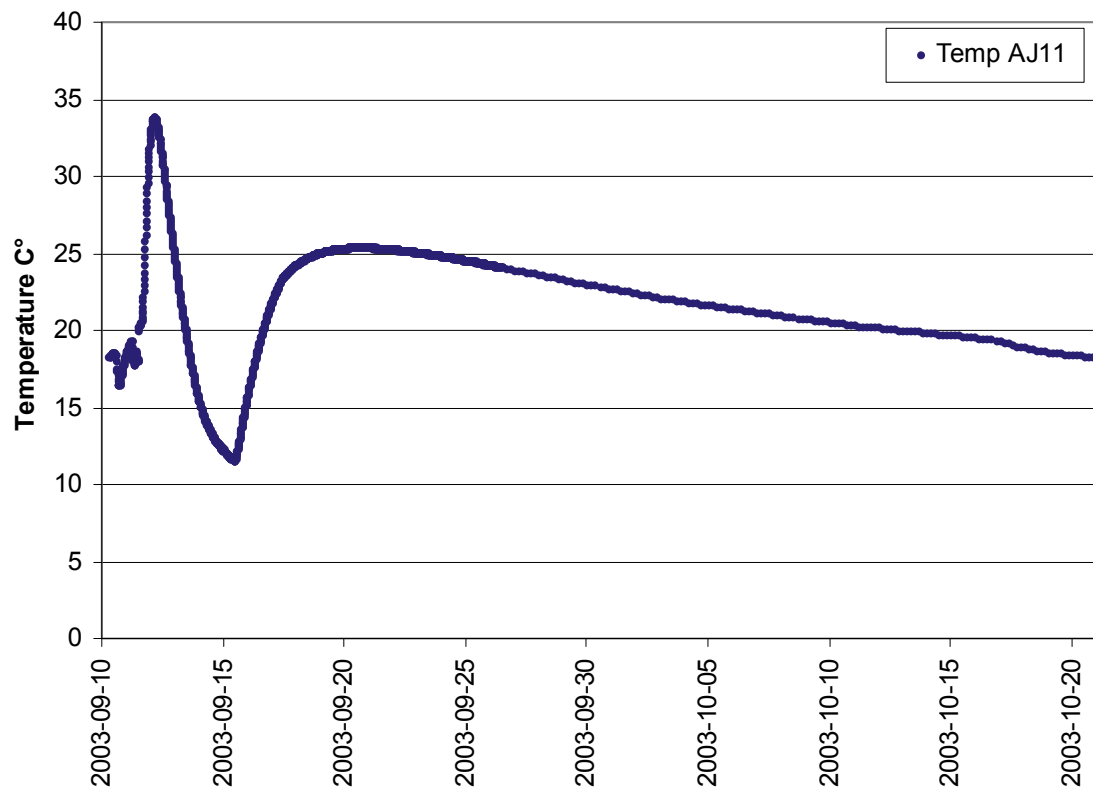

Rebar strain gages during cooling:

Rebar Strain Meters (AJ1-AJ6)

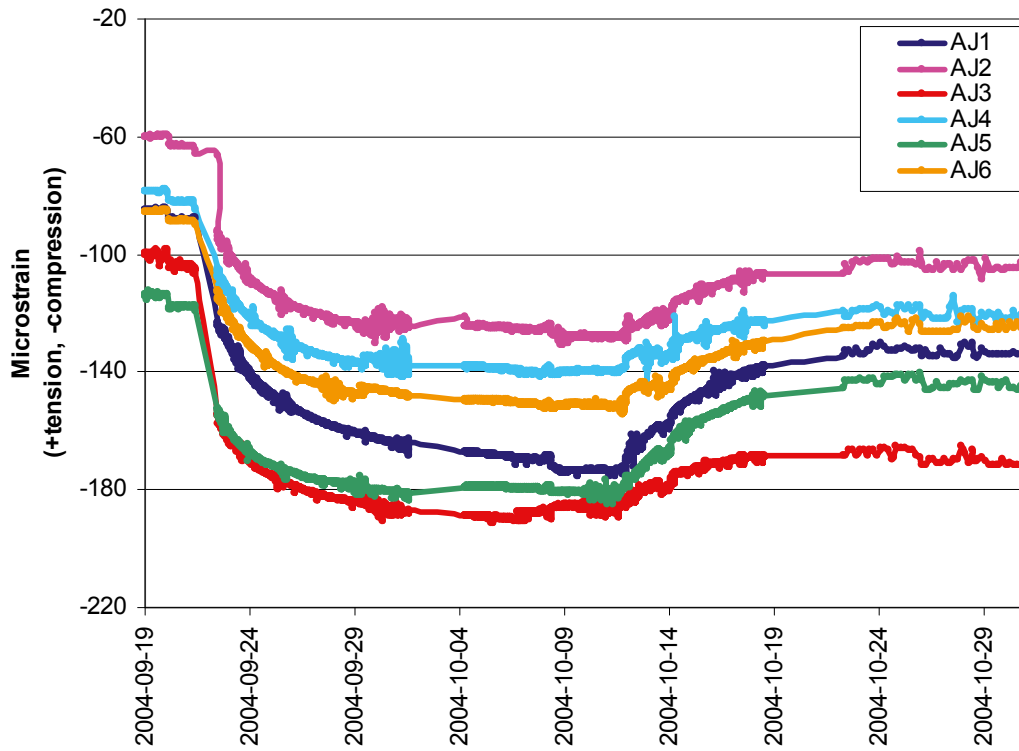

Rebar Strain Meters (AJ7-AJ12)

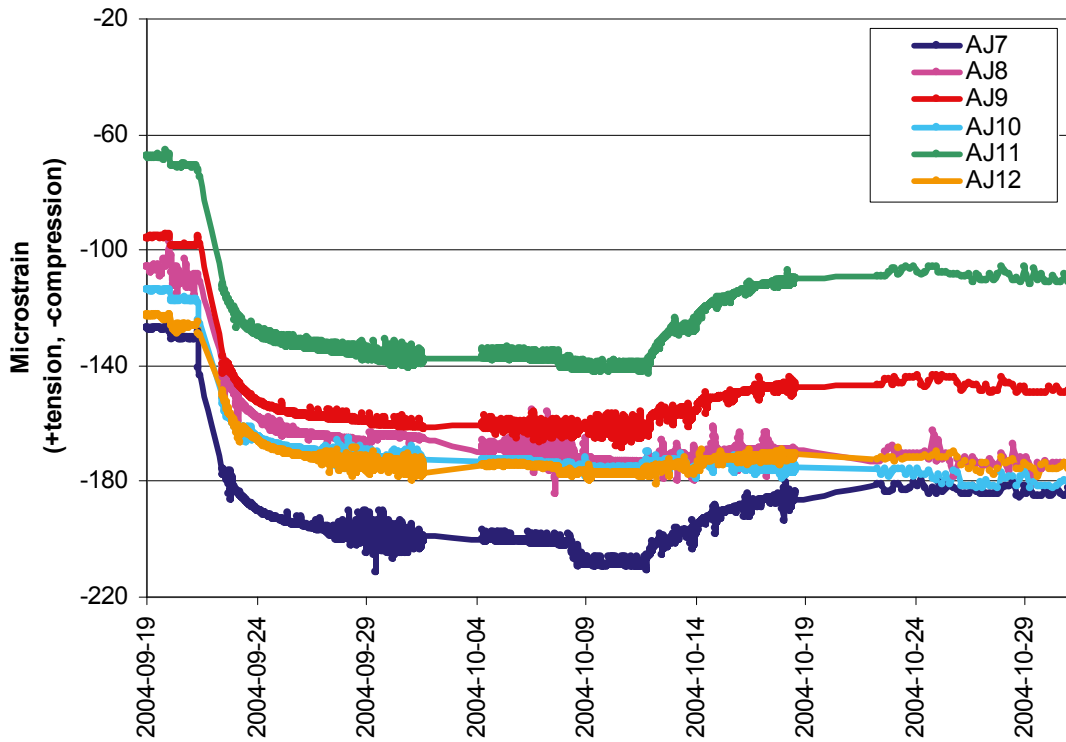

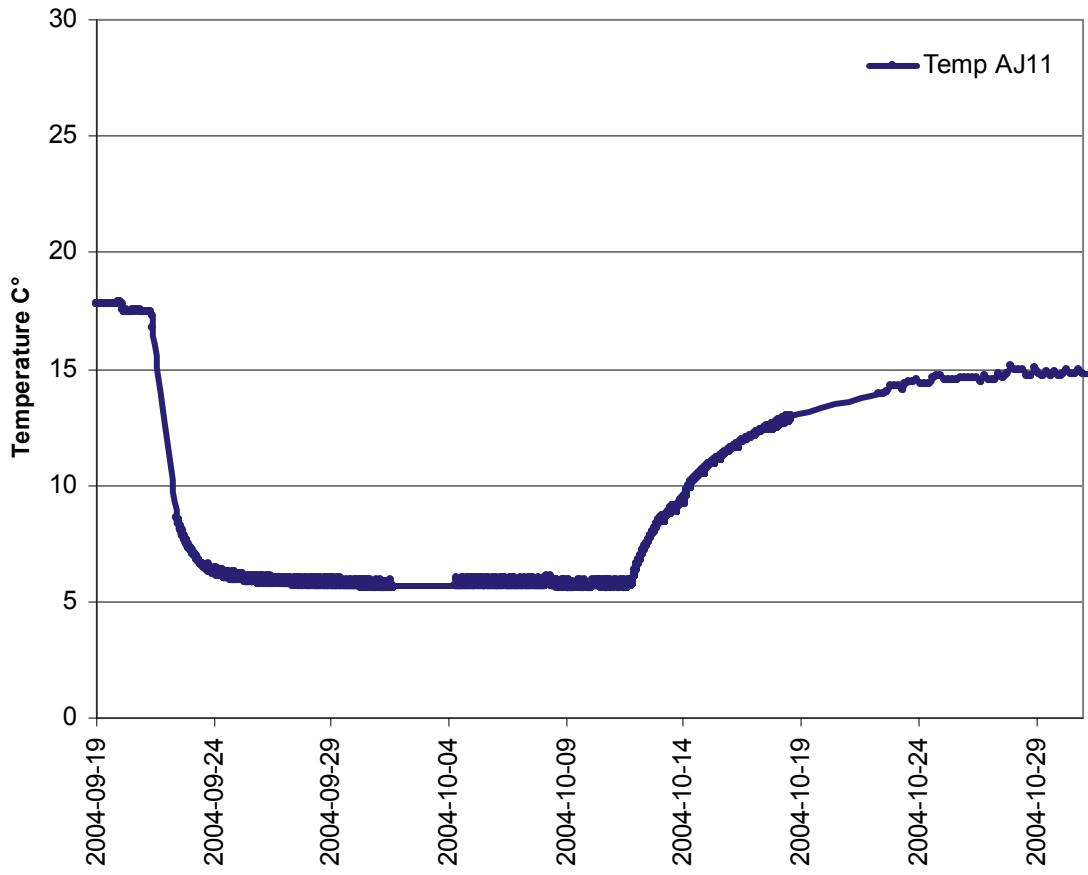

Joint meters 2003-2007:

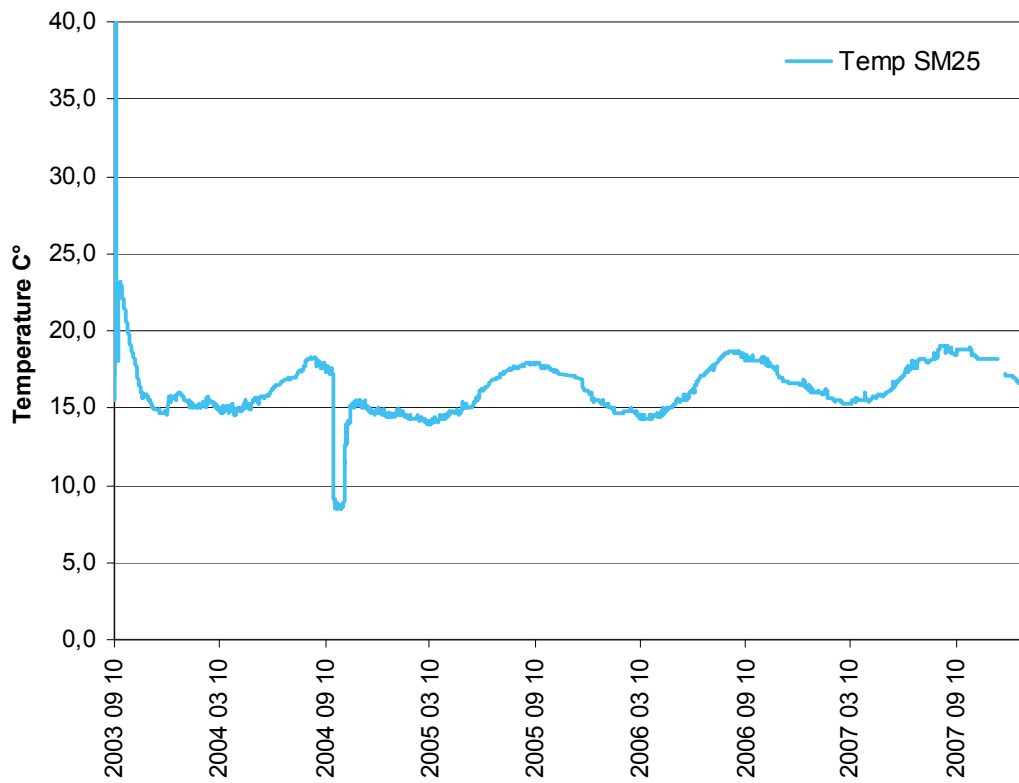
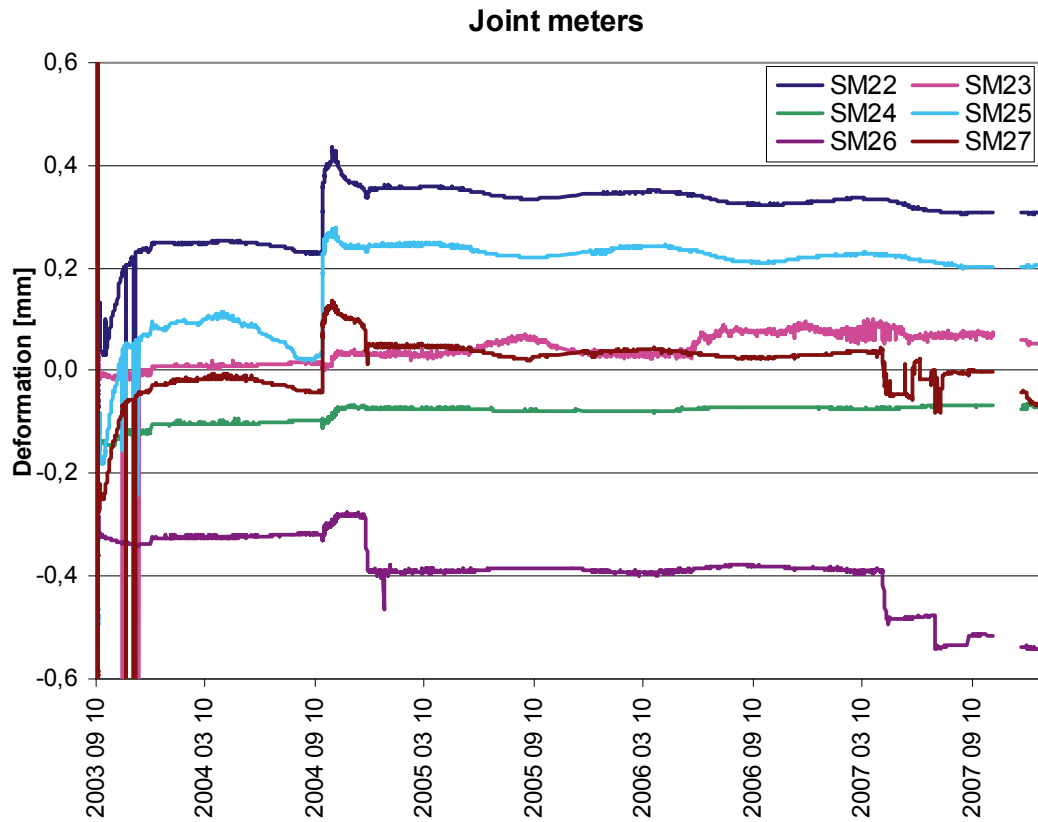

Joint meters during casting:

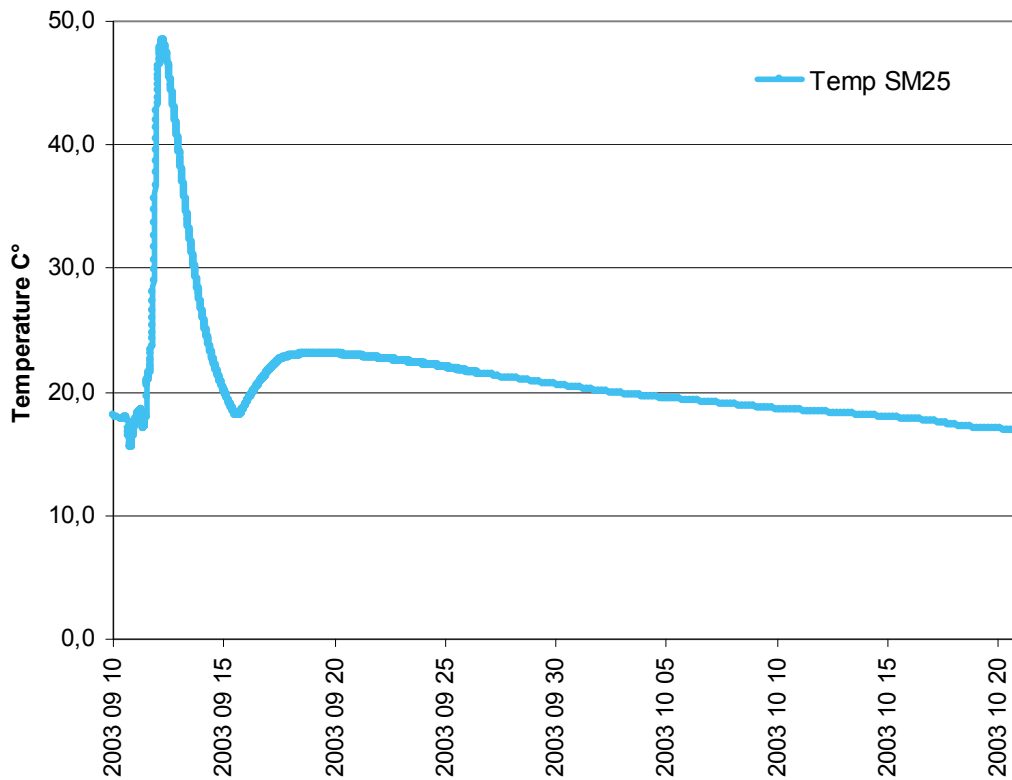
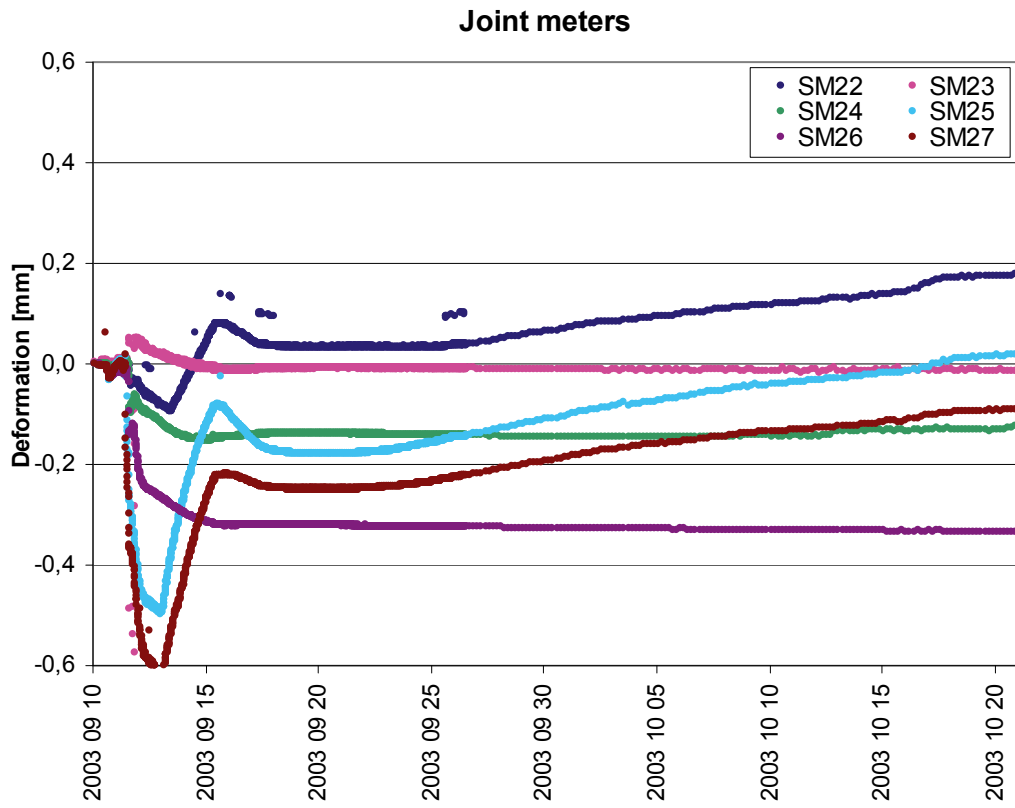

Joint meters during cooling:

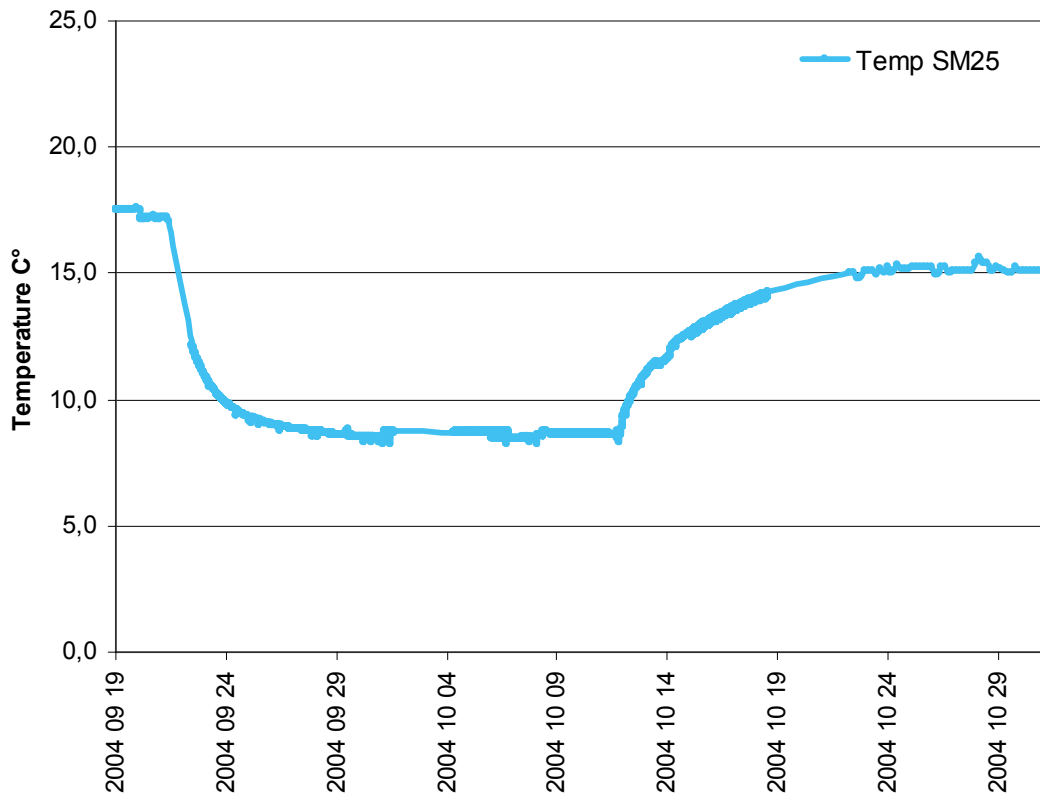
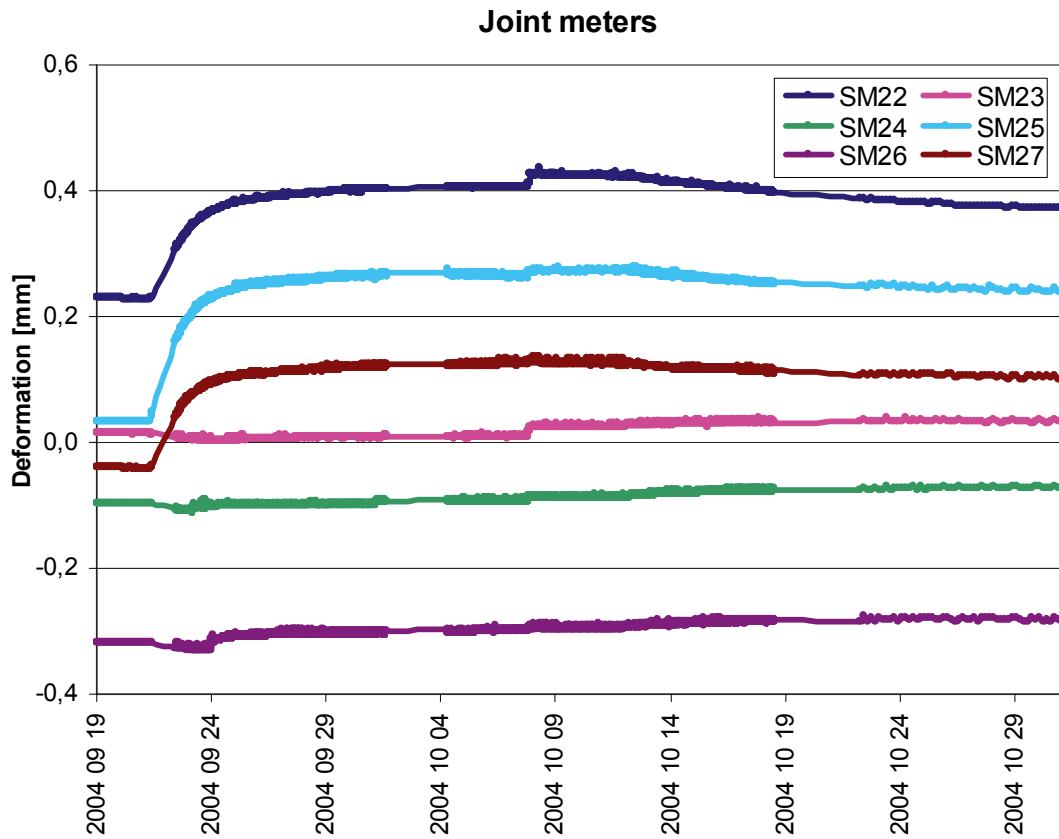

Embedded strain gages 2003-2007:

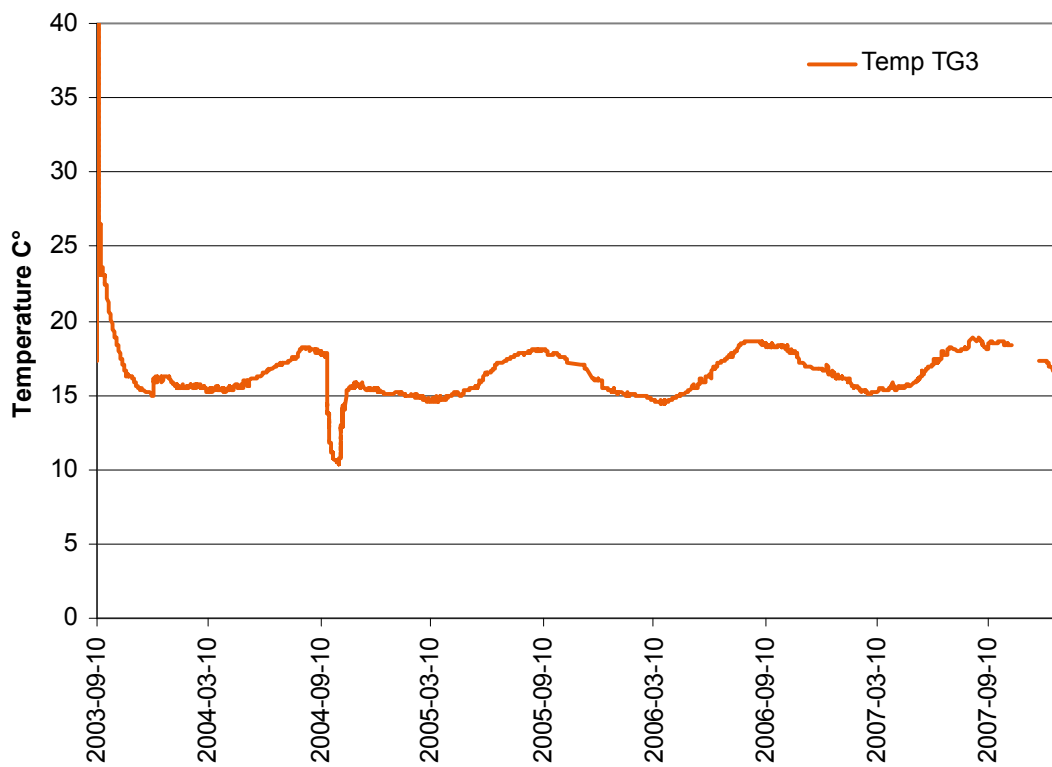
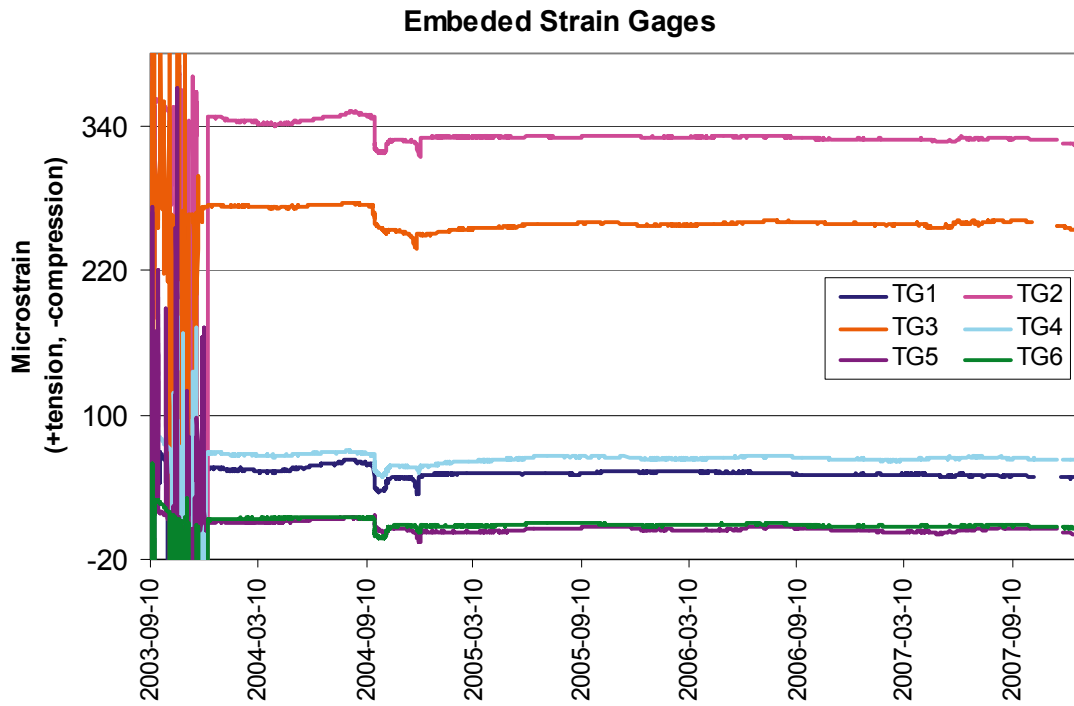

Embedded strain gages during casting:

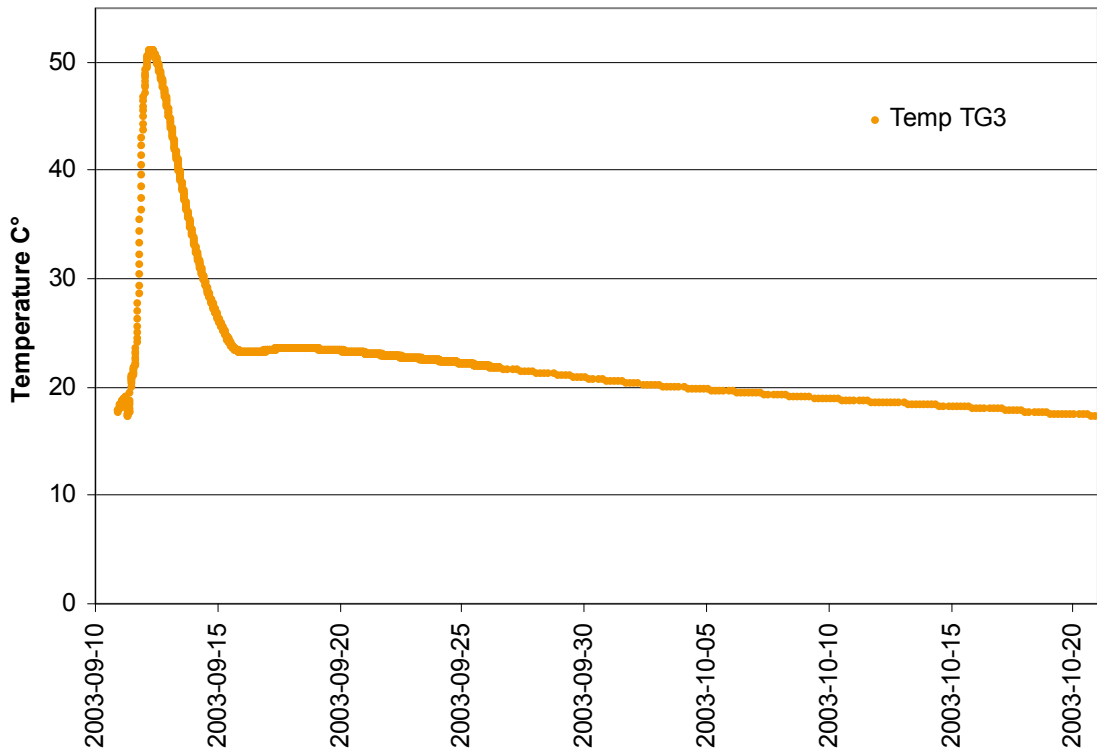
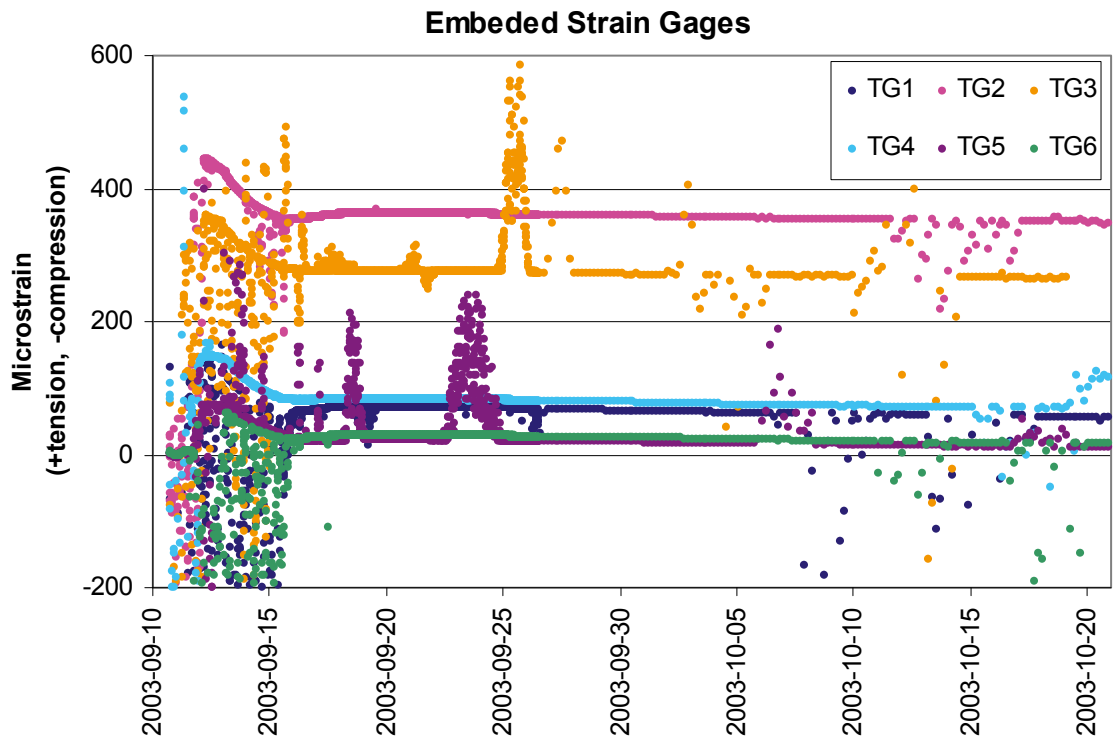

Embedded strain gages during cooling:

