

Deep repository for spent nuclear fuel

Facility description – Layout E

Spiral ramp with one operational area

Svensk Kärnbränslehantering AB

April 2002

Svensk Kärnbränslehantering AB

Swedish Nuclear Fuel
and Waste Management Co
Box 5864
SE-102 40 Stockholm Sweden
Tel 08-459 84 00
+46 8 459 84 00
Fax 08-661 57 19
+46 8 661 57 19



Deep repository for spent nuclear fuel

Facility description – Layout E

Spiral ramp with one operational area

Svensk Kärnbränslehantering AB

April 2002

**DEEP REPOSITORY - FACILITY DESCRIPTION
LAYOUT E
SPIRAL RAMP WITH ONE OPERATIONAL AREA**

This report documents a proposal for the design of the deep repository for spent nuclear fuel. The proposal is based on the principles that were formulated in the original KBS-3 study, but has been supplemented by investigations and experience to reflect current knowledge.

The purpose of the report is:

- to provide an integrated picture of the deep repository, as a basis for SKB's other work, e.g. environmental impact assessments, transport systems, safety issues and alternative locations,
- to provide a co-ordinated account of the conditions and requirements concerning all of the necessary functions in the deep repository in order to have a well functioning facility.

In addition, it should be possible to use the report as:

- a tool in the task of achieving a co-ordinated, safe and accepted design for the facility,
- a basis for further planning and costing,
- a basis for adaptation to geographic and other conditions for the particular location,
- a basis for information material, both within SKB and for interested parties outside, such as public authorities, municipalities and the general public.

The capacity of the deep repository has been chosen on the basis of 40 years of operation of the Swedish nuclear power reactors, which will produce approximately 9,000 tons of uranium, equivalent to approximately 4,500 canisters.

The design outlined is based on theoretical analyses of functions, safety requirements, procedures etc. that can be identified during the various phases of the construction and operation of the repository. In addition, preliminary organisation and staffing plans have been drawn up, for use as the basis for planning the necessary buildings.

The report gives a vision of the overall layout and function of the facility, and a proposal for the design of all individual parts of the repository. The relationships between the various parts of the repository are described, both above and below ground, as is the interplay between the part above ground and part below ground.

The proposal is based on a hypothetical inland location with a rail link. The report describes a layout with a spiral ramp as access to the deposition area and with a single operational area above ground.

The ramp will be used as a transport route for heavy and bulky transports. A shaft, that connects the operational area with the central area of the deposition area, is used for utility systems and for staff transports between the surface and the deposition area.

It has been assumed that the deposition areas and the central area are on the same level. The appendix, describing a two-level alternative, shows how the underground area could be arranged if the deposition area for regular operation were to be divided into two levels.

The facility description concentrates on the situation during regular operation. It also describes the gradual expansion programme, including land requirements and connections to existing infrastructure. The report concludes with some perspective sketches, which give a vision of how the repository might look when ready for operation.

This facility description is a translation of the Swedish SKB report R-02-18.

The facility description for the deep repository for spent nuclear fuel has been produced by the undersigned together with Ebbe Forsgren, SwedPower AB and Fritz Lange, Lange Art AB.

It is important to note that this report merely gives an example of one possible design for the deep repository. Many issues concerning system design, functional solutions, layout and design ought to be investigated further before deciding on the final design.

Stockholm, 15 April 2002



Stig Pettersson

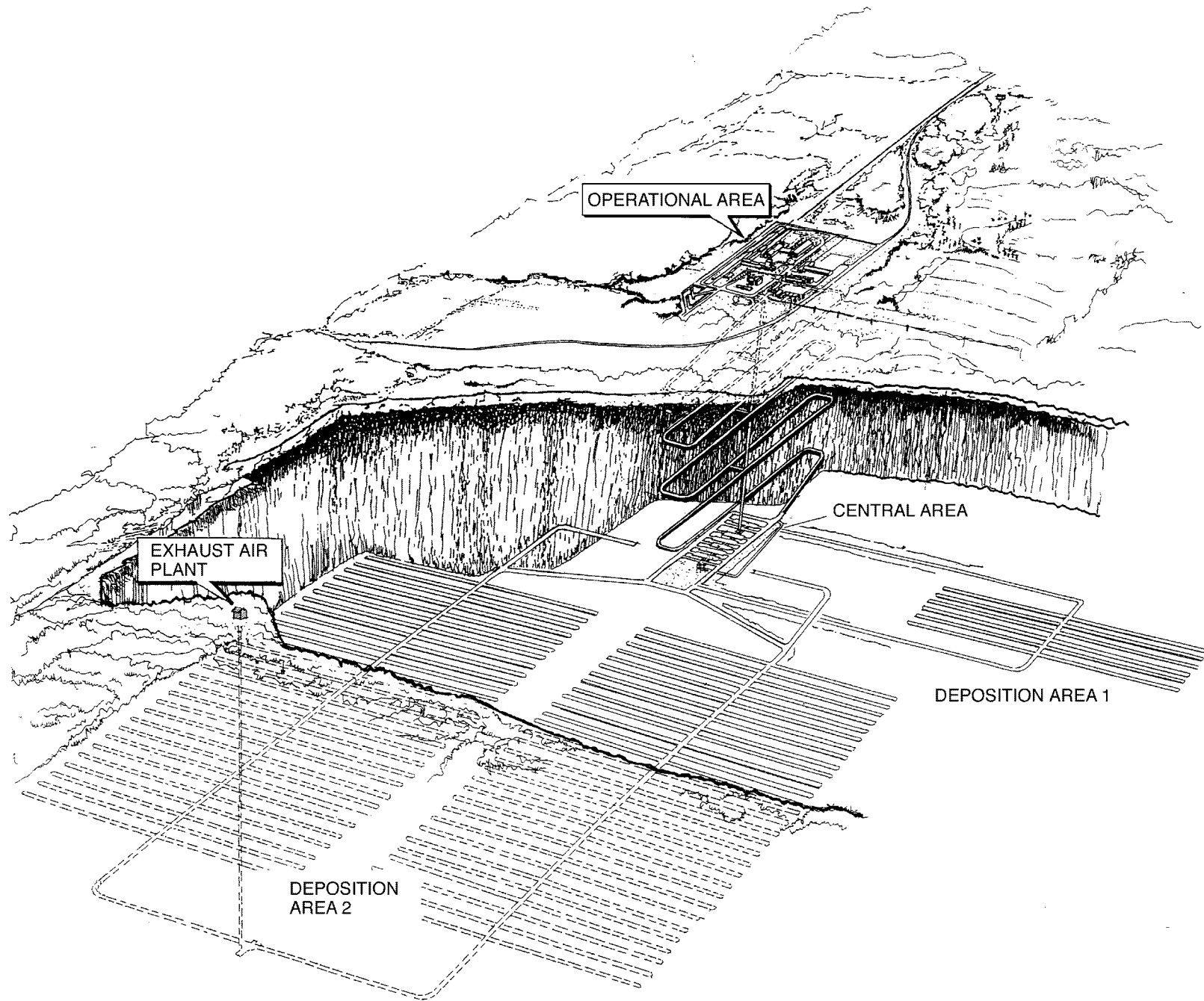

CONTENTS

1. GENERAL.....	6. OPERATIONS	11. OPERATIONAL AREA - COMMON
1.1 Background.....	6.1 General	11.1 Generic arrangement.....
1.2 Objective.....	6.2 Rock excavation and deposition work.....	11.2 Site arrangement for regular operation
1.3 Delimitations	6.3 Preparation of buffer and backfilling material.....	11.3 Operations
1.4 Implementation.....	6.4 Servicing and maintenance.....	11.4 Protection against trespassing.....
2. GENERAL REQUIREMENTS	6.5 Information.....	11.5 Transports to the operational area.....
2.1 General.....	7. TRANSPORT	11.6 Transport routes in the area.....
2.2 Laws and regulations	7.1 General	11.7 Collector rail for electrically driven vehicles....
2.3 Safety requirements.....	7.2 Transport casks containing canisters	11.8 Railway yard.....
2.4 Radiation protection requirements	7.3 Bentonite.....	11.9 Routing of cables and pipes in the ground.....
2.5 Safeguards.....	7.4 Excavated rock masses	11.10 Ground treatment.....
2.6 Physical protection.....	7.5 Backfilling material	11.11 Possible extension areas
2.7 Environmental requirements.....	7.6 Transports in the ramp	11.12 Data and dimensions.....
2.8 Data for canisters.....	8. VEHICLES AND MACHINES	11.13 Site arrangement – excavation of ramp and shaft
2.9 Data for transport casks.....	8.1 General	12. OPERATIONAL AREA - BUILDINGS
2.10 Data for radiation shielding tubes.....	8.2 Vehicles	12.1 List of buildings
2.11 Deposition capacity.....	8.3 Machines.....	12.2 Office and workshop building.....
2.12 Buffer and backfilling material	9. STAFF - ORGANISATION	12.3 Information building.....
3. PHASES	9.1 General	12.4 Garage building.....
3.1 General.....	9.2 Organisation	12.5 Storage building.....
3.2 Site investigation.....	9.3 Staff.....	12.6 Utility building.....
3.3 Detailed investigation	10. HARBOUR AREA	12.7 Electrical building / Switchyard.....
3.4 Construction for initial operation.....	10.1 General	12.8 Reloading hopper
3.5 Initial operation	10.2 Generic arrangement.....	12.9 Unloading hopper
3.6 Evaluation.....	10.3 Site arrangement	12.10 Portal building.....
3.7 Construction for regular operation	10.4 Railway yard.....	12.11 Production building.....
3.8 Regular operation.....	10.5 Storage building for bentonite.....	12.12 Management centre.....
3.9 Decommissioning - sealing.....	10.6 Harbour office	12.13 Elevator and ventilation building.....
4. GENERIC DESIGN - HARBOUR	10.7 Ground treatment.....	12.14 Auxiliary systems building.....
5. GENERIC DESIGN – DEEP REPOSITORY		12.15 Terminal building
5.1 General.....		
5.2 Overall		
5.3 Staffing, during daytime.....		
5.4 Radiological environment.....		
5.5 Protection against trespassing		
5.6 Transport routes.....		
5.7 Power supply.....		
5.8 Ventilation		
5.9 Repository drainage system.....		
5.10 Comparative land requirements.....		

CONTENTS

- 13. EXHAUST AIR PLANT
 - 13.1 General.....
 - 14.1 Site arrangement.....
 - 14.1 Ventilation building.....
- 14. ROCK STOCKPILE
 - 14.1 Rock volumes
 - 14.2 Stockpile arrangement.....
- 15. UNDERGROUND - COMMON
 - 15.1 General.....
 - 15.2 Generic arrangement
 - 15.3 Theoretical site arrangement.....
 - 15.4 Designations
 - 15.5 Operations.....
 - 15.6 Transport routes.....
 - 15.7 Tunnel cross sections
 - 15.8 Fire protection.....
 - 15.9 Doors.....
 - 15.10 Ventilation
 - 15.11 Repository drainage system.....
 - 15.12 Electricity distribution.....
 - 15.13 Working environment
 - 15.14 Data and dimensions.....
- 16. RAMP - TUNNELS - SHAFTS
 - 16.1 General.....
 - 16.2 Ramp
 - 16.3 Tunnels.....
 - 16.4 Special solutions.....
 - 16.5 Shafts.....
 - 16.6 Co-ordination between ramp and shaft.....
- 17. CENTRAL AREA
 - 17.1 General
 - 17.2 Site arrangement
 - 17.3 Reloading station.....
 - 17.4 Storage and workshop vault.....
 - 17.5 Elevator vault.....
 - 17.6 Ventilation vault.....
 - 17.7 Electrical power vault.....
 - 17.8 Vehicle vault.....
 - 17.9 Repository drainage vault
 - 17.10 Rock silo
- 18. DEPOSITION AREA
 - 18.1 General
 - 18.2 Deposition area 1
 - 18.3 Deposition area 2
 - 18.4 Excavation work.....
 - 18.5 Deposition work
 - 18.6 Drilling of deposition holes.....
 - 18.7 Inserting of buffer.....
 - 18.8 Deposition of canister.....
 - 18.9 Backfilling.....
 - 18.1 Deposition tunnel – connection and sealing.....
- 19. SYSTEMS
 - 19.1 Ventilation system
 - 19.2 Repository drainage system.....
 - 19.3 Electrical system
 - 19.4 List of systems.....
- 20. DECOMMISSIONING
 - 20.1 General
 - 20.2 Starting point for decommissioning
 - 20.3 Deposition areas.....
 - 20.4 Central area.....
 - 20.5 Ramp.....
 - 20.6 Restoration - reuse
- 21. VISIONS
 - 21.1 Architectural objectives.....
 - 21.2 Examples
- 22. PRINCIPAL DATA FOR THE FACILITY
- 23. REFERENCES

APPENDIX: TWO-LEVEL ALTERNATIVE

- 1.1 Background
- 1.2 Objective
- 1.3 Delimitations
- 1.4 Implementation

1

GENERAL

1.1 Background

The deep repository for spent nuclear fuel will be constructed, operated and sealed in order to isolate the spent nuclear fuel from the biosphere for a very long period of time. This will lead to a variety of requirements regarding the construction, operation and safety of the facility, which must be taken into account in the design.

In 1992/93, SKB compiled the first facility descriptions for a future deep repository. The main reason for producing them at that time was to document how the repository might look, in a comprehensive and co-ordinated way, based on the KBS-3 method. Until 1992/93, work on the repository had been concentrated on the most important generic solutions, while the overall design of the facility was deferred.

In the years since these facility descriptions were drawn up, many studies have been carried out in individual areas of deep repository technology. Practical work has been undertaken, on both a laboratory and industrial scale. For example, the technology has been studied during handling of canisters and bentonite in the repository, preliminary safety analyses have been conducted (SR 97), and trial production of canisters has been started. In addition, experiments and demonstrations in the Äspö laboratory have started to yield practical results. Consequently, an updating of the facility description for the deep repository is justified.

Subsequently, the backfilling material has been changed from silica sand and bentonite to a mixture of the excavated rock and bentonite. This has created a requirement for a rock storage yard close to the operating area, for an estimated storage period of around 40 years.

1.2 Objective

The intention of this facility description is to produce documentation of the deep repository in a form that reflects current knowledge and experience. The objectives of this account are:

- To create documentation that describes the entire deep repository, in terms of design, function and working methods, and which can form a common basis for the continued design work on the facility.

- To serve as a basis for planning site-specific facilities at the locations in question.
- To serve as a starting point for drawing up site-specific site investigation programmes.
- To serve as a basis for costing and scheduling.
- To facilitate more in-depth studies of necessary operations and logistics, as well as machinery and vehicle requirements.
- To serve in the assessment of staff requirements when the facility is in operation.
- To act as a control instrument, in order to ascertain the need for further studies into technical problems of importance for the final design.
- To serve as the basis for information for public authorities, municipalities, landowners and other interested parties that are affected.
- This facility description deals with the “Spiral ramp with one operational area” alternative. Besides it is assumed that theoretical site is located inland in the vicinity of a suitable railway.

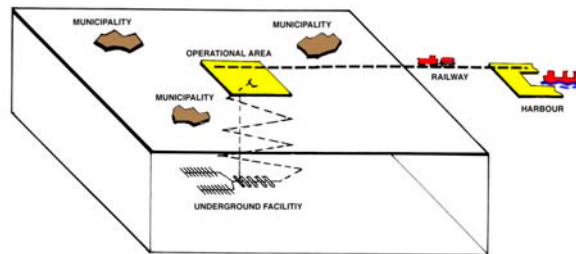

Figure 1-1 The main criteria for locating the deep repository, with a harbour, rail link to the repository and the operational area.

1. GENERAL

1.3 Delimitations

The design of the deep repository in this description is based on generic conditions and does not refer to a specific site. The design is for a deep repository, with access via a spiral ramp, and one operational area. The description refers to a theoretical, inland site, with a rail link for transporting canisters with spent reactor fuel and bentonite to the deep repository site. The fundamental arrangement, with a harbour, rail link to the deep repository and the operational area adjacent to the ramp to the deposition area is shown in figure 1-1.

The facility description details, primarily, the regular operation, while the construction of the deep repository is not presented. The extent of the facility is theoretical, with no account taken of actual geological conditions. The final design of the facility, and the size of the deposition areas, will be adapted later to the geographical and geological conditions of the site selected, and the wishes of the community. The deposition area will be larger than that shown, as the length and location of the deposition tunnels will have to be adapted to the accessibility of rock masses. No details of the construction of the rail link have been included in this description.

While the facility is being constructed, including the excavation of shafts and tunnels, there will be temporary buildings at the deep repository, but this phase of the repository is not presented in this description. A survey of the service and engineering systems necessary for the deep storage repository has been carried out, and there is an account of it in the description. Only the systems that affect the design of the repository have been studied in some depth. This applies to the underground ventilation system, the electrical system, the repository drainage system and fire prevention, as well as certain special equipment for producing buffer and backfilling material.

1.4 Implementation

When the project is implemented, a design model that has been used previously in similar projects will be used. The model consists of a number of stages, which successively refine the design in line with increased knowledge of conditions, working methods and machinery. A basic principal of the design model is that general issues concerning requirements and conditions are brought together and structured clearly.

The aim of the design model is to provide gradual refinement and documentation, in step with increased knowledge about the requirements of the project. This gradual increase in detail will also successively limit the scope for making changes. The design stages and the gradual increase in detail are shown in figure 1- 2 below. The first stages include various alternative solutions, which are sifted out during the subsequent stages, in favour of methods that better fulfil requirements on functionality, safety and cost effectiveness etc.

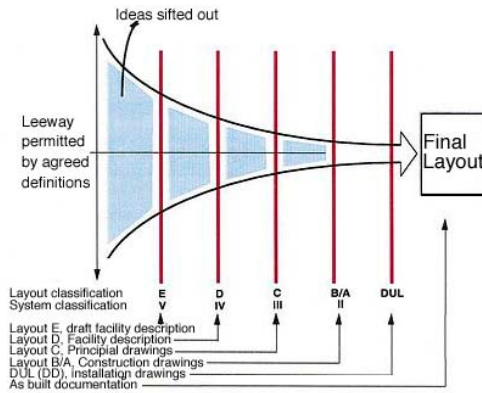

Figure 1-2 Step-by-step design and gradual limitation of scope for change.

This design model is intended to deal with all aspects of the project: buildings, utilities, machinery and vehicles. Each stage ends with the production of documentation, consisting of facility and system descriptions, drawings, diagrams, costings and schedules. Figure 1-3 illustrates the general design model. The figure shows the step-by-step order of priority in a large construction project. It also shows the relationship between the information used to plan buildings and the design of equipment and systems. The number of stages can be reduced for tunnels.

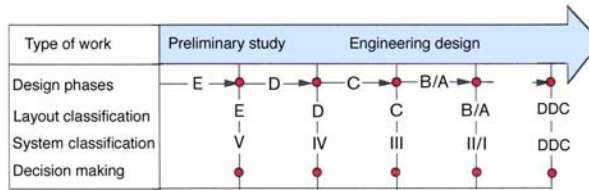

Figure 1-3 Nomenclature and classification used in SKB's design model.

In the first stage, the preliminary study, a facility description is produced, called layout E. It is based on an account of the purpose of the facility and preliminary appearance of the equipment, which are described in a document called system class V.

This facility description corresponds to the information requirements in the definition for layout E.

During the engineering and design phase, the information will be refined in stages D and C, where layout C and system documentation III usually form the basis for procurement and contracts.

1. GENERAL

Additional refining and detailing will be done in stages B and A, and II and I respectively, and will lead finally to the Detailed Documentation for the Construction (DDC), which will determine the final design of the facility.

The deep repository needs a specially formulated design model, in order to be able to gather the information from the planned site investigations. During this period, the design of the facility will be adapted to suit local conditions, including the infrastructure and geological conditions that affect the location of the shafts, ramp and deposition areas for spent nuclear fuel canisters. The adapted design model is shown in figure 1-4.

Layout stage E will be carried out before site-specific information is available. Layout stage D will be carried out during the site investigation stage, and will be divided up into a number of stages, based on the site investigations that will be carried out. In stages E and D, the entire deep repository is dealt with as a whole. In the later stages, the individual parts will be developed, in step with the schedule for the project.

The application of the design model, as regards the underground area, is limited principally to the cross section areas of the tunnels and shafts. The final location and extent of the tunnels will need to be determined while the tunnels are being excavated. However, the parts of the facility that involve building work will be planned in accordance with the step-by-step design model.

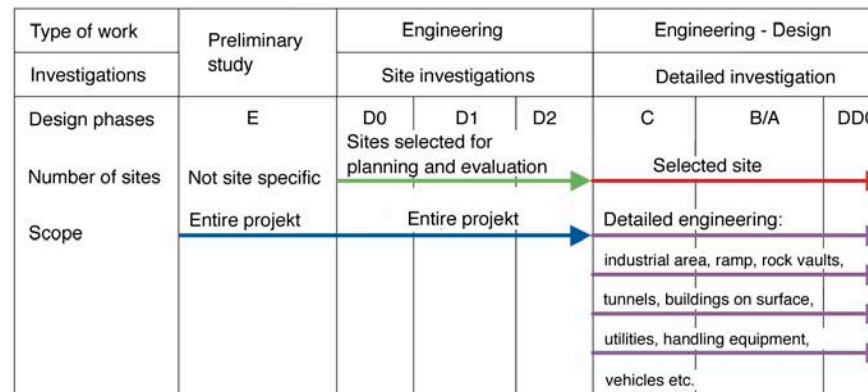

Figure 1-4 Adapted design model

- 2.1 General
- 2.2 Laws and regulations
- 2.3 Safety requirements
- 2.4 Radiation protection requirements
- 2.5 Safeguards
- 2.6 Physical protection
- 2.7 Environmental requirements
- 2.8 Data for canisters
- 2.9 Data for transport casks
- 2.10 Data for radiation shielding tubes
- 2.11 Deposition capacity
- 2.12 Buffer and backfilling material

2

GENERAL REQUIREMENTS

2. GENERAL REQUIREMENTS

2.1 General

The repository will be designed so that the canisters are handled and deposited in a safe manner.

The KBS-3 model will form the basis of the design of the facility. This means that the spent fuel, which is encapsulated in canisters, will be put individually in vertical holes, at a depth of 400-700 metres below the surface. In this description, 500 metres has been chosen from this point on. Each canister will be surrounded by a buffer, consisting of compacted bentonite.

The design of the facility will take account of the existing transport system for reactor fuel and low- and intermediate-level waste. In principle, this means that transport casks containing a canister will be handled one at a time. Equipment required for loading, unloading and transporting will be standardised throughout the whole transport chain.

The deposition tunnels will be backfilled successively as deposition of the canisters is completed. When deposition is completely finished, all underground spaces will be backfilled with previously excavated rock, which has been mixed with bentonite if necessary.

The facility will be constructed in two basic stages, the first stage will permit limited deposition, while the second stage will enable continuous deposition to be carried out.

The latter stage will be designed so that new tunnels can be excavated while deposition work is taking place, without the two operations interfering with one another.

The surface facility for the deep repository will be adapted to the prevailing local conditions, in a considerate and aesthetically pleasing way. The facilities will be co-ordinated with the existing infrastructure as far as possible.

2.2 Laws and regulations

Some examples of the laws, regulations and conditions that should be observed when designing the facility are:

- The law on nuclear operations (1984:3)
- The radiation protection law (1988:220)
- Regulations associated with these laws from SKI and SSI, the supervisory authorities.
- The Environment Act (FS 1998:808)
- General requirements for industrial operations, e.g. industrial safety.

2.3 Safety requirements

Construction and operating phases

The facility will be designed such that it can be set up and operated with complete safety, and in compliance with current legislation and regulations.

Long-term safety

The facility will be designed so that the long-term safety after the deep repository has been sealed shall fulfil the requirements in the safety regulations issued by the Swedish Radiation Protection Institute (SSI) for the handling of nuclear waste, and the discussion material presented by the Swedish Nuclear Power Inspectorate, (SKI), on the basis for regulations and general guidelines on the final disposal of spent nuclear fuel etc.

2.4 Radiation protection requirements

The facility will be designed and equipped so that the canisters can be handled in compliance with established principles for protection from ionising radiation. SSI's and SKI's regulations will be followed; these specify the requirements for safety and radiation protection for nuclear reactors and waste facilities.

2.5 Safeguards

The facility will be designed in a way that makes it possible to apply the prescribed safeguards.

The IAEA has issued a draft policy for safeguards for a deep repository. This provides, *inter alia*, that safety checks shall be maintained, even after the repository has been backfilled and sealed. The checking will be carried out by continuous monitoring during operation and sealing, and thereafter by periodical monitoring of the area.

2.6 Physical protection

The deep repository will have physical protection, designed to prevent unauthorised access to the areas concerned, and to prevent damage to, or theft, of fissile material.

2.7 Environmental requirements

The facility will be designed in a way that causes as little impact as possible on its surroundings.



2.8 Data for canisters

Length:	4.8 m
Diameter:	1.05 m
Weight:	25-27 tons

2.9 Data for transport casks

Length:	5.5 m
with shock absorber	6.1 m
Diameter:	2.0 m
with shock absorber	2.3 m
Weight empty:	40 tons
Weight with canister:	65 tons
incl. shock absorbers/transport frames	75 tons

2.10 Data for radiation shielding tubes

Length:	5.5 m
Diameter:	2.0 m
Weight empty:	35 tons
Weight with canister:	60 tons

Transport cask for encapsulated fuel

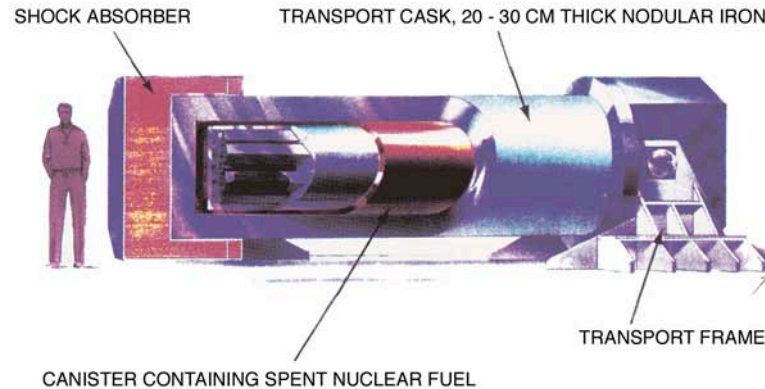

2.11 Deposition capacity

Repository capacity

The deep repository will be designed to house the following number of canisters:

- Total number of canisters 4,500
(Equivalent to 9,000 tons of uranium)
- Number of canisters during initial operation: 200 - 400
- Number of canisters during regular operation: 4,100 - 4,300

Rate of deposition

Affected systems will be designed to deal with the following rates of deposition:

- During initial operation: 100 canisters /year
equivalent to 2-3 canisters per week
- During regular operation: 200 canisters/year
equivalent to 5 canisters per week

2. GENERAL REQUIREMENTS

2.12 Buffer and backfilling material

Buffer

Each canister will be surrounded by the following buffer of bentonite in the deposition hole:

- Bottom thickness: 0.5 m
- Sheath thickness: 0.35 m
- Lid thickness: 1.5 m

The measurements given refer to the thickness of the buffer after becoming saturated with water.

The production plant will be designed to produce buffer material in pace with the deposition of canisters.

After the bentonite has been compacted into buffer blocks, they must be stored in a controlled manner, in order to prevent cracking and damage caused by drying out or absorption of moisture.

Backfilling material

Deposition tunnels

Each deposition tunnel will be backfilled immediately after deposition of the canisters has ended. The backfilling material is assumed to consist of previously excavated rock, mixed with approximately 15 percent bentonite.

Measures will be taken to enable continuous backfilling. Backfilling material will be prepared in parallel with the backfilling.

Other rock vaults and shafts

The intention is to backfill all rock vaults, tunnels and shafts when deposition has finished. It is not thought that this work will affect the design or size of the facility.

- 3.1 General
- 3.2 Site investigation
- 3.3 Detailed investigation
- 3.4 Construction for initial operation
- 3.5 Initial operation
- 3.6 Evaluation
- 3.7 Construction for regular operation
- 3.8 Regular operation
- 3.9 Decommissioning - sealing

3. PHASES

3.2 Site investigation

The report "Integrated account of method, site selection and programme prior to the site investigation phase" contains a presentation of those areas in which SKB wishes to proceed with site investigations.

The objective of the site investigations is to provide a basis for:

- Showing that the selected site fulfils fundamental safety requirements and prerequisites for construction.
- Comparing the site with other investigated sites.
- Adapting the deep repository to the local conditions with acceptable environmental and societal impact.

The time frame, scope and content of the site investigation phase require that it be divided into sub-phases, in order to carry out all of the investigations and analyses efficiently. A division into phases also makes it easier to use a method of investigation tailored to the site, and provides more effective feedback from the evaluation. For this reason, the site investigation will be divided into initial and complete (more detailed) site investigation.

The objectives of the initial site investigation are:

- To identify and select a site within a candidate area, evaluated as most suitable for a deep repository, so that continued investigations will be concentrated at that site.
- To make a general determination as to whether the conclusion of the pre-study as to the suitability of the candidate area is still valid, based on the data from the bedrock.

The objectives of a complete site investigation are:

- To provide a geoscientific understanding of the site concerning present conditions and naturally ongoing processes.
- To give a basis for adaptation of the repository to the site.
- To provide a basis for analysing implementation of the facility and consequences thereof.
- To provide a basis for a safety analysis to assess if long term safety can be ensured for the site.

During the site investigation various surface and borehole-based methods will be used to investigate the bedrock and its fracture zones. Geoscientific models (descriptions) of the site will be developed. These models will then be used for elaborating a site-specific facility description.

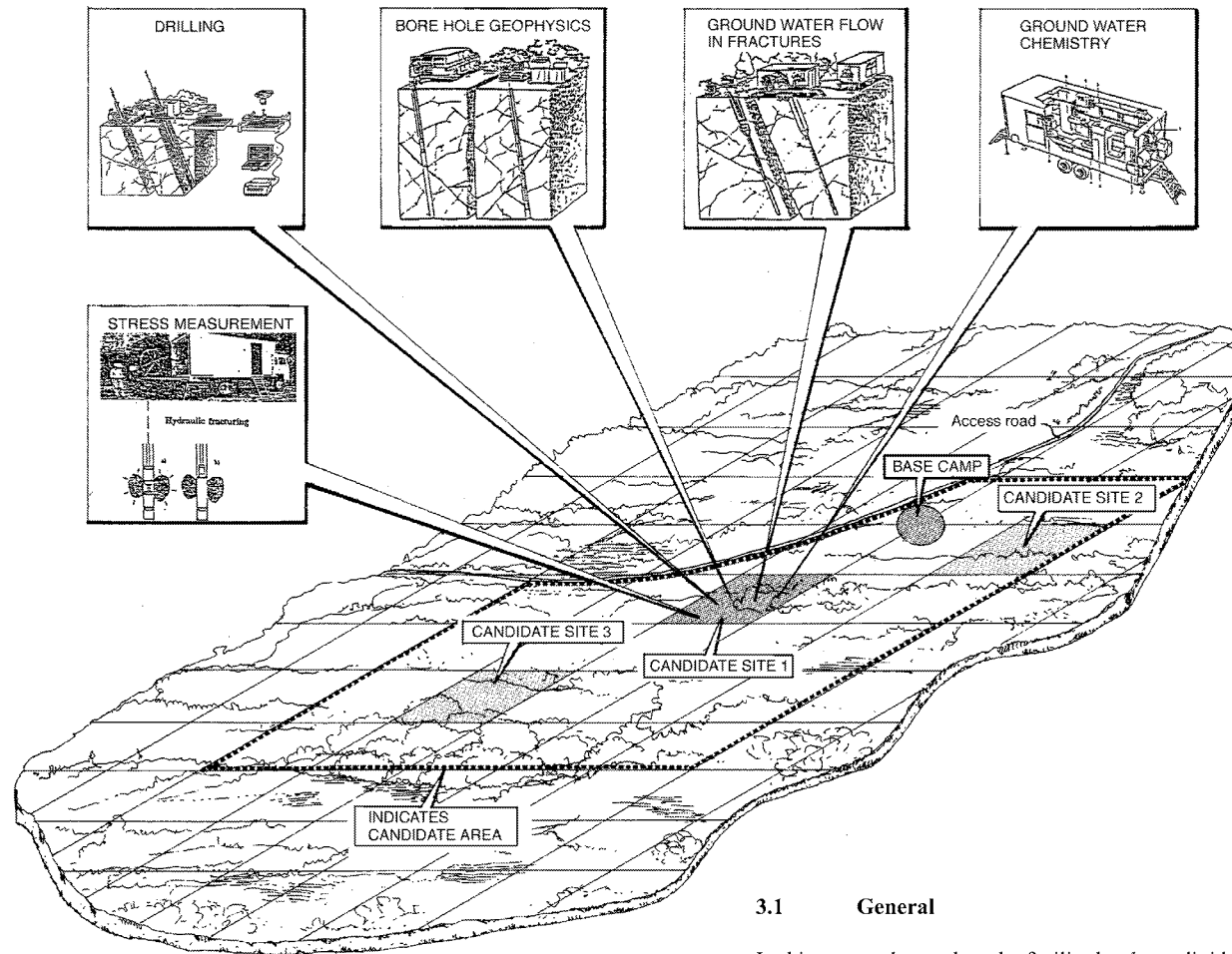

3.1 General

In this report, the work at the facility has been divided into eight phases. The following section describes the activities in each phase.

1. Site investigation
2. Detailed investigation
3. Construction for initial operation
4. Initial operation
5. Evaluation
6. Construction for regular operation
7. Regular operation
8. Decommissioning - sealing

3. PHASES

3.3 Detailed investigation

Once a site has been chosen and the necessary permits have been obtained, the detailed investigation begins. The work involves going down to the main level of the facility, approximately 500 metres below ground level. While the construction is underway, the necessary rock engineering and geoscientific investigations will be conducted, in order to develop the site description.

The following rock and construction work will be carried out in this phase:

Above ground

- Establishing construction areas, including constructing the necessary roads.
- Constructing temporary buildings, e.g. office huts, break huts, a canteen, site workshops and stores.
- Fencing the site.
- Installing power, water supply etc.

Setting up areas for excavated rock material.

Below ground

- Excavating the ramp from the operational area to the central area of the deposition level. Excavation of the shaft to the deposition level.
- Excavating transport and investigation tunnels on the deposition level.
- Developing some of the rock vaults in the central area.

It is estimated that 50-80 people will be working at the site during this phase.

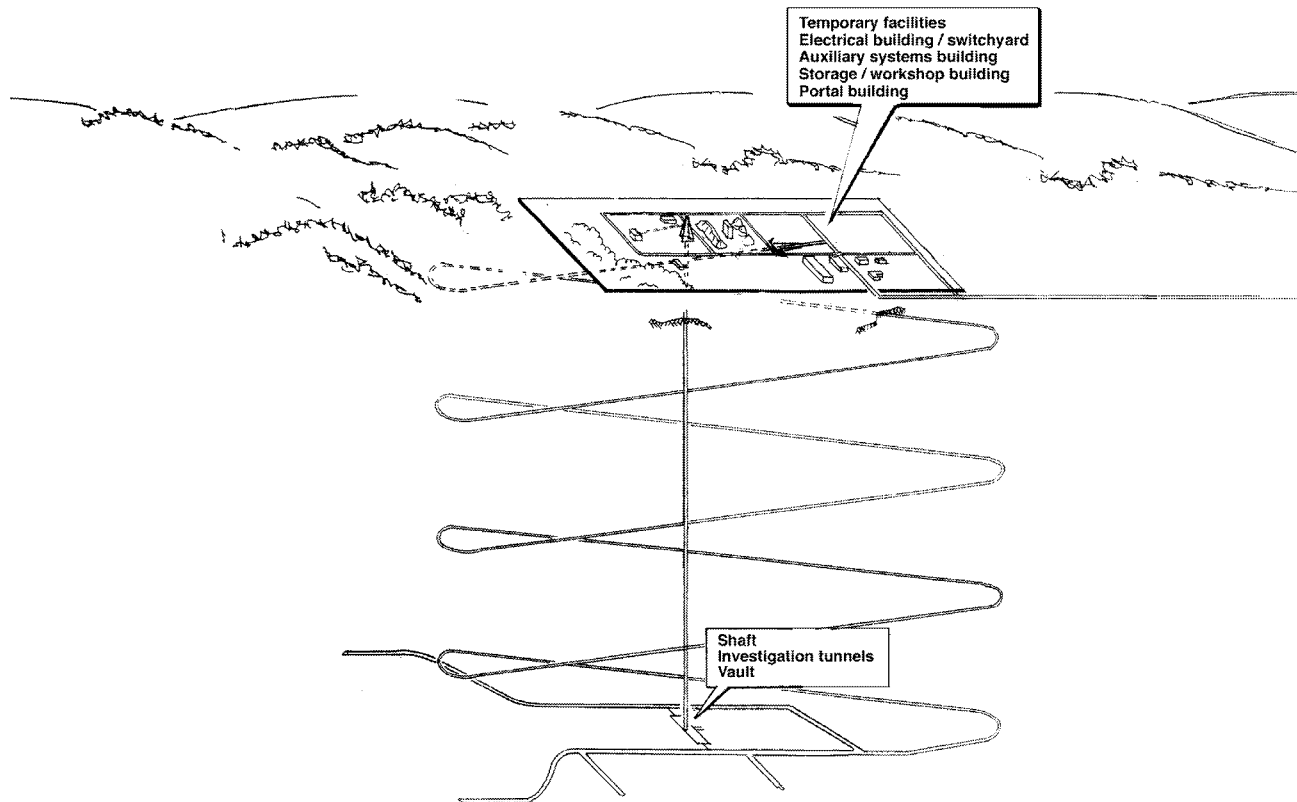

3. PHASES

3.4 Construction for initial operation

Above ground

The earthworks is carried out for the operational area, including the access road system. A rail track is laid to the operational area. The infrastructure is built up, consisting of water, sewerage, district heating system, surface water system and electrical supply system. The following buildings are constructed in the operational area.

- Information building
- Office and workshop building
- Management centre
- Production building
- Elevator/ventilation building
- Terminal building
- Garage building
- Unloading hopper for rock

A local rock store is built up.

Below ground

The following work is carried out below ground.

- Construction of necessary rock vaults in the central area, including the silo for excavated rock and associated transport tunnels.
- Construction of all tunnels in deposition area 1, and gradual drilling of most of the deposition holes.
- Installation of necessary service systems.

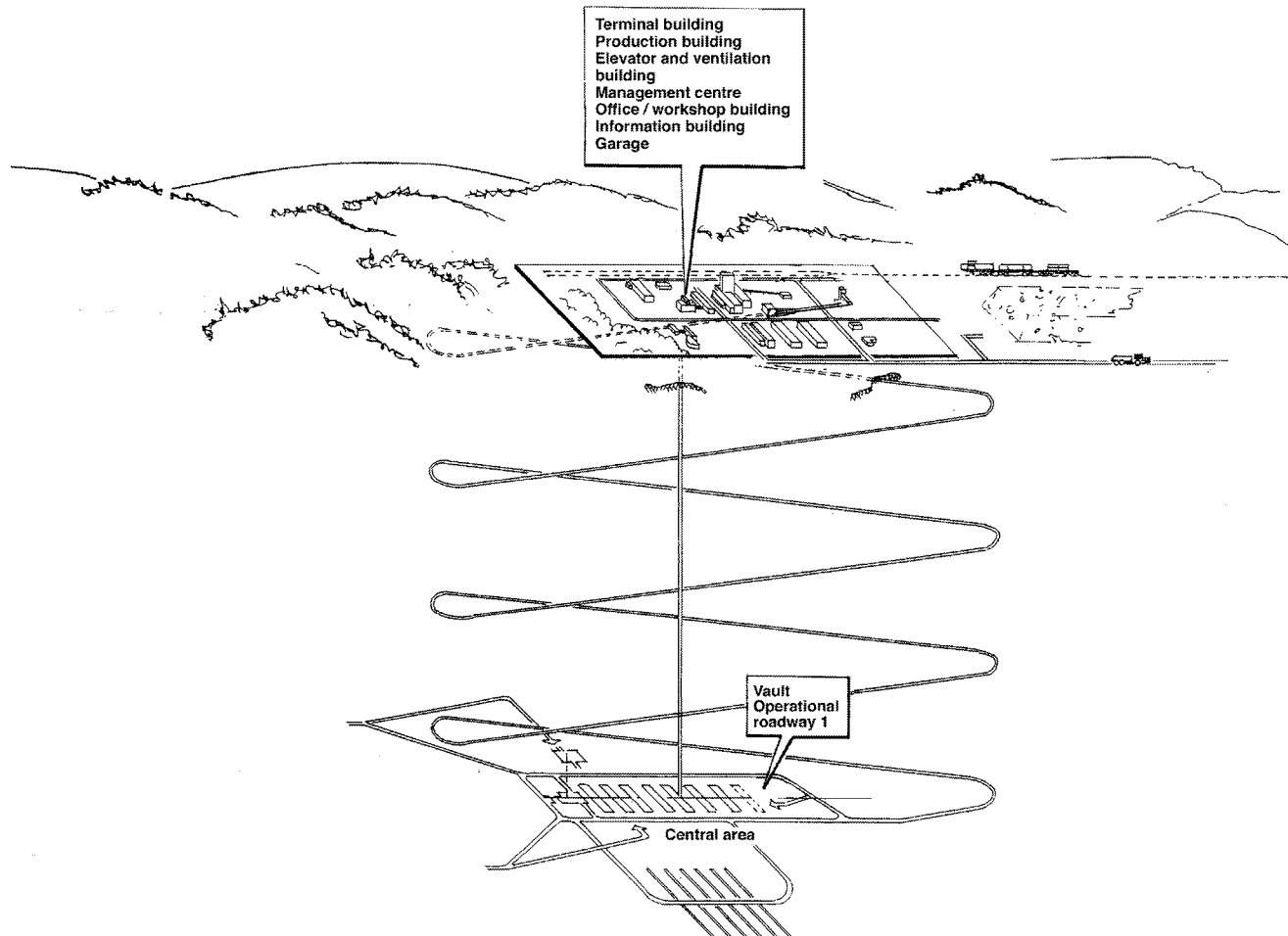

3. PHASES

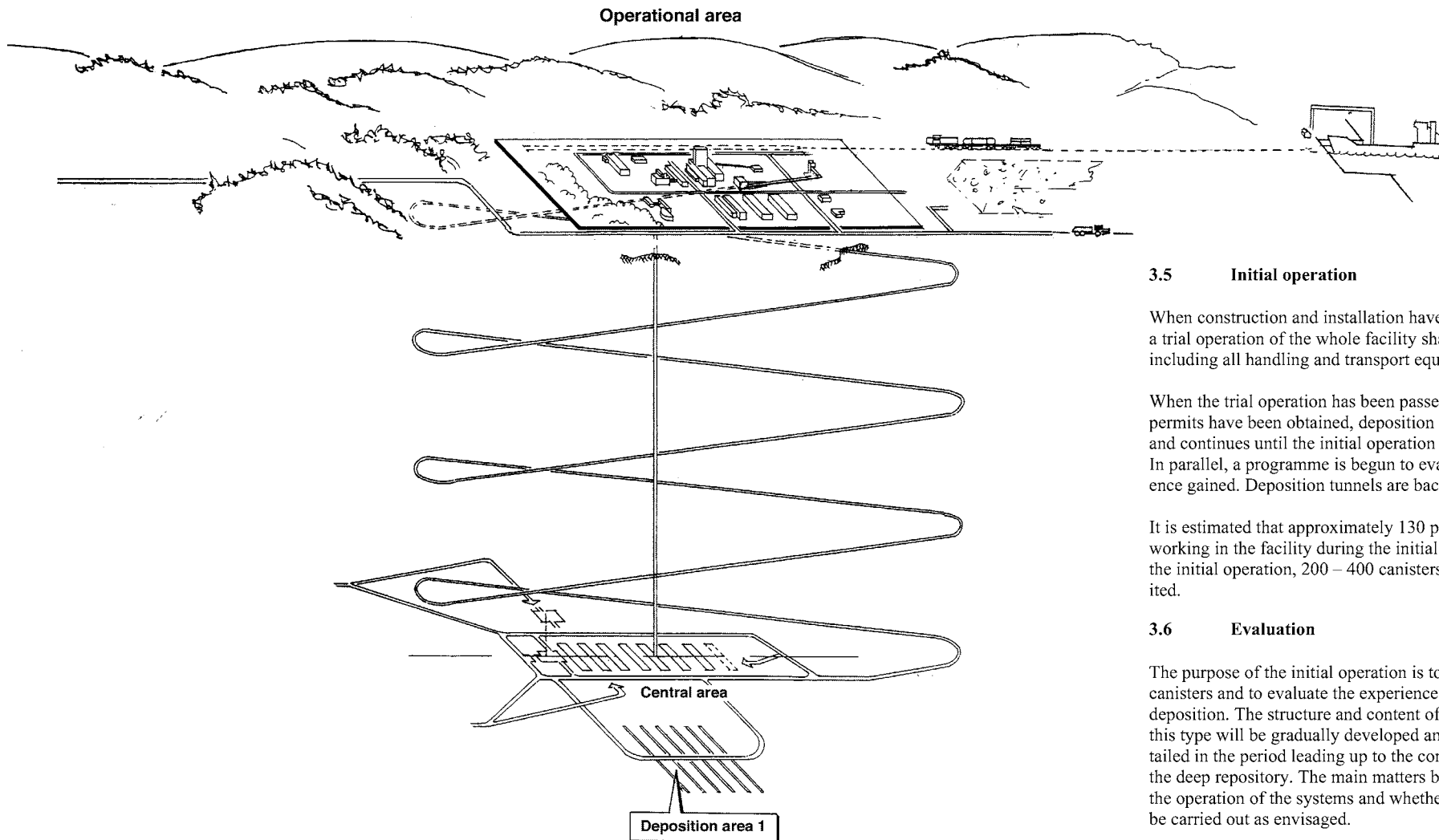

3.5 Initial operation

When construction and installation have been completed, a trial operation of the whole facility shall be conducted, including all handling and transport equipment.

When the trial operation has been passed and operating permits have been obtained, deposition of canisters starts, and continues until the initial operation phase is complete. In parallel, a programme is begun to evaluate the experience gained. Deposition tunnels are backfilled and sealed.

It is estimated that approximately 130 people will be working in the facility during the initial operation. During the initial operation, 200 – 400 canisters will be deposited.

3.6 Evaluation

The purpose of the initial operation is to deposit 200 - 400 canisters and to evaluate the experience gained from this deposition. The structure and content of an evaluation of this type will be gradually developed and made more detailed in the period leading up to the commissioning of the deep repository. The main matters being studied are the operation of the systems and whether deposition can be carried out as envisaged.

After the initial operation has been evaluated, regular operation will begin. Regular operation involves full-scale deposition and will continue until all canisters with spent reactor fuel has been deposited in the repository.

3. PHASES

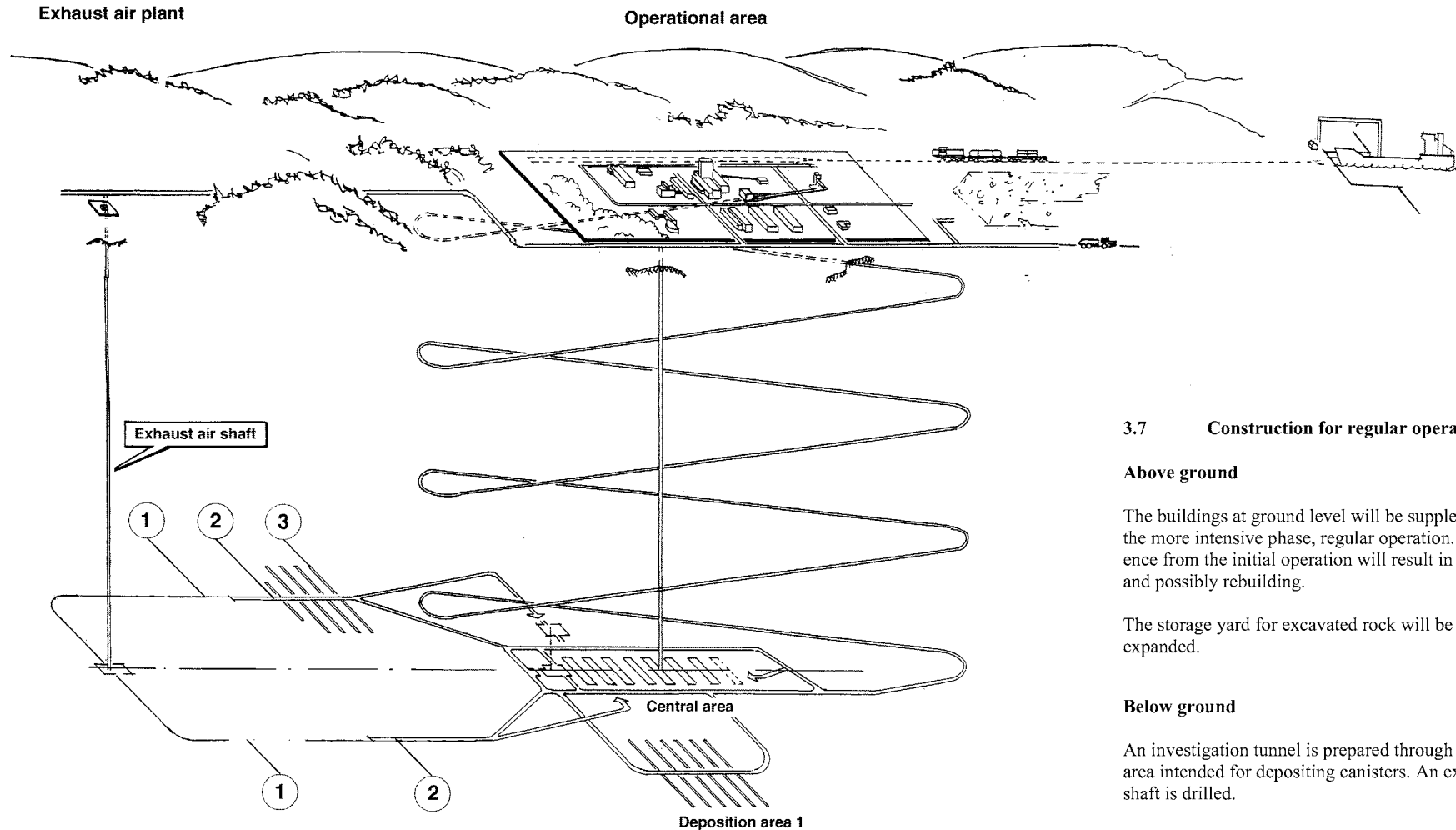

3.7 Construction for regular operation

Above ground

The buildings at ground level will be supplemented for the more intensive phase, regular operation. The experience from the initial operation will result in modifications and possibly rebuilding.

The storage yard for excavated rock will be continuously expanded.

Below ground

An investigation tunnel is prepared through the entire area intended for depositing canisters. An exhaust air shaft is drilled.

The investigation tunnel is enlarged to form the main tunnel, along a stretch of several hundred metres, in preparation for construction of deposition tunnels. Around ten deposition tunnels are prepared, so that the deposition can start.

3. PHASES

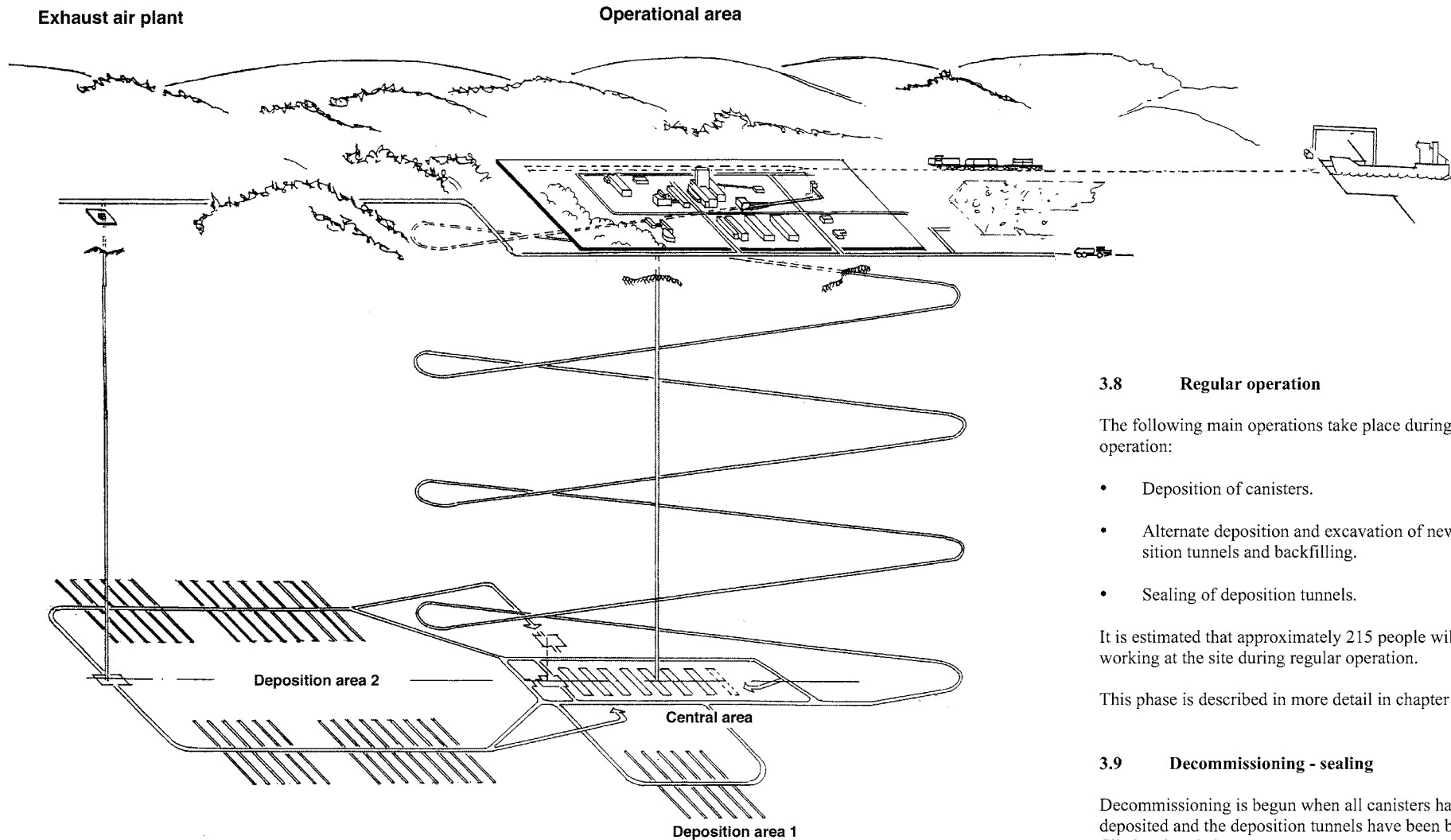

3.8 Regular operation

The following main operations take place during regular operation:

- Deposition of canisters.
- Alternate deposition and excavation of new deposition tunnels and backfilling.
- Sealing of deposition tunnels.

It is estimated that approximately 215 people will be working at the site during regular operation.

This phase is described in more detail in chapter 6.

3.9 Decommissioning - sealing

Decommissioning is begun when all canisters have been deposited and the deposition tunnels have been back-filled and sealed.

This phase is described in more detail in chapter 20.



4. GENERIC DESIGN - HARBOUR

Requirements

This facility description assumes that the location of deep repository will be located in a place that necessitate the shipping of the transport casks containing canisters from the encapsulation plant to a nearby harbour. The harbour must also be suitable for receiving ships carrying bentonite.

Conditions

The harbour will be built so that it can receive both roll-on-roll-off-ships carrying transport casks and ships carrying bulk bentonite.

The transport casks will be unloaded and temporarily stored outside. The area where the transport casks will be put must be surrounded by special protection against trespassing. It should be possible to unload the bentonite mechanically and store it temporarily indoors. It should be possible to transport the transport casks and bentonite on by rail.

Traffic

- A ship with 7,000 tons of bentonite will arrive approximately every six months.
- A ship with 10 transport casks will arrive once a fortnight
- A train carrying 750 tons of bentonite will go to the deep repository once a fortnight
- A train carrying ten transport casks will go to the deep repository every fortnight.

Generic layout

The conditions indicated above are illustrated in the adjoining diagram. The design of the harbour can easily be adapted to the circumstances of the particular site.

The desired harbour facility could be co-ordinated with an existing harbour. However, it must be possible to receive ships of the required size, and there must be a rail link or the possibility of creating one. The unloading points for canisters and bentonite can be separate if necessary. However, it must be possible to provide the temporary storage area for transport casks with acceptable protection against trespassing.

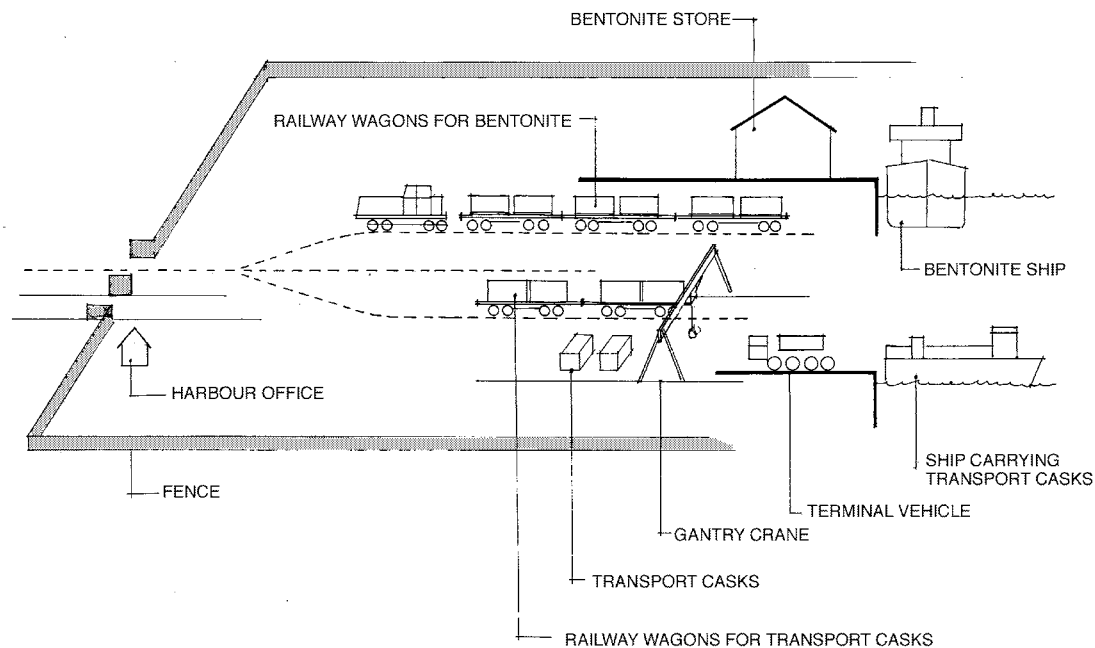

- 5.1 General
- 5.2 Overall
- 5.3 Staffing, during daytime
- 5.4 Radiological environment
- 5.5 Protection against trespassing
- 5.6 Transport routes
- 5.7 Power supply
- 5.8 Ventilation
- 5.9 Repository drainage system
- 5.10 Comparative land requirements

**5 GENERIC DESIGN –
DEEP REPOSITORY
5.1 GENERAL**

Conditions affecting the layout

1. The deposition area of the repository is located 500 metres below the surface.
2. The proposed rock vaults will be determined by practical, technical and economic factors.
3. Excavated rock volume should be kept to a minimum.
4. Excavated rock is intended to be used as backfilling material. Any excess will be either stored or sold.
5. Backfilling is done using rock with or without bentonite.
6. The deposition areas are assumed to be on one level.
7. If possible, there should be a common low point for collection of repository drainage water.
8. Both the underground and surface facilities shall be designed in a consistent and easily assessable way.
9. All functions should be flexible and expandable.
10. The underground facility shall be adaptable to the prevailing rock quality, within the constraints for the overall operation.
11. It is envisaged that deposition of canisters and construction of deposition tunnels will be done at the same time.
12. It should be easy to monitor everyone entering the operational area and the underground area.
13. The surface facility will be adaptable to environmental, geographical and topographical conditions, as well as to the existing infrastructure.
14. There should be a high level of safety in all aspects of the facility.
15. The technology used shall be optimised for both excavation and operation.

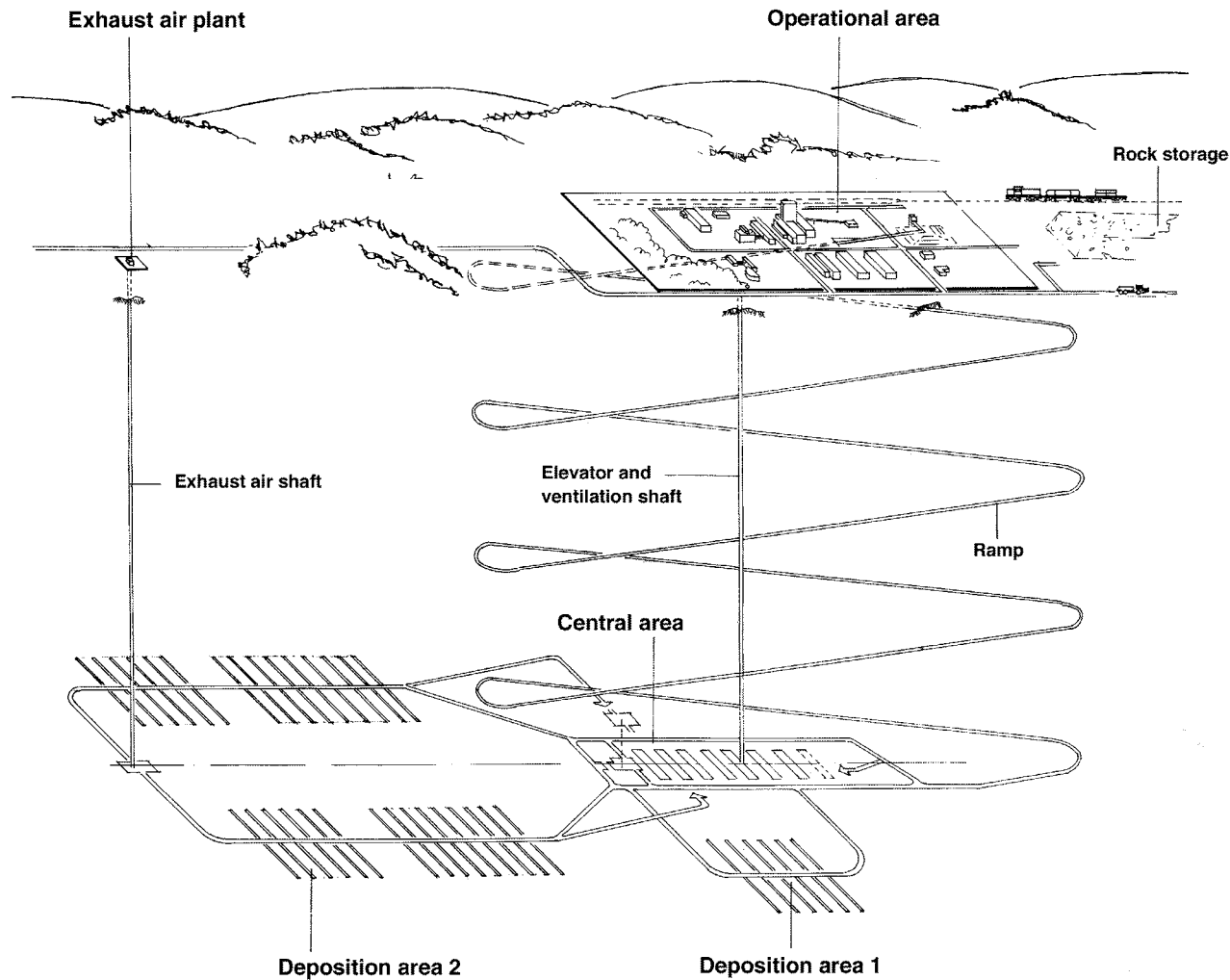

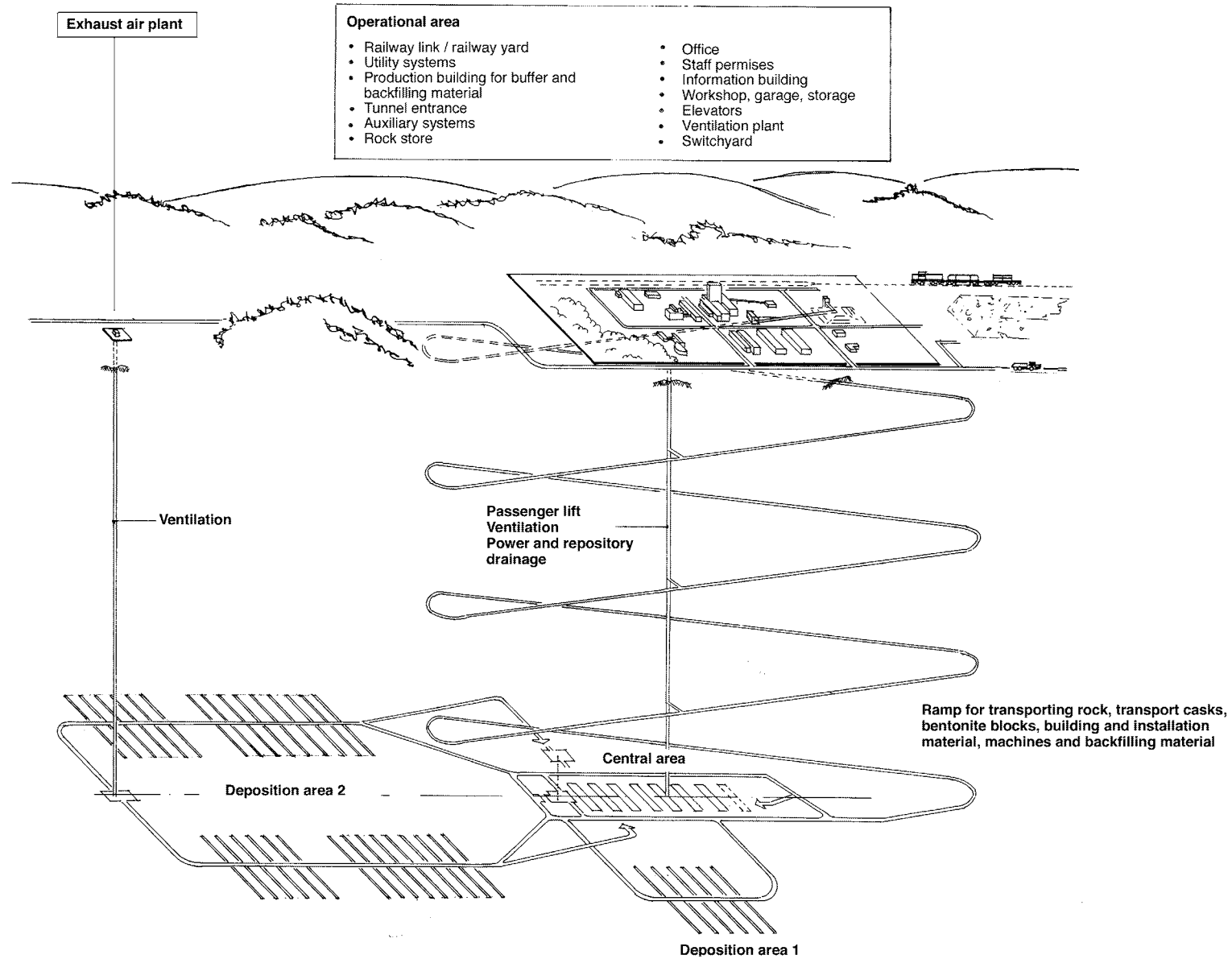

5. **GENERIC DESIGN –
DEEP REPOSITORY**
5.3 **STAFFING, DURING DAYTIME**

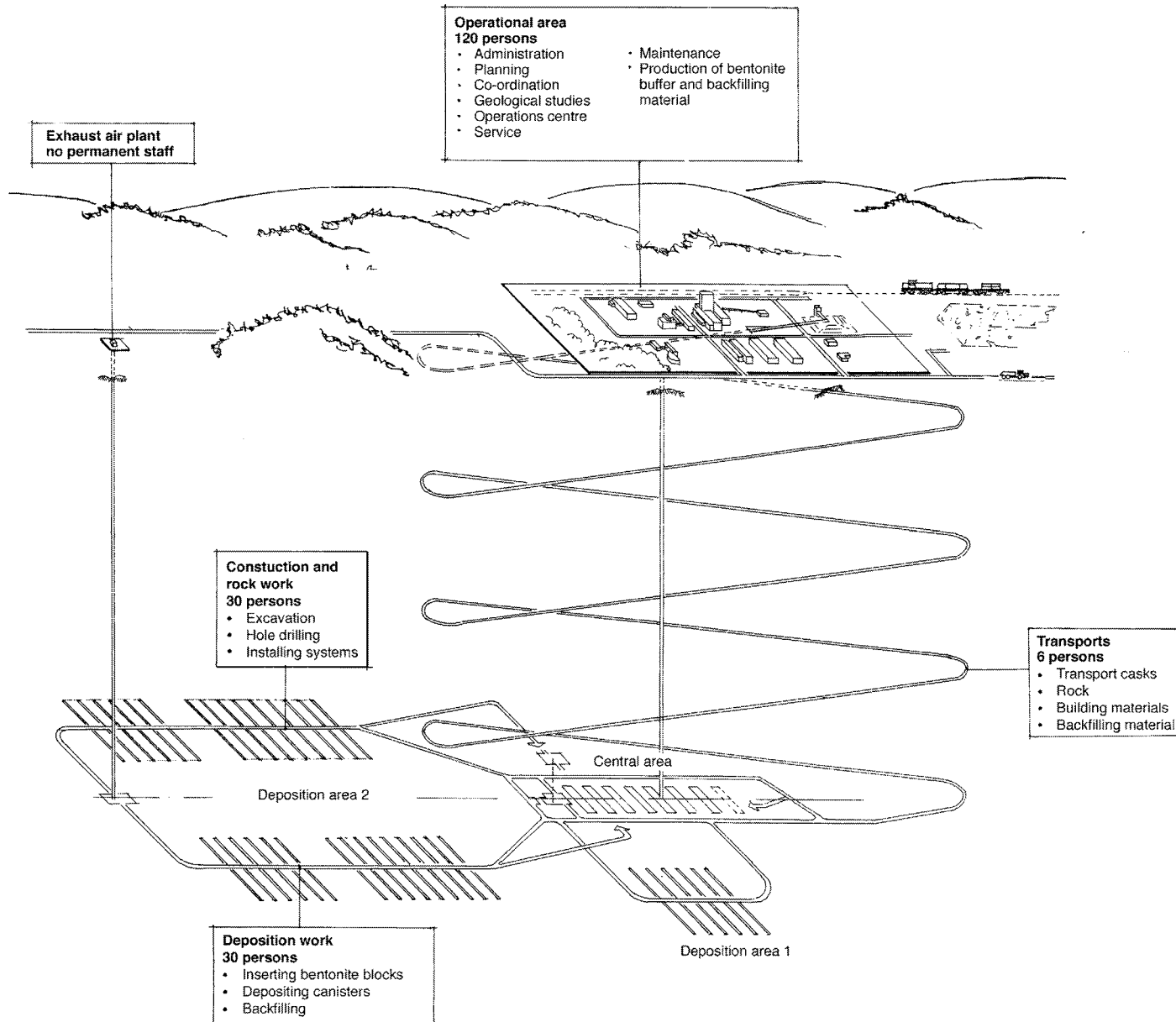

Conditions

The spent fuel is encapsulated in canisters, which are transported to the deep repository in radiation shielding transport casks. No special protective measures are required during the transport. The conditions are equivalent to those applying when transporting spent fuel from the reactors to CLAB.

The handling in the deep repository involves transferring the canisters to a radiation shielding tube, which is then transferred to the deposition machine. The entire handling process is carried out using radiation-shielded equipment.

Actions

The parts of the facility that are affected will be designed in a way that the staff are protected in accordance with applicable regulations.

Where necessary, handling equipment will be remote-controlled and fitted with suitable radiation shields.

The facility will be divided up into radiological zones, based on the presence of radioactive material.

The radiologically zoned area includes the reloading station and the buffer store in the terminal building on the surface.

In the underground facility, the reloading station and the deposition tunnels in which deposition is in progress are classified as zoned areas.

Staff members that drive, reload and deposit the canisters will wear a dosimeter. Dosimeters are collected in and returned to the operations centre.

The zoned area is divided up into various areas in the established way, based on the radiation level in each particular area.

Blue area: Admission 40 hours per week
Yellow area: Admission 1-5 hours per week

Example:

- The buffer store is classified as a yellow area, because filled transport casks are put there.
- The reloading station is classified as a yellow area when there are filled transport casks or radiation shielding tubes present.
- The deposition tunnel for canisters is classified as a yellow area when the deposition is being carried out.
- Transport of transport casks in the tunnel system is classified as a moving radiation source, in accordance with transport regulations.

There is no radiation from other operations in the facility.

As the spent fuel is well encapsulated and is transported to the final deposition site in transport casks or radiation shielding tubes, there will be neither airborne nor surface radioactivity in the facility. Thus, no special clothing is needed in the zoned area.

As a safety precaution, the facility will be continuously monitored for the presence of radioactivity.

The railway yard will be fenced to prevent unauthorised access to the area near railway waggons loaded with filled transport casks.

A detailed account of environmental issues and safety while the facility is operating will be included in the environmental impact assessment, which will be produced at a later date.

Summary

There is ionising radiation at the deep repository.

Actions:

- Zoned facility
- Layout designed for radiation protection
- Radiation shielding of affected building elements
- Remote-controlled mechanical equipment with special radiation shielding
- Dosimeters will be worn.

Airborne activity

From the waste: Not present
Radon from the rock: Present

Action:

- The capacity and design of the ventilation plant.

There is no surface contamination

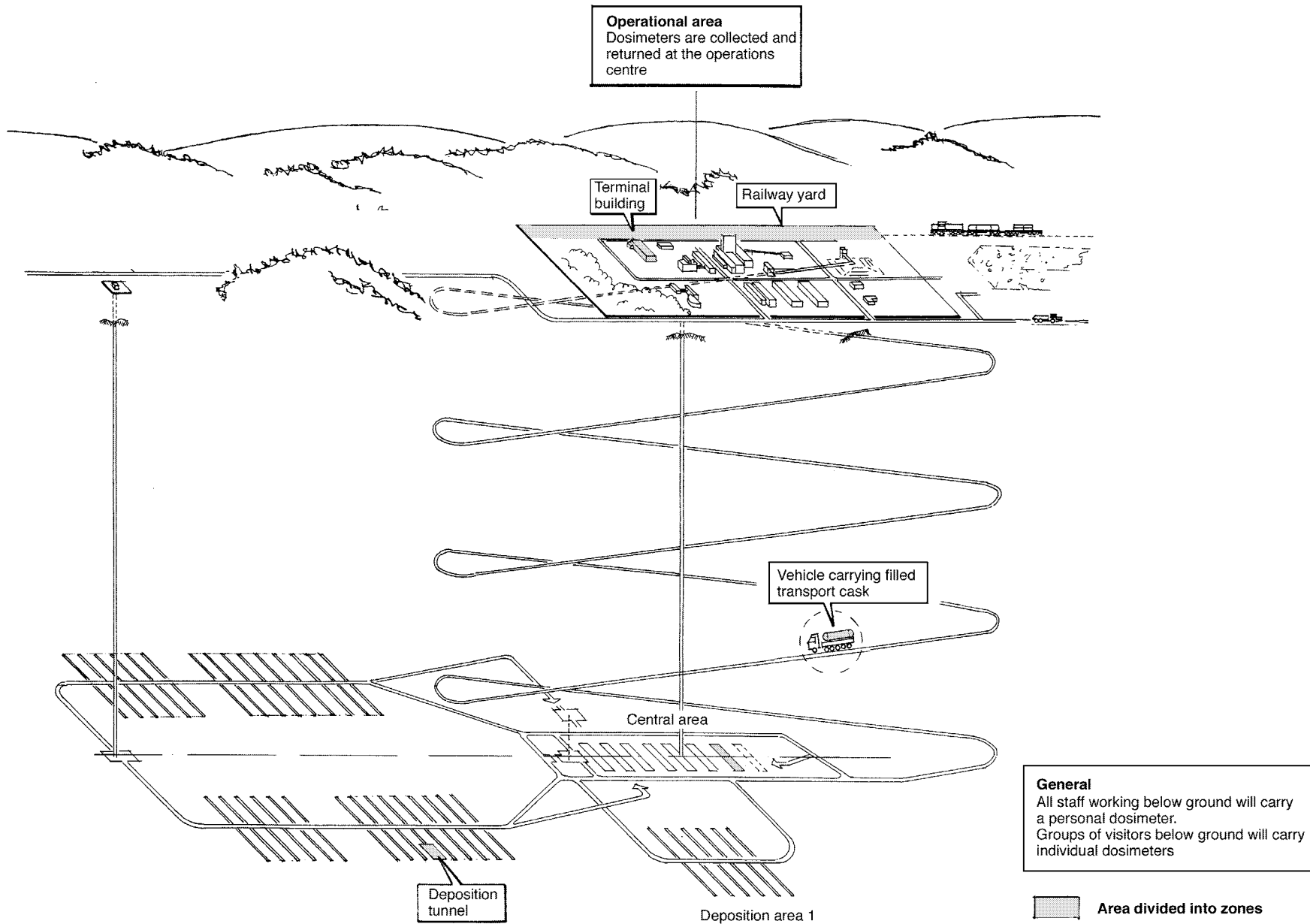

5. **GENERIC DESIGN –
DEEP REPOSITORY**
5.5 **PROTECTION AGAINST TRESPASSING**

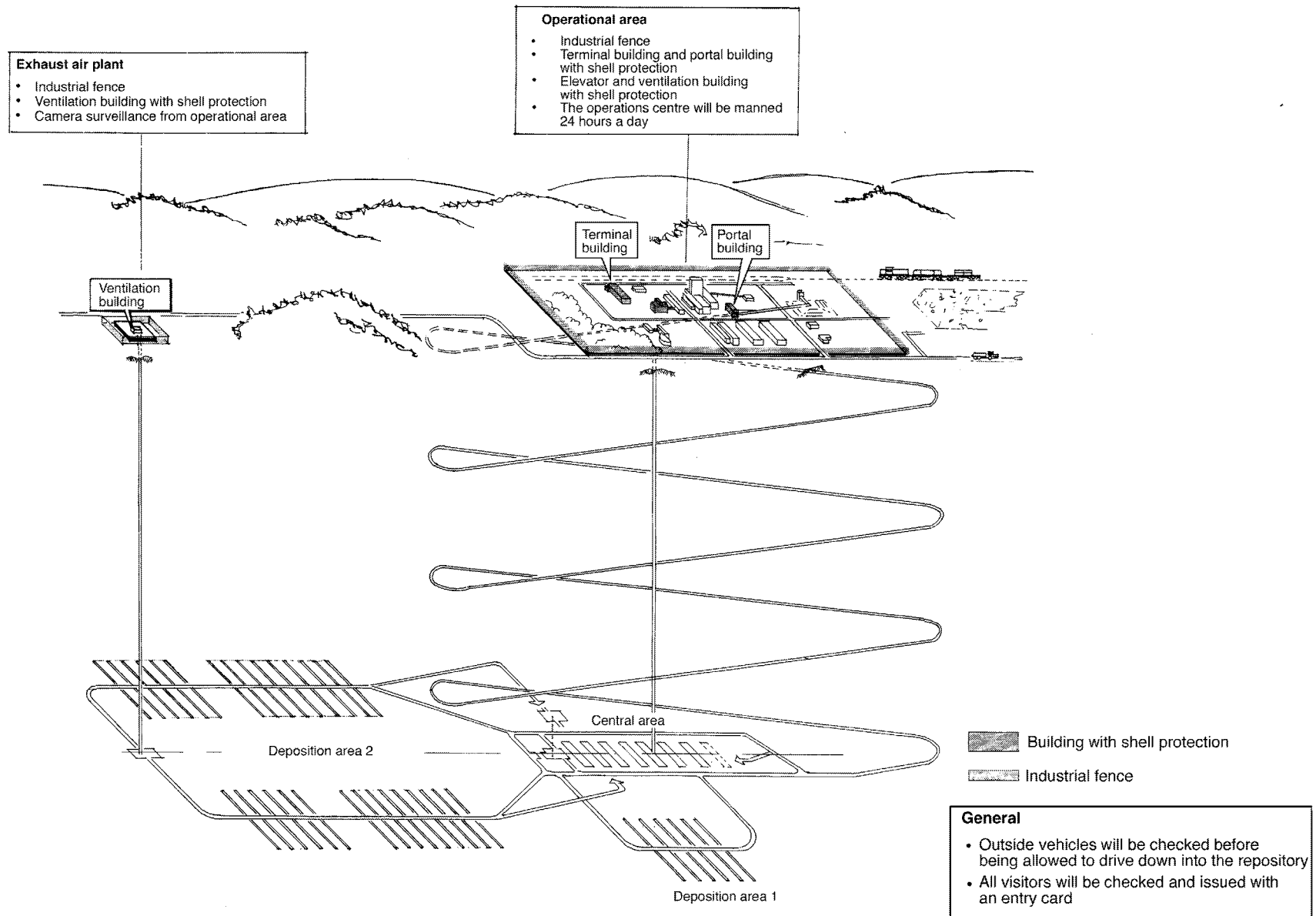

5 GENERIC DESIGN –
 DEEP REPOSITORY
 5.6 TRANSPORT ROUTES

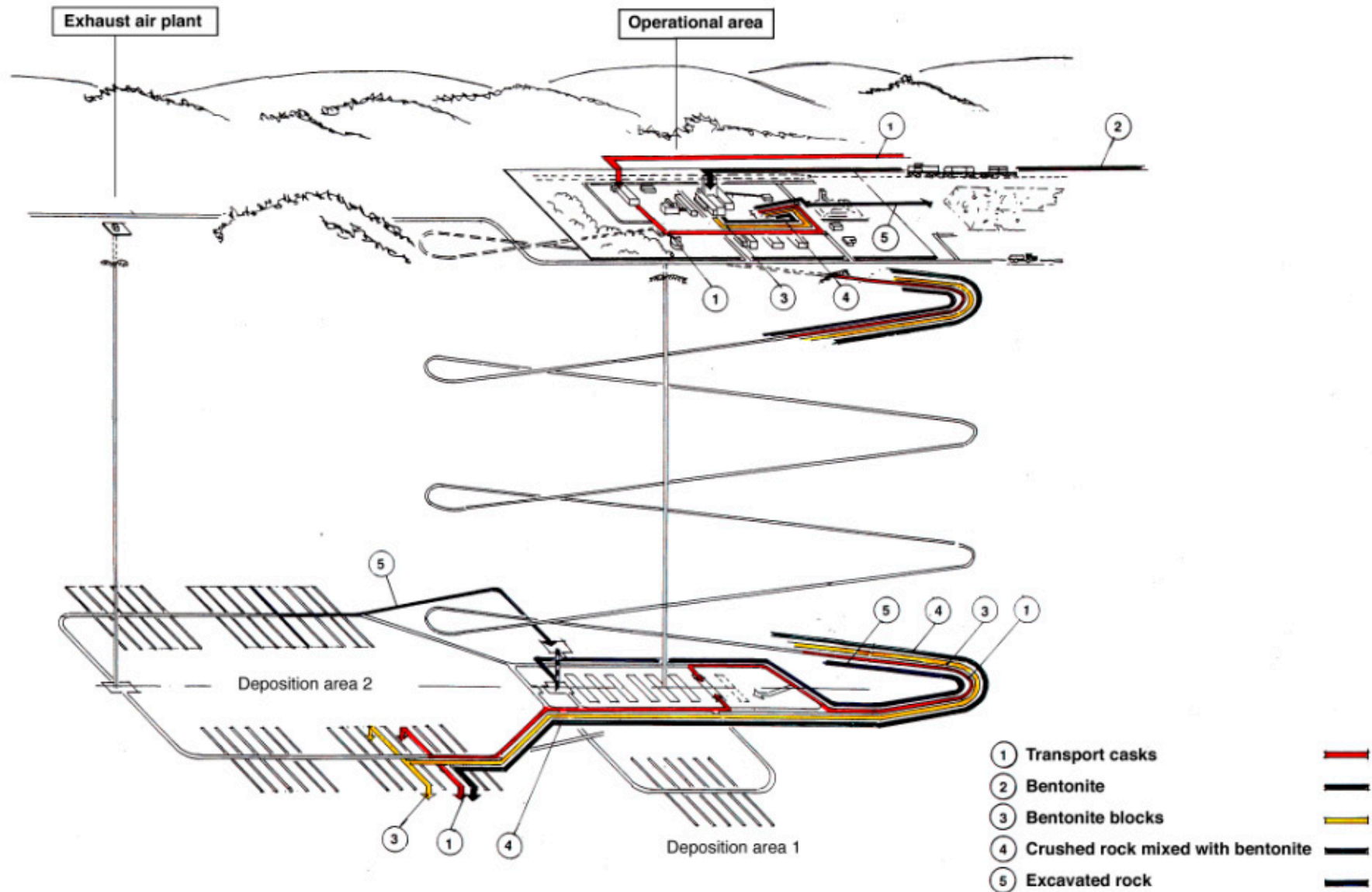

5. GENERIC DESIGN –
DEEP REPOSITORY
5.7 POWER SUPPLY

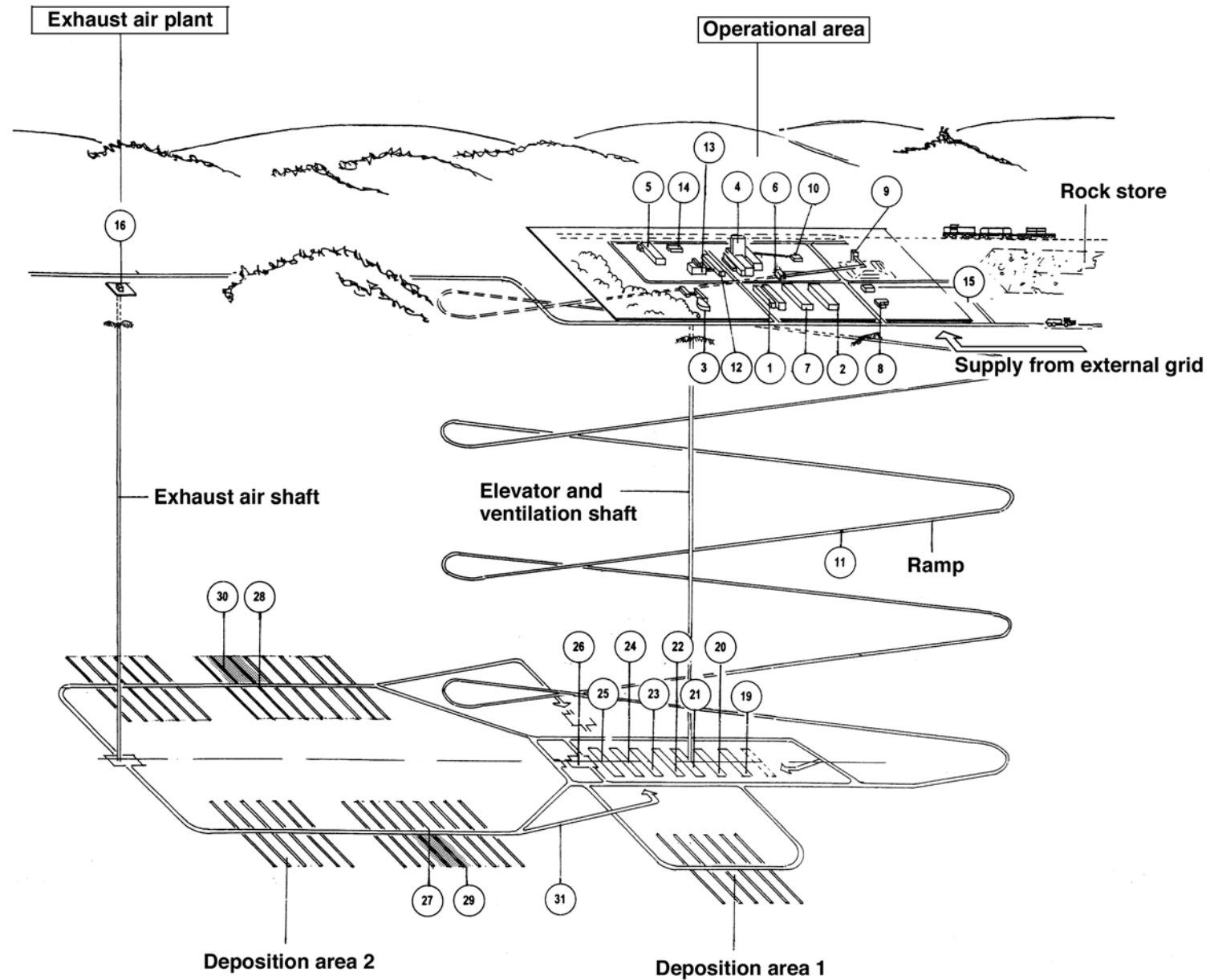

5. **GENERIC DESIGN –
DEEP REPOSITORY
POWER SUPPLY**

5.7

Pos.	Area/Building	Type of installation								
		External switchyard	High voltage switchyard	Auxiliary power unit	Low voltage switchyard	Electrical room	Rectifier + battery	UPS + battery	Distribution boards	Mobile distribution
OPERATIONAL AREA										
1	Office and workshop building				x					
2	Information building					x			x	
3	Garage building								x	
4	Storage building								x	
5	Utility building								x	
6	Electrical building/Switchyard	x	x	x	x		x		x	
7	Unloading hopper								x	
8	Reloading hopper								x	
9	Portal building								x	
10	Production building				x	x			x	
11	Management centre						x		x	
12	Elevator and ventilation building					x			x	
13	Auxiliary systems building					x			x	
14	Terminal building								x	
15	Ramp – Electric vehicle operation					x			x	
EXHAUST AIR PLANT										
16	Ventilation building				x	x				

Pos.	Area/Building	Type of installation								
		External switchyard	High voltage switchyard	Auxiliary power unit	Low voltage switchyard	Electrical room	Rectifier + battery	UPS + battery	Distribution boards	Mobile distribution
UNDERGROUND AREA – CENTRAL AREA										
19	Reloading vault									x
20	Storage and workshop vault									x
21	Elevator vault									x
22	Ventilation vault									x
23	Electrical vault		x		x		x	x		
24	Vehicle vault									x
25	Repository drainage vault					x				x
26	Rock silo									x
UNDERGROUND AREA – DEPOSITION AREA										
27	Electrical building - A-side		x							
28	Electrical building - B-side		x							
29	Current deposition area								x	x
30	Current excavation area								x	x
31	Transport tunnels – Electric vehicle operation								x	x

5. **GENERIC DESIGN –
DEEP REPOSITORY**
5.8 **VENTILATION**

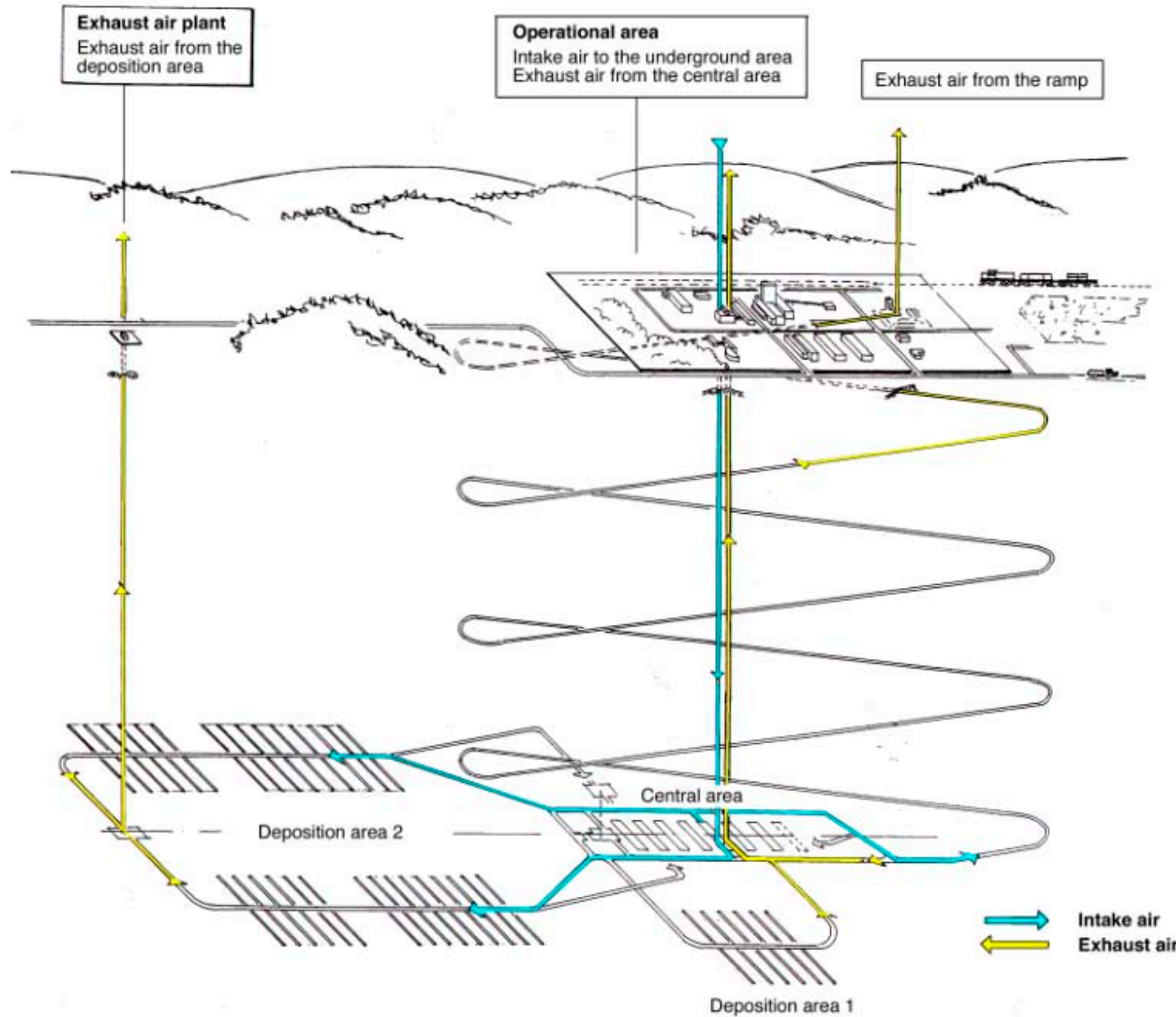

5. **GENERIC DESIGN –
DEEP REPOSITORY**
5.9 **REPOSITORY DRAINAGE SYSTEM**

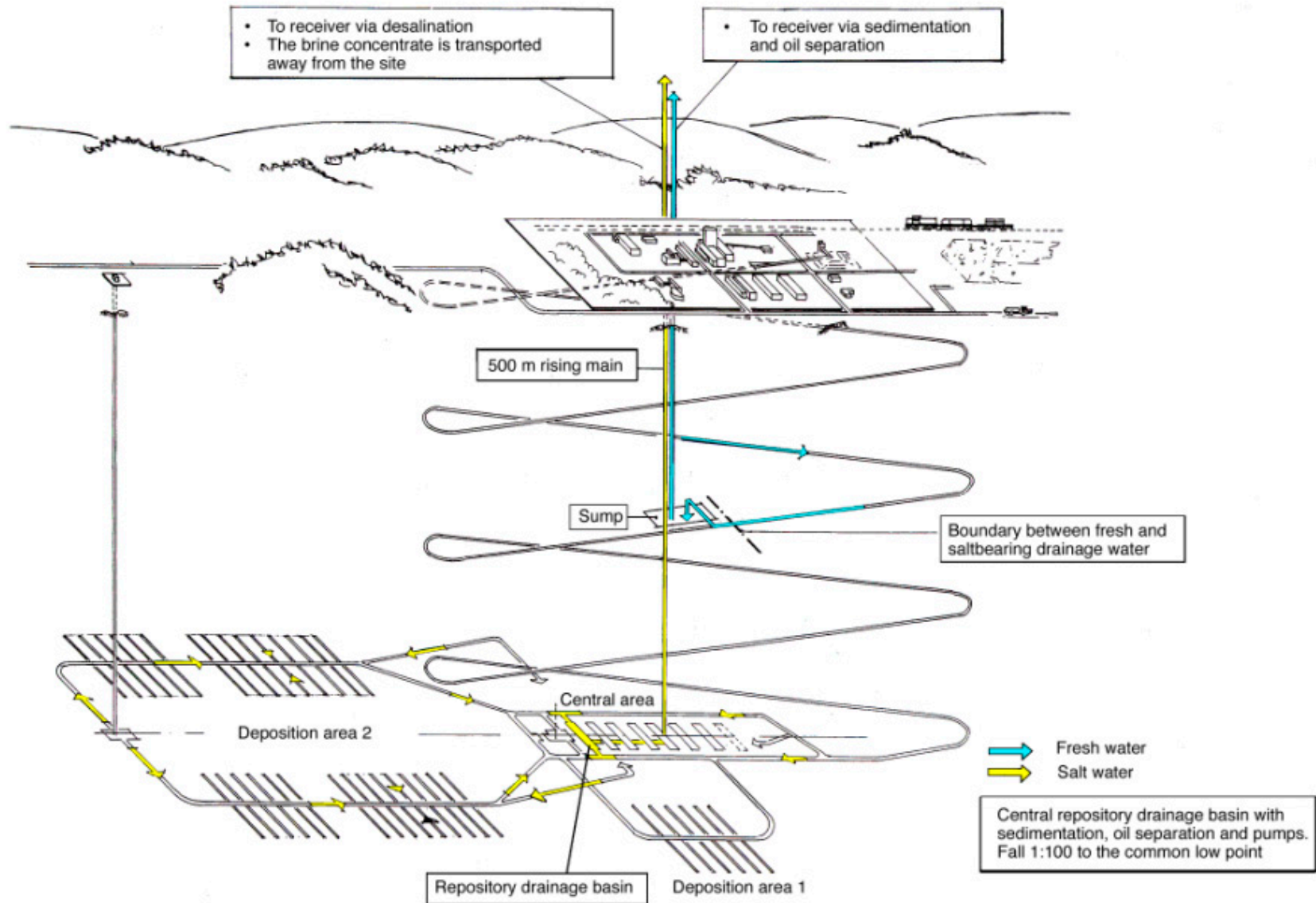

5 **GENERIC DESIGN –**
 DEEP REPOSITORY
5.10 **COMPARATIVE LAND REQUIREMENTS**

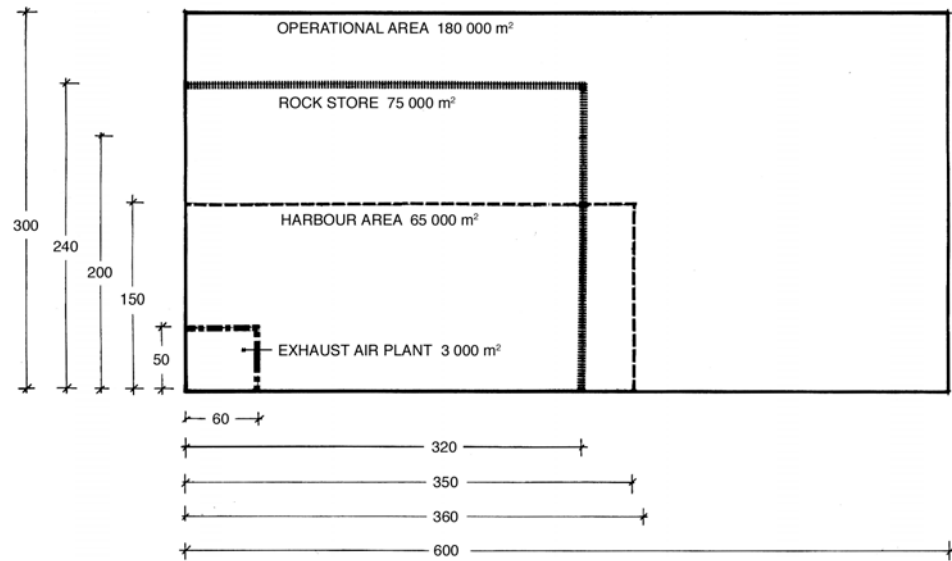

The adjoining figure shows all of the land required for the surface facilities of the deep repository.

The widths and lengths given correspond with relevant site arrangements in the other parts of the description.

- 6.1 General
- 6.2 Rock excavation and deposition work
- 6.3 Preparation of buffer and backfilling material
- 6.4 Servicing and maintenance
- 6.5 Information

6

OPERATIONS

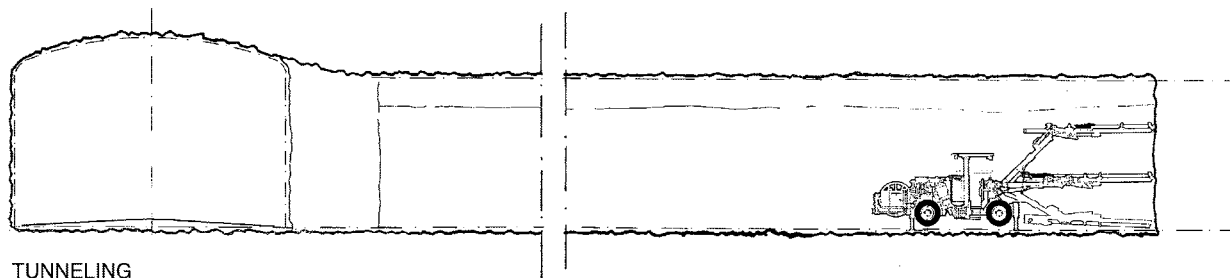

TUNNELING

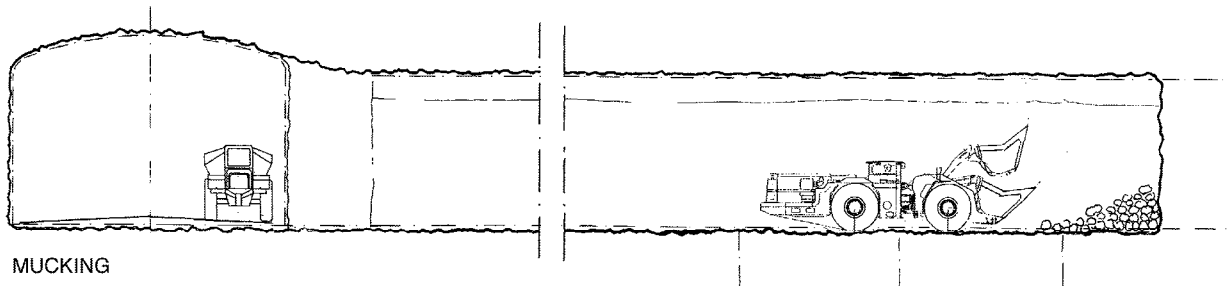

MUCKING

6. OPERATIONS

6.1 General

This section deals with the continuous operations in the deep repository during regular operation that influence the design of the facility.

The starting point for the account is that the surface facility has been fully constructed. During regular operation, deposition will take place on one side while the excavation work is going on in another area. The ring tunnel has been excavated as an investigation tunnel and the exhaust air shaft has been drilled.

6.2 Rock excavation and deposition work

This description exemplifies current thinking on rock excavation and deposition work. Technological development and more in-depth system studies could lead to a different procedure when the time comes to carry out the work.

The deposition tunnels are approximately 265 metres long and have a cross-sectional area of approximately 30 m². The tunnels will preferably be oriented perpendicular to the main tunnels. Conventional tunnelling, using drilling and blasting, is planned for this phase. The tunnel will be blasted out in two stages, top heading and bench, which will reduce the cracking of the floor of the tunnel.

After blasting, but before the rock is removed, the section of tunnel that has been blasted will be scaled. The scaling will be done by machine. The rock will be removed by a loading machine, into a dumper at the mouth of the tunnel. The loading machine drives in and collects the excavated rock material and then reverses out to load the dumper. The width of the tunnel does not permit the vehicles to turn. It is thought that the loading machine will be electrically driven, fed by a cable from an outlet at the mouth of the tunnel. The intention is that the dumper in this phase will be diesel-powered, to provide greater flexibility. After the excavated rock has been removed, inspection, geological mapping and any rock reinforcement work are carried out.

When the deposition tunnel has been excavated out, the vertical deposition holes for the canisters will be drilled. A special drilling machine (TBM machine) will be used for this. Each hole will be approximately 1.75 metres in diameter and approximately 8 metres deep.

6. OPERATIONS

6.3 Rock excavation and deposition work (cont.)

The work begins with core drilling in the intended positions for the deposition holes, in order to check that the rock is suitable. The position of the hole is marked on the roof of the tunnel. A levelling concrete slab, approximately 2.5 x 2.5 metres, is then cast above the position for each deposition hole. The purpose of this slab is to provide a level attachment point for the TBM machine and to prevent water running down into the deposition hole later. While this work is being done, the floor of the tunnel is levelled with macadam, in preparation for heavy loads.

Temporary installations for ventilation, electricity, lighting, drainage water etc. are carried out. Then the deposition holes are drilled, using the TBM machine. The TBM machine is centred over the hole and stabilised by hydraulic devices, which brace themselves against the roof and walls of the tunnel. The drill cuttings are collected up in containers, using a vacuum unit. All of the holes in the deposition tunnel will be drilled before deposition is started. Finally, a recess for the concrete sealing at the tunnel entrance is drilled.

When all of the holes in the deposition tunnel have been drilled, preparations are made for deposition. The TBM machine is moved to the next tunnel. The bottom of the deposition hole is screeded with concrete. The deposition machine is moved into the tunnel, driven to the end of the deposition tunnel and parked in readiness for receiving canisters.

Deposition starts with the hole at the far end of the tunnel. The hole is drained and cleaned, and a final check is made before the buffer material is put into position. There is a specially designed vehicle to do this. The vehicle brings a supply of bentonite blocks from the production building. The bentonite lining them will be checked. The vehicle is driven out the tunnel and parked in the main tunnel. When the canister has been deposited, the vehicle returns to the hole to put the remaining bentonite blocks in place. They will be placed above the canister, at the top of the hole. Thus, the vehicle will make two trips into the tunnel for each hole, to put the bentonite blocks in place.

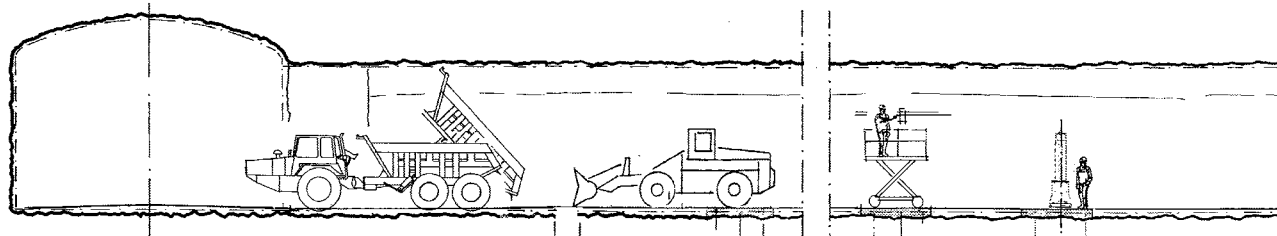

LAYING THE ROADWAY
INSTALLING SERVICE SYSTEMS
DRILLING PROBE HOLES FOR DEPOSITION HOLES

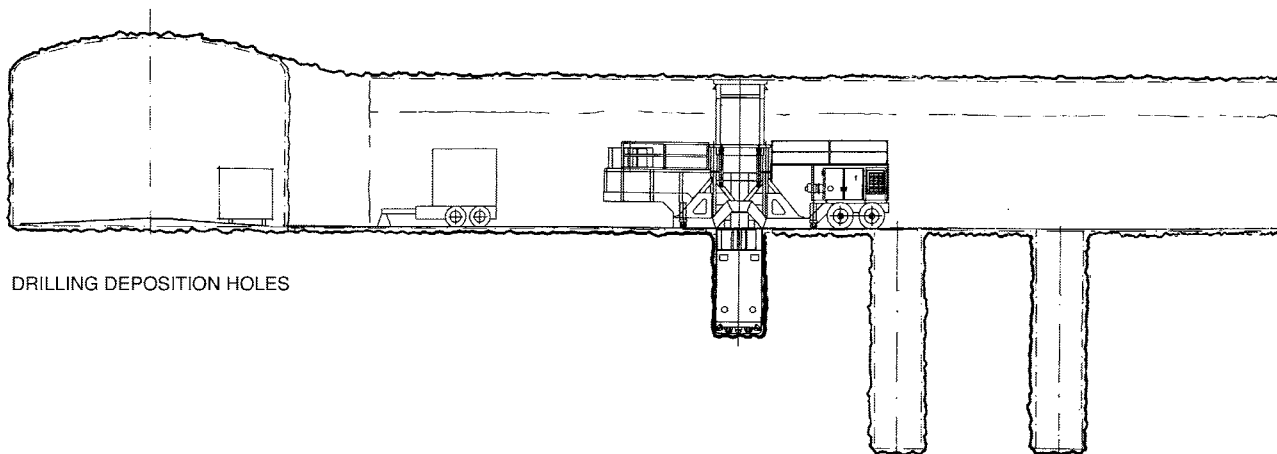

DRILLING DEPOSITION HOLES

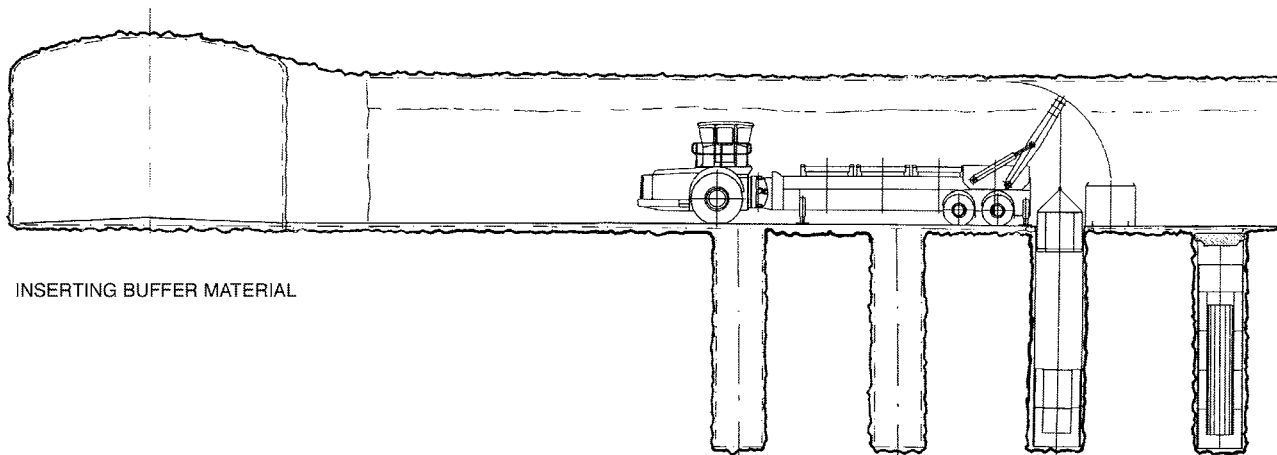

INSERTING BUFFER MATERIAL

6. OPERATIONS

6.2 Rock excavation and deposition work (cont.)

The transport vehicle brings a radiation shielding tube containing a canister from the reloading station and is driven into the deposition tunnel, to dock with the deposition machine. When the radiation shielding tube is in place in the deposition machine, the machine moves to the deposition hole, which has been prepared with buffer material. When the machine is in the correct position, the radiation shielding tube is split open inside the machine and the canister can be moved down into the deposition hole, surrounded by the radiation shielding provided by the deposition machine.

The deposition sequence ends with the deposition machine putting a bentonite block on top of the canister. While this procedure is being carried out, from docking to the canister being lowered into the hole, the staff in the deposition tunnel are protected from radiation by the radiation shielding tube, the shielding on the deposition machine and finally by the bentonite block on top of the canister. The remaining bentonite blocks, which are necessary to completely form the buffer, are put in place by the bentonite buffer vehicle. The deposition hole is then temporarily sealed, until the tunnel is backfilled.

When all of the deposition holes in a tunnel have been filled with canisters, the deposition machine is moved to the next deposition tunnel and the tunnel can be backfilled and sealed. Installations and the roadway are successively removed when the backfilling takes place. The backfilling material that will be used consists of a mixture of bentonite and crushed rock. The backfilling material will be transported in bulk by truck from the production building, down to the second transverse roadway. There, the material will be tipped into a hopper and a conveyor belt will fill the containers with backfilling material. The containers are transported to the deposition tunnel and are emptied into a backfilling machine. This machine deposits material using a feeding belt, and packs it using a vibrator.

The deposition tunnel will then be sealed with a concrete plug.

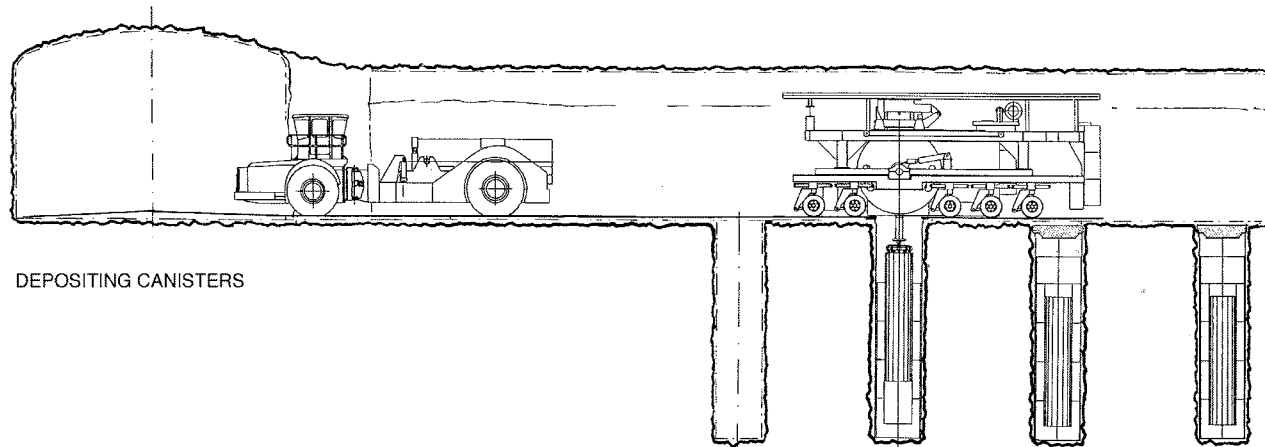

DEPOSITING CANISTERS

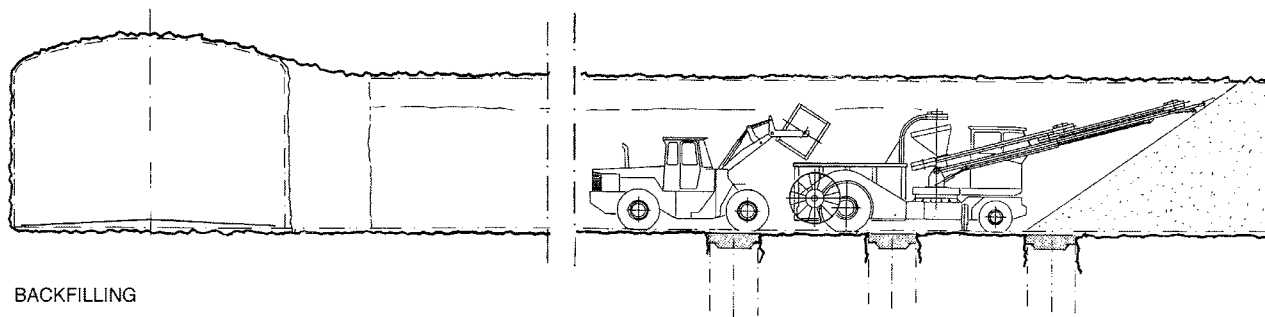

BACKFILLING

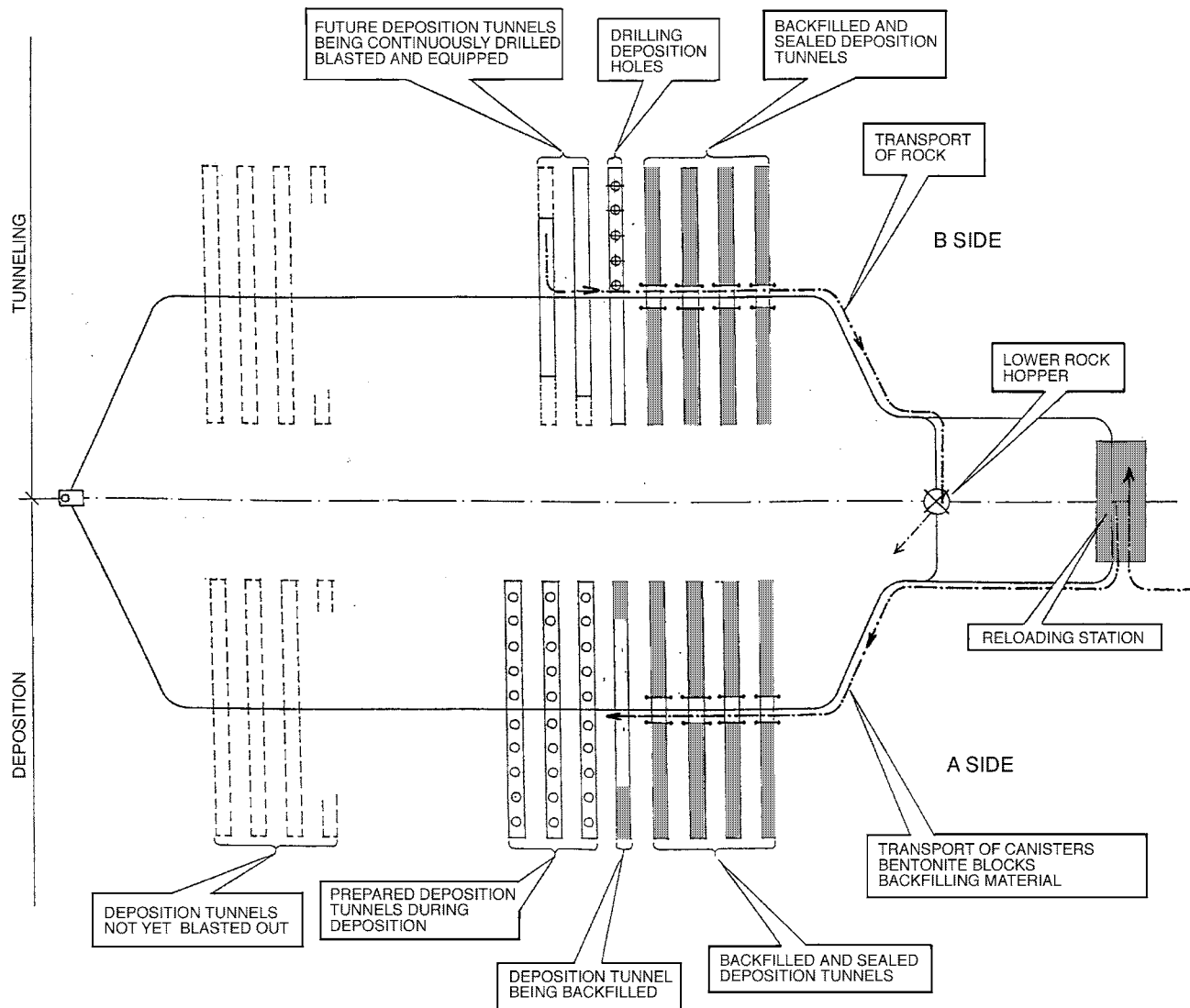

6. OPERATIONS

6.2 Rock excavation and deposition work (cont.)

As mentioned previously, the excavation and deposition operations have to be split into two separate areas. The reason for this is that each operation is so extensive that they should not be carried out along the same section of main tunnel.

The division into separate areas, each with its own transport tunnel from the central area, will reduce congestion considerably. In addition, the deposition work can be carried out in a cleaner environment.

In order for the operations to run smoothly during regular operation, it would be advisable to change sides once a year.

A decisive requirement for changing sides is that deposition tunnels in question will have been backfilled and sealed with concrete plugs when the changeover takes place. The reason for this is that the buffer material around the canisters will start to swell after deposition if there is water in the deposition hole. This means that backfilling of the tunnel in question must start immediately after the last canister has been deposited.

Backfilling must be carried out in a continuous process, without interruption.

STARTING POINT ON THE EXCAVATION SIDE

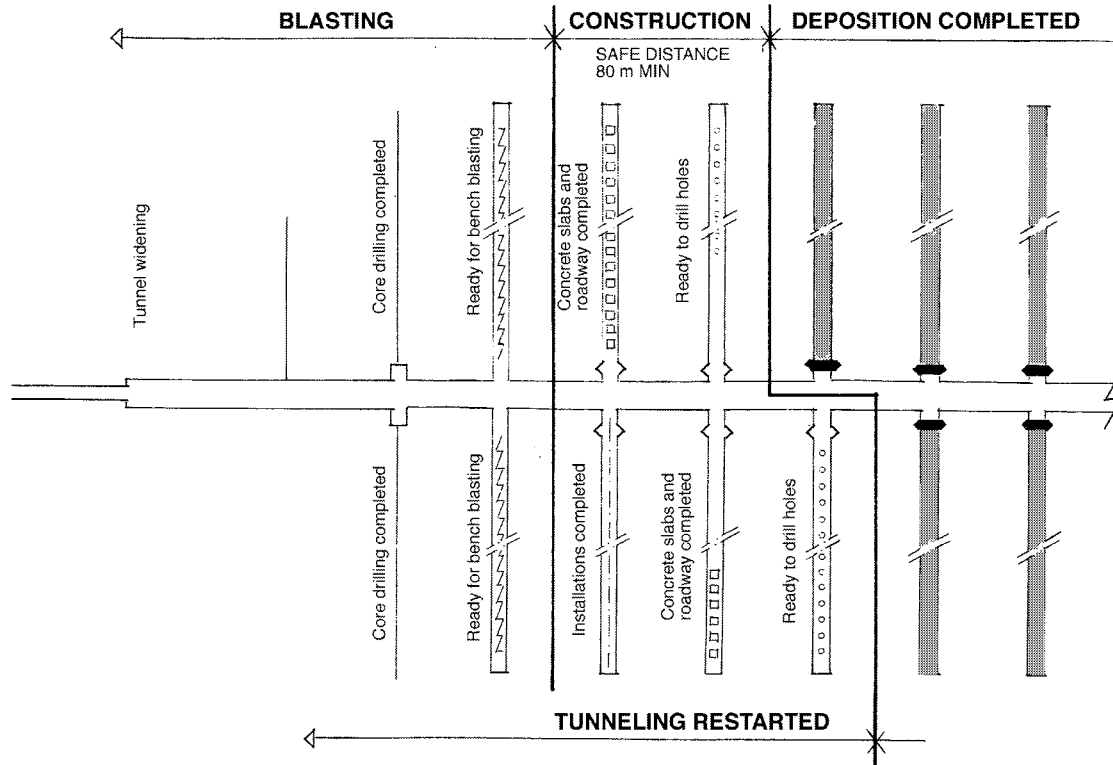

6. OPERATIONS

6.2 Rock excavation and deposition work (cont.)

Rock excavation side

The purpose of the work on the rock excavation side is to excavate and prepare tunnels ready for deposition at the prescribed rate.

The following stages are involved:

- Enlarging of the investigation tunnel into a main tunnel or transport tunnel.
- Core drilling for future deposition tunnels.
- Excavating top heading in deposition tunnels.
- Additional bench blasting in deposition tunnels.
- Drilling of recess for concrete plug
- Installation of service systems.
- Casting concrete slabs over deposition holes and laying a roadway.
- Drilling deposition holes.
- Checking.
- Screeding the bottom of deposition holes.

In order to make the work efficient, the various operations will have to be spread out over ten tunnels, in which work can be carried more or less simultaneously. When a stoppage is necessary in one tunnel, this can be compensated for by moving the resources involved to an adjacent tunnel. In this way, each team can be utilised continuously.

The work on the rock excavation side will probably require 30 people at a time.

The figure shows the situation on the rock excavation side at the time for the changeover.

STARTING POINT ON THE DEPOSITION SIDE

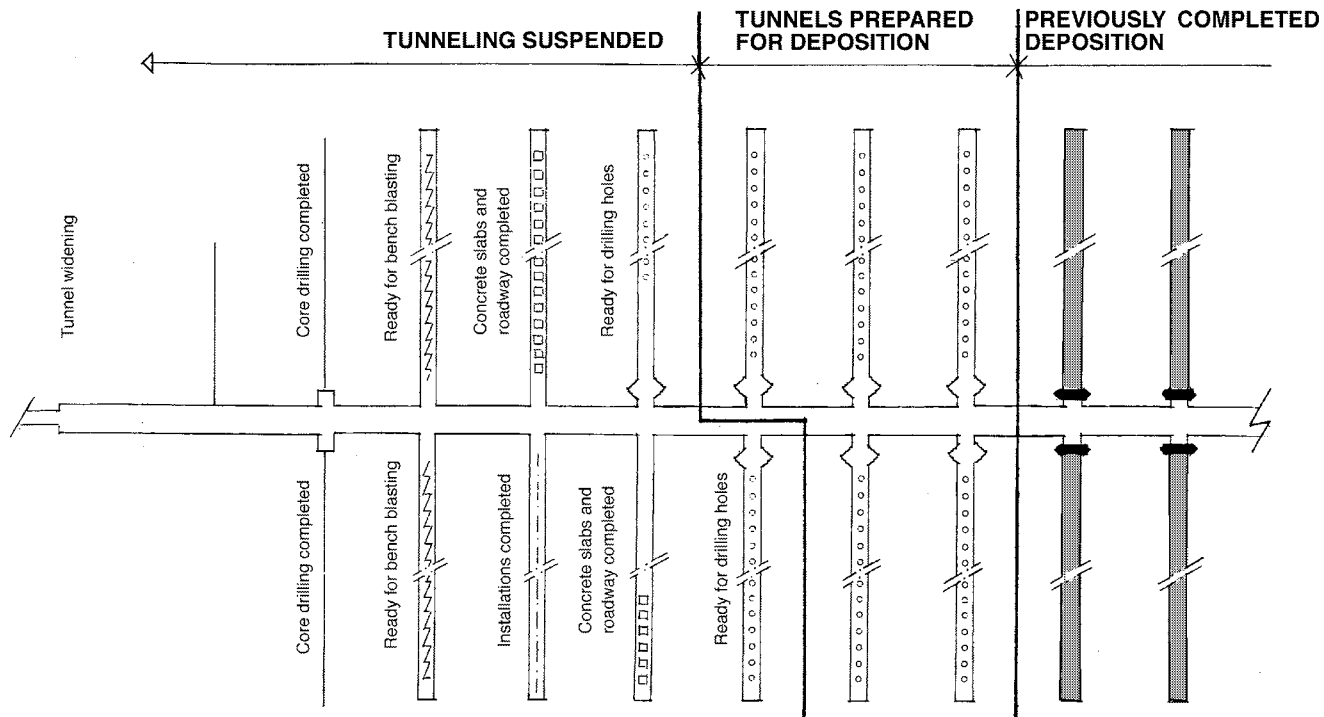

6. OPERATIONS

6.2 Rock excavation and deposition work (cont.)

Deposition side

The work on this side involves the actual deposition of the canisters.

The following stages are involved:

- The deposition holes are emptied of water.
- Each deposition hole is inspected and passed.
- Buffer material is brought in and put in place.
- Canisters are brought in and put in place.
- Stripping out service systems etc.
- Backfilling the deposition tunnel.
- Sealing by casting a concrete plug.

The schedule means that work on the deposition side will initially be limited solely to deposition. Backfilling can start when all approved deposition holes in a deposition tunnel have been filled with canisters. It is estimated that a maximum of 30 people will be working on the deposition side at the same time.

The figure shows the situation on the deposition side at the time for the change of side.

The planned rate of deposition involves five standard length tunnels with 40 deposition holes being filled each year.

6. OPERATIONS
6.3 PREPARATION OF BUFFER AND BACKFILLING MATERIAL

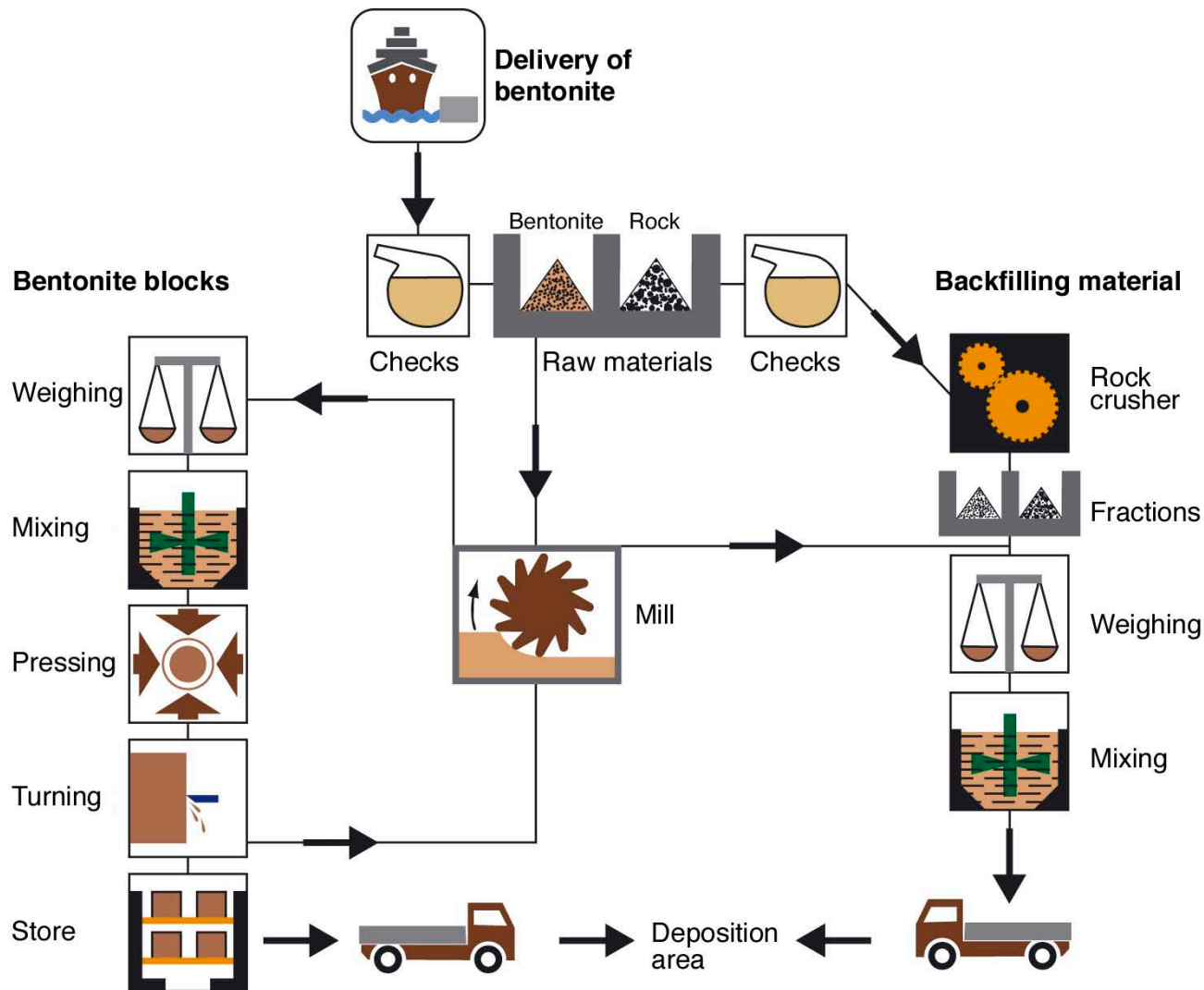

In the KBS-3 method, the canisters are surrounded by a barrier of compacted bentonite. In addition, when deposition of the canisters is complete, the deposition tunnels will be backfilled with a mixture of crushed rock and bentonite.

The method of storage of both of the materials are subject to requirements to maintain the required quality. It is thus essential that production take place near to the deep repository. This will provide the shortest possible lead-time between production and use.

The production can also keep pace with deposition, without interruption.

The flowchart to the left shows the planned work schedule.

The nature of the production is such that the work will be different from other operations at the deep repository. As long as the agreed quantities and times are adhered to, the work can be run more or less independently.

Much of the activity at the deep repository involves carrying out preventive maintenance and repairs for the entire facility. The following categories are involved.

CATEGORIES

1. Property services

- Buildings
Building, electrical, plumbing and heating, fitting out
- Groundwork
Roads, open spaces, railway yard, fences, gates, lighting, grassed areas, planted areas
- District heating
Production and distribution
- Water
Purification, distribution
- Sewage
Pipe network and treatment

2. Vehicles - special

- Large dumpers for transporting rock
- Vehicle for transporting transport cask
- Vehicle for transporting radiation shielding tube
- Vehicles for buffer material
- Fork-lift truck for 20' (10') containers
- Railway wagons for transport casks
- Railway wagons for bentonite

3. Vehicles - standard

- Trucks with a demountable body
- Tipper trucks with a crane
- Trucks with a concrete mixer
- Wheel loaders
- Hydraulic lift platform
- Light service vehicles
- Vehicles for transporting personnel
- Small dumpers for transporting rock

4. Machines

- Deposition machine for canister
- Isostatic press for buffer material
- Crushers
- Screens
- Mixers
- Drilling machine for deposition holes
- Filling machine for backfilling
- Vacuum equipment for collecting drill cuttings

5. Transport arrangements

- Belt conveyors
- Travelling cranes
- Telfers
- Elevators

6. Excavation machines

- Drilling machines
- Bolt drilling machine
- Excavator with hydraulic scaling rod
- Grouting equipment
- Shotcrete equipment
- Loaders
- Excavators

7. Gates/Doors

SYSTEM

- Electrical power
 - Transformers
 - Switchgear
 - Distribution network
 - Variator units
 - Auxiliary power unit
 - Collector rail for electric vehicles
- Lighting
- Ventilation
 - Fans
 - Dampers
 - Ducts
 - Filters
 - Noise suppressers
 - Heating batteries
- Repository drainage system
 - Pumps
 - Valves
 - Pipes
- Fire water
- Fire alarm
- Traffic signal system
- Telephones, alarm system, computer network etc.
- CCTV etc.

6. OPERATIONS

6.4 SERVICING AND MAINTENANCE

WORKSHOP AND STORAGE FACILITIES

The following workshop facilities are available for servicing and maintenance operations:

Mechanical workshop

For making spare parts and maintenance parts, prefabricating installation parts, welding etc.

Vehicle workshop

For servicing special vehicles and machines. Washing, changing oil, changing tyres, servicing batteries and general supervision.

Storage

Receiving and checking goods, forwarding, distribution within the facility and storekeeping. Store for core samples.

Workshop in the central area at the -500 metre level

For repair work on machines and installations. Base for work facility out in the underground facility.

Storage vault in the central area at the -500 metre level

Intermediate storage of building and installation materials.

OTHER

- Special vehicles and machines will be serviced by the supplier.
- Standard vehicles will be serviced by local workshops.
- The work of looking after, stripping out and reinstalling service systems in the deposition area is carried out by a separate group, which continually co-ordinates its operations with the rock excavation and deposition work.

Other maintenance is co-ordinated for the whole facility. Outside contractors will carry out major reconstruction and extensions.

6. OPERATIONS

6.5 INFORMATION

We assume that the deep repository will become a major tourist attraction. For many years, existing nuclear power plants have welcomed up to 20,000 visitors a year. Bearing this in mind, it is likely that the same interest will be shown in the deep repository.

This description proposes the following arrangements for receiving and informing both technical visitors and tourists.

The visitors will be received at the operational area, where there is an information building. The building will contain a reception area, offices for guides, an exhibition area, film and lecture theatre and group rooms. There will also be a foyer, with a cloakroom and toilets, and a canteen. The idea is that the visitors will be given a general introduction here, about the background to the operation and design of the deep repository.

After the introduction, visitors will have the opportunity to make study visits to the production building and the operations centre.

In the first of these facilities, visitors can study the production of buffer material and backfilling material. In the latter, the visitors can see the ongoing operations in the various parts of the facility being monitored on TV screens and panels. After that, they will be met by guides, who will take them in groups down to the deposition level.

The visitors will be given boots and hard hats in the elevator and the ventilation building. There are also cloakroom and toilets here.

After the journey down by elevator, the visitors will be assembled in the elevator vault, where they will have the opportunity to experience the underground environment.

The idea is that the guide will give a presentation of the underground area, with the aid of photographs and diagrams on a large screen.

It will also be possible for small groups to visit parts of the underground facility that are of particular interest, on condition that the work schedule permits.

The visitor operation will be co-ordinated with other operations.

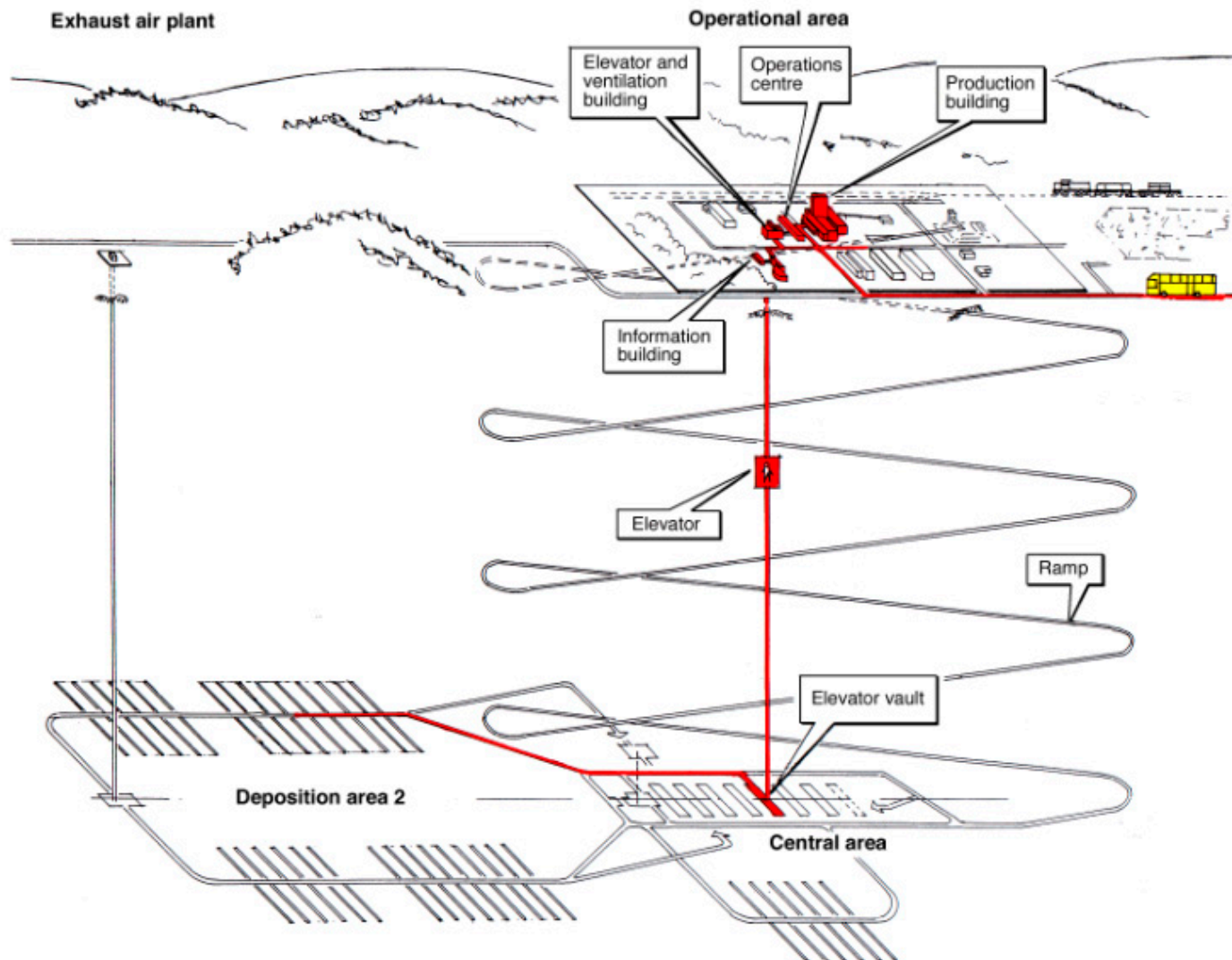

- 7.1 General
- 7.2 Transport casks containing canisters
- 7.3 Bentonite
- 7.4 Excavated rock masses
- 7.5 Backfilling material
- 7.6 Building material etc.
- 7.7 Transports in the ramp

7

TRANSPORT

7. TRANSPORT
7.1 GENERAL

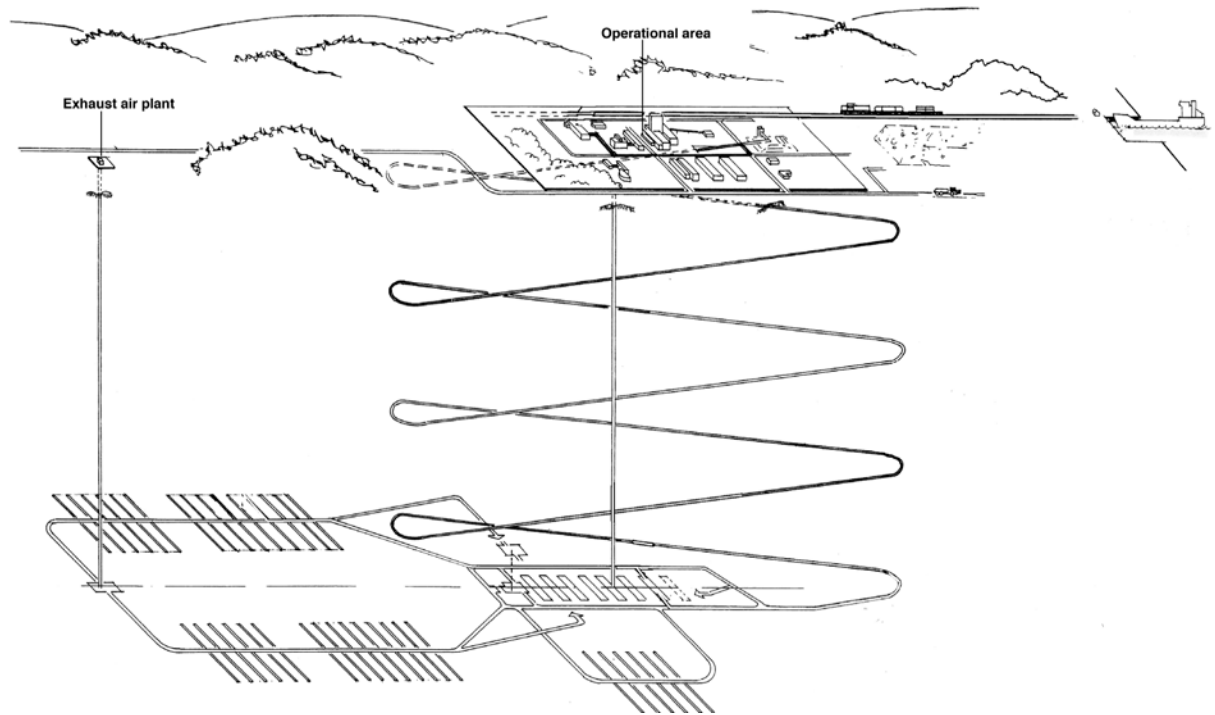

Requirements

The following products will need to be transported in the deep repository during regular operation:

LARGE AMOUNTS

- Transport casks containing canisters
- Bentonite in bulk
- Compacted bentonite blocks
- Excavated rock material
- Backfilling material
- Concrete
- Crushed rock/macadam

LIMITED AMOUNTS

- Building material
- Installation material
- Explosives
- Diesel fuel

OTHER

- Material for servicing/maintenance
- Facility staff
- Visitors

Assumptions

- Transport casks containing canisters and bulk bentonite will be transported by specially constructed ships to a suitably situated harbour.
- It is assumed that the deep repository will be located inland.
- It is assumed that transport casks containing canisters and bulk bentonite will be transported from the harbour to the operational area by rail.

Scope

The following pages, 7-2 to 7-6, describe the transport logistics for the planned transport requirements. The logistics cover transport from the harbour via the operational area to the deposition area at the 500-metre level.

Page 7-7 contains an account of transports in the ramp.

See chapter 8 for details of the vehicles.

7. TRANSPORT
7.2 TRANSPORT CASKS CONTAINING
CANISTERS

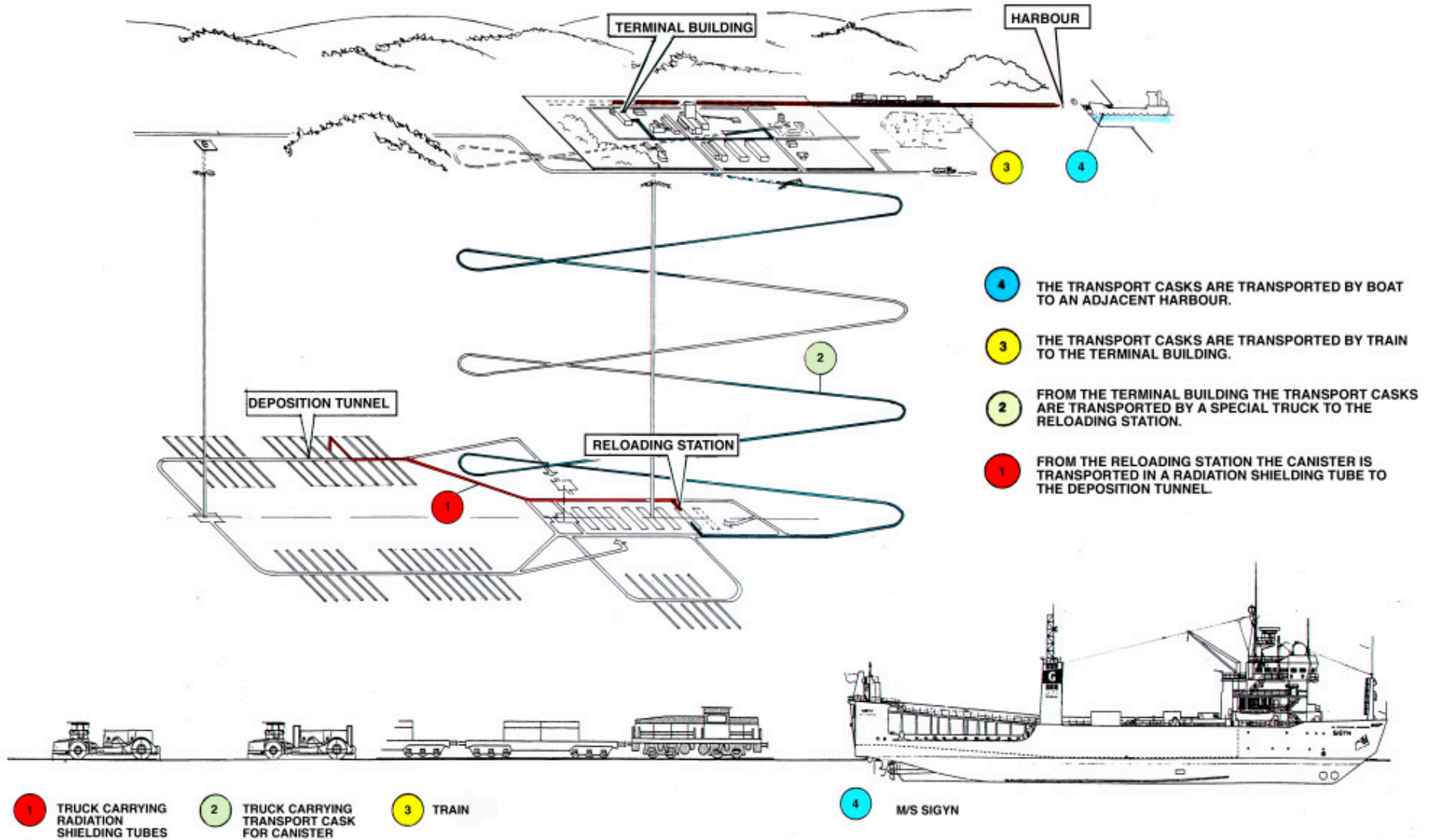

- 4 THE TRANSPORT CASKS ARE TRANSPORTED BY BOAT TO AN ADJACENT HARBOUR.
- 3 THE TRANSPORT CASKS ARE TRANSPORTED BY TRAIN TO THE TERMINAL BUILDING.
- 2 FROM THE TERMINAL BUILDING THE TRANSPORT CASKS ARE TRANSPORTED BY A SPECIAL TRUCK TO THE RELOADING STATION.
- 1 FROM THE RELOADING STATION THE CANISTER IS TRANSPORTED IN A RADIATION SHIELDING TUBE TO THE DEPOSITION TUNNEL.

7. TRANSPORT
7.3 BENTONITE

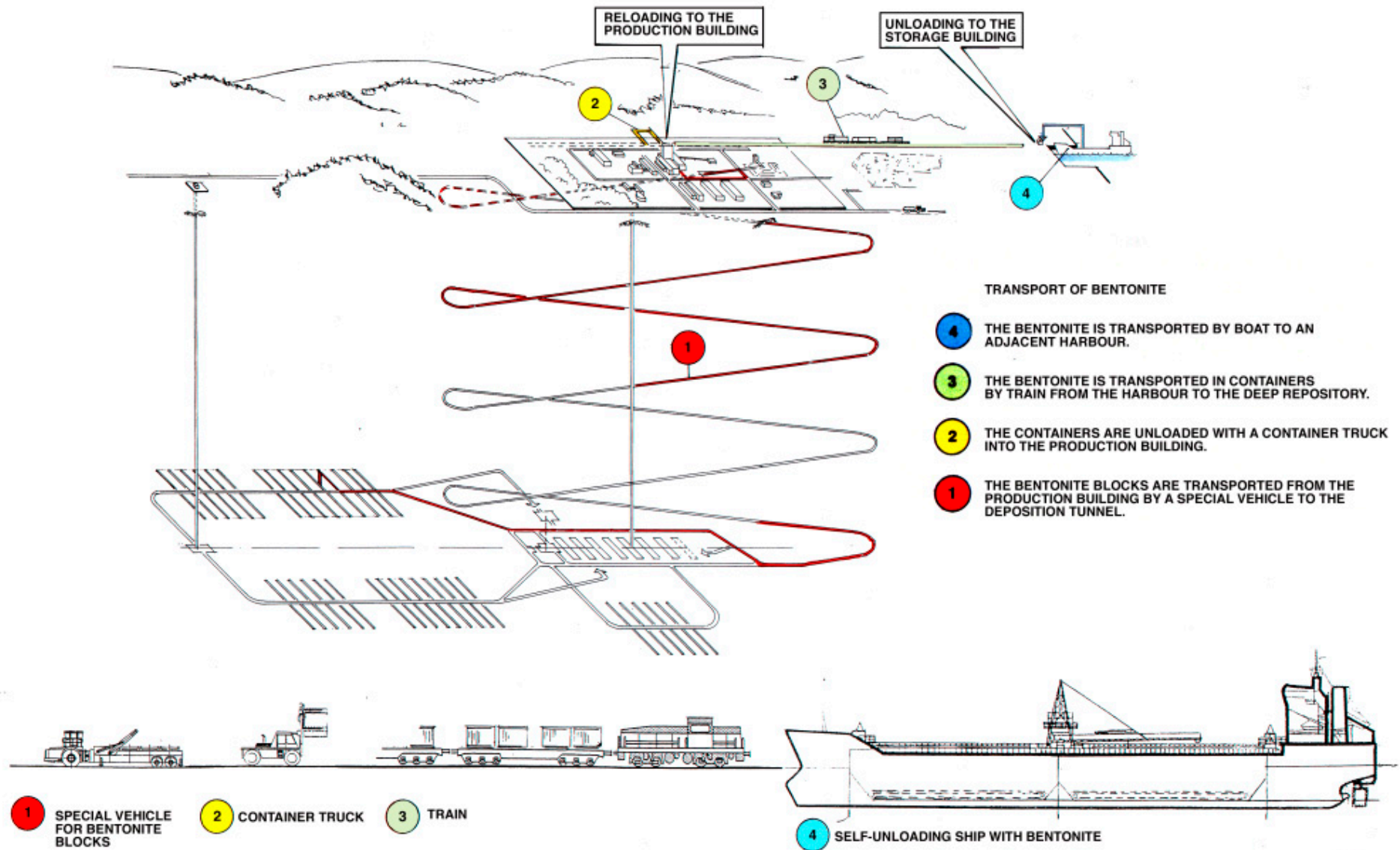

7. TRANSPORT
7.4 EXCAVATED ROCK MASSES

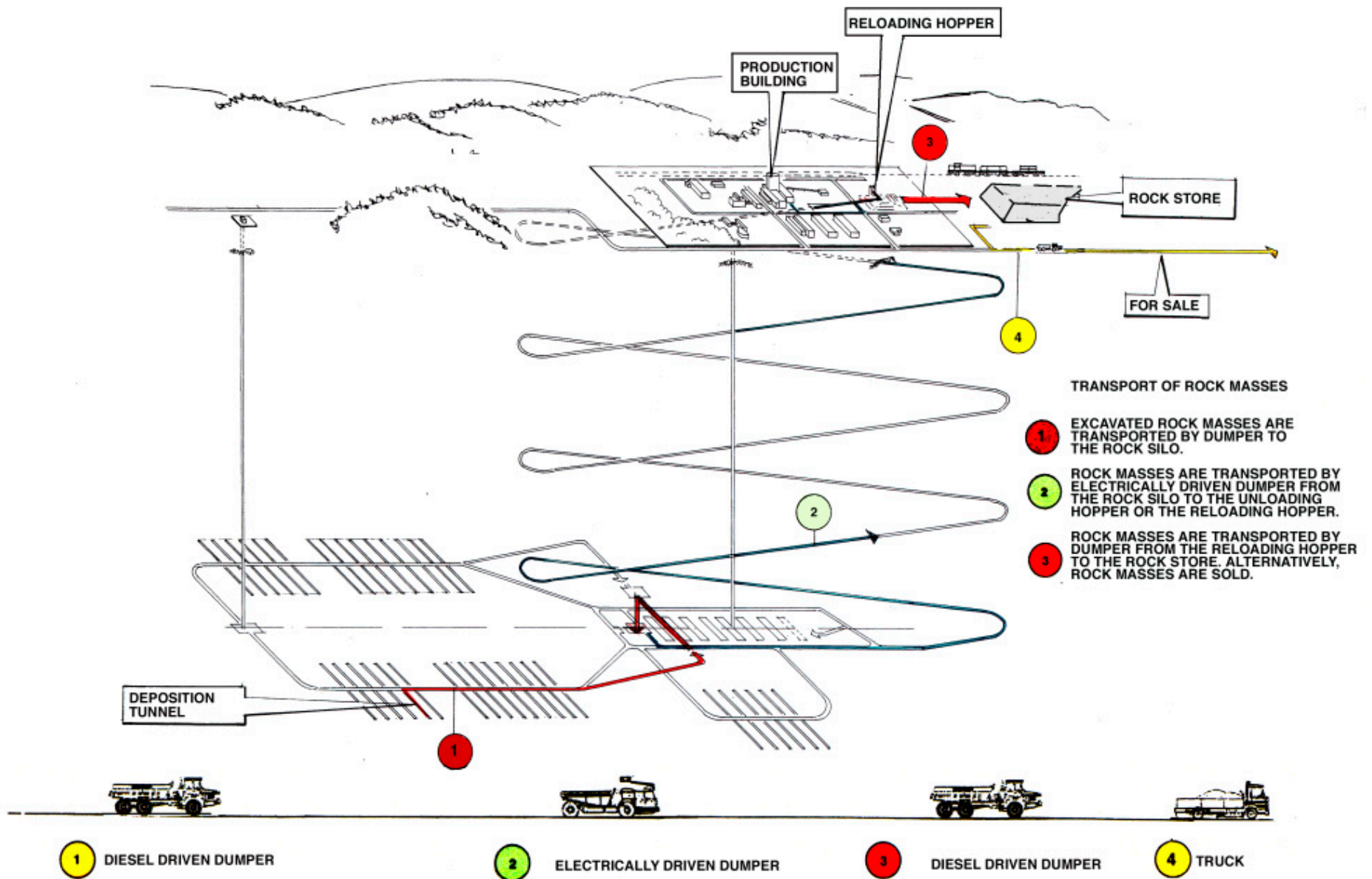

7. TRANSPORT
7.5 BACKFILLING MATERIAL

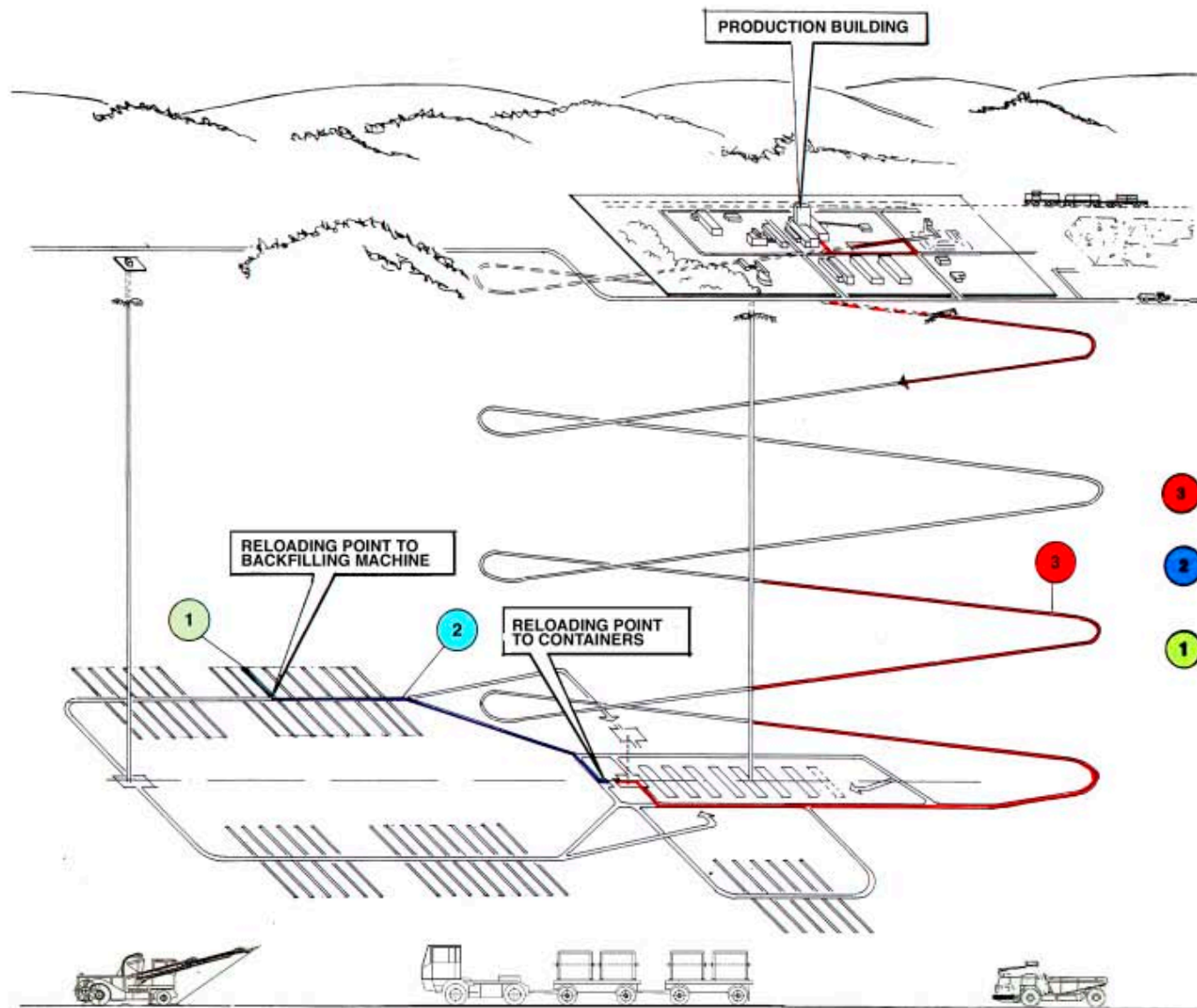

TRANSPORT OF BACKFILLING MATERIAL

- 3** BACKFILLING MATERIAL IS TRANSPORTED BY DUMPERS FROM THE PRODUCTION BUILDING TO THE RELOADING POINT, WHERE THE MATERIAL IS FILLED IN CONTAINERS.
- 2** THE BACKFILLING MATERIAL IS TRANSPORTED IN CONTAINERS FROM THE RELOADING POINT TO THE DEPOSITION TUNNEL.
- 1** THE CONTAINERS ARE TRANSPORTED TO THE BACK-FILLING MACHINE WHICH WILL DEPOSIT THE BACK-FILLING MATERIAL.

1 BACKFILLING MACHINE

2 VEHICLE WITH CONTAINER WAGONS

3 ELECTRICALLY DRIVEN DUMPER

7. TRANSPORT
7.6 TRANSPORTS IN THE RAMP

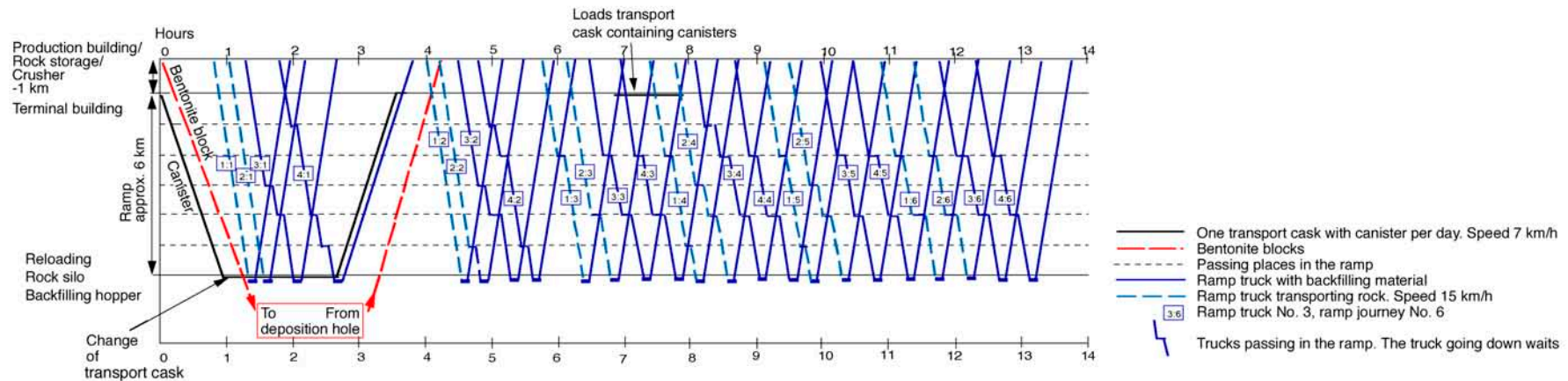

The diagram above shows a typical example of the traffic in the ramp to the deposition level.

The traffic that is directly related to the operation is made up of trucks for:

- Transport casks containing canisters.
- Bentonite blocks.
- Excavated rock and backfilling material.

In addition to this traffic, there are vehicles for construction work and installations, servicing and maintenance and to some extent for staff. These appear rather irregularly, and are not shown in the diagram.

Explanation of the diagram

The traffic is controlled so that rock and backfilling material are transported along the ramp without disrupting the trucks carrying canisters and bentonite.

At the starting point of the diagram, time 0, it is assumed that the canister truck is loaded with a transport cask, and the bentonite truck

with bentonite blocks. They start at the same time from the terminal building, black solid line, and the production building, red dashed line, respectively. The speed has been set at 7 km/h for both. The bentonite truck is approximately one km behind the canister truck. It then takes approximately one hour for the trucks to reach their destination, the reloading station for the canister truck and the deposition tunnel for the bentonite truck.

In the reloading station, the transport cask is unloaded and an empty cask is loaded onto the truck. The time for the load changeover is shown as two hours on the diagram. The truck then returns along the ramp to the terminal building, where a new cask is loaded ready for the next day's ramp trip.

The bentonite truck goes to the current deposition tunnel.

When the canister and bentonite trucks are down in the ramp, the four rock trucks can start their first trips along the ramp. They are shown in the diagram by dashed turquoise and solid blue lines. The downward trips are marked 1:1 to 4:1. The first figure is the number of the truck, 1-4, and the second is the trip number for the truck that day.

Trips 1:1 and 2:1, dashed turquoise, show trucks loaded with backfilling material, the other two, 3:1 and 4:1, solid blue, travel down the ramp empty. The distance between the first two is determined by the loading time for the backfilling material. The time can be chosen more freely for the last two.

At the deposition level, the loads from two trucks will be emptied into the hopper for backfilling material and all of them will be loaded with rock from the rock silo. The time for these activities is indicated on the diagram by a thick, horizontal blue line, which takes between five and ten minutes. These trucks travel at 15 km/h and can each manage one ramp trip before the canister and bentonite trucks return. The fourth truck follows immediately after the canister truck on the upward trip.

The rock trucks can then make new ramp trips. The rock trucks can each manage six trips in 14 hours. The last trips of the day are designated 1:6 and 4:6.

The rock trucks are permitted to pass one another in the ramp. The ramp has five passing places, which are indicated on the diagram by dashed, horizontal lines. The passing operation is shown on the diagram as one or more notches in the blue (turquoise) line.

- 8.1 General
- 8.2 Vehicles
- 8.3 Machines

8

VEHICLES AND MACHINES

8. VEHICLES AND MACHINES

8.1 General

Transport constitutes a substantial proportion of the activity in the deep repository. Section 7.7 contains an account of the planned logistics for the majority of the transport operations. This section contains detailed information about each type of vehicle that will be required for transport.

The summary contains information about both standard vehicles and special vehicles. Some of the special vehicles have not been constructed yet.

Bearing in mind that about ten years will elapse before the transport requirements for operating the deep repository will arise, the vehicles in use then could look different, which is why these illustrations should be seen as examples.

The dimensions and capacities of the vehicles shown form the basis for this facility description. The information about the number of vehicles of each type required has been based on the rate of deposition of the deep repository.

In this report, it has been assumed that regular, heavy transport will, for environmental reasons, be carried out by electrically driven vehicles, as follows:

- Canisters from the terminal building to the current deposition tunnel via the reloading station in the central area.
- Compacted bentonite blocks between the production building and the current deposition tunnel.
- Rock from the rock silo in the central area on the deposition level to the rock stockpile unloading point or the production building on the surface.
- Backfilling material from the production building to the reloading point in the central area on the -500 metre level.

It is assumed that passenger transport and light service transport on the -500 metre level will use battery-driven vehicles, stationed in the central area.

Power distribution for the electric vehicles is described in section 11.7 for the operational area, and in section 15.12 for the -500 metre level.

Other transport will be carried out using diesel-driven vehicles, fitted with exhaust cleaning and dust extraction systems.

Articulated dumper truck

Vehicle for transporting rock from deposition tunnels to the rock silo in the central area.

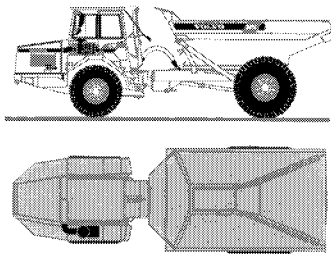

Load capacity = 22 tons
Length = about 8.95 m
Width = about 3.18 m
Height = about 3.16 m
Gross vehicle weight = 40 tons
Method of propulsion = diesel
Turning radius = 7.8 m
Quantity = 3
Standard design

Truck for transport cask

Vehicle for transporting transport cask containing canister, from the surface to the reloading station on the - 500 metre level.

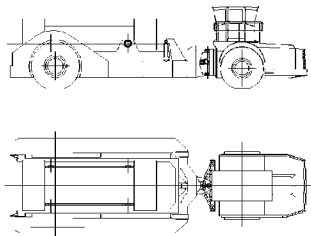

Load capacity = 80 tons
Length = about 13.5 m
Width = about 4.25 m
Height = about 3.8 m
Gross vehicle weight = 120 tons
Method of propulsion = electric
Turning radius = 7.7 m
Quantity = 2
Special design = rear section with transport frame

Truck for radiation shielding tube

Vehicle for transporting radiation shielding tube containing canister, from the reloading station to the deposition tunnels on the - 500 metre level.

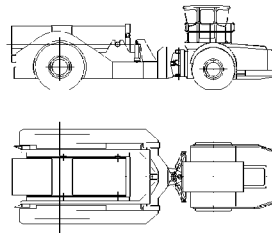

Load capacity = 60 tons
Length = about 12.3 m
Width = about 4.25 m
Height = about 3.8 m
Gross vehicle weight = 100 tons
Method of propulsion = electric
Turning radius = 7.7 m
Quantity = 1
Special design = rear section with integrated unloading platform

Vehicle with wagons for containers

Vehicle for transporting containers of backfilling material from the reloading hopper on the - 500 metre level to the deposition tunnel

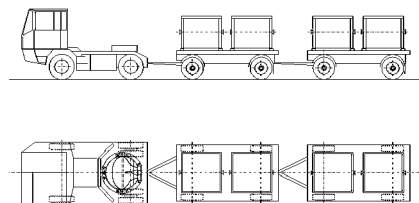

Load capacity = 25 tons
Length = about 20 m
Width = about 2.6 m
Height = about 3.2 m
Gross vehicle weight = 35 tons
Method of propulsion = electric or diesel
Turning radius = 10 m
Quantity = 2

8. VEHICLES AND MACHINES
8.2 VEHICLES

Articulated dumper truck

Vehicle for transporting rock from the -500 metre level to the production building on the surface, and for returning backfilling material down to the reloading hopper on the -500 metre level.

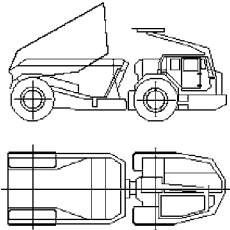

Load capacity = 50 tons
 Length = about 10.8 m
 Width = about 3.5 m
 Height = about 3.3 m
 Gross vehicle weight = 85 tons
 Method of propulsion = electric
 Turning radius = 7.8 m
 Quantity = 4
 Standard design

Special vehicle for bentonite blocks

Vehicle for transporting bentonite blocks from the production building on the surface down to the deposition tunnel on the -500 metre level. The vehicle will also lift the units down into the deposition holes.

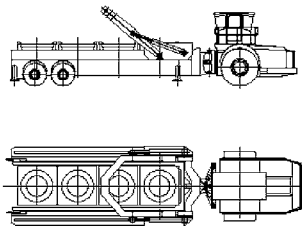

Load capacity = 25 tons
 Length = about 14.8 m
 Width = about 4.0 m
 Height = about 3.8 m
 Gross vehicle weight = 55 tons
 Method of propulsion = electric
 Turning radius = 7.8 m
 Quantity = 1
 Special design with rear section with a crane and transport frame

Concrete truck with mixer

Vehicle for transporting concrete from the concrete station on the surface down to casting location on the -500 metre level.



Load capacity = 15 tons
 Length = about 10 m
 Width = about 2.5 m
 Height = about 3.8 m
 Gross vehicle weight = 25 tons
 Method of propulsion = diesel
 Turning radius = 11.8 m
 Quantity = 1
 Standard design

Tractor loader

Vehicle for various work on the -500 metre level.



Load capacity = 5 tons
 Length = about 10 m
 Width = about 2.5 m
 Height = about 3.8 m
 Gross vehicle weight = 12 tons
 Method of propulsion = diesel
 Turning radius = 12 m
 Quantity = 1
 Standard design

Forklift truck

Vehicle for unloading and loading containers filled with bentonite.

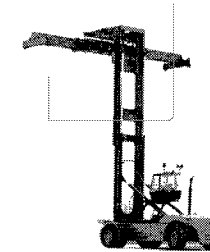

Load capacity = 36 tons
 Length = about 8 m
 Width = about 2.6 m
 Height = about 3.5 m
 Gross vehicle weight = 84 tons
 Method of propulsion = diesel
 Turning radius = about 5 m
 Quantity = 1
 Standard design

Truck

Vehicle for transporting building material etc. to the facility and down to the -500 metre level.

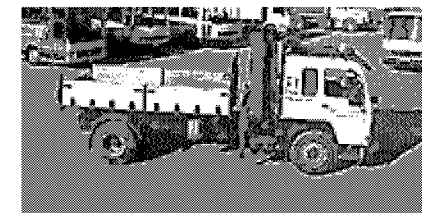

Load capacity = about 10 tons
 Length = about 10 m
 Width = about 2.4 m
 Height = about 3.6 m
 Gross vehicle weight = 8 tons
 Method of propulsion = diesel
 Turning radius = 11 m
 Quantity = 1
 Standard design with crane

8. VEHICLES AND MACHINES

8.3 MACHINES

Mobile drilling unit for vertical, full face boring

Drilling machine for deposition holes.

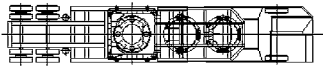
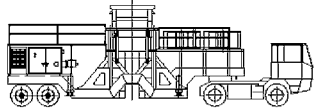

Length = about 13.8 m incl. Sisu truck
Width = about 2.5 m
Height = about 3.7 m
Gross vehicle weight = 45 tons
Method of propulsion = electric / diesel
Quantity = 2
Special design

Self-propelled deposition machine with rubber wheels

Deposition machine for depositing canisters. The machine is fitted with complete radiation shielding.

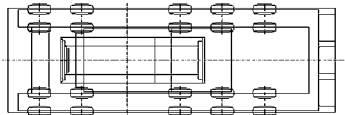
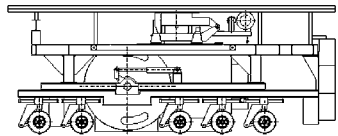

Length = about 11.6 m
Width = about 4.1 m
Height = about 4.6 m
Gross vehicle weight = 160 tons
Method of propulsion = electric
Quantity = 1
Special design

General

The regular operation of the deep repository requires a number of machines to be available, for excavating and preparing new deposition tunnels, and for actually depositing the canisters. In addition, there will be machines for maintaining the facility.

The machinery for excavating new deposition tunnels consists of conventional, standard machines, adapted for the required function, capacity and size.

It is assumed that machines with comparatively stationary operation will be electrically driven. However, diesel propulsion is acceptable for moving between workplaces.

Machines for drilling the deposition holes and for depositing the canisters will be specially designed for their tasks. These types of machine will be electrically driven.

This section gives information for current solutions.

Backfilling machine

Backfilling machine for the deposition tunnel, with conveyor and compactor.

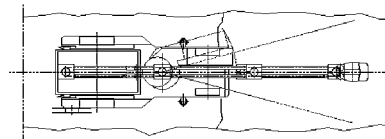
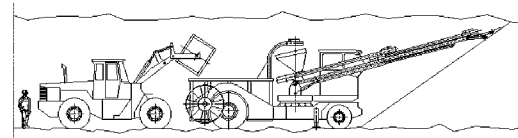

Length = about 11.5 m
Width = about 4.0 m
Height = about 4.2 m
Gross vehicle weight = 50 tons
Method of propulsion = electric
Quantity = 1
Special design

8.
8.3

VEHICLES AND MACHINES
MACHINES

Rock drilling rig

E.g. Tamrock Axera T 10 DATA-312

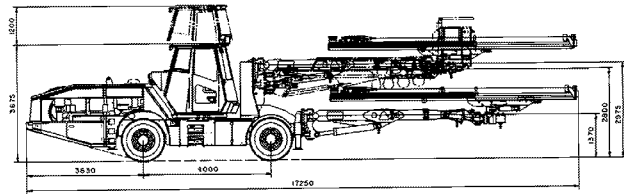

Length = about 17.2 m
Width = about 2.9 m
Height = about 3.7 m
Gross vehicle weight = 39 tons
Method of propulsion = electric
Quantity = 1

Scaling hammer

Electrohydraulic hammer, e.g. Brock 330S, for scaling tunnels and rock vaults

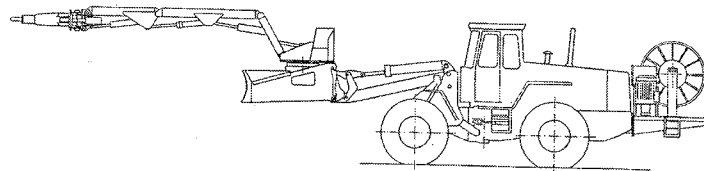

Length = about 3.5 m
Width = about 1.2 m
Height = about 1.6 m
Gross vehicle weight = 3 tons
Method of propulsion = electric
Quantity = 1

Loader

Loader, e.g. TORO 1400, for mucking rock at the excavation area.

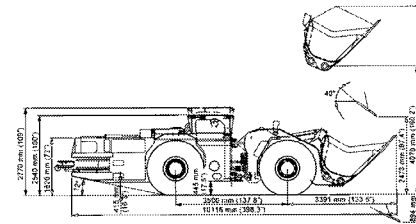

Length = about 10 m
Width = about 2.7 m
Height = about 2.8 m
Load capacity = 14 tons
Gross vehicle weight = 48 tons
Method of propulsion = electric
Turning radius = 6.7 m
Quantity = 2

- 9.1 General
- 9.2 Organisation
- 9.3 Staff

9. STAFF - ORGANISATION

9.1 GENERAL

Staff

There will be a total staff of approximately 130 at the deep repository, during the initial operation. During regular operations, the number will be approximately 215.

In order to ensure that the design of the facility will work well for all required functions and operations, a plan has been drawn up regarding the scope and method of the work. In addition, a proposed organisation and staffing plan has been prepared. This organisational plan forms the basis for the design of permanent buildings.

Short, staff-intensive phases in the expected life of the facility will be covered by temporary arrangements.

Assumptions

- The facility will be built with the help of contractors.
- SKB will set up a project organisation for the construction of the facility.
- SKB will set up an organisation to manage, operate and maintain the facility.
- In the introductory phase of the facility, the above-mentioned organisations will be working at the site simultaneously.
- SKB will carry out the excavation work using its own personnel during the operating phase of the facility.
- The work will generally be performed during the day. However, the underground excavation for the chosen rate of deposition will require working in shifts.
- The facility will be guarded 24 hours a day, throughout the year, by staff based at the facility.
- For security reasons, the operations centre will always be manned when staff are below ground.
- The operating staff will be located in the management centre.
- Other categories of staff will, as far as possible, be located in or have their base in the office and workshop building.
- The operating organisation will be responsible for transports between the receiving harbour and the deep repository, with regard to planning and traffic.
- The operating organisation at the deep repository will also be responsible for the operation and maintenance of the facilities at the receiving harbour.
- Operation of the railway can be bought in.
- Maintenance of rolling stock can be bought in.
- Operation of the restaurant will be bought.
- The maintenance of the facility will be carried out using the following main division:
 - Systems - machines - equipment
 - Vaults - tunnels
 - Buildings
- The facility will be shut down during holiday periods.
- Major work on the facility, such as overhauling the elevator machinery or equivalent activities should be planned to take place during these periods.
- Canisters will be deposited for approximately 40 weeks a year. The facility has been designed for a deposition rate of 200 canisters a year.
- The assumptions of staff requirements in this phase are based on preliminary information.

9. STAFF - ORGANISATION
9.2 ORGANISATION

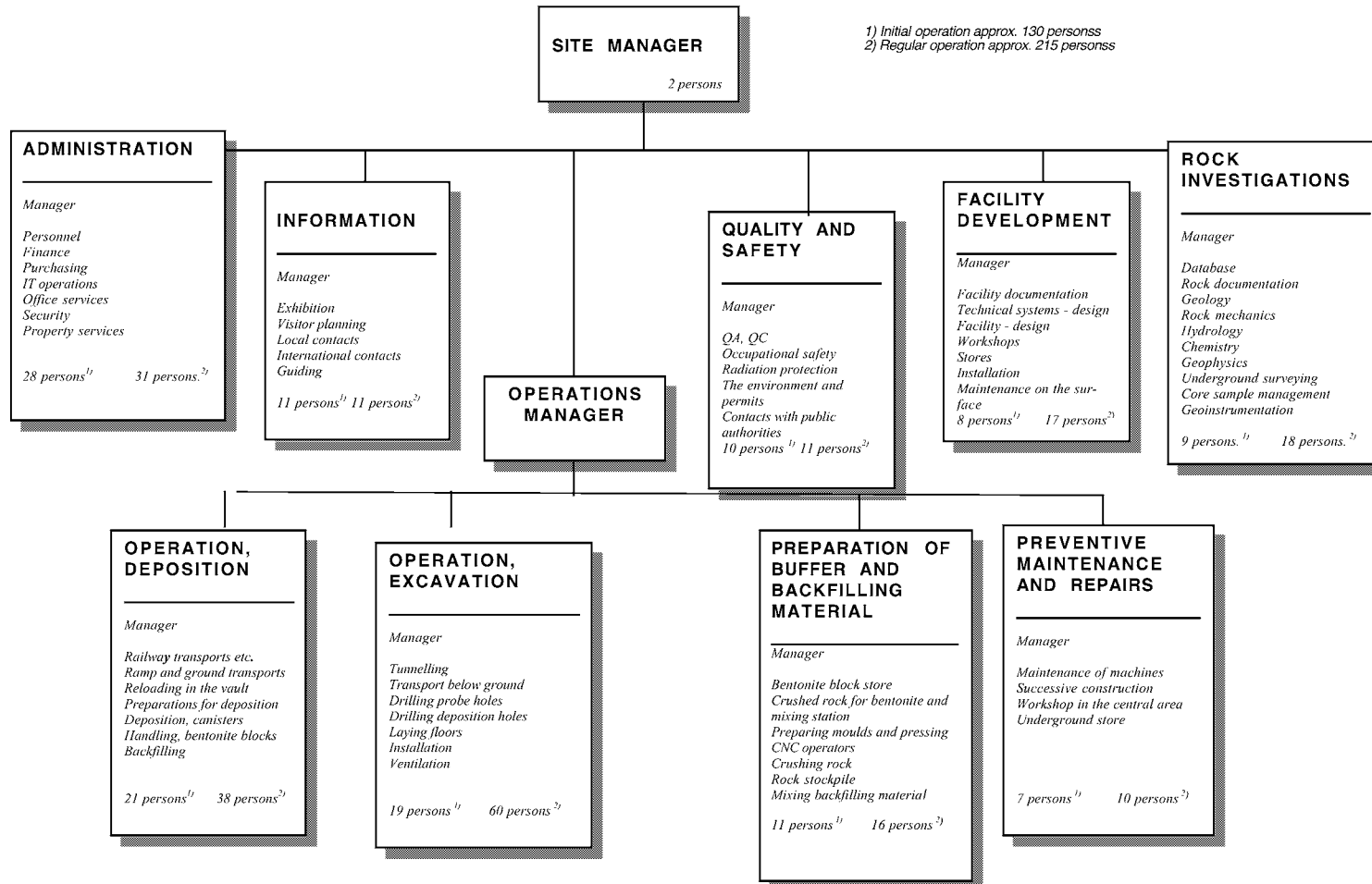

9. STAFF - ORGANISATION
9.3 STAFF

Administration

Function	Activity	Initial operation	Regular operation
Manager	Management, co-ordination, planning, finances, resources, training	1	1
Personnel	Wages, training, staff care, health care	3	3
Finance	Budget, follow-up, accounting, invoicing, invoice processing, project finances, tax issues, cash	2	2
Purchasing	Goods, services	1	1
IT operations	Computer service, program development	2	2
Office services	Post room, telephone exchange, reprographics, archive, library, office materials, furniture	3	3
Security	Authorisation checks, area protection, rescue service	10	10
Property services	Cleaning, gardening, road maintenance, snow clearing, service transport above ground, refuse collection, property maintenance, laundry	4	6
Absenteeism reserve	Guarding, servicing	2	3
Total number of persons		28	31

Facility development

Function	Activity	Initial operation	Regular operation
Manager	Management, co-ordination, design, project management for extensions and additions	1	1
Facility documentation	Follow-up and documentation of deposition and the facility, buildings, systems, machines, components	1	2
Technical systems - design	Mechanical and electrical design, electronics	1	3
Facility – design	Developing facility systems and components	1	2
Workshops	Skilled repair work on steel structures, welding and forging, electrical and electronic work	2	3
Store	Forwarding, internal distribution, storekeeping	1	2
Installation	Own installation work, installation checks, test running	1	2
Maintenance above ground	Elevators, travelling cranes	1	2
Total number of persons		8	17

Rock investigations

Function	Activity	Initial operation	Regular operation
Manager	Management, co-ordination	1	1
Exhibition	Reception, maintenance and development of exhibition	2	2
Visitor planning	Planning visitor traffic	2	2
Local contacts	Co-ordination with the district administration, local info meetings	1	1
International contacts	Information to foreign authorities, Following up foreign experiences	2	2
Guiding	Transport, tours, catering	3	3
Total number of persons		11	11

Function	Activity	Initial operation	Regular operation
Manager	Management, co-ordination, planning, development, finance, resources, training	1	1
Database	Documentation, computer technology	1	1
Rock documentation	Geoscientific data	1	4
Geology	Mapping, evaluation, assessment	1	3
Rock mechanics	Fracture measurement, strength measurement, evaluation, assessment	1	1
Hydrology	Flow measurement, chemical measurement, sampling	2	2
Chemistry	Sampling, chemical analyses, evaluation, assessment		
Geophysics	Measurement, evaluation, assessment		2
Underground surveying	Underground surveying, mapping, measuring drill holes	1	2
Core sample management	Core sample storage, sample preparation		1
Geoinstrumentation	Instrument servicing, instrument storage	1	1
Total number of persons		9	18

Function	Activity	Initial operation	Regular operation
Manager	Management, co-ordination	1	1
Manager, quality	Monitoring, advising	1	1
Staff, quality	Checking goods received, checking operations	2	3
Occupational safety	Monitoring operations with regard to occupational safety	1	1
Radiation protection	Measuring, evaluating, classifying the areas	1	1
Safety analyses	Analyses of operations and incidents	1	1
Environment, permits	Monitoring operations with regard to environmental matters, information for operating permits	2	2
Contacts with authorities	Reporting, following up safety level	1	1
Total number of persons		10	11

9. STAFF - ORGANISATION
9.3 STAFF

Operation, deposition

Function	Activity	Initial operation	Regular operation
Manager	Management, co-ordination, planning, resources	1	1
Ramp and ground transports	Transport of transport casks in ramp. Bentonite transports in ramp. Rock from silo to production building or rock store. Backfilling material to unloading hopper.	1	1
Reloading in the vault	Reloading from transport cask to radiation shielding tube, handling components and equipment in the vault	1	2
Deposition, canisters	Preparatory work in tunnels, transporting canisters to deposition tunnels, checking hole quality, deposition	2	2
Handling bentonite blocks	Transporting bentonite blocks below ground, inserting blocks	2	2
Backfilling	Backfilling material to the deposition tunnel. Backfilling, compacting. Casting of concrete plugs.	9	19
Absenteeism reserve		2	2
Total number of persons		9	10

Preparation of buffer and backfilling material

Function	Activity	Initial operation	Regular operation
Manager	Management, co-ordination, resources, job reports	1	1
Bentonite blocks, store	Handling, storekeeping	2	2
Crushed rock for bentonite mixing station	Crushing, mixing	2	2
Preparing moulds and pressing	Preparing moulds, filling, pressing	1	2
CNC operators	Following up the press cycle?	1	2
Rock crushing	Transporting in, crushing	1	1
Rock stockpile	Handling	1	2
Mixing	Mixer, silos	1	2
Absenteeism reserve	Bentonite blocks, backfilling material	1	2
Total number of persons		11	16

Preventive maintenance and repairs

Function	Activity	Initial operation	Regular operation
Manager	Management, co-ordination, resources	1	1
Tunnelling	Drilling, grouting, blasting, rock support, checking rock quality	1	16
Rock transport below ground	Rock to silo	6	10
Drilling probe holes	Core-drilling for deposition tunnels, core-drilling for deposition holes		2
Drilling deposition holes and transport	Drilling, removing drill cuttings		5
Roadway, laying and cleaning	Mucking, concrete slabs, macadam	4	8
Ventilation	Servicing work for excavation	4	12
Absenteeism reserve	Drilling, transport, backfilling	3	6
Total number of persons		19	60

Function	Activity	Initial operation	Regular operation
Manager	Management, co-ordination, inspection, resources	1	1
Maintenance of machines	Drainage systems, ventilation, power, vehicles, deposition and excavation machines	2	3
Successive expansion	Expansion of electrical, ventilation and mechanical systems that follow the tunnelling work	2	4
Workshop in the central area	Basic mechanical work	1	1
Store below ground	Storekeeping	1	1
Total number of persons		7	10

- 10.1 General
- 10.2 Generic arrangement
- 10.3 Site arrangement
- 10.4 Railway yard
- 10.5 Storage building for bentonite
- 10.6 Harbour office
- 10.7 Ground treatment

10

HARBOUR AREA

10. HARBOUR AREA

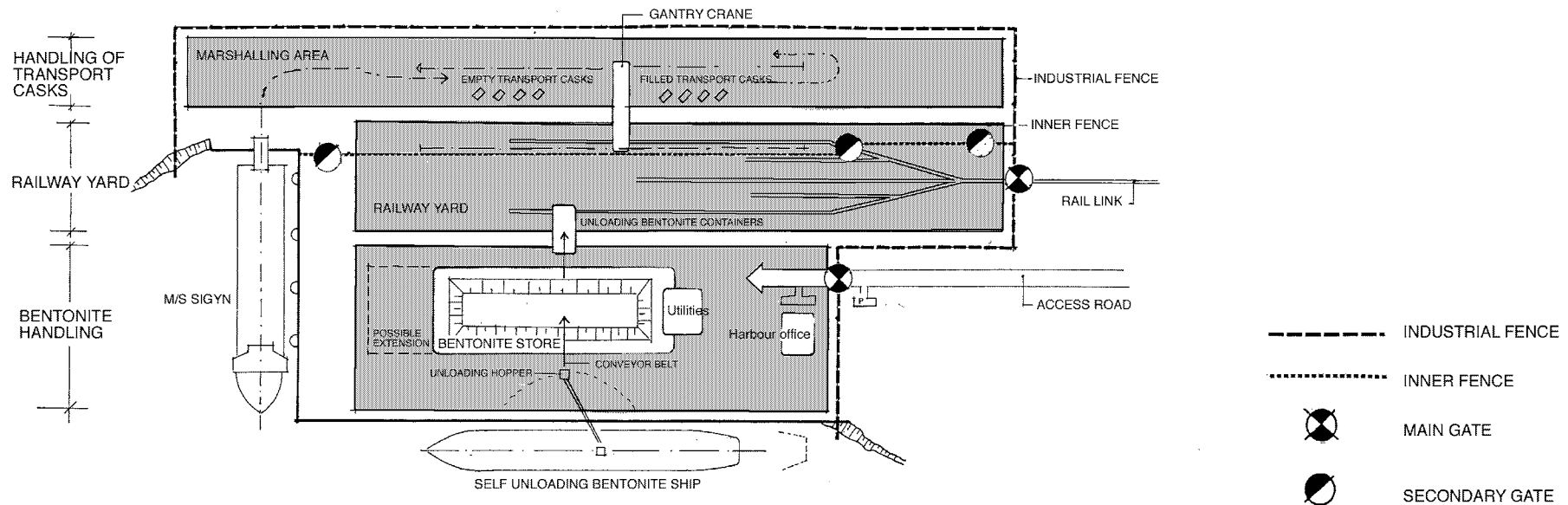

10.1 General

The following proposal for the design of the harbour, based on the requirements in chapter 4, has been drawn up in order to give an idea of the size of the facility.

The harbour area has been designed solely to meet the needs of the deep repository, without adaptation to the actual geographical situation.

10.2 Generic arrangement

The harbour area consists of the following sub-areas:

- Quay area for bentonite handling
- Railway yard
- Area for marshalling transport casks

The quay for the ship containing transport casks must have a roll-on-roll-off berth, while the bentonite vessel needs to be able to dock alongside a quay where it can connect to a fixed unloading facility.

The figure above shows the proposed facilities and the design of the protection against trespassing. The area is enclosed by an industrial fence, which limits access from the landward side. There may also be an inner fence, which separates the transport cask storage area from the rest of the harbour area. As a result, the crews of the ships can go ashore via the main entrance, without coming into contact with the transport casks.

Operations

The crew of the bentonite vessel carries out the unloading procedure, from the hold of the vessel to the bentonite storage area. The crew of the vessel carrying the transport casks unloads and loads the vessel using a terminal vehicle they bring with them. Staff from the operational area of the deep repository load the transport casks onto, and unload them from, the railway wagons using a gantry crane.

The same staff also load the bentonite into the containers on the railway wagons. In doing so, they use wheel loaders, which they drive into the building between the current bay and a mechanical unloading device, which apportions the correct amount to each container.

Security staff guard the harbour area when there are filled transport casks stored in the area. The train crew helps with unloading and loading.

Considering the relatively limited amount of traffic, the harbour can be classed as a temporary workplace. The work is led from the operations centre. Staff with similar duties, from the operational area of the deep repository, look after the land and buildings.

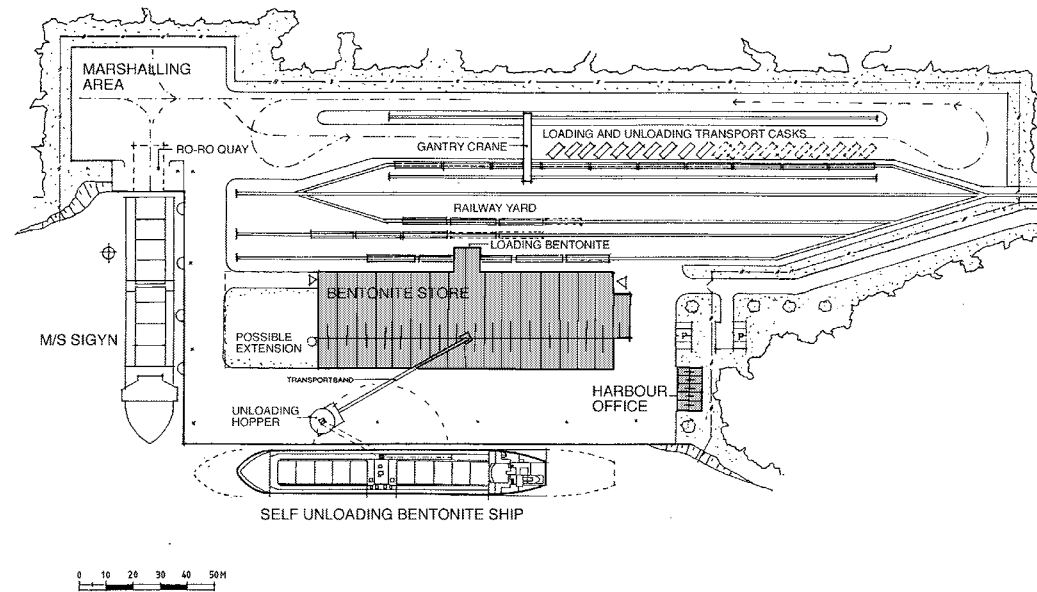

10.3 Site arrangement

The site arrangement has been designed with regard to the following:

- The number, shape and size of the quay berths
- The floor area of the bentonite store
- The length of the train and the number of wagons
- The size of the railway yard
- The place for parking the transport casks

The storage building for bentonite is located alongside the quay where the vessel can be berthed. The vessel must be specially designed for this type of cargo, with specially adapted unloading equipment onboard. The equipment on the ship feeds the bentonite to a hopper on the quay, from where a permanent belt conveyor transports the material into the bentonite building. The roll-on-roll-off berth is at right angles to the bentonite quay.

Transport casks are unloaded and loaded using a terminal truck, via the stern ramp. The ship is designed to carry ten transport casks.

Unloading and loading continue until nine filled casks have been brought ashore and lined up along the railway track. When the ninth cask has been set down, the terminal truck takes the first empty transport cask and reverses onto the ship.

The truck then takes the last filled cask, drives out and puts it in line with the other nine. The other nine empty casks are then driven onto the vessel. The reloading ends with the terminal truck being driven aboard, after which the vessel is ready to set out on the return voyage.

The place where the transport casks are put will have room for 19 units along the railway track. Reloading from the transport frames to the railway wagons is done using a gantry crane, which can span both the storage area and the track. The train remains stationary while the gantry crane performs the lift.

The transport frames mentioned previously are essential for the whole transport system, which is based on handling using a terminal truck. Using this system, the transport frames remain in the harbour area. The railway wagons will be fitted with an equivalent arrangement.

There is a road encircling the harbour area, so that guards can patrol by car. There is a small building at the main entrance to the area that contains the staff premises etc. Parking spaces for facility staff and visitors have been located outside the fence.

Dimensions

Length:	350 m
Width:	100 m
Area:	35,000 m ²

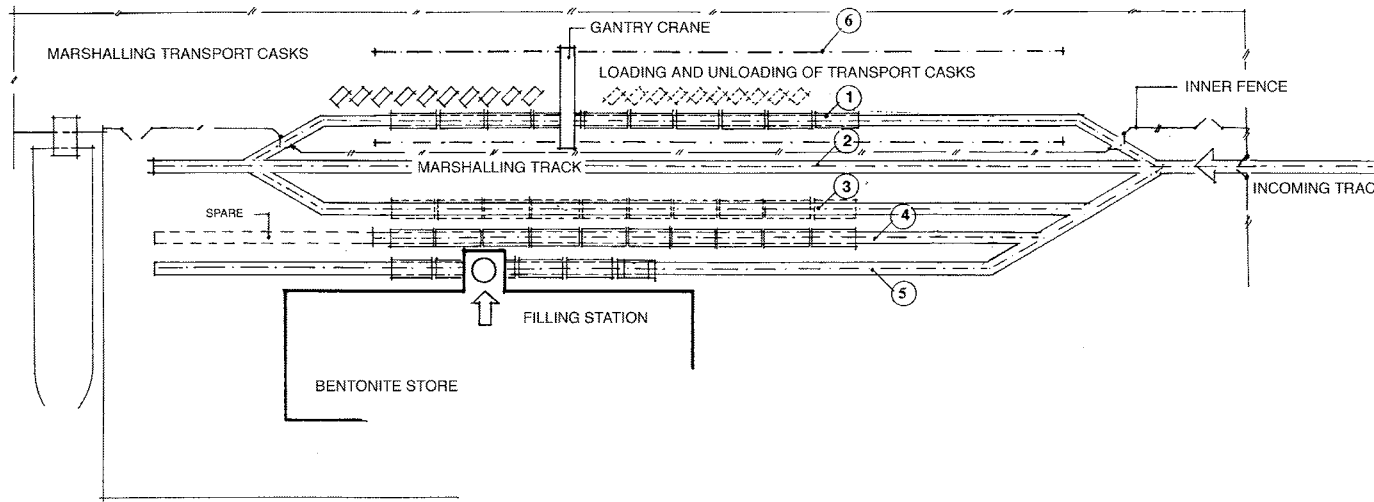

10.4 Railway yard

General

The purpose of the railway system is to transport casks containing encapsulated spent nuclear fuel and bentonite from the harbour to the operational area. The following wagons are required:

- 11 specially built covered wagons, which carry one transport cask, one of which will be kept in reserve
- 11 open goods wagons for two 20'/(four 10') containers, one of which will be kept in reserve
- One diesel locomotive.

The facility track system will probably be limited to tracks from the harbour and the operational area, linked to the National Rail Administration's general rail network.

Layout

The railway yard in the harbour area will be designed to accommodate two trains at the same time, each consisting of 10 wagons. There will also be marshalling tracks for changing the train configuration.

The railway yard consists of six parallel tracks, as follows:

1. For loading and unloading transport casks.
2. For marshalling.
3. For incoming, empty bentonite containers.
4. For outgoing, full bentonite containers.
5. For loading bentonite
6. Track for the gantry crane.

There is also a gantry crane at the railway yard, for unloading transport casks:

Max. load:	80 tons
Max. lift height:	8 m
Coverage area:	
Width:	30 m
Length:	250 m

Radio controlled.
Hoist designed to match the lifting points of the transport cask.
Specially designed winding gear, to prevent the load from being dropped.

Dimensions

Length:	275 m
Width:	40 m
Area:	11,000 m ²

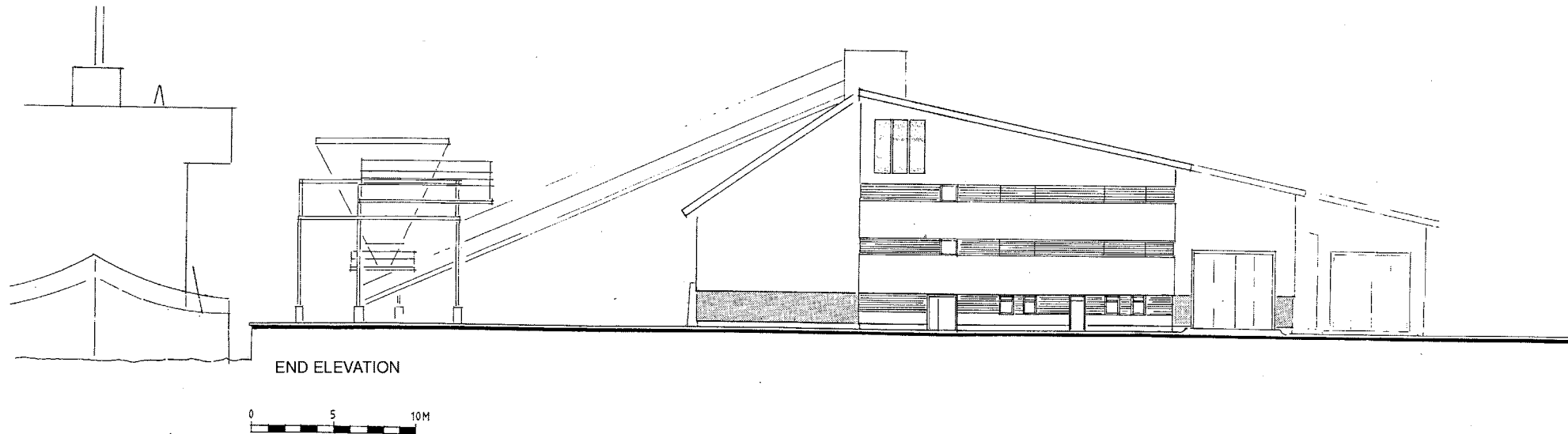

10.5 Storage building for bentonite

General

The purpose of the bentonite storage building is to act as a buffer store for bentonite, while awaiting onward transport to the operational area of the deep repository.

The size of the storage building has been chosen so that it can receive the load from a vessel of 10,000 dwt.

At present, there is sufficient tonnage available, with special unloading equipment and capacity for ocean traffic.

The storage building will satisfy the requirement for a suitable environment for storing bentonite, where limiting moisture pickup is paramount.

Operations

The operations in the building are limited to using wheel loaders to unload bentonite into containers standing on railway wagons. The job involves loading 20/40 containers in succession on each occasion. Between these times, operations cease.

The building, which has an elongated, rectangular shape, is divided lengthways into a wide bay for storage and a narrow bay for unloading. The storage area is divided into three equal sections, which permits separation of different qualities of the bentonite.

The unloading section runs through the entire building, with vehicular access to the three sections. On the opposite side, in the centre of the long side of the building, there is an extension, with a railway track running through it, where the wagons stand to load the containers.

The bentonite is transported into the building using an inclined conveyor belt, up under the roof. There, the bentonite is discharged onto a distribution conveyor belt, which runs along the entire length of the storage section, and with which the material can be distributed as required.

At one gable end of the building, there are service areas for protective clothing and cleaning equipment. On an upper level, there is an area for the ventilation system. The environment in the building is classified as dusty.

The building has been based on a comparable facility in Norway. Experience of that facility has been good.

Dimensions

Length:	108 m
Width:	36 m
Height:	15 m
Area:	39,000 m ²
Storage volume, total:	15,000 m ³
Storage volume per section:	5,000 m ³

Equipment

- 4 belt conveyors
- 2 reloading hoppers
- 1 unloading position
- 1 wheel loader
- 6 large roller shutters
- 4 large folding doors
- Fans with cyclones and filters

10. HARBOUR AREA

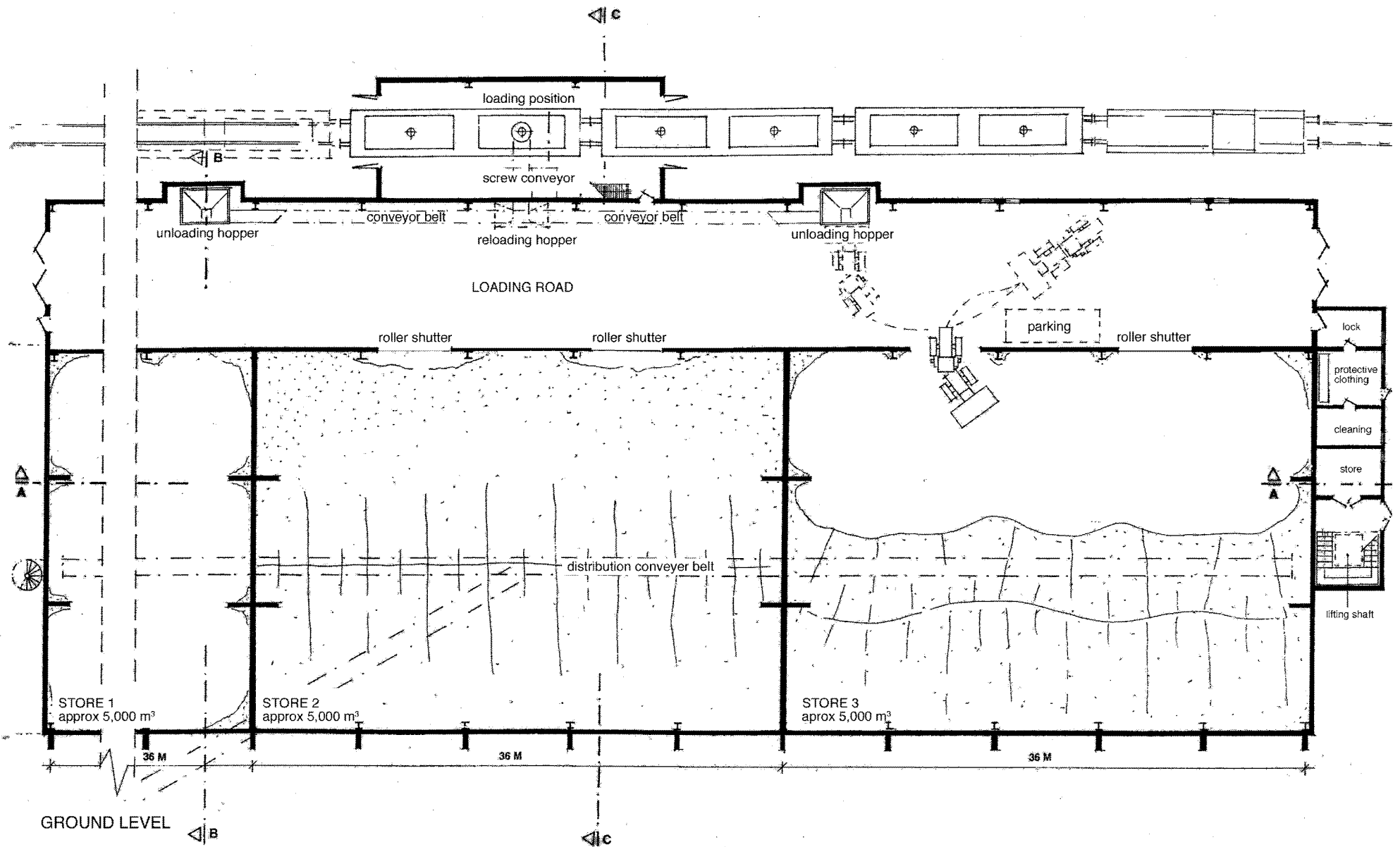

10. HARBOUR AREA

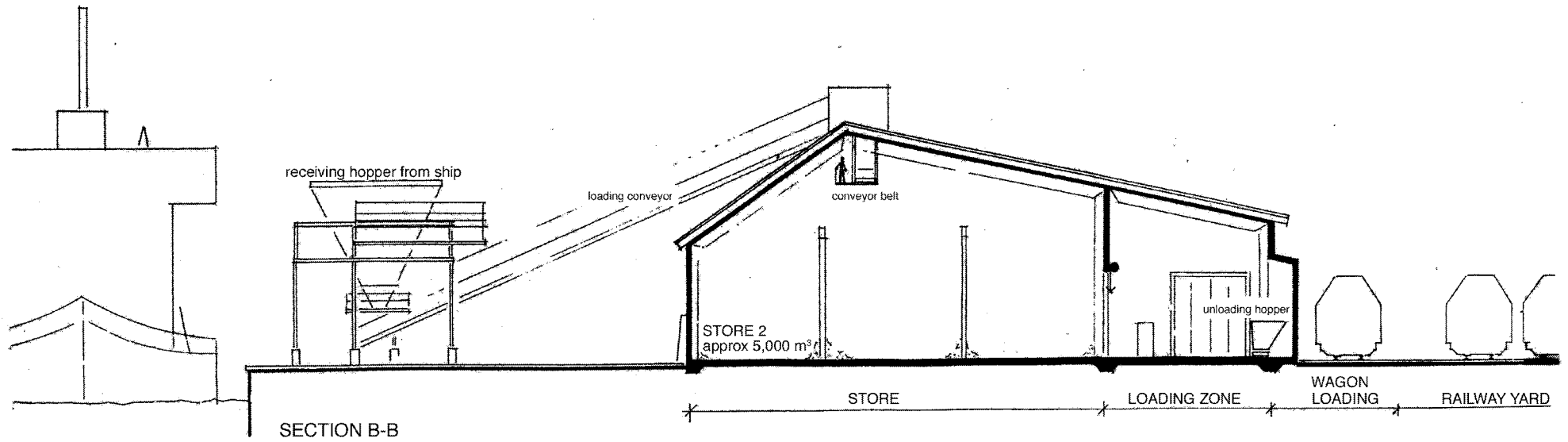
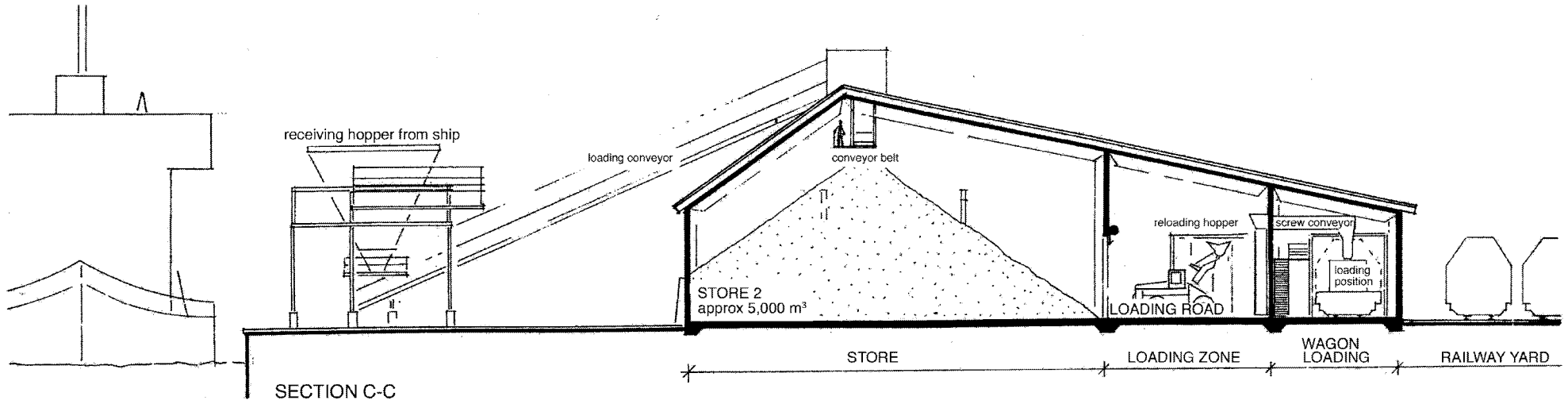

10. HARBOUR AREA

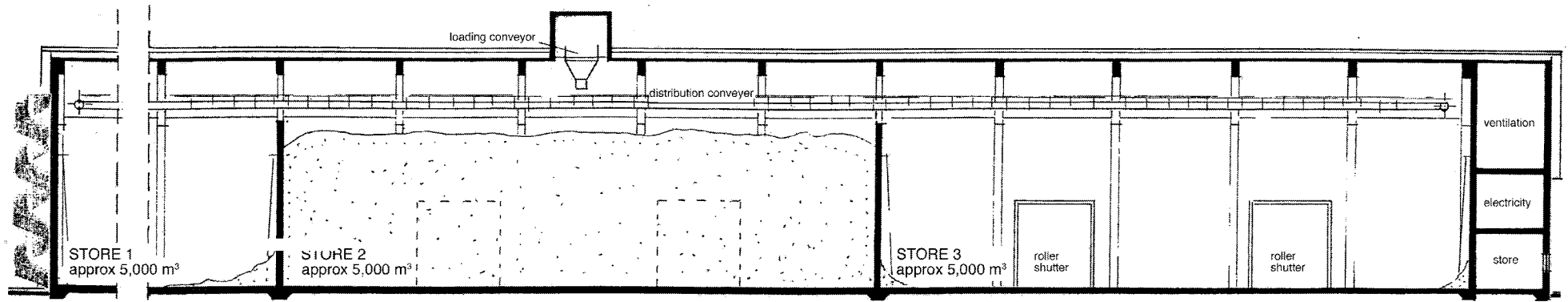

SECTION A-A

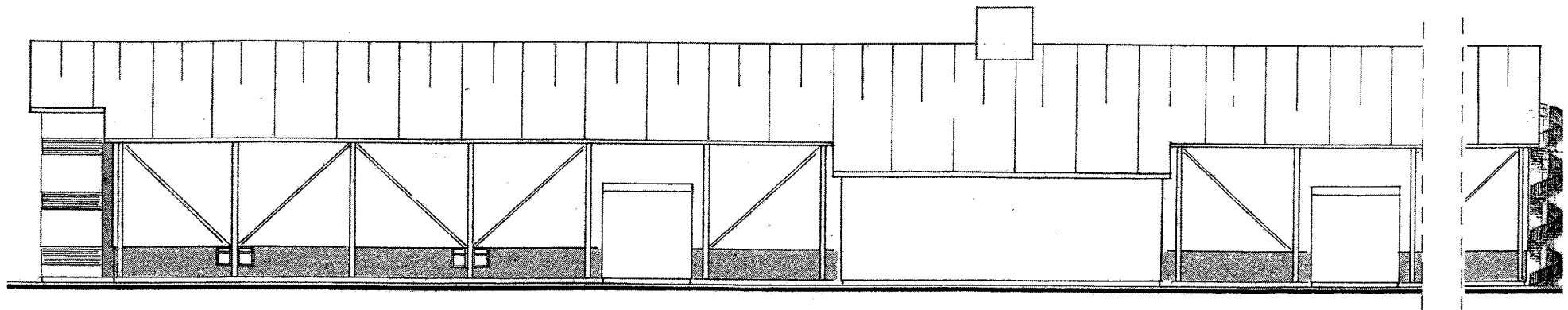

SIDE ELEVATION

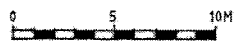

10. HARBOUR AREA
10.6 HARBOUR OFFICE

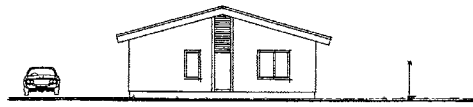

END ELEVATION

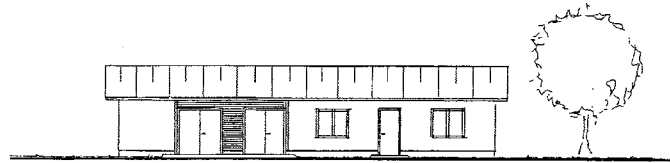

FRONT ELEVATION

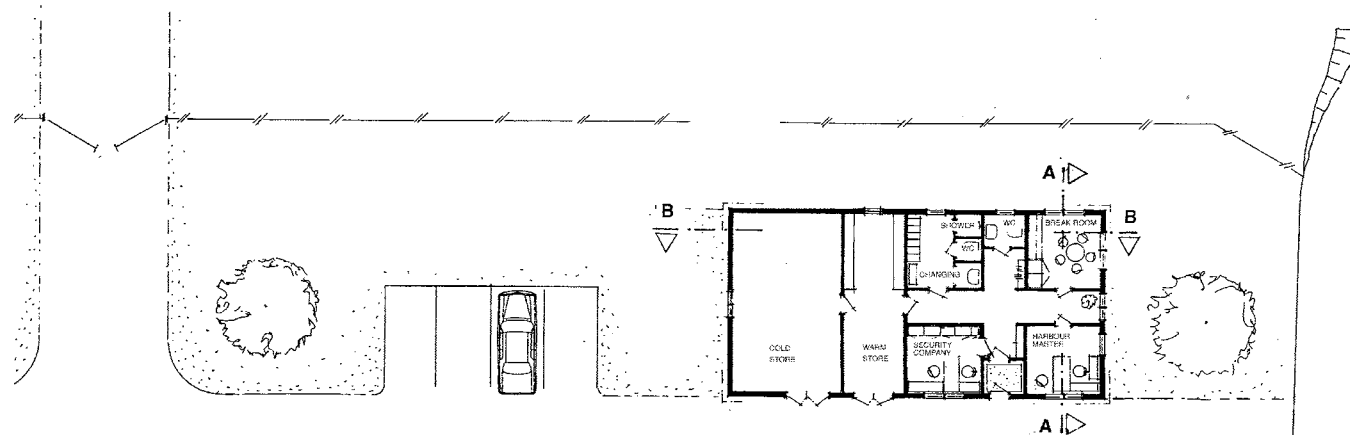

FLOOR PLAN

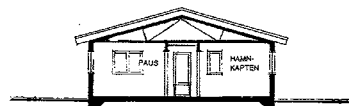

SECTION A-A

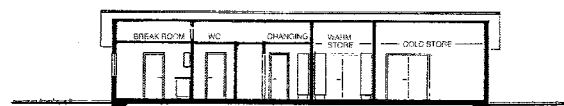

SECTION B-B



General

The purpose of the building is to provide for the local needs of the staff that will be working in the area. There is also a small storage area for tools etc.

Operations

The building will be used mainly as a base for those working more or less regularly in the harbour area. It is not intended that the building will be used as a permanent workplace.

Layout

The building consists of a relatively long space, divided into a staff/office section, a warm storage section and a cold storage section.

The staff section consists of changing and washing rooms, toilets, a break room with a kitchen and two offices.

The storage areas consist of unfurnished rooms, which can be adapted for storing tools and other equipment needed for the work.

The shape of the building and its location in the area make it possible to extend in two directions if the need should arise.

Dimensions

Length: 17 m
 Width: 8 m
 Height: 4 m
 Area: 136 m²

The staff area has been designed to accommodate eight people at the same time.

10. HARBOUR AREA
10.7 GROUND TREATMENT

The surfaces of areas used by vehicles are paved with asphalt. The railway yard is gravelled in the usual way. The yards will be well drained. The area around the main entrance and harbour office will be planted with a limited amount of grassed areas and bushes.



The harbour area will have outside lighting.

A fence with gates will be erected, in accordance with the guidelines in section 10.2. The immediate area on either side of and alongside the fence will be open, to facilitate surveillance of the protection against trespassing.

A number of cameras will be installed to permit surveillance of the area.

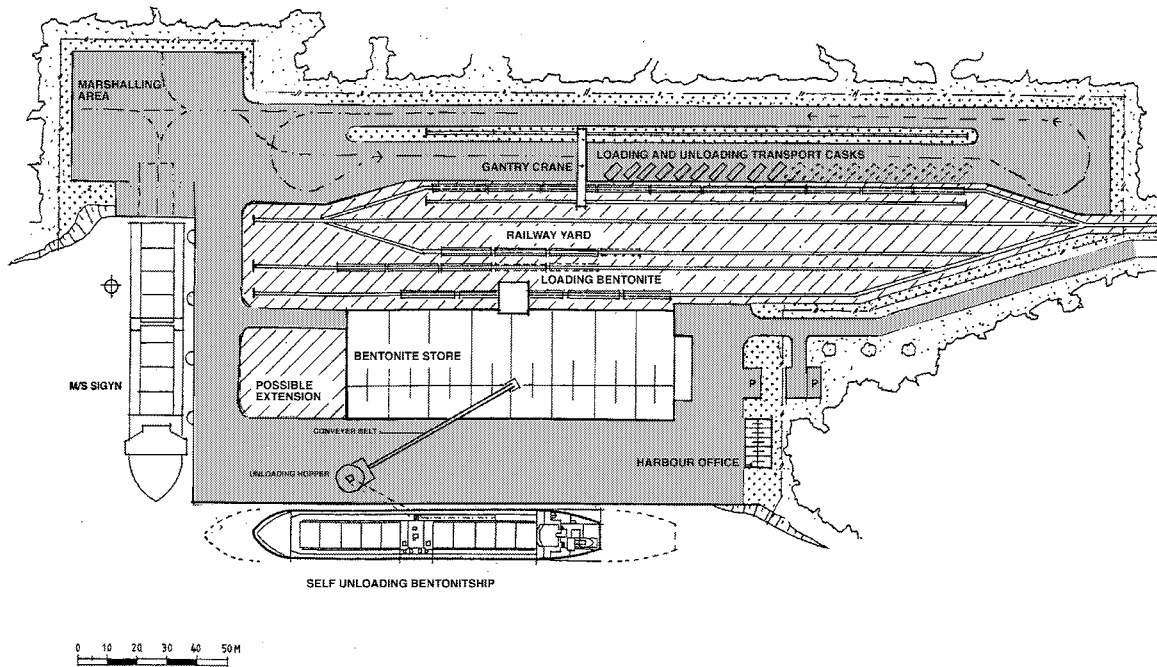
There will be monitors in the harbour office and the operations centre.



-  **GRAVEL**
-  **ASPHALT**
-  **VEGETATION**

- 11.1 Generic arrangement
- 11.2 Site arrangement for regular operation
- 11.3 Operations
- 11.4 Protection against trespassing
- 11.5 Transports to the operational area
- 11.6 Transport routes in the area
- 11.7 Collector rail for electrically driven vehicles
- 11.8 Railway yard
- 11.9 Routing of cables and pipes in the ground
- 11.10 Ground treatment
- 11.11 Possible extension areas
- 11.12 Data and dimensions
- 11.13 Site arrangement – excavation of ramp and shaft

Requirements

The basic requirements for the design of the surface area are set forth in chapter 5, which describes the planned operation that affects the surface area. Activities during the regular operation phase will dimension the size of the operational area. The operational area will also be designed with regard to the requirements and conditions that exist during both the mobilization and construction phases, and also to possible activities when deposition comes to an end. The following phases will be considered:

- Mobilization phase
- Construction phase
- Operational phase
- Future

Assumed conditions for the site

Undeveloped land - reasonably flat forest terrain. Acceptable conditions for foundations. Relatively close proximity to existing infrastructure in the form of a road, railway and preferably water, sewerage and electricity adjacent to the existing industrial area.

Mobilization phase

Ground- and roadwork, erection of temporary facilities, connections to the local infrastructure, excavation, begin storing rock, erection of and service building and auxiliary systems, installation of auxiliary and service systems.

Construction phase

Construction of necessary buildings, including roads, railway yard, yards. Additions to auxiliary and service systems. Installation of mechanical equipment etc. Simultaneous continued excavation of the underground area.

Operating phase

Transport of canisters, bentonite and rock. Production of bentonite blocks and backfilling material. Servicing - maintenance - administrative checks and labour supervision. Information activities.

The future

Alternative 1

Decommissioning - demolition – restoration

Alternative 2

Decommissioning - demolition - restoration - information/tourism.

Alternative 3

Decommissioning - some demolition/stripping out – adaptation to new industrial activity – additional building for the new requirements.

Objectives

The following objectives have been taken into consideration when planning the facilities above ground:

- The arrangement should have been thoroughly thought through and be characterised by a comprehensive outlook from the start.
- The arrangement will take account of the conditions that exist in each stage.
- The facility will be easy to oversee, with well-defined entrances.
- The design will be well structured and co-ordinated with the nature and conditions of the operation.
- The arrangement will be designed to provide the type and frequency of transport required.
- The facility will provide good flexibility and extendibility.
- The generic arrangement will be designed so that it can be adapted easily to the local ground conditions, external connections, existing buildings and existing infrastructure.
- The generic arrangement of the facility will permit the creation of an aesthetically pleasing facility, with a safe and pleasant working environment.

Principal factors

The following factors are important for the design:

- Size of the railway yard
- Vehicular traffic
- Working environment
- Expansion in stages
- Stockpiling of rock
- Protection against trespassing.

Layout

An analysis of the actual conditions highlights four functionally essential areas, as follows.

11. OPERATIONAL AREA - COMMON 11.1 GENERIC ARRANGEMENT

Service zones:

- Entrance with parking
- Information building
- Office and workshop building
- Garage
- Store
- Electrical building
- Utility building

Production zone:

- Terminal building
- Production building with crushed rock- and bentonite store
- Reloading hopper
- Portal building
- Tunnel ramp

Railway yard

- Tracks

Rock store

- For excavated rock to be used for backfilling

A proposal for the generic arrangement of the operational area, worked out with regard to the above requirements and conditions, is given in page 11-2. The proposal gives information about the principles for the construction of the surface area.

A proposal for the layout of the facility, based on the buildings that have been designed, is shown in page 11-3.

Comments

The reason for dividing the functions into a number of separate, detached buildings is that each building can be designed for its primary purpose, without taking unnecessary account of irrelevant or unusual functions. The division provides great flexibility and good opportunities for expansion. Each building can be built at the time desired. However, continued analyses of required functions, such as adaptation to local conditions, might result in a considerably different utilisation of the surface area.

The design can be adapted to the requirements and desired environmental standards.

11. OPERATIONAL AREA - COMMON
 11.1 GENERIC ARRANGEMENT

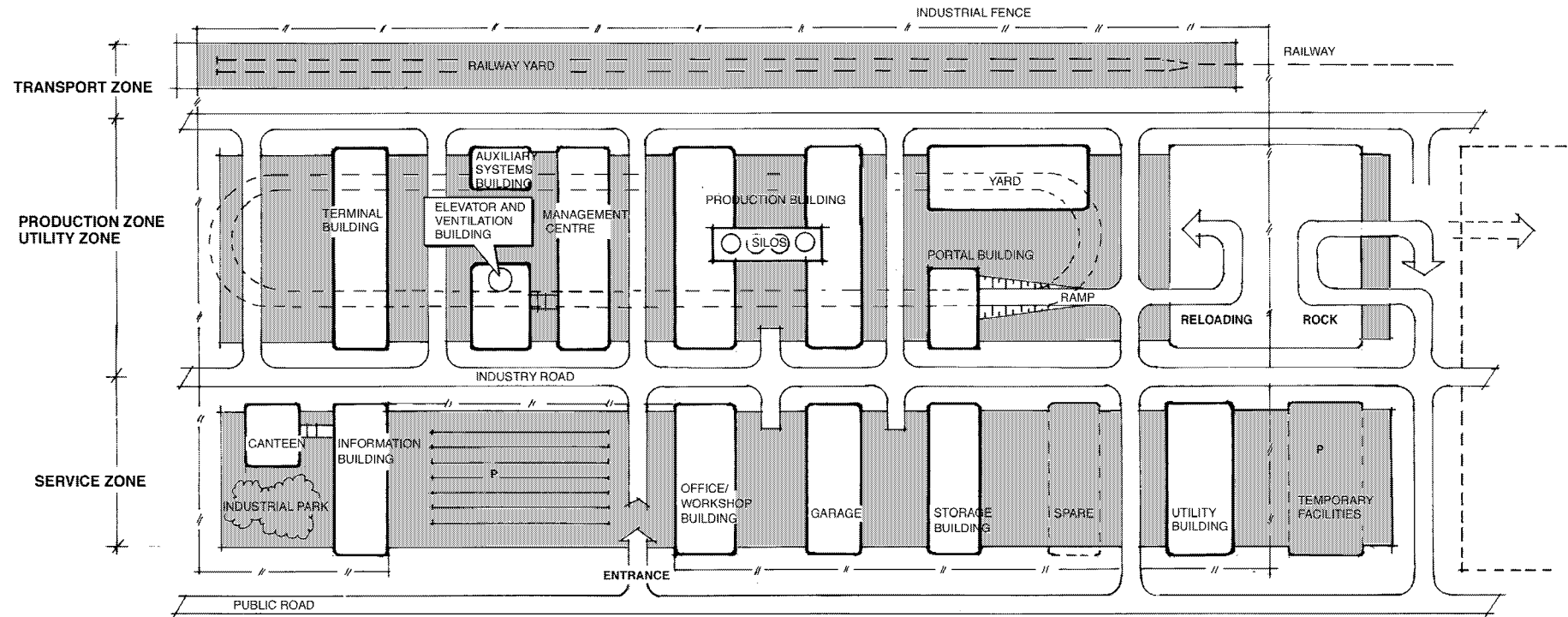

11. OPERATIONAL AREA - COMMON
 11.2 SITE ARRANGEMENT FOR REGULAR
 OPERATION

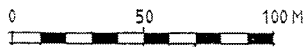
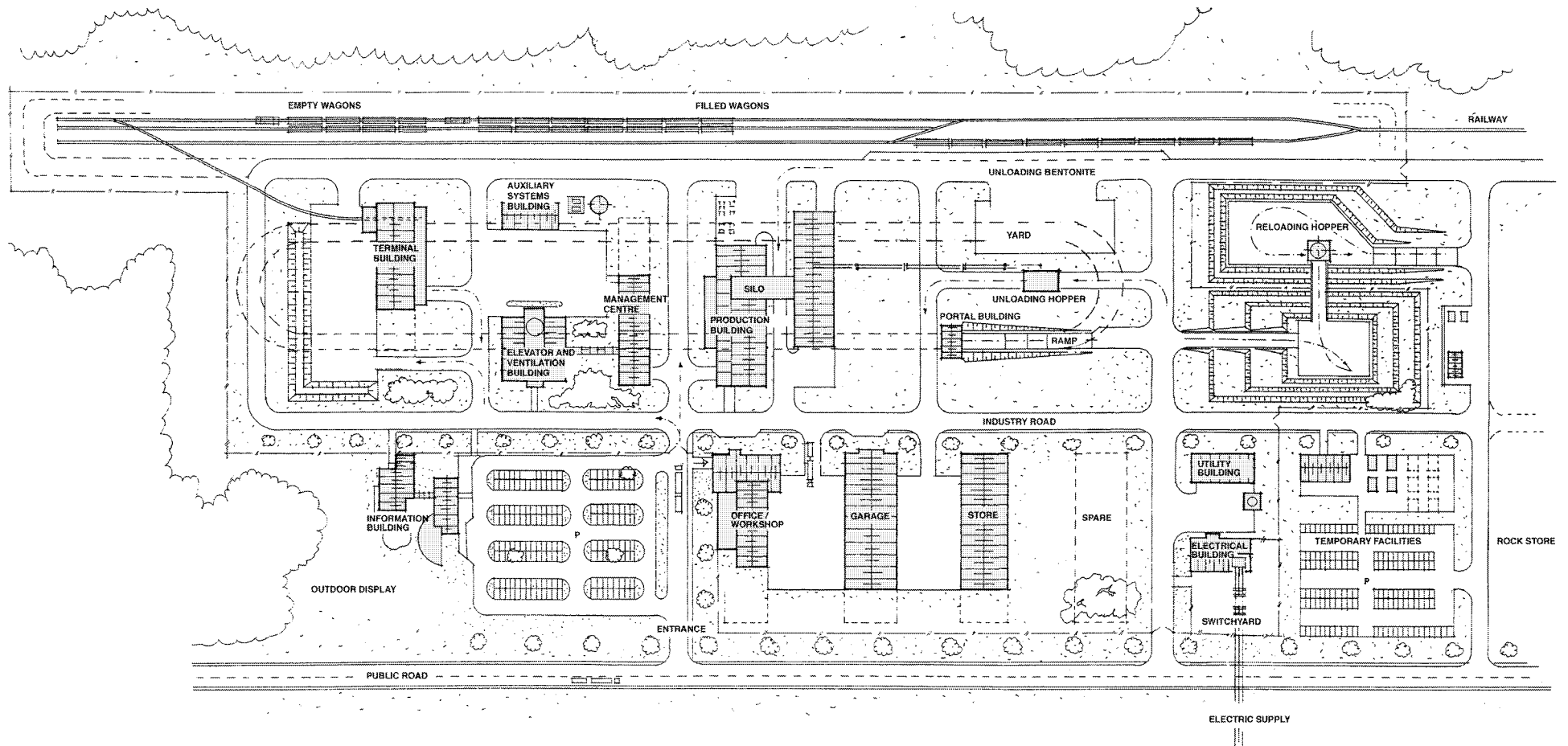

11. OPERATIONAL AREA - COMMON
11.3 OPERATIONS

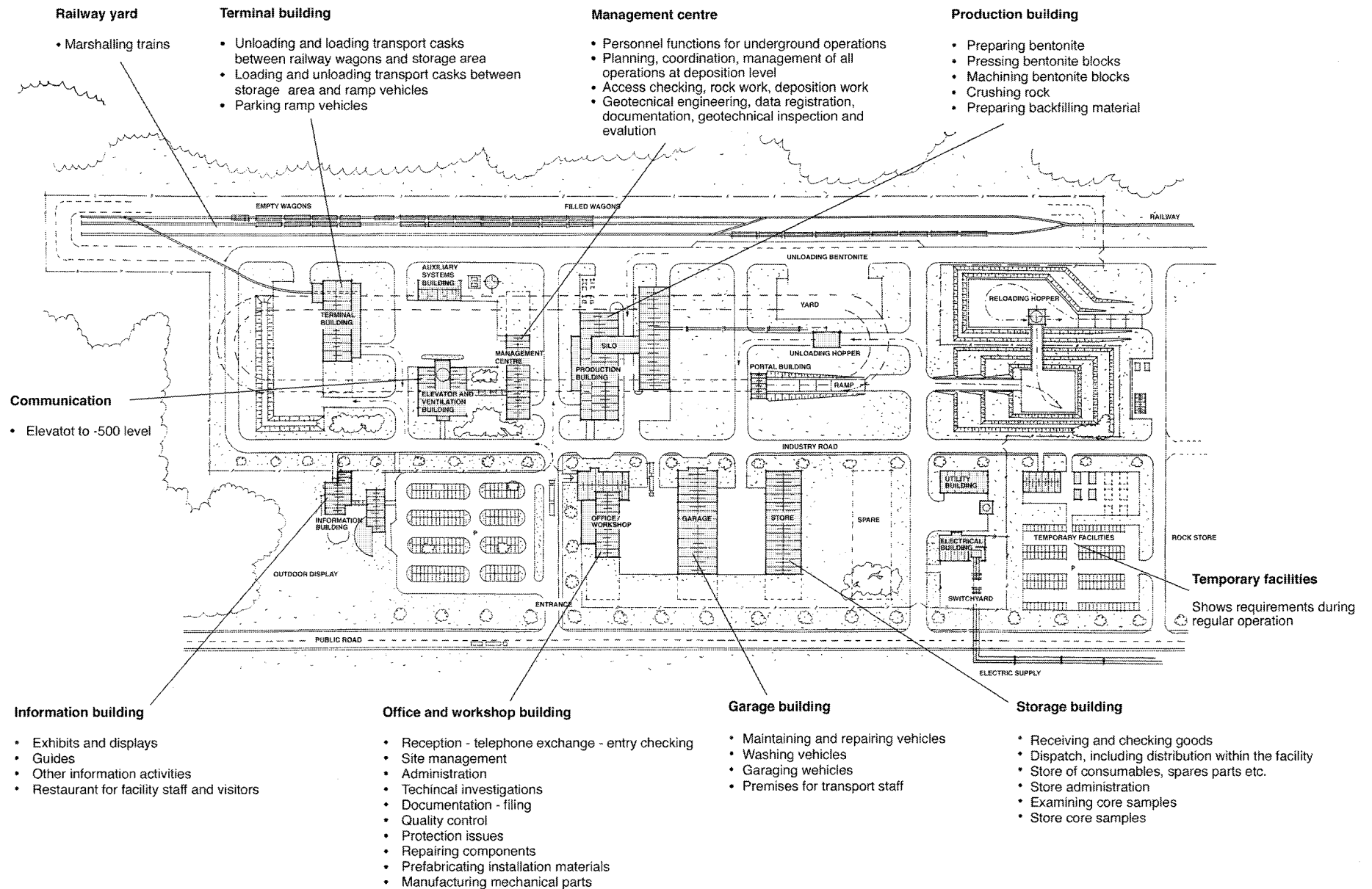

11. OPERATIONAL AREA - COMMON
11.4 PROTECTION AGAINST TRESPASSING

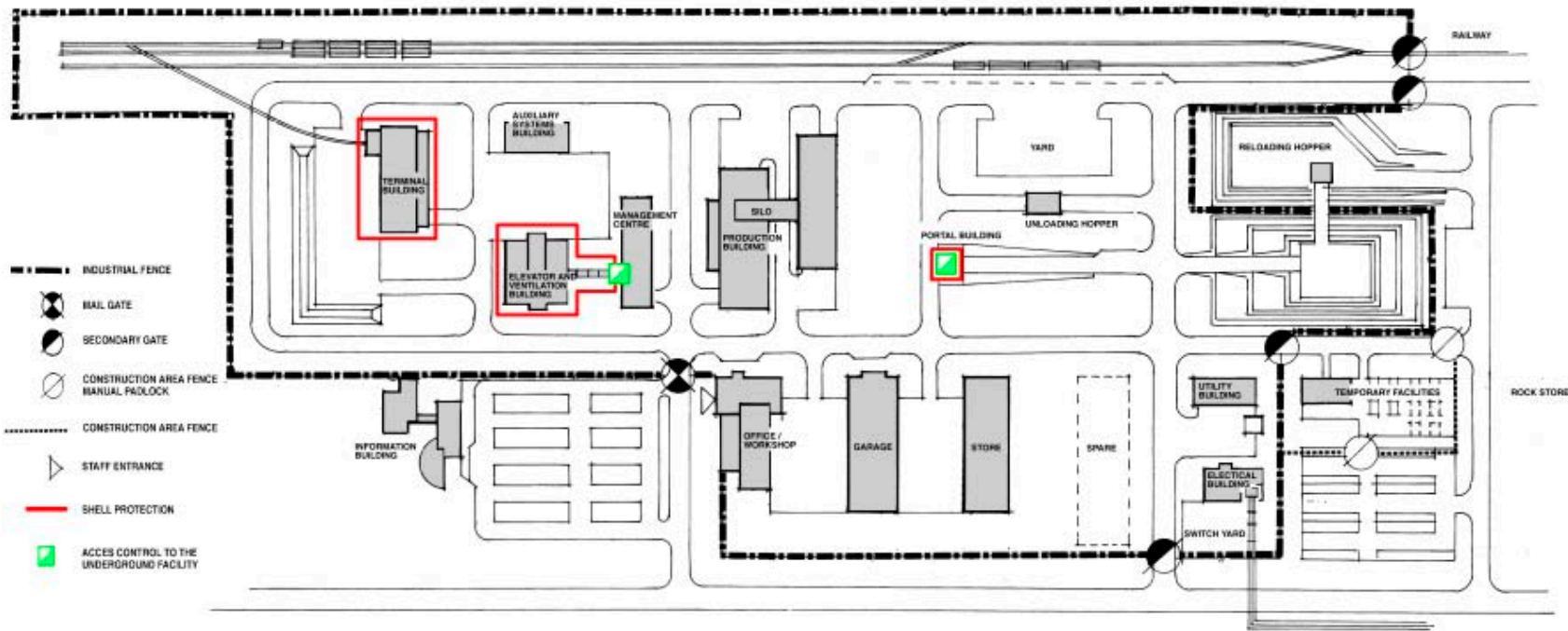

General

Special measures are required, in order to prevent unauthorised access to the operational area as well as to the underground facility.

An industrial fence encloses the operational area including the railway yard. A temporary fence surrounds the area for temporary facilities. The information building and the parking spaces for the facility's staff, contractors' staff and visitors are placed outside the fenced areas. The outdoor switchyard adjacent to the electrical building is provided with a separate fence. Reloading of rock for stockpiling or sale takes place outside the industrial fence.

The facility's staff enter the operational area via the main entrance at the parking area and walk to their workplaces in the adjacent buildings. Contractors' staff enter the operational area via the area for temporary facilities. Card readers and turnstiles are used for entry checks. Transports to the operational area are expected to enter the area through the main gate where checks can be done.

The secondary gates for vehicle transports are located at the far end of the operational area. These gates will be provided with card readers and will be surveyed and remote controlled from the operations centre. The railway track will be provided with its own gate.

Entrance to the underground facility can take place either via the elevator and ventilation building or by car via the spiral ramp to the central area.

There are many reasons why it is important to know how many persons there are in the underground facility and where they are expected to be. Therefore own operations and maintenance staff and contractors' staff shall pass the operations centre for registration and at the same time collect and return dosimeters and personal protection equipment. After the entrance check the staff walks a passage to the elevator and ventilation building for further transport to the underground facility.

In order to facilitate the work in the operations centre, groups of visitors can be led directly to the elevator and ventilation building, with the guide responsible for maintaining all checking.







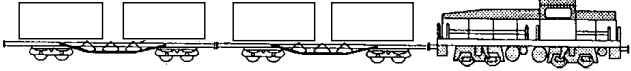
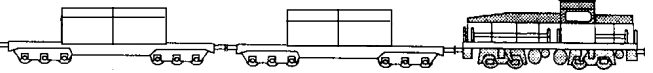

Staff and vehicles for transports to and from the underground facility will be checked with card reader and TV-surveillance in the portal building at the entrance to the ramp. All vehicles entering the underground facility must fulfil special safety demands. Temporary visiting vehicles must be checked before permission is given to enter the underground facility.

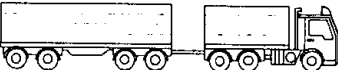
In order to maintain prevent trespassing in the underground facility, the elevator and ventilation building, the staff building, the adjoining walkway and the portal building must be fitted with shell protection. Because of the function of the terminal building it must be fitted with shell protection too.

Railway transports

Type of freight	Number per				
	year	month	week		
Bentonite tonnes	14000	1500	-		20(40) containers = 10 wagons
wagons	300	30	-		
Canisters wagons	200	20	-		10 wagons

Car transports

Type of freight	Number per				Type of vehicle
	year	week	day		
Rock	2400	140	20		Dumper
Building material, general freight	400	10	2		Truck with trailer
Concrete	240	5	1		Concrete truck - mixer
Fuel oil – diesel fuel	30	-	-		Tanker truck
Service	200	5	1		Service vehicle
Facility's staff	14000	350	70		Car
Visitors	4000	100	20		
Study visits	400	10	2		Bus
Refuse	40	1	-		Refuse truck
Food	600	15	3		Truck

11. OPERATIONAL AREA - COMMON
 11.6 TRANSPORT ROUTES IN THE AREA

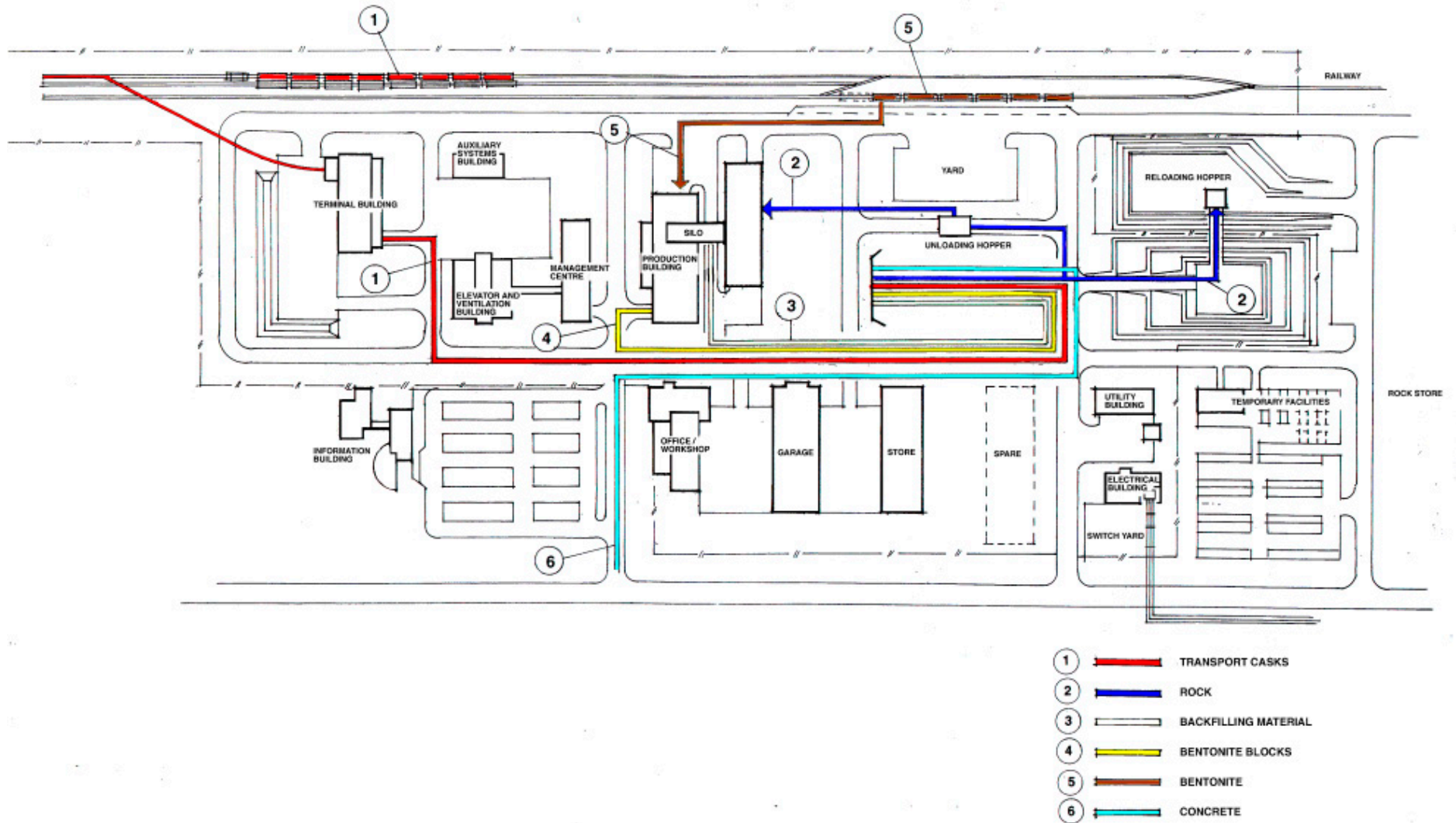

11. OPERATIONAL AREA - COMMON
11.7 COLLECTOR RAIL FOR ELECTRICALLY
DRIVEN VEHICLES

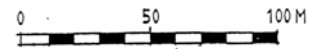
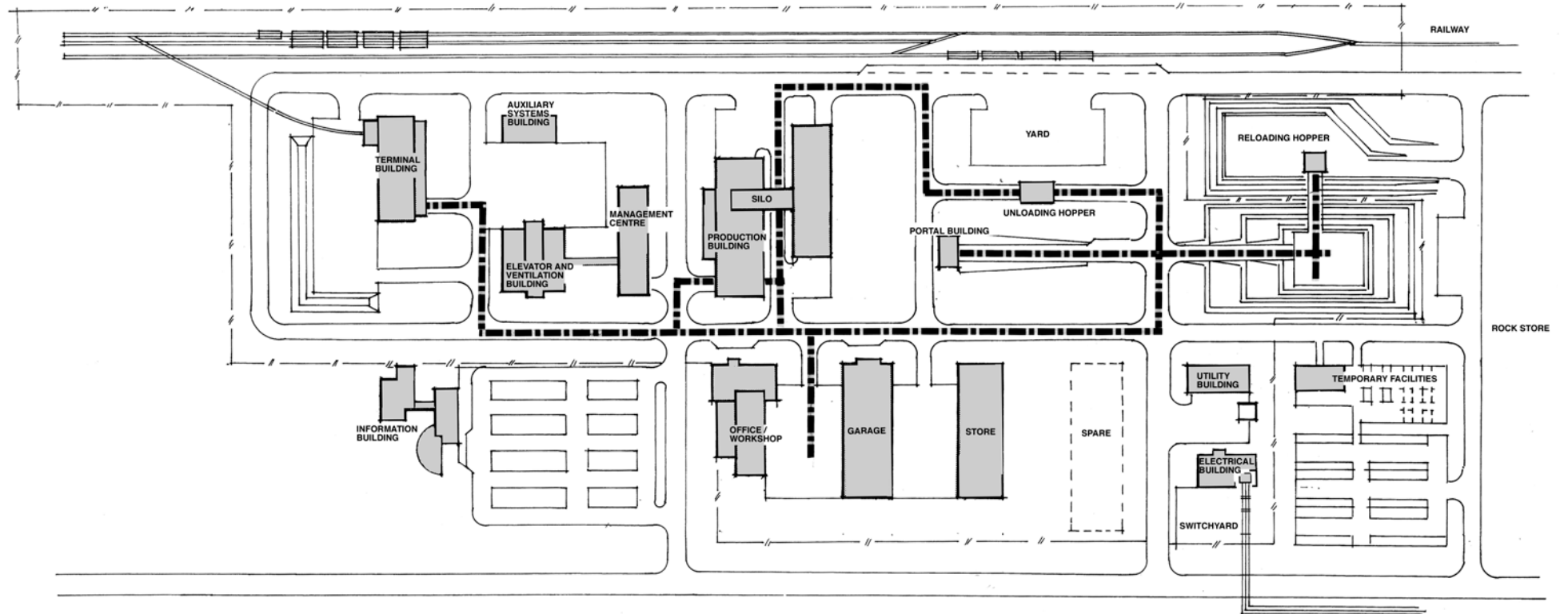

11. OPERATIONAL AREA – COMMON
11.8 RAILWAY YARD

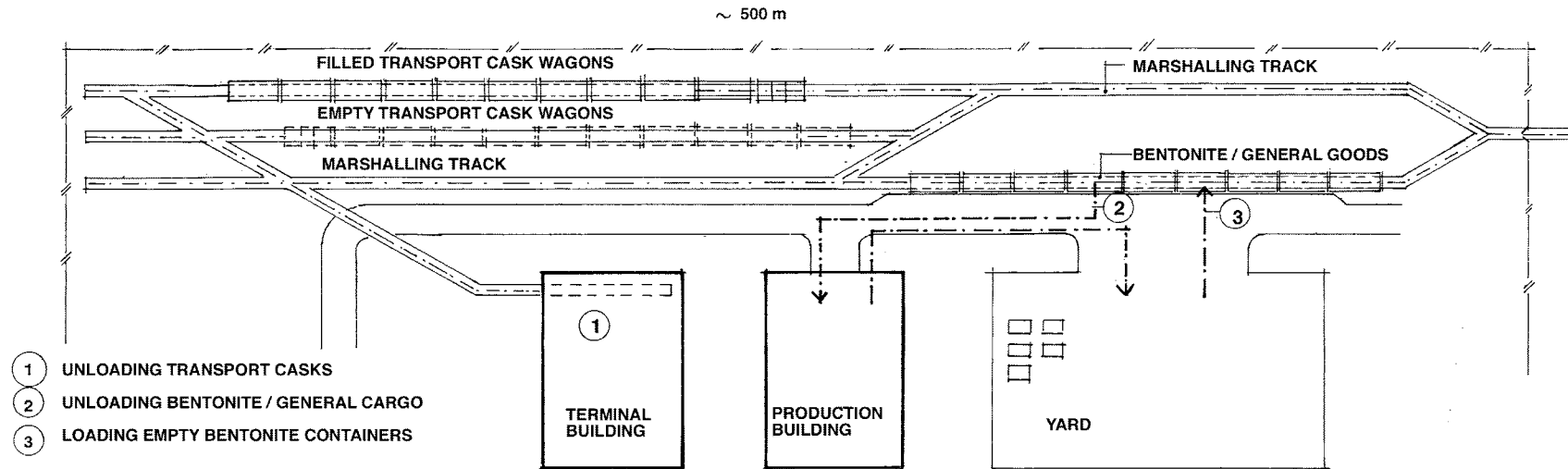

11.8 Railway yard

The objectives on page 11-1 are based on the assumption that transport casks and bentonite will be transported by rail from the nearest suitable harbour to the operational area of the deep repository. The transport requirement is equivalent to one train every other week carrying transport casks or bentonite.

A reason for choosing rail transport is to separate the transports from the general public as far as possible. Rail transport takes place in a controlled manner, on a track area where public access is prohibited.

Rail transport requires a railway yard inside the operational area, for marshalling, unloading and loading.

The railway will be a separate connection to an existing rail network, which is intended solely for the use of the deep repository. This means that the railway yard in the operational area will be the terminus.

The railway yard is designed for traffic with trains consisting of ten waggons plus a locomotive.

The wagons intended for transporting transport casks will be specially designed for the purpose, while bentonite will be transported in bulk containers, loaded onto standard goods wagons. In the latter case, it is assumed that each wagon will take two (four) ISO containers.

The rail transport will use diesel locomotives, to reduce investment for the railway system. The railway yard, which is straight, flat and horizontal, consists of three tracks. The track arrangement enables both a train with transport casks and a train with bentonite containers to stand at the railway yard at the same time.

The three tracks are connected to the terminal building by a siding. To unload the transport casks, a wagon is uncoupled from the train and shunted into the terminal building. The superstructure of the wagon is pulled apart and the travelling crane lifts off the transport cask and places it in a vacant place in the building. Then an empty transport cask is lifted onto the railway wagon, the superstructure is pushed together and the wagon is shunted out and put on the free track. The procedure continues in the same way until all of the wagons are unloaded.

The train carrying the bentonite containers is unloaded and loaded using a forklift truck, which transports the containers between the rail wagons and the bentonite store in the production building. As a result, the train will be parked on the track nearest the yard. Transport of odd items, e.g. equipment for the repository, will be unloaded in an equivalent way. As there is no collector rail, a mobile crane can be used for unloading and loading.

For safety reasons, the railway yard will be inside the industrial fence. There will be a lockable gate over the incoming track. The railway yard is monitored from the operations centre via TV cameras. It will also be possible to drive around the railway yard track system by car. Marshalling, unloading and loading, and the traffic between the harbour and the operational area is controlled from the operations centre.

Dimensions

Train length including locomotive:	175 m
Length of railway yard:	500 m
Width of railway yard:	50 m
Total track length in the operational area:	1,500 m

11. OPERATIONAL AREA - COMMON
11.9 ROUTING OF CABLES AND PIPES IN THE GROUND

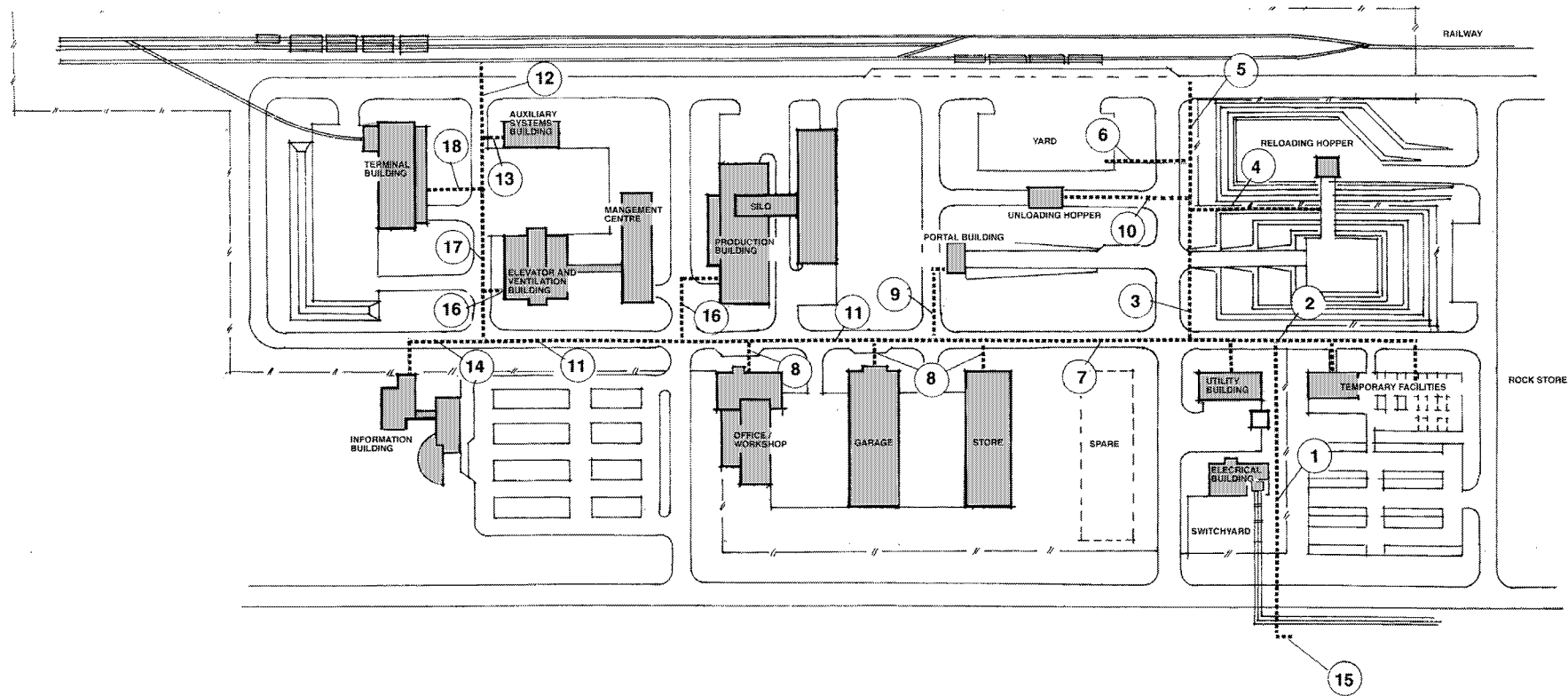



System / Section	1	2	3	4	5	6	7	8	9	10	11	12	13	14	15	16	17	18
Raw water	x														x			
Potable water/ water for fire protection		x					x	x			x		x	x		x	x	x
Sewage	x	x					x	x			x		x	x	x	x	x	x
Fresh drainage water	x						x		x						x			
Saline drainage water												x	x			x	x	
District heating	x						x	x	x		x		x	x		x	x	x
Control cables	x		x		x		x	x	x		x	x	x	x		x	x	x
Telephone cables, computer network	x	x					x	x	x		x		x	x	x	x	x	x
Power cables – high voltage	x						x		x		x				x ¹⁾	x		
Power cables – low voltage	x	x	x	x	x	x	x	x	x	x	x	x	x	x		x	x	x

¹⁾ Overhead transmission line

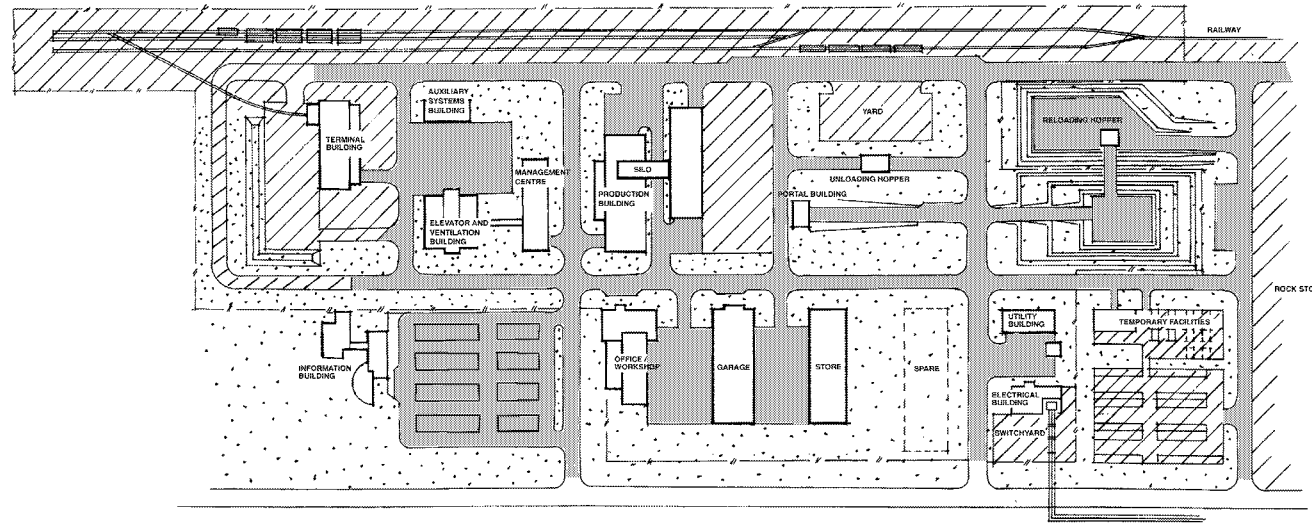
11. OPERATIONAL AREA - COMMON
11.10 GROUND TREATMENT



KEY:

-  GRAVEL
-  ASPHALT
-  VEGETATION

The area will be well drained. The final choice of surface in the operational area will be made when the planned land use has been fixed, in combination with the requirements for the chosen site.

Proposed surfaces (i.e. asphalt, gravel and grass), are shown in the figure to the left.

- Frequently used roads will be asphalted.
- The level areas between the office and workshop building and garage building, and between the garage building and storage building will be asphalted.
- The parking area outside the main entrance will be asphalted.
- The area for temporary facilities will be gravelled.
- The yard between the ramp to the deposition level and the railway yard will be gravelled.
- The railway yard will be gravelled.
- Suitable areas of grass, bushes and trees will be planted, primarily near the entrance area and buildings containing permanent workplaces.

The various parts of the facility are connected by electrical cables in ducts. Section 11.9 shows the extent of these.

The ramp down to the portal building will have district heating coils installed in it, to keep the roadway free of ice and thus avoid skidding.

11. OPERATIONAL AREA - COMMON
11.11 POSSIBLE EXTENSION AREAS

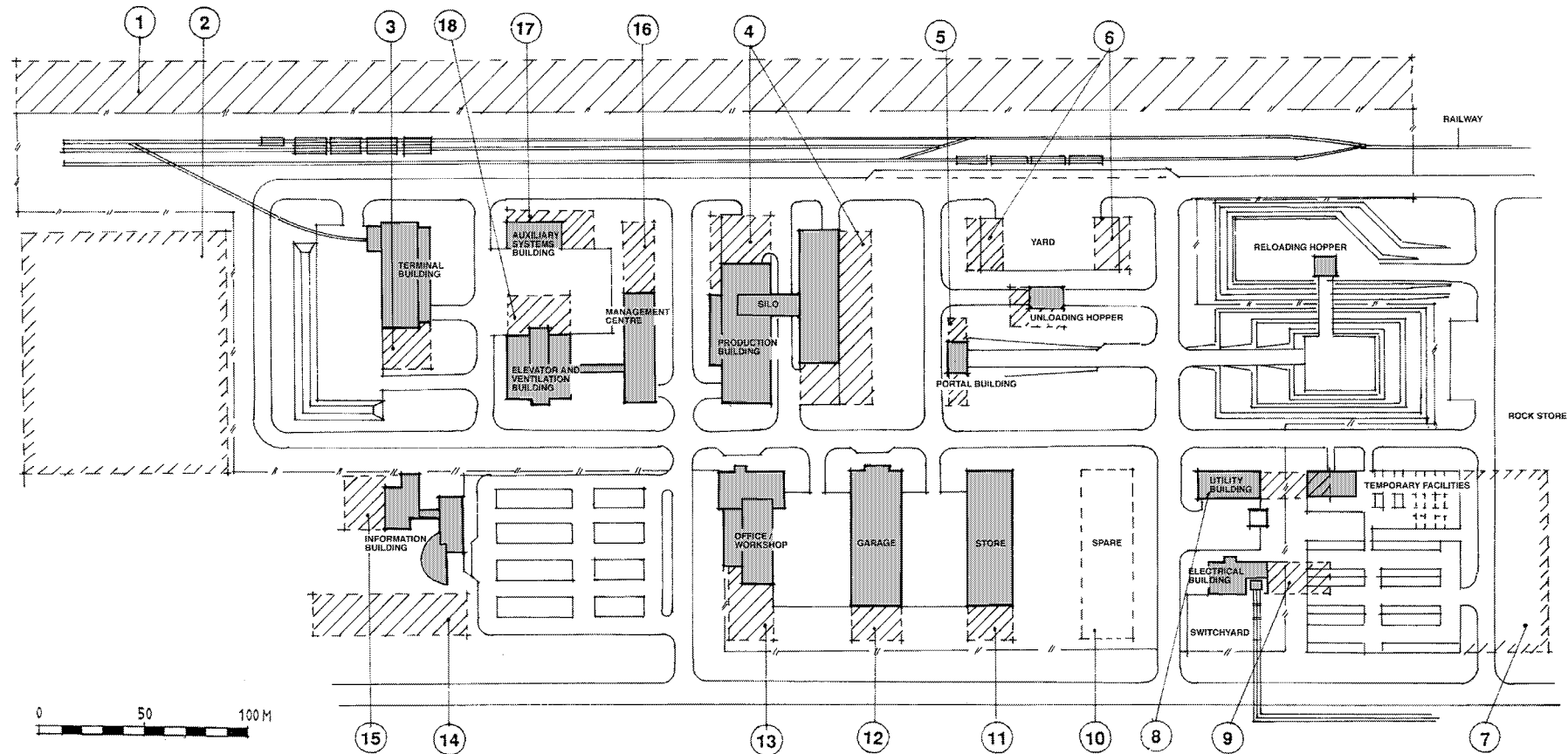

The following opportunities for expansion are available in the operational area

Pos. Area/building

1. The railway yard can be enlarged with more tracks
2. Spare land for future needs
3. The terminal building can be lengthened
4. The production building can be both lengthened and enlarged in various ways
5. The portal building can be lengthened
6. New buildings can be built on the yard
7. The area for temporary facilities can be enlarged
8. The utility building can be lengthened
9. The electrical building can be lengthened
10. Additional storage/workshop building can be built

Pos. Area/building

11. The store and workshop building can be lengthened
12. The garage building can be lengthened
13. The office and workshop building can be lengthened for one of the functions or both
14. The parking area can be enlarged
15. The restaurant section can be enlarged
16. The management centre can be lengthened or a floor added
17. The auxiliary systems building can be enlarged and lengthened
18. The elevator and ventilation building can be enlarged

11. OPERATIONAL AREA - COMMON
11.12 DATA AND DIMENSIONS

AREA		SIZE
1.	Total area utilised	180,000 m ²
2.	Industrial area (inside the fence)	120,000 m ²
3.	Area for temporary facilities	12,000 m ²
4.	Area built on	13,000 m ²
5.	Area built on as proportion of area used	7,2 %
6.	Asphalted roads	11,000 m ²
7.	Asphalted areas	15,000 m ²
8.	Gravelled areas, excluding railway yard	16,000 m ²
9.	Green spaces	120,000 m ²
10.	Number of parking spaces	280
11.	Highest building in the area	30 m
12.	Area of railway yard	12,000 m ²
13.	Track length of railway yard	1 500 m
14.	Area for excavated rock	80,000 m ²
15.	Excavated rock (stored, loose volume)	1,000,000 m ³
16.	Total length of fence	1 900 m
17.	Length	600 m
18.	Width	300 m

General

The area for stockpiling rock has been chosen on the basis that the volume of rock needed for production of backfilling material needed for backfilling of the repository when the deposition of canisters has ended will be stored temporarily near the operational area. The surplus will be sold.

This summary has not taken into account the use of excavated rock for preparing the operational area.

11. OPERATIONAL AREA - COMMON
11.13 SITE ARRANGEMENT – EXCAVATION OF RAMP AND SHAFT

Procurement strategy

The facility will probably be procured in a number of contracts. Consequently, several contractors will be working at the site at the same time.

In order to carry out the work, temporary buildings and systems will be required – referred to as temporary facilities. Unless agreed otherwise, these temporary facilities will be taken down and removed when the construction and installation work comes to an end.

Co-ordination

SKB is responsible for planning the workplace and arranging for co-ordination between the contractors.

Protection against trespassing

SKB will erect a fence around the site. Vehicles entering the area will be checked from a guard hut at the main entrance. SKB is responsible for guarding the area.

Parking areas

There should be spaces for all cars to be parked outside the construction area.

Parking areas are located next to the SKB facility office and information building, and next to the main gate.

Heavy vehicles, trucks, mobile cranes etc. are parked inside the fence.

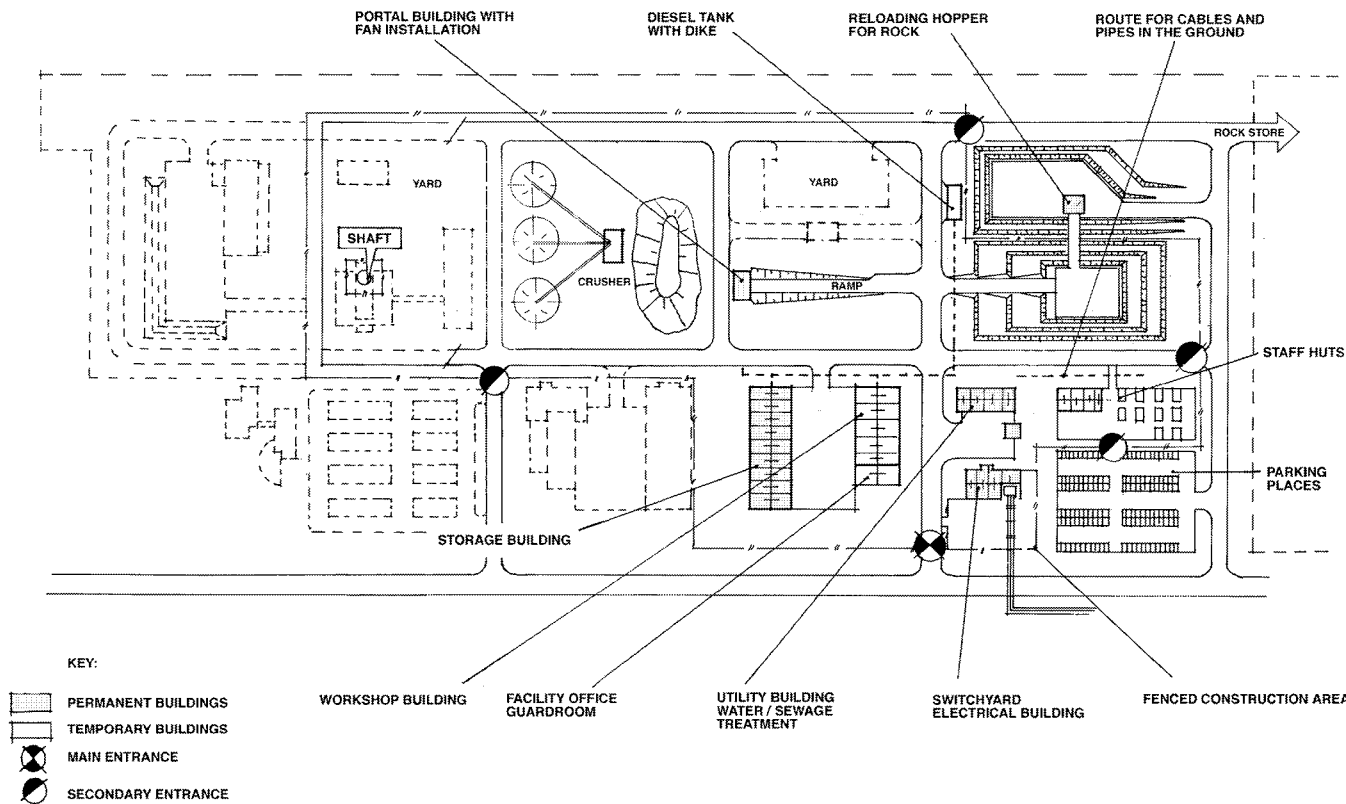

Temporary facilities - Generic arrangement

The figure shows how the construction site and associated facilities can be arranged in order to provide an efficient workplace.

**11. OPERATIONAL AREA - COMMON
11.13 SITE ARRANGEMENT – EXCAVATION OF
RAMP AND SHAFT**

Catering

A temporary canteen, intended to serve both the SKB's and the contractor's staff, will be set up on the site. It is intended that the canteen will be operated as a contract.

Accommodation

If the facility is near a community, accommodation there should be used in the first instance. If this is not practicable and/or the facility is in a remote location, a caravan park will be arranged in a suitable place.

Health care

If the facility is relatively near a large population centre, the community health centre should be used.

If the facility is located a long way from the nearest large community, a basic health care facility will be set up, staffed by a nurse. The main task will be to deal with work injuries and accidents.

Storage

Places for putting the contractors' materials, storage buildings etc. will be organised in the area.

General lighting

SKB arranges general lighting, both indoors and outdoors. Each contractor is responsible for additional lighting as required.

Collection points for building waste

SKB arranges collection points for building waste, scrap etc., and is responsible for removal.

Cleaning – refuse collection

Each contractor is responsible for cleaning and refuse collection in his work area.

Snow clearing

SKB is responsible for snow clearing and sanding roads in the area, and the parking areas. However, storage yards are cleared of snow by the contractors.

Water for fire protection

SKB sets up a number of fire hydrants in the area.

Utilities

SKB arranges the following utilities within the building area with prepared, strategically placed connection points:

- Electrical power
- Water for fire protection
- Potable water
- Sewage
- Telephones

SKB's temporary buildings

SKB requires the following temporary buildings:

- Office for site management
- Guard building (possibly co-ordinated with the office for the site management)

There will probably be up to 20 facility staff.

The contractors' temporary facilities

Each contractor is responsible for providing his own personnel areas, as required. The personnel areas are located inside the fence, at locations provided by SKB. The personnel areas will be put as near each contractor's work area as possible, bearing in mind the desire for short walking distances.

Each contractor will organise its own storage area as required, in areas indicated by the owner.

The total number of staff may amount to 200-400 persons.

Other

Main roadways and access roads to the various parts of the facility should have a hard surface.

Premises for information activities will be arranged at an early stage.

- 12.1 List of buildings
- 12.2 Office and workshop building
- 12.3 Information building
- 12.4 Garage building
- 12.5 Storage building
- 12.6 Utility building
- 12.7 Electrical building / Switchyard
- 12.8 Reloading hopper
- 12.9 Unloading hopper
- 12.10 Portal building
- 12.11 Production building
- 12.12 Management centre
- 12.13 Elevator and ventilation building
- 12.14 Auxiliary systems building
- 12.15 Terminal building

12. OPERATIONAL AREA – BUILDINGS
12.1 LIST OF BUILDINGS

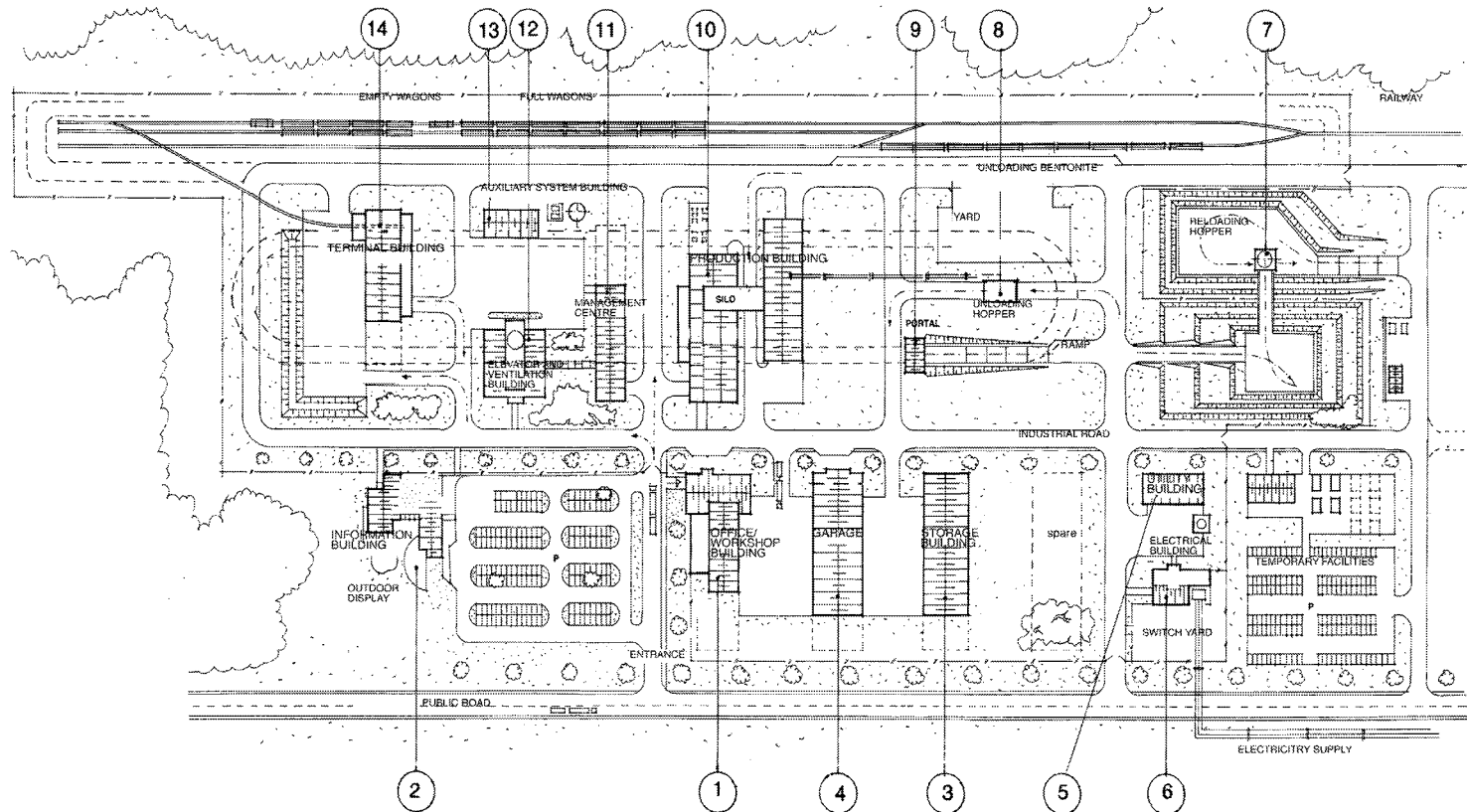

POS.	NAME
1.	Office and workshop building
2.	Information building
3.	Storage building
4.	Garage building
5.	Utility building
6.	Electrical building/Switchyard

POS.	NAME
7.	Reloading hopper
8.	Unloading hopper
9.	Portal building
10.	Production building
11.	Management centre
12.	Elevator and ventilation building
13.	Auxiliary systems building
14.	Terminal building

Layout

The office and workshop building is located in the centre of the facility, where the access road meets the central roadway, around which the various parts of the facility are grouped. The entrance to the building is at the fence surrounding the operational area. This building is the first one that visitors see, so it is the natural entrance/surveillance point in the facility.

This structure consists of a combined office and workshop building, made up of two, linked building sections. The workshop section is the taller building, with a more enclosed quality and larger design details.

The office section is L-shaped, bordering the workshop on two sides. The building has two storeys and an open design, with softer materials, to reflect a human scale.

The lower storey of the office section is a service floor, with an entrance and reception area, changing rooms and plant rooms for the operation of the building. The upper floor is devoted to office space, with individual offices and associated rooms, plus two open-plan office areas.

The covered atrium acts as a natural link between the two floors, and creates a spirit of community between the various occupational groups working in the building. The atrium is the central point of the building.

The workshop, storage areas, changing rooms and office can all be expanded, if necessary, without altering the overall function of the building.

Office section

The angled office section is on two floors, with an inner atrium. The whole of the upper floor is a “quiet” office floor. The lower floor is primarily a service floor for the building.

The entrance to the building is situated at the crossing of the access road and the central road through the facility, which is called *Industrigatan*. The entrance hall is located here, with a cloakroom, toilets and reception, as well as a post room and registry. The reception has a good view over the access road and *Industrigatan*. The entrance hall is constructed as a covered atrium, which links the upper floor with the lower one. Around the atrium, there is a staircase, elevator and a large conference and lecture hall.

Beyond the conference room there are offices, staff rooms and a laboratory, which is intended for research work on rock. This arrangement provides short distances to the storage area for rock samples and via a secondary staircase to the office that is intended for researchers, geologists and other staff carrying out work on the rock.

At the other end of the building, the ground floor contains changing rooms for men and women, and a changing room for occasional visitors. There are also secondary premises here for the workshop and technical areas, for the operation of the building.

The entire upper floor is intended for office space, which is divided in two by the atrium in between. The intention is that the maintenance department, administration and operations management will use one part and staff carrying out geotechnical work will use the other. The office section consists of individual offices and associated ancillary rooms, e.g. store, archive, photocopying, and two open plan offices. These can easily be converted to individual offices if desired.

Store and workshop

The workshop is dominated by a large open room, with space for machines and bench work in one half of the room, and an open floor area for assembly/disassembly work in the other half. The workshop has a travelling crane with a free hook height of six metres. In the outer wall, there are windows and a large door, which enables large vehicles to come in and out. In the inner part of the workshop there are small, separate areas for storage, precision engineering, welding and cleaning by means of solvents.

There are two large storerooms in the workshop extension. They are both the same height as the workshop and can have a travelling crane installed if necessary. The walls between the workshop and the storage areas will be constructed so that they can easily be taken down and moved, in order to alter the size of the area to suit any changes in requirements.

Mechanical equipment

The machinery consists of:

- Workshop machines
- Welding equipment
- Cleaning equipment
- Lifting devices

Dimensions

The approximate dimensions of the building are:

Length:	56 m
Width:	32 m
Height:	10 m
Volume:	10,600 m ³

12. OPERATIONAL AREA – BUILDINGS
12.2 OFFICE AND WORKSHOP BUILDING

Functions

The building is intended to house the following functions:

- Site management
- Administration
- Staff
- Reception
- Finance
- Purchasing
- Technology
- Development
- Documentation
- Planning
- Archive
- Project management
- Mechanical workshop
- Bench work
- Machining
- Welding
- Staff areas

Korr. = Corridor

Förråd (Frd) = Store

Städ = Cleaning

Omkl = Changing

Hiss = Elevator

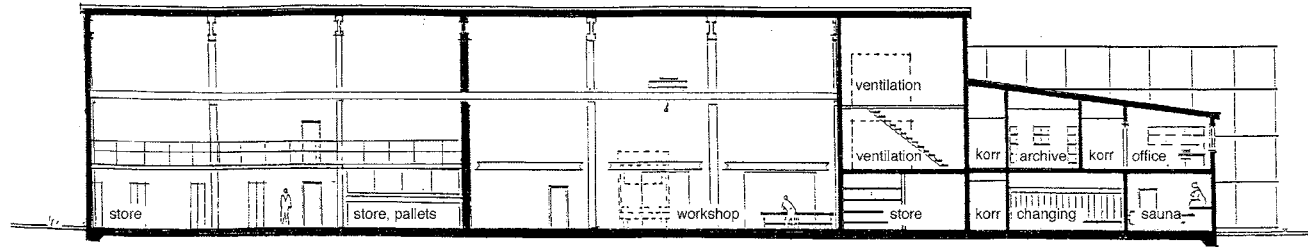

SECTION C-C

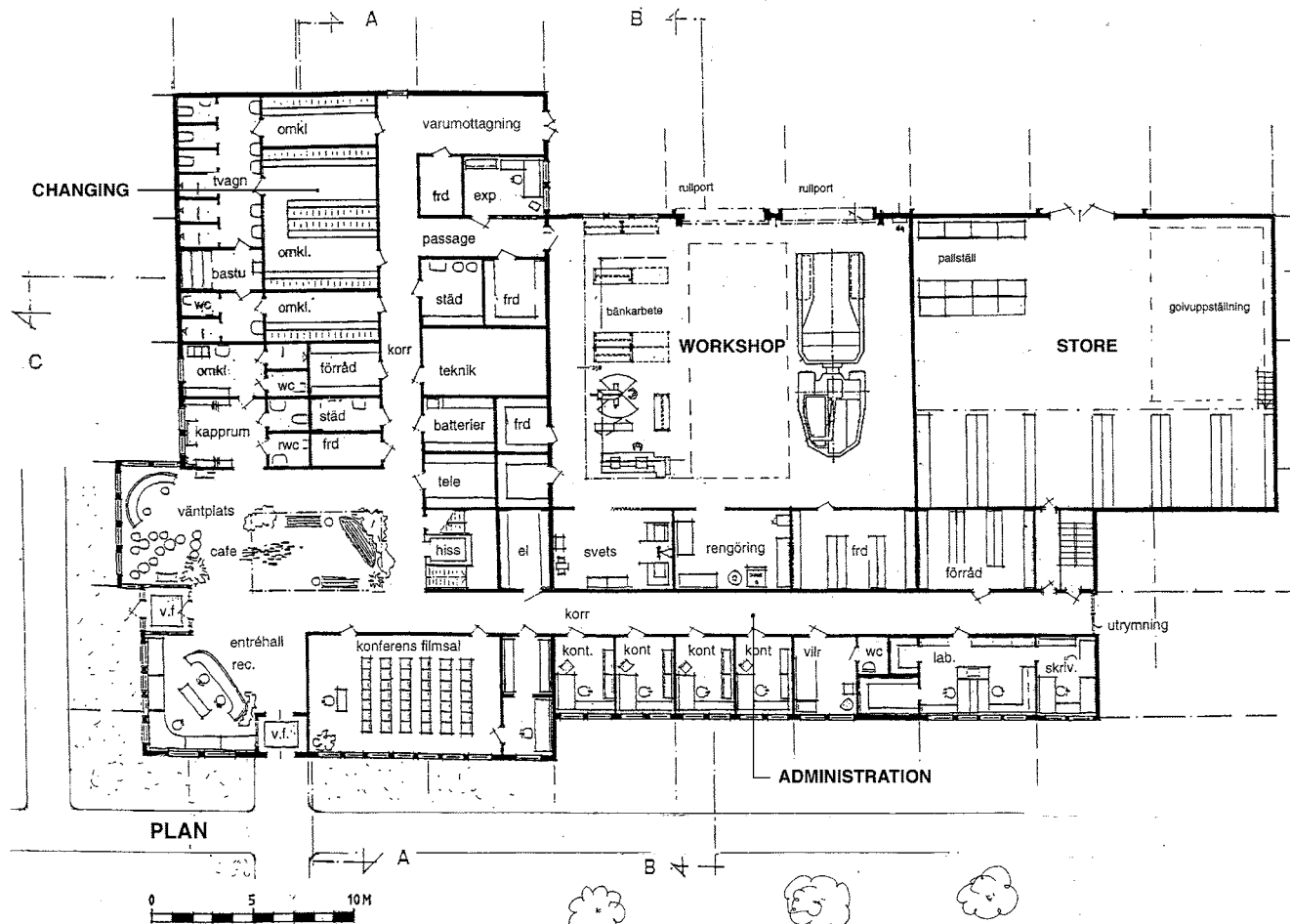

PLAN

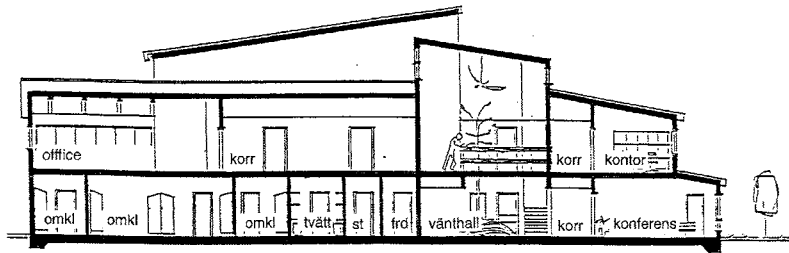

SECTION A-A

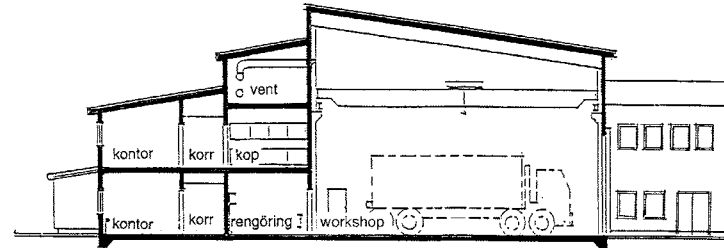

SECTION B-B

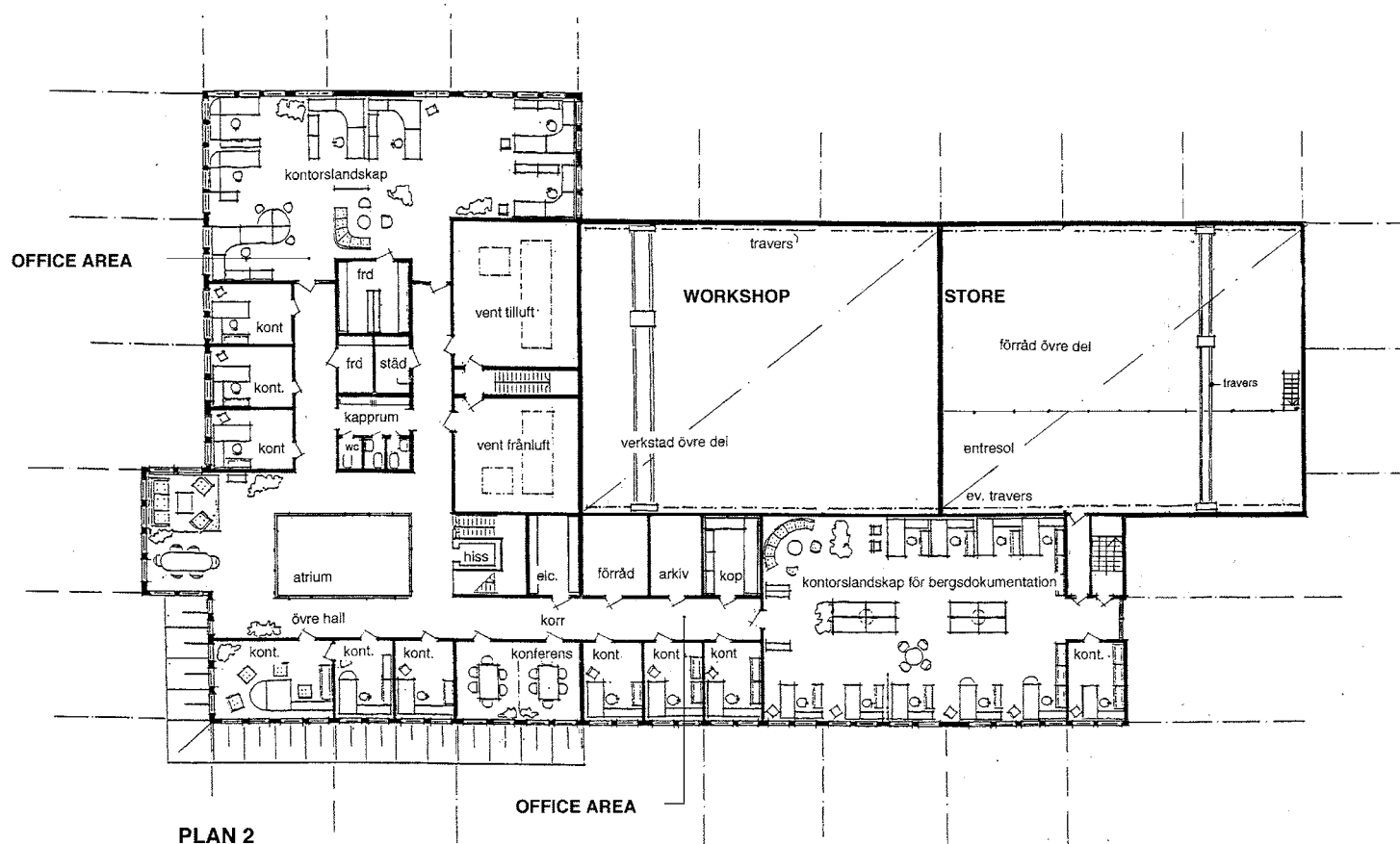

- Kont. / Kontor = Office
- Frd / Förråd = Store
- Städ = Cleaning
- Kapprum = Cloakroom
- Hiss = Elevator

PLAN 2



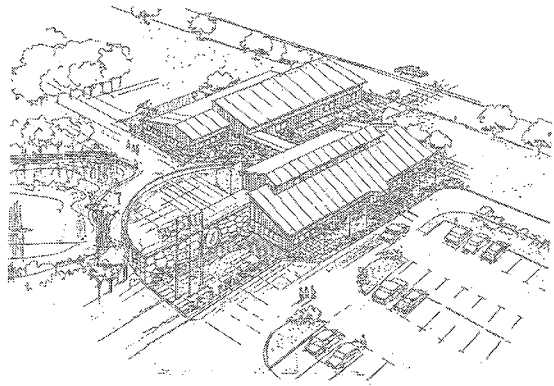

General

Because of the size and nature of the project, many groups from the community are expected to be interested in obtaining various types of information about the operation. For this reason, it is important to build suitable premises for information activities at an early stage in the project, in order to be better prepared to meet expectations. This means that an information building might be built as one of the first permanent parts of the facility.

The building will probably contain a restaurant, which could serve both visitors and facility staff. Most of the visitors are expected to visit only the information building.

Layout

The building consists of two separate sections (an information section and a restaurant section), which are connected to one another by a corridor.

As the activities in the information section are intended for outside visitors, this section faces the access road, and is located outside the operational area. In this way, the operations in the facility are not disrupted by incoming and outgoing traffic.

The restaurant is positioned so that its entrance faces the operational area, to allow the facility staff reach the restaurant. Visitors in the information area enter the restaurant directly, via the connecting corridor.

The following functions are planned for the information area:

- Exhibition hall for displaying objects, models etc.
- Area for information, and audio-visual presentations
- Mock-up of an underground section
- Area outside the building for parking vehicles and standing large components
- Entrance vestibule with reception, cloakroom, toilets etc.
- Group room and rooms for information staff.

The exhibition hall and information area have been put in a semicircular section of the building, in which the exhibition hall is reminiscent of a parabolic screen, which reflects the facility and its activities on large, unbroken areas of wall, in an enclosed exhibition space.

In this way, the exhibition hall will have free wall areas, with space for screens, and a free floor area that can be used for continually changing exhibits. The room is screened from the outside world and on a lower level, so as to direct interest towards the exhibits, and at the same time create a feeling that the facility is below ground. The only real window is a circular, glazed area, around two metres in diameter, which, like a camera lens, points towards the facility and provides a view, but also acts as a display window into the exhibition.

Outside the exhibition hall there will be a yard, where it will be possible to arrange displays of bulky equipment, vehicles etc., which can't be displayed in the exhibition hall. Visitors will get to the yard either straight out from the exhibition hall or from the restaurant, where there can be an outdoor café, in the summer. In the entrance area there is a reception area, cloakroom, toilets, a corridor to the restaurant section and offices for the information centre staff.

Below ground, in the basement, there is an exhibition area in the form of an imaginary section of tunnel from the deep repository. This is reached by elevator from the exhibition hall.

12. OPERATIONAL AREA – BUILDINGS

12.3 INFORMATION BUILDING

The restaurant consists of a large dining room and a smaller guest dining room. In the summer, the outdoor café, mentioned earlier, will also be open.

The entrance to the restaurant faces the operational area, which is principally intended for facility staff. Visitors, most of whom will be in the information building, get to the restaurant via the corridor.

Goods, refuse etc. are transported to and from the restaurant via the goods area at the rear of the building. These vehicles will have to pass through the gate.

Capacity

The exhibition area has been designed for a normal busload of visitors at the same time, i.e. 50-60 people.

The restaurant can seat approximately 90 people in the large dining room. This will necessitate 2-3 sittings during the periods when the maximum number of people are working here. The guest dining room can seat 10-12 people.

Dimensions

The approximate dimensions of the building are:

Information section

Length:	46 m
Width:	20 m
Height:	7 m

Restaurant section

Length:	29 m
Width:	18 m
Height:	6 m

Whole building

Length:	57 m
Width:	39 m
Volume:	5,000 m ³

12. OPERATIONAL AREA – BUILDINGS
 12.3 INFORMATION BUILDING

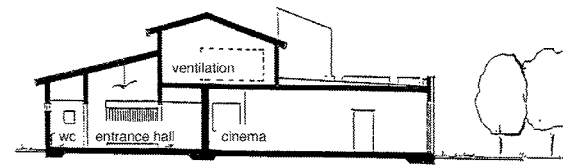
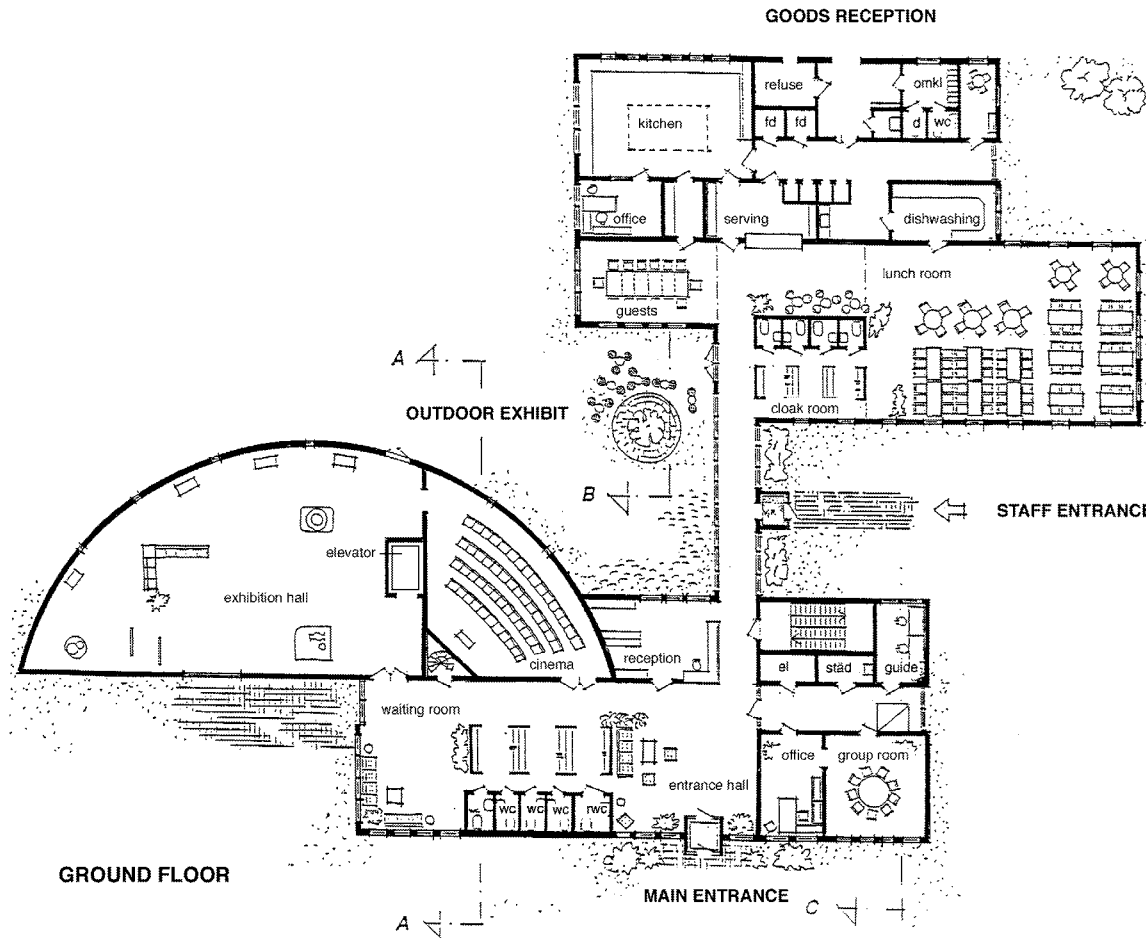

SECTION A-A

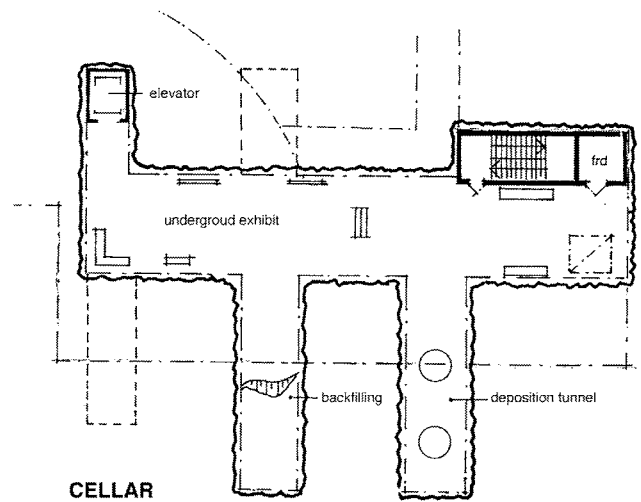

CELLAR

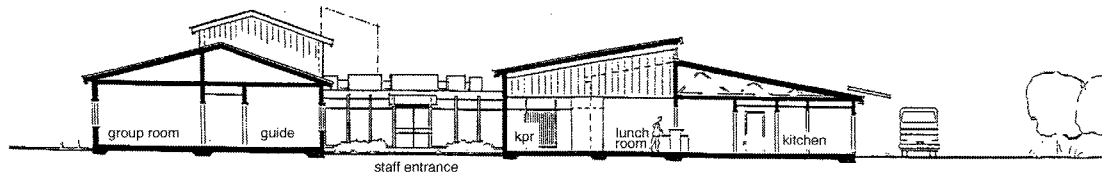

SECTION C-C

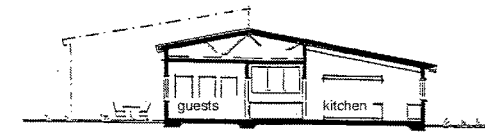

SECTION B-B

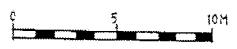

General

As described in chapter 8, the operation and maintenance of the deep repository require a considerable number of vehicles of various types to be available. In order to keep these vehicles in working order, it is important to park them in a garage when they are not in use. In addition, cleaning, repair and servicing facilities must be available, particularly for those units that are too large to be driven on public roads.

Operations

The following operations are intended to be carried out in the garage building:

- Parking of vehicles and machines in heated premises
- Servicing and repairing vehicles.
- Storekeeping of spare parts, tyres, lubricating oils and consumables for the vehicles.

Base for vehicle drivers, including changing room, washing and lunch breaks, as well as dealing with worksheets.

Layout

The garage building contains sub-areas for the following functions:

- Offices and staff
- Workshop with store
- Washing hall with cleaning equipment
- Garage for large ramp trucks
- Garage for large and small standard vehicles, including tractors and associated equipment.

The relatively long building is positioned with the office and staff section facing the main roadway running through the operational area.

The office and staff section is on two floors, of which the ground floor mainly is used for locker rooms. There are also some offices.

The upper floor is used for staff room, kitchenette and group room and office for planning of the workshop activities. As the workshop building is located next to the garage building it is assumed that available offices and staff premises in the garage building will be used by staff from both buildings.

This floor also houses electrical and fan rooms for the requirements of the whole building. The rest of the building is divided into separate areas, to suit the nature of the tasks involved.

The large vehicle hall has doors at both ends, to make it easier to arrange the vehicles as required.

Special equipment

- Travelling crane for servicing in the workshop section
- Max. load 5 tons
- Span 11 m
- Length of crane track 15 m
- Max hook height 6 m
- High-capacity drainage channel with an inspection chamber in the washing hall
- Special cleaning equipment for the vehicle washing water.

Dimensions

Length:	65 m
Width:	25 m
Height:	9 m
Floor area in office and staff section:	285 m ²
Floor area in workshop and garage section:	1,265 m ²
Volume:	12,000 m ³

12. OPERATIONAL AREA – BUILDINGS
 12.4 GARAGE BUILDING

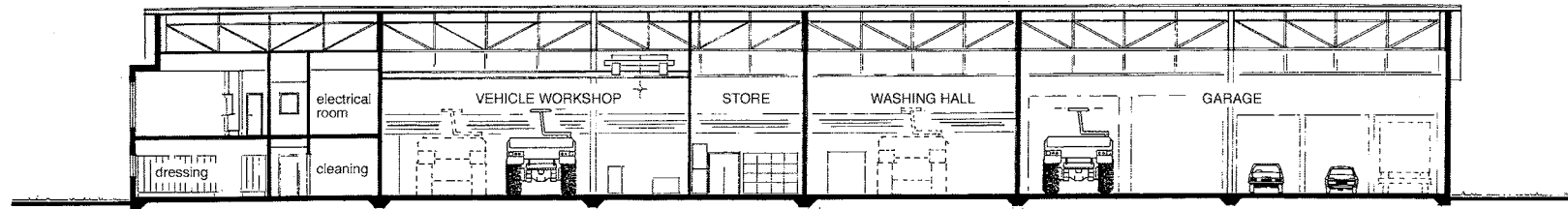

SECTION A-A

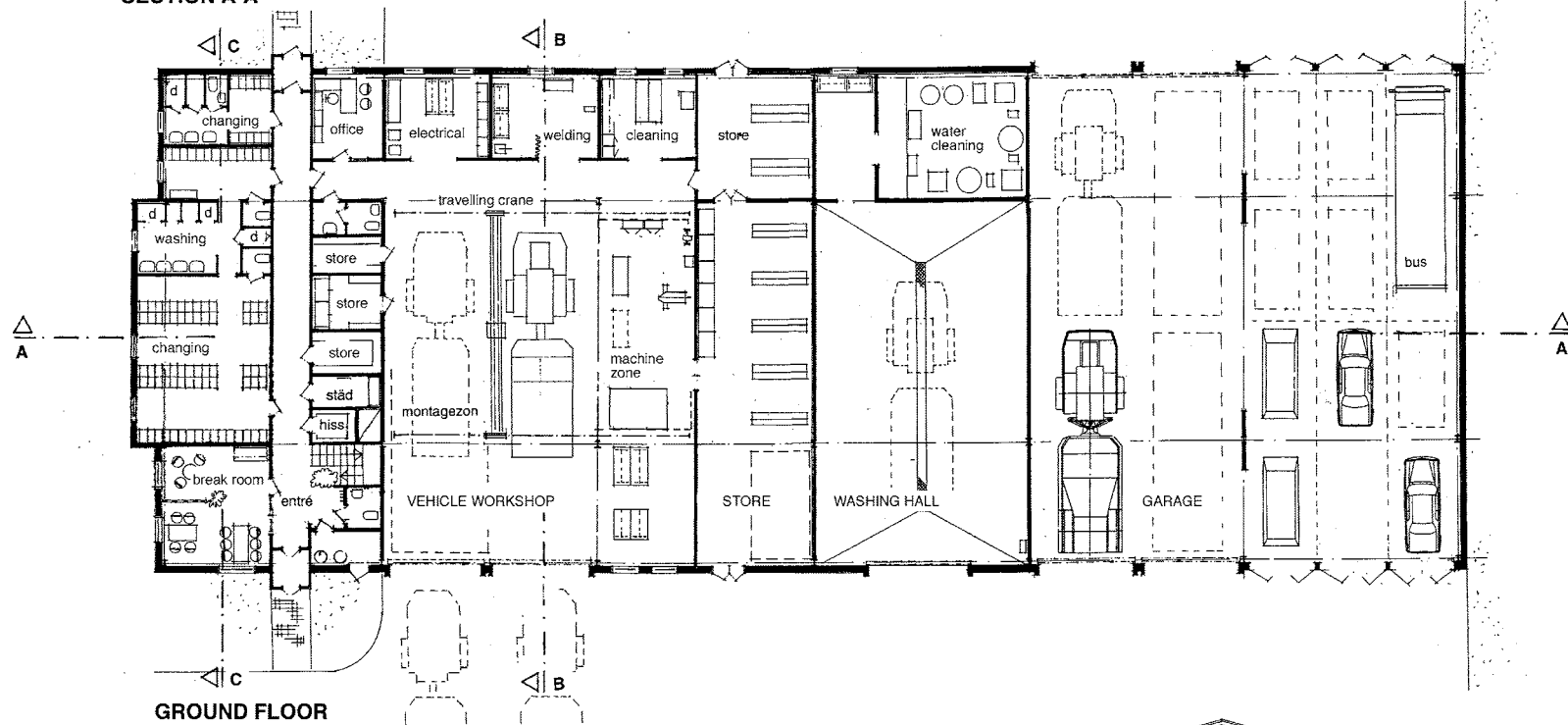

GROUND FLOOR

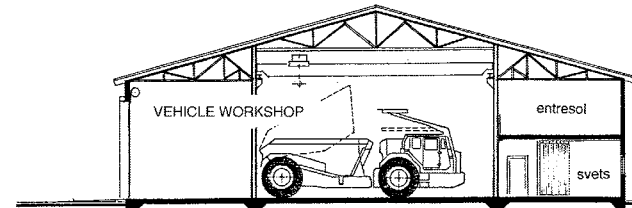

SECTION B-B

- D = Shower
- Städ = Cleaning
- Hiss = Elevator
- Entré = Entrance

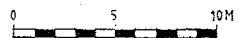

12. OPERATIONAL AREA –BUILDINGS
12.4 GARAGE BUILDING

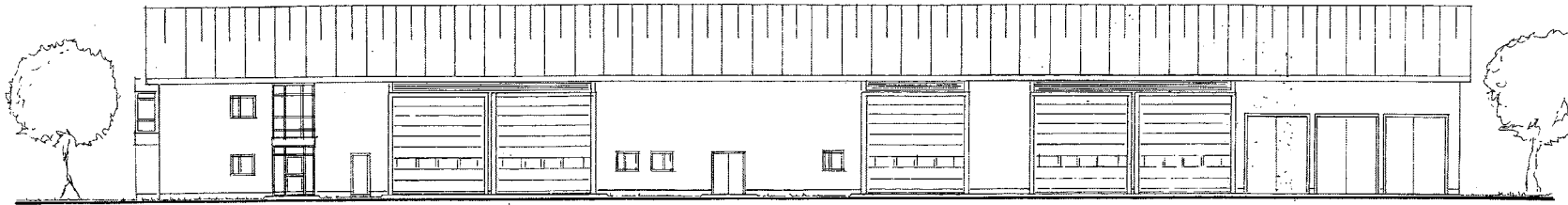

FRONT ELEVATION

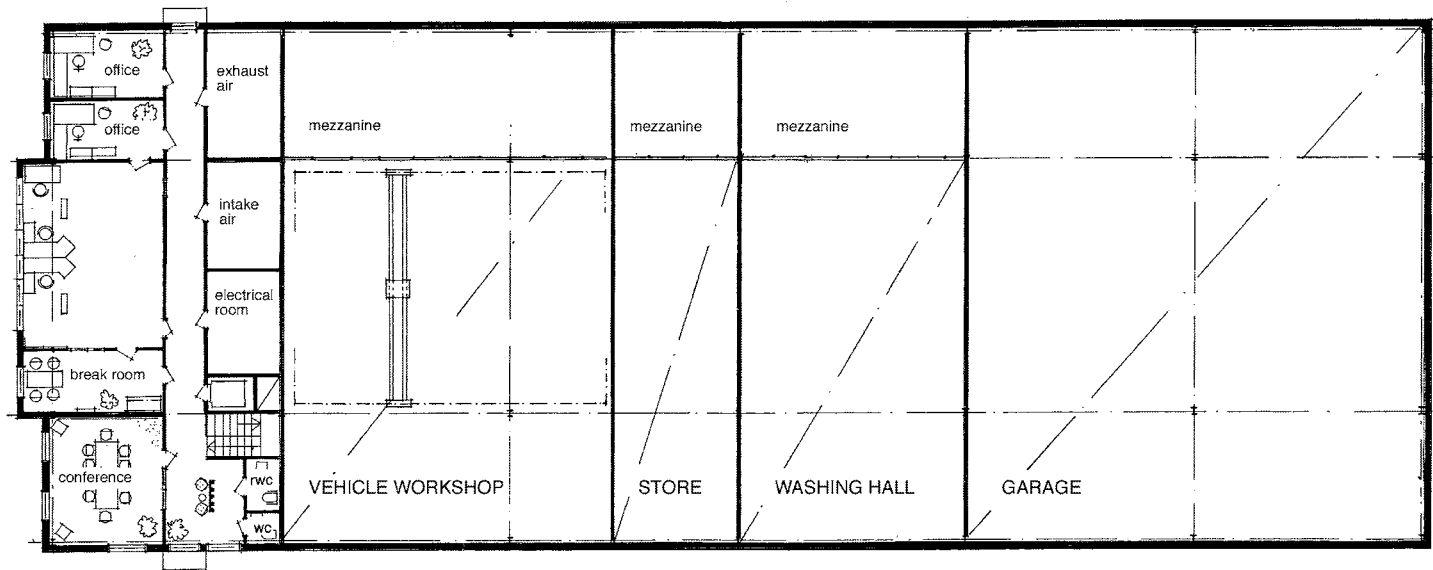

UPPER FLOOR

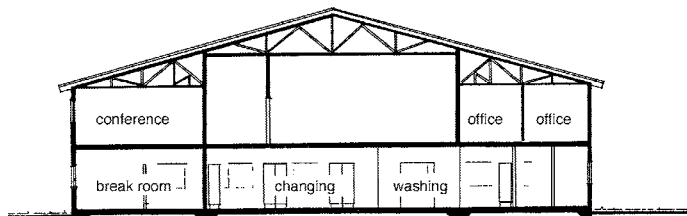

SECTION C-C

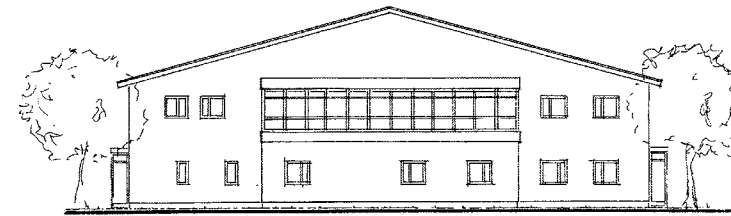

END ELEVATION

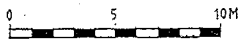

General

All goods transport to the deposition level should be made via the ramp from the operational area. In order to be able to handle incoming goods, it is necessary to have premises for that purpose.

Premises are required for the following functions:

Dispatching

- Receipt of goods
- Delivery checks
- Distribution
- Administration

Storage

- Spare parts
- Installation materials
- Building materials
- Consumables
- Instruments

Core sample storage

- Storage
- Examination
- Documentation

Operations

The dispatch and store section is staffed during the day, to deal with incoming goods. In addition to checks on incoming goods and interim storage, the work involves being responsible for the internal distribution to the final user out in the facility and dealing with transport vehicles leaving the deep repository.

The core sample storage will be manned at regular intervals, to receive and store core samples from core drilling in the deposition areas. At the same time, specialist geologists will study and evaluate the core samples, to assess how the technical properties of the actual body of rock match the requirements. This work requires the use of a suitable room, immediately adjacent to the storage area.

Layout

The storage building has a traditional design for this type of function.

The building is divided along its length into three, parallel bays.

The middle bay is full height and has a crane track running through it. The side bays have an upper level along most of their length. The building does not have a basement.

The building is divided along its length into a dispatch section, a store for general requirements and an area for studying and storing core samples.

Each section has entrances from the same side. Staff and work areas are on the side facing the access road.

The design of the building makes it easy to adapt to prevailing requirements and wishes.

Special equipment

- Travelling crane
- Pallet racks
- Shelving racks
- Bays

Dimensions

Length:	65 m
Width:	25 m
Height:	9 m
Floor area excl. mezzanine:	1,625 m ²
Volume:	12,500 m ³

12. OPERATIONAL AREA – BUILDINGS
 12.5 STORAGE BUILDING

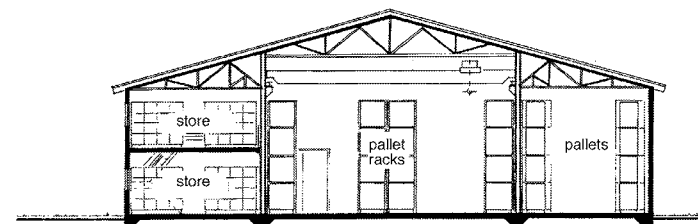
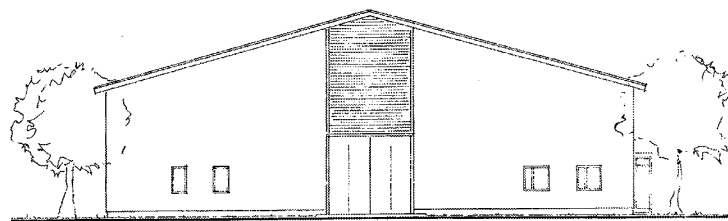
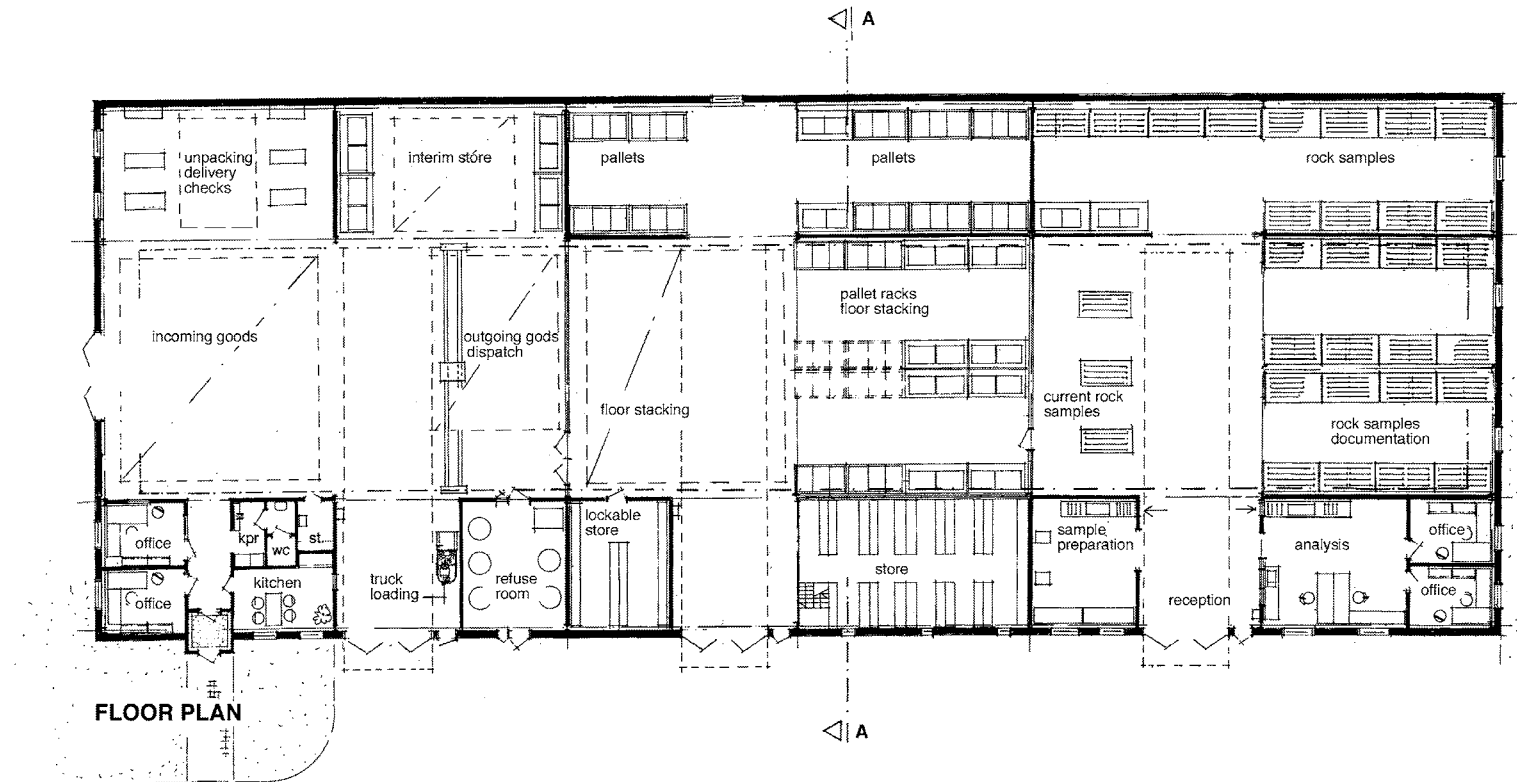

12. OPERATIONAL AREA – BUILDINGS
12.5 STORAGE BUILDING

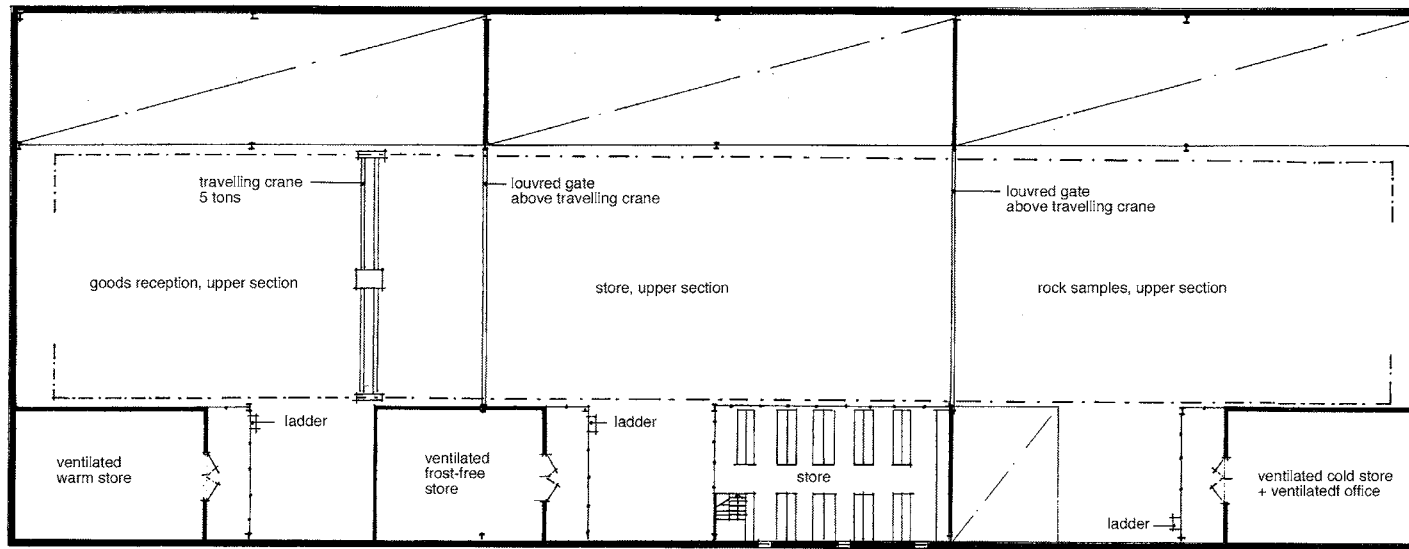

UPPER FLOOR

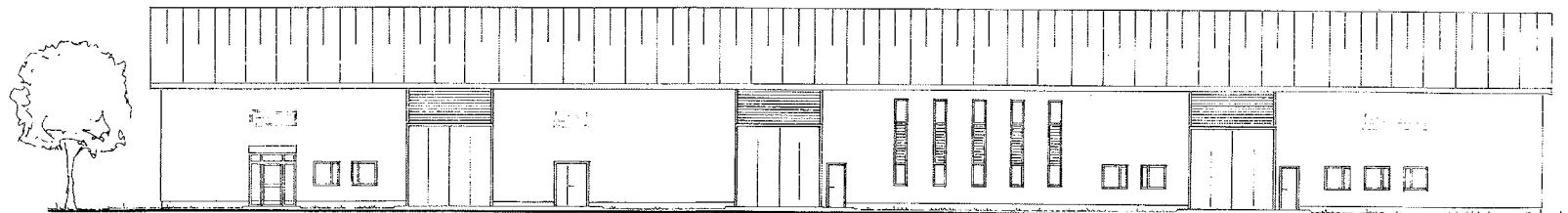

FRONT ELEVATION

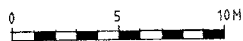

12. OPERATIONAL AREA –BUILDINGS
12.6 UTILITY BUILDING

General

In this description, it is assumed that the deep repository is located in a place where there is no municipal infrastructure for water, sewerage and district heating. Consequently, the operational area will have to be equipped with its own local infrastructure. A special building is needed for this, with separate areas for a boiler room, water treatment plant and sewage treatment plant. The systems will be designed to meet the requirements during both the building and operating phases. It is assumed that raw water will come from a nearby well or lake. The potable water will also be used as fire fighting water.

The sewage is treated both biologically and chemically. The sewage treatment section will also be designed so that it can receive wastewater from the central area on the -500 metre level, which will be transported up to the operational area by a sludge emptier.

The heating system consists of an oil-fired boiler with associated distribution pumps. The system in the utility building is connected to an external pipe network, which links all of the buildings in the area. See section 11.9.

Layout

The building is designed as a hall, divided into areas for four functions, as described below. There are no internal connections between the four functions, for environmental reasons. There is no need for staff premises in the building.

- Water treatment plant
- Boiler room with chimney and fuel oil tank with a retaining dike
- Sewage treatment plant
- Property maintenance store

Operations

The operations in the building are limited to normal maintenance. It is envisaged that the operations will be monitored from the operations centre.

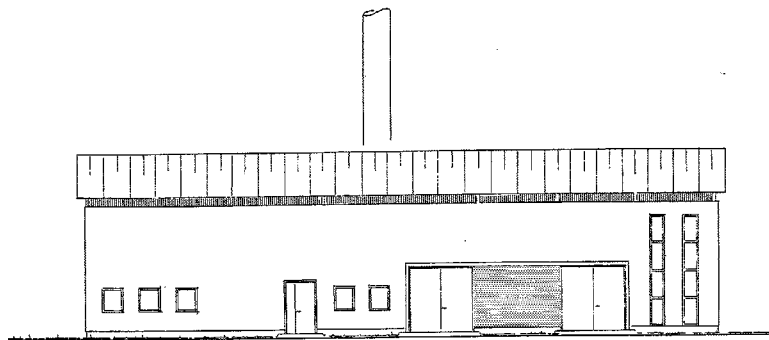

FRONT ELEVATION

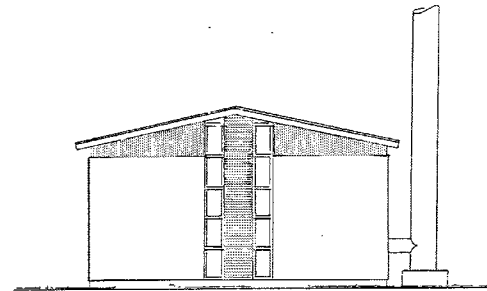

END ELEVATION

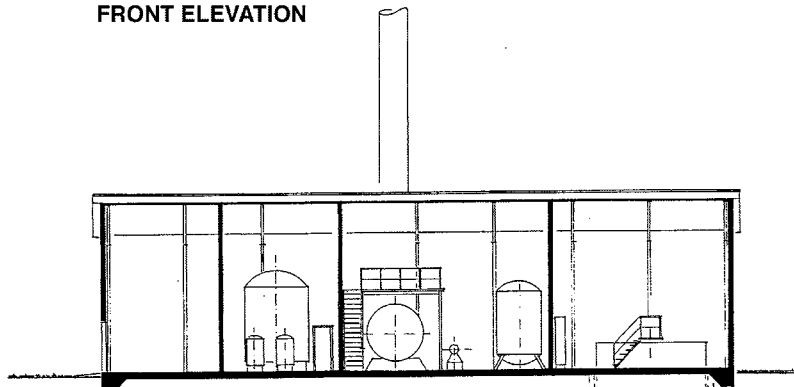

SECTION A-A

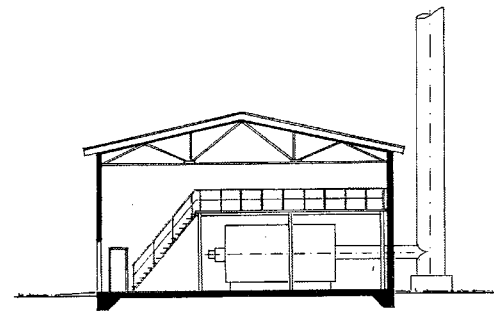

SECTION B-B

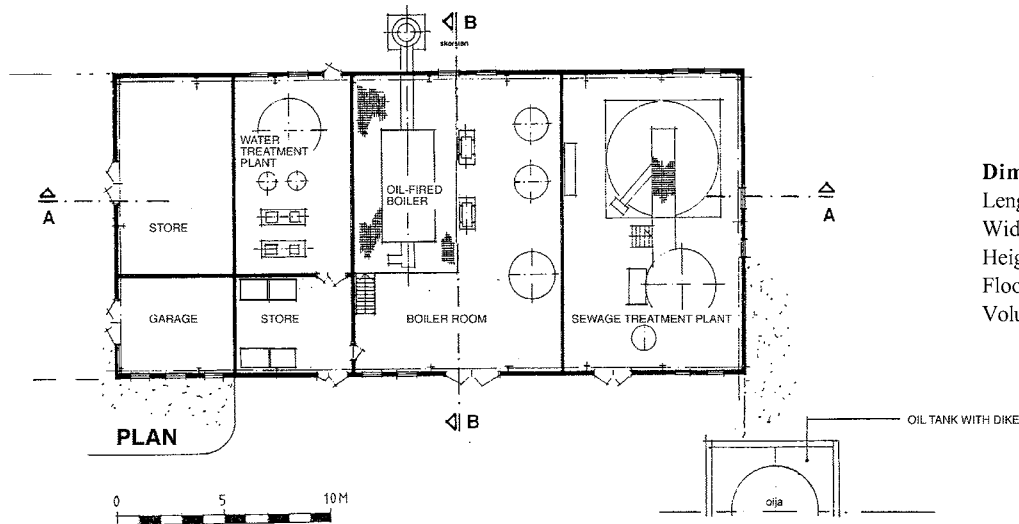

Dimensions

- Length: 28 m
- Width: 14 m
- Height: 9 m
- Floor area: 400 m²
- Volume: 34,000 m³

12. OPERATIONAL AREA - BUILDINGS

12.7 ELECTRICAL BUILDING / SWITCHYARD

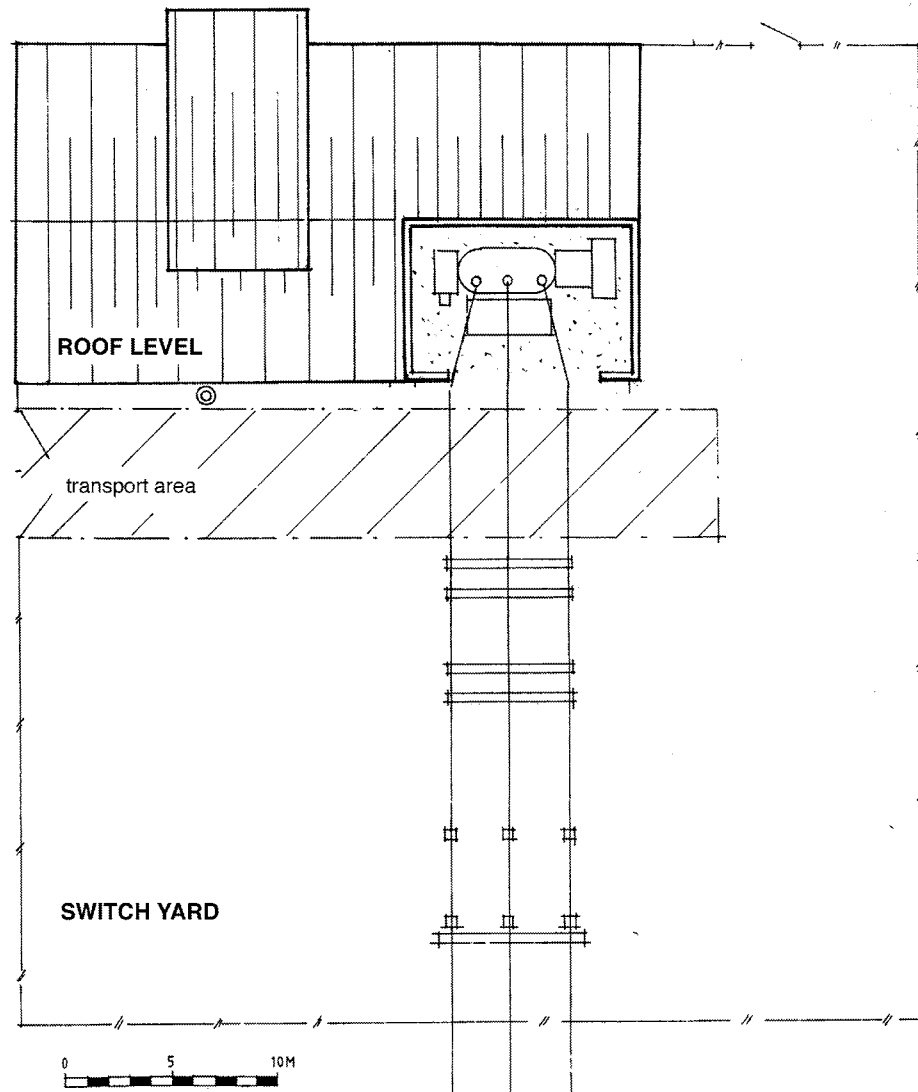

General

As can be seen from the proposal for supplying electrical power to the deep repository, which is described in section 19.3, a switchyard with connected electrical building is required for distribution of power both to the above ground facility as well as the underground facility.

The electrical building contains areas for the following functions:

- High voltage switchgear room
- Low voltage switchgear room
- Switchgear room for primary power
- Equipment room for control equipment etc.
- Standby power unit
- Area for servicing circuit breakers
- Transformer bay
- Store

Operations

The switchgear and the standby power unit require only occasional inspection. Maintenance of circuit breakers can be made in a special room. The electrical building provides a temporary workplace for this.

Layout

The electrical building is on one level, divided into three sections, each designed for its particular function, starting with the switchgear rooms.

The transformer for incoming power is in an open bay, integrated with the electrical building.

On the same side as the switchgear rooms, there is a separate room for a standby power unit. Transformers for outgoing power to various facilities are located on the opposite side of the switchgear rooms. A cable space below ground links the three switchgear rooms. Outgoing cables connect to external, underground ducts.

Dimensions

Length:	40 m
Width:	16 m
Height:	8 m
Floor area excl. transformer bay:	560 m ²
Volume:	2,500 m ³

12. OPERATIONAL AREA - BUILDINGS
12.7 ELECTRICAL BUILDING / SWITCHYARD

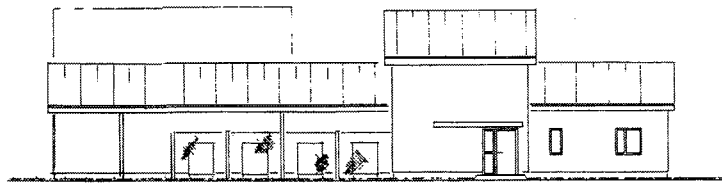

FRONT ELEVATION

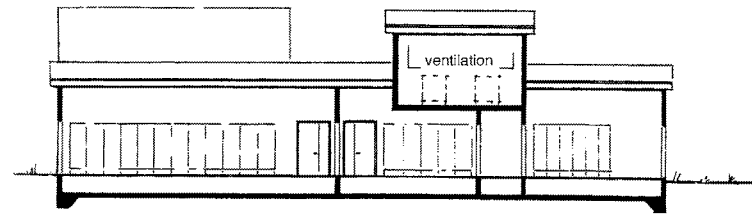

SECTION A-A

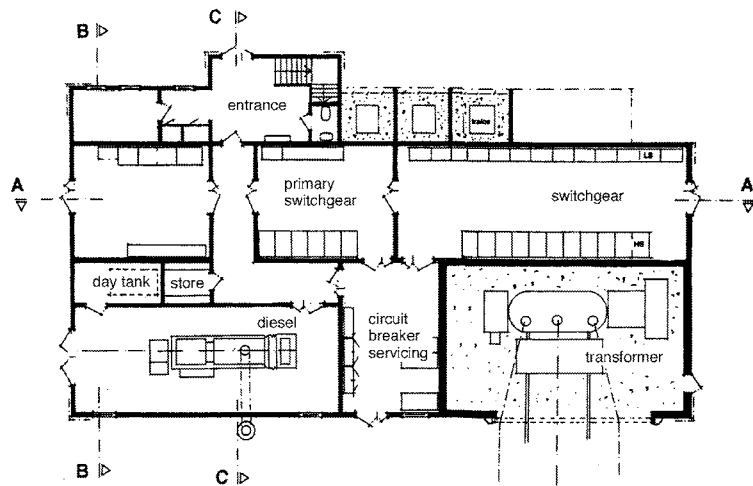

GROUND LEVEL

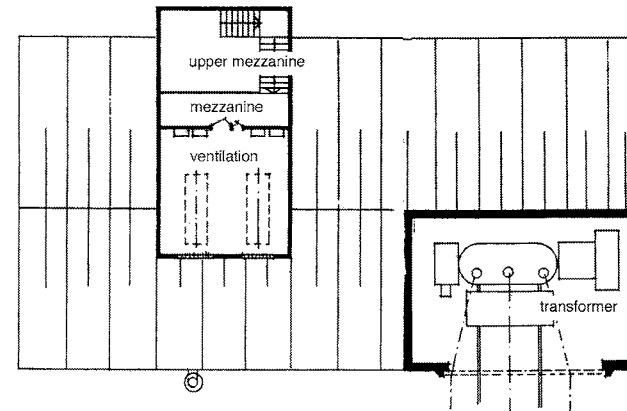

LEVEL 2

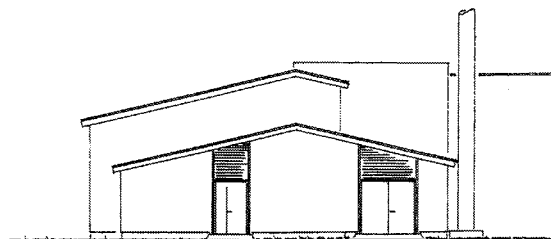

END ELEVATION

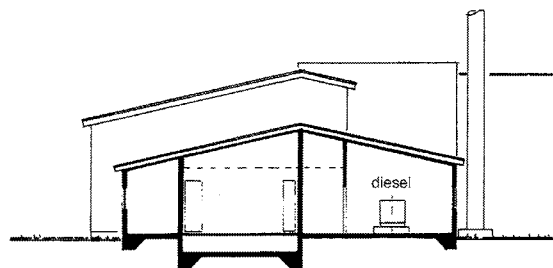

SECTION B-B

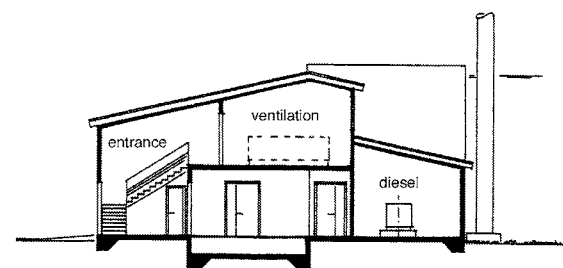

SECTION C-C

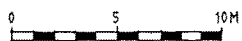

12. OPERATIONAL AREA – BUILDINGS
 12.8 RELOADING HOPPER

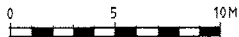
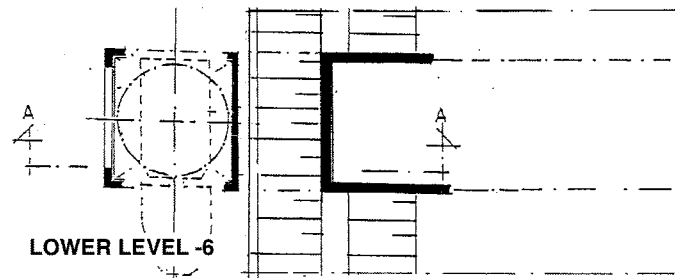
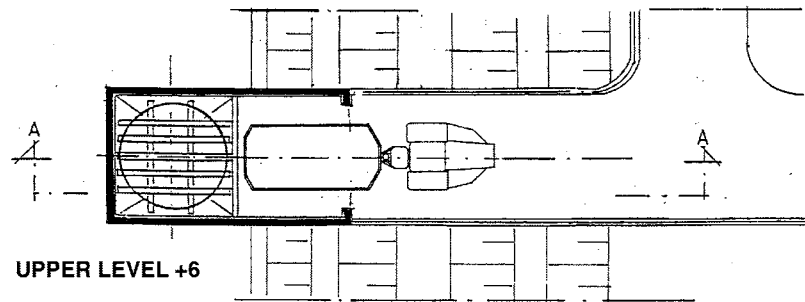
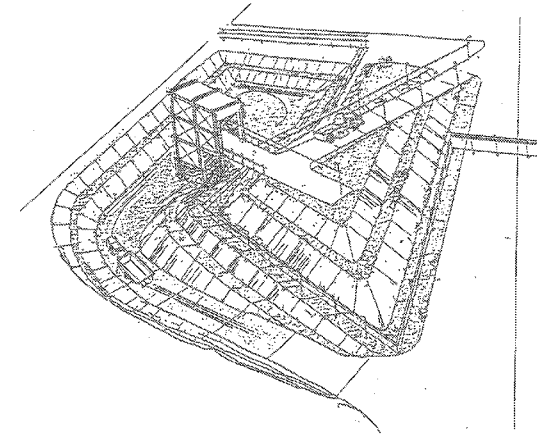
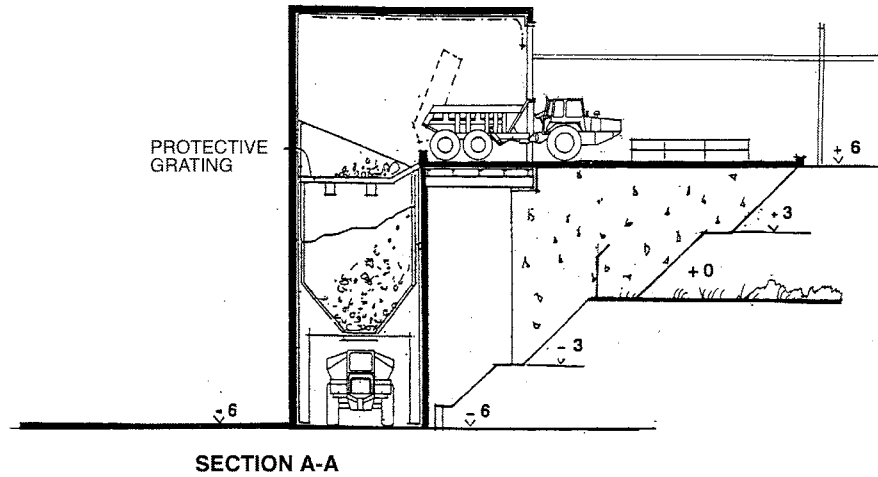

For environmental reasons, rock from the underground area is transported up the ramp to the surface using electrically driven rock dumpers. As it is not practically possible to transport rock by electrically driven vehicles all the way to the stockpiling area, it will have to be reloaded on the surface, near the mouth of the tunnel. The proposed solution is that the reloading will be achieved using a hopper, which has ramps for the vehicles to the top and bottom sections. The hopper is located at the fence, such that the unloading point for the electrically driven dumper is inside the fence and the loading point for the diesel-driven dumper is outside the fence. It is envisaged that the hopper will be unmanned. The dumper driver will take care of unloading and loading.

12. OPERATIONAL AREA – BUILDINGS
12.9 UNLOADING HOPPER

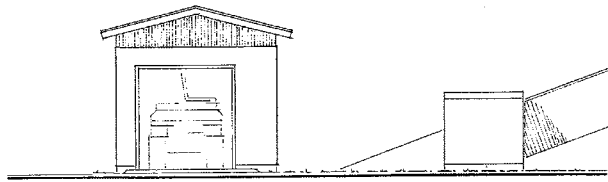

END ELEVATION

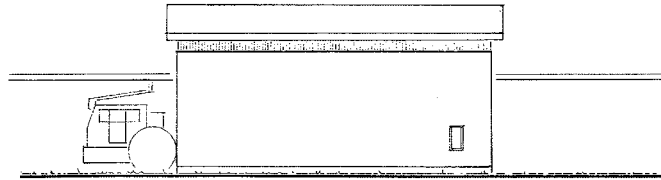

FRONT ELEVATION

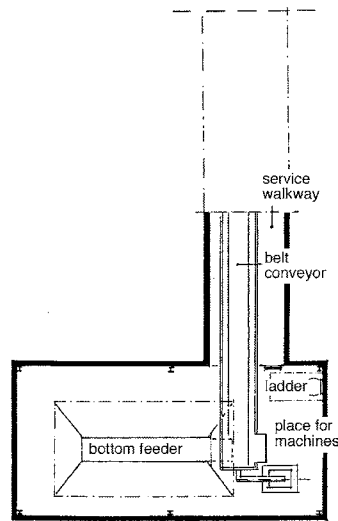

CELLAR

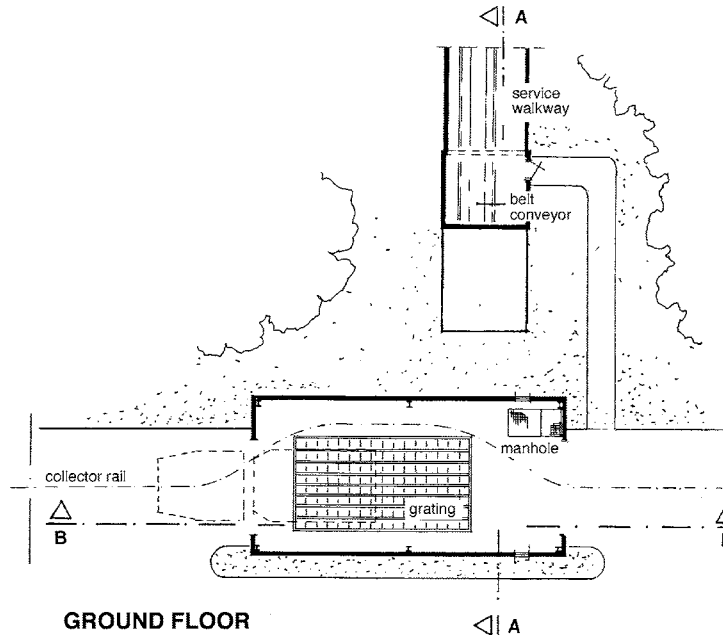

GROUND FLOOR

General

New deposition tunnels will be excavated at the same rate as the canisters are deposited. In this way, there will be a good balance between excavation and backfilling when the backfilling phases are underway. Rock for reuse is stored temporarily while waiting to be crushed and mixed with bentonite, after which it is transported back to the deposition level. In order to make the transport work more efficient, an building with an unloading hopper will be built, so that the trucks can easily tip their loads and then immediately continue to load backfilling material.

Operations

The drivers tip their loads by driving forwards and stopping over the hopper. The conveyor belt starts automatically and runs as long as there is material in the hopper. The volume of the hopper is equivalent to two loads. This avoids waiting time between trucks. Any pieces that don't fall through the grating are removed using a tractor loader.

Layout

The unloading hopper consists of a concrete structure, sunken into the ground. It contains a rock hopper and space for a bottom feeding device and a belt conveyor. The belt conveyor transports the rock up to a distribution belt in the roof of the rock store section of the production building. The floor consists of a grating of steel sections, which cover the hopper below. The superstructure is steel, with covered sides and open gables. The superstructure stops rainwater and snow falling down into the hopper, which could make it more difficult to mix in the bentonite later.

Special equipment

- Steel grating
- Bottom feeding device
- Belt conveyor

Dimensions

Below ground		Above ground	
Length:	14 m	Length:	14 m
Width:	3 m	Width:	14 m
Depth:	4.5 m	Height:	7.5 m
Volume:	450 m ³		
Volume of hopper:	85 m ³		

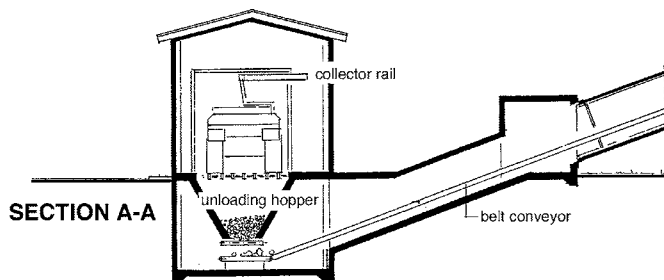

SECTION A-A

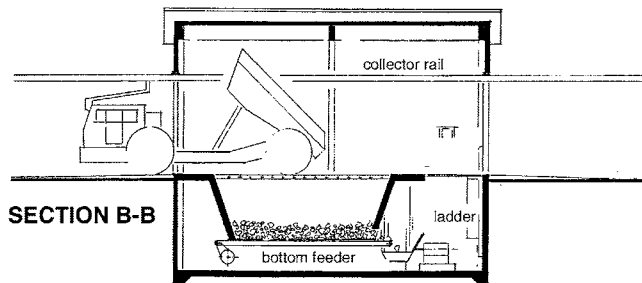

SECTION B-B

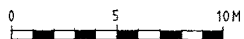

12. OPERATIONAL AREA – BUILDINGS

12.10 PORTAL BUILDING

Layout

The portal building, which is rectangular, is situated transversely over the mouth of the ramp.

The floor of the building also forms a roof over the mouth of the ramp. A staircase links the ground floor with the ramp below. The building on the surface houses exhaust air fans for the ramp.

The façade of the portal building facing the ramp demarcates the underground area from the surface.

Pipes and cables from the electrical building etc. pass from underground ducts to the ramp, where they continue down to the underground area.

The building will be acoustically insulated and fitted with shell protection.

Dimensions

Above ground level

Length:	16 m
Width:	10 m
Height:	6 m
Area:	160 m ²
Volume:	900 m ³

Below ground level

Length:	5 m
Width:	2 m
Height:	7,5 m
Area:	10 m ²
Volume:	75 m ³

The remaining section is part of the ramp.

General

The purpose of the building is to act as an entrance to the underground part of the repository. The building is situated over the mouth of the ramp.

The building contains the following functions:

- Remote-controlled motorised door.
- Separate pedestrian door alongside the large door.
- The design of the door will allow the collector rail to pass through without a break.
- The outdoor part of the ramp will be well drained into a special sump.
- The outer ramp will be fitted with heating coil to keep it free of snow and prevent the vehicles from skidding.
- A fan room for exhaust air fans for the underground facility.
- Ducts for pipes and cables running between the operational area and the underground parts of the facility.
- The portal building will be fitted with shell protection, to prevent unauthorised entry to the underground area.

Operations

The portal building is normally unmanned. Staff visit the fan room only to carry out inspections and make any repairs.

The door is opened remotely, using personal entry cards that are issued to authorised drivers.

Pedestrian doors have a code lock. Doors are monitored on the outside and inside via TV-cameras, from the operations centre. Around 70 vehicles are expected to pass through each day.

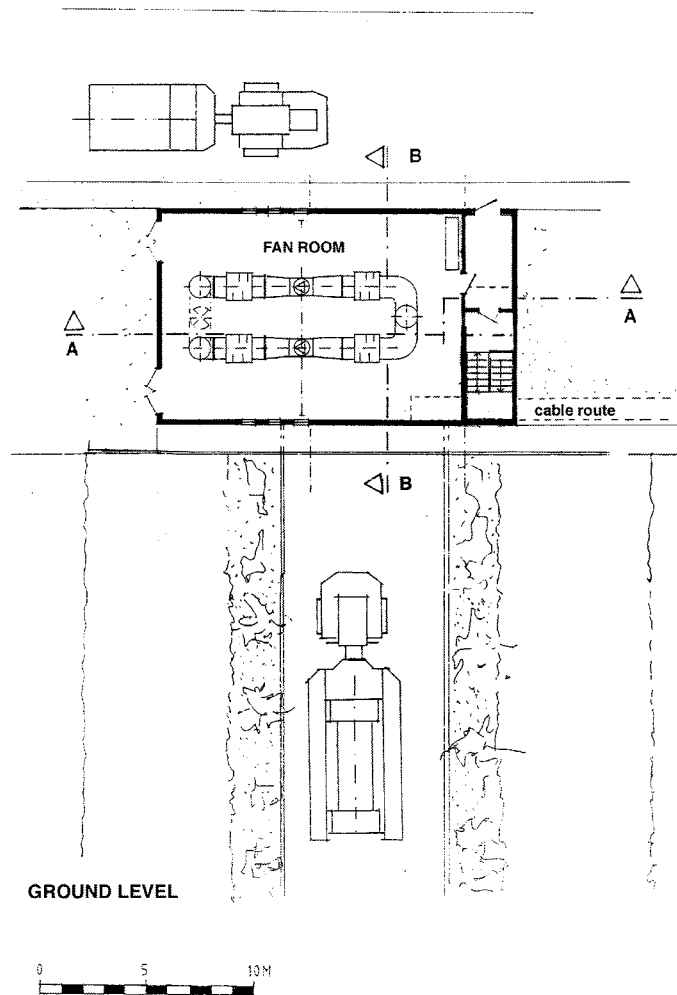

12. OPERATIONAL AREA – BUILDINGS
12.10 PORTAL BUILDING

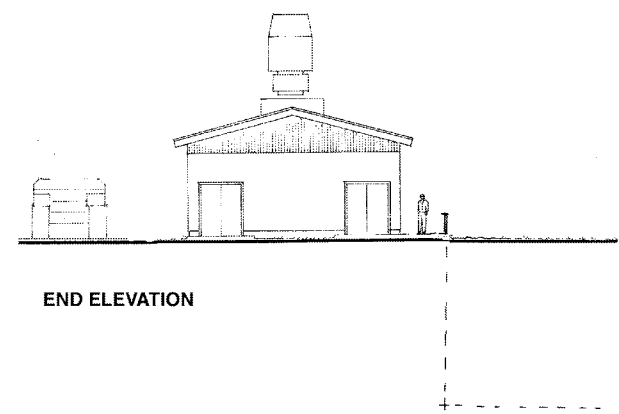
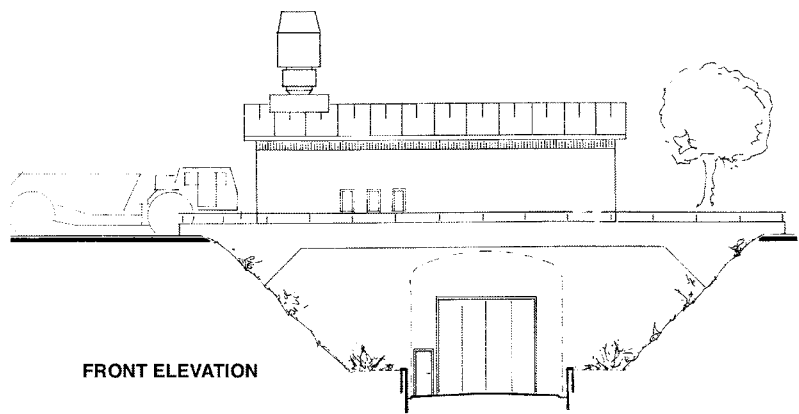
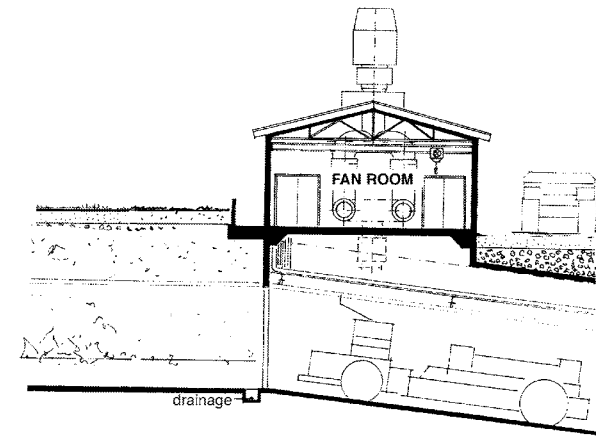
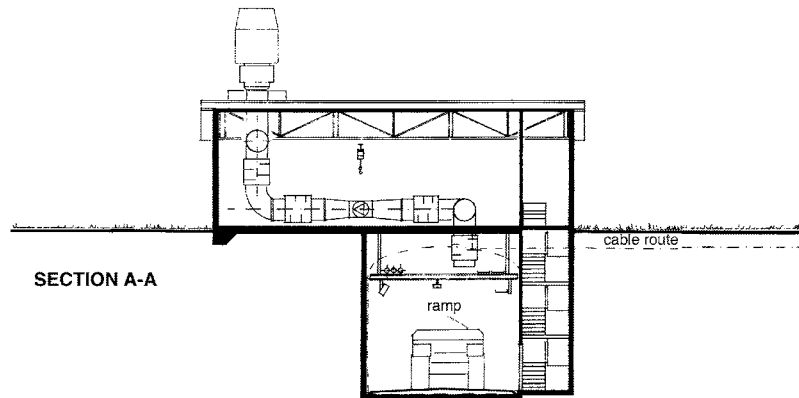

12. OPERATIONAL AREA – BUILDINGS

12.11 PRODUCTION BUILDING

General

The KBS-3 method assumes that there are several barriers surrounding the spent fuel. These barriers are the canister, the buffer and the surrounding rock. In order for the buffer around the canister to work, the deposition tunnels must be backfilled, so that the buffer is kept in place, and the flow of water into the deposition tunnels is restricted. The buffer consists of highly compacted bentonite, and the backfilling material is made up of a mixture of crushed rock and bentonite. The bentonite buffer and backfilling material are prepared in the production building.

Storing and handling the compressed bentonite blocks places demands on the environment in which they are kept and on the handling equipment, to ensure that the blocks don't get damaged in storage. There are corresponding requirements for storing and handling the backfilling material, so problems do not arise when it is being put into the deposition tunnels. For this reason, these products must be prepared immediately adjacent to the deep repository, in the production building.

Layout

The bentonite is brought to the operational area by rail. To keep the transport distance short, the production building is next to the railway yard.

The production building has the following functions:

- Store for parking incoming containers of bulk bentonite.
- Rock store
- Crushing plant
- Mixing plant for producing backfilling material
- Unloading crushed rock for construction work below ground
- Unloading backfilling material
- Preparation plant, where the bentonite is ground and moistened
- Plant for pressing bentonite blocks, including machining
- Intermediate store for finished bentonite blocks, on pallets with airtight covers
- Unloading finished units
- Control room for controlling and monitoring the process

- Staff areas
- Offices
- Areas for study visits.

The production building consists of two, large, parallel, elongated building sections, linked by a smaller, transverse building section facing the centre. One of the large buildings contains a hall for uncrushed rock and a hall for a crushing plant. The other large building contains an area for parking containers filled with untreated bentonite, and a bentonite preparation plant.

The silos of the transverse building section mentioned earlier project into this building. These silos are for material in various phases of the process. On the opposite side is the pressing hall, the processing hall and finally the interim store for finished blocks, with its unloading facility.

Along the outer wall of the latter building, there are rooms for staff, a control room and some offices. There is also an electrical room, a fan room and a special viewing gallery.

The bentonite containers are handled using a forklift truck, both indoors and outdoors. The rock from the deposition level is loaded into the rock storage area via a free-standing unloading building, with a conveyor up to a distribution conveyor belt running along the length of the store. A wheel loader feeds the crushing plant.

Outgoing crushed rock for building use and rock mixed with bentonite for backfilling deposition tunnels is loaded under the silos in the central building. Compacted bentonite blocks are unloaded in the elongated part of the pressing hall, onto a specially constructed vehicle.

Operations

Bentonite blocks and backfilling material will be produced using 2-shift operation. The bentonite is taken from the silos to the dosing tanks, from where it goes to block production and to be mixed with crushed rock for backfilling material. Most of it is used to mix into backfilling material.

The facility has equipment for preparing the bentonite, including grinding and moistening, so it can be bought directly from the excavation site, without any intermediary. There is also equipment for sampling and quality control.

Blocks are produced by the bentonite being put into moulds, and then being pressed. The block then goes for checking and any machining that might be necessary, is put onto a pallet with a cover, and is then taken to the store or straight down to the underground area. After the block has been taken out of the mould, the mould goes back for cleaning, preparation and new pressing.

The production of backfilling material begins with the rock being crushed to the correct size. Suitable quantities of crushed rock and bentonite are weighed, tipped into a mixer and then mixed. The material is prepared continuously so that a deposition tunnel can be backfilled quickly. The prepared backfilling material is loaded into dumpers and driven down to a reloading point in the central area, for onward transport to the deposition tunnel.

The operations in the production building are fairly well demarcated from other tasks in the deep repository. They consist of controlling and monitoring the production processes, manual processing and checking, and driving wheel loaders in the area.

Bentonite blocks are produced to keep pace with the deposition of one canister a day, five days a week. There is also a stock of bentonite blocks, sufficient for approximately five deposition holes.

Mechanical equipment

- Belt conveyors
- Rock crushing plant
- Silos for crushed rock, bentonite and backfilling material
- Equipment for grinding and moistening the bentonite
- Pressing plant
- Mixing plant
- Equipment for machining bentonite blocks
- Travelling cranes
- Wheel loaders for containers and rock

12. OPERATIONAL AREA – BUILDINGS
 12.11 PRODUCTION BUILDING

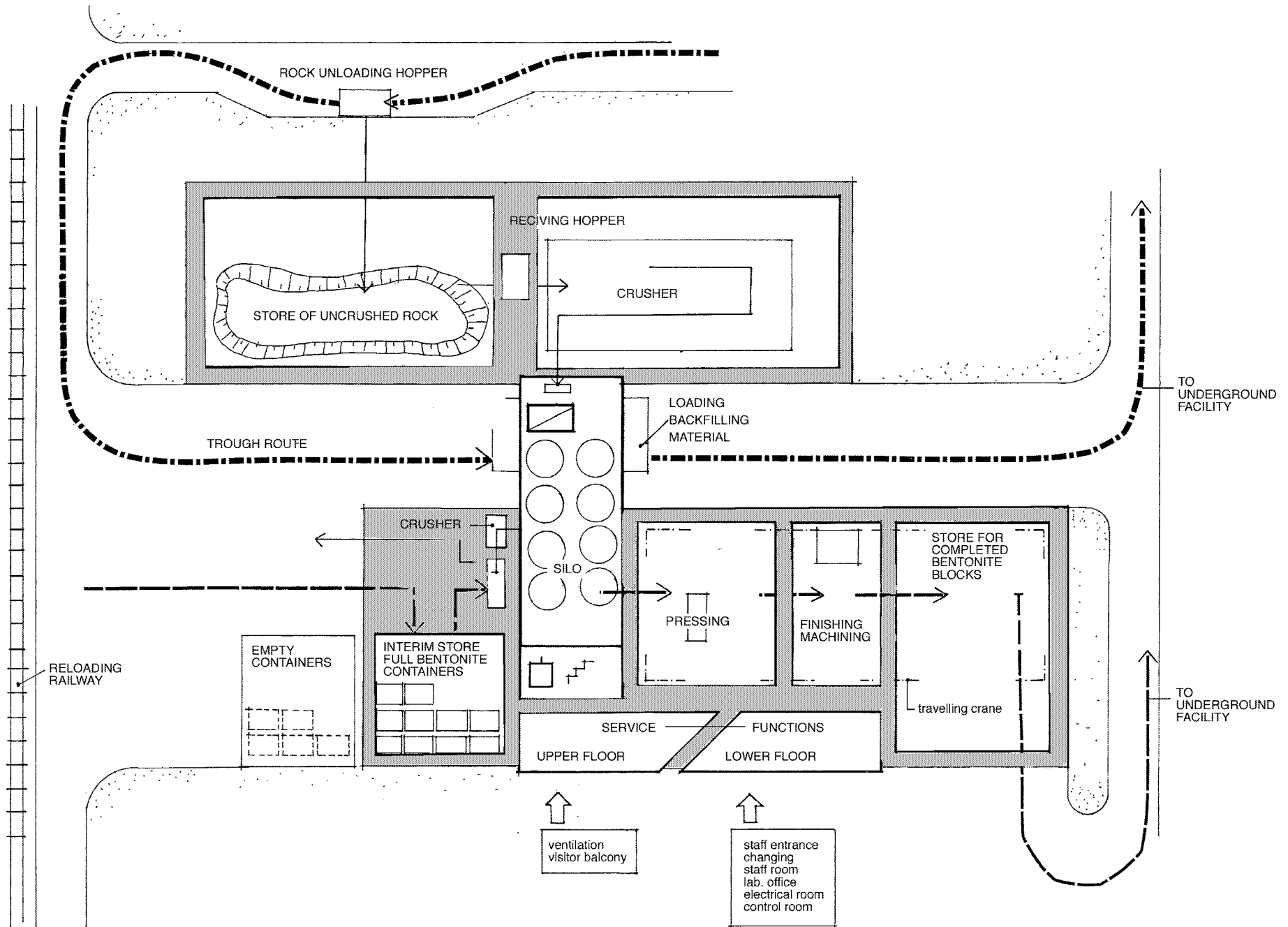

12. OPERATIONAL AREA – BUILDINGS
12.11 PRODUCTION BUILDING

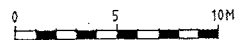
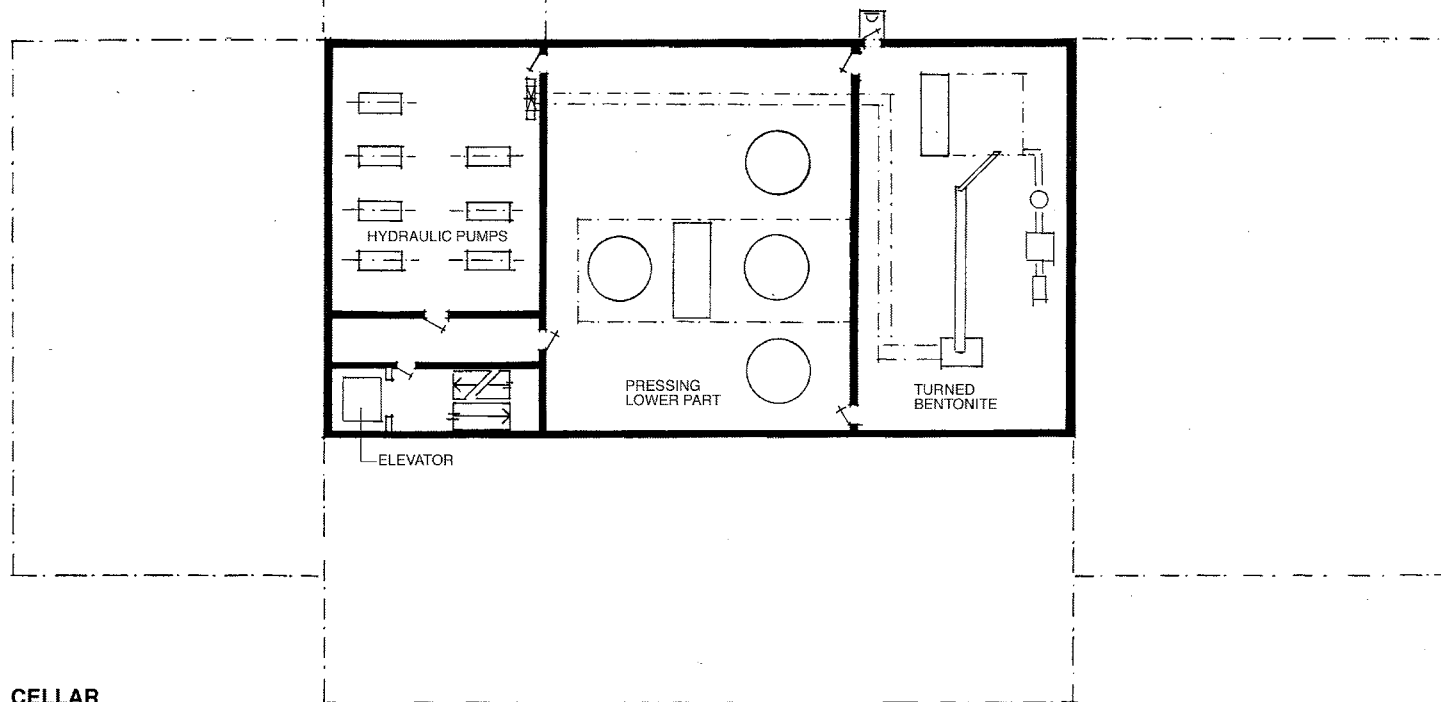
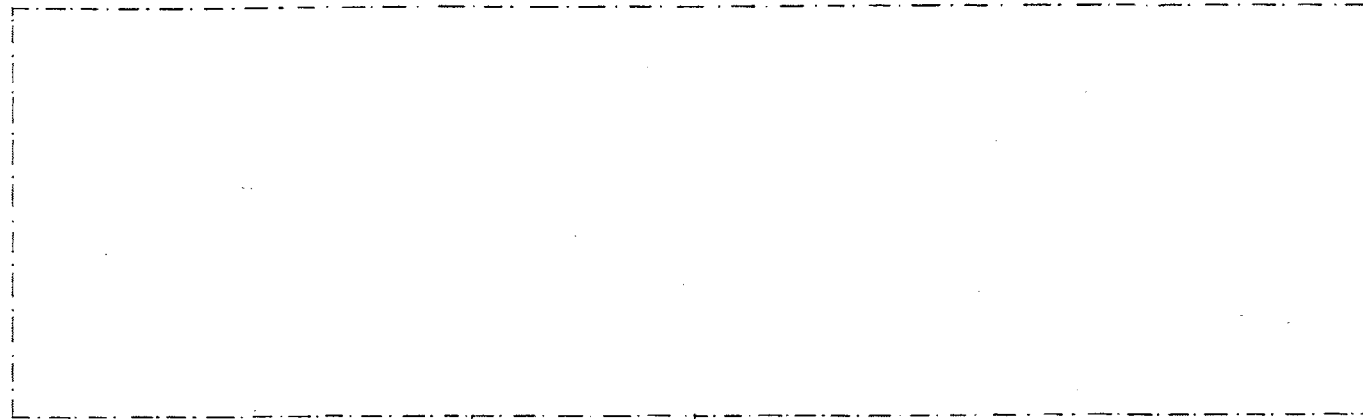

CELLAR

12. OPERATIONAL AREA – BUILDINGS
 12.11 PRODUCTION BUILDING

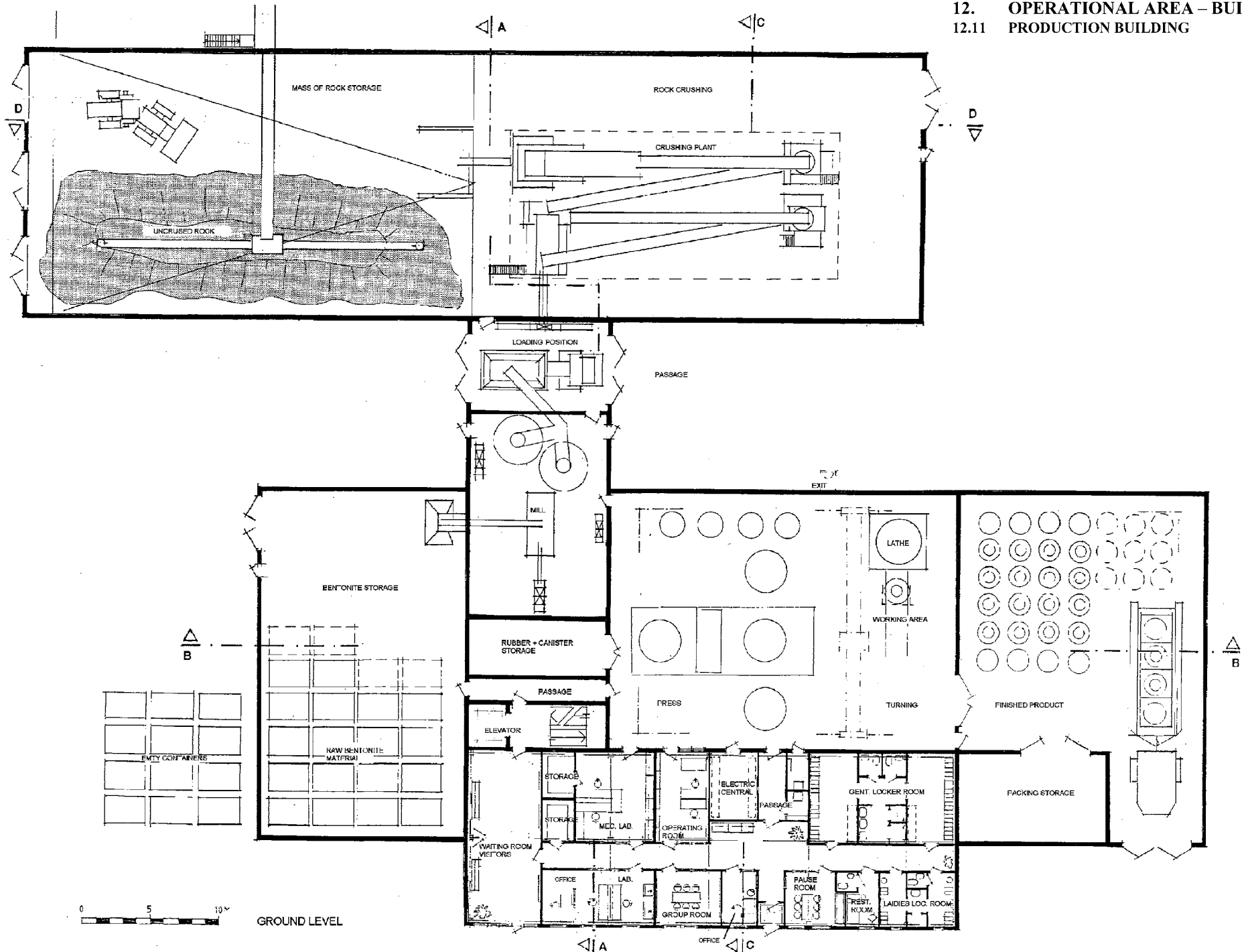

12. OPERATIONAL AREA – BUILDINGS
 12.11 PRODUCTION BUILDING

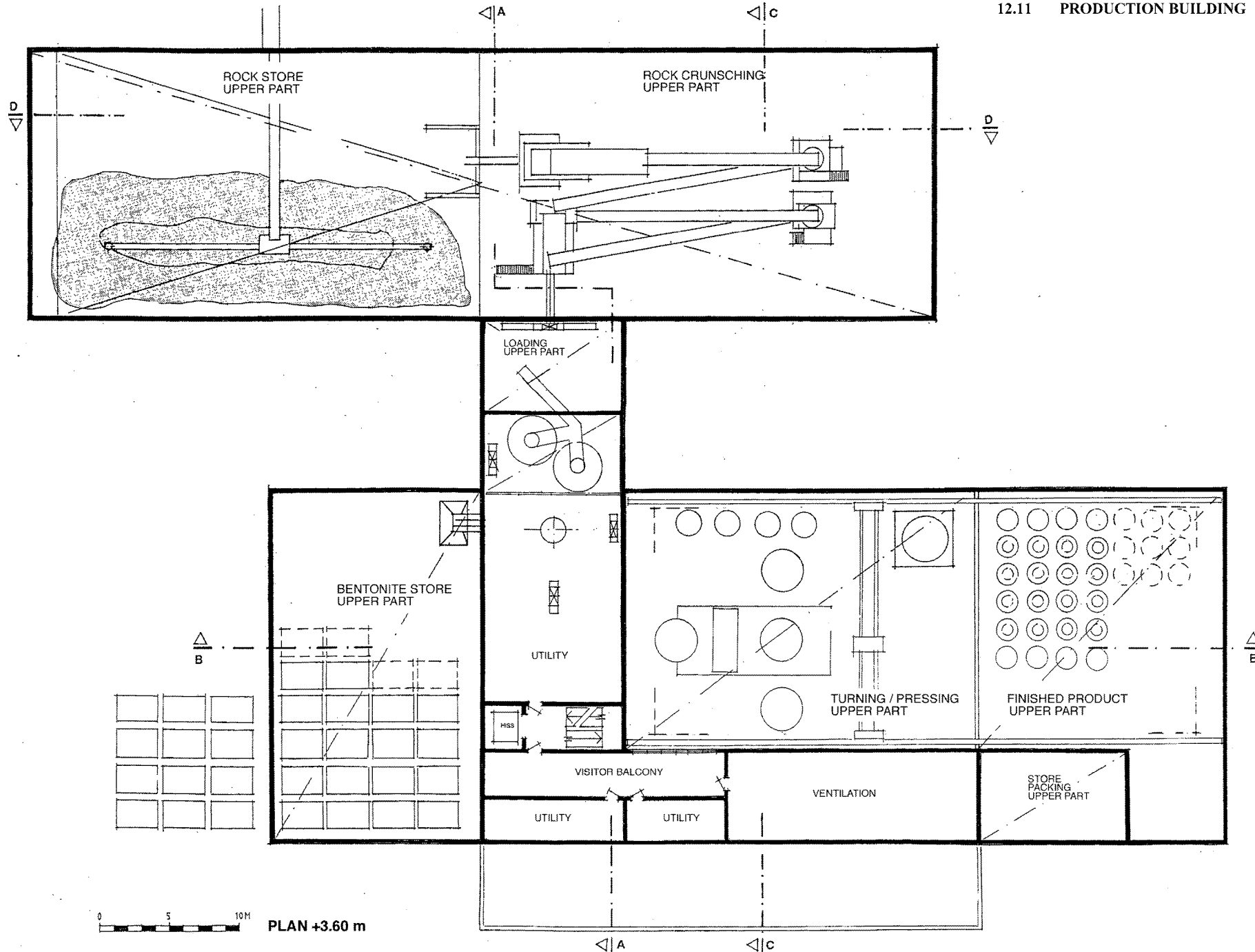

0 5 10M
 PLAN +3.60 m

12. OPERATIONAL AREA – BUILDINGS
 12.11 PRODUCTION BUILDING

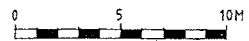
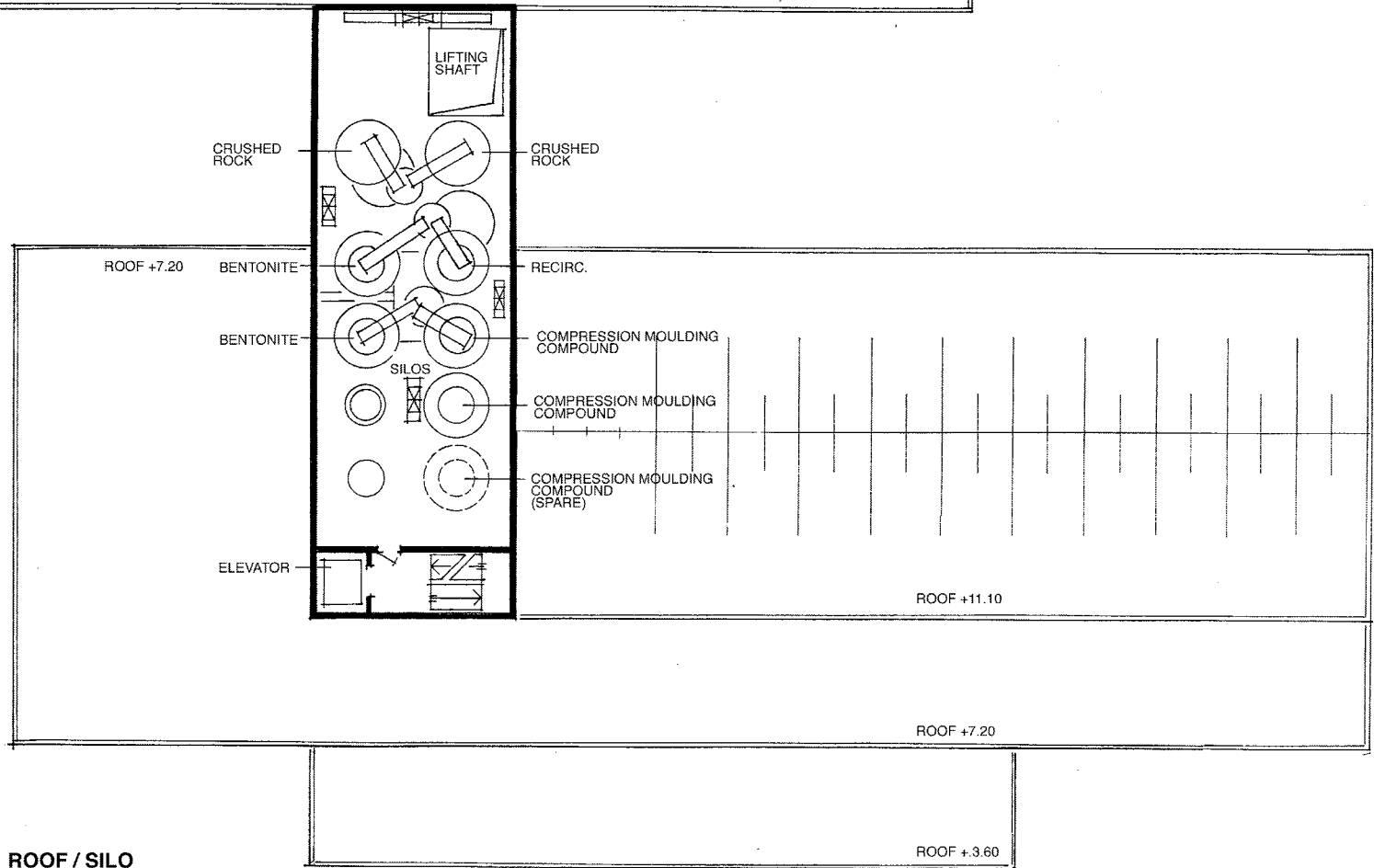
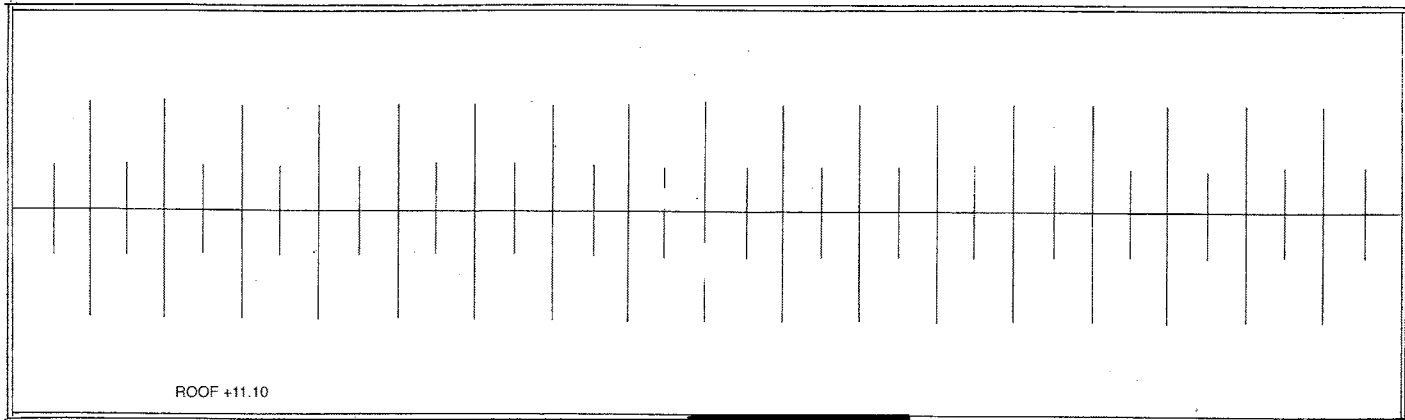

ROOF / SILO

12. OPERATIONAL AREA – BUILDINGS
12.11 PRODUCTION BUILDING

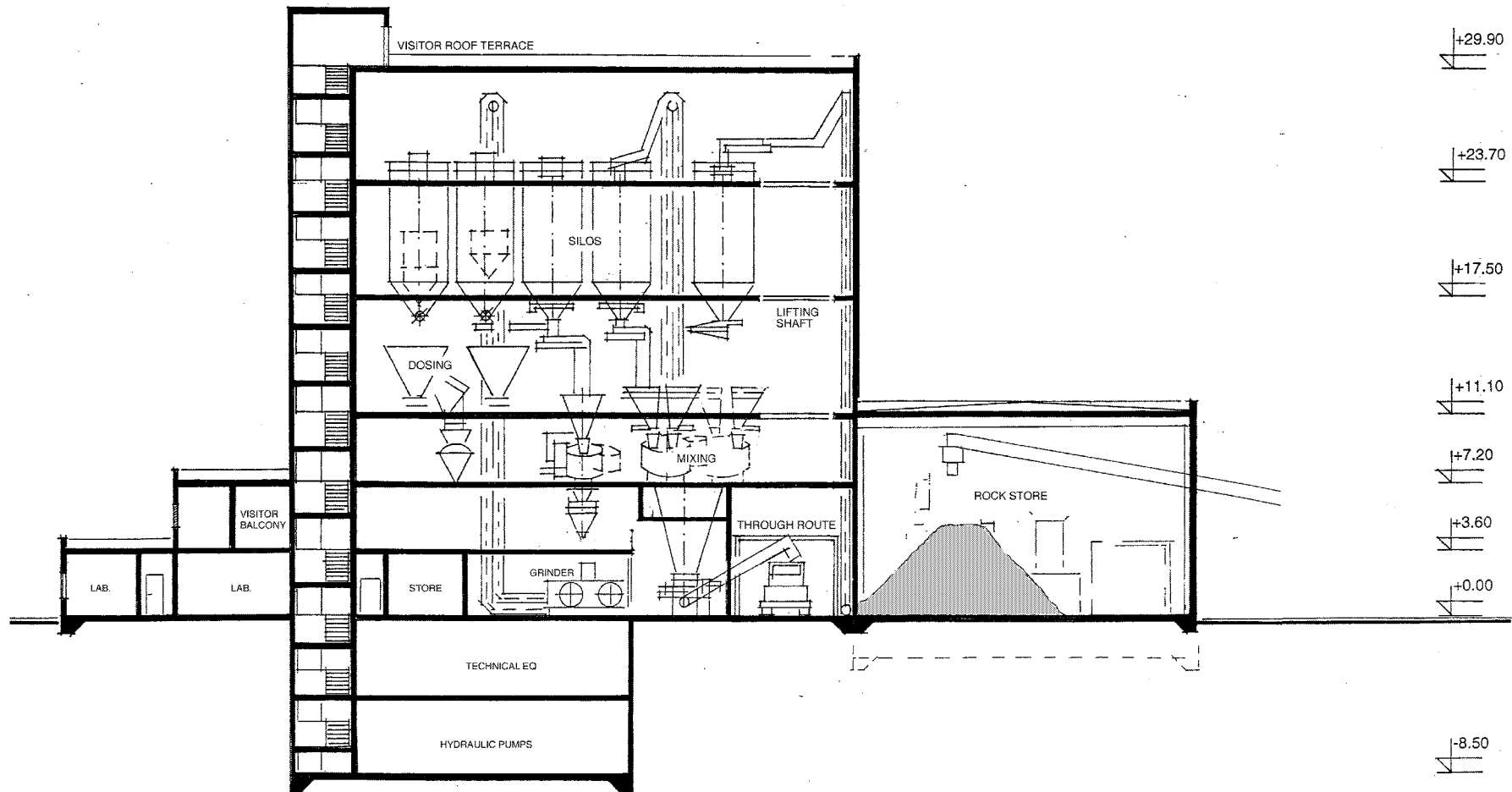

SECTION A-A



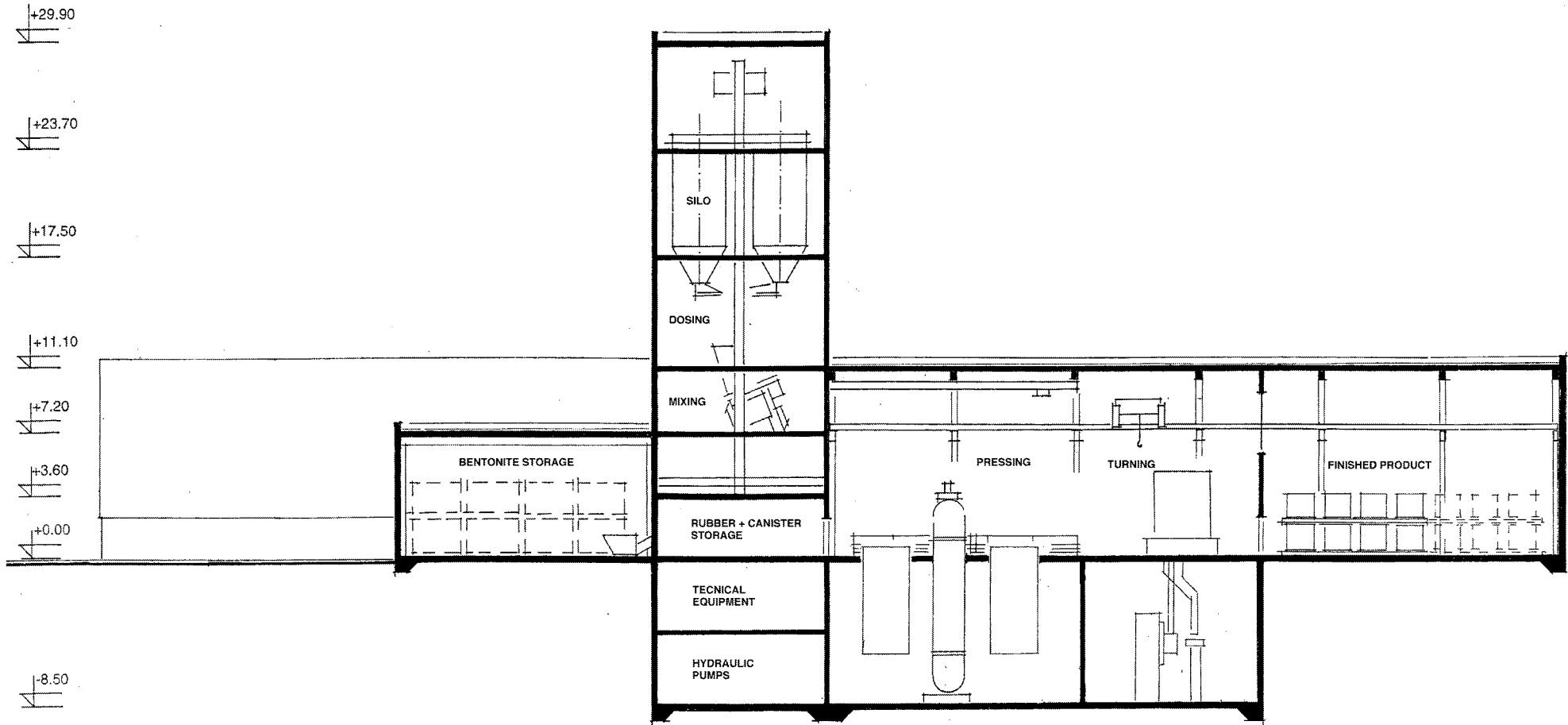

SECTION B-B

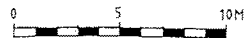

12. OPERATIONAL AREA – BUILDINGS
12.11 PRODUCTION BUILDING

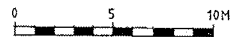
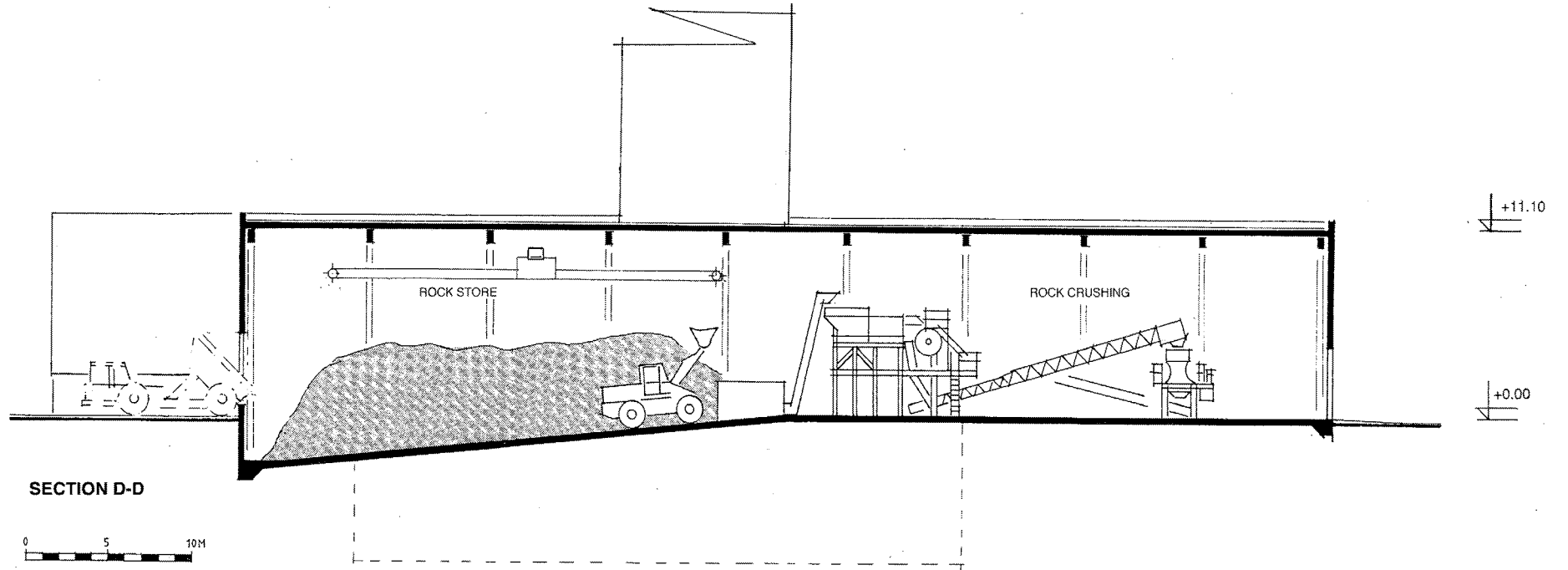
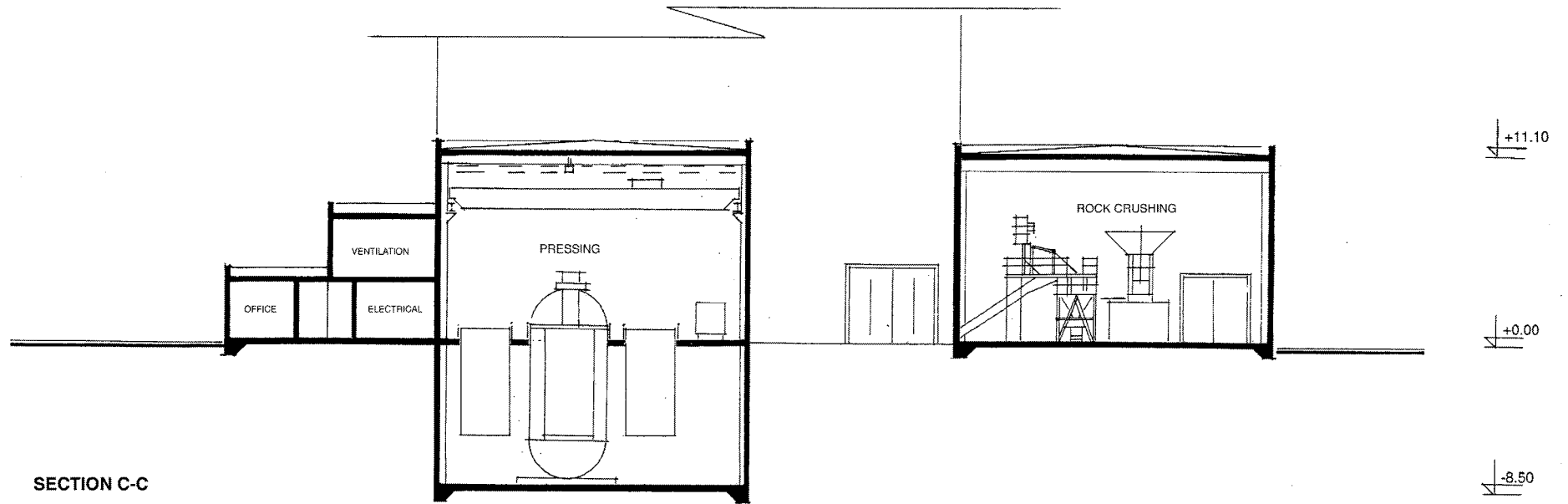

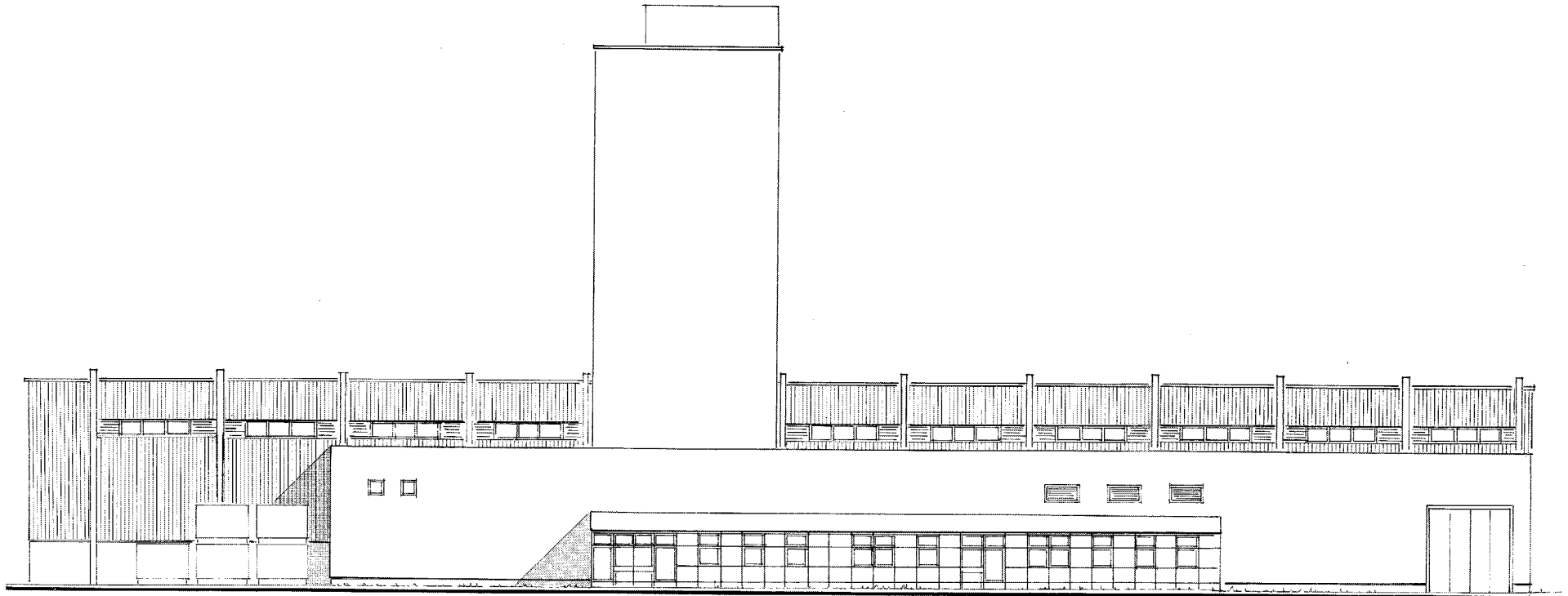

FRONT ELEVATION



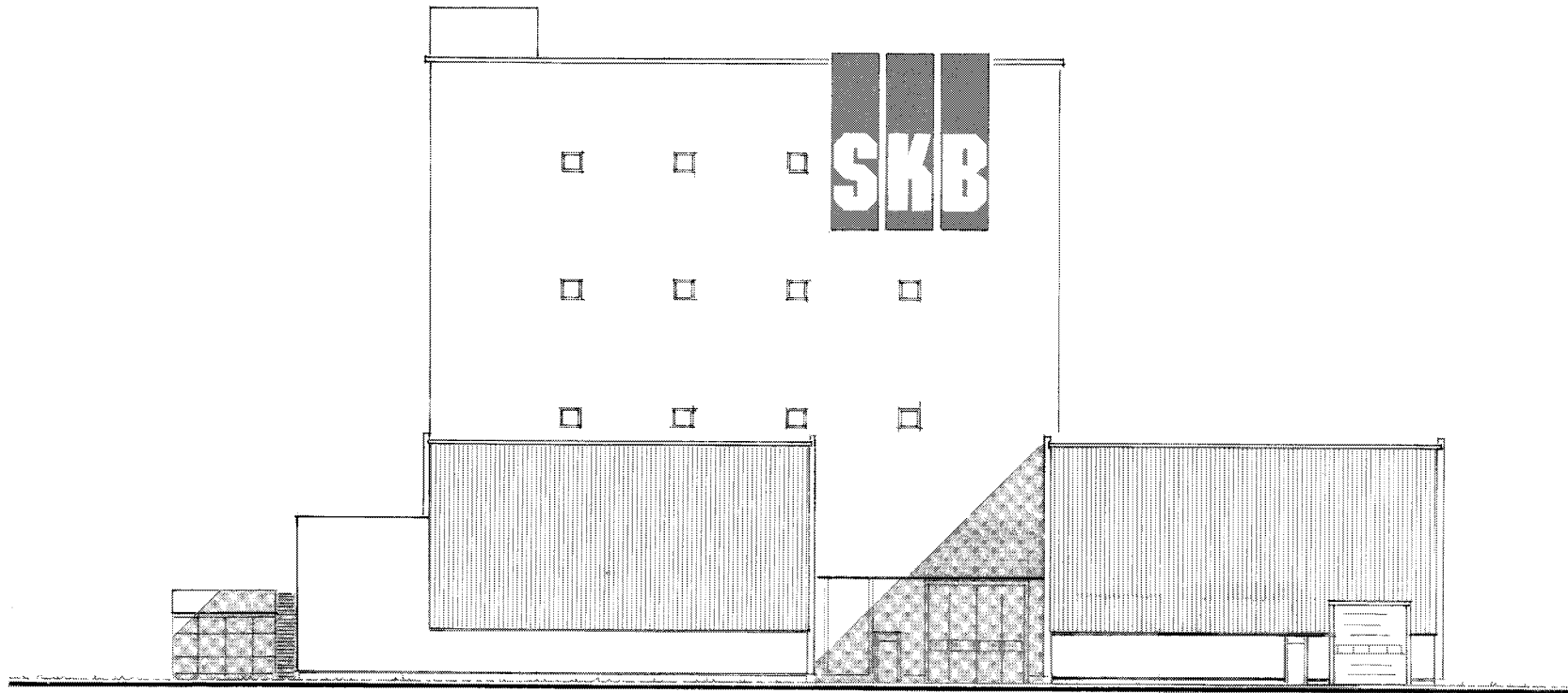

END ELEVATION



General

The purpose of the building is to provide premises for operational staff. From here all operations will be planned and supervised. At the same time the building will provide all staff working underground with premises for changing, washing and rest, storage for protective clothing and other protective equipment.

All staff working in, or wishing to visit, the underground facility have to pass through this building to the elevator and ventilation building for further transport with elevator down to -500 meter level.

Operations

Following operations take place in the building:

1. General planning and supervision of all operational and maintenance activities in the deep repository.
2. Daily planning and preparation of all activities underground such as:
 - Geotechnical investigations
 - Mapping, probe drilling, assessment, setting out and documentation
 - Excavation and building work
 - Excavation, rock support, roadways, installation, dismantling of service systems, drilling of deposition holes
 - Deposition of canisters and backfilling of deposition tunnels, including sealing and documentation
 - Planning and supervision of maintenance and repairs of machines, vehicles and lifting equipment and permanent systems for ventilation, rock drainage, electrical power distribution, lighting, doors etc.
 - Continuous radiological monitoring including handling of dosimeters and evaluation
 - Guarding
3. Transport planning:
 - Transport casks, bentonite blocks, rock and backfilling material in the ramp
 - Transport casks between the harbour and the terminal building
 - Bentonite between the harbour and the production building

4. Operations centre

The following activities will take place in the operations centre:

- Authorisation checks
- Access and attendance checks
- Fire alarm surveillance
- Issuing of work orders
- Guarding of the operational area and the exhaust air plant (TV and rounds)
- Surveillance of the ventilation, drainage system, lighting and door positions for the underground facility
- TV surveillance of the underground facility
- Handling of dosimeters

The operations centre is staffed 24 hours a day.

Staff that work mainly underground will use the staff areas when work starts and ends, and at lunchtime. The majority of the staff will probably use the canteen in the information building.

Layout

The management centre is located between the production building and the elevator and ventilation building. The management centre is basically designed as a two-corridor building on to levels, without a cellar, and with a small fan room. A corridor runs from the entrance at one end to the far end. A transverse corridor connects on one side to the elevator and ventilation building via a covered passage.

The purpose of the management centre is to provide operational staff with following premises:

- Entrance, reception area, cloakroom
- Rooms for changing, washing, sauna and toilets for women and men
- Equivalent facilities for visitors
- Goods reception
- Cleaning room, refuse room
- Laundry
- Conference room
- Staff room
- Area for operations centre
- Control point for entry to the underground facility
- Offices

12. OPERATIONAL AREA – BUILDINGS

12.12 MANAGEMENT CENTRE

The front part of the building is used as an entrance hall, with a reception on one side and a lunchroom on the other side. There is a row of service rooms along the corridor that runs through the building, against the outer wall, while the changing rooms and their ancillary functions are on the opposite side.

The changing rooms are divided in two parts, one of which is for storing personal clothing and the other for dirty work clothes. The washing facilities are between the two changing rooms.

The areas are designed for shift work, which means that more lockers are required in relation to washing and toilet places. There are the same facilities for both women and men, as the duties involved will probably be suitable for both sexes.

The layout is a proposal for a generic design, with a communication system including service areas. The room plan shows different types of offices, open-plan offices and a conference room. It is also possible to work out an optimal division of rooms, within the general rules. The building can be adapted to actual requirements, by altering the number of floors or the length of the building.

Dimensions - Capacities

Length:	50 m
Width:	16 m
Height:	7 m
Floor area:	770 m ²
Volume:	3,850 m ³

Number of changing places

Women:	25
Men:	60
Visitors:	10

Number of places in lunch room: 30

12. OPERATIONAL AREA – BUILDINGS
12.12 MANAGEMENT CENTRE

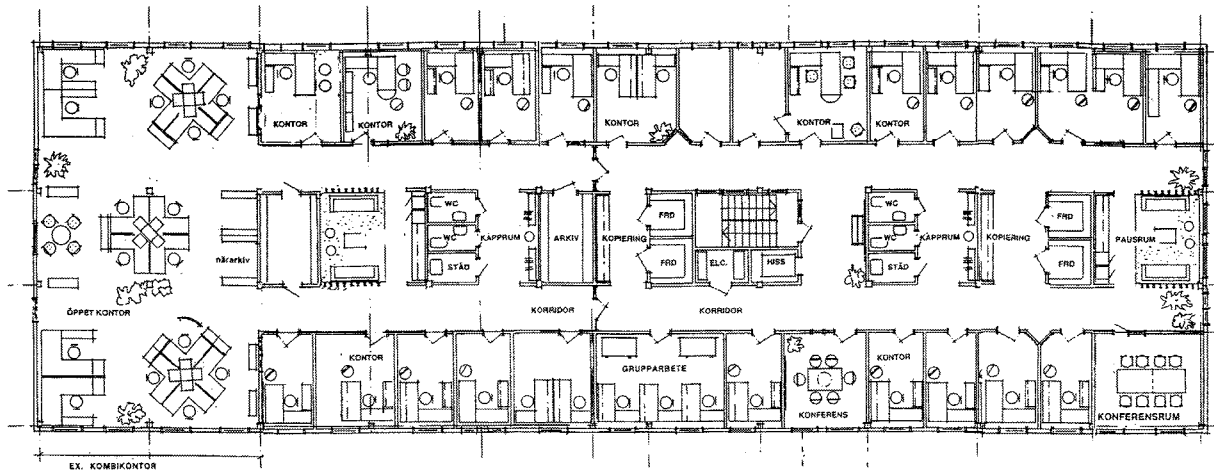

UPPER FLOOR

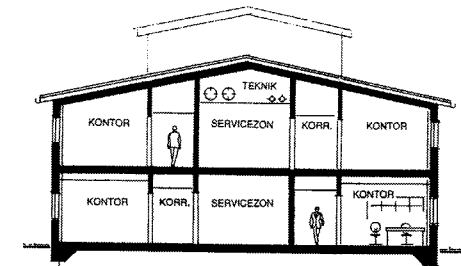

SECTION

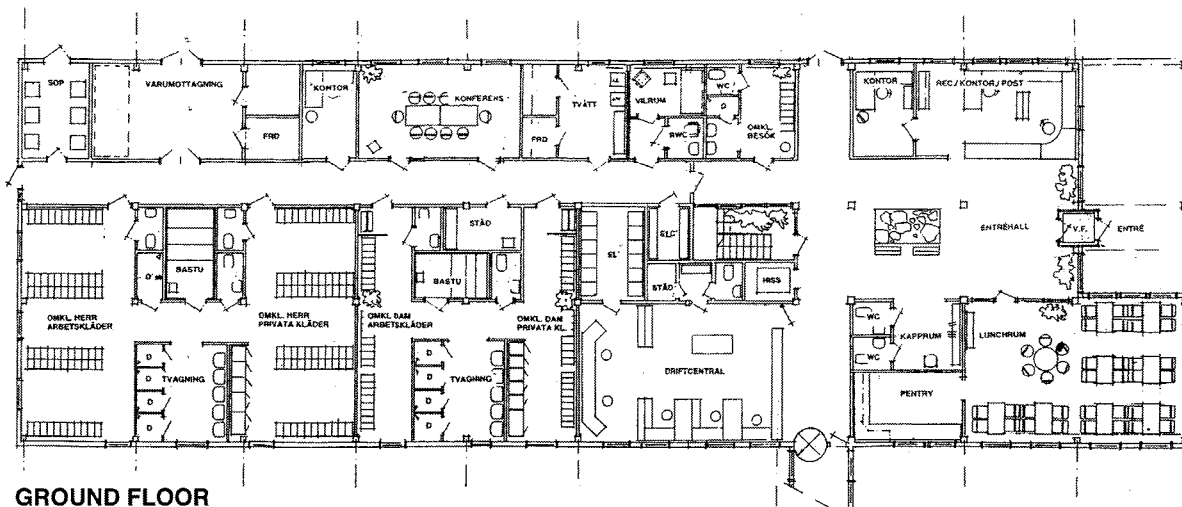

GROUND FLOOR

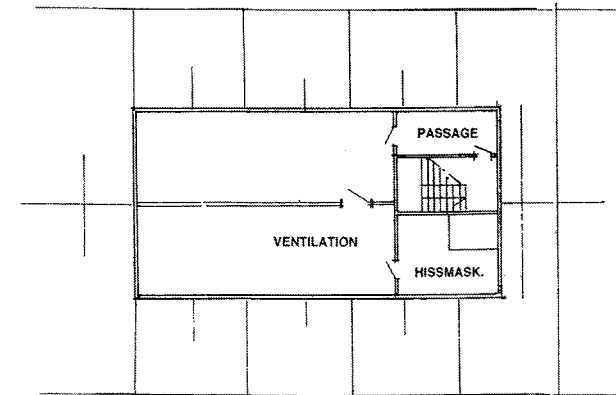

ROOF LEVEL



KEY

- KONTOR = OFFICE
- FRD = STORAGE
- STÅD = CLEANING
- PAUSRUM = BREAK ROOM
- KPR = CLOAK ROOM
- KOPIERING = COPYING ROOM
- ELC = ELECTRIC
- HISS = ELEVATOR
- KORR = CORRIDOR

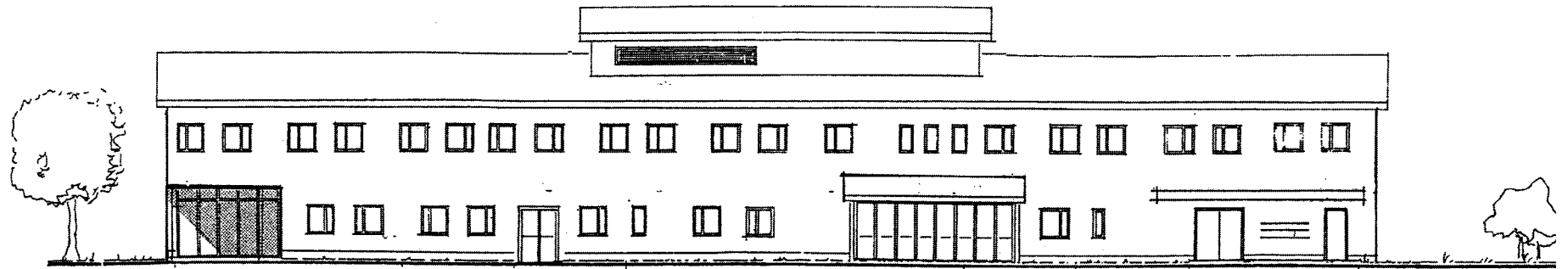

SIDE ELEVATION

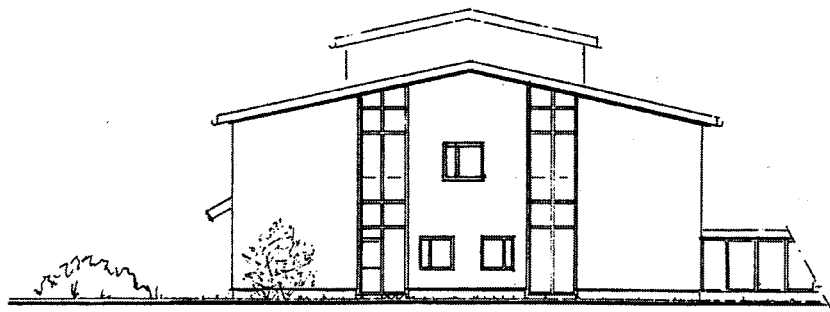

END ELEVATION

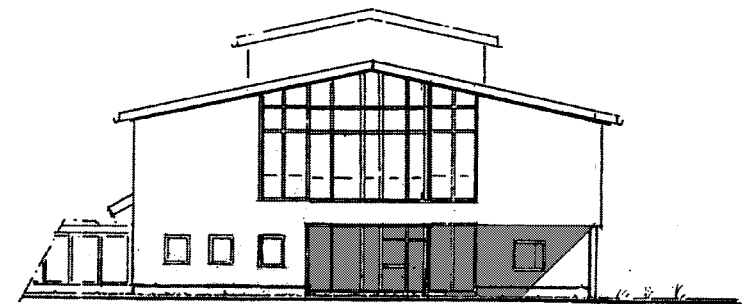

FRONT ELEVATION

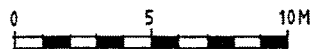

12. OPERATIONAL AREA - BUILDINGS

12.13 ELEVATOR AND VENTILATION BUILDING

General

An elevator shaft will be excavated, in order to shorten the travelling distance for staff between the surface and the deposition level. At the same time it is also possible to shorten the distance travelled by ventilation air, power and drainage water, and the various signal systems that are required.

This means that the shaft superstructure will house the following functions:

- Elevator machinery room
- Shaft superstructure
- Fan system to serve the underground area
- Installation space for pipes and cables to the deposition level.
- Routes for facility staff and visitors.

Operations

Permanent workplaces have not been planned in the elevator and ventilation building. However, the staff having their usual workplaces on the deposition level will pass back and forth through the building at least once a day. In addition, visitors can be taken down to the -500 metre level by the same route.

The ventilation system and elevator machinery will require regular maintenance. There will be some service areas that require staff to visit the building from time to time.

Layout

The design of the building is based on the size of the elevator shaft and the way the elevator and fan systems connect to it. The building has two full floors and a third, partial floor, positioned centrally over the elevator shaft. There is no cellar. However, there are incoming ducts for pipes and cables that connect to the shaft.

The ground floor consists of a central section containing a stair well, elevator hall, elevators, installation spaces over the shaft and a lifting shaft to the elevator machinery room on level 3. There are staff areas on either side of the central section, for both facility staff and visiting groups, comprising an area for protective equipment, a staff room and toilets. There are also service areas for fans, which can be lowered down to the ground floor from floor 2.

In order to make transporting small and light goods from the underground area easier, an anteroom for temporary storage has been situated adjoining the lift vault. This prevents the approach to the elevators from becoming cluttered with packages waiting to be dealt with. The rear part has been used for storage and temporary service rooms. These rooms will probably need to be used as equipment rooms, such as for various types of recording systems.

Floor 2 is used for the ventilation system for the underground facility, consisting of fans, suction chambers, pressure chambers, noise suppressers, air heaters and control equipment. Ducts to the underground area are connected to the shaft on this floor.

There is a separate fan room at the front of the building, for internal requirements. There is a subsidiary control room next to the main staircase. The operation of the ventilation plant can be controlled from there.

Floor 3 forms a continuation of the central section of the floors below. The floor is divided into two rooms, one of which is used for installing the elevator machinery and the other as a lifting area for both the elevator machinery room and the shaft to the -500 metre level.

The fire compartmentalisation of the elevator and ventilation building will be co-ordinated with the shaft below, including space in front of the elevators in the elevator vault, in order to ensure safe evacuation by the elevators.

The building will be fitted with shell protection, to prevent unauthorised access. This shell protection will cover the enclosed passage from the management centre.

The sound output from the fans to the outside will be effectively limited.

With regard to the design of the elevator shaft, refer to section 16.5.

Mechanical equipment

- Fans
- Two lift installations
- Lifting equipment for elevator machinery and shaft.

Dimensions

Length:	35 m
Width:	30 m
Height:	13 m
Floor area, total:	1,400 m ²
Volume, total:	9,500 m ³

12. OPERATIONAL AREA - BUILDINGS
 12.13 ELEVATOR AND VENTILATION BUILDING

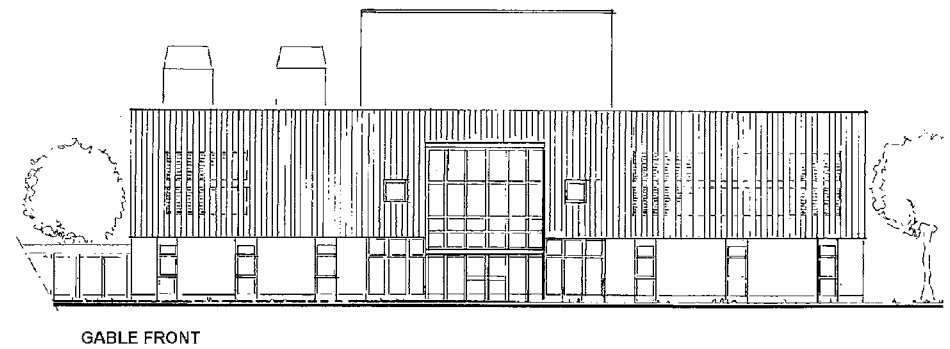
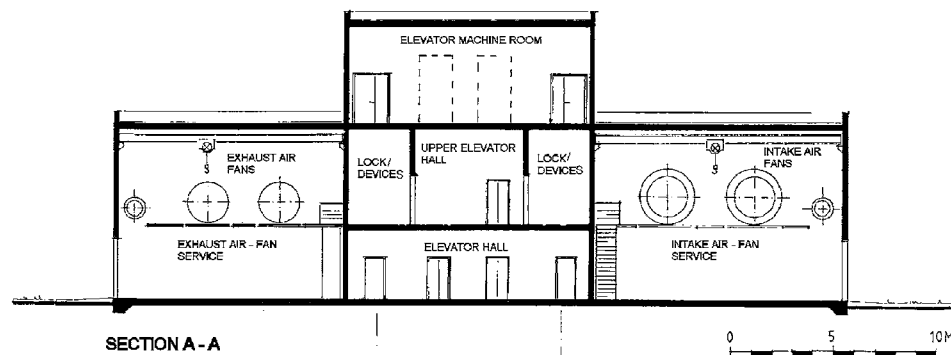
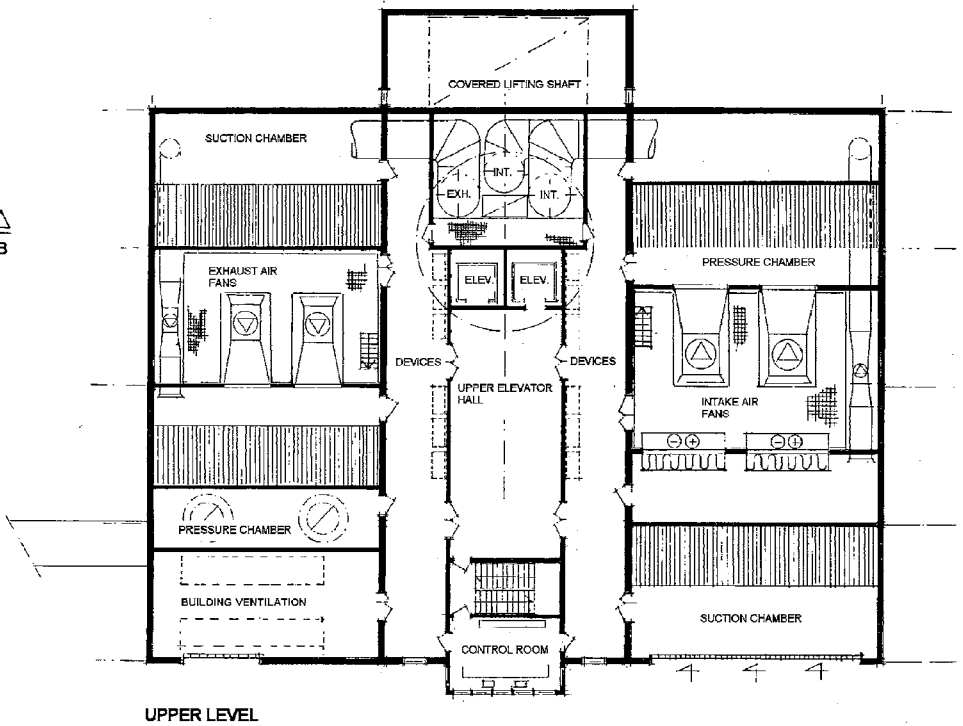
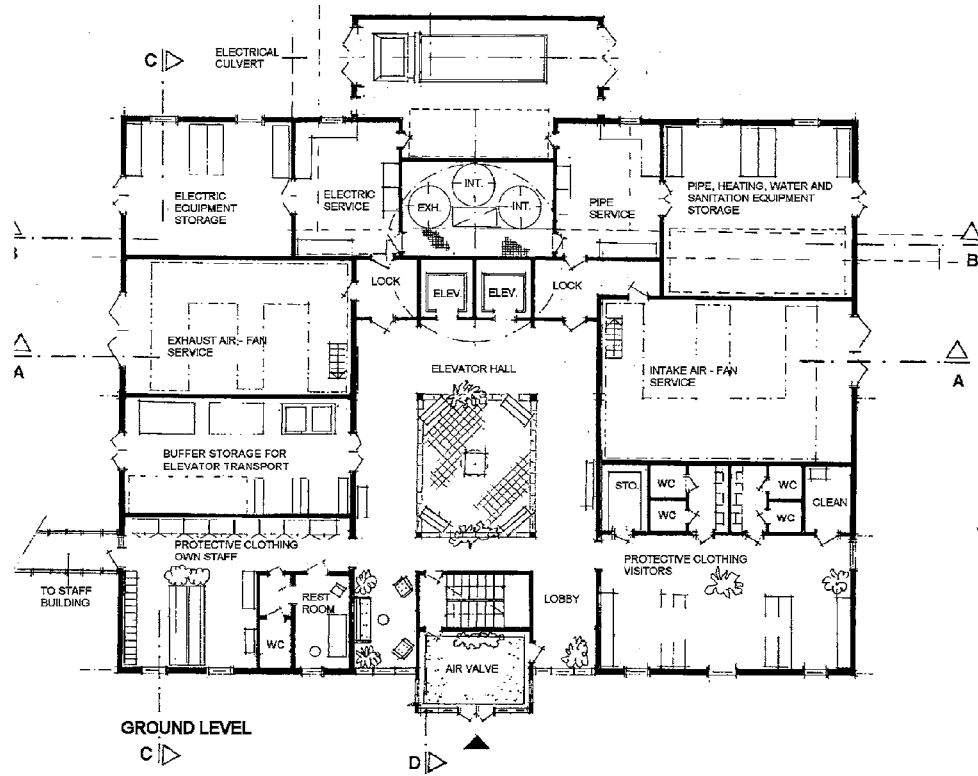

12. OPERATIONAL AREA - BUILDINGS
 12.13 ELEVATOR AND VENTILATION BUILDING

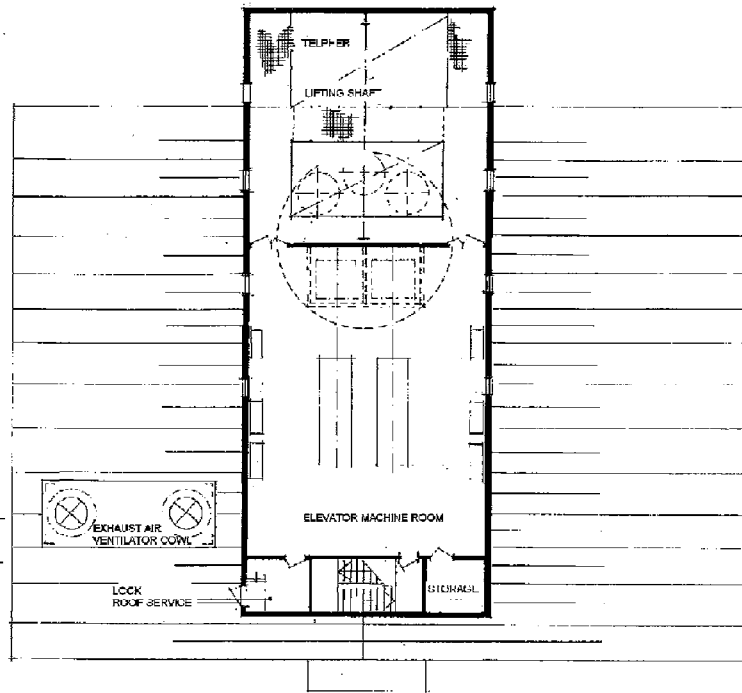

ROOF LEVEL

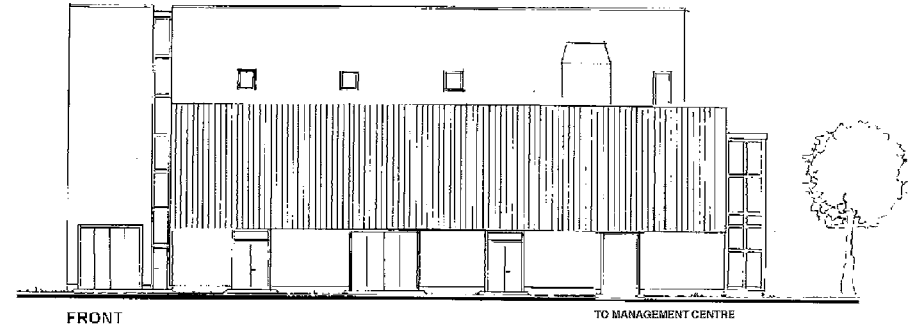

FRONT

TO MANAGEMENT CENTRE

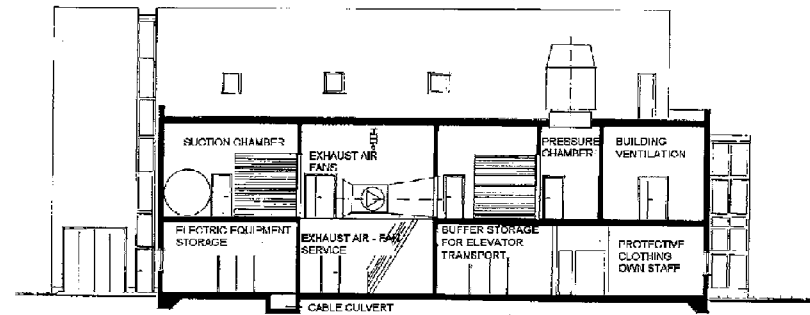

SECTION C - C

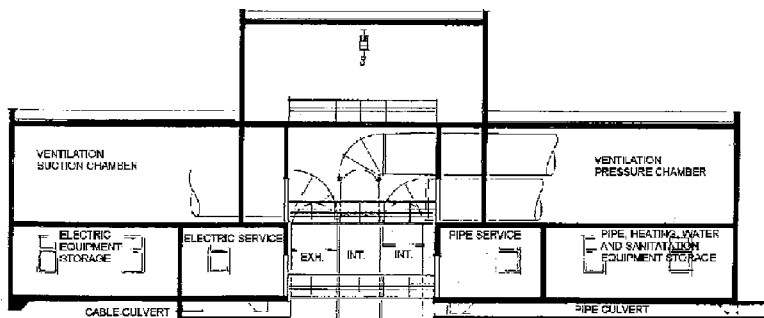

SECTION B - B

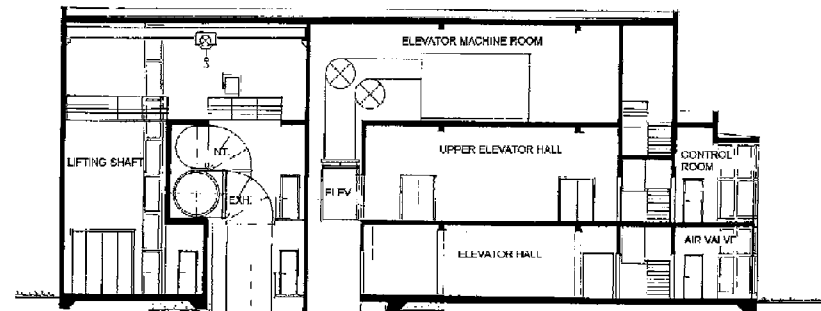

SECTION D - D



12. OPERATIONAL AREA - BUILDINGS

12.14 AUXILIARY SYSTEMS BUILDING

General

Systems in the auxiliary systems building will deal with and treat repository drainage water.

The repository drainage water will probably have a relatively high salt content. If the operational area is at a reasonable distance from the sea, it will probably be possible to pipe out the repository drainage water untreated.

If the operational area is located a long way from the sea, the repository drainage water will have to be desalinated to an acceptable level before it is piped to a suitably located receiver.

In this facility description, it is assumed that it is necessary to desalinate the repository drainage water.

The ventilation system for the underground area must be designed to prevent condensation on surfaces and installations. This requires that the intake air be preheated for most of the year and cooled for short periods, depending on the weather.

From an energy saving standpoint, it is advantageous to utilise the heat in the repository drainage water using heat pumps.

In the generic solution, repository drainage water is pumped up from the repository drainage vault in the central part of the repository level, via the elevator and ventilation shaft and then on to a basin in the auxiliary systems building.

From this basin, the water is pumped to the heat pumps, after which the cooled water is piped to the next basin. From there, the still saline water is pumped to the reverse osmosis desalination unit. To reduce the salinity sufficiently, the process will have at least two stages.

The highly saline water that is produced is pumped over to a cistern. The concentrate could be removed by tanker, for further transport to a suitable location for discharge into the sea.

The entire system must be designed and sized to provide efficient and safe operation. The three basins in the system provide flexible operation. For example, the drainage pumps on the deposition level can be run intermittently.

The system should be able to deal with any variations of inflow, while meeting the requirement for maximum permitted salinity for discharge to the particular receiver.

Operations

The system is intended to operate continuously, without staff being present. It is assumed that the plant will be controlled and monitored from the operations centre.

Inspection rounds will be made to check the condition of equipment. Any maintenance and repair of equipment will be done as required.

The concentrate might have to be removed several times a week.

Layout

The auxiliary systems building consists of a hall divided into two sections. The small section comprises two water basins, lower than the surface. The large section of the building contains a lane for heat pumps and electric boilers, and a parallel lane for desalination equipment.

Transport into the latter section is from the gable end. There are storage and cleaning rooms at the end of the building.

Staff premises are not required in the building.

Dimensions

The approximate dimensions of the building are:

- Length: 16 m
- Width: 13 m
- Height: 6.5 m
- Floor area excluding basins: 270 m²
- Volume - warm repository drainage water: 100 m³
- Volume - cold repository drainage water: 100 m³
- Volume excluding basins: 2,000 m³

12. OPERATIONAL AREA - BUILDINGS
 12.14 AUXILIARY SYSTEMS BUILDING

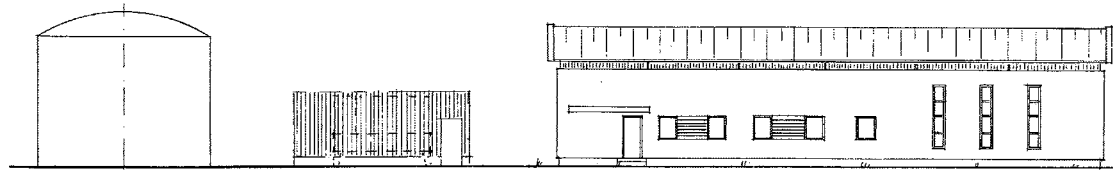

FRONT ELEVATION

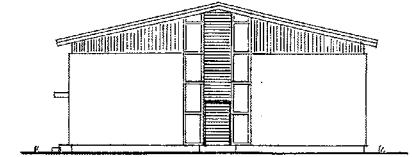

END ELEVATION

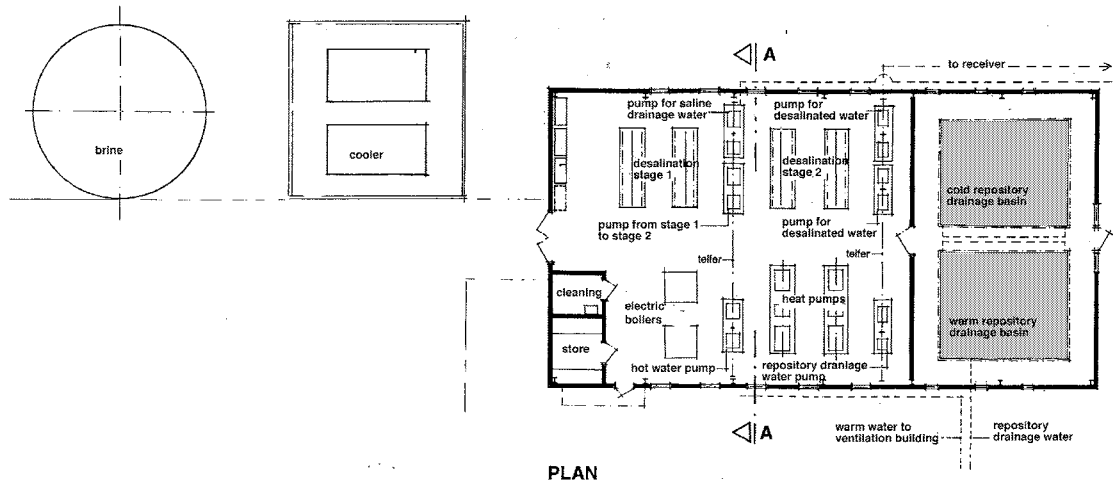

PLAN

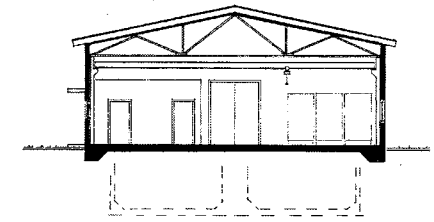

SECTION A - A

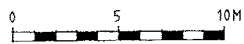

12. OPERATIONAL AREA – BUILDINGS

12.15 TERMINAL BUILDING

General

In this particular case, the transport casks will be transported to the deep repository by rail. This means that a special area will be needed for reloading between railway wagons and terminal vehicles. It will also be necessary to have covered interim storage of the transport casks, in order to even out the transport flow at the railway to match the deposition capacity. The following conditions apply.

- It should be possible to use the travelling crane to unload filled transport casks and load empty ones from one railway wagon at a time.
- The number of places for parking transport casks will be equivalent to one shipload, i.e. 10.
- Each train consists of ten wagons, each loaded with one transport cask.
- To be able to unload and load every wagon consecutively, an extra position is needed, to be used when swapping filled and empty casks. The terminal building will be designed to have space to park 12 casks to have reserve positions available.
- One wagon is put in the building at a time
- The travelling crane is also used to load the ramp truck.
- The travelling crane has a special safety feature, to prevent the load being dropped.

Operations

The operations in the terminal building involve unloading and loading railway wagons, and loading and unloading trucks for transport down into the repository. It is assumed that a train made up of ten wagons will arrive at the operational area every ten working days. The unloading will be done in a continuous operation. For reasons of security, wagons with filled transport casks should not be left standing in the railway yard, and for logistical reasons, the locomotive must be driven back to the harbour to transport bentonite between the transport cask runs.

One transport cask will be transported by truck to the deposition level each workday, for a total of five return trips a week. A special transport manager will lead the reloading procedure, in accordance with applicable regulations. The checks also include some documentation.

Staff will probably work full-time in the building on occasion. The unloading to the deposition level will usually be carried out for a shorter period each workday. The ramp truck will be parked in the building when it is not being used. However, any work on the vehicle will be done in the garage building. Locomotives and wagons can be serviced in the railway section of the hall.

Layout

The terminal building is situated at the farthest part of the operational area, as seen from the rail link. The wagons are planned to be operated one at a time for unloading and loading. The combined operation of the terminal building and the railway yard, and how the trains are marshalled, are described in section 11.8.

The terminal building consists basically of a long hall, with a place for a railway wagon to stand at one end and an equivalent parking place for a terminal truck at the other end.

The floor area between the vehicle positions at the gable ends is designed to take 12 transport casks. The area is divided into three sections, with space for four transport casks in each.

The lower part of the long outer walls will provide a degree of radiation shielding for the surrounding area.

A travelling crane that runs along the length of the building spans the hall. The crane is designed to unload and load the vehicles at both ends of the building. The travelling crane will be radio-controlled. The rest position for the travelling crane will be over the entrance for the ramp vehicle.

Along one long wall of the building, there are areas for staff, power supply and surveillance equipment. There is a corridor running through the building, linking the two ends.

There is a local fan room on the upper floor of the annex, with access via an internal staircase. The temperature in the hall section will be kept above freezing, while the annex will have a normal indoor temperature.

There will be a pit under the railway track, to collect melt-water from wagons that are covered with snow. The area will be covered by a grating, level with the surrounding floor. The outer walls, doors and gates of the terminal building will be fitted with shell protection in order to prevent unauthorised entry.

Special equipment

- Travelling crane
- Lifting yoke designed for the transport casks
- Special design to prevent loads being dropped
- Max. load 80 tons
- Highest lift height 7 m
- Span 17 m
- Length of crane track 23 m
- Cradles to hold the transport casks.

Data and dimensions

Length:	50 m
Width:	25 m
Height:	11 m
Floor area – hall section:	900 m ²
Floor area - other section:	300 m ²
Volume:	11,000 m ³

12. OPERATIONAL AREA – BUILDINGS
12.15 TERMINAL BUILDING

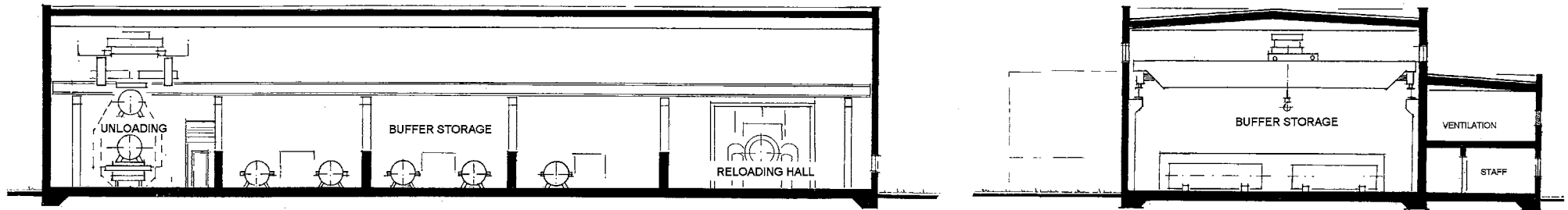

SECTION A - A

SECTION B - B

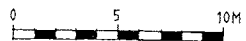
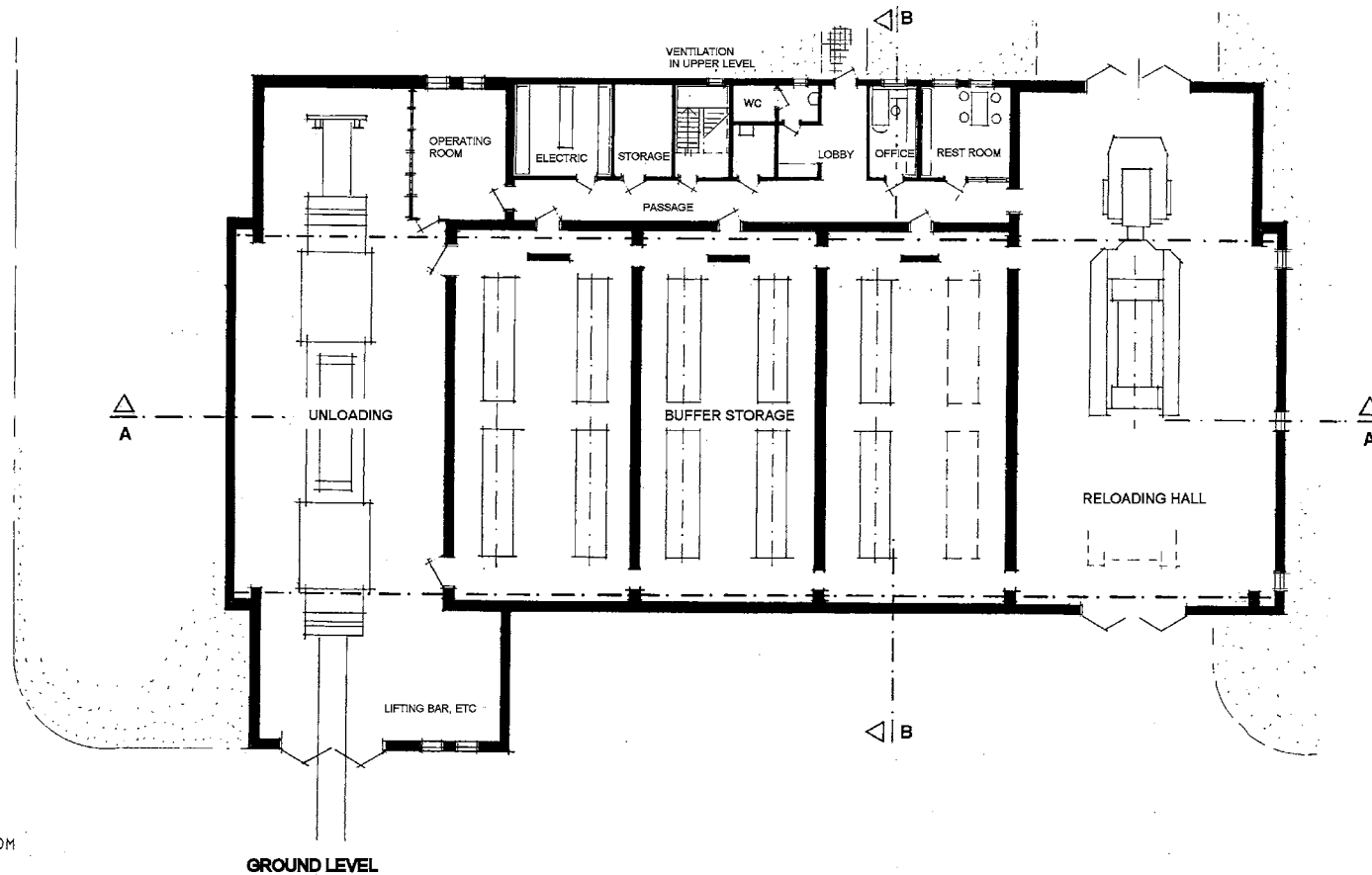

GROUND LEVEL

12. OPERATIONAL AREA – BUILDINGS
12.15 TERMINAL BUILDING

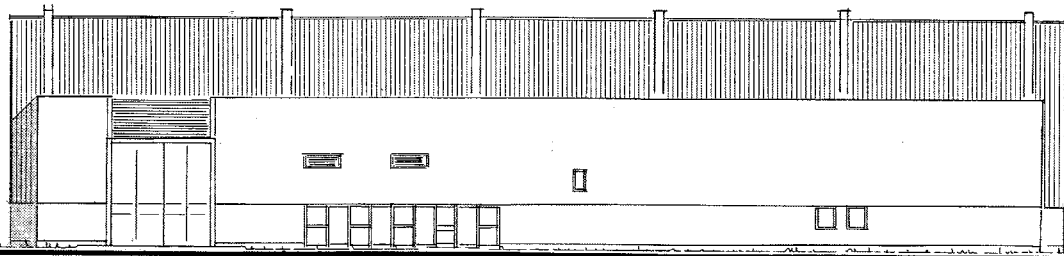

FRONT ELEVATION

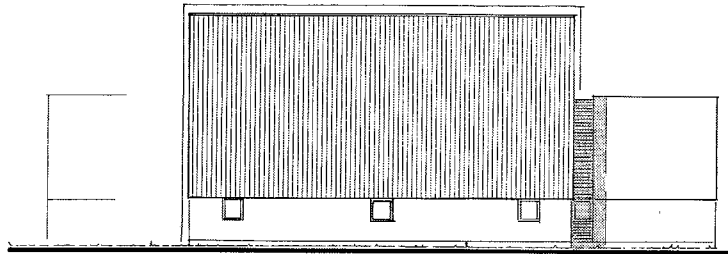

END ELEVATION

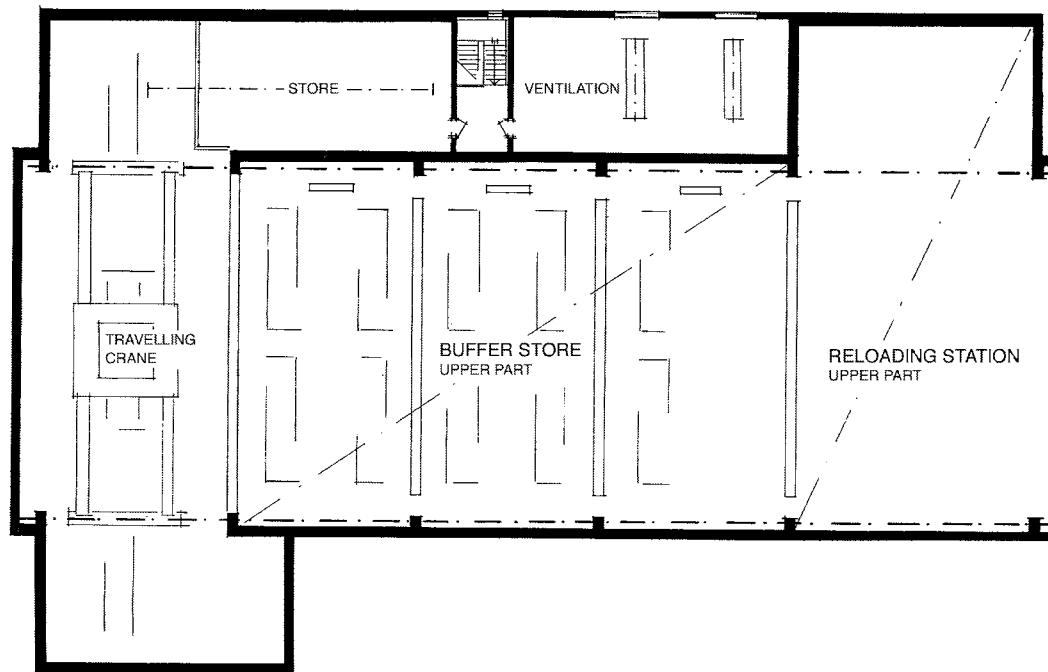

UPPER FLOOR

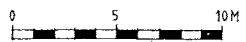

- 13.1 General
- 13.2 Site arrangement
- 13.3 Ventilation building

13

EXHAUST AIR PLANT

13. EXHAUST AIR PLANT

13.1 General

The proposed design of the underground facility assumes that an exhaust airshaft will be constructed at the far end of the deposition area. The intake air is transported down from the operational area, via ducts in a shaft, to the ventilation vault in the underground area, and is distributed by booster fans and ducted out into the various tunnels in the facility.

The exhaust air is extracted via the ramp and the exhaust airshaft, and is drawn up by fans in the superstructure. The fan system will normally run continuously. The system will be designed with redundant fans, so that maintenance, repairs or a change of fan can be done without shutting down the entire system.

The location of the ventilation building is determined by the design of the underground facility. This means that the building will be outside the facility operational area, at a distance of several kilometres.

The ventilation building will operate unmanned, and be controlled remotely from the operations centre.

The exhaust airshaft will be drilled. The hole is approximately 500 metres deep, with a diameter of approximately three metres. The exhaust airshaft could also serve as an evacuation route from the underground facility. In that case, evacuation would be by means of a inspection hoist, permanently mounted in the ventilation building.

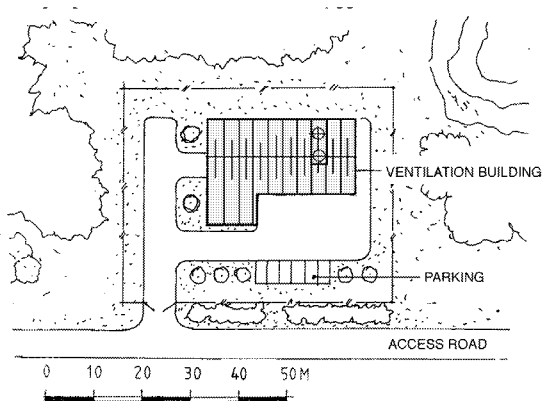

13.2 Site arrangement

As mentioned previously, the deposition area on the -500 metre level will be adapted to suit the quality of the rock in the particular area, which means that the extent of the underground area affects the choice of location for this ventilation building on the surface. It is therefore likely that this part of the facility will be located in a green field site.

The requirements for the site are, in addition to adaptation to the underground facility, that the building be located separate from built-up areas and other land uses of economic and environmental importance.

Against this background, it is reasonable to assume that the building will be located in a relatively undisturbed, forested area, with no existing road link. The site ought to be somewhat higher than the surrounding land, to facilitate drainage. The shaft should preferably enter rock close to the surface or be directly into bare rock.

The land required is limited to basic access roads from the nearest public road and a small area of hardstanding with room to park some vehicles. Water and sewerage connections should not be necessary.

Electricity will be supplied from the operational area, which will ensure that operations can continue if there is a loss of power from the external network.

As it is planned to full face bore the exhaust airshaft, no rock will be brought up here.

Operations

The systems in the ventilation building are controlled and monitored from the operations centre. Staff will make regular inspection rounds of the area. Servicing and maintenance will be carried out as needed.

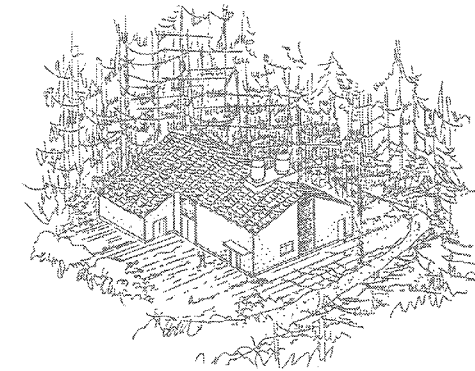

13.3 Ventilation building

The ventilation building contains the following sections, each designed for the particular function:

- Suction chamber over shaft
- Elevator machinery room
- Fan room
- Electrical room with switchyard, equipment room, storeroom and pressure chamber

The building is constructed on a concrete bottom slab, which also acts as a connection to the exhaust airshaft. The suction chamber part of the superstructure is located centrally over the exhaust airshaft. The machinery for the inspection elevator is in an annex adjacent to the suction chamber section. The fans are positioned parallel to one another, on opposite sides of the centre line of the building. In the next part of the building, there is an electrical room, an equipment room and a storeroom for rescue equipment. The building has a mansard roof, to conform to old Swedish building traditions. The building can easily be adapted for various site conditions.

Special equipment

The building contains the following mechanical equipment:

- Exhaust air fans
- Noise suppressers
- Machinery for inspection elevator

Dimensions

Length =	30 m
Width =	21 m
Highest point =	8 m
Area of ground floor =	520 m ²
Volume =	3,600 m ³

13. EXHAUST AIR PLANT
13.3 VENTILATION BUILDING

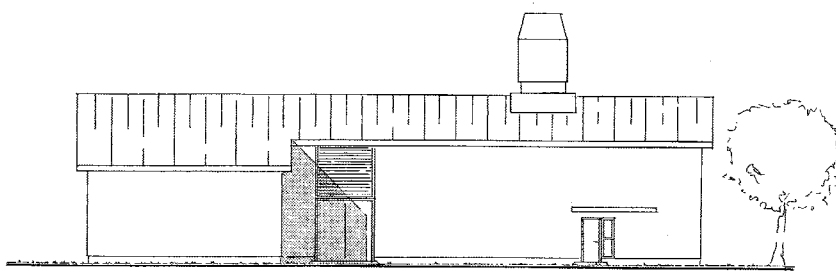

FRONT ELEVATION

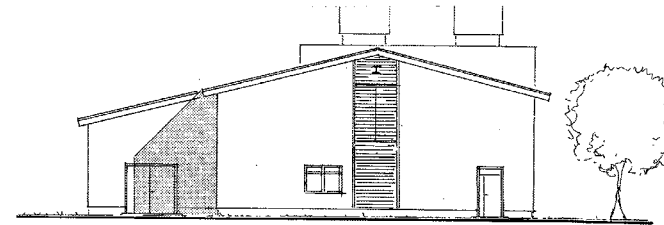

END ELEVATION

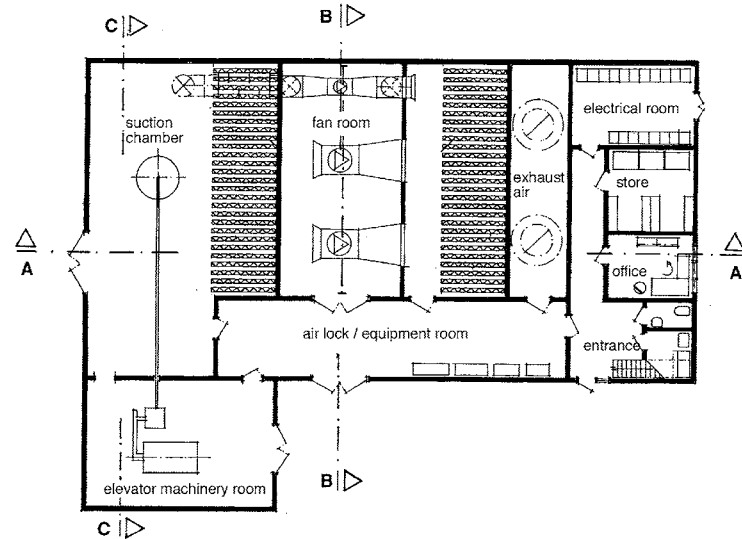

GROUND FLOOR

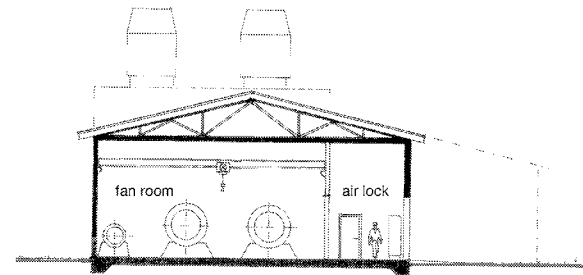

SECTION B-B

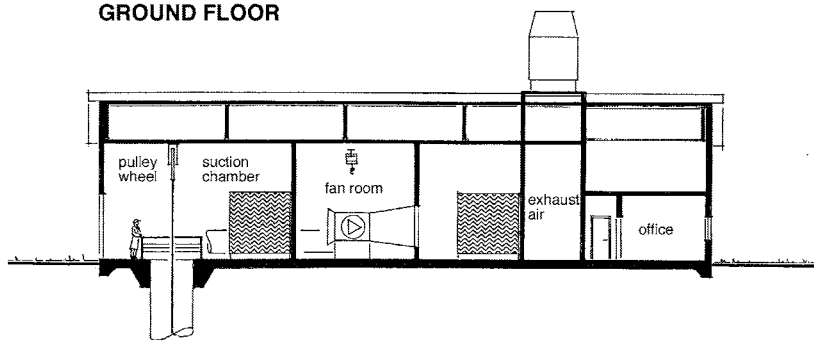

SECTION A-A

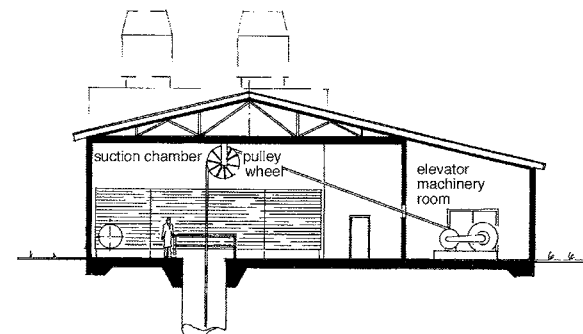
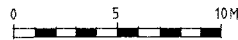

SECTION C-C

- 14.1 Rock volumes
- 14.2 Stockpile arrangement

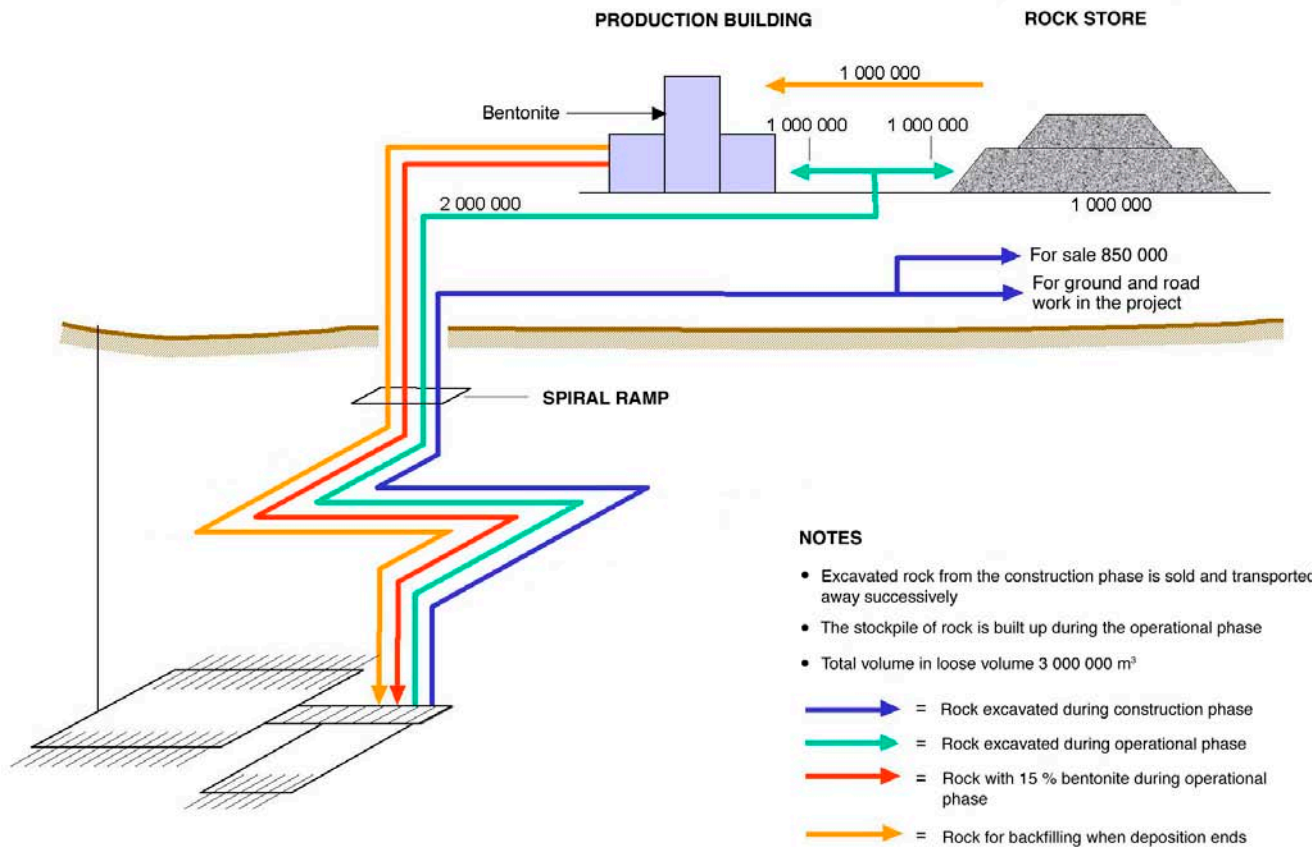

Figure 14-1 Flows of rock masses

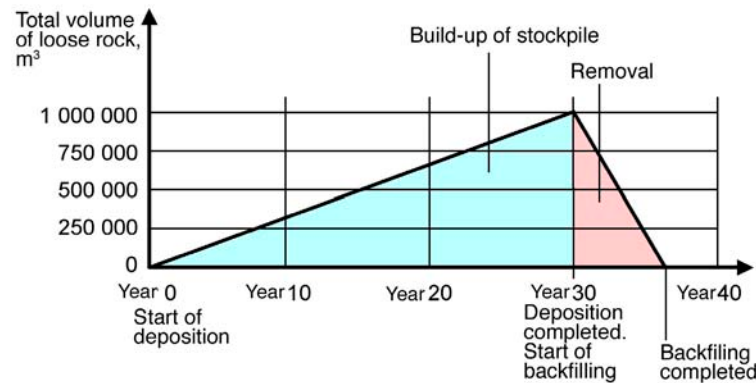

Figure 14-2 Volume of stockpile

14. ROCK STOCKPILE

14.1 Rock volumes

The excavation of the deep repository will give rise to a considerable amount of excavated rock. A certain volume would be stored and used for production of backfilling material. The surplus can be sold or has to be stockpiled.

During the construction phase, 1,000,000 m³ of excavated rock will be produced. The initial construction phase includes the ramp, the central area and the preferably area for initial operation.

A small proportion of the rock that is produced during the construction phase will have to be used for constructing the yard and roads needed for the project.

While the facility is in operation, deposition tunnels will be excavated and the deposition holes for the canisters will be drilled. It is estimated that this amount will be approximately 2,000,000 m³ of excavated rock. Of this, approximately 1,000,000 m³ will have bentonite mixed with it and be used as backfilling material for the deposition tunnels.

The surplus amount produced during the operating phase will have to be stockpiled in a suitable way nearby, so that, when deposition ends, it can be used as backfilling material for all spaces except the deposition tunnels.

The surplus that is created during the operational phase will be sufficient to meet the requirements for backfilling material when deposition ends.

There are various ways the deal with the rock from the deep repository project. It would be reasonable to assume that the rock from the construction phase could be sold successively as building material, and be transported away from the site, which would mean that the size of a buffer stockpile could be limited.

The planned logistics are shown in figure 14-1, which shows flows and relationships more clearly.

The course of events outlined means that the stockpile for rock reserved for backfilling will increase successively during the entire operating phase, which it is estimated will last for approximately 30 years. When deposition ends and the decision is made to strip-out all areas below ground, backfilling will take approximately 5 years. The formation of the stockpile is shown in figure 14-2.

14. ROCK STOCKPILE

14.2 Stockpile arrangement

Acceptable care of the excavated rock requires meticulous planning and implementation. The means of control could be a landscape plan, which describes handling the rock, stages involved, temporary facilities and replanting measures. It is important to have a well-founded basic concept, in order to avoid costly intermediate handling of the rock.

In accordance with the conditions on which this facility description is based, most of the rock that is excavated will be returned as backfilling material. The interim storage time has been estimated at approximately 40 years.

In order for the stockpile not to be seen as a tip during this period, a deliberate shape is required for the excavated rock. The shape of the stockpile ought to contrast with the surrounding landscape, in order to indicate that it is temporary.

The stockpile can be constructed in various ways, with the shape decided by the conditions at the chosen site. The adjoining sectional diagram shows the total amount of excavated rock in a pile that rises in 3 m terraces approximately 15 m above ground level, i.e. not above the surrounding tree line.

So that the excavated rock is not seen as too intrusive, it is proposed that a retaining embankment, approximately 6 m high, be constructed in the initial phase, which will enclose the entire rock stockpile (as shown in the adjoining section). The retaining embankment is covered with the earth that was removed from the stockpile site to prevent unwanted growth into the excavated rock. The retaining embankment will be planted with trees like those that are found in the surrounding landscape.

This will maintain a natural but distinct demarcation between the stockpile and the surrounding countryside.

When, after approximately 40 years, the rock is returned underground, the affected area of land will be reinstated, as near to the original condition as possible.

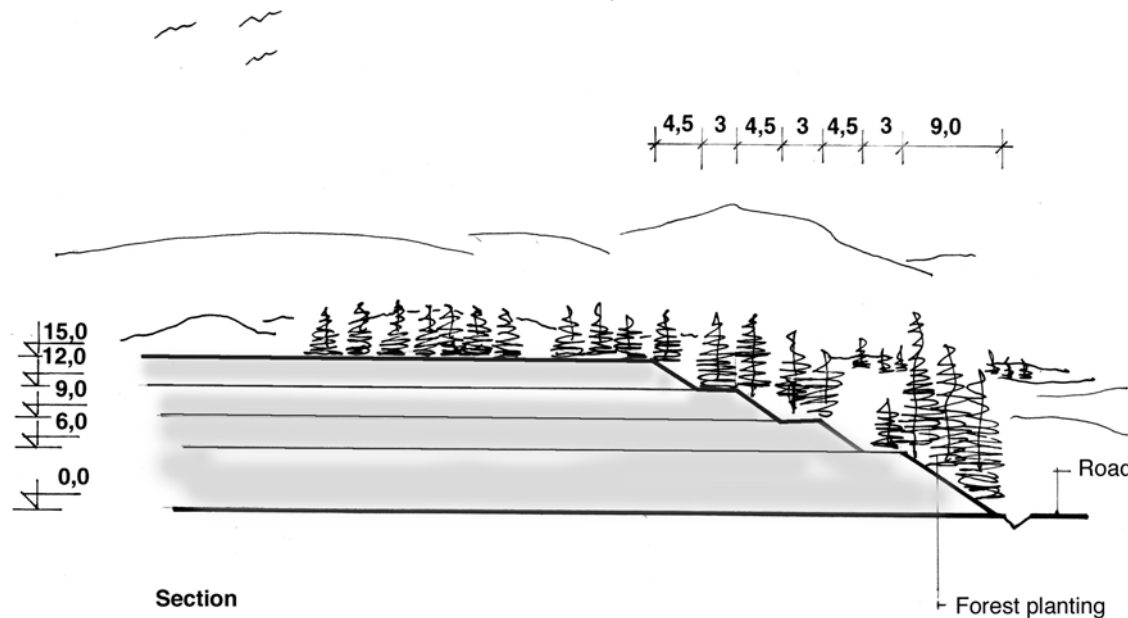

14. ROCK STOCKPILE

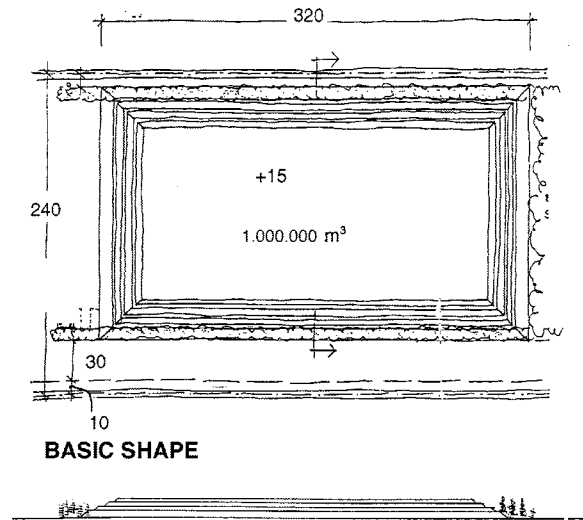

If all of the excavated rock were to be brought together in one pile it would be equivalent to just over the area of eight football pitches placed side by side. At an assumed height of 15 metres, which is equivalent to a five-storey building, this rock stockpile would be an extremely dominant feature in the landscape.

Bearing in mind the variations in the requirements for backfilling material during the operating phase, there is a serious risk that the stockpile would never achieve a defined shape (see basic design.)

If, instead, the stockpile were to be split up into smaller volumes (say three units), it would be blended into the landscape in a more considerate way. This would also make it possible to give most of the stockpile its definitive appearance at an early stage. This part would form a passive stockpile. A smaller part of the rock would form a separate pile, which would take up the variations in the requirement for backfilling material, and act as an “active stockpile” (see variants 1 and 2).

The adjoining solutions for the stockpile area should be seen as theoretical. The possible variations are, of course, unlimited, and are governed primarily by the nature of the landscape in the selected sites.

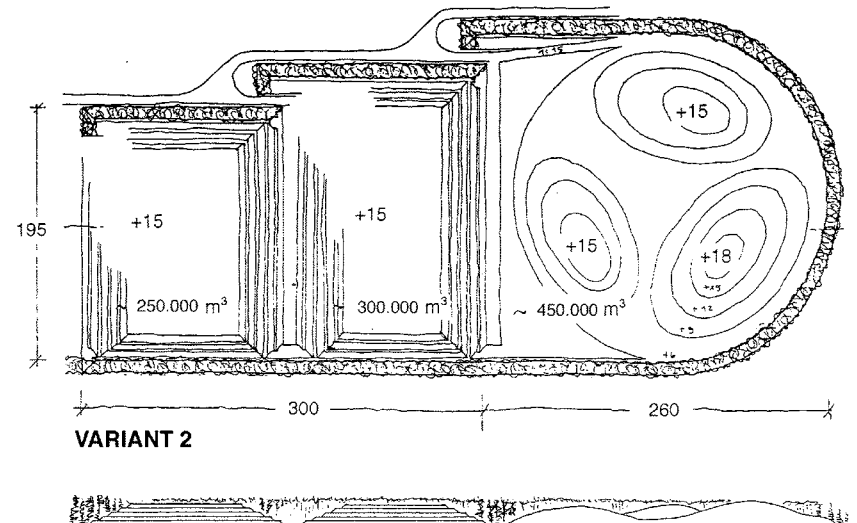
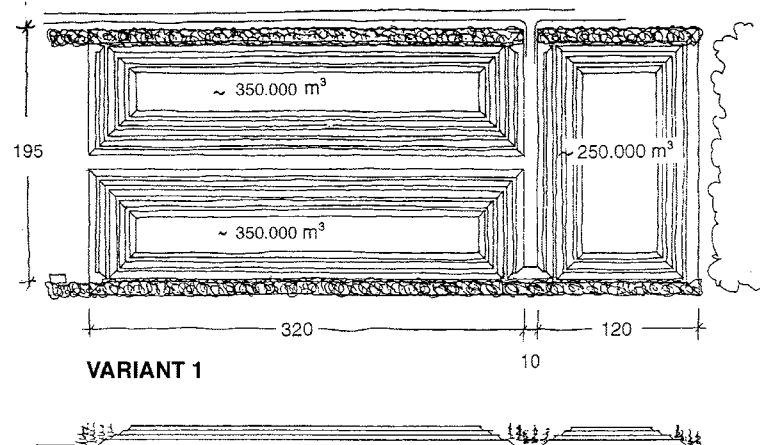

- 15.1 General
- 15.2 Generic arrangement
- 15.3 Theoretical site arrangement
- 15.4 Designations
- 15.5 Operations
- 15.6 Transport routes
- 15.7 Tunnel cross sections
- 15.8 Fire protection
- 15.9 Doors
- 15.10 Ventilation
- 15.11 Repository drainage system
- 15.12 Electricity distribution
- 15.13 Working environment
- 15.14 Data and dimensions

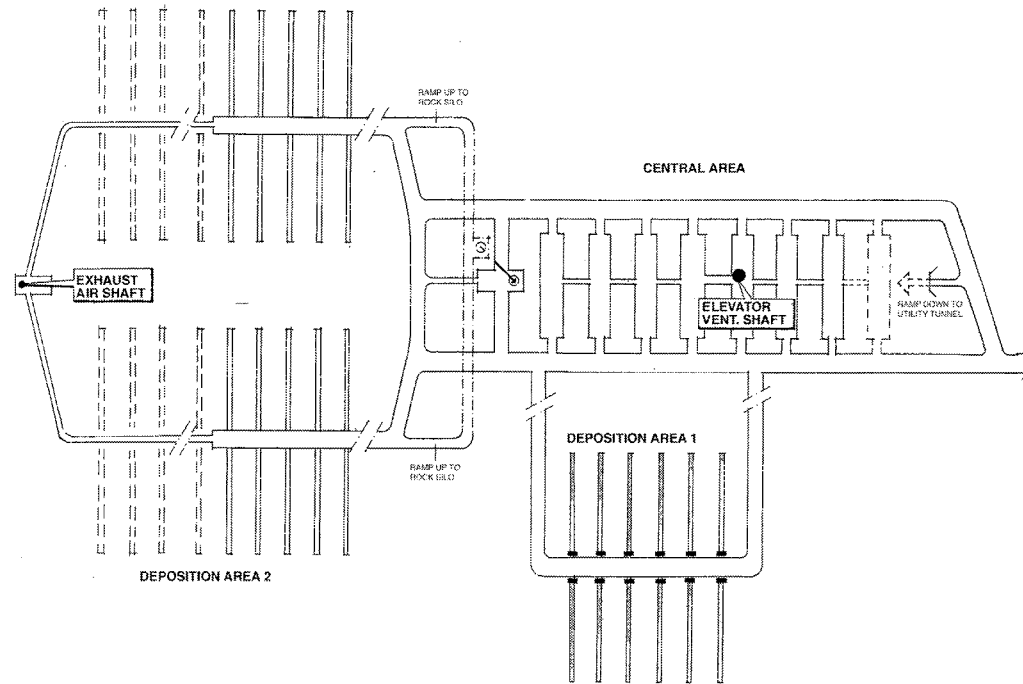

General

The underground area of the deep repository consists of the following units:

- Ramp
- Elevator and ventilation shaft
- Exhaust air shaft
- Central area
- Deposition area 1
- Deposition area 2

Division

The reasons for the division are:

- The central area should be kept together, to provide close contacts between its various functions,
- Deposition area 1 should be separate from, but close by, the central area, so that it can serve as a demonstration area. The separate location means that this section can be filled with canisters and deposition tunnels backfilled before deposition area 2 is started.

The distance between the central area and the canister deposition areas is determined by the location of rock masses of suitable size and quality within the area.

Expansion in stages

The proposed arrangement means that the underground area can be extended in stages and deposition tunnels backfilled with retained function in each phase. The various areas can be constructed and backfilled as desired, within reasonable limits.

Expandability

The generic design makes it possible to extend the underground area with additional vaults and tunnels in each subsection, if so desired.

Simplicity

The underground area is characterised mainly by simplicity, with few variations in the cross sections of the tunnels. The entire underground area is arranged so that almost all of it drains to a common low point due to gravity.

Flexibility

The proposal allows the size of the vaults to be varied, without altering or impairing overall function.

Layout

The proposed arrangement is clear and easy for both facility staff and visitors to find their way around.

Levels

Deposition level at -500 metres
Gradient 1:100 – 1:50 towards the drainage basin in the central area.
Ramp gradient 1:10.

**15. UNDERGROUND - COMMON
15.2 GENERIC ARRANGEMENT**

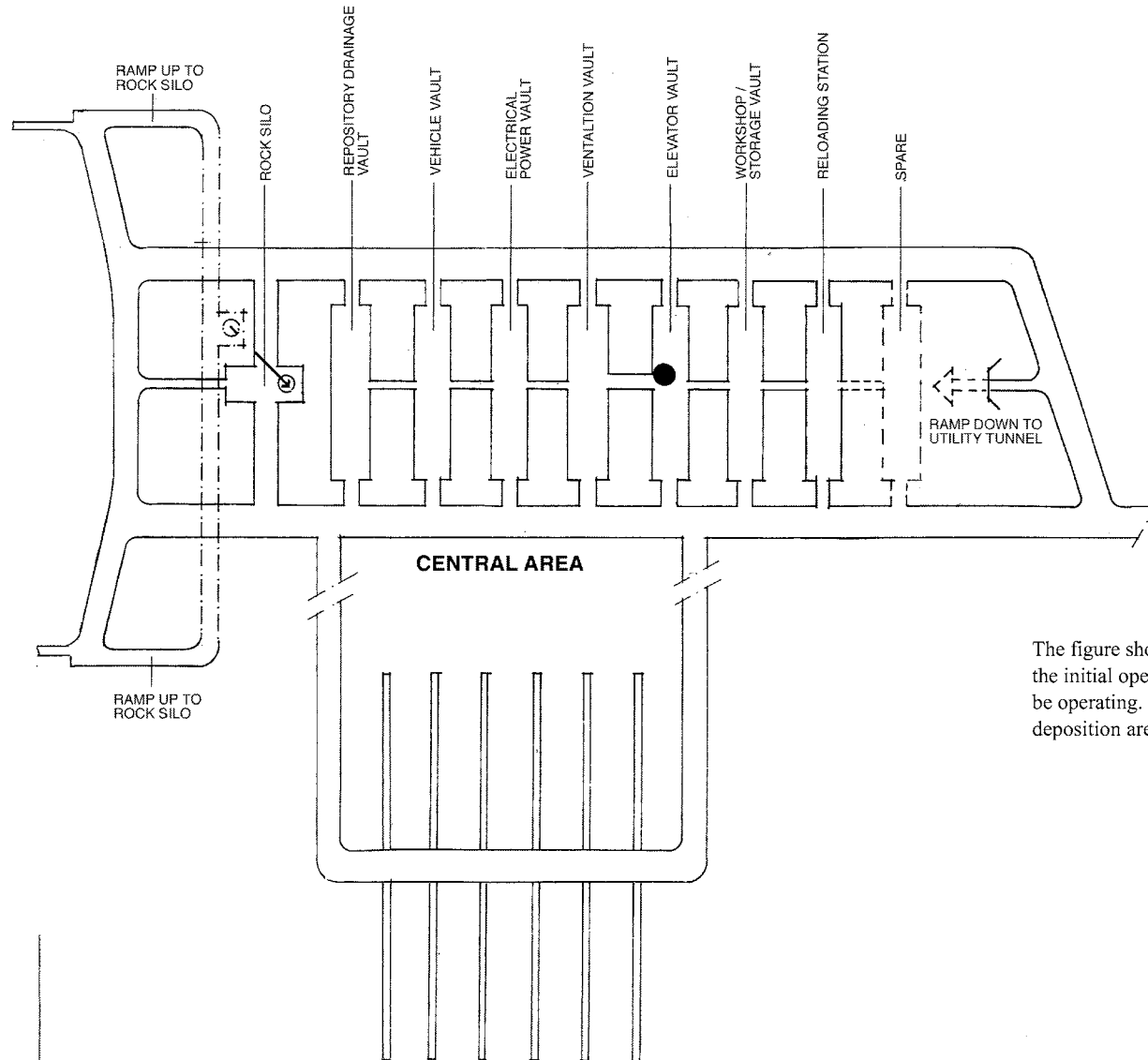

The figure shows the generic design of the facility during the initial operation. All functions in the central area must be operating. During this phase, the exhaust air from the deposition area is led up to the surface via the ramp.

REGULAR OPERATION | INITIAL OPERATION

DEPOSITION AREA 1

15. UNDERGROUND - COMMON
15.3 THEORETICAL SITE ARRANGEMENT

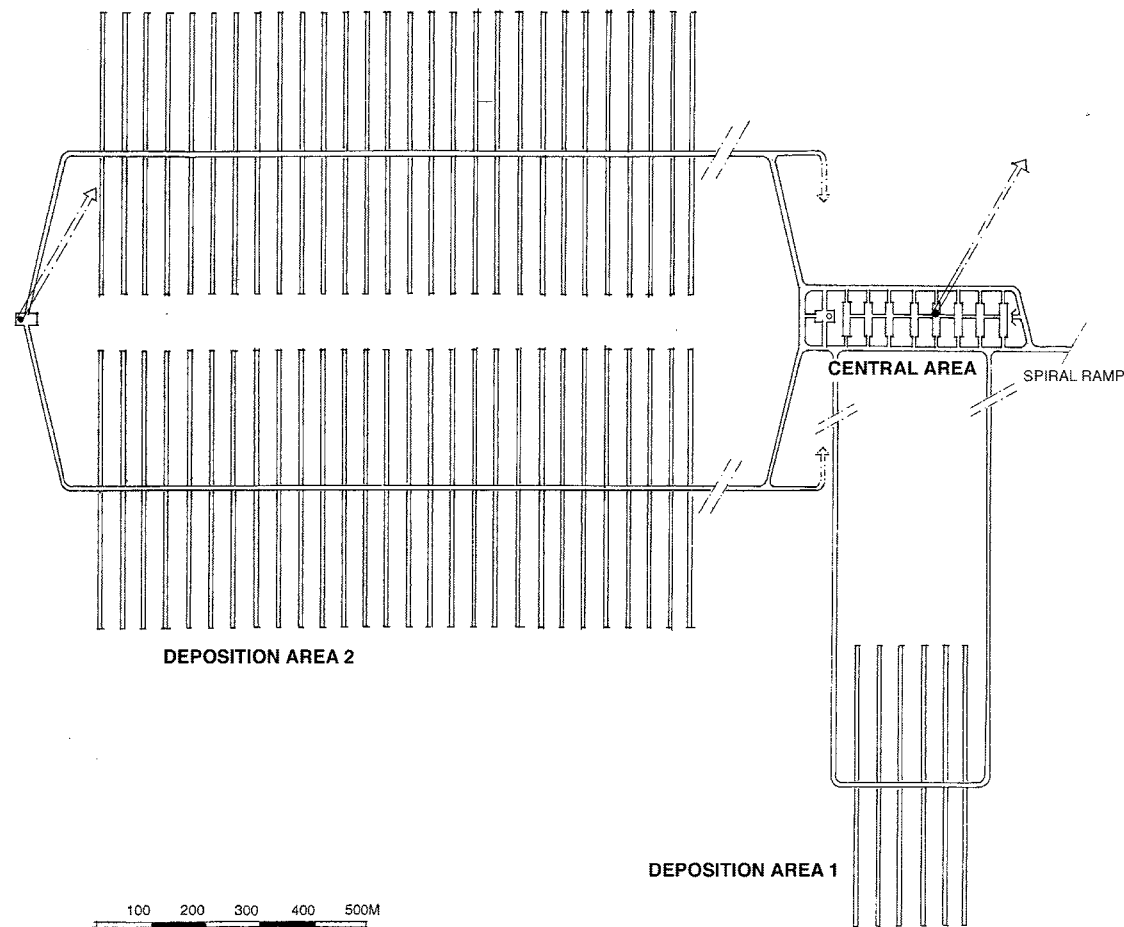

The figure to the left shows a theoretical site arrangement of the underground area of the deep repository. The figure shows the relative proportions of the various parts of the repository, based on the planned division. The area of the deposition area is based on the space required for 4,500 canisters, divided amongst deposition tunnels, with each having 40 positions. The length of the deposition tunnels has been set at 265 metres, with the distance between the centre lines of the deposition tunnels set at 40 metres.

The figure shows extent of the facility when fully developed.

In reality, the deposition area will almost certainly have to be divided up into smaller units, based on the quality of the particular rock, in terms of fracture zones etc. Transport tunnels will link the various sub-areas.

This means that the area used will be somewhat larger than the figure shows.

15. UNDERGROUND - COMMON
 15.4 DESIGNATIONS

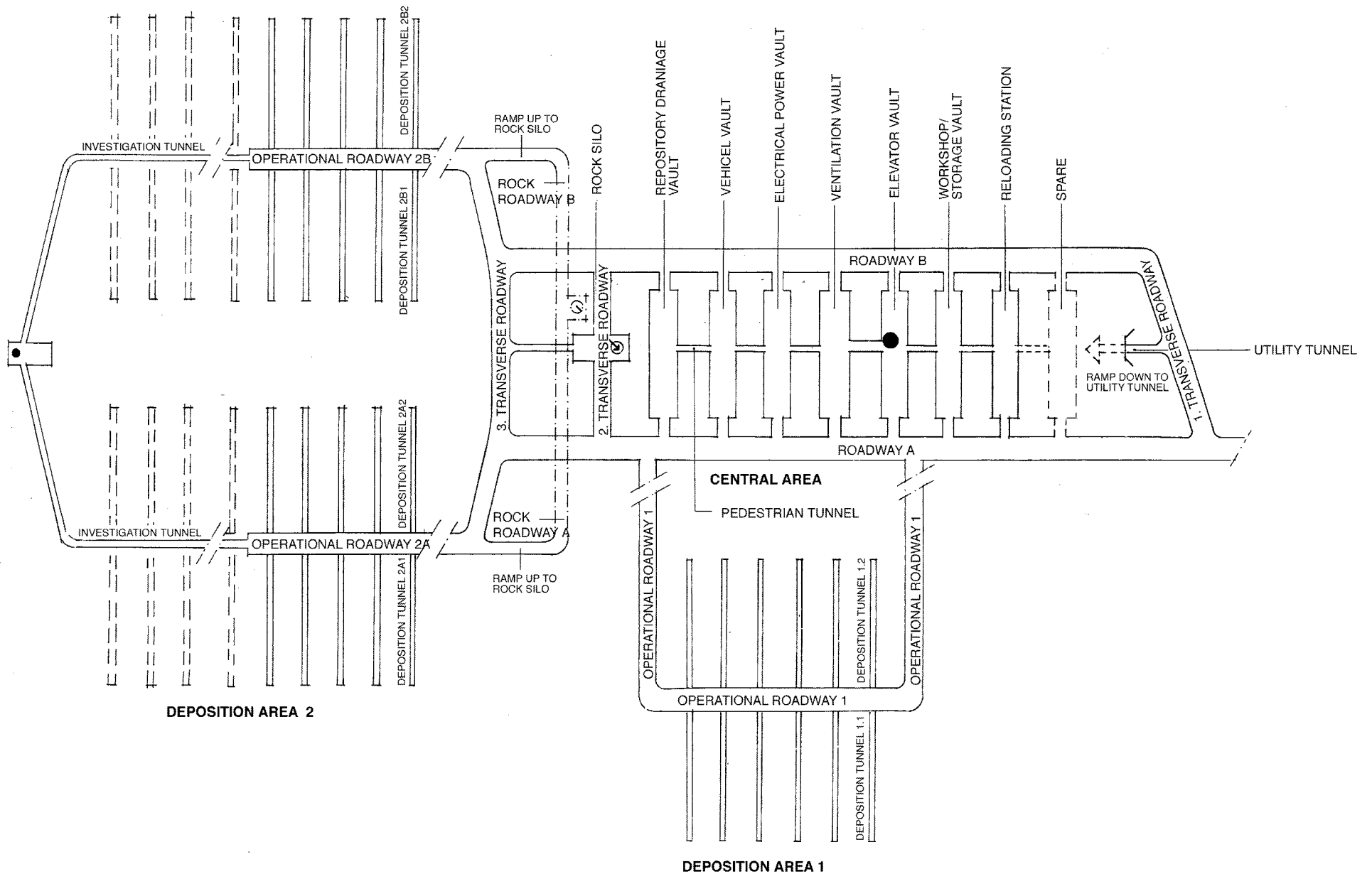

15. UNDERGROUND – COMMON
15.5 OPERATIONS

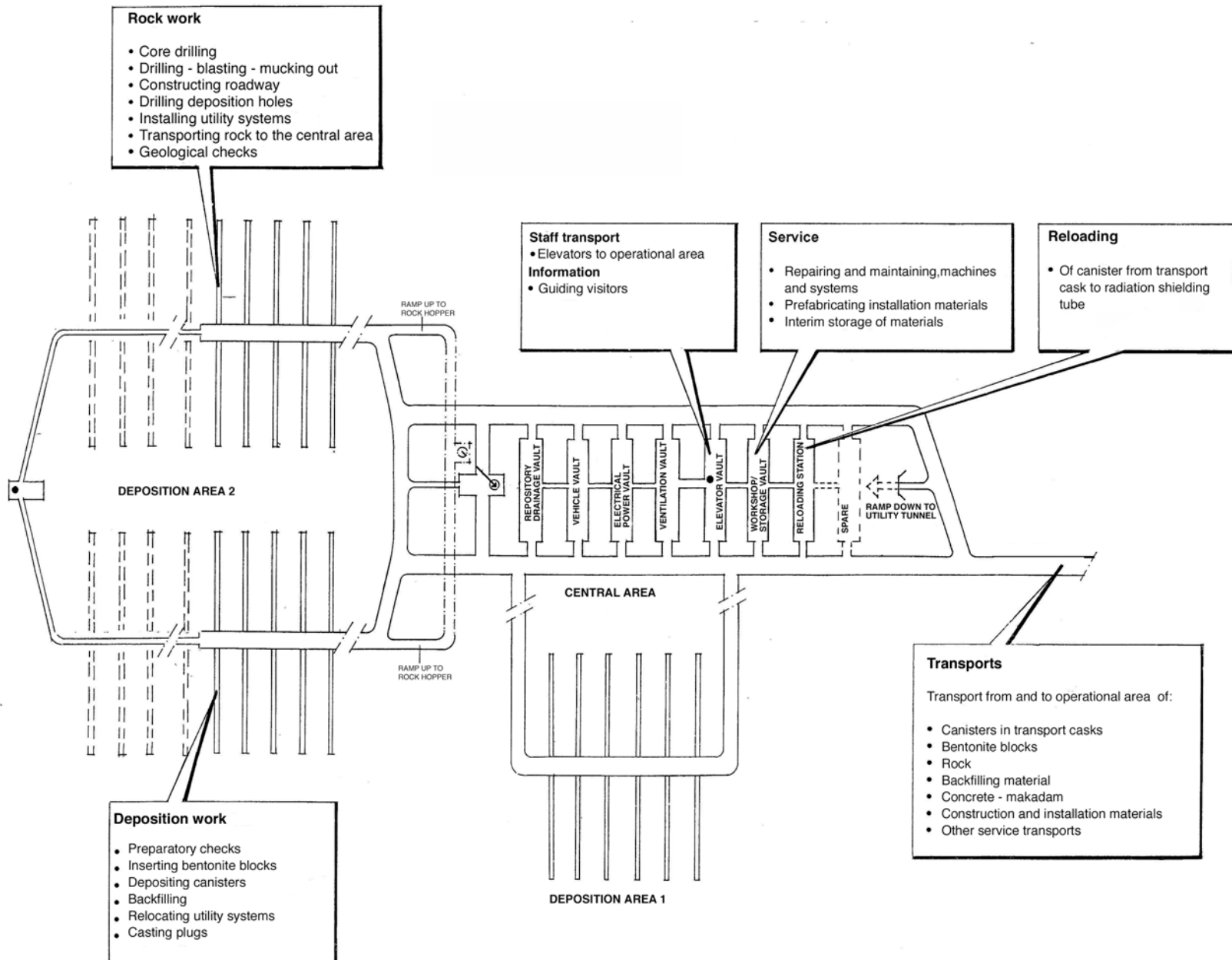

**15. UNDERGROUND - COMMON
15.6 TRANSPORT ROUTES**

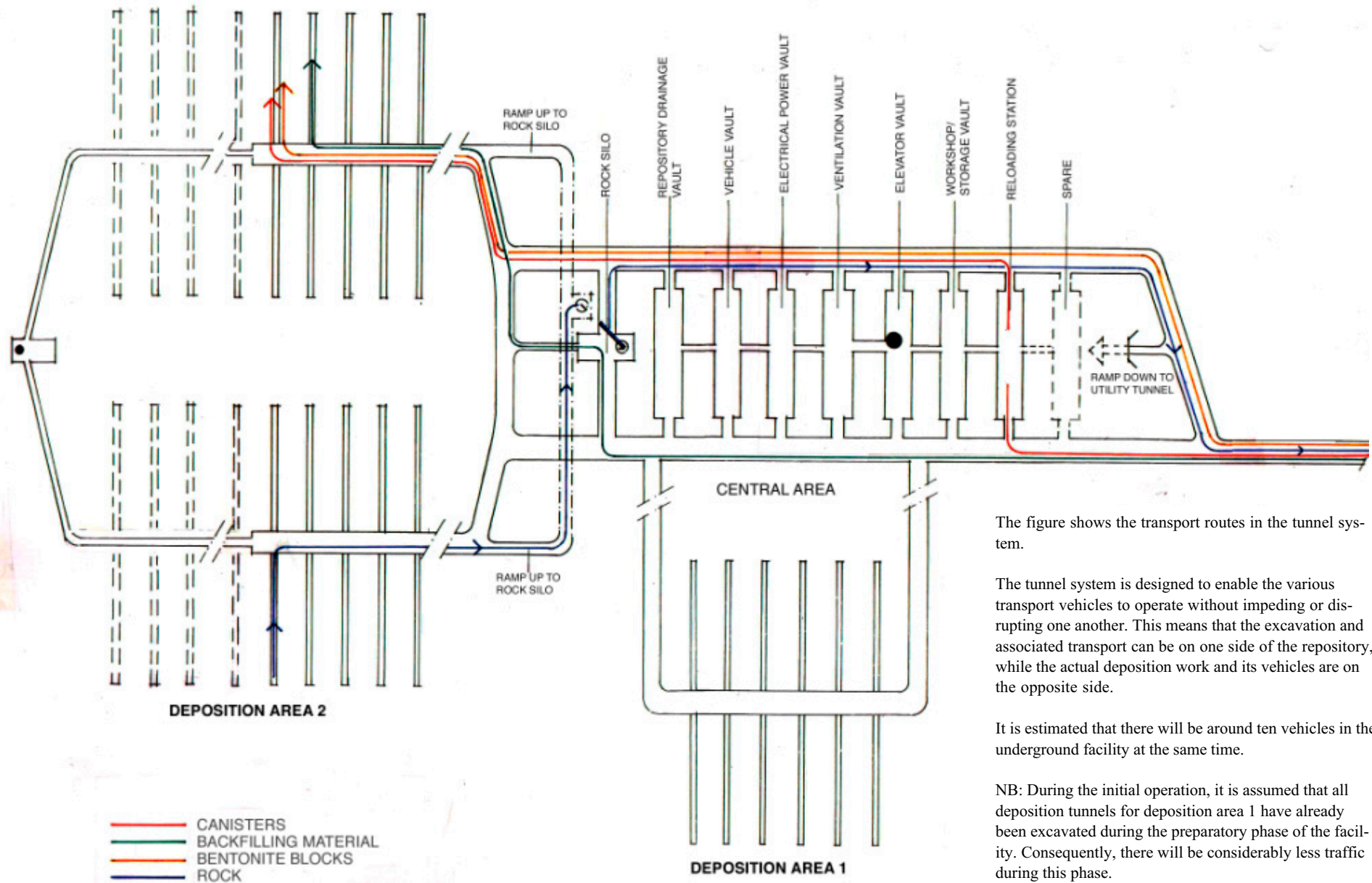

The figure shows the transport routes in the tunnel system.

The tunnel system is designed to enable the various transport vehicles to operate without impeding or disrupting one another. This means that the excavation and associated transport can be on one side of the repository, while the actual deposition work and its vehicles are on the opposite side.

It is estimated that there will be around ten vehicles in the underground facility at the same time.

NB: During the initial operation, it is assumed that all deposition tunnels for deposition area 1 have already been excavated during the preparatory phase of the facility. Consequently, there will be considerably less traffic during this phase.

15. UNDERGROUND - COMMON
15.7 TUNNEL CROSS SECTIONS

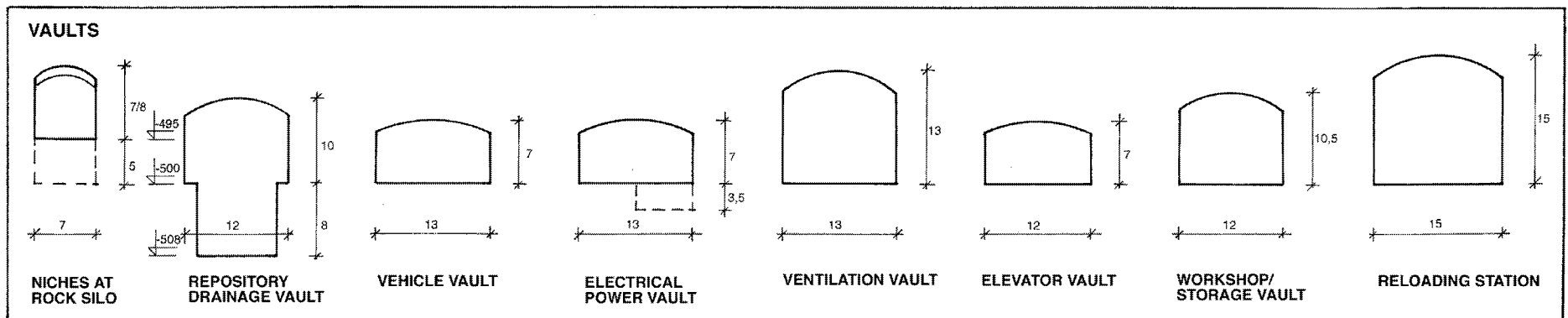
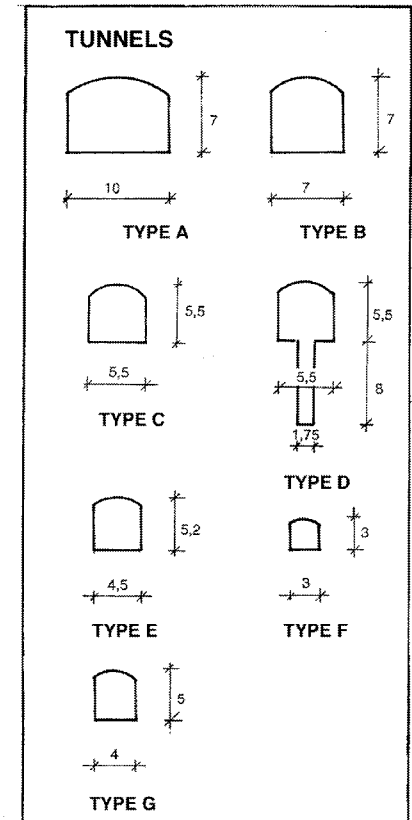
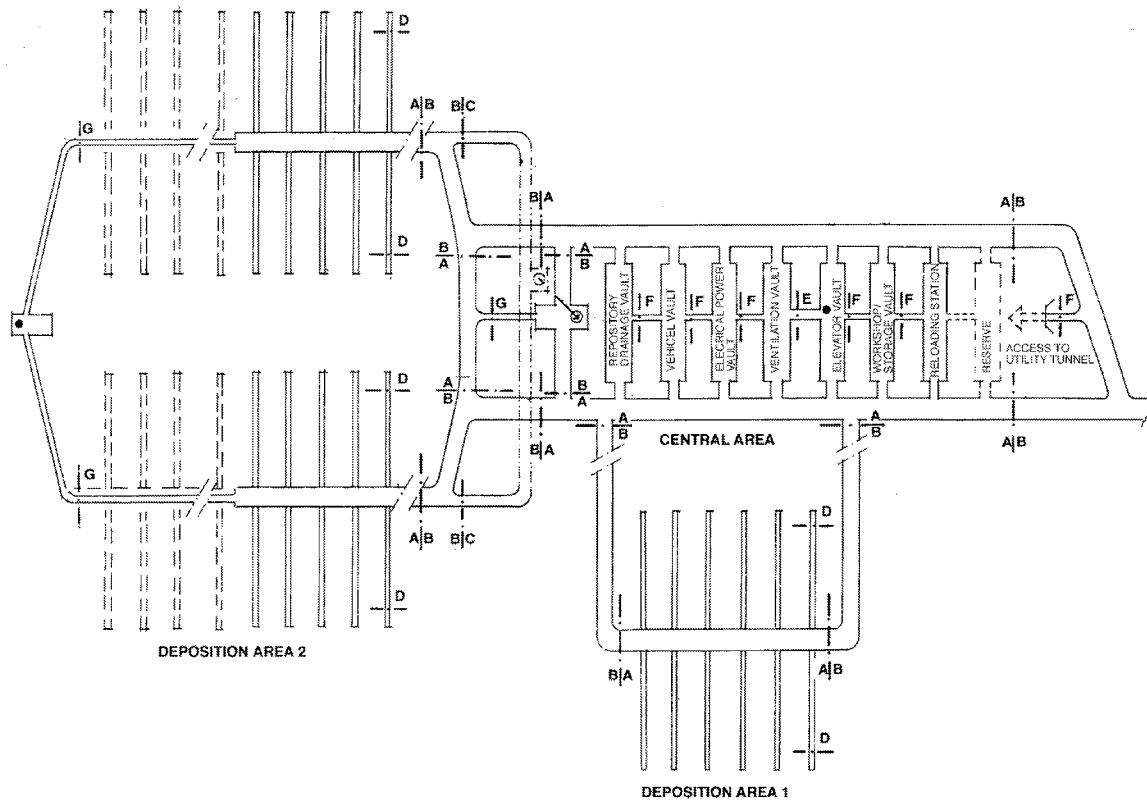

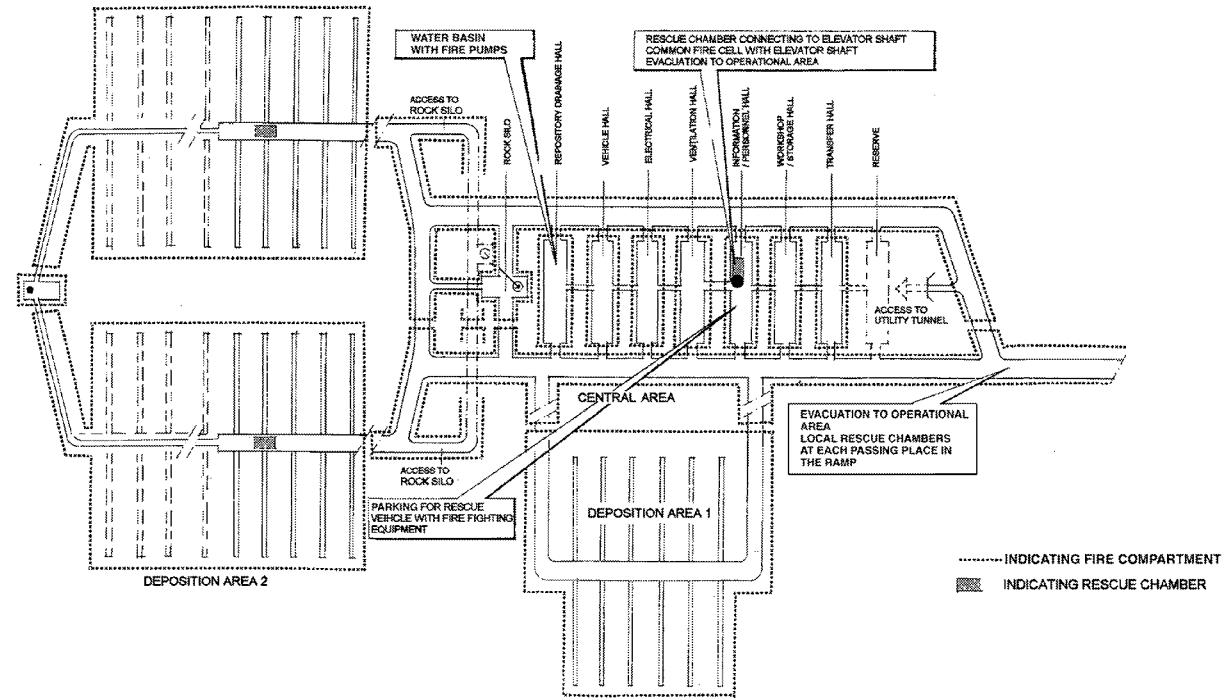

Hazards

The risk of fire is considered to be relatively small in the underground area. The greatest danger is vehicle fires. Other causes of fire could be combustible material in storage areas and overloaded cables.

Vehicles

All vehicles and machines are either electrically or diesel-driven. All vehicles that are permitted to operate in the underground part of the facility will be fitted with a fire extinguishing system.

Division into fire zones

To limit the consequences of fire, the facility is divided up into fire zones. The fire zones are divided by means of doors that are normally closed and doors that are closed automatically if there is a fire alarm. The number and location of the doors are shown in a separate page.

Evacuation routes

There are evacuation routes via the elevator and ventilation shaft and the ramp to the operational area.

In addition to evacuation, a rescue chamber is connected to the elevator and ventilation shaft in the elevator vault and mobile rescue chambers are required for workplaces in the deposition area. There are also rescue chambers connected to the elevator and ventilation shaft at each passing place in the ramp.

Extracting combustion gases

The facility ventilation system will extract combustion gases.

Fire alarm

The facility will have a fire alarm system, designed for the operations and layout of the facility.

System for extinguishing fires

A fire fighting water system will be installed, with fire hydrants in strategic locations around the facility. A vehicle with fire extinguishing equipment will be parked in the central area, to provide quick assistance.

There is a fire fighting water basin, with pumps, in the drainage vault in the central area. The basin is filled with fresh water from the operational area. Repository drainage water should not be used, due to the corrosion risk posed by the anticipated high salt content. Hand-held fire extinguishers will be set up in current workplaces.

Other

The facility will be equipped with emergency lighting, to facilitate evacuation and rescue operations. Sign systems will be arranged to facilitate orientation in the tunnel system.

15. UNDERGROUND - COMMON DOORS
15.9 DOORS

Doors

The facility requires doors in strategic places, to fulfil the following functions:

- Separating the areas for environmental reasons.
- Separating the areas to form effective fire zones.

The adjoining sketch shows where the doors need to be located.

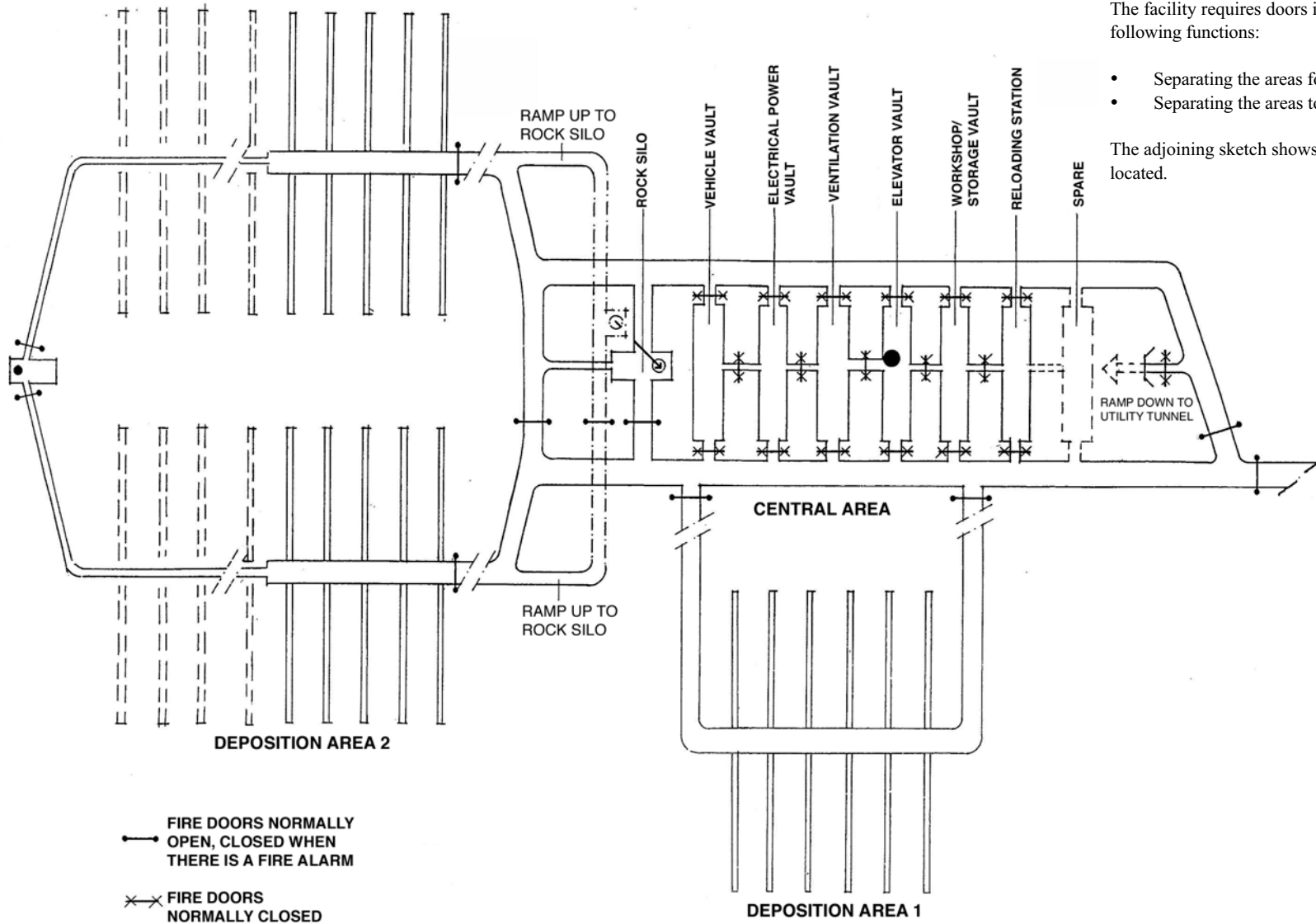

● FIRE DOORS NORMALLY OPEN, CLOSED WHEN THERE IS A FIRE ALARM
 ✕ FIRE DOORS NORMALLY CLOSED

15. UNDERGROUND - COMMON
15.10 VENTILATION

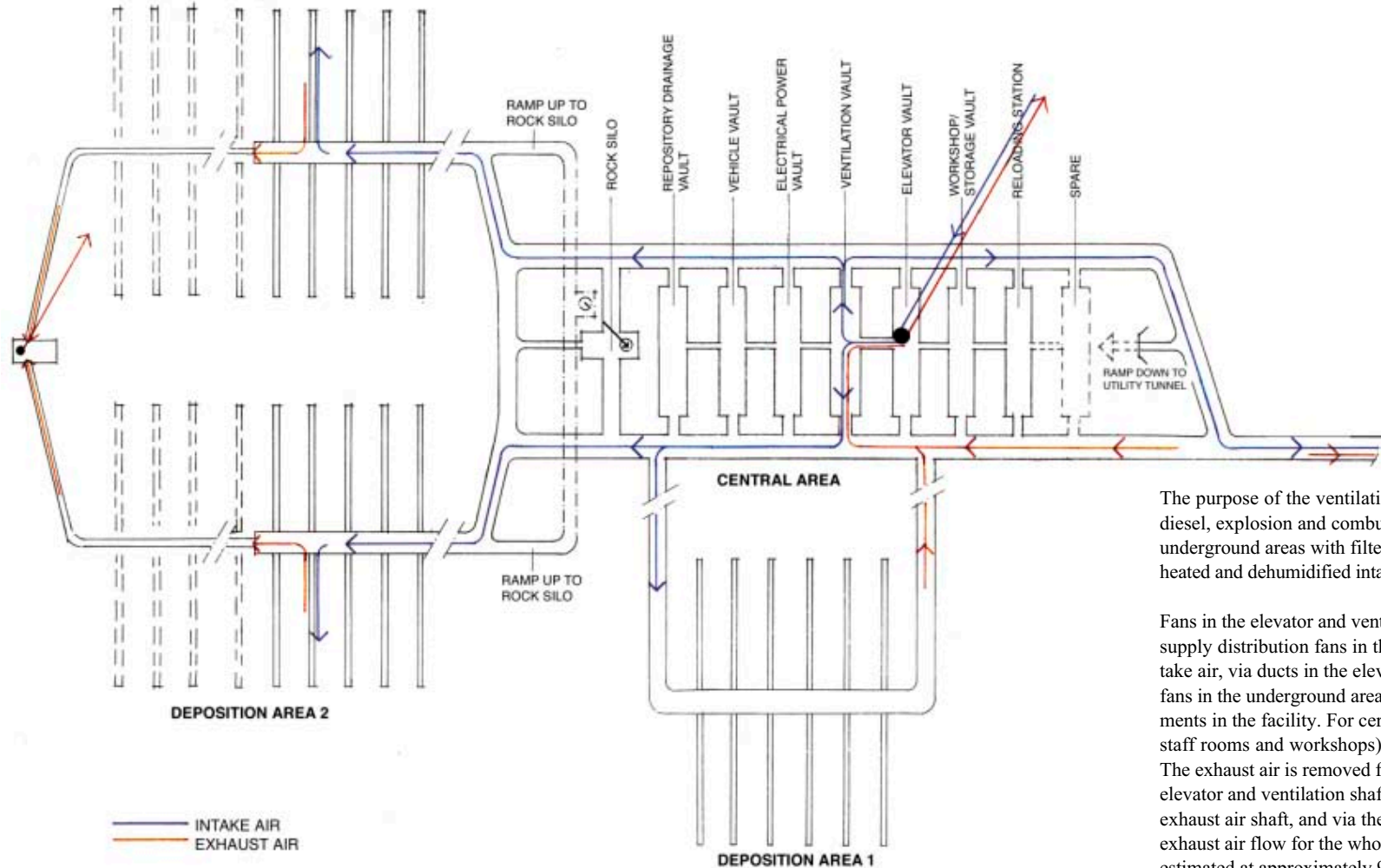

The purpose of the ventilation is to carry away radon, diesel, explosion and combustion gases, and to supply the underground areas with filtered and, when necessary, pre-heated and dehumidified intake air.

Fans in the elevator and ventilation building on the surface supply distribution fans in the underground area with intake air, via ducts in the elevator and ventilation shaft. The fans in the underground area serve various fire compartments in the facility. For certain fire compartments (e.g. staff rooms and workshops), the intake air is postheated. The exhaust air is removed from the central area via the elevator and ventilation shaft, from deposition area 2 via an exhaust air shaft, and via the ramp. The total intake and exhaust air flow for the whole facility has been preliminary estimated at approximately 90 m³/s, if vehicles and machines are electrically driven. If there is increased use of diesel-driven vehicles and/or radon levels in the rock are higher, the airflow will have to be higher.

During initial operation, only the elevator and ventilation shaft is used for intake and exhaust air ducts. During regular operation, the exhaust air system is supplemented by a shaft at the far end of the deposition area. The exhaust air duct in the elevator and ventilation shaft is used solely for extracting exhaust air and smoke from the central area.

15. UNDERGROUND - COMMON
15.11 REPOSITORY DRAINAGE SYSTEM

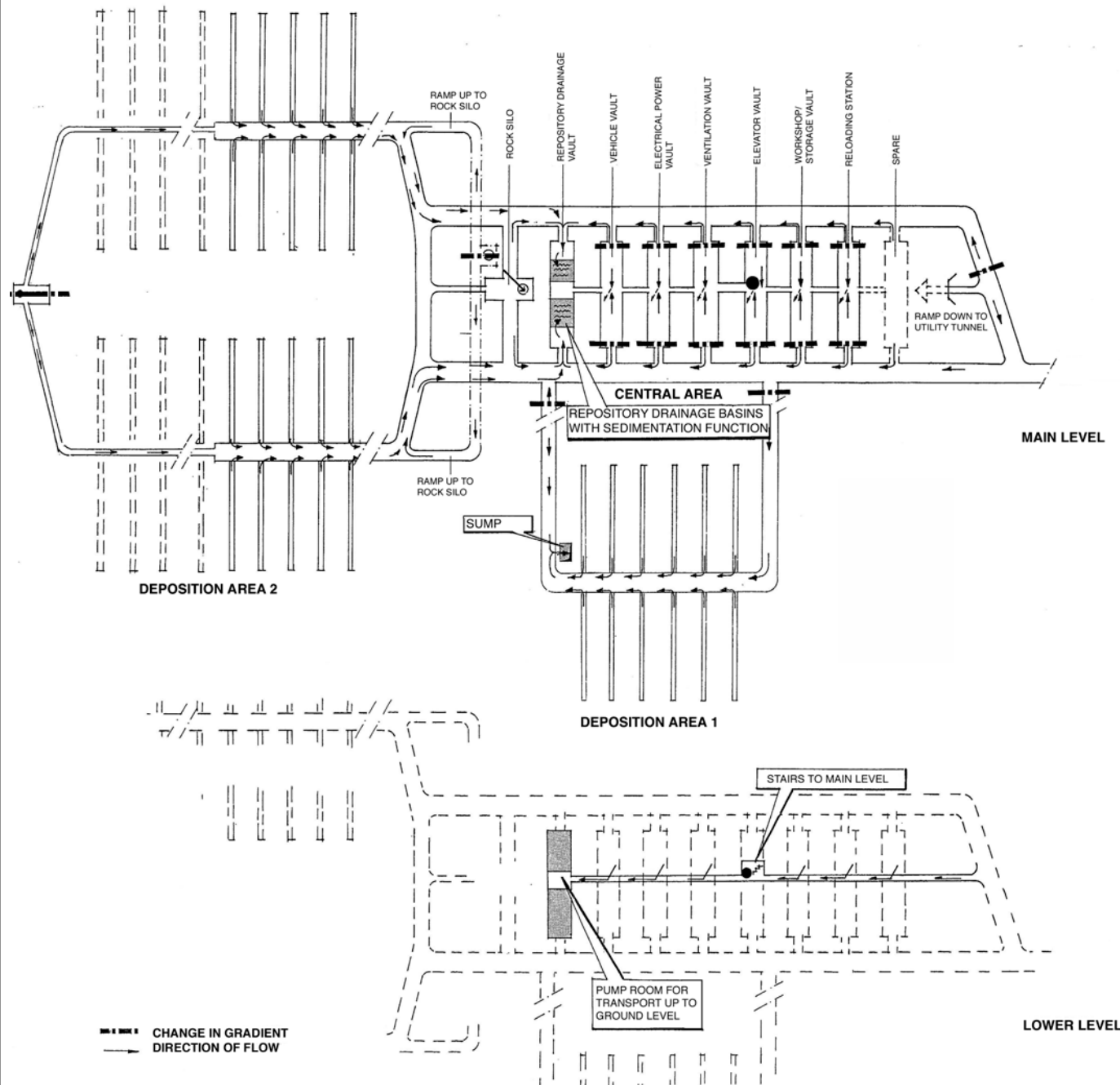

It is difficult to estimate in advance how much water will leak in. The rock will be sealed to a reasonable extent, to reduce the amount of water leaking in. The extent of sealing will be based on individual requirements for each part of the facility, and pumping costs. The system for dealing with the repository drainage water in the underground area of the facility is designed on the basis of the following principles:

- All tunnels are constructed with a gradient of one percent, to a common low point in the central area. This provides a simple system with a minimum number of pumps. The implementation of this principle determines the levels in the entire underground area. Deposition area 1 may have a local drainage sump.
- The repository drainage water is led along the tunnels in open channels, between the roadway and the rock wall.
- Drainage pipes are laid in the roadway where tunnels cross.
- The deposition tunnels are drained through the macadam bed, which forms a temporary roadway, out to the main tunnel, where the water is collected by the drainage system in the main tunnel.
- The repository drainage basin is designed so that sludge can settle on the bottom and oil can be separated off from the surface of the water. The basin is divided into two sections, so that one section at a time can be emptied to remove sludge. The pumps are located between the basins, to give the shortest possible pipe system. Theoretically, the volume of the repository drainage basin can cope with a power outage of 10 hours, without any part of the repository flooding.
- The repository drainage water is pumped to the operational area in a single stage, via the elevator and ventilation shaft. Here, heat pumps extract the thermal energy from the water. The repository drainage water will probably have to be desalinated before it is led to a suitable nearby water system.
- The vaults in the central area are drained by a pipe in the utility tunnel that links them, to a local sump in the central part of the repository drainage vault. From there, the water is pumped up into the common basin.

**15. UNDERGROUND - COMMON
15.12 ELECTRICITY DISTRIBUTION**

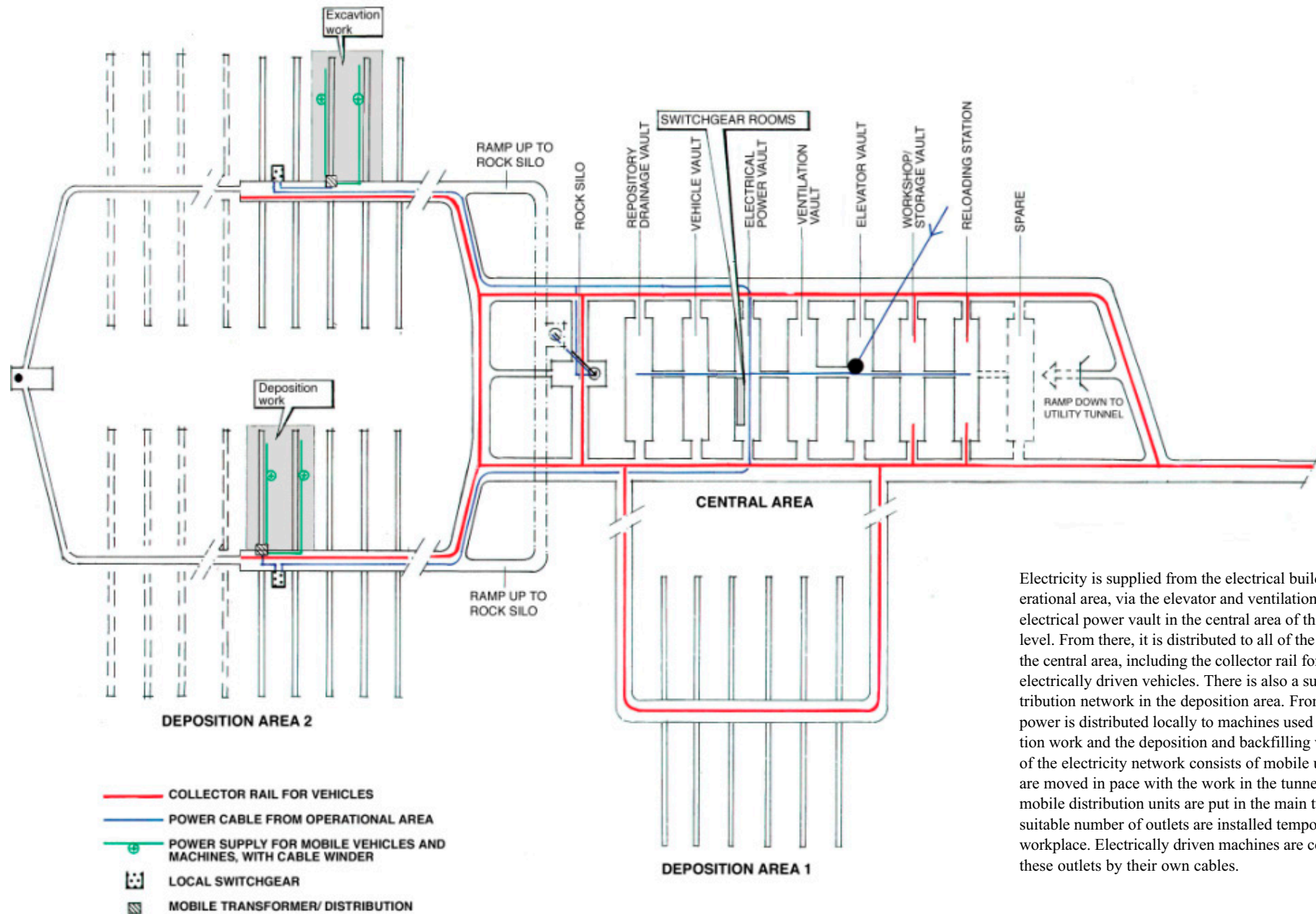

Electricity is supplied from the electrical building in the operational area, via the elevator and ventilation shaft, to the electrical power vault in the central area of the deposition level. From there, it is distributed to all of the fixed loads in the central area, including the collector rail for supplying electrically driven vehicles. There is also a supply to a distribution network in the deposition area. From this network, power is distributed locally to machines used in the excavation work and the deposition and backfilling work. This part of the electricity network consists of mobile units, which are moved in pace with the work in the tunnel system. The mobile distribution units are put in the main tunnels, while a suitable number of outlets are installed temporarily in each workplace. Electrically driven machines are connected to these outlets by their own cables.

**15. UNDERGROUND - COMMON
15.13 WORKING ENVIRONMENT**

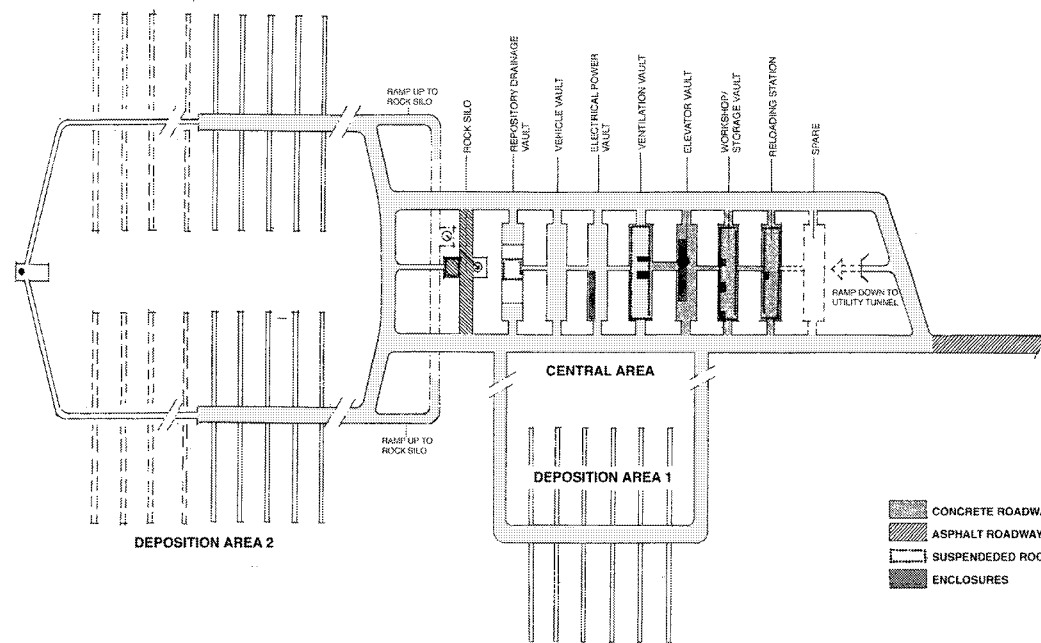

General

The underground area of the facility consists mainly of bare tunnels and vaults. The climate is damp, with a temperature of around 12°C throughout the year. The chosen air change rate should produce relatively good air quality, with diesel and radon gases being vented out. The explosion gases are vented out via a shaft at the far end of the deposition area, so they do not affect other areas in the facility. Electrically driven vehicles transport heavy loads. Most of the machines will also be electrically driven. It is envisaged that the staff will wear heavy clothing for normal outdoor work. Boots and hard hats are required.

Enclosures

Local enclosures are necessary, to create a controlled working environment and acceptable conditions for electronic and electrical equipment. However, the aim is to limit the need for enclosures as much as possible, without compromising function and the working environment.

Suspended roofs

Suspended roofs are required in the vaults in the central area, as a protection from water that leaks in. Local suspended roofs are also required in the ramp, transport tunnels and main tunnels.

Roadways

The roadway in the ramp has a wearing course of asphalt. Experience shows that the drive wheels of vehicles can skid on concrete roadways. Transport tunnels and main tunnels on the deposition level have concrete roadways. The deposition tunnels are provided with a macadam roadway for certain stages of the work.

Lighting

The tunnel system will have general lighting, designed primarily for vehicular traffic. It should also be possible to walk along the tunnels without a torch.

There will be a high standard of lighting in the tunnels around the vaults in the central area, as staff and vehicles frequently move around in this area. There is adequate task lighting in the vaults.

Temporary lighting is installed in the work areas in the deposition area. This lighting is moved as the deposition or excavation work advances along the main tunnels. The passing places in the ramp have a higher lighting level, to facilitate the passage of vehicles and aid orientation. In addition, all vehicles and machines will have lights.

15.
15.14

**UNDERGROUND - COMMON
DATA AND DIMENSIONS**

AREA	Length, m	Width, m	Height, m	Diameter, m	Volume, m ³
• Ramp	5,400	7	7	-	250,000
• Niches in ramps (5)	45	5	7	-	7,900
• Exhaust air shaft	-	-	500	3	3,500
• Elevator and ventilation shaft	-	-	500	8.5	28,000
• Central area				-	
• Reloading station	50	15	15.5	-	11,000
• Vehicle and workshop vault	66	12	10	-	7,900
• Elevator vault	66	12	7	-	5,500
• Ventilation vault	66	13	13	-	11,000
• Electrical power vault	66	13	8.5	-	6,500
• Vehicle vault	66	13	7	-	5,500
• Repository drainage vault				-	
• main level	66	12	10	-	7,500
• lower level	52	9.5	8	-	3,600
• Niche for rock silo				-	
• silo			18	7.5	700
• unloading rock	15	7.5	7	-	800
• unloading backfill. mat.	16	7,5	8	-	900
• loading rock	16.5	7	7	-	850
• Deposition areas					
• Deposition area 1	540	290			100,000
• Deposition area 2	1,100	1,100			925,000
• Tunnel system					
• Roadway A	300	10	7	-	20,000
• Roadway B	300	10	7	-	20,000
• Rock roadway A	300	5.5	5.5	-	10,000
• Rock roadway B	300	5.5	5.5	-	10,000
• Operational roadway 1	1,300	10/7	7		65,000
• Operational roadway 2A	1,500	10/7	7		90,000
• Operational roadway 2B	1,500	10/7	7		90,000
• Investigation tunnel	620	4	5		12,000
• Utility tunnel	300	3	3		2,700
• Pedestrian tunnel	100	3	3		1,000
Total excavated volume					approx. 1,700,000
Equivalent volume loose material					approx. 3,100,000

The figures in the table are based on the theoretical extent of the underground area, as described in the site arrangement.

- 16.1 General
- 16.2 Ramp
- 16.3 Tunnels
- 16.4 Special solutions
- 16.5 Shafts
- 16.6 Co-ordination between ramp and shaft

16

RAMP - TUNNELS - SHAFTS

General

The ramp, tunnels and shafts together make up the necessary space for access to the underground area and its rock mass, where the spent nuclear fuel will be deposited.

These spaces form a comprehensive transport and communication system, which links the vaults in the central area with the various deposition areas.

The ramp and tunnels have been designed to allow the necessary transport of staff, rock, transport casks containing canisters, buffer material, building materials, backfilling material and machinery. The tunnel system will also be used for installing the systems required for both the excavation and operational phases. The extent of the tunnel system is shown in the site arrangement, in which each tunnel cross section is shown by a different colour.

Size

The tunnel system on the deposition level has been planned in a way that provides good accessibility between the different sub-areas while the operations are underway. The proposed cross sections take account of all planned types of transport vehicles, as described in chapter 7, as well as individual movements of large machines between workplaces.

In most sections of the tunnels, the transport and handling of transport casks and shielded tubes with canisters have determined the size.

Safety

The design of the tunnel system has also been influenced by the need for safe evacuation.

Layout for the communication section

The following definitions have been used when giving the proposed data and dimensions for the tunnel cross sections.

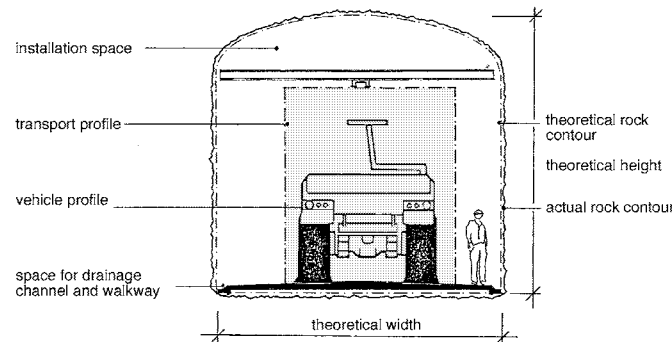

Gradient of tunnel system – Changes in gradient

It is assumed that the tunnel system on the deposition level will have a gradient of 1:100 to the repository drainage basin in the central area. If this principle is abandoned for some reason, it will be more difficult to deal with water that leaks in.

Large changes in gradient will be gradual, to prevent problems for “long vehicles”.

Curve radius

Curve radius will be limited to 15 metres, to ensure access for “long vehicles”.

Transport

The table on page 16-5 shows the transport in each tunnel section. For more information about transport and vehicles, see chapters 7 and 8.

Road surface

The ramp will be given a rolled concrete roadway with a surface layer of asphalt. The asphalt layer is to increase the friction and thus help prevent the drive wheels of the vehicles from skidding.

The transport tunnels on the deposition level will be given a rolled concrete roadway throughout. The exception is the investigation tunnel in the loop round deposition area 2, which will have a macadam surface.

The floors of the deposition tunnels will be surfaced with macadam. See chapter 18.

Walls - Roofs – Suspended roofs

Large areas of the roofs and walls in the ramp, main and transport tunnels and vaults will be sprayed with concrete. This is to stabilise the rock and minimise maintenance costs. Suspended roofs will be installed in individual areas as required, to collect and lead away water dripping from the roof.

16. RAMP - TUNNELS - SHAFTS
16.1 GENERAL

Attachments

Horizontal steel sections are attached to the roof at regular intervals, to support cable racks, pipes, ventilation ducts, lighting fittings, traffic signals, the collector rail and signs. The steel sections are attached to the roof by rock bolts. Columns from the floor will be avoided, to increase accessibility.

System installations

Table 2, page 16-5 shows the systems in each tunnel section. The table gives an idea of the type and space requirements of the tunnels.

For information about systems that affect the size/design, refer to chapter 19.

Signs

The ramp and the tunnel system will be fitted with signs for information, traffic, safety and distances.

Lighting

General lighting is installed in the ramp, limited to enabling staff to get around. The passing places on the ramp have stronger lighting.

The tunnel system on the deposition level has general lighting in the transport sections and higher lighting levels in adjoining places.

The lighting in the work areas is suited to individual requirements, and will be moved as the work progresses.

DOOR IN TYPE A TUNNEL

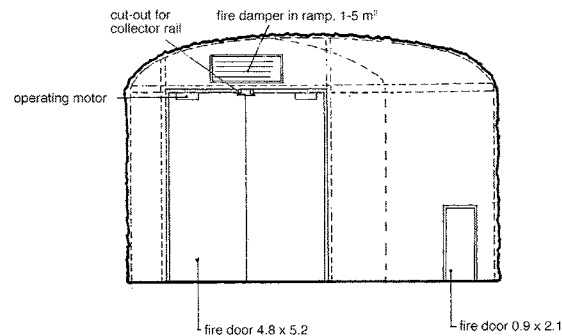

DOOR IN TYPE B TUNNEL

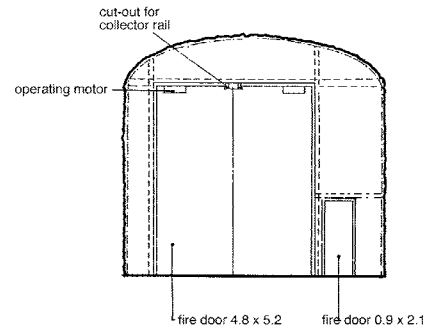

DOOR IN TYPE F TUNNEL

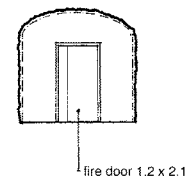

Doors – pedestrian doors

The ramp and tunnel system will be fitted with doors and pedestrian doors, to demarcate the ramp from the outside and enable fire zone division and the segregation of different activities.

The following doors are planned:

- Outer door to the outside in the portal building.
- Fire doors at the passing places in the ramp.
- Fire doors and doors separating different operations in the central area.
- Fire doors in the transport tunnel system.

The above doors will be fitted during the excavation prior to the facility going into operation, to provide compartmentalisation in the event of a fire.

Section 15.9 shows the locations of the doors.

The doors to the vaults in the central area will normally be closed. They will be motor-driven, and be operable locally from both sides if necessary. There will be a separate pedestrian door next to each door.

The outer door in the portal building at the mouth of the ramp will be designed to fulfil the requirement for shell protection. The door will be motor-driven, and it should be possible to operate it remotely from the operational centre and authorised vehicles.

The fire doors will normally be open, and will be closed automatically when there is a fire alarm. The doors will be motorised, and it should also be possible to control them locally, when the emergency services need to gain access.

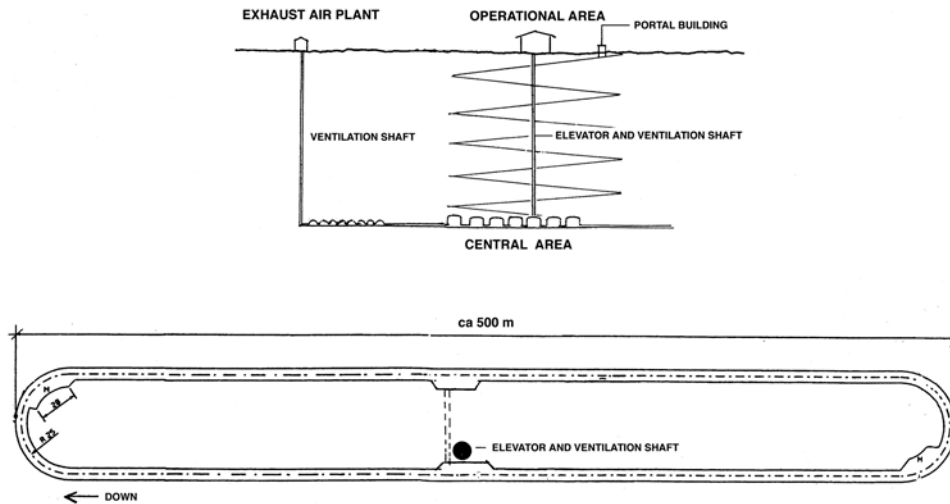

16. RAMP - TUNNELS - SHAFTS

16.2 RAMP

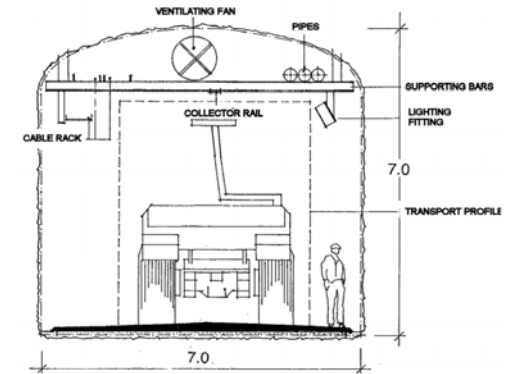

Ramp

This refers to the stretch from the portal building in the operational area to the central area on the deposition level at -500 metres.

Types of transport

During regular operation, the ramp will be used for all heavy and bulky transport requirements between the surface and the deposition level. The exception is most staff transport, which will be by elevator.

Transport that determines the size

The cross section of the ramp has been chosen in view of the following requirements:

- Two standard trucks should be able to pass at any point on the ramp.
- A truck and a heavy electrically driven truck, or two heavy trucks, can pass at the passing places.
- The height has been chosen so that it allows the passage of a truck with a superstructure with a maximum height in line with EU regulations (4.2 m). The collector rail and a safety distance have been assumed to need a height of 0.5 m.
- The chosen cross section contains a margin for transporting any units larger than those currently envisaged.

Layout

A proposal for arrangement of the spiral ramp is shown above. As seen in a plan view the ramp consists of two parallel tunnels with 180 degrees curves at each end. The length of each leg is about 500 metres. The distance between the legs is assumed to be 50 metres in a plan view. The spiral ramp starts at the portal building in the operational area and ends at the central area at a level of -500 metres.

The spiral consists of five turns with a total length of 5000 metres with an average gradient of 1:10.

The spiral ramp will be co-ordinated with the operational area on ground level and the central area on deposition level permitting the elevator and ventilation shaft to be located centrally in the system.

The shaft will be located between the legs of the ramp in such a way that it will be connected to one leg of ramp on each passing level. The shaft might be connected to the other leg with a short connecting tunnel.

By connecting the spiral ramp to the shaft escape routes are created. A lock at each connecting tunnel will separate the ramp from the shaft. See page 16-15.

Cables and pipes in the shaft might be connected to the ramp at each level.

Passing places will be arranged at each connection to the shaft. The layout of the passing places is shown on page 16-10.

Fire doors

In order to limit the effects of a fire in the ramp and facilitate the work of the fire service, a smoke barrier door has been placed at each passage.

To obtain a good seal when the doors are closed, folding doors will be used. These will allow the collector rail to pass through.

Data and dimensions

- Width: 7 m
- Height: 7 m
- Cross-sectional area: 48 m²
- Assumed length: 5,000 m
- Assumed volume: 250,000 m³
- Average gradient: 1:10
- Min. curve radius: 15 m

16. RAMP - TUNNELS – SHAFTS
16.3 TUNNELS

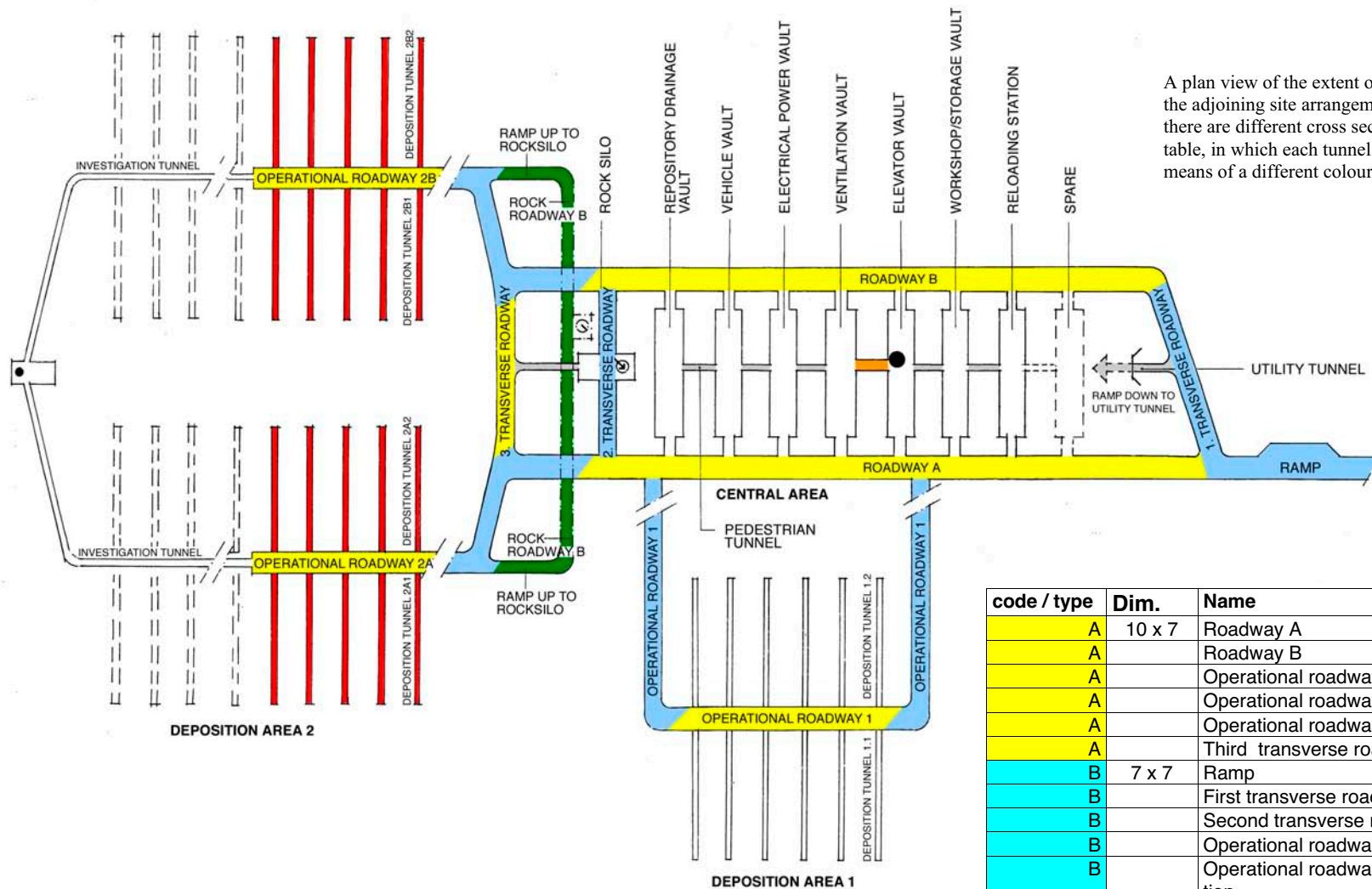

A plan view of the extent of the tunnel system is shown in the adjoining site arrangement. For functional reasons, there are different cross sections, as shown the following table, in which each tunnel cross section is shown by means of a different colour.

code / type	Dim.	Name
A	10 x 7	Roadway A
A		Roadway B
A		Operational roadway 1 - Main tunnel section
A		Operational roadway 2A - Main tunnel section
A		Operational roadway 2B - Main tunnel section
A		Third transverse roadway
B	7 x 7	Ramp
B		First transverse roadway
B		Second transverse roadway
B		Operational roadway 1 - Transport tunnel section
B		Operational roadway 2A - Transport tunnel section
B		Operational roadway 2B - Transport tunnel section
C	5,5 x 5,5	Rock roadway
D	5,5 x 5,5	Deposition tunnel
E	4,5 x 5,2	Ventilation tunnel
F	3 x 3	Pedestrian tunnel
F		Utility tunnel
G	4 x 5	Investigation tunnel

Table 1
Summary of systems in each tunnel section

Tunnel section \ System	Repository drainage system	Drinking water	Waste water	Water for fire protection	Ventilation	Power / control	Collector rail	Lighting	Fire alarm	Traffic signals	Telephones	Loudspeakers	TV cameras	Computer network
Ramp	X			X	X	X	X	X	X	X	X	X	X	X
Roadway A	X			X	X	X	X	X	X	X	X	X	X	X
Roadway B	X			X	X	X	X	X	X	X	X	X	X	X
First transverse roadway	X			X	X	X	X	X	X	X	X	X		X
Second transverse roadway	X			X	X	X	X	X			X	X	X	X
Third transverse roadway	X			X	X	X	X	X			X	X		X
Operational roadway 1- Transport section	X			X	X	X	X	X	X	X	X	X	X	X
Operational roadway 2A – Transport section	X			X	X	X	X	X	X	X	X	X	X	X
Operational roadway 2B – Transport section	X			X	X	X	X	X	X	X	X	X	X	X
Operational roadway 1 – Main tunnel section	X			X	X	X	X	X			X	X	X	X
Operational roadway 1A – Main tunnel section	X			X	X	X	X	X			X	X	X	X
Operational roadway 2B – Main tunnel section	X			X	X	X	X	X			X	X	X	X
Deposition tunnel	X				X	X		X	X		X	X	X	X
Rock roadway	X			X	X	X		X	X			X	X	
Ventilation tunnel	X				X			X	X			X		
Investigation tunnel	X				X			X	X			X		
Pedestrian tunnel	X				X			X	X			X		
Utility tunnel	X	X	X		X	X		X	X			X		

Table 2
Summary of transports in each tunnel section

Tunnel section \ Type of transport	Rock	Compacted buffer material	Transport cask	Radiation shielding tube	Backfilling material	Installation material	Building material	Diesel fuel	Explosives	Machines	General service transport
Ramp	X	X	X		X	X	X	X	X	X	X
Roadway A	X	X	X	X	X	X	X	X	X	X	X
Roadway B	X	X	X	X	X	X	X	X	X	X	X
First transverse roadway	X	X	X		X	X	X	X	X	X	X
Second transverse roadway	X				X						X
Third transverse roadway					X	X	X	X	X	X	X
Operational roadway 1- Transport section	X	X		X	X	X	X	X	X	X	X
Operational roadway 2A – Transport section	X	X		X	X	X	X	X	X	X	X
Operational roadway 2B – Transport section	X	X		X	X	X	X	X	X	X	X
Operational roadway 1 – Main tunnel section	X	X		X	X	X	X	X	X	X	X
Operational roadway 1A – Main tunnel section	X	X		X	X	X	X	X	X	X	X
Operational roadway 2B – Main tunnel section	X	X		X	X	X	X	X	X	X	X
Deposition tunnel		X		X	X	X	X			X	X
Rock roadway	X				X	X		X	X	X	X
Ventilation tunnel											
Investigation tunnel											X
Pedestrian tunnel											
Utility tunnel											

16. RAMP - TUNNELS - SHAFTS
16.3 TUNNELS

TYPE A

Dimensions

Cross section:

Width: 10 m

Height: 7.0 m

Cross-sectional area: 70 m²

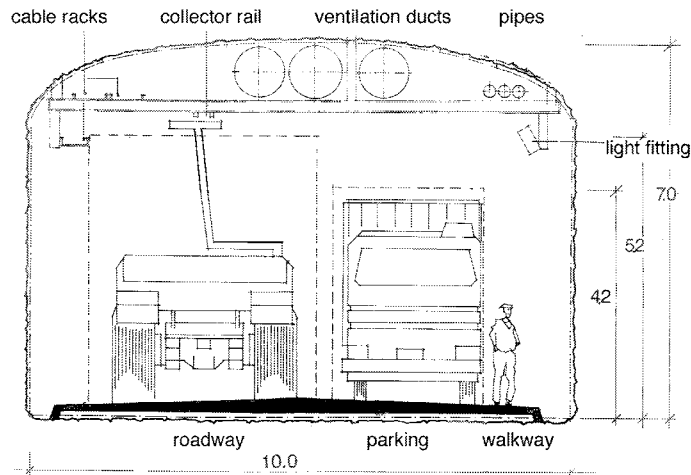

TYPE A

Section - Roadways A and B

Function

The tunnel section forms a continuation of the ramp from where it levels out on the deposition level. Roadways A and B link the vaults in the central area, which create some local traffic.

Roadways A and B make it possible to separate traffic to the deposition or excavation side.

Dimensions

Theoretical length per side: 300 m

Theoretical volume per side: 20,000 m³

Other

Regarding parking spaces and connections to vaults, see section 16.4.

TYPE A

Sections – Operational roadways 1, 2A and 2B – Main tunnel

Function

These sections form part of the common transport tunnel system, from which the deposition tunnels lead.

The size of the cross section is determined by the space required for bringing in and moving the machine for depositing the canisters and by other equipment and vehicles needed to carry out the deposition work. Work will be carried out in several deposition tunnels at the same time. In addition to vehicles, various types of containers with switchgear, tools, rescue chambers etc. will need to be lined up along the walls.

It is thought that the space required for the excavation work will not affect the design, even though this work also requires space for a number of types of machine and vehicle, as well as containers with switchgear, rescue chambers etc.

Installations required for power supply, ventilation, lighting etc. will be extended in pace with the progress of the excavation work.

It is assumed that the deposition work will be served by electrically driven machines and vehicles, which require that a collector rail has been installed.

It is assumed that the excavation side will use electrically driven drilling machines and diesel-driven dumpers.

Dimensions

Theoretical length: 2,500 m

Theoretical volume: 165,000 m³

Others

With regard to the connection to deposition tunnels, see page 18-12.

Chapter 18 contains more detailed information about the interplay between the main tunnel and the deposition tunnels.

TYPE A

Section - Third transverse roadway

Function

The third transverse roadway links the two parts of the deposition area, so that machines for excavation and deposition can be moved without needing to drive the long way around the central area. It also makes it possible to fill containers of backfilling material for onward transportation to the deposition tunnels. The cross section has been chosen to provide room for the reloading equipment, while still allowing large machines to pass.

The traffic will be relatively brisk in the third transverse roadway when the deposition tunnels are being backfilled.

Dimensions

Theoretical length: 100 m

Theoretical volume: 7,000 m³

Other

Regarding the generic design of the reloading area, refer to section 16.4.

16. RAMP - TUNNELS - SHAFTS
16.3 TUNNELS

TYPE B TUNNEL

Dimensions

Cross section
 Width: 7 m
 Height: 7 m
 Cross-sectional area: 30 m²

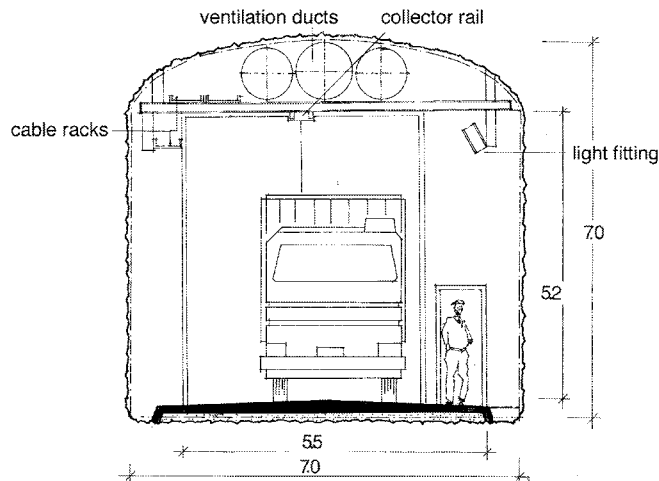

TYPE B TUNNEL

Section - First transverse roadway

Function

The first transverse roadway links the ramp with roadway B. The tunnel allows transport vehicles to be separated, based on the division of operations in the deposition area at the time. From this section, the ramp goes down to the utility tunnel, which links the vaults in the central area together.

Dimensions

Theoretical length: 170 m
 Theoretical volume: 8,000 m³

TYPE B TUNNEL

Section - Second transverse roadway

Function

The second transverse roadway leads to an unloading point for incoming backfilling material, and a loading point for outgoing rock. To make it easier to design the reloading facility to transfer the backfilling material into containers in the third transverse roadway, the unloading point for backfilling material is 5 metres above the main level. The intended gradient of the main level to the loading niches is 1:8.

Dimensions

Theoretical length: 170 m
 Theoretical volume: 8,000 m³

Other

Regarding the design of loading and unloading niches and associated conveyor for backfilling material etc., see section 17.10.

TYPE B TUNNEL

Sections – Operational roadways 1, 2A and 2B – Transport tunnel

Function

These tunnel sections link the central area with the deposition areas.

This type of tunnel can also be used between different deposition areas, if these need to be separated for geological reasons.

The cross section of the tunnel allows two standard trucks to pass one another. In long stretches, passing places are required for the larger units.

The cross section provides only a limited amount of storage space for equipment etc., compared with the cross section of the main tunnel.

Dimensions

Theoretical length: 1,800 m
 Theoretical volume: 80,000 m³

16. RAMP - TUNNELS - SHAFTS
16.3 TUNNELS

TYPE C TUNNEL
 Cross section - Rock roadway

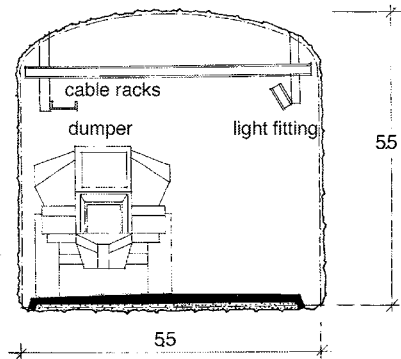

Function

The rock roadway will be used to transport rock from the excavation of new deposition tunnels to the upper level of the rock silo. The rock roadway connects to the A and B sides of the deposition area. The double connection avoids the problem of vehicles having to pass one another, and also meets the requirement for an evacuation route.

The layout of the unloading niche is shown in section 17.10. The only vehicles operating in the rock tunnel will be diesel-driven dumpers.

Dimensions

Cross section:
 Width: 5.5 m
 Height: 5.5 m
 Cross-sectional area: 30 m²
 Theoretical length per side: 300 m
 Theoretical volume per side: 10,000 m³

TYPE D TUNNEL
 Section - Deposition tunnels

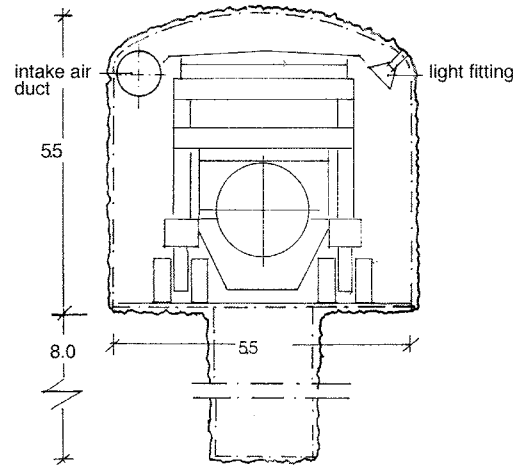

Function

This type is the most important in the whole facility. The size of the tunnel cross section is determined by the size of the deposition machine, which in turn is determined by the size and handling of the canister. In addition to the cross section of the deposition machine, space is required for access for people and installations.

Dimensions

Cross section
 Width: 5.5 m
 Height: 5.5 m
 Cross-sectional area: 30 m²
 Theoretical length: 31,200 m
 Preliminary number of tunnels: 122
 Total theoretical deposition tunnel volume: 970,000 m³

TYPE E TUNNEL
 Section - Ventilation tunnel

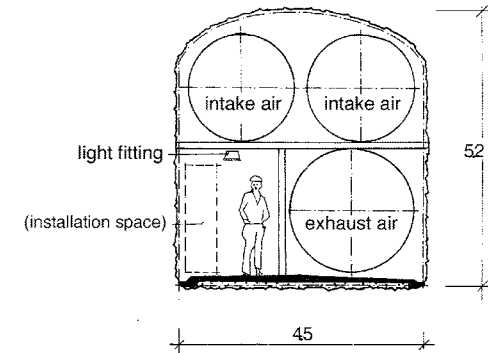

Function

In addition to being a communication route, this tunnel cross section will provide a route for intake and exhaust air ducts between the elevator shaft and the ventilation vault.

Dimensions

Cross section:
 Width: 4.5 m
 Height: 5.2 m
 Cross-sectional area: 23 m²
 Theoretical length: 20 m
 Theoretical volume: 400 m³

16. RAMP - TUNNELS - SHAFTS
16.3 TUNNELS

TYPE F TUNNEL

Section – Pedestrian tunnel

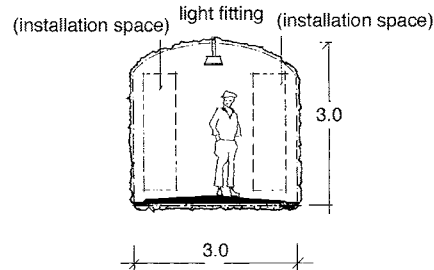

Function

The purpose of the pedestrian tunnel is to provide a separated passageway on the main level, between the vaults in the central area. In addition to the function as a pedestrian route for the staff, the pedestrian tunnel can be used as a cable route.

Dimensions

Cross section
 Width: 3 m
 Height: 3 m
 Cross-sectional area: 9 m²
 Theoretical length: 90 m
 Theoretical volume: 800 m³

Type F tunnel

Section – Utility tunnel under the central area

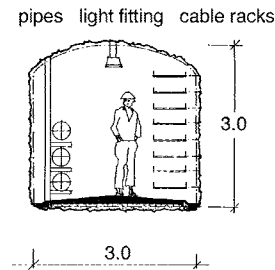

Function

The function of the tunnel is to make it possible to link the vaults in the central area in a co-ordinated way and provide a simple way to install utility systems to each vault. Installing these systems below the main level removes all of the problems associated with co-ordinating installations in roadways A and B.

The tunnel starts from the first transverse roadway on the main level and continues to the repository drainage vault pump room on the bottom level.

The utility tunnel will be excavated with a gradient of 1:100 down to the repository drainage vault, to facilitate drainage. The utility tunnel will be used solely for installing cables and pipes. It is not intended as a communication route.

Dimensions

Cross section
 Width: 3 m
 Height: 3 m
 Cross-sectional area: 9 m²
 Theoretical length: 300 m
 Theoretical volume: 8,700 m³

TYPE G TUNNEL

Section – Investigation tunnel

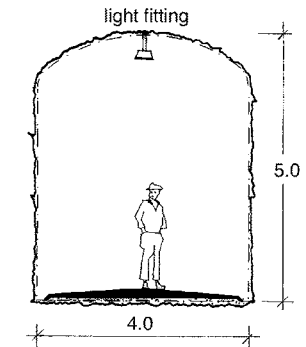

Function

It is assumed that when the excavation work is being carried out before the start of regular operation, an investigation tunnel will be excavated through the planned deposition area. The tunnel makes it possible to study the quality of the rock closely, including the location of future deposition tunnels. It will also be possible to lead out the exhaust air from the work area to the exhaust airshaft at the far end of the deposition area. Completing the entire tunnel loop will also provide an evacuation route in the event of fire

The intention is that the investigation tunnel will be enlarged to the size of the main tunnel, as new deposition tunnels are excavated.

The cross section of the investigation tunnel will be chosen such that it will be possible to use the same equipment as in others tunnels.

16. RAMP - TUNNELS - SHAFTS
16.4 SPECIAL SOLUTIONS

Passing places in the ramp

General

For economical reasons, the cross-sectional area of the ramp has been chosen so that heavy transport vehicles cannot pass one another everywhere along its length.

In order to make it possible to use sufficiently large vehicles, a number of passing places have been created. A preliminary examination of the transport logistics shows that one passing place per kilometre of ramp would provide sufficient flexibility.

Layout

The passing places consist of a local enlargement of the ramp, which allows two large trucks of the Kiruna type to pass one another. The enlargement will be made on the downward side, to allow vehicles travelling up the ramp to drive past the passing place without turning in to the side or stopping. The length of the passing places has been chosen to accommodate two vehicles in the waiting position, one behind the other. The passing place will be horizontal, to prevent waiting vehicles rolling out of control.

In the upper part of the passing place, there is a transformer for supplying power to the collector rail for the electrically driven trucks. There is a sump in the upper part of the passing place to deal with repository drainage water.

Dimensions:

Width: 12 m
 Height: 7 m
 Length: 38 m

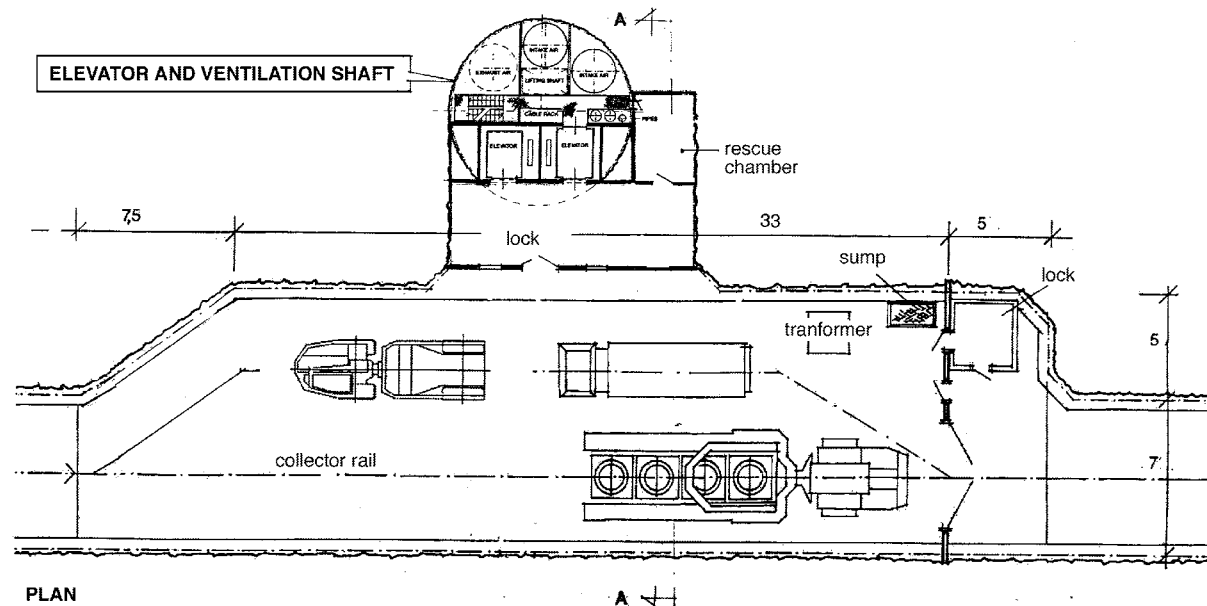
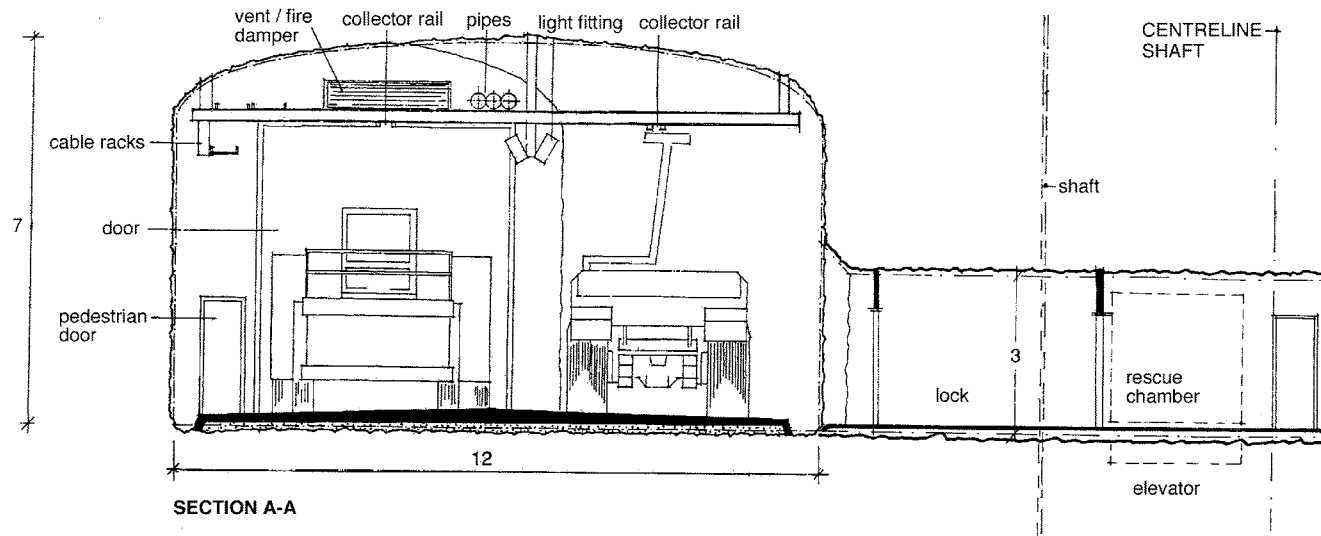

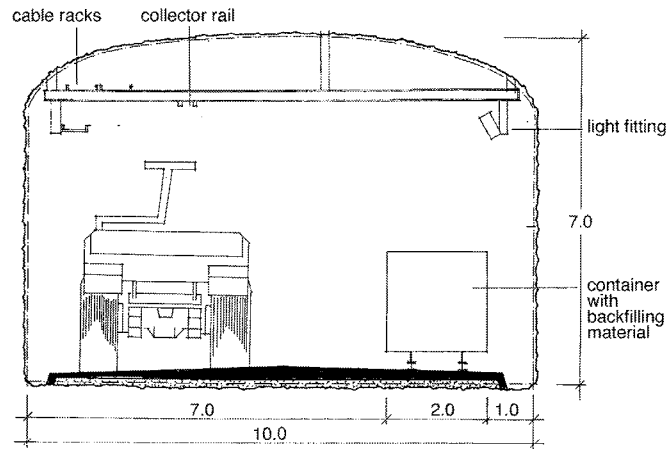

SECTION A-A

Reloading point for backfilling material

General

In this phase, it has been decided to prepare the backfilling material in the production building on the surface. The trucks that take the rock up to the surface can then return with backfilling material.

This means that a reloading facility is required, so that the material can be transported along the last stretch to the backfilling machine. As the bentonite/rock mixture is classed as a perishable commodity, the transport must be carried out at the same time as the backfilling.

In order to do this, the backfilling material must be put into specially designed containers, suitable for both transport to and loading into the backfilling machine.

With regard to transporting the backfilling material to the reloading point and into containers in the third transverse roadway, see section 17.20.

Layout

As the figure shows, a row of containers is lined up along the wall of the tunnel on the central area side. The idea is that filled containers will be gathered at one end of the parking area while empty containers will be placed at the other end. The filling point is at the centre of the roadway, where the conveyor belt from the loading hopper ends. As the filled containers are driven away, empty ones are returned and filled. Each container will hold approximately 5 m³ of backfilling material.

The layout of the roadway means that ten filled and ten empty containers can stand on the roadway at the same time. The filling is controlled by intermittently running the conveyor belt from the loading hopper. The loading point will have to be shielded in some way, to prevent the material getting onto the roadway.

The figure shows the loading/unloading procedure.

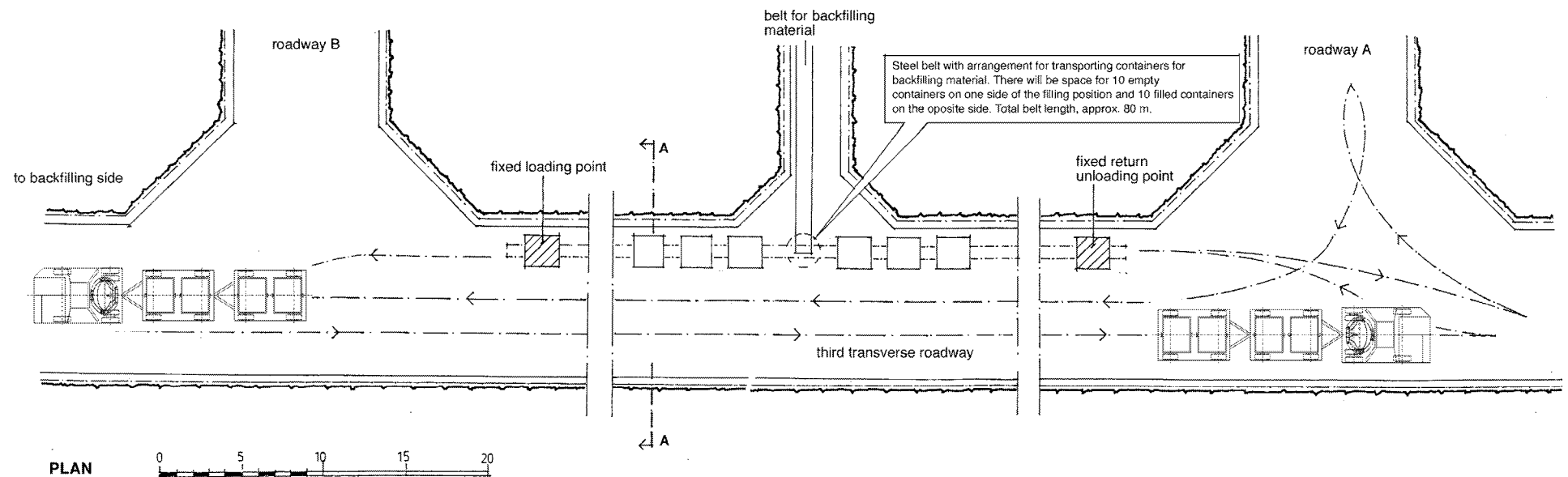

PLAN

16. RAMP-TUNNELS-SHAFTS
16.4 SPECIAL SOLUTIONS

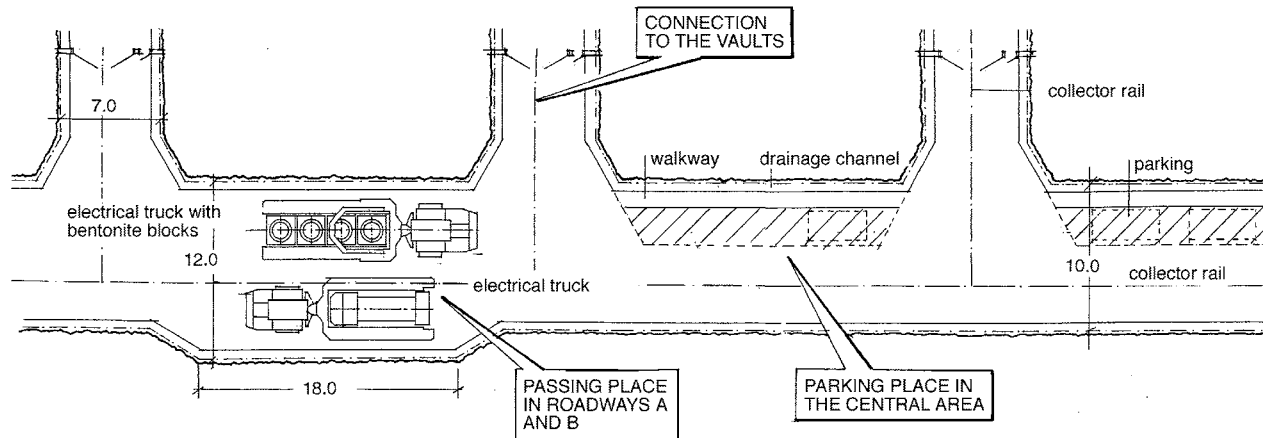

Passing place in roadways A and B

General

For economical reasons, the cross section of the roadway has been chosen such that heavy vehicles will not be able to pass one another along the entire stretch.

In order to still provide sufficiently large transport capacity, one passing place each has been arranged for roadways A and B.

Layout

The passing place consists of a local enlargement of the roadway, which enables two, large Kiruna type trucks to pass one another. The enlargement will be put on the side opposite the entrances to the vaults.

Dimensions:

Width: 12 m
Height: 7 m
Length: 18 m

Parking area in the central area

The time taken for most of the journeys in both the ramp and the transport tunnels on the deposition level makes them fairly long and monotonous. It is therefore probable that drivers will want to stop next to the elevator vault for a short break. To facilitate this, a parking area will be provided in roadways A and B. As a result, temporary parking won't prevent other traffic passing.

The above figure shows what the parking place looks like.

The connection to the vaults in the central area

The figure above shows an example of a connection to a vault in the central area. The length of the connecting tunnel can vary, depending on the length of the particular vault.

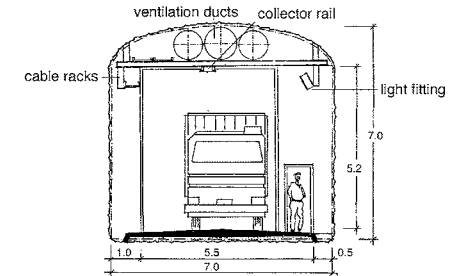

CONNECTIONS TO THE VAULTS

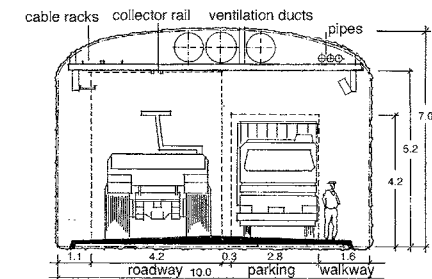

PARKING IN THE CENTRAL AREA

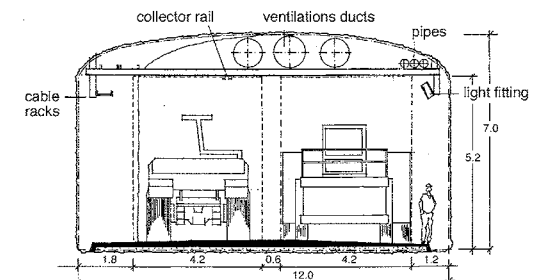

PASSING PLACE IN ROADWAYS A AND B

ELEVATOR AND VENTILATION SHAFT

General

The shaft links the operational area with the central area of the underground facility. The shaft will be used as a communication route and as a route for ventilation ducts, pipes and cables.

At the start of the project, the shaft will also make it possible to carry out geological investigations. One possibility would be to carry out horizontal drilling at the desired number of levels across the planned deposition area, while the shaft is being sunk. This will provide information that, in combination with the results of drilling probe holes from the surface, will provide additional information about the quality of the particular rockmass.

The shaft will be large enough for two elevators, intake and exhaust air ducts, a repository drainage pipe, a freshwater pipe and racks for power, control and telecommunication/IT cables.

Layout

The shaft will have two elevators installed in it. The reason for the doubling up is because there must always be an elevator available to meet the requirement for uninterrupted operation in the underground facility. To allow access to the shaft for inspection and any changes to installed systems, it will be possible to stop one of the lifts every 25 metres, at landings.

For fire safety reasons, the shaft will be sectioned off with concrete barriers, from the -500 metre level up to and including level 3 in the elevator and ventilation building on the surface.

The shaft will be sunk in stages, using conventional drilling, blasting and mucking, using temporary hoists up to ground level. The walls of the shaft will be scaled and sprayed with fibre-reinforced concrete, to stabilise the surface and reduce the need for repeated scaling. As the shaft is gradually being sunk, preparations will be made for the subsequent slipform casting, and brackets will be set into the rock sides to support the ventilation ducts.

The shaft has a number of mezzanine levels, constructed of metal grating, adjacent to the lift landings. Cable racks and pipes are installed on the slipform-cast concrete walls. Ladders link the lift landings.

One of the elevators has doors on two opposite sides of the elevator cage. This makes it possible to alight straight onto the lift landing. The opening to the ventilation duct section is fitted with a fire door.

Dimensions

Diameter of shaft: 8.5 m
 Depth of shaft: 510 m
 Volume of shaft: 29,000 m³

Other

Elevator specification for two elevators

Use: Transporting staff and light goods.

Elevator type: Friction winder. Rope guided.

Data: Number of passengers: 20
 Max. load: 2.0 tons
 Lifting height: 520 m
 Lifting speed: 5 m/sec
 Cage size 2 x 3 m: 6 m²

Elevator cage: Industrial standard
 Elevator no. 1: Opening on one side
 Elevator no. 2: Opening on two opposite sides

Landings: Elevator no. 1: 7
 Elevator no. 2: 22

Environment: Shaft, corrosive environment
 Regular use, substantial wear

EXHAUST AIR SHAFT

General

The ventilation system for the underground area is designed so that intake air is drawn down to the deposition level via the elevator and ventilation shaft in operational area, for further distribution out into the deposition areas. The exhaust air is extracted via the ramp to operational area, the elevator and the ventilation shaft to operational area and a shaft at the far end of deposition area 2.

Layout

The exhaust air shaft, which has a diameter of approximately 3 metres, is created using full face boring. Excavated rock is removed from underneath. The drilling process produces smooth walls, which require no additional treatment.

System installations have not been planned in the exhaust air shaft, although a simple service hoist is planned, to enable regular inspection of the rock.

The superstructure of the exhaust air shaft and its fans are described in chapter 13.

Dimensions

Diameter of shaft: 3.0 m
 Depth of shaft: approx. 500 m

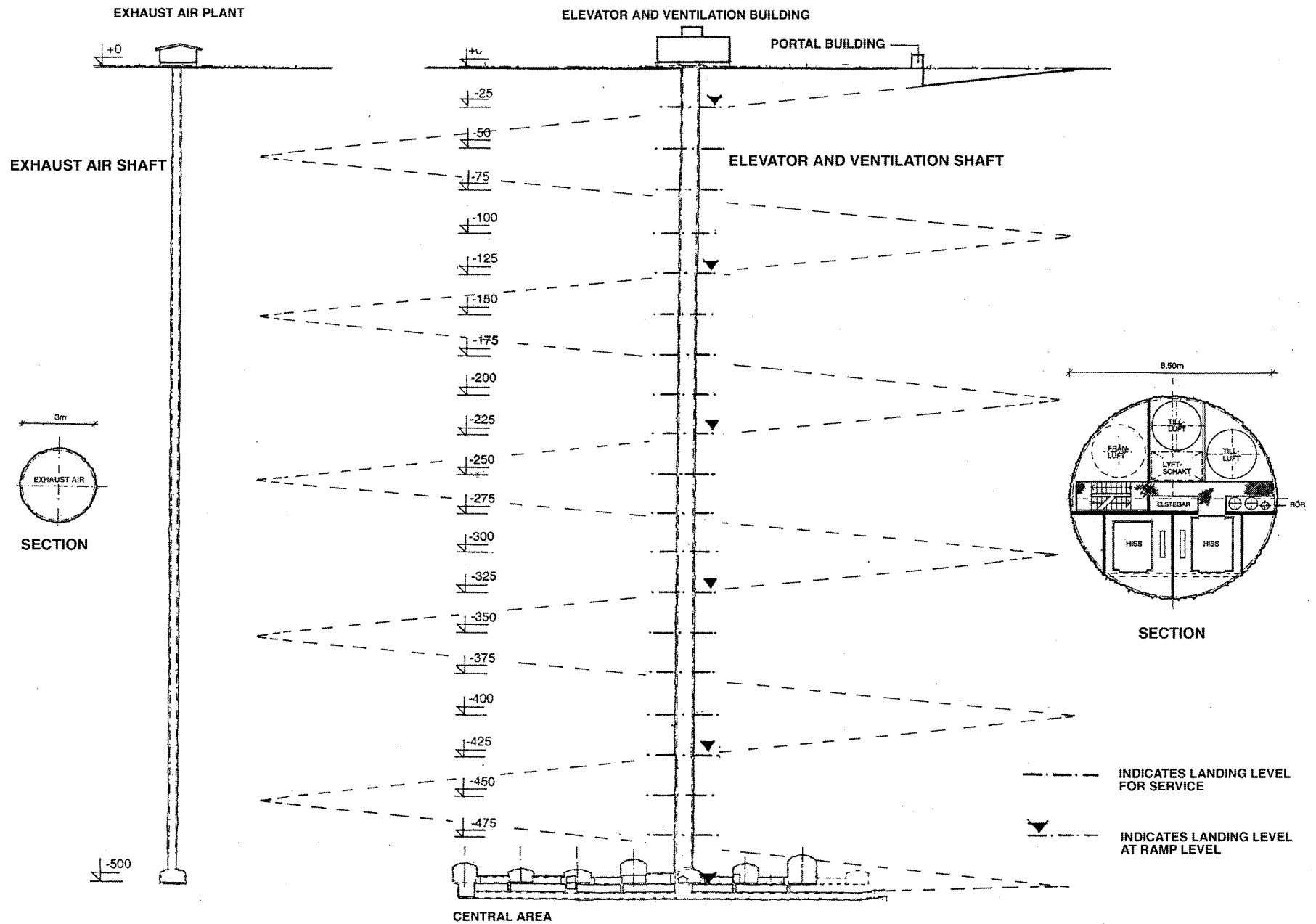

16. RAMP - TUNNELS - SHAFTS
 16.6 CO-ORDINATION BETWEEN RAMP AND SHAFT

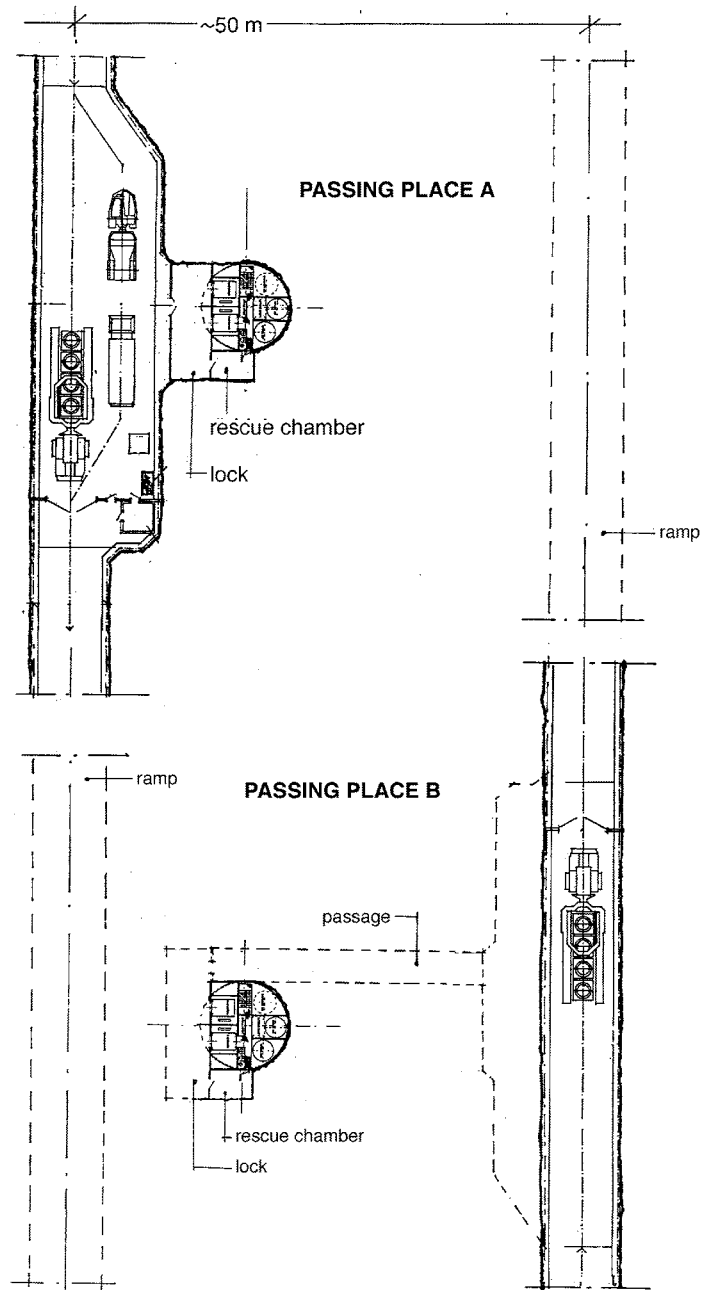
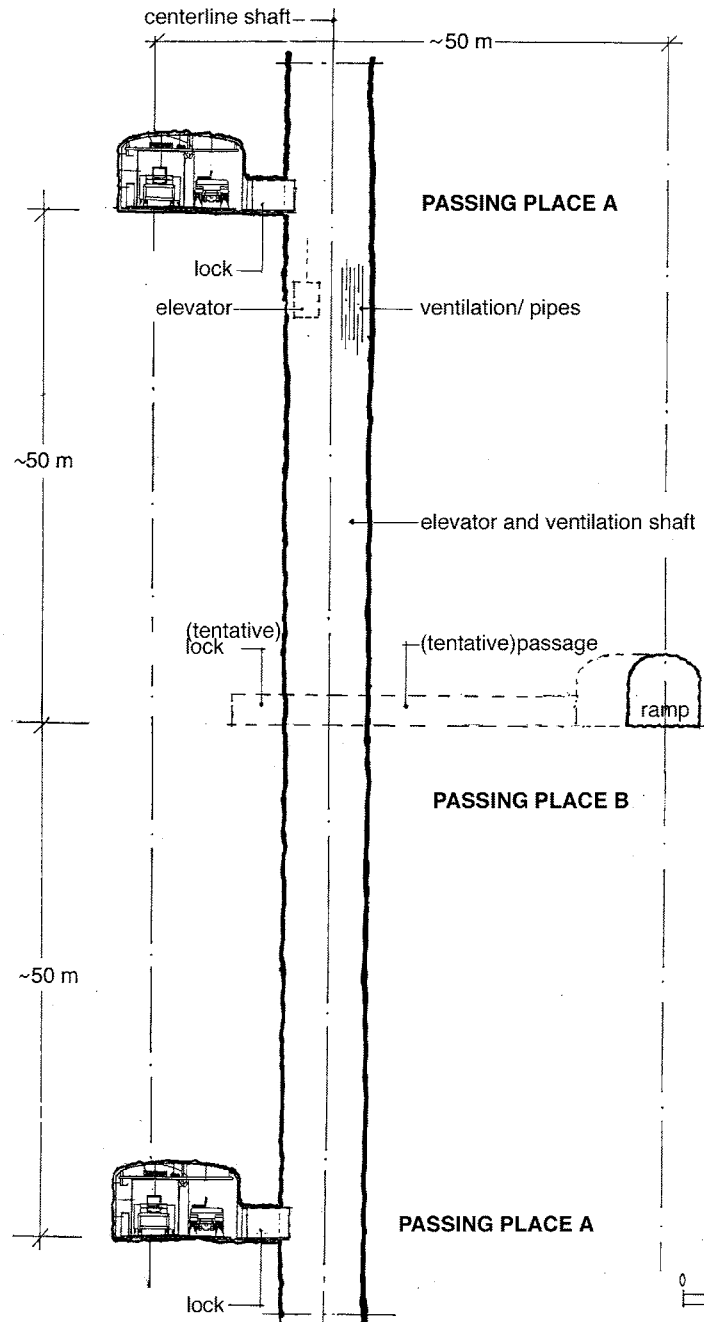

- 17.1 General
- 17.2 Site arrangement
- 17.3 Reloading station
- 17.4 Storage and workshop vault
- 17.5 Elevator vault
- 17.6 Ventilation vault
- 17.7 Electrical power vault
- 17.8 Vehicle vault
- 17.9 Repository drainage vault
- 17.10 Rock silo

17. CENTRAL AREA
17.1 GENERAL

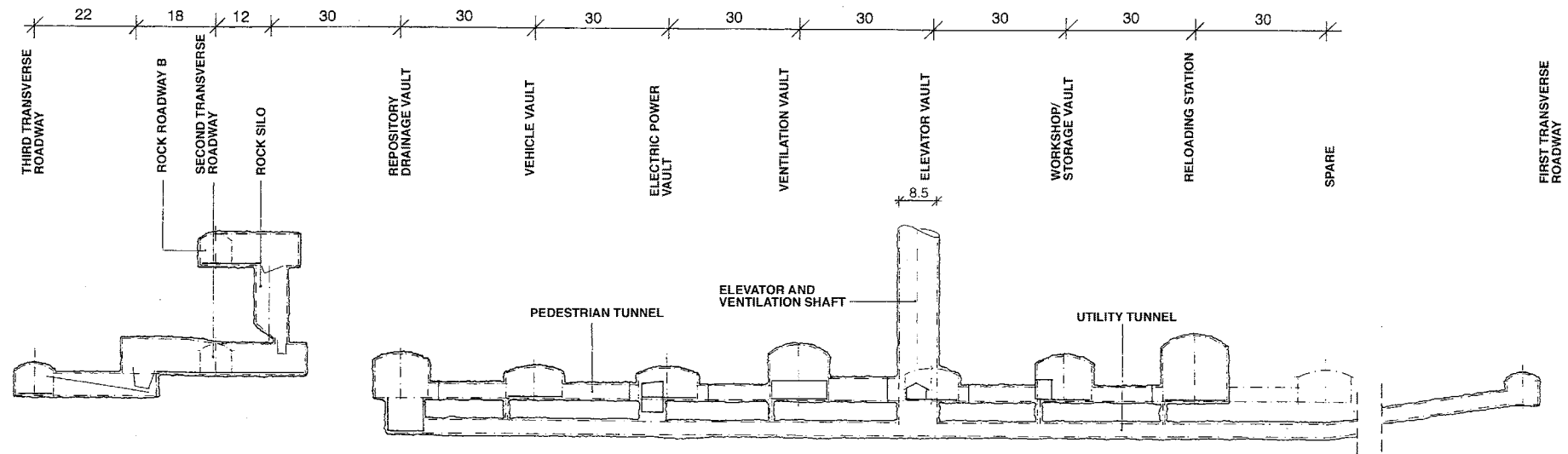

General

The central area consists of the following parts:

ROCK VAULTS

- Reloading station
- Storage and workshop vault
- Elevator vault
- Ventilation vault
- Electrical power vault
- Vehicle vault
- Repository drainage vault
- Rock silo
- Reloading point for backfilling material

TUNNELS

- Transport tunnels
- Pedestrian and utility tunnels

Layout

The overall dimensions of the central area are approximately the following: length = 300 metres, width = 110 metres, which is equivalent to an area of 33,000 m².

For rock engineering reasons, the functions of the central area have been divided up into seven vaults, each designed for its intended function. The vaults are situated on transverse links between two parallel transport tunnels. The vaults are also linked by a central pedestrian tunnel, on the main level, and a tunnel below running in the same direction, intended for installing pipes and cables.

The locations of the vaults relative to one another are determined on the basis of functional factors, primarily the transport of staff and goods of various types.

Access to the central area is via the ramp and by elevators to the central elevator vault. The grouping of the vaults between the two parallel transport tunnels makes orientation easy and provides good communication.

The cross section of the vaults varies from 12 to 16 metres in width and 8 to 15 metres in height, depending on the planned function. The length of the vaults varies between 47 and 66 metres.

The connections to roadways A and B have been made the same size as the transport tunnels in general, to facilitate transport and the installation of ventilation ducts, pipes and cable racks.

The distance between the vaults has been chosen as c/c 30 metres.

The solution is flexible, as the dimensions can be altered when the final conditions can be determined, without needing to abandon the basic principle. Space has been reserved for additional vaults for any future requirements.

The basic layout of the central area is shown in section on this page and in plan view on the next page.

17. CENTRAL AREA
17.3 RELOADING STATION

General - functions

Transport casks containing canisters with spent nuclear fuel will be transported between the terminal building in the operational area and the central area of the underground facility using a special electrically driven vehicle. The canisters will have to be reloaded for further transport to the deposition tunnel.

The reason for the reloading is that the transport cask that is required for transport between the encapsulation plant and the deep repository, and down to the deposition level of the deep repository, must meet the IAEA's recommendations for transporting spent nuclear fuel. During reloading on the deposition level, the canister is transferred to a radiation shielding tube, which provides sufficient radiation protection and is adapted to the shape of the deposition machine.

The purpose of the reloading station is to provide room for the equipment needed to perform this reloading safely and shielded from radiation.

Operations

This vault is intended solely for reloading canisters containing spent nuclear fuel. The reloading is controlled manually from a small control room. The equipment has been designed so that staff are protected from radiation.

An average of one reloading per workday is planned. The system will include a number of radiation shielding tubes, to increase flexibility.

The transport vehicle carrying the radiation shielding tube and canister will probably be parked in the reloading station when it is not in use.

Layout

The reloading station consists of an elongated vault with a reloading point in the centre. The vault has a travelling crane that covers the entire length of the vault.

Between the reloading rig and the parking areas, there are places to park transport casks, radiation shielding tubes and lifting yoke.

The trestles will be designed so that both the transport cask and the radiation shielding tube can be put on them. This will make it possible to transport canisters containing spent nuclear fuel in both directions, depending on which part of the repository that deposition is taking place in at the particular time. This will enable transport out to the deposition area to be done by the shortest route, with as few changes of direction as possible and passing as few vehicles as possible.

The sides of the vault provide temporary storage for shock absorbers for the transport casks. The walls of the reloading station are not clad. A suspended ceiling covers the entire roof area, to catch drips. The floor of the vault is concrete, and drains to the utility tunnel. A drainage ditch runs along the walls of the vault, and falls to the transport tunnels at the ends.

Access to the reloading station is from the ends. The opening can be closed off by a door, with a separate pedestrian door. The reloading station is also connected to the other vaults in the central area by a central pedestrian tunnel on the main level and a utility tunnel below. Pipes and cables come from the utility tunnel. The ventilation ducts are connected from the transport tunnels at both ends of the vault.

A free-standing control room has been located in the centre of the vault, where the reloading procedure can be monitored. The track for the travelling crane is supported by a row of columns along the walls of the vault. There is a ladder at one of the travelling crane end positions, for access to the travelling crane for servicing.

Special equipment

Travelling crane for lifting transport casks and radiation shielding tubes, with and without a canister.

Max. load:	80 tons
Span:	13 m
Max. lifting height:	8 m
Length of crane track:	42 m

- Special demands on design due to the requirement for safe handling.
- Radio-controlled
- Lifting device suitable for the particular load.

Reloading rig for transferring the canister from the transport cask to the radiation shielding tube. The rig has radiation shielding and is remotely controlled from a nearby control position.

Dimensions

- Length = 50 m
- Width = 15 m
- Height = 15.5 m
- Volume of vault = 11,000 m³
- Floor area of vault = 700 m²

17. CENTRAL AREA
17.3 RELOADING STATION

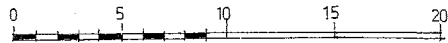
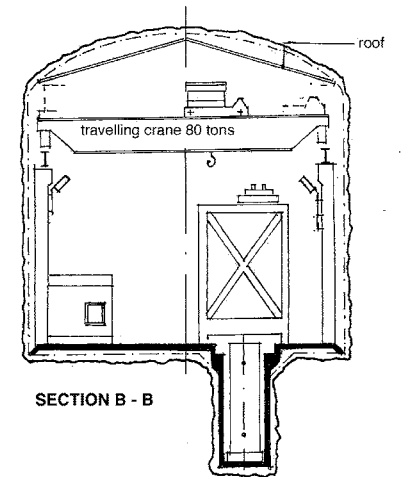
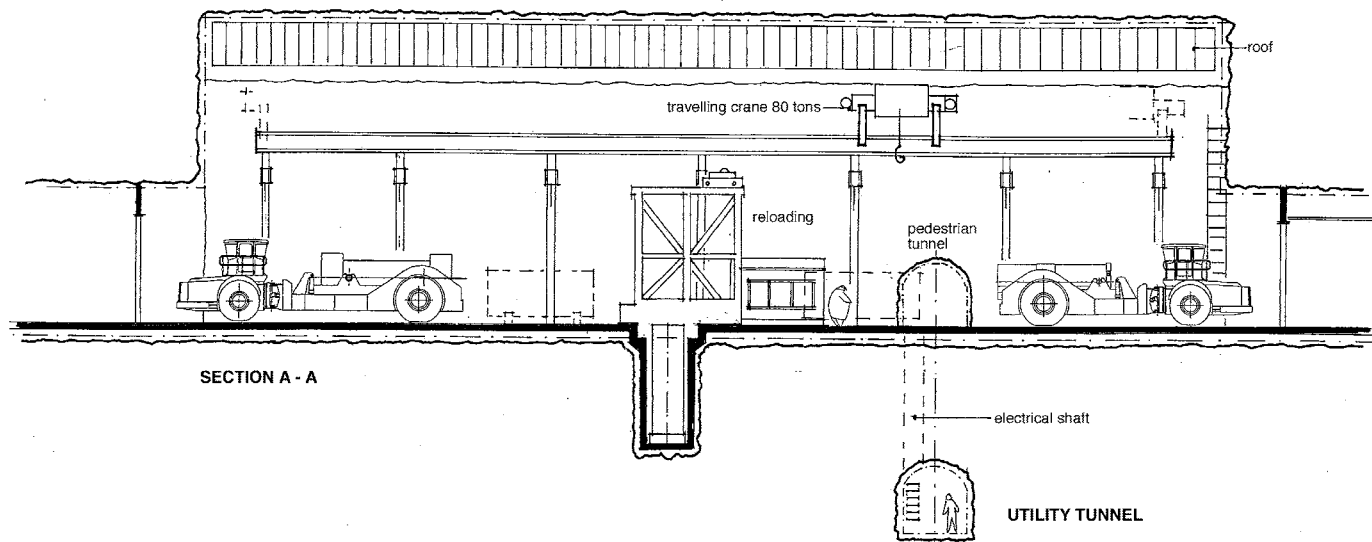
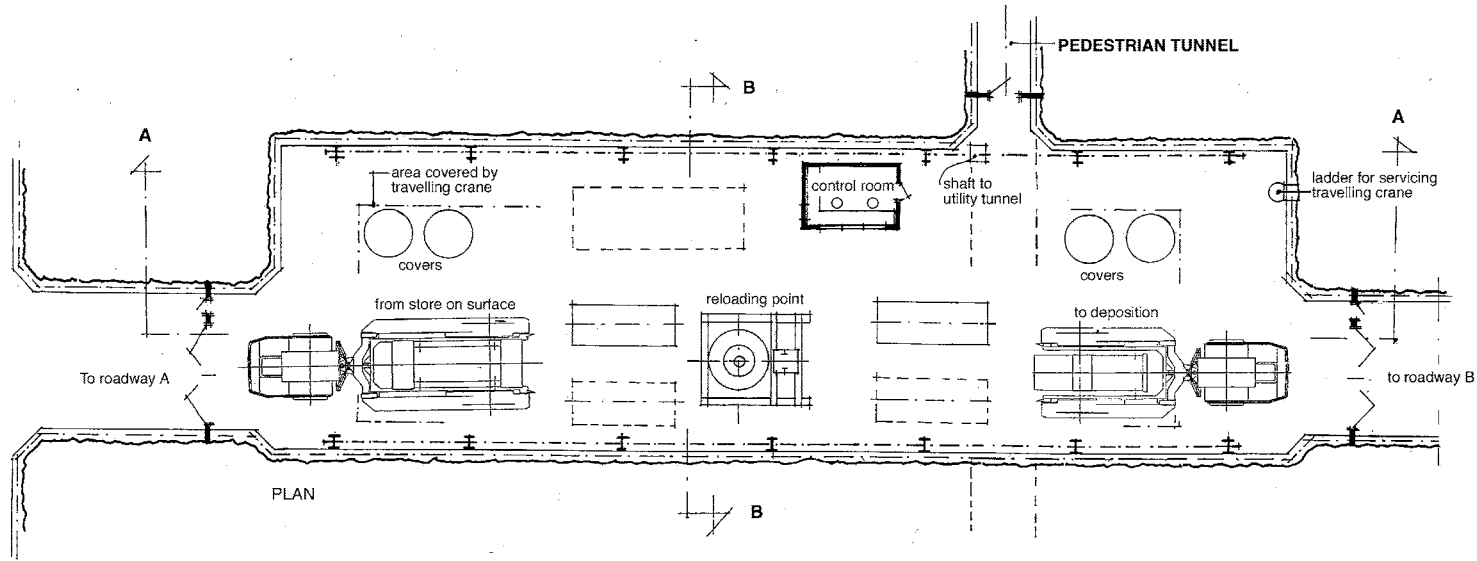

General

As its name implies, is obvious from the name this vault is intended to meet the requirement for a local workshop area and storage area. Creating a special vault for these requirements makes it possible to keep the transport tunnel system free of dispersed storage areas, as far as possible.

This reduces the risk of fire and facilitates access into the facility. It also provides the conditions for a reasonable working environment for staff involved.

Workshop section

Machines, vehicles, other equipment and installations in the underground area need to be inspected, serviced and repaired. Bearing in mind the distance to the workshop on the surface, a workshop is required in the central part of the underground area. The workshop can also be used as a base for work out in the various parts of the facility.

Operations

It is thought that the work in the workshop will consist mainly of basic repair and servicing of various types of vehicles and machines.

Work that requires special equipment, in the form of machine tools and the like, manufacturing new replacement parts etc. will be done in the workshop on the surface. The workshop will also be used as a base for maintaining and repairing the following systems and building elements:

- Ventilation system
- Repository drainage system
- Lifting devices
- Doors and operating units
- Collector rails

The work also involves dismantling and reassembling parts of the service systems as the deposition progresses.

Storage section

As mentioned previously, both excavation/construction work and deposition work will go on simultaneously in the facility. Both operations require access to various types of machines and vehicles, and to various types of building materials. Bearing in mind the distance up to the stores on the surface, a local store is required in the vault. The storeroom is intended to satisfy this requirement. The planned operations in the storeroom are limited to bringing in and taking out equipment and building materials. It is assumed that handling will be done using a forklift truck and travelling crane.

The following materials and equipment are planned to be stored temporarily in the storage section:

- Building materials
 - Timber for formwork
 - Reinforcement bars
 - Rock bolts
 - Cement
 - Sand
 - Steel sections
- Installation material
 - Cables
 - Cable racks
 - Pipes and fittings
 - Hoses
 - Lighting fittings
 - Lamps
- Other
 - Lubricating oils
 - Protective materials
 - Protective equipment
 - Scaffolding
 - Work tools
 - Mobile drainage pumps
 - Mobile welding sets
 - Mobile electrical distribution units

Operations

This vault will be a base for various categories of service staff. It will probably be permanently manned.

17. CENTRAL AREA 17.4 STORAGE AND WORKSHOP VAULT

Layout

The storage and workshop vault is connected at both ends to the two parallel transport roadways, from which vehicles enter. The size of the tunnel connections is based on the truck that requires the most space.

Staff communication with the reloading station and the elevator vault is via the transverse pedestrian tunnel. This maintains a close connection with the people that travel to and from the various parts of the repository. The location also makes possible speedy communication with the operational area on the surface.

The joint storage and workshop vault consists of an open space with bare walls and a suspended roof, as a protection against any water dripping down. The floor of the vault is concrete and is drained via the utility tunnel below. The vault has a travelling crane, which covers the whole floor area. Columns along the sides of the vault support the track for the travelling crane.

Most of the **workshop section** consists of an open floor area, which provides room to park machines and vehicles requiring servicing or repair. There are shelves, pallet racks and workbenches along the walls. There should be segregated areas for equipment used to clean oily machine parts, for storing lubricating oils and hydraulic oil and for welding individual parts.

The **storage section** is fitted out as required. Part of the floor area is reserved for the temporary storage of building and installation materials en route to be installed in the facility. It is envisaged that materials will be handled using a forklift truck. In the centre of the vault, there is a free-standing office module containing two offices.

Dimensions

- Length = 66 m
- Width = 12 m
- Height = 10 m
- Volume of vault = 7,900 m³
- Floor area of vault = 790 m²

17. CENTRAL AREA
17.4 STORAGE AND WORKSHOP VAULT

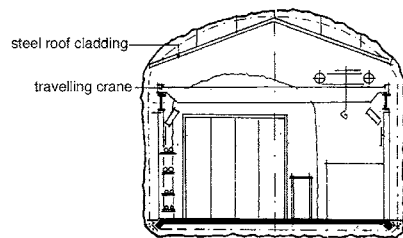
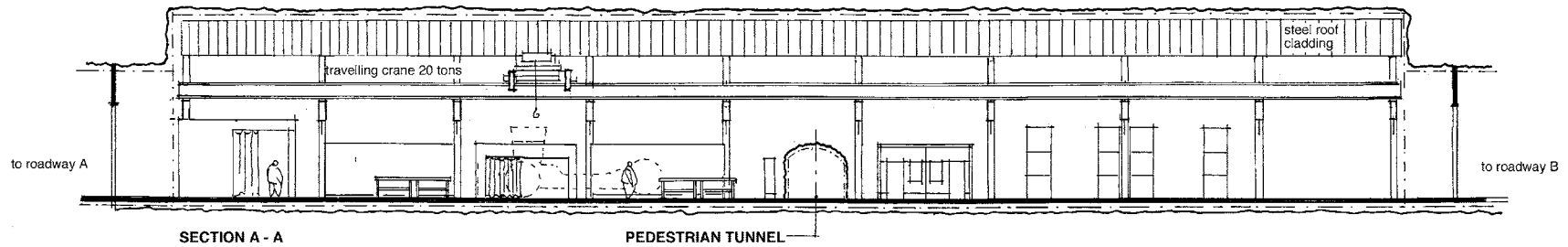
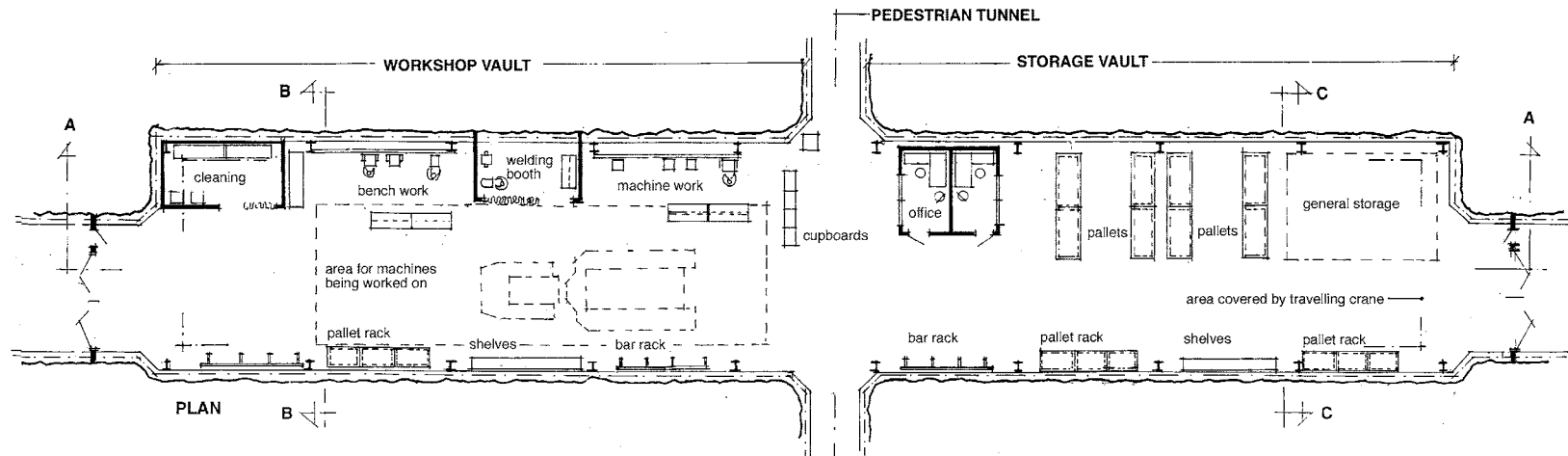

SECTION B - B

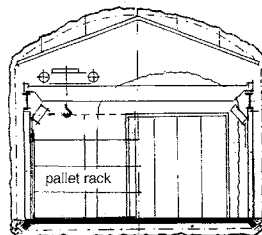

SECTION C - C



SPECIAL EQUIPMENT

Common travelling crane

Max load: 20 tons
Span: 13 m
Max. lifting height: 8 m
Length of crane track: 42 m
Lifting hook
Radio-controlled

Workshop section

Electric welding set
Gas welding set
Pillar drill
Grinder

Storage section

Pallet racks
Shelves

17. CENTRAL AREA
17.5 ELEVATOR VAULT

General - functions

The elevator vault is intended to be the “human contact point” on the deposition level. By co-ordinating the elevator from the operational area with this vault, all staff that are working on the deposition level will pass through this vault.

The elevator vault is in the middle of the central area. Other vaults in the area can be reached via the transverse pedestrian tunnel.

In addition to acting as a communication route to and from the various parts of the facility, the area is intended to be used as an information and exhibition hall for tourists and other categories of visitors. Here, a group of visitors would assemble at the back of the vault, where there will be a suitable display. The facility can also be presented and described using a large screen, onto which guides can project site plans, diagrams, tables and live pictures from work going on in various parts of the facility. Small groups could be driven out to look at excavated deposition tunnels etc.

Groups of around 20 people should be able to be accommodated on study visits. An emergency vehicle equipped for fire fighting in the elevator vault should also be parked here, to allow the emergency services access to the deposition level using the elevators, so they can quickly drive out to the particular area.

There are parking places for bicycles in the vault. For reasons of fire safety, vehicles may not be parked in the vault.

There are toilets for facility staff and visitors in the elevator vault. A small group workroom with a small kitchenette for occasional work-related requirements on the deposition level is also planned.

The entrance to the elevators is designed as a rescue chamber for around 60 people, adjacent to the elevators.

Operations

No tasks should be normally carried out on a regular basis in the elevator vault, although staff will usually be present in the adjacent workshop and storage vault.

Guides will be in the vault occasionally, during study visits.

Layout

The elevator vault consists of a bare, elongated rock cavern, with a roadway running along one side. There is an elevator shaft in the centre of the other side. On one side there is a lobby for the elevators, which also acts as a rescue chamber. For reasons of safety, the rescue chamber is in the same fire compartment as the elevator shaft, so that it will be acceptable as an evacuation route.

On the opposite side of the elevator shaft there is a building containing toilets and a garage for the emergency vehicle, as well as protective equipment on the lower level and a small office area on the upper level. If necessary, this can be either removed or enlarged. In order to be able to meet the temporary requirements for workplaces on the deposition level, e.g. for visiting researchers, there is space to set up moveable office modules.

The width of the roadway is sufficient to allow a small tourist bus to travel along it.

There are arrangements for washing boots outside the doors to the vault, to help maintain cleanliness.

The vault has a concrete floor, which drains to the utility tunnel below.

Suspended roofs and shotcrete should be used only when necessary, so the visitors can see the structure of the rock. It is thought that this will be an interesting feature in the experience of visiting the deposition level.

Special equipment

Audio-visual equipment for providing visitors with information.

Dimensions

- Length = 66 m
- Width = 12 m
- Height = 7 m
- Volume of vault = 5,200 m³
- Floor area of vault = 800 m²

17. CENTRAL AREA
17.5 ELEVATOR VAULT

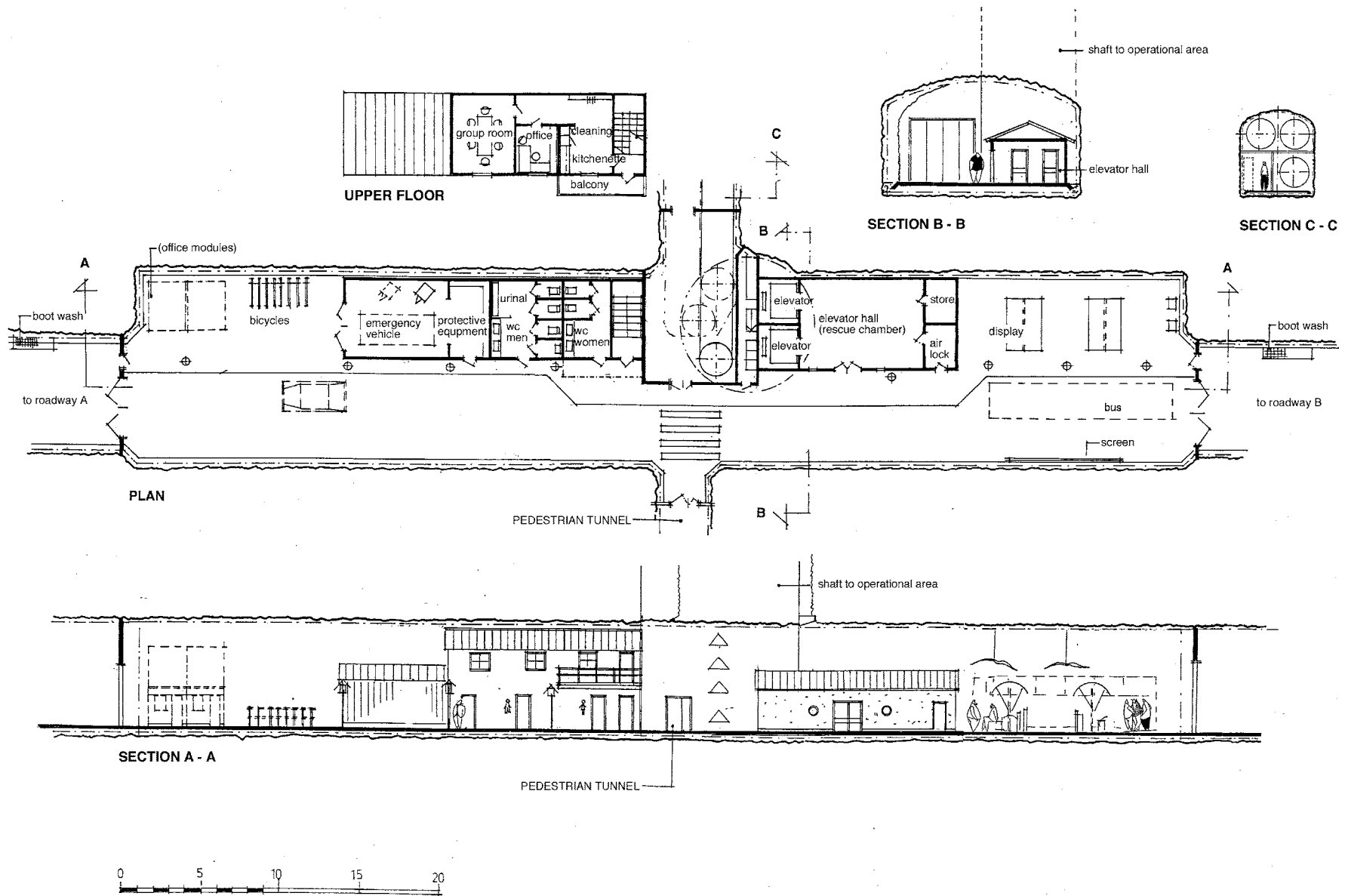

General - function

The generic design of the ventilation plant for the underground area is shown in section 15.10.

The ventilation building in the central area accommodates distribution fans for the entire underground area. The intake air is conveyed to a pressure chamber via intake air fans on the surface. The pressure in the pressure chamber is controlled so that it is kept at atmospheric pressure.

A number of distribution fans with dampers, postheaters (applies to certain rooms, e.g. staff rooms and workshops) and noise suppressers supply various fire compartments in the facility with the correct volume of air, depending on the prevailing operating conditions. A proportion of the exhaust air goes to a suction chamber, which is served by exhaust air fans on the surface, which maintain the pressure at atmospheric pressure.

Operations

Staff will be in the fan rooms only when making rounds and carrying out maintenance work on fans etc.

Layout

The ventilation vault is divided into two fan rooms, situated on either side of the pedestrian tunnel. One of the fan rooms contains intake air fans and the other exhaust air fans. The intake air is taken from the surface, via ducts in the elevator and ventilation shaft. The exhaust air, mainly from the central area, is led via a duct in the same shaft to the surface.

The fans are on steel frames on an upper level, with straight connections to suction and pressure chambers. The location allows straight ducts to be used out into the transport tunnels and facilitates servicing work on the fans.

Cubicles for control and monitoring have been placed in the main level of the vault. There are entrances at both ends of the vault, for installation work, changing parts and servicing. There is a pedestrian route and a transport route for light and less bulky material and equipment in the central area.

The floor of the vault is concrete, with drainage ditches along the walls. The steel frame for mounting the fans is supported by columns from the floor. A sheet-steel roof is fitted over the fans, to protect them from any water that leaks in.

Air chambers are made of concrete.

It is thought that no other enclosures will be required.

Equipment

There are lifting beams above the fans to facilitate maintenance.

Approximate dimensions

- Length: 66 m
- Width: 13 m
- Height: 13 m
- Floor area 850 m²
- Volume: 10,000 m³

17. CENTRAL AREA
17.6 VENTILATION VAULT

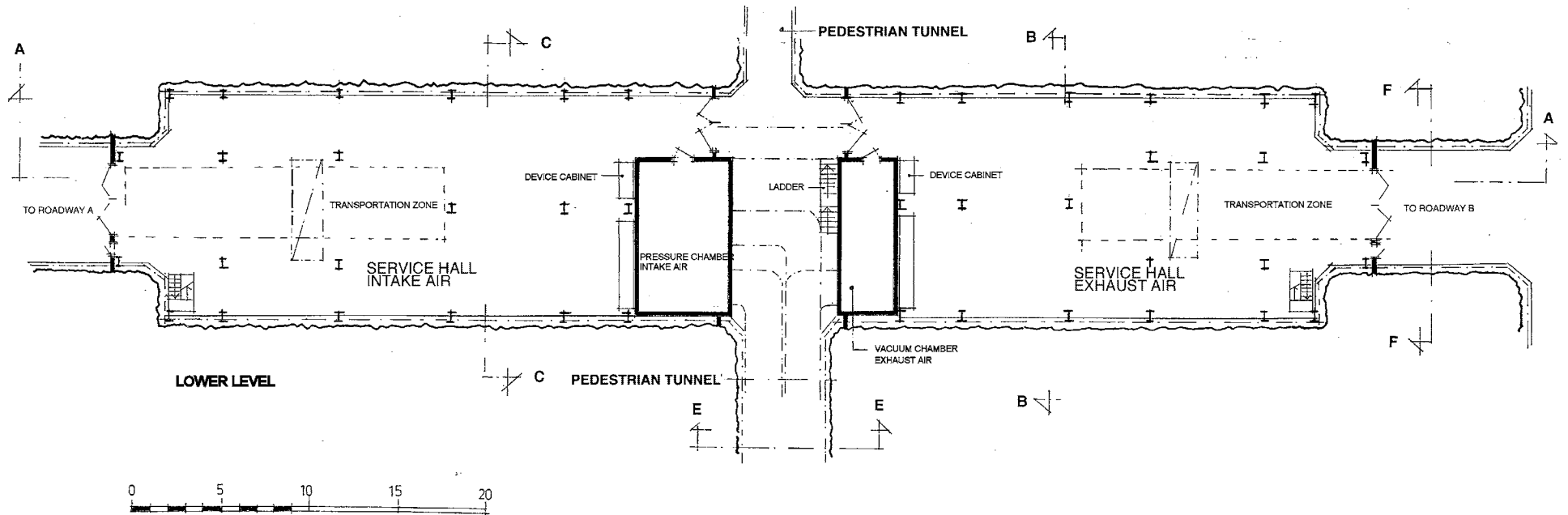
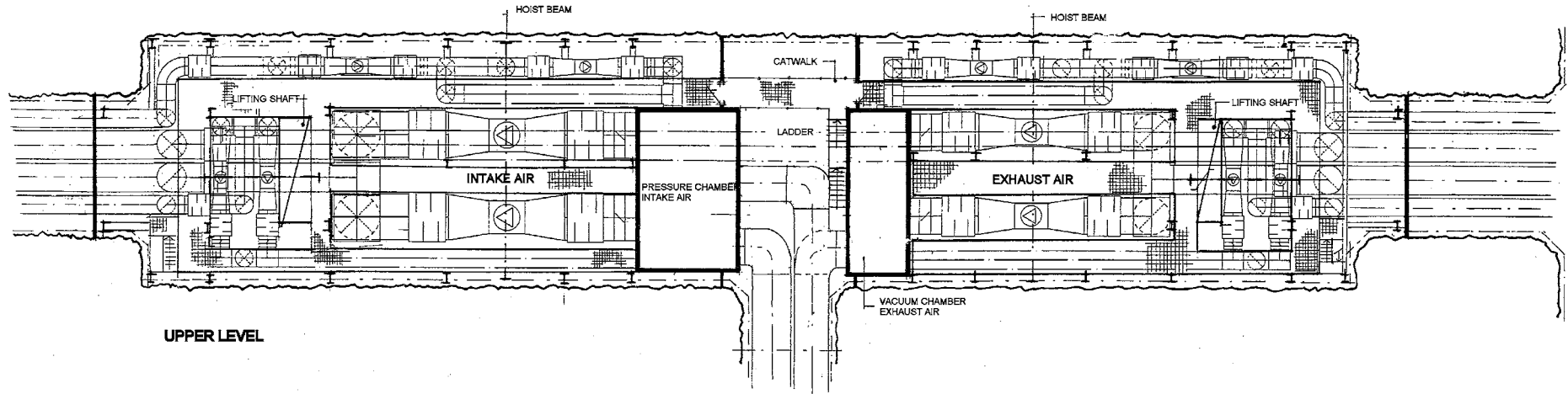

17. CENTRAL AREA
17.6 VENTILATION VAULT

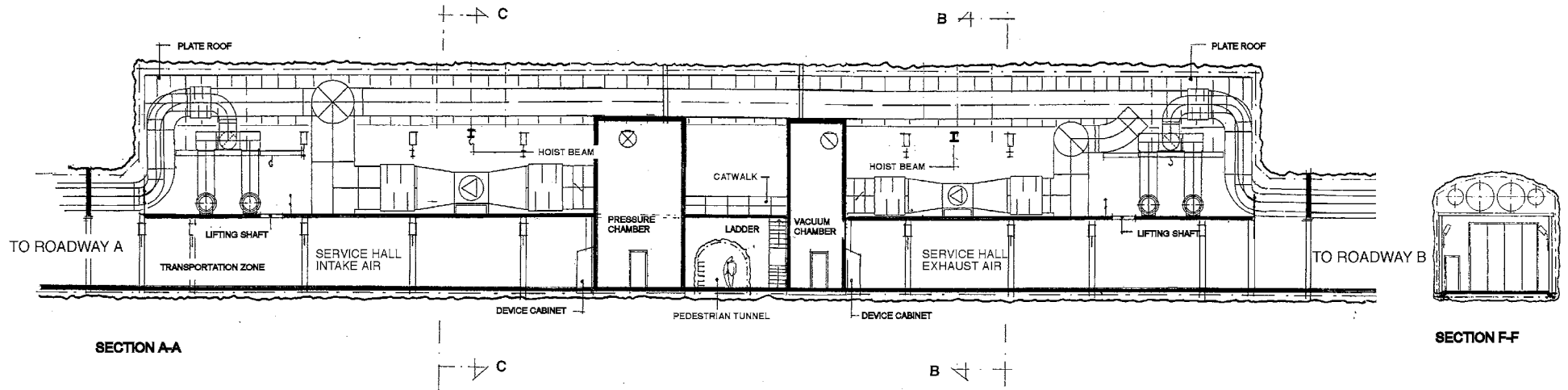

SECTION A-A

SECTION F-F

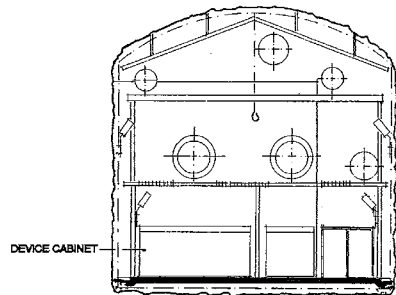

SECTION B-B

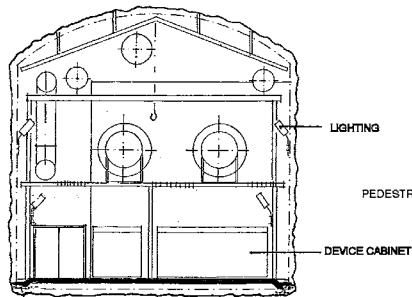

SECTION C-C

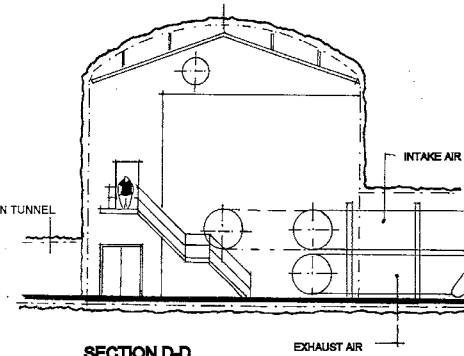

SECTION D-D

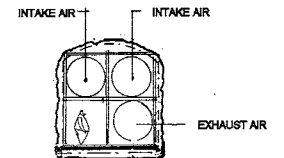

SECTION E-E



17. CENTRAL AREA

17.7 ELECTRICAL POWER VAULT

General - functions

The overall design of the power supply system for the deep repository is shown on page 5-8. There is a more detailed description of the design of the electrical systems in section 19.3.

The function of the electrical power vault is to provide room for switchgear for supplying power to all of the equipment in the underground area, with the exception of the ramp, and parking places with charging equipment for battery-driven vehicles.

The installed capacity in the underground area is estimated at approximately 9 MW. The power is supplied from a secondary busbar and a primary busbar in the electrical building in the operational area. The power is fed down by cables via the elevator and ventilation shaft to the electrical power vault, where they connect to the switchyard. The central area and the deposition areas are supplied from here, as is the collector rail for operating vehicles in the deposition areas.

The main loads in the central area are drainage pumps and ventilation fans.

Operations – electrical building section

The electrical building section is normally unmanned. Staff come only to carry out work in the building, when carrying out maintenance of the switchgear and when making additions to the system.

Operations – vehicle section

The vehicle section is intended to be used as a parking place for battery-driven light vehicles, including staff transport on the deposition level. While they are parked, the vehicles are connected to electrical outlets to charge the batteries. The main time when staff will be here is during shift changes.

Layout

In common with the other vaults, the electrical power vault is situated between roadways A and B, perpendicularly to them.

One half of the vault houses the electrical building and the other is used for parking vehicles.

The pedestrian tunnel passes through the centre of the vault, linking all of the vaults in the central area.

The electrical building and vehicle parking area are grouped along one side, while a transport roadway runs along the opposite side.

In addition to the separate switchgear rooms on the main level, the electrical building has a cable cellar below it.

These rooms have direct connections to the utility tunnel below, which links all of the vaults in the central area.

The arrangement facilitates cable installation.

The vault consists of a bare cavern with a concrete floor. The concrete floor is drained via the utility tunnel below to the adjacent repository drainage vault.

The switchgear is in a separate building, in order to provide a suitable environment for the safe operation of the electrical system.

Pressure in the enclosure is relieved using bursting panels, which burst towards the rock cavern.

The electrical building has its own ventilation.

The power supply to the deposition areas is via separate cable routes through the transport tunnels on the main level and on to the main tunnels, where there are additional local transformers.

Dimensions

Main level

- Length = 66 m
- Width = 13 m
- Height = 6 m
- Volume of vault = 4,500 m³
- Floor area of vault = 850 m²

Lower level – cable cellar

- Length = 34 m
- Width = 4.5 m
- Height = 3.5 m
- Volume of vault = 550 m³
- Floor area of vault = 150 m²

17. CENTRAL AREA
17.7 ELECTRICAL POWER VAULT

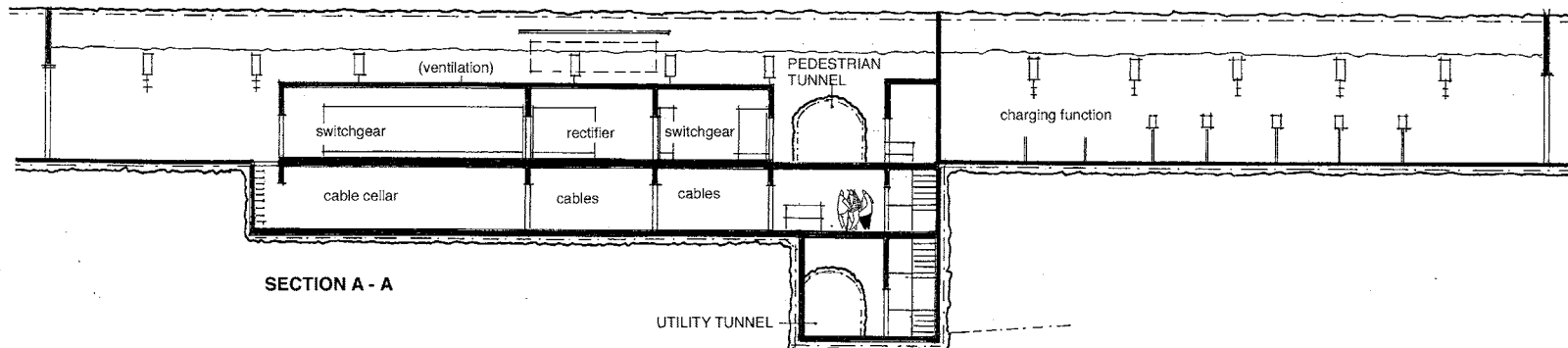
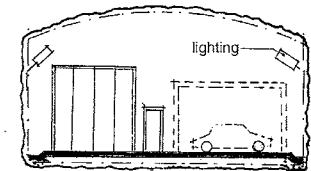
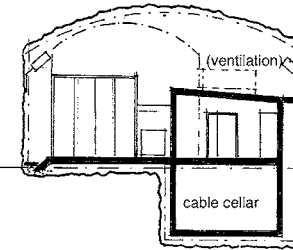
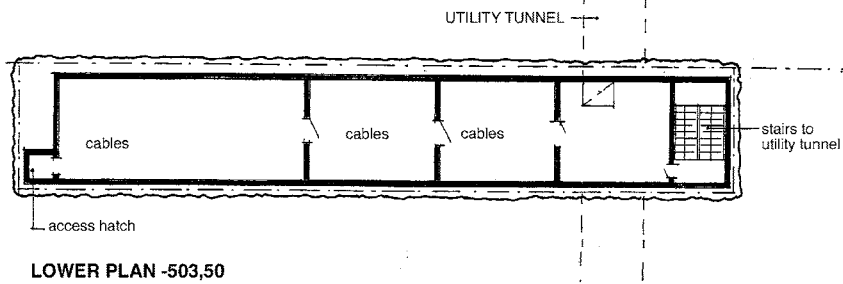
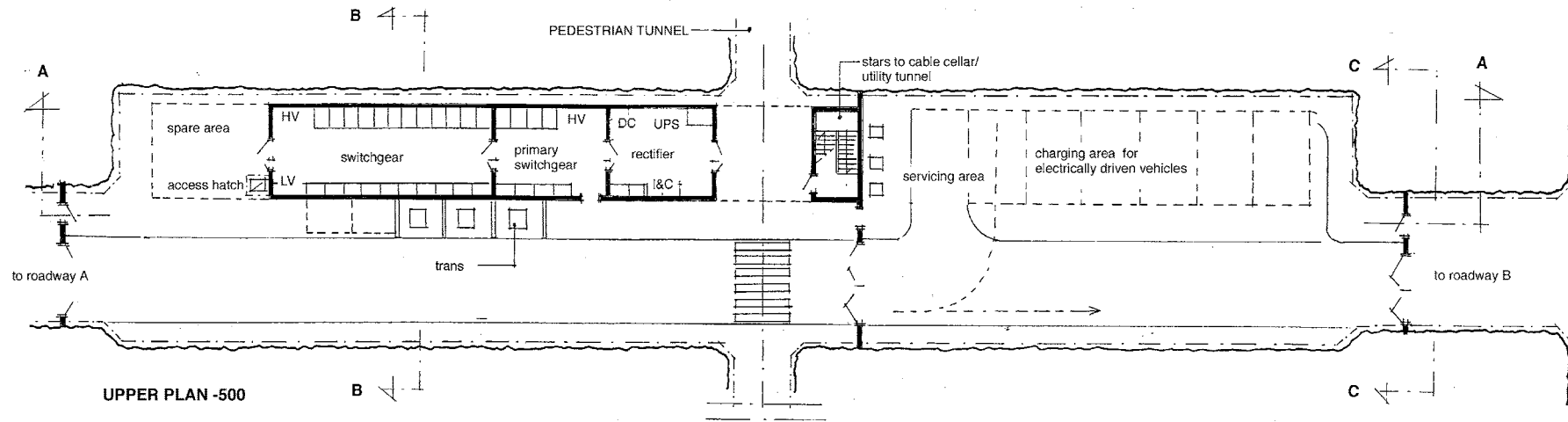

17. CENTRAL AREA
17.8 VEHICLE VAULT

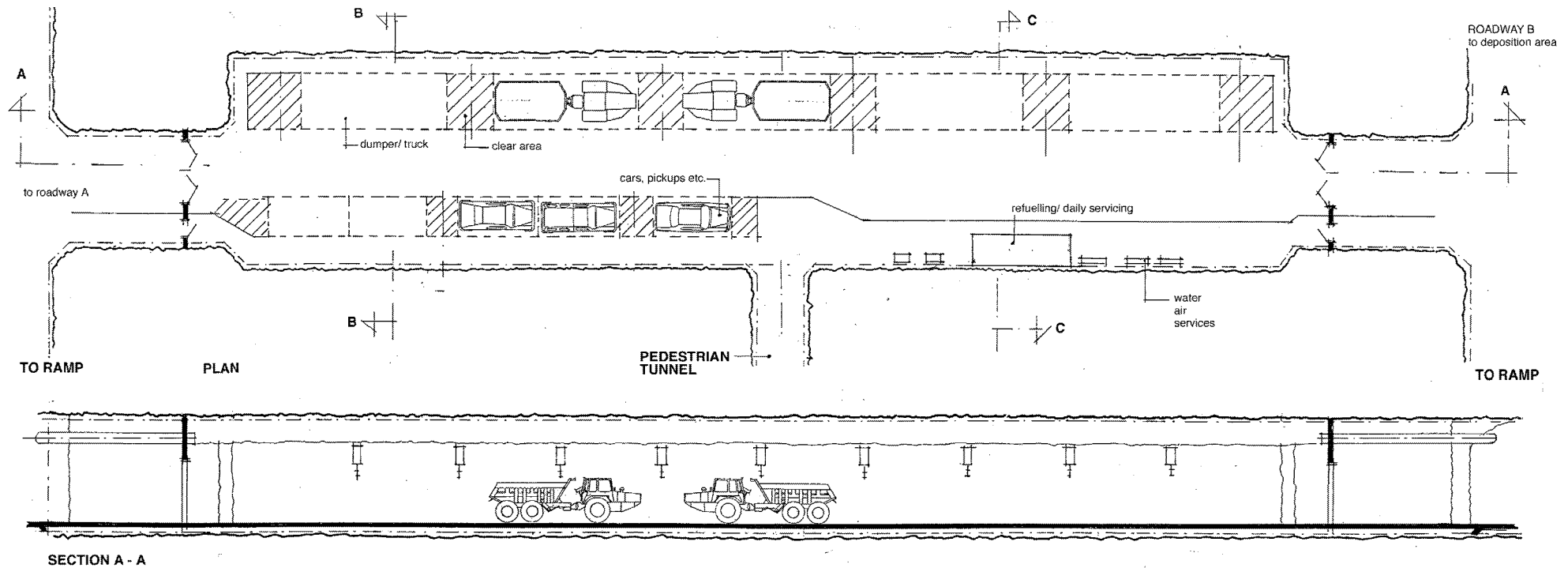

SECTION A - A

General - functions

The operations in the deposition area require a considerable number of vehicles and machines. These will have to be kept in a separate, segregated area when they are not in use.

As these units are classified as a fire hazard, it is important they be kept protected, as far as possible, in an area fitted with sprinklers. As many vehicles will be diesel-driven, it would be advantageous to set up a diesel refuelling facility in the area.

Operations

In general, staff will be in the vehicle vault only when driving the vehicles in and out. There could be a limited amount of servicing work.

Layout

The vehicle vault is situated between the repository drainage vault and the electrical power vault. The location means that it is close to washing areas in the repository drainage vault and the parking place for electrically driven vehicles in the electrical power vault. The walking distance for staff from the vehicle parking area to the staff vault and the elevator up to the operational area is relatively short.

The vehicle vault is an elongated space, with an open roadway running through it. On either side of the roadway there are places to park vehicles and machines along the walls of the vault. There is a built-in, fireproof tank at one end of the vehicle vault.

The vault has a suspended roof throughout, to protect the vehicles from any water that leaks in. The floor is concrete with drainage ditches along the walls. The pedestrian tunnel runs through the vehicle vault on the main level and the utility tunnel runs past on the level below.

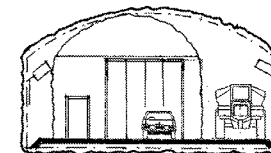

SECTION B - B

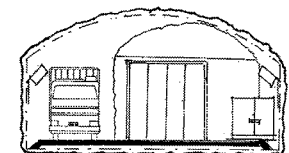

SECTION C - C



Dimensions

- Length = 66 m
- Width = 13 m
- Height = 7 m
- Volume of vault = 5,500 m³
- Floor area of vault = 850 m²

The vault can accommodate five large vehicles.

General - functions

The following functions are co-ordinated in the repository drainage vault:

- A common low point for repository drainage water from the entire underground facility, consisting of basins and pumps. Regarding the generic design of the system, refer to section 19.2.
- Freshwater basin.
- Fire fighting pumps.
- Pumps for the sprinkler systems for certain parts of the central area.
- Washing area for machines and vehicles.
- System for cleaning recirculated water for washing vehicles.
- System for oil separation in the repository drainage system.
- Equipment for dealing with sludge that has settled in the repository drainage basins.

Operations

The only occasions that staff will be in the repository drainage vault are when making rounds, servicing pumps and emptying sludge. It is also possible to wash machines and vehicles next to the basins.

Layout

The repository drainage room contains two separate collection basins and a pump room in between. The bottom level of the basins is approximately eight metres below the main level. The repository drainage water is piped from the outer, parallel transport tunnels to the basins. The pipework system is designed so that water from either side can be conducted to either basin by altering valves. In this way, it is always possible to drain one of the basins to remove the sludge.

Vehicles can enter from both ends of the repository drainage vault. There is a travelling crane in the roof of the vault, for servicing pumps and emptying sludge. The sunken basins are fitted with walls and floors. The floor on the main level is concrete. The vault is otherwise bare. Steel columns from the floor support the track for the travelling crane. There is a sheet-steel roof over the pump bay. The parking position for the travelling crane is under the same roof and in this way is protected from any water that might leak in. The basins are surrounded by a removable safety rail, and have ladders down to the water level. The sludge is lifted up by a scoop hanging from the travelling crane, and is emptied into a container, for transport to a storage area on the surface.

Special equipment

- Travelling crane
- Max. load 5 tons
- Span 10 m
- Max. lifting height 14 m
- Length of crane track 65 m
- Repository drainage system pumps
- Equipment for washing vehicles, with separate equipment to clean the washing water
- Fire fighting pumps
- Oil separation equipment.

Dimensions of main level

- Length = 66 m
- Width = 12 m
- Height = 10 m
- Floor area, excluding basin and pump room = 300 m²
- Volume = 7,500m³

Dimensions of the lower level

- Length = 52 m
- Width = 9,5 m
- Height = 8,5 m
- Floor area = 450 m²
- Volume = 3,500 m³
- Total basin capacity = 700 m³
- Volume of freshwater basin = 200 m³

17. CENTRAL AREA
17.9 REPOSITORY DRAINAGE VAULT

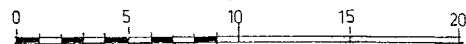
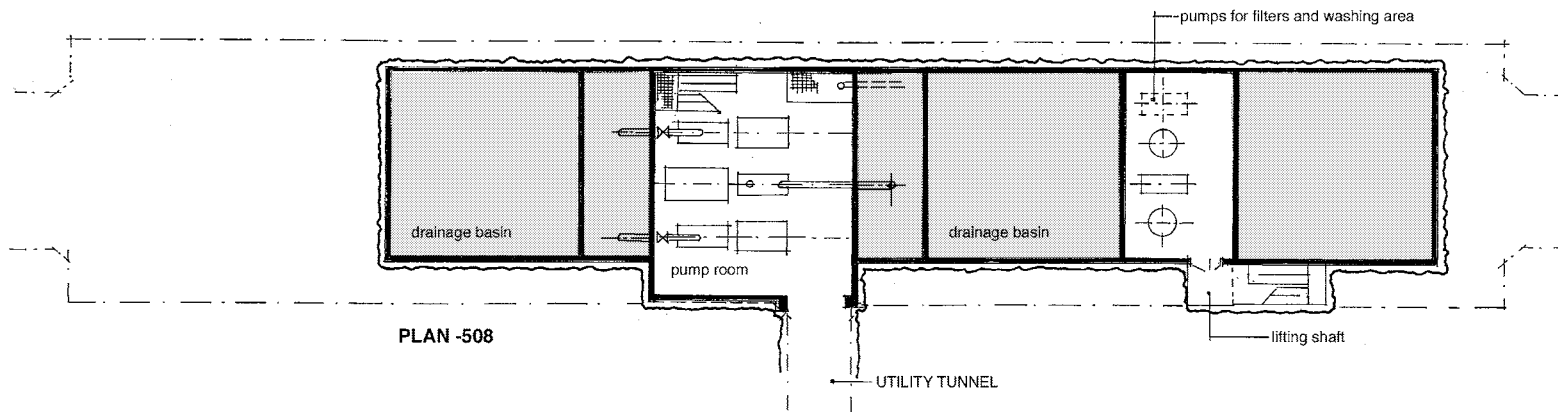
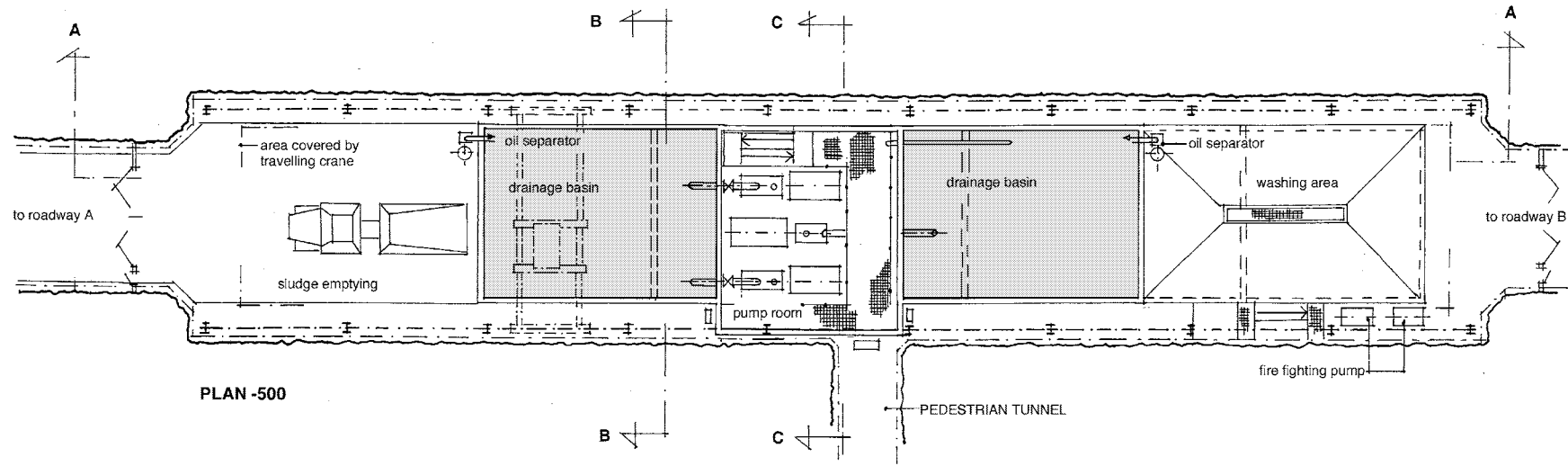

17. CENTRAL AREA
17.9 REPOSITORY DRAINAGE VAULT

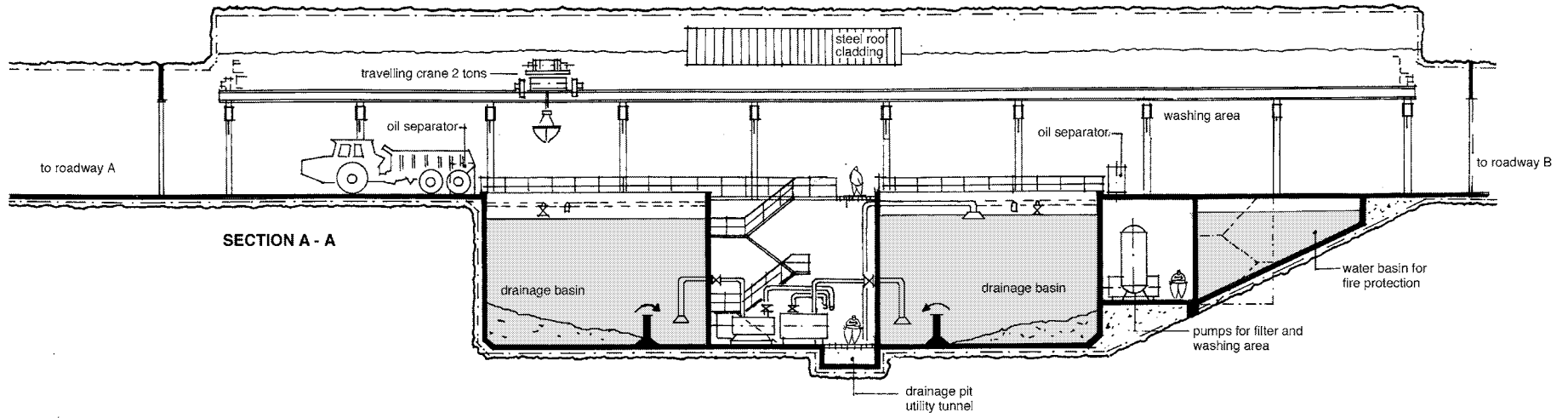

SECTION A - A

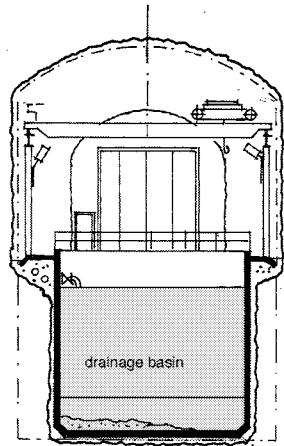

SECTION B - B

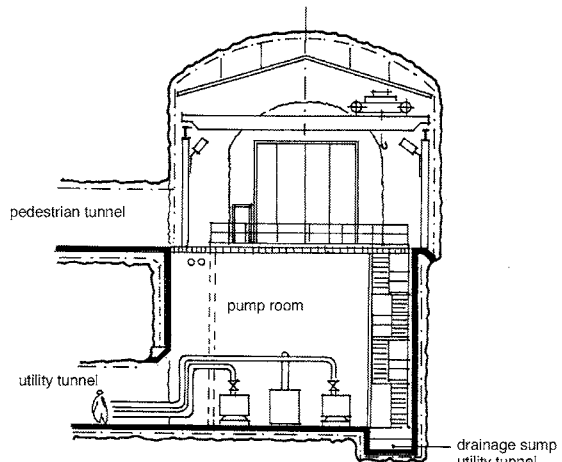

SECTION C - C



17. CENTRAL AREA
17.10 ROCK SILO

General - functions

All of the rock that is excavated during regular operation will be transported up to the surface. After crushing and mixing with bentonite, some of the material will be returned to the deposition level, to be used as backfilling material in the deposition tunnels.

A portion will be either stored with the rock that was produced when the deep repository was initially excavated or sold to an outside body.

The rock from the excavation of new deposition tunnels is transported by diesel-driven dumpers to the rock silo, which is situated in the central area of the underground facility. From there, the rock is transported up to the surface by larger, electrically driven vehicles.

These latter also take backfilling material down to the second transverse roadway, for reloading into special containers. This return transport will take place during the backfilling drives.

The silo provides considerable flexibility, as there is no direct association between the excavation work on the deposition level and the transport operations in the ramp. A disruption of some sort in either operation has no immediate impact on the other work.

As the backfilling material has to be treated as a perishable commodity, it is not possible to use an intermediate storage for this too. Consequently, the reloading to containers will have to be done at the same rate as the backfilling.

Layout

The rock silo is situated at the end of the central area, nearest the deposition area. The height of silo is such that rock can be loaded and backfilling material unloaded on the same level. To avoid a local low point that would be caused by loading containers with backfilling material standing on the -500 metre level in the adjacent tunnel, the reloading level under the rock hopper has been put on the -495 metre level. The niches for loading and unloading have been designed to suit the turning area and free height for tipping the body required by the trucks.

The diameter of the rock silo has been chosen so as to limit the likelihood of arching. In order to provide the estimated storage volume, the silo extends up to the -470 metre level. The rock silo has a steel grating over the top. The gap width is designed to suit the crusher in the production building in the operational area. The walls of the silo should be bare. The bottom has a feed mechanism. Local ramps go out from the main tunnels on both sides of the main level.

As only the trucks for transport to the surface are electrically driven, collector rails need to be installed only on the main level. The adjoining transport tunnels have concrete roadways.

Operations

Normally, it is only the dumper driver that is in the areas around the upper and lower parts of the rock silo. It might be necessary to break up large blocks using a boulder splitter over the rock silo. However, it is thought that the blasting will produce few large blocks, which is why the dumper driver can do the job. If necessary, someone could control and monitor the reloading of backfilling material into containers when the backfilling drives are in progress, depending on how the system is arranged.

Dimensions

Rock silo:

Diameter = 7.5 m
Height = 18 m
Volume = 700 m³

Unloading niche for rock:

Width = 7.5 m
Depth = 15 m
Height = 7 m
Floor area = 130 m²
Volume = 800 m³

Unloading niche for backfilling material:

Width = 8 m
Depth = 16 m
Height = 8 m
Floor area = 130 m²
Volume = 900 m³

Loading niche for rock:

Width = 7.5 m
Depth = 16 m
Height = 7 m
Floor area = 130 m²
Volume = 850 m³

Special equipment

- Boulder splitter
- Grating screen
- Conveyor belt

17. CENTRAL AREA
17.10 ROCK SILO

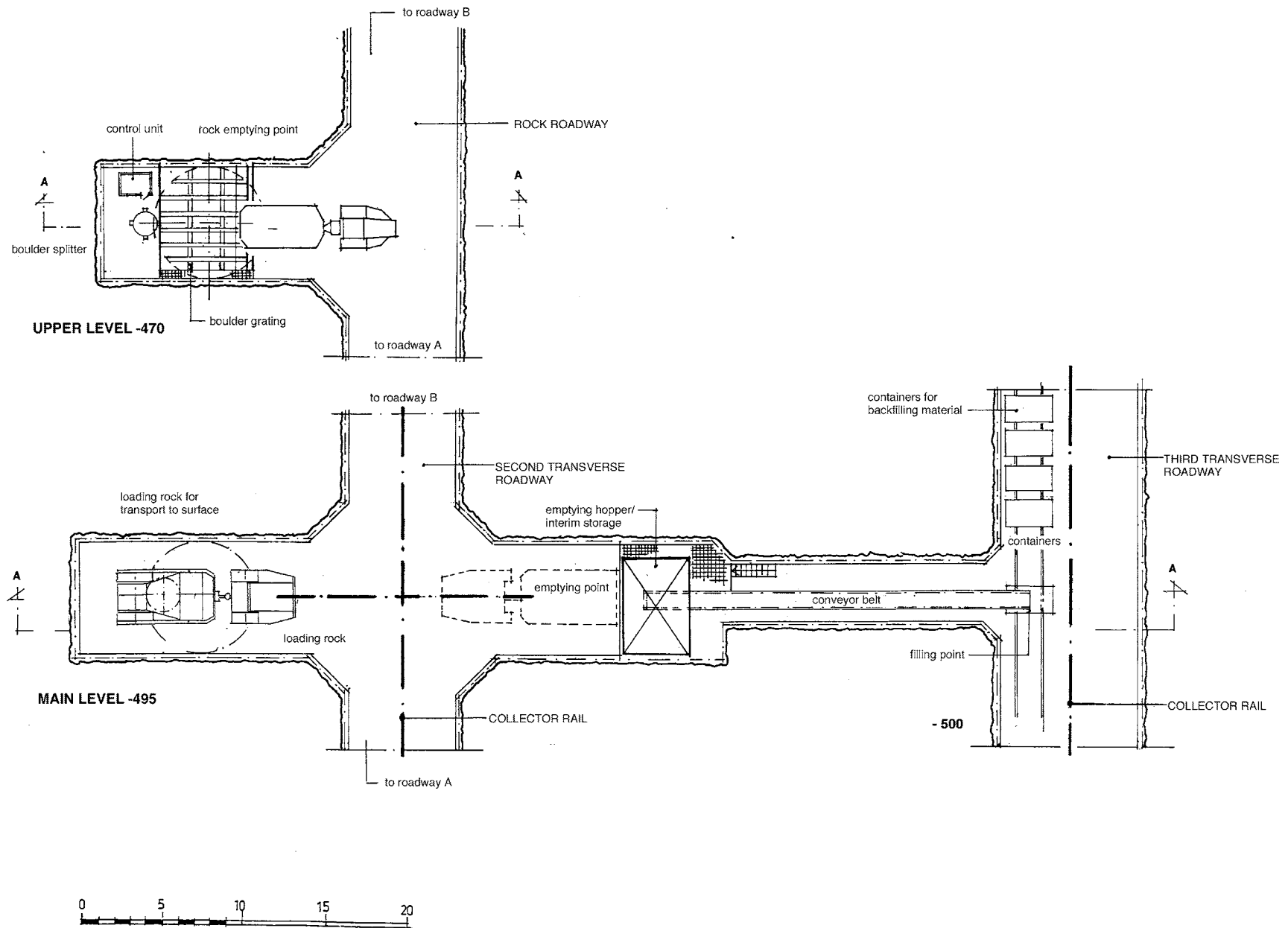

17. CENTRAL AREA
17.10 ROCK SILO

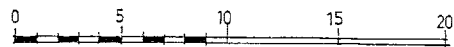
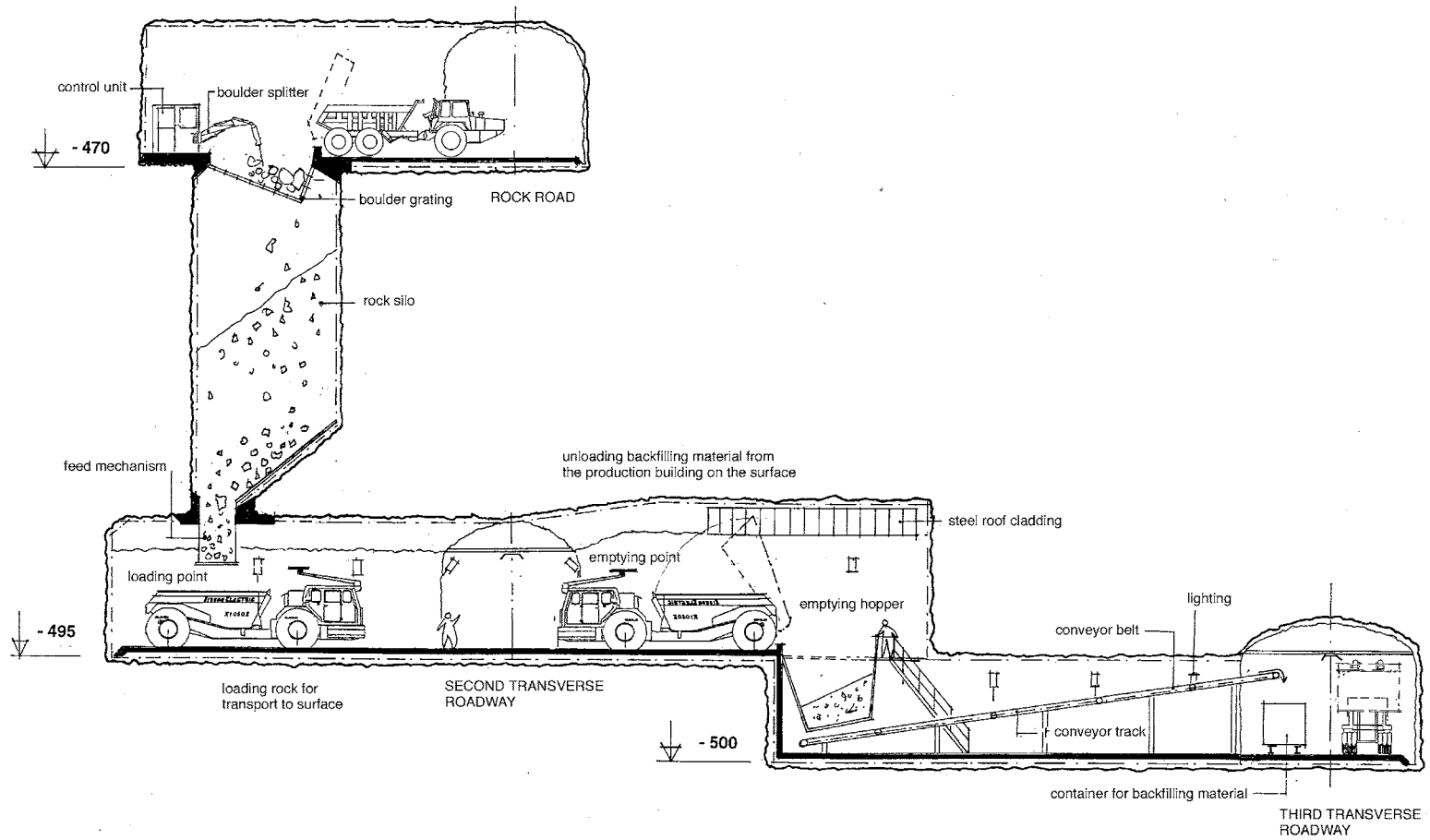

- 18.1 General
- 18.2 Deposition area 1
- 18.3 Deposition area 2
- 18.4 Excavation work
- 18.5 Deposition work
- 18.6 Drilling of deposition holes
- 18.7 Inserting of buffer
- 18.8 Deposition of canister
- 18.9 Backfilling
- 18.10 Deposition tunnel
 - connection and sealing

18. DEPOSITION AREA
18.1 GENERAL

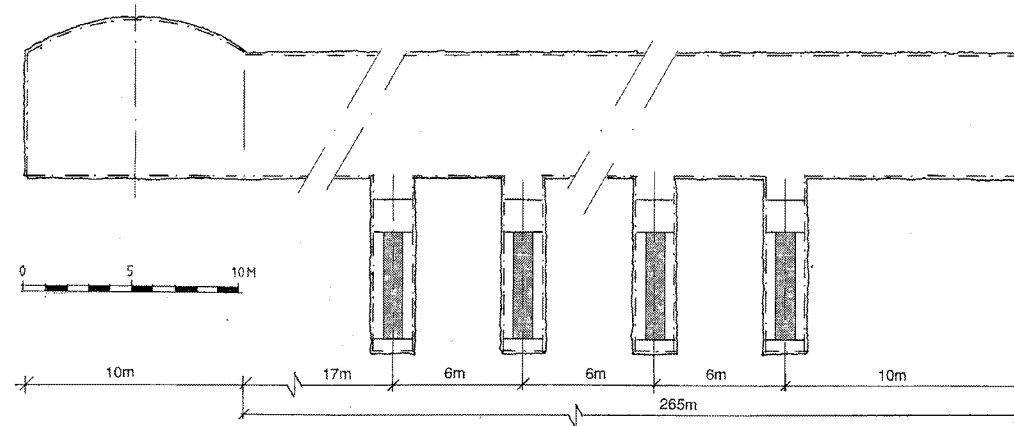
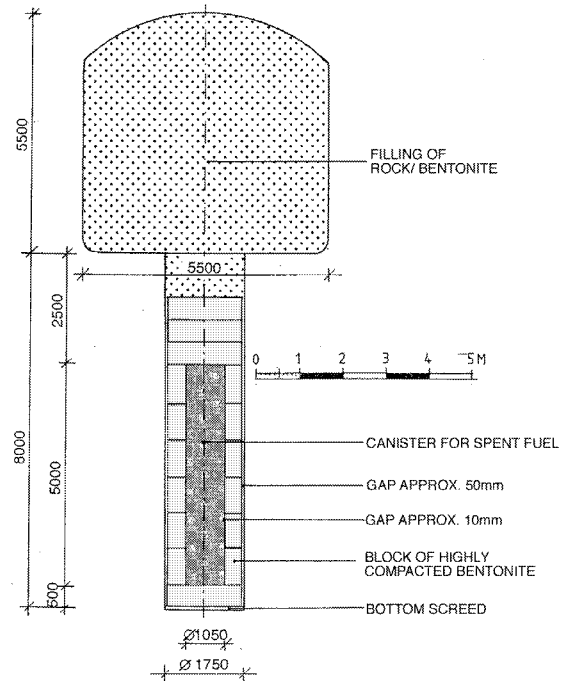

The design of the deposition area is determined by the following conditions:

1. The size of the canister: length = 4.8 metres, diameter = 1.05 metres.
2. The shape of the handling equipment. The size of the cross section of the deposition tunnel is determined by the profile of the deposition machine.
3. The thickness of the buffer in plan view = 350 mm. The size is determined by the requirement for effective sealing against groundwater and the requirement for dissipation of heat into the surrounding rock.
4. The diameter of the deposition hole is 1.75 metres
This is the sum of the diameter of the canister and the thickness of the buffer material, plus a margin to compensate for deviations in execution.
5. It is assumed that the distance between the deposition holes is approximately 6.0 metres. The distance between the canisters has been chosen so there will be sufficient rock to absorb the heat.

6. In general, the length of the deposition tunnels will be 265 metres. The size has been judged to be reasonable, considering the safety of the workers and mechanical limitations. The length of the tunnel is sufficient to accommodate 40 deposition holes, 37 positions are assumed to be useable.

The length of the deposition tunnels and the number of deposition holes will be decided when the rock quality is known.

7. The deposition tunnels will be straight and parallel.
8. The deposition tunnels join the main tunnel at right angles. This permits machines and vehicles to pass unimpeded, whichever direction they are travelling.
9. It is assumed that the distance between the deposition tunnels will be 40 metres. The main consideration when choosing this distance was heat dissipation from the canisters. If the distance between the deposition tunnels needs to be greater, due to the presence of a fracture zone, the main tunnel should convert to transport tunnel standard, for reasons of economy, and then revert to main tunnel standard when acceptable rock quality is reached.
10. The deposition tunnels will be fitted with concrete plugs, designed to prevent the backfilling material being forced out into the main tunnel when backfilling is finished.

11. Deposition tunnels will, if possible, be put on both sides of the main tunnel.
12. The connection points for the deposition tunnels on either side of the main tunnel can be located wherever is suitable. This means that there is no requirement for them to open directly opposite one another.
13. The width of the main tunnel is determined by the space needed for moving machines between the deposition tunnels.
14. The deposition part of the deep repository will be divided into two areas. The first area will be used during the initial operation and the second area will be used during regular operation. The intention is that the initial operation will demonstrate how the chosen technique performs.
15. Deposition area 1 will be separate from deposition area 2.
16. The deposition area is designed for a total of 4,500 canisters, divided into 400 for deposition area 1 and 4,100 for deposition area 2.
17. Deposition area 2 will be divided into two areas, enabling excavation work in one area in parallel with deposition work in the other area without interfering with one another.

18. DEPOSITION AREA
18.2 DEPOSITION AREA 1

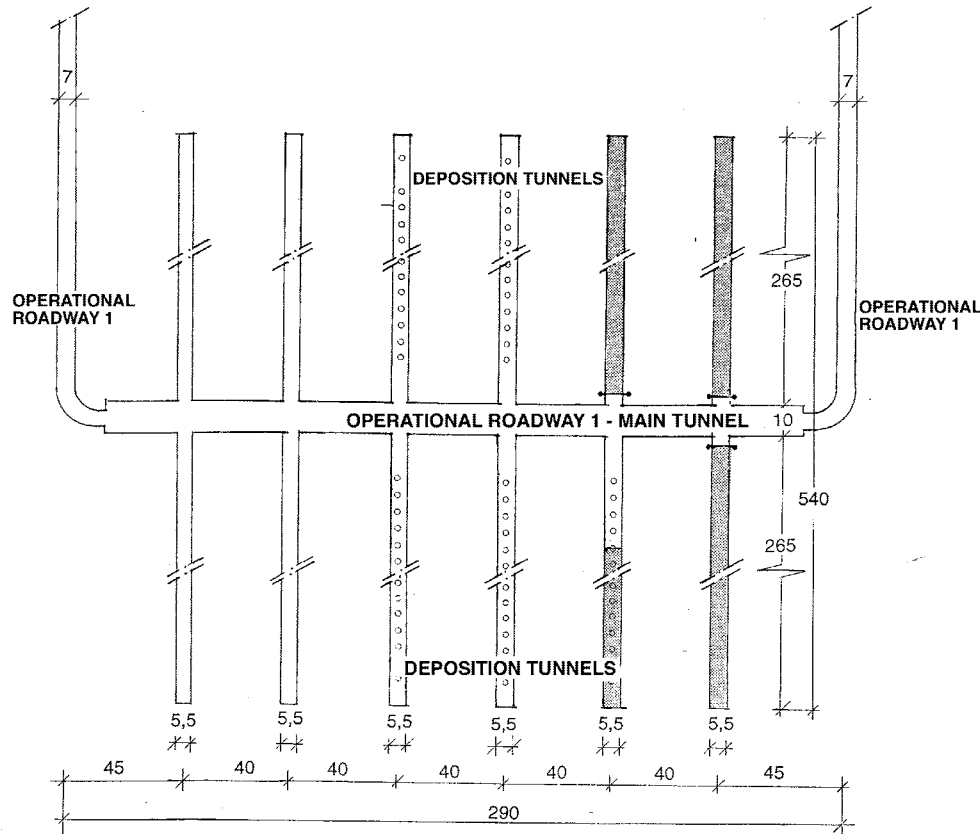

It is assumed that deposition area 1 will be separate from deposition area 2, with a connection to roadway A in the central area.

The area consists of 12 deposition tunnels, grouped six on either side of the main tunnel section of the tunnel loop.

The tunnel loop has two connections to roadway A in the central area, which facilitates the necessary transport work and also provides two alternative evacuation routes. All twelve of the deposition tunnels should be excavated as part of general development of the facility before initial operation.

Most of the deposition holes will be drilled as part of the general development.

When all of the deposition tunnels have been backfilled and sealed with concrete plugs, the initial operation will be completed. The backfilling of the main and transport tunnel system is carried out as part of the total backfilling in the decommissioning phase.

Dimensions

Plan view measurement, as shown in the figure.

Operational roadway 1	approx. 1,300 m
Area of section:	approx. 110,000 m ²
Number of canister positions:	400
Total deposition volume:	100,000 m ³ .

18. DEPOSITION AREA
18.3 DEPOSITION AREA 2

Deposition area 2 is the extension of the central area, linked by a tunnel loop that begins at roadways A and B in the central area.

There are 55 deposition tunnels grouped on either side of each leg, called operational roadways 2A and 2B, 110 in total.

The layout provides for evacuation in two directions, whatever the starting point.

The adjoining figure shows the final extent of the deposition area.

For reasons of time and economics, only part of the tunnel system will have been developed when regular operation begins. During regular operation, the excavation work will be carried out in parallel with the deposition work.

The division into two sides means that the excavation and deposition work can be separated, which is necessary because of the nature and scale of the operations in relation to the planned rate of deposition.

The combination of excavation and deposition means that only part of the deposition tunnel system will be open at any time.

When the repository is being extended prior to regular operation, the furthest part of the tunnel loop will be excavated, as a small investigation tunnel. A ventilation shaft will be drilled in the furthest part of the loop. This will enable air to be evacuated from operational roadways 2A and 2B.

Dimensions

Plan view measurement, as shown in the figure.

Area of the section:	approx. 1,180,000 m ²
Number of canister positions:	4,100
Total deposition volume:	950,000 m ³ .

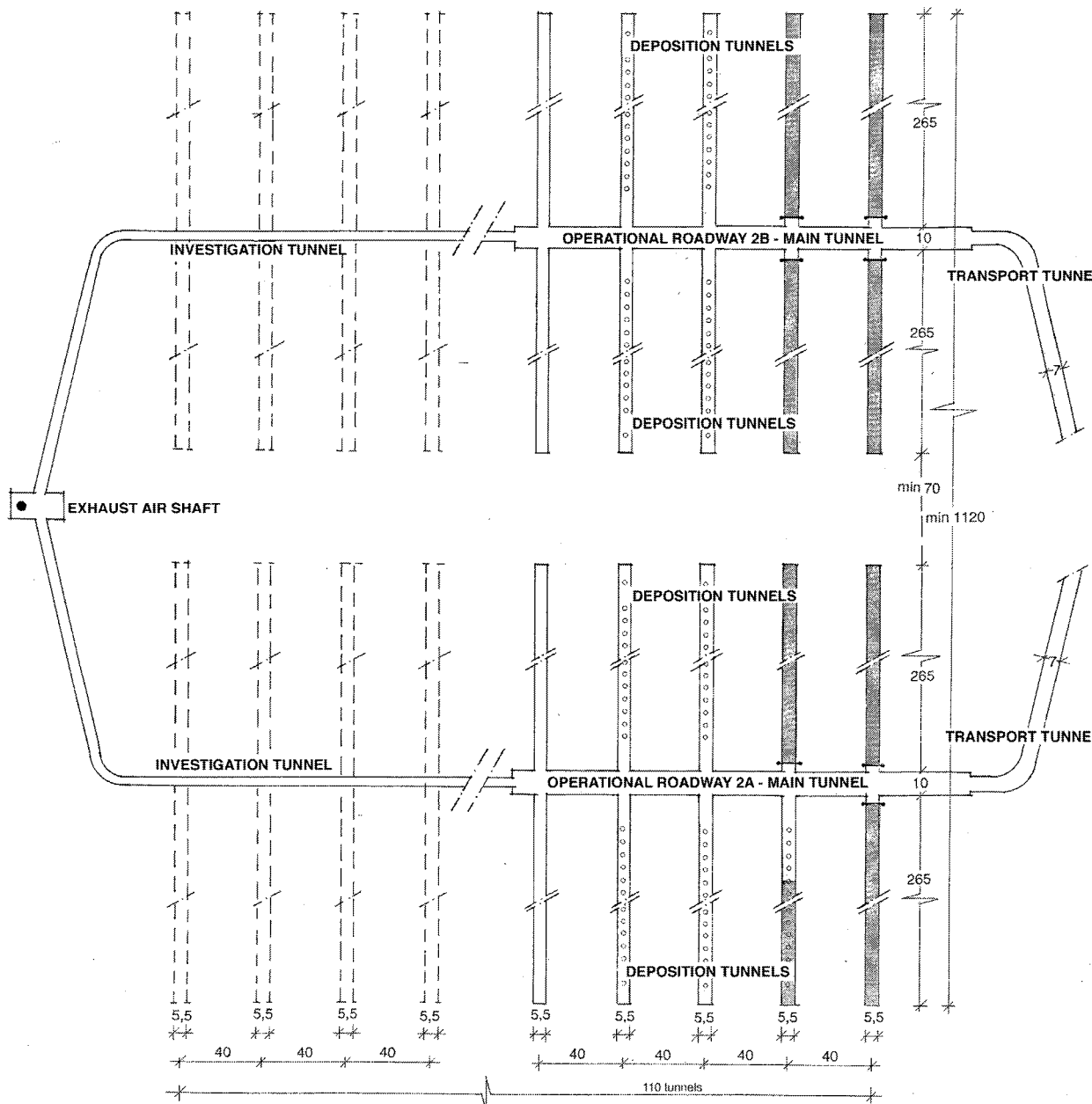

18. DEPOSITION AREA
18.4 EXCAVATION WORK

Excavation work

The excavation work involves a number of different activities, each of which requires specialised staff with access to machinery specially designed for the purpose.

To achieve high productivity, it is essential that these crews are able to work continuously, without being affected by waiting time caused by other activities. To avoid this, the activities should be going on in around ten tunnels at the same time. This will make it possible to co-ordinate the work optimally.

The tables on the right show the activities, with the associated mechanical equipment.

View of the situation

The illustration on page 18-5 shows how the excavation work might be carried out at one stage during regular operation.

The illustration shows a situation in which the principles outlined above are being applied, with parallel work in several tunnels. The positions indicated are intended to show which machines are needed and where in the tunnel system they are either operating or are standing while awaiting the next operation.

In this way, the illustration gives an understanding of the space limitations in the particular work area.

It is estimated that approximately 25 people will be working in the area at the same time.

Pos.	Activity/ Equipment
A.	Core drilling for deposition tunnels
1.	Drilling rig for core drilling
2.	Wagon for cores
3.	Service vehicle for staff and light materials.
B.	Enlarging investigation tunnels into transport/main tunnels. Excavating deposition tunnels (drift and bench)
1.	Drilling rig
2.	Grouting equipment
3.	Loading equipment for explosives
4.	LHD-loader
5.	Dumpers
6.	Bolt drilling unit
7.	Equipment for shotcreting
C.	Mucking the tunnel bottom, installations
1.	Light excavator
2.	Dumper

Pos.	Activities/Equipment
D.	Casting concrete slabs and laying roadway
1.	Concrete truck
2.	Gravel truck
3.	Vibrating roller
4.	Tractor loader
E.	Preparing deposition holes
1.	TBM machines
2.	Vacuum suction unit, including containers
3.	Truck with crane
F.	Drilling of recess
1.	Drilling rig
2.	Tractor loader
G.	Other
1.	Rescue chamber
2.	Toilet unit
3.	Switchgear container
4.	Tool container
5.	Service vehicle
6.	Vehicle for transporting staff
7.	Hydraulic lift platform

18. DEPOSITION AREA
18.4 EXCAVATION WORK

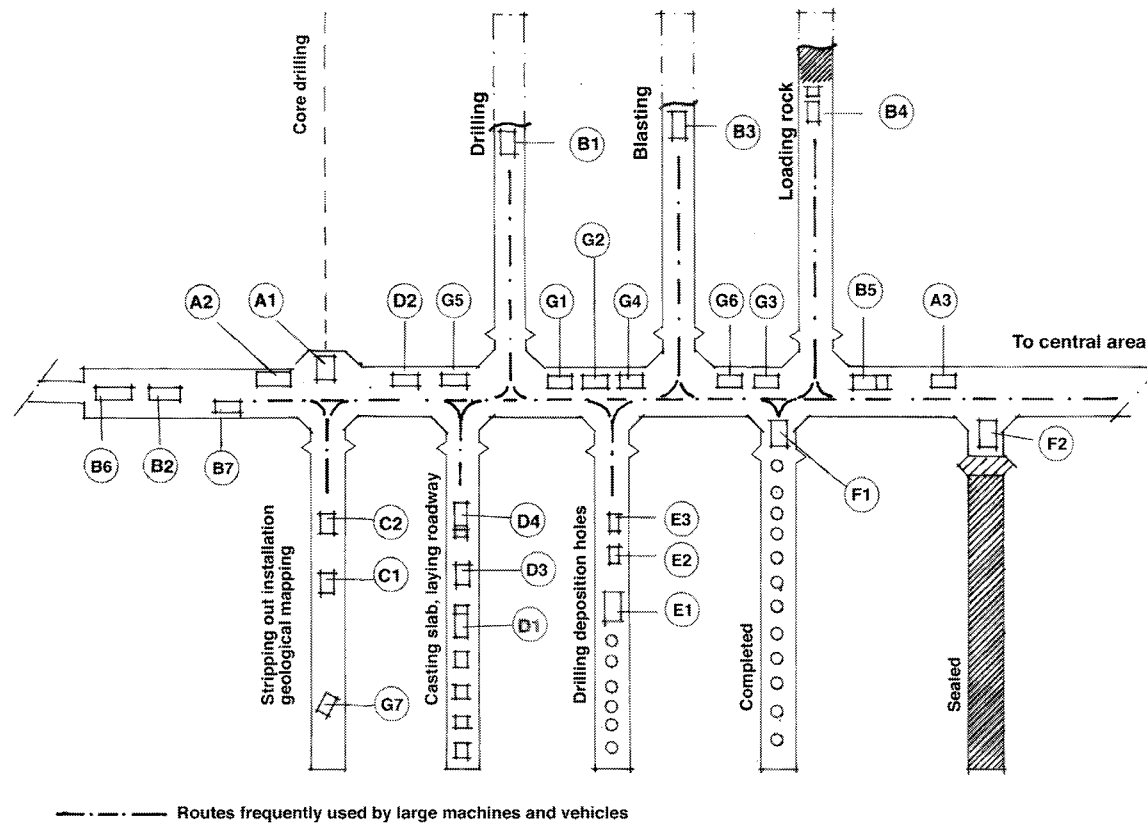

18. DEPOSITION AREA
18.5 DEPOSITION WORK

Deposition work

The deposition work consists of a number of activities, each of which requires specialised staff with access to specially designed mechanical equipment.

The operations follow a fixed order of priority, determined initially by the space available. If time is to be used most efficiently, most of the tasks must be done simultaneously.

The table shows the number of activities, with associated mechanical equipment.

View of the situation

The illustration on page 18-7 shows how the deposition work could be carried out at one stage during regular operation.

The illustration shows that activities are going on in four deposition tunnels at the same time. The positions indicated show which machines are used where at the particular time/point. The example also shows temporary parking of machines while awaiting the next operation.

The purpose of the illustration is to try to give an understanding of how the work area might look on the deposition side.

It is estimated that approximately 25 people will be working in the area at the same time.

Pos. Activity/Equipment

H. Checking deposition holes

1. Work platform
2. Mobile crane for handling the cover

I. Levelling the bottom of deposition holes

1. Concrete truck
2. Work platform for work in the deposition hole

J. Deposition

1. Buffer vehicle
2. Deposition machine
3. Vehicle for transporting canisters

K. Stripping out installations - Removing roadway

1. Excavator
2. Hydraulic lift platform
3. Dumpers

Pos. Activity/Equipment

L. Backfilling

1. Wheel loader with containers
2. Backfilling machine with vibrator

M. Casting of plug

1. Concrete truck
2. Truck with crane
3. Concrete pump

N. Other

1. Rescue chamber
2. Toilet unit
3. Switchyard container
4. Tool vehicle
5. Service vehicle
6. Vehicle for staff transport

18. DEPOSITION AREA
18.5 DEPOSITION WORK

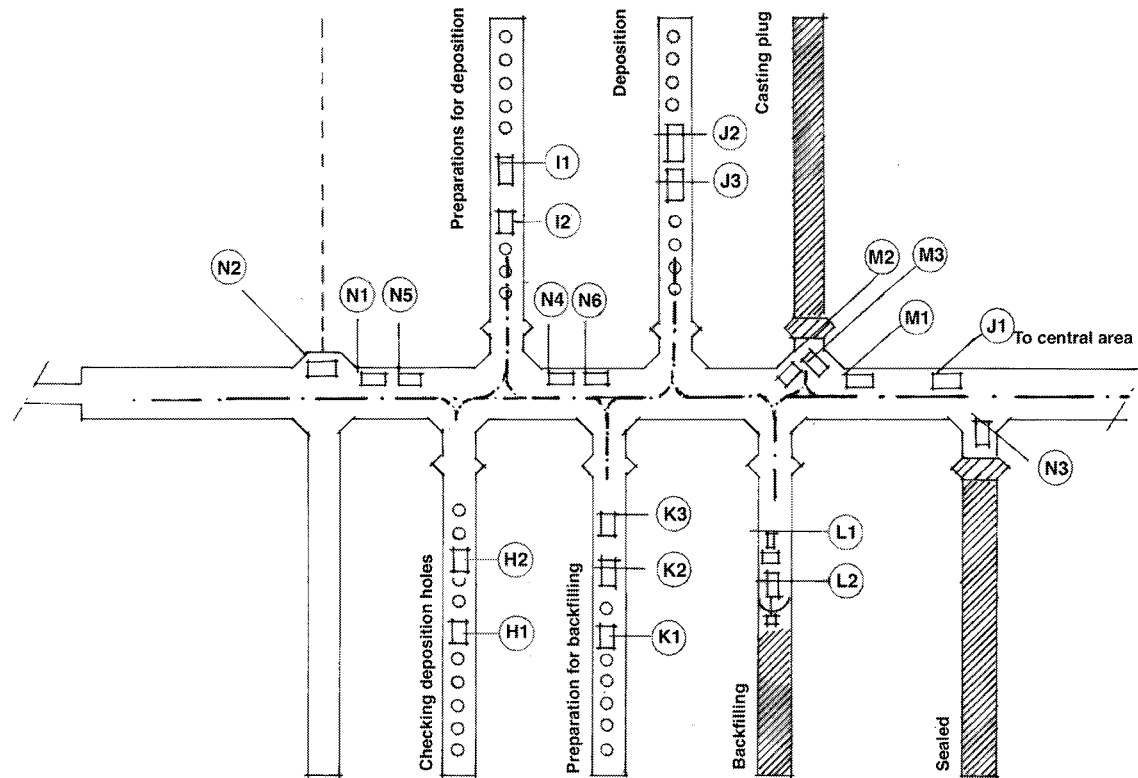

--- Routes frequently used by large machines and vehicles

18. DEPOSITION AREA
18.6 DRILLING OF DEPOSITION HOLES

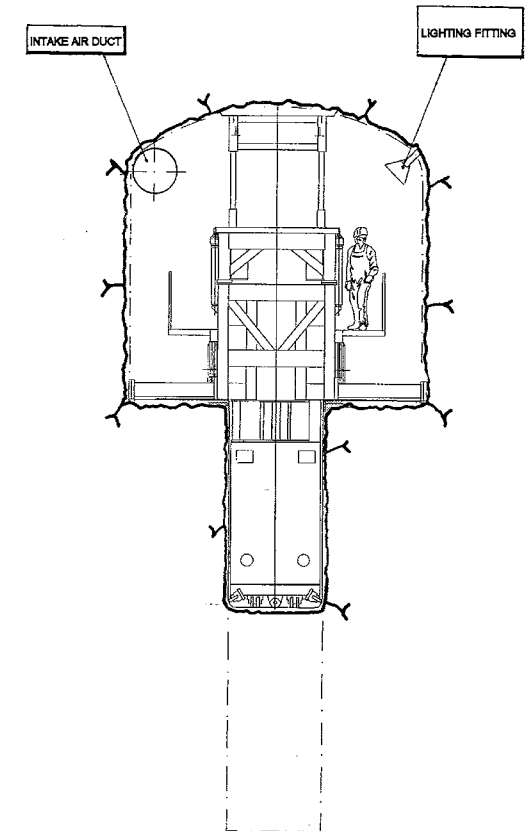
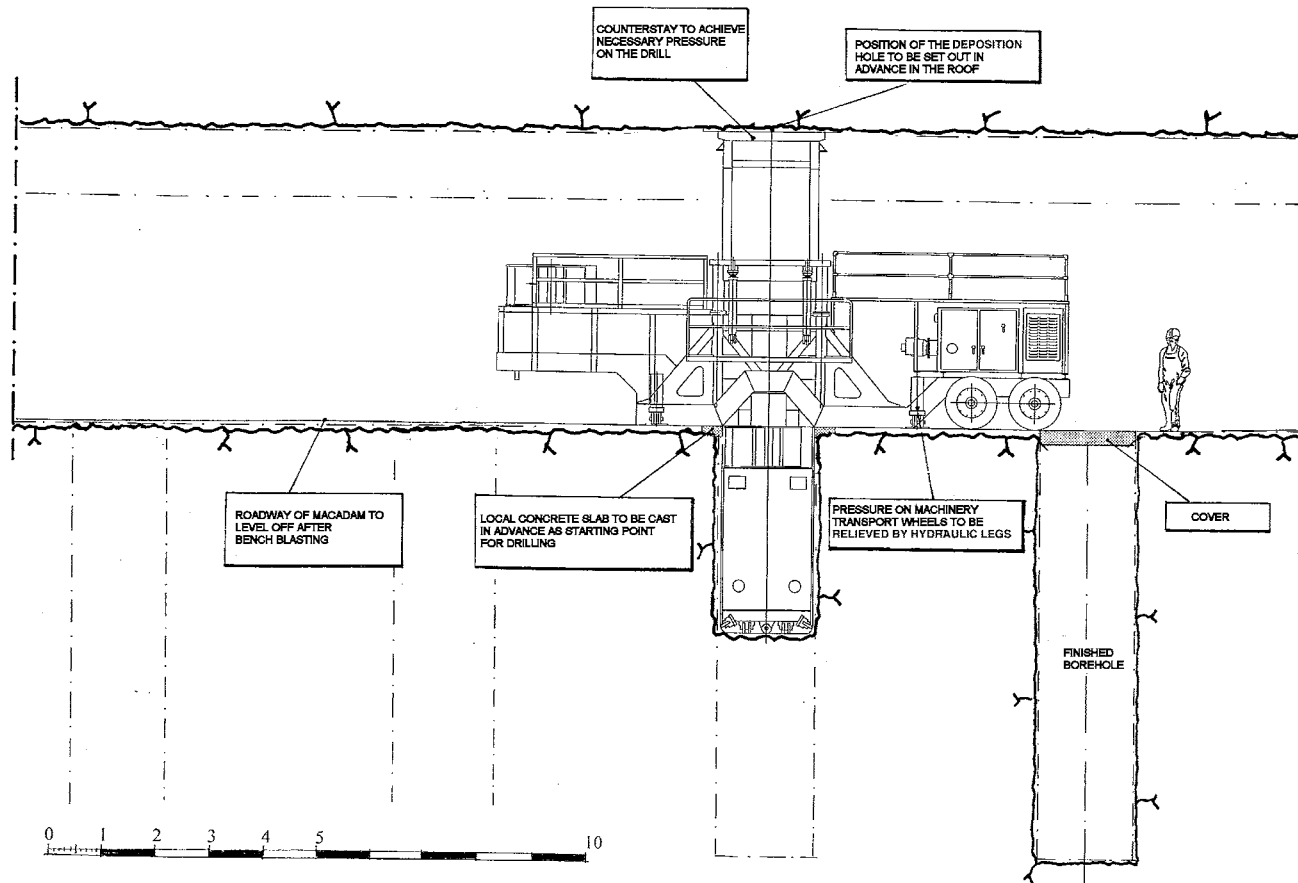

Drilling of deposition holes

Drilling the deposition holes is part of the excavation work. The machine is electrically driven. Power is supplied via a cable.

The roadway in the deposition tunnel is macadam, which evens out the floor after bench blasting. Individual concrete slabs have been cast over the locations of the deposition holes.

The position of the deposition holes is marked in advance on the roof of the tunnel.

The machine is reversed into the tunnel and a special truck moves it between the positions.

When drilling, the weight of the drilling rig is taken of the transport wheels by hydraulic struts. The roof is used as an abutment, to achieve sufficient pressure on the drill.

A vacuum suction unit continuously removes the drill cuttings.

As the deposition hole is deeper than the height of the tunnel, the drilling will have to be interrupted a number of times in order to insert distance pieces to give the desired drill depth.

The volume of the deposition hole is 20 m³.

18.
18.7 DEPOSITION AREA
INSERTING OF BUFFER

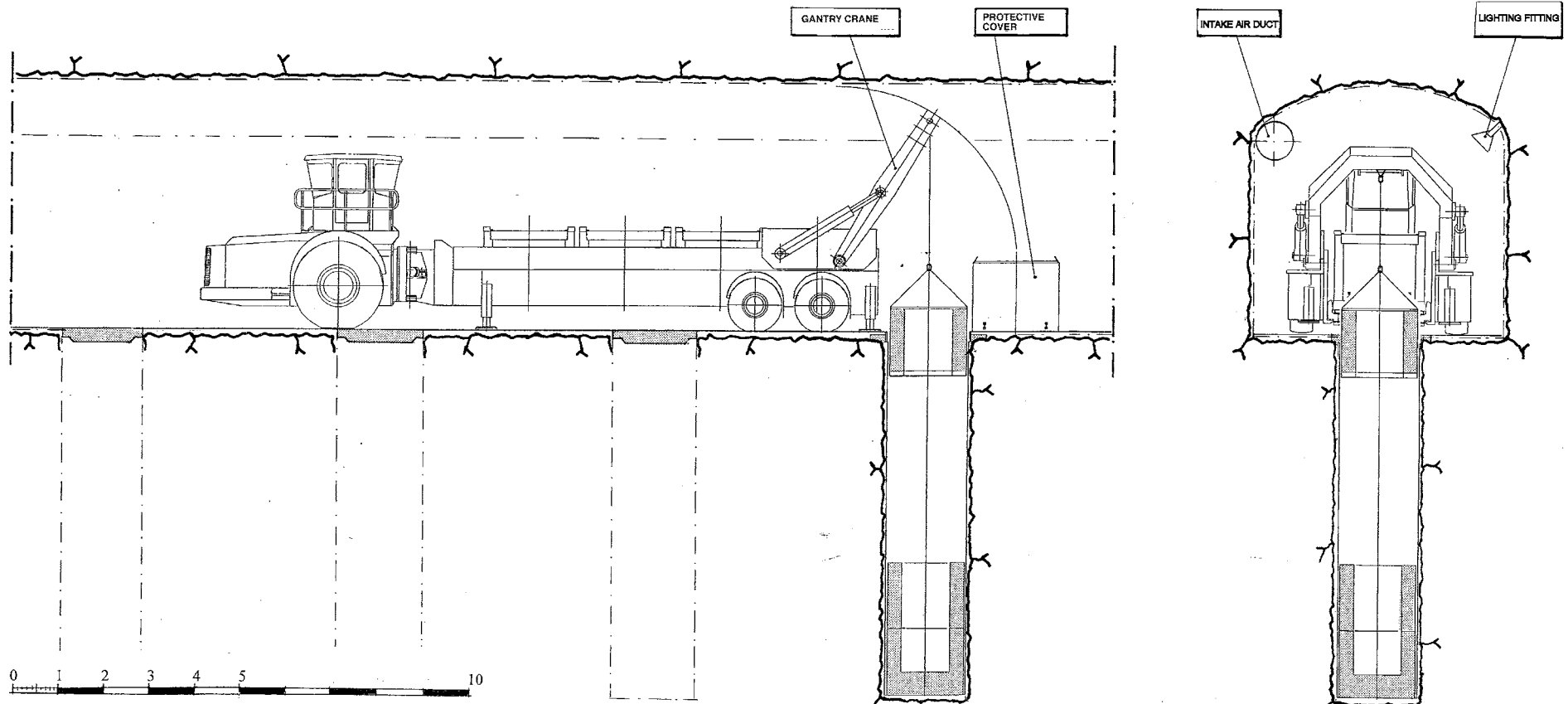

Inserting of buffer

The machine is electrically driven. Power is taken from the collector rail as far as the mouth of the deposition tunnel. After that, power is supplied via a cable connected to a nearby outlet.

The job of the buffer deposition machine is to transport the compacted buffer material from the production building in the operational area to the deposition tunnel, including positioning the units in the deposition hole.

The vehicle loads sufficient blocks for one deposition hole.

The machine is reversed into the deposition tunnel. Hydraulic legs align the load section with the deposition hole. The units are lifted by a gantry crane, which can position them precisely.

Each unit is protected under a removable cover on the vehicle. First, the cover is lifted off and put at the far side of the deposition hole. Then, the bentonite block is connected and lowered down into the hole. The protective cover is put back on the vehicle and the next sequence starts.

18.
18.8

DEPOSITION AREA DEPOSITION OF CANISTER

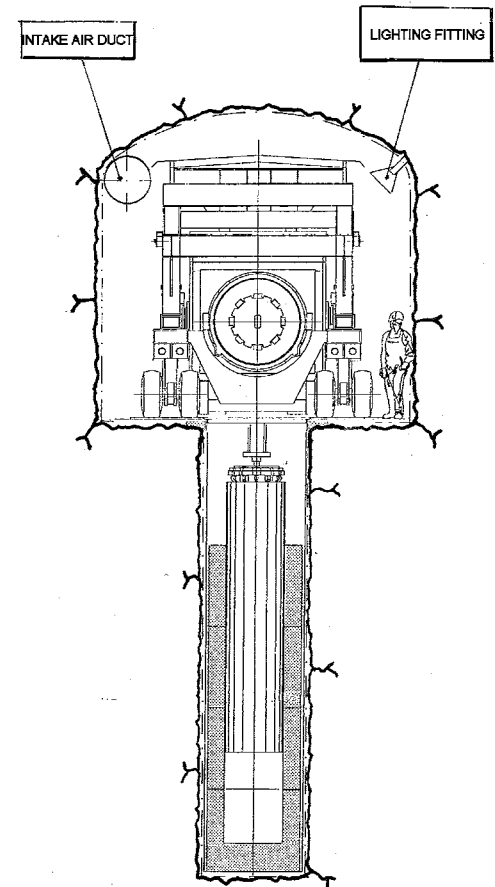
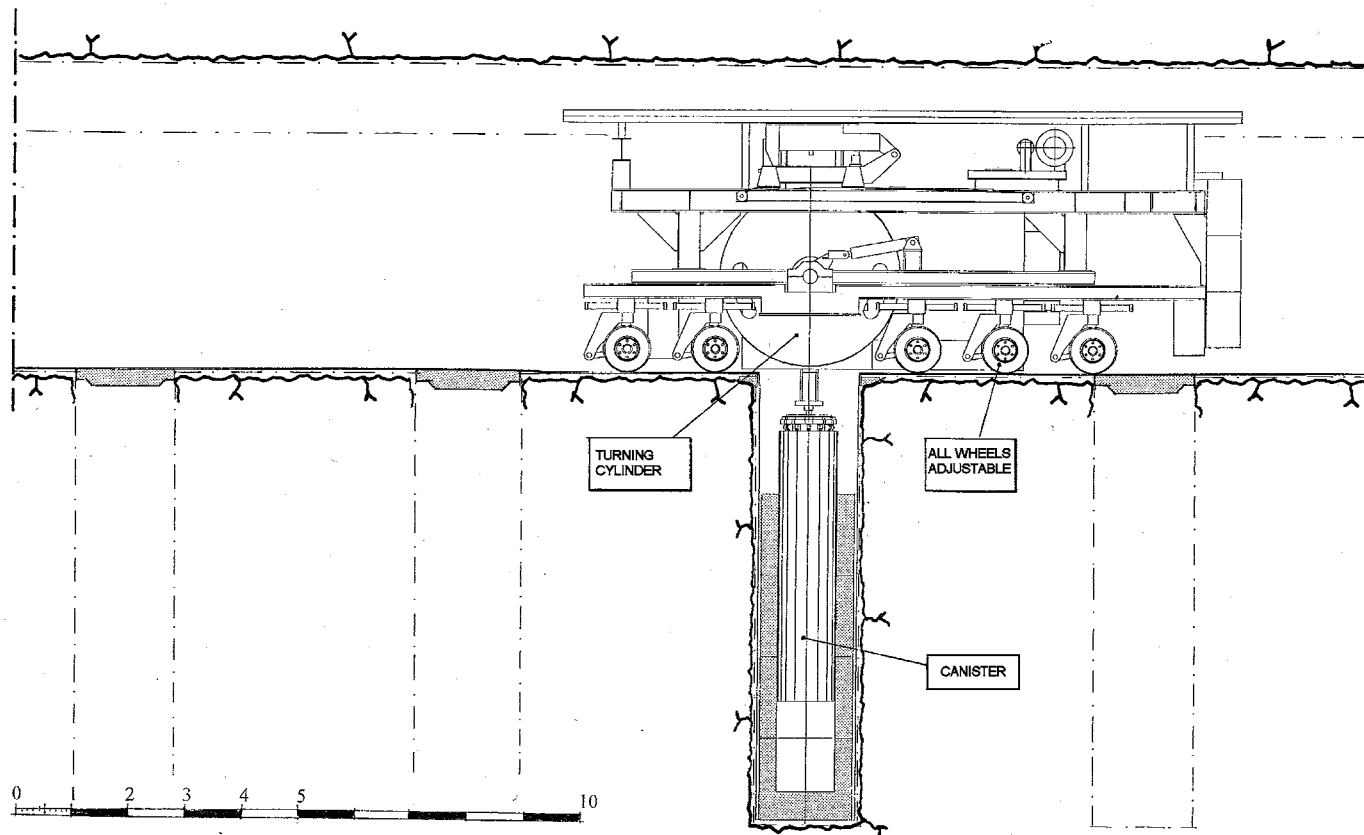

Deposition of canister

The job of the machine is to transfer the canister from the horizontal position to the vertical position and then lower it down and place it on the bottom block of the deposition hole.

The machine is electrically driven and self-propelled. Power is supplied via a cable from a nearby outlet.

Deposition starts at the far end and continues out to the mouth of the tunnel.

A special vehicle transports the canister to the deposition machine. Inside the machine, the canister is enclosed by a radiation shielding tube. The deposition machine pulls the canister across, after which the insertion process begins. The machine is radiation shielded from the surrounding area.

The deposition machine is remote-controlled.

18. DEPOSITION AREA
18.9 BACKFILLING

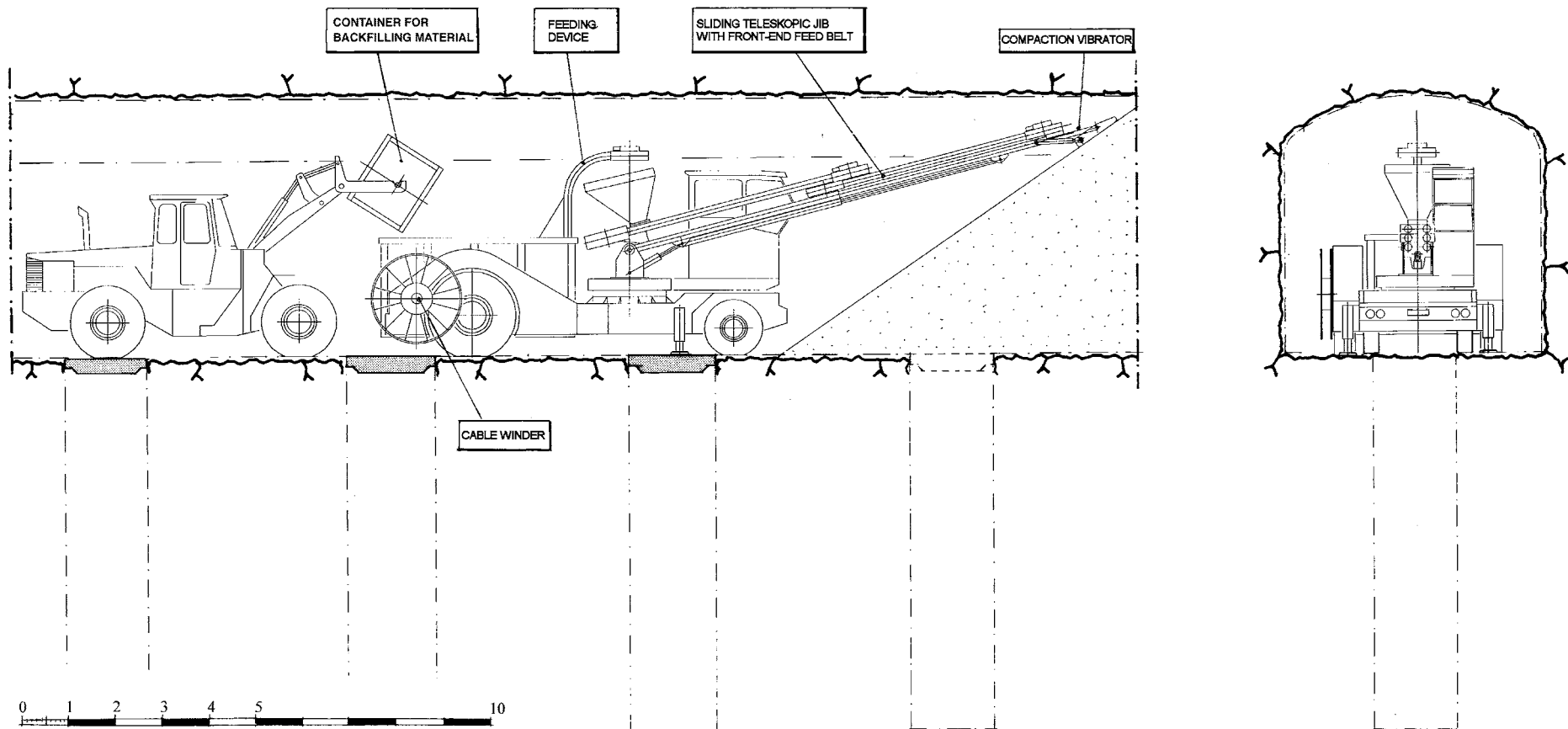

Backfilling

The job of the backfilling machine is to refill the deposition tunnel with a mixture of crushed rock and bentonite. The material will be compacted carefully, to achieve the best possible fill quality.

The backfilling machine is electrically driven. Power is supplied via a cable from a nearby outlet.

The machine has a moveable, telescopic arm, with a feed belt, feed device and vibrating compactor.

The work will go on continuously along the entire tunnel, in order to quickly produce sufficient resistance to withstand the swelling of the bentonite. A wheel loader transports containers of backfilling material between the main tunnel and the backfilling machine.

The turnaround time for a tunnel is approximately 5.5 weeks.

18. DEPOSITION AREA
18.10 DEPOSITION TUNNEL – CONNECTION AND SEALING

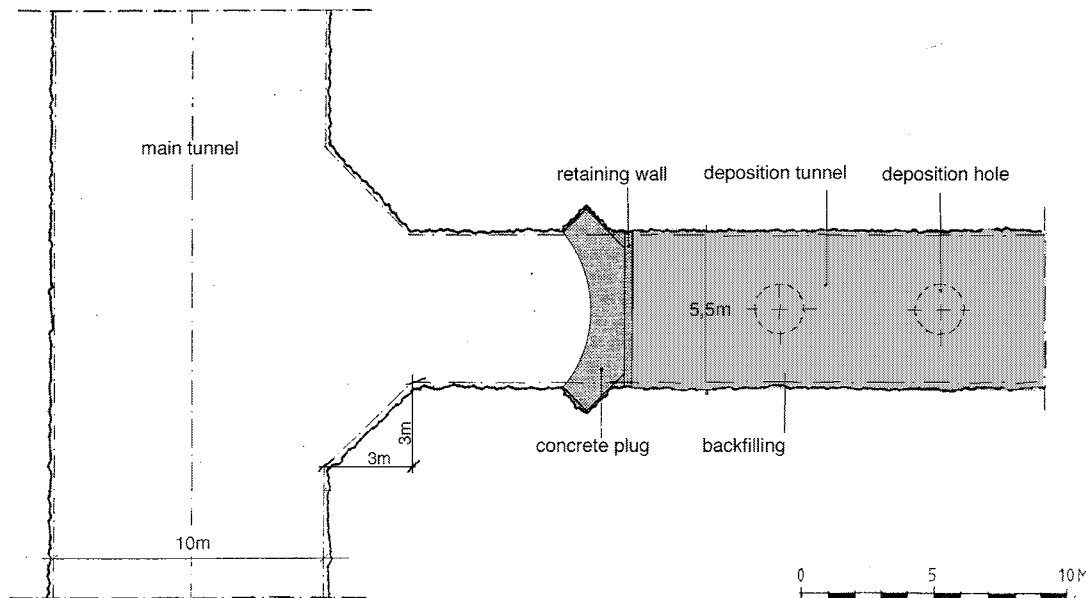
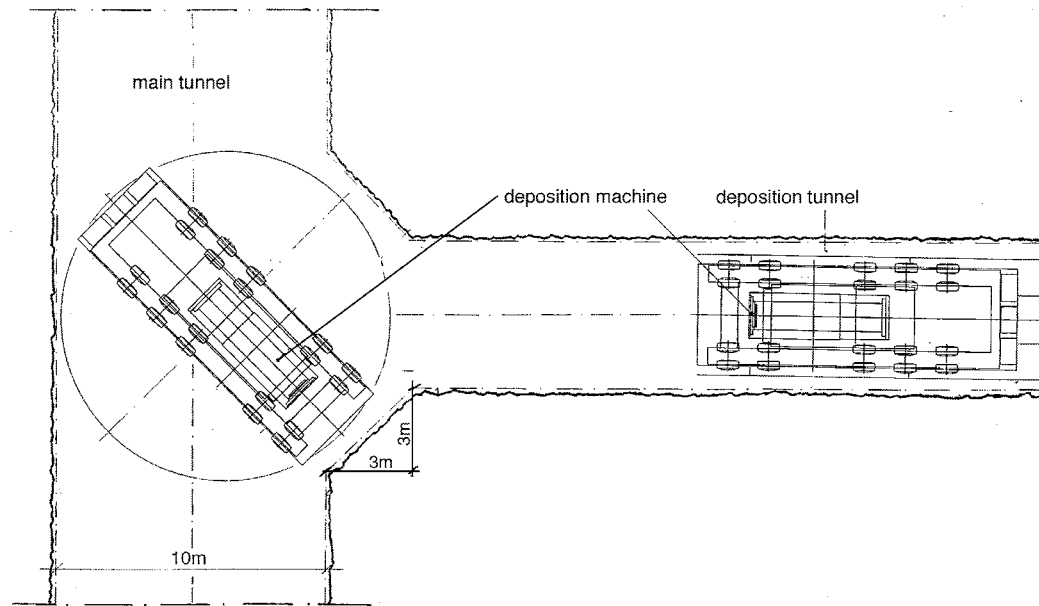

Connection

The connection of the deposition tunnel to the main tunnel must be made so as to allow the passage of all vehicles and machines needed to carry out tunnelling, deposition and backfilling. The deposition machine requires the most room, the main tunnel must be 10 metres wide and the deposition tunnel must be chamfered as shown in the diagram.

As an example of the space required, the deposition machine has been drawn on the sketch.

Further detailed studies will be required to check that there is room to install the necessary utility systems in the area, without impeding the transport vehicles. This applies to electrical distribution units, air fans, screens etc.

Sealing of the deposition tunnel

The deposition tunnel will be backfilled with a mixture of crushed rock and bentonite when deposition comes to an end.

To complete the backfilling, a retaining wall must be erected, to prevent the backfilling material falling out into the main tunnel. The wall will withstand the pressure from the backfilling material.

To prevent the combined pressure from groundwater and the swelling of the bentonite pushing the material out of the deposition tunnel, a substantial plug must be cast in the mouth of the tunnel. Its job is to seal the deposition tunnel until the main tunnel is backfilled. The concrete plug has no long-term barrier function.

The sketch shows a preliminary arrangement of the sealing.

- 19.1 Ventilation system
- 19.2 Repository drainage system
- 19.3 Electrical system
- 19.4 List of systems

19

SYSTEMS

Ventilation system
General

The ventilation system shall provide the different parts of the deep repository with ventilation air in order to maintain a good working environment for staff, equipment and operations. The ventilation system will be divided into different separate installations placed above and below ground.

Operational area

Elevator and ventilation building

In the elevator and ventilation building intake and exhaust air fans will be installed to supply the underground facility. The fans are of the axial type and are mounted, along with their outlet expanders, on steel frames. The intake air side consists of fresh air inlets (louvers), noise suppressers, filters, heating/cooling (dehumidification) batteries, fans and noise suppressers. The exhaust air side consists of fans, noise suppressers and outlet cowls. The heat/cold for the batteries comes from heat pumps in the auxiliary systems building. The heat pumps take their heat from the drainage water, before it is desalinated (if necessary) and released to the receiver. The intake and exhaust air systems incorporate double fans. Each fan is designed for 100 percent of the required flow. One fan runs at a time and the other acts as a spare.

There are also additional fans, for normal ventilation and fire ventilation of the elevator and ventilation shaft.

At times of the year when there is high humidity in the outside air, the heat pumps will be run as chillers, to dehumidify the outside air.

Portal building

In the fan room in the portal building above the mouth of the tunnel in the operational area, there are exhaust air fans, which extract air from the ramp tunnel. The exhaust air is blown via noise suppressers.

Other buildings

The individual buildings in the operational area also have balanced intake and exhaust air systems, designed for the individual needs of each building.

Underground facility

The ventilation system for the underground facility is designed as a balanced intake and exhaust air system. The purpose of the ventilation system is to ventilate out radon, diesel exhaust fumes and explosion gases, and also combustion gasses in the event of a fire. It will also treat the air so as to maintain a good working environment for the staff working in the underground facility. Heat recovery and dehumidification are installed.

The airflow, 90 m³/s in total, has been chosen on the assumption that transport in the underground area is by electrically driven vehicles and that the radon levels in the rock are low. This means that the flow rates might increase if conditions change. For example, two diesel-driven dumpers operating continuously would require the airflow to be increased by 30 m³/s.

The intake air fan supplies a pressure chamber in the ventilation vault in the central area with treated fresh air. The speed of the fan is regulated, so that the flow can be varied to maintain a constant pressure in the pressure chamber. The pressure here will be the same as the atmospheric pressure.

The ventilation vault on the deposition level is divided into two parts, one for intake air fans and one for exhaust air fans. The intake air is taken from the pressure chamber by fans that distribute the air to various vaults and tunnels (the air to certain vaults, such as staff areas and workshops, is postheated when necessary). The spaces are divided into a number of different fire compartments, which are separated by fire dampers to achieve correct ventilation.

The exhaust air is extracted via three different exhaust air systems. In the first system, the exhaust air is sucked from each vault and ducted the suction chamber in the ventilation vault. In an equivalent way to the intake air, a constant pressure is maintained in this system, by the exhaust air fans in the elevator and ventilation building in the operational area. In the second system, the exhaust air is extracted along the ramp tunnel, up to exhaust air fans in a fan room at the mouth of the tunnel. In the third system, the exhaust air is extracted via an exhaust airshaft in deposition area 2. This shaft leads up to a separate ventilation building on the surface.

The deposition tunnels are supplied with air from the main tunnel. A fan blows in intake air via a duct at the innermost end of the tunnel. To maintain the correct relative humidity during deposition, there is a dehumidifier. The fan and dehumidifier with associated ducts are removed when deposition is completed and moved to a new deposition tunnel.

The ramp tunnel has reversible impulse fans in the roof of the tunnel, to provide fire ventilation.

Exhaust air plant

In the fan room in the building over the exhaust airshaft, there are exhaust air fans, which remove air from the deposition area. The exhaust air is blown out above the roof via noise suppressers. There is also an additional fan for fire ventilation of shaft and tunnels.

19. SYSTEMS
19.1 VENTILATION SYSTEM

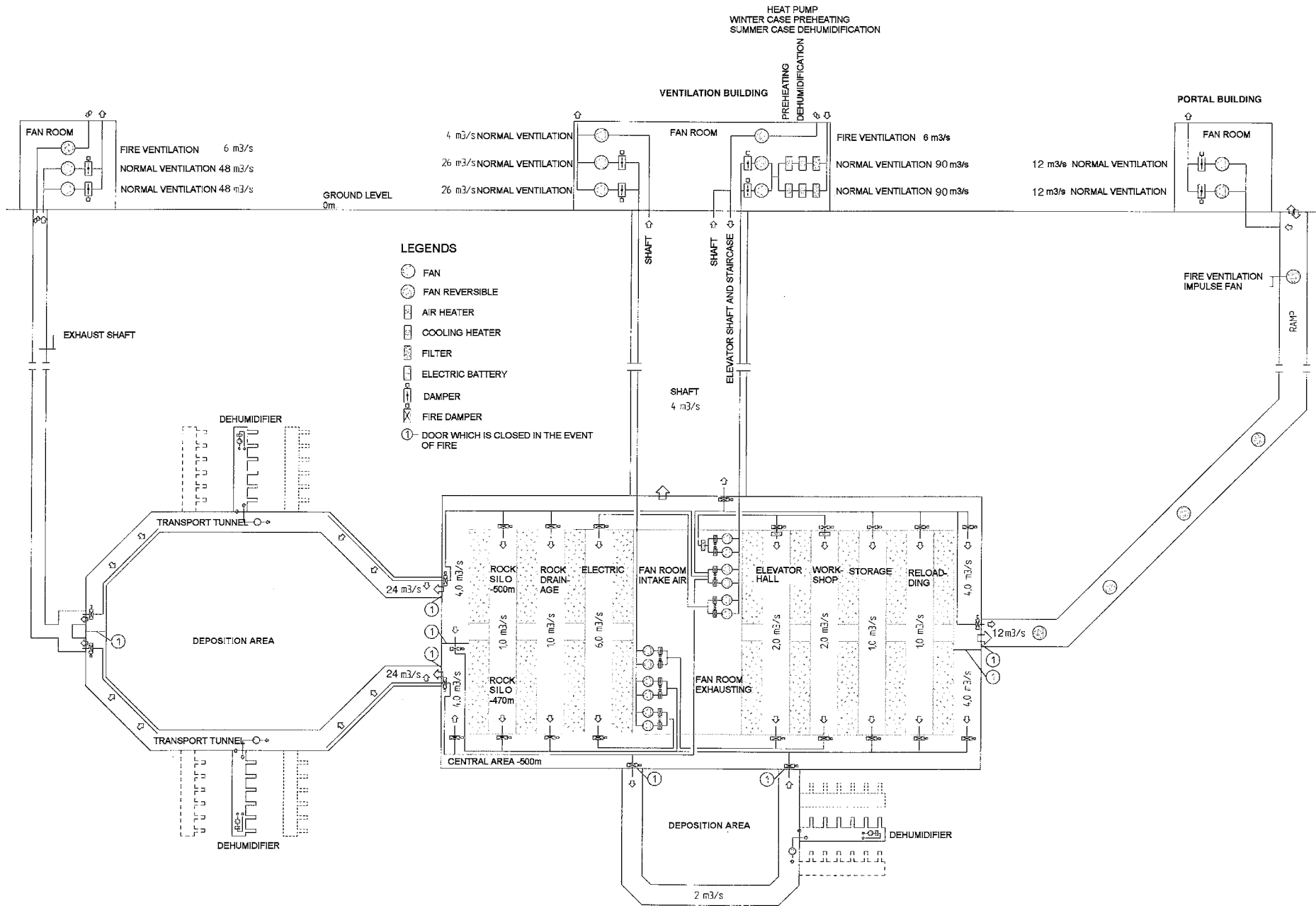

- LEGENDS**
- FAN
 - FAN REVERSIBLE
 - AIR HEATER
 - COOLING HEATER
 - FILTER
 - ELECTRIC BATTERY
 - DAMPER
 - FIRE DAMPER
 - DOOR WHICH IS CLOSED IN THE EVENT OF FIRE

19 SYSTEMS
19.2 REPOSITORY DRAINAGE SYSTEM

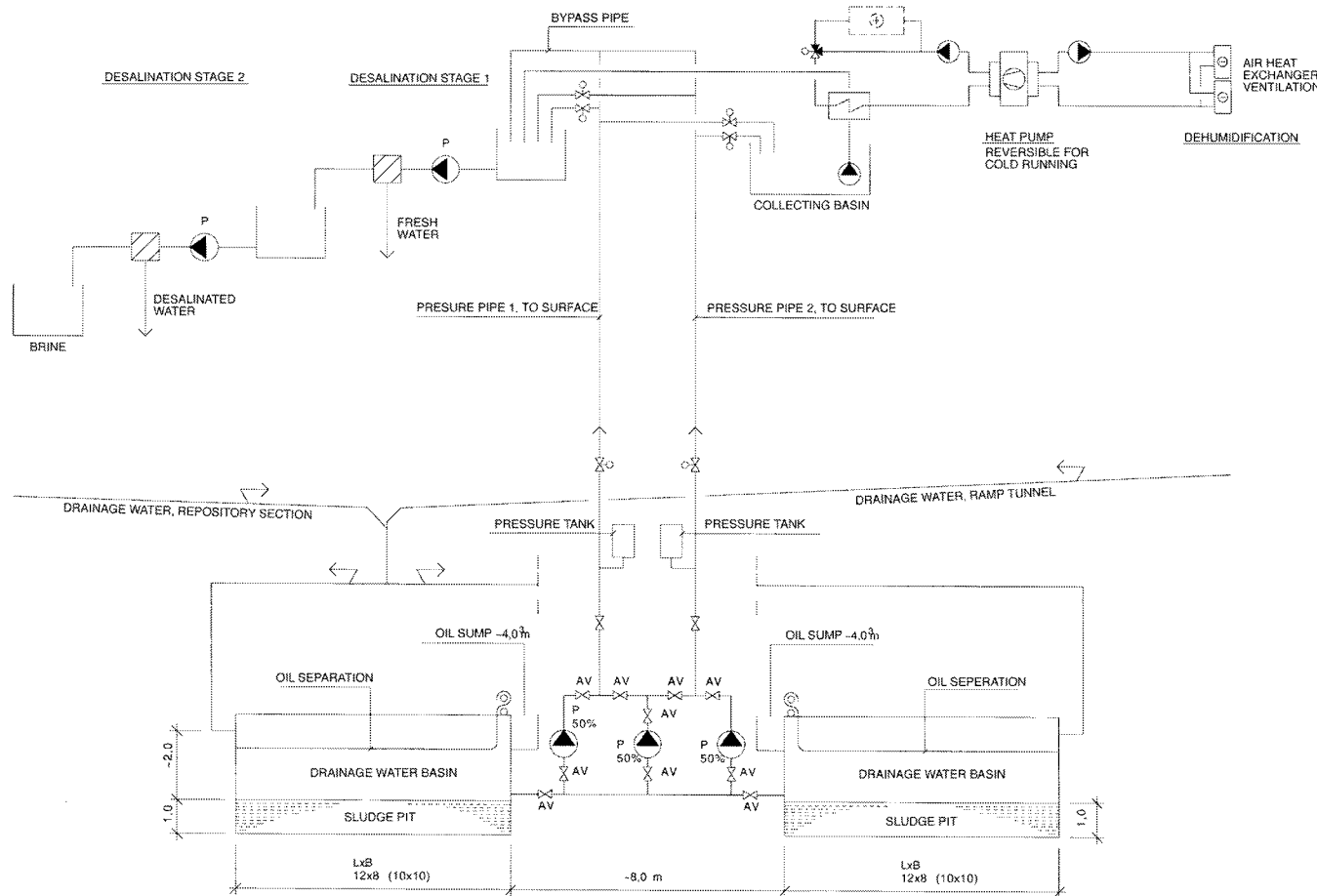

General

Repository drainage water is led away from tunnels and vaults towards a common low point due to the fact that they are excavated with a gradient of 1:100. The water is collected in two basins, where sludge and oil are removed. The structure of the rock could mean that some low points might be formed, which would require there to be small sumps in the repository. The water from these would be pumped to the normal drainage basins.

From the vaults in the central area, the water is led down to the utility tunnel and collected in a sump in the repository drainage vault. From here, the water is pumped up to the repository drainage basins.

Repository drainage vault

In the repository drainage vault, there are three, dry-mounted pumps, which are designed for 3 x 50 % of the flow, approximately 40 l/s. The flow into the basins is designed so that one basin can be emptied of water to remove sludge that has settled on the bottom, while all of the repository drainage water is piped to the other basin.

A surface separator is installed, to collect up any oil leakage. It sweeps over the surface at regular intervals and collects the oil in an oil drum. The drum is then transported to the surface by truck to be dealt with.

The pumps pump up the roughly cleaned water through pipes in the elevator and ventilation shaft to a basin in the auxiliary systems building.

Auxiliary systems building

In the auxiliary systems building, the drainage water flows through two basins. From the first basin, the water is pumped through a heat pump to the second basin. From basin two, the water is pumped through a two-stage desalination plant. The desalinated water is piped to a receiver, and the brine is collected in a tank, for transport to a suitable receiver. The flow can be up to 2 l/s.

Generic design

The installed capacity for the deep repository is estimated at approximately 16 MW, with an effective consumption of approximately 10 MW.

Operational area

The voltage of the external network depends on the location of the facility, but in this description it has been assumed that the facility is supplied with power from the external network via a 130 kV connection in operational area, where the outdoor switchyard is situated. In the electrical building in the operational area, there are switchgear rooms and sub distribution units. Power is supplied to the ramp from a sub distribution unit.

Underground facility

The various parts of the underground facility except for the ramp are supplied from the operational area, via the elevator and ventilation shaft.

All equipment below ground is fed from the electrical building in the electrical power vault.

Electrical power supply to buildings on the surface

On the surface there are the following:

- Operational area including the production building and ramp (installed capacity approx. 6 MW), elevator and ventilation building, shaft and connection to central area of the underground facility (9 MW)
- Exhaust air plant (approx. 230 kW)
- Harbour (approx. 400 kW).

Operational area

The operational area has an electrical building with a 10 kV switchyard. The electrical building is supplied from its own transformer, which is connected to the external network.

In the operational area, 10 kV and 400 V are used. All nearby loads are supplied from electrical building, e.g. the portal building, garage, store and outside lighting.

The production building and the elevator and ventilation building have their own electrical rooms, transformers and low voltage switchgears.

The deep repository is backed up with a stand-by power unit, which will supply high priority loads if there is a loss of supply from the external network. High priority loads are elevators, drainage pumps, the fire protection system and its pumps and fire doors, emergency lighting, supplies to uninterruptible systems etc. According to a very preliminary estimate, the power requirement is approximately 900 kW.

Electrical power supply below ground

The transport route for electric driven vehicles along the ramp is supplied from the electrical building in the operational area. The supply is from a 10 kV cable, which feeds a number of 10/1 kV, 1600 kVA transformers in the ramp. Each transformer feeds a 1 km long section of the collector rail.

The electrical building in the electrical power vault in the central area is supplied from the electrical building in the operational area, via two 10 kV cables installed in the shaft. The electrical building in the operational area and the electrical building in the central area have high priority and low priority busbars.

Three voltage levels are used below ground: 10 kV, 1,000 V and 400 V. The distribution voltage used between high voltage distribution units is 10 kV. The supply voltage to electrically driven vehicles and large machines is 1,000 V. For lighting, power, fixed equipment and small machines, 400V is used.

Each side of the main tunnel has its own electrical substation, approximately 500 metres from the start of the loop.

The machines used in the deposition tunnels are fed from a number of mobile distribution units, housed in small enclosures. The supply to the mobile distribution units is 10 kV, via a rubber cable. The mobile distribution units have:

- high voltage distribution
- 1,000 V / approx. 1,600 kVA and 400 V / approx. 100 kVA dry-insulated transformers
- 400/230V low voltage and 1,000 V distribution, feeding a number of groups.

Exhaust air plant

The ventilation building is supplied via a 10 kV cable from the operational area. It has its own electrical room with transformers and a low voltage switchgear.

Harbour

The harbour has an installed capacity of approximately 400 kW. The supply comes from the general external network, at 10 or 20 kV.

There is a small substation in the area, e.g. a standard, concrete, mini supply station. The substation has a 630 kVA transformer, high voltage switchgear and a basic low voltage switchgear. The substation has a maximum area of 15 m².

Power is supplied via distribution boards in the various buildings.

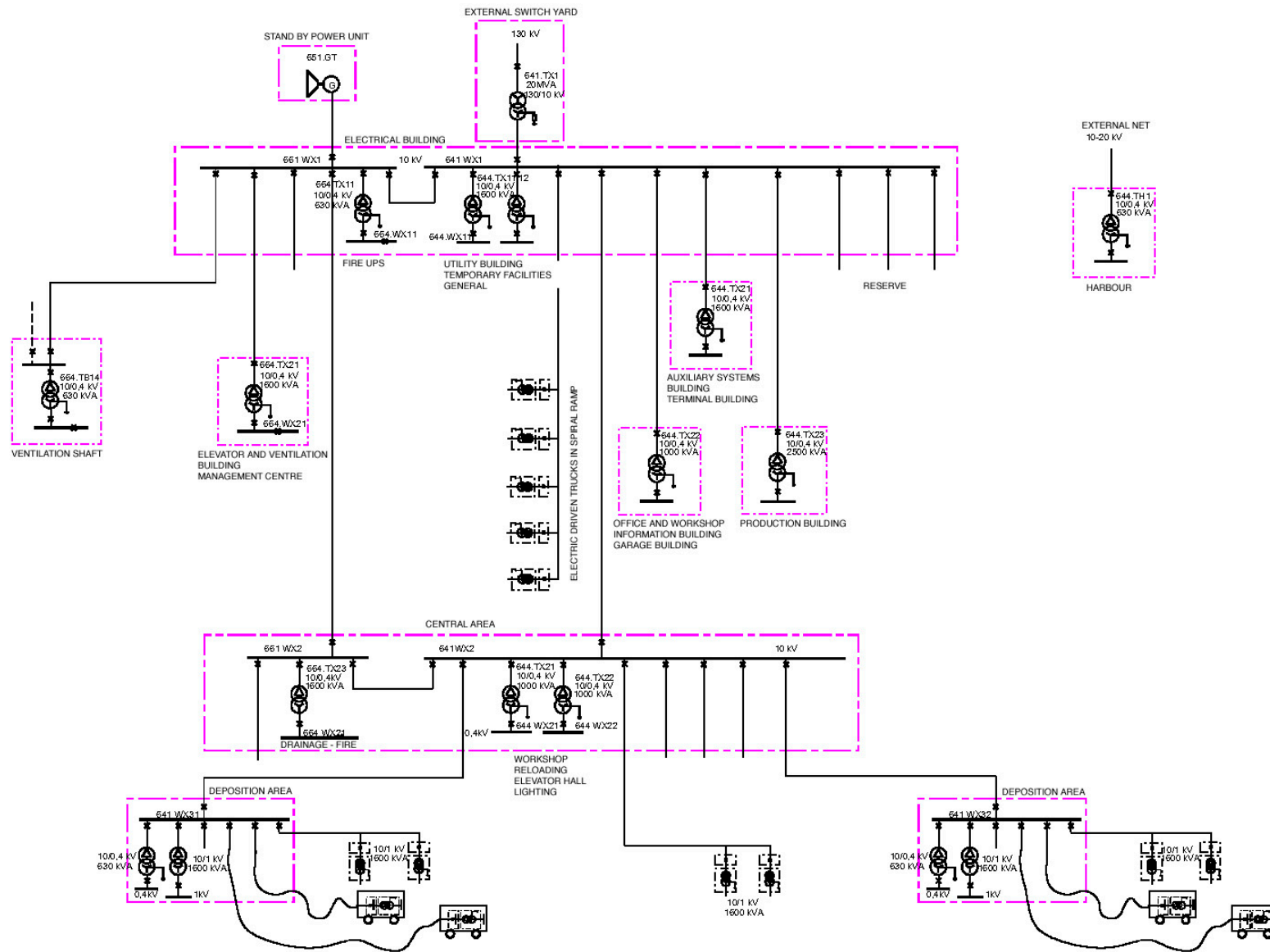

System no. System name**100 Facilities at the deep repository****110 Facility site**

111 Ground work, roads, railway, fences etc.
112 Pipe and cable ducts below ground
113 Railway yard
114 Harbour
116 Rock stockpile
117 Sedimentation basins
118 Removal of surface water
119 Temporary facilities

120 Underground area, central area

121 Reloading station
122 Elevator vault
123 Workshop and store
124 Ventilation vault
125 Electrical power vault
126 Repository drainage vault
127 Vehicle vault
128 Rock roadway with rock hopper

130 Deposition areas, transport tunnels and shafts

131 Deposition area, initial operation
132 Deposition area, regular operation
133 Vacant
134 Transport and main tunnels
135 Ramp
136 Elevator and ventilation shaft
137 Ventilation shaft
138 (Skip shaft)

140 Operational buildings

141 Terminal building
142 Production building
143 Management centre
144 Office and workshop building
145 Portal building
146 Elevator and ventilation building
147 Unloading hopper
148 Reloading hopper

150 Service buildings

151 Utility building
152 Electrical building
153 Auxiliary systems building
154 Information building
155 Garage building
156 Storage building

180 Exhaust air plant

181 Ventilation building

190 Vacant**200 Handling and transport systems****190 Transport casks for canisters etc.**

211 Transport casks for canisters
212 Transport frames
213 Radiation shielding tubes
214 Vacant

220 Transport equipment for canisters and bentonite

221 Deposition machine for canisters
222 Ramp truck
223 Tube truck
224 Bentonite vehicle for ramp transport
225 Bentonite wagon for deposition tunnel

230 Equipment for excavation and backfilling

231 Drilling rigs
232 Rock scaling machine
233 Backfilling machine
234 (Skips)
235 Loaders
236 Rock dumpers

240 Equipment in the central area

241 Reloading equipment for canisters
242 Equipment in central area, elevator vault
243 Equipment in central area, workshop vault
244 Equipment in central area, ventilation vault
245 Equipment in central area, electrical vault
246 Equipment in central area, repository drainage vault
247 Equipment in central area, rock roadway/rock silo
249 Temporary facilities during the detailed investigation phase and the initial operational phase

250 Equipment in operational buildings on the surface

251 Equipment in terminal building
252 Equipment in production building, incl. crushed rock and bentonite store
253 Equipment in management centre
254 Vacant
255 Equipment in portal building
256 Equipment in elevator and ventilation building

260 Equipment in service buildings on the surface

261 Equipment in utility building
262 Equipment in electrical building
263 Equipment in auxiliary systems building
264 Equipment in Information building
265 Vacant
266 Equipment in storage building

270 Equipment outside the operational area

271 Equipment for stockpiling rock
272 Equipment for sedimentation
273 Equipment in the ventilation building for exhaust air

280 Handling systems

281 Other travelling cranes on the surface
282 Other lifting equipment on the surface
283 Other canister deposition equipment
284 Other travelling cranes in the underground area
285 Other lifting equipment in the underground area

300 Process systems**340 Drainage system for the underground area**

342 Pump and drainage system for the underground area
343 Repository drainage water treatment

500 Control equipment**510 General control functions**

511 Equipment in operational centres
515 Control cables

520 Computer system**540 Process control and monitoring**

541 Operation monitoring
542 System monitoring
543 Safety and protection

550 Activity measurement

553 Detection portals
554 Room monitors
556 Dosimeters

600 Electrical power system**610 Electrical supply to the facility**

611 High voltage switchyard
612 Supply cable

640 Ordinary distribution system

641 Ordinary 10 kV network
642 10 kV supply for ramp vehicles
643 Ordinary 1,000 V network
644 Ordinary 400/230 V network

650 Stand-by power system

651 Stand-by power unit
652 Stand-by power distribution system

670 Battery backup system

677 Battery backup network

690 Cables

691 Power cables

700 Service systems**730 Raw water treatment and distribution**

731 Raw water treatment system

740 Air treatment systems

742 Air treatment and distribution for deposition holes
744 Ventilation system for the underground area
745 Ventilation system for the terminal building
746 Ventilation system for production building
747 Ventilation system for other buildings on the surface

750 Gas systems

753 (Compressed air system)

760 Other water and drainage systems

761 Potable water distribution system
762 Heat pump plant
763 Hot water heating system
764 Boiler plant
765 Floor drainage system
766 Wastewater system for the surface area
767 Sewage
768 Surface water system
769 Groundwater system

800 Other systems and equipment**810 Other lifting and transport equipment**

812 Elevators and skips
813 Trains
814 Cars, vans and trucks

820 Fixtures, fittings and tools

819 Laboratory fittings and equipment
823 Equipment in workshops
824 Mobile radiation shields
825 Equipment in offices and staff areas
826 Equipment for collecting and analysing research data

830 Lighting and electrical outlets

831 Indoor lighting
833 Outdoor lighting
834 Lighting below ground
835 Emergency lighting

840 Communication and alarm systems

841 Facility telephone system and intercom
842 National telephone system
843 Alarm system
844 Paging system
845 Loudspeaker system
846 Clock system
848 Radiotelephone system
849 TV surveillance

850 Other communication systems

851 Carrier frequency link
852 Protection against trespassing

860 Fire protection

861 Water for fire fighting
862 Sprinkler system
866 Gas extinguisher system
868 Fire ventilation system
869 Fire alarm system

870 Lightning protection and earthing

871 Lightning protection system
872 External earthing system

- 20.1 General
- 20.2 Starting point for decommissioning
- 20.3 Deposition areas
- 20.4 Central area
- 20.5 Ramp
- 20.6 Restoration - reuse

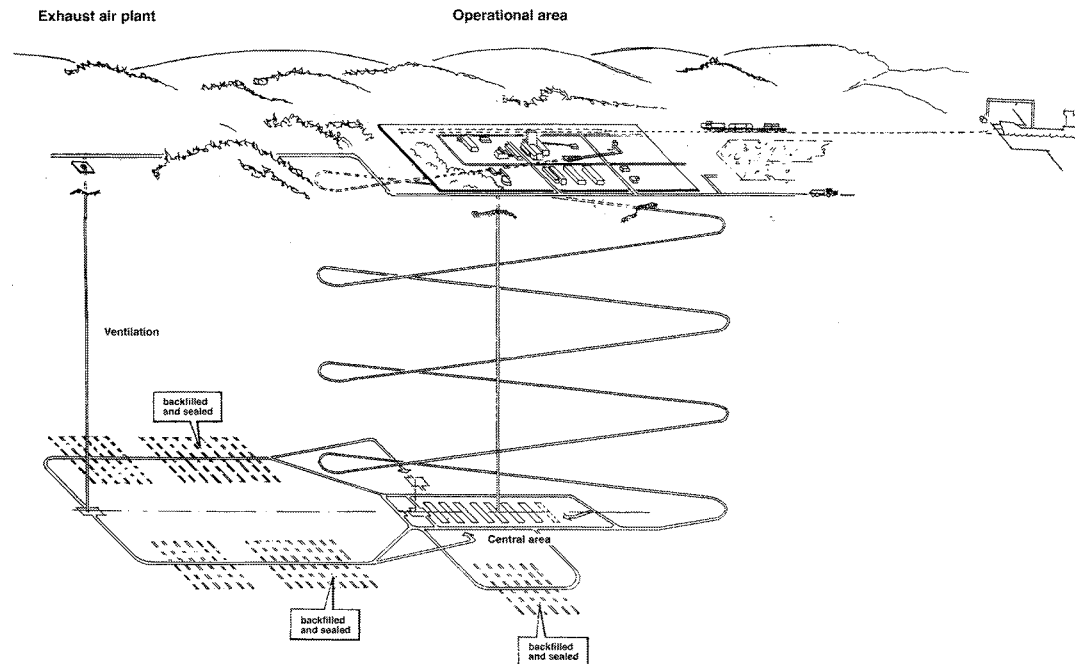

20.1 General

The decommissioning of the operations at the deep repository can begin when all of the spent nuclear fuel has been deposited. Special authorisation will be required for backfilling and sealing the entire facility. The application for such authorisation will include an updated evaluation and analysis of the long-term safety.

In principle, the decommissioning should be carried out in the same way as the development, but in reverse order. When this is being done, installations and auxiliary systems will be used as far as possible. In the final phase of the decommissioning, temporary systems, such as ventilation systems, will be required when the permanent systems are stripped out. As part of the decommissioning, installations and building components will be stripped out and transported up to the surface. The installations are removed to reduce the amount of organic material, metals etc. in the spaces close to the spent nuclear fuel. It is assumed that the backfilling material will be crushed rock with some bentonite mixed in, but the use of plain rock for backfilling is also being investigated.

It is assumed that the same working methods that have been worked out for the deposition tunnels will be used for other tunnels in the facility. The function and design of the plugs mentioned earlier are the subject of investigations in another connection. While awaiting the results of these investigations, a number of plugs have been suggested in the following diagrams. The plugs in the mouths of the ramp and shafts to the surface are intended to make unauthorised access more difficult in the future. The plugs lower down the shafts and on the deposition level are intended to limit the movement of groundwater in the repository.

The strategy outlined above, of withdrawing towards the central area, means that the common service, transport and staff functions can be retained and used for most of the time. When the underground area has been backfilled and the shafts and ramp have been sealed, the purpose of the facility have been achieved. The utilisation of the parts of the facility on the surface will depend on the circumstances and requirements at the particular time.

20.2 Starting point for decommissioning

The following conditions apply:

- Deposition of canisters has been completed.
- All deposition tunnels for canisters have been backfilled and sealed.
- All transport facilities and transport routes outside the deposition tunnels are still fully accessible.
- All utility systems are operating.

The entire area above ground is fully accessible.

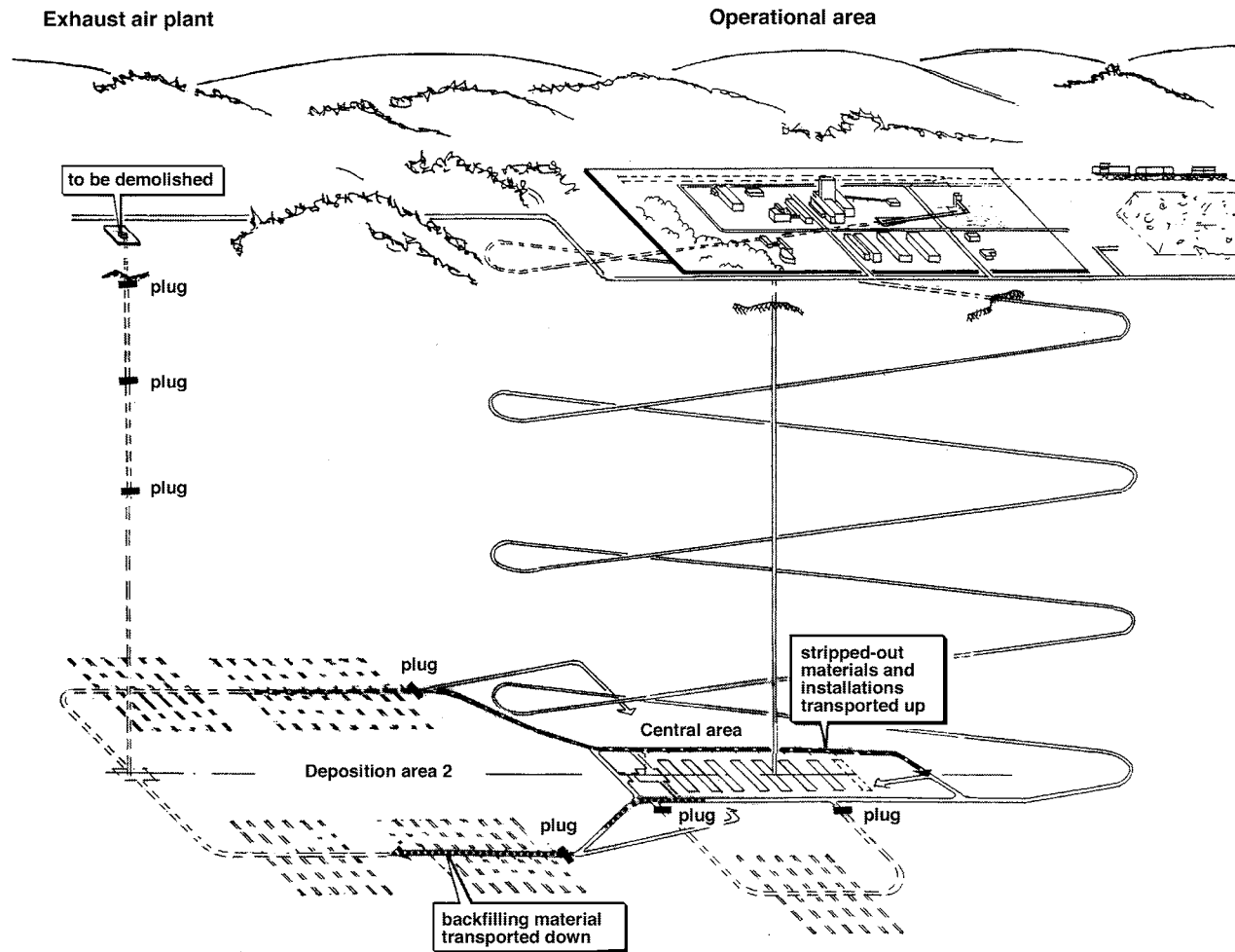

It is assumed that the decommissioning will begin with the following measures:

- Backfilling of operational roadway 1.
- Backfilling of operational roadway 2A from the exhaust airshaft at the far end of deposition area 2 to the third transverse roadway.
- Backfilling of operational roadway 2B, starting at the exhaust airshaft. As this is done, the exhaust airshaft up to the surface is backfilled, plugged at various levels where necessary, and sealed with a concrete plug at ground level.
- Demolition of the ventilation building on the surface, and restoration of the land.
- As this part of the exhaust air system is being disconnected, all exhaust air from the remaining areas is evacuated via the ramp.
- As the operational roadways are being backfilled, installations and building materials are removed and transported up to the surface.

20. DECOMMISSIONING
20.4 CENTRAL AREA

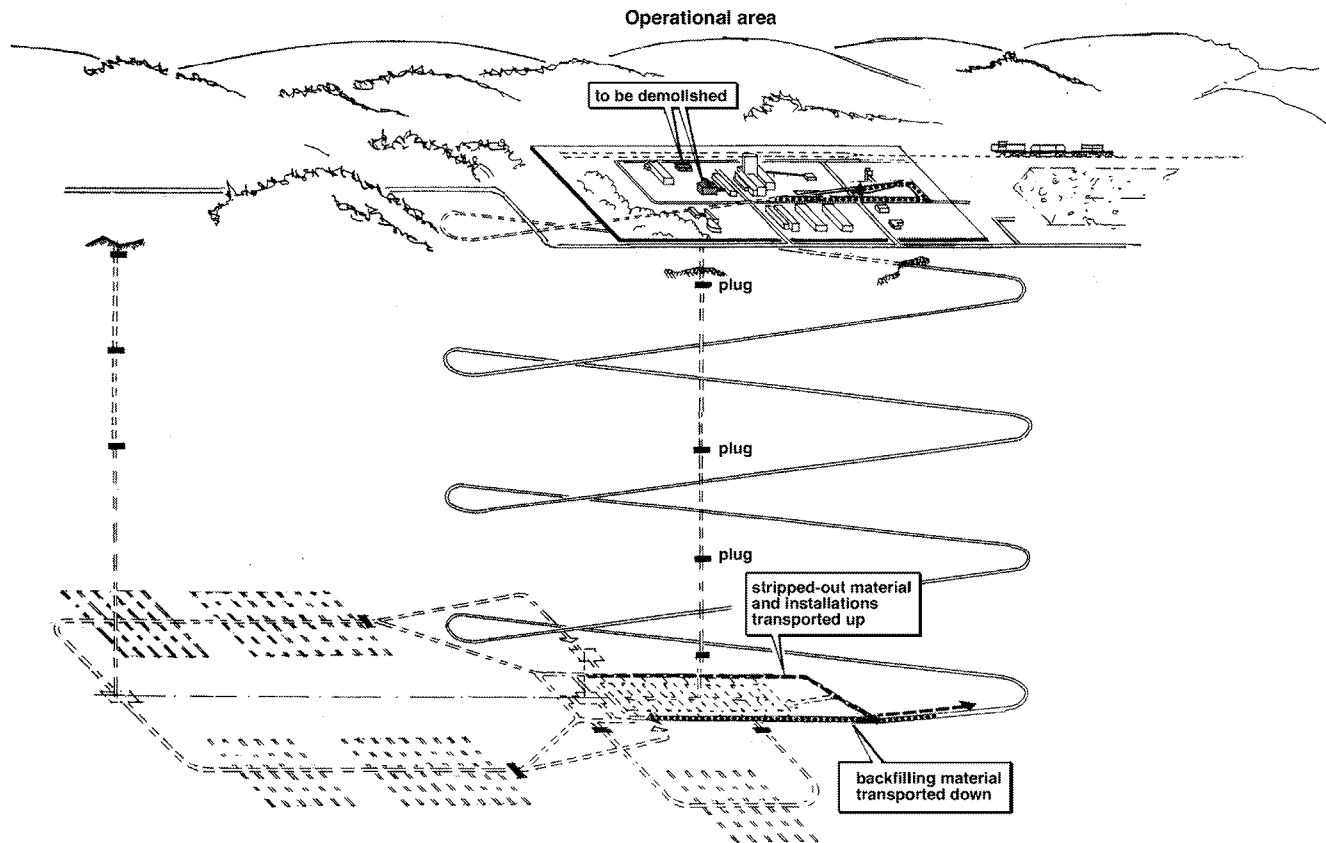

- Backfilling of all spaces in the central area, starting with the rock silo, the rock roadway and third transverse roadway.
- Setting up of temporary facilities for power supply, ventilation and repository drainage as the ordinary systems are disconnected.
- Removal of elevators and other installations in the shaft as the backfilling proceeds.
- Backfilling of roadways A and B, starting at the third transverse roadway and continuing to the ramp. Simultaneous gradual backfilling of all vaults in the central area.
- Demolition of the elevator and ventilation building and the auxiliary systems buildings in the operational area. Other buildings can be used for other activities if desired.

Operational area

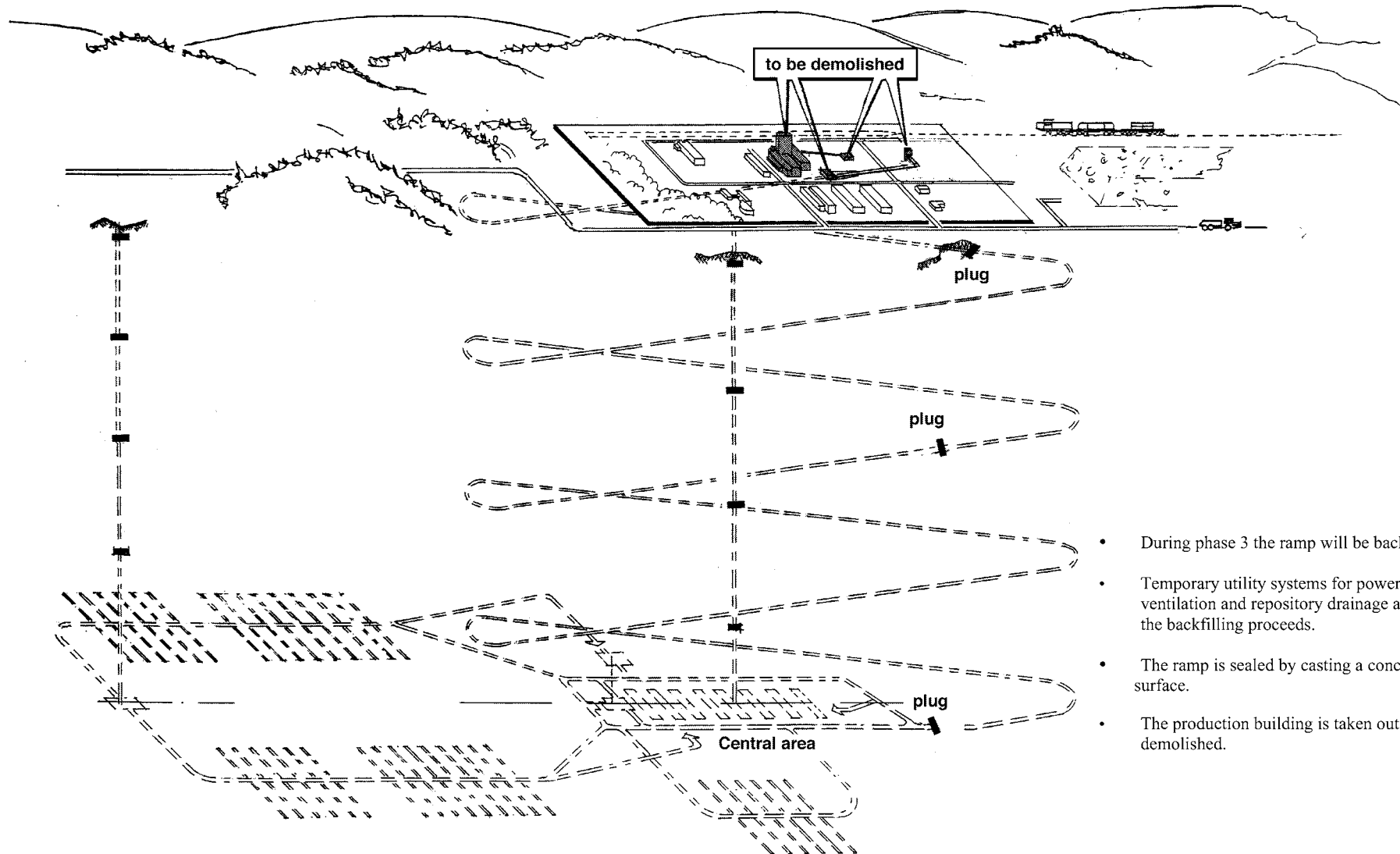

- During phase 3 the ramp will be backfilled.
- Temporary utility systems for power, lighting, ventilation and repository drainage are stripped out as the backfilling proceeds.
- The ramp is sealed by casting a concrete plug near surface.
- The production building is taken out of operation and demolished.

20. DECOMMISSIONING
20.6 RESTORATION - REUSE

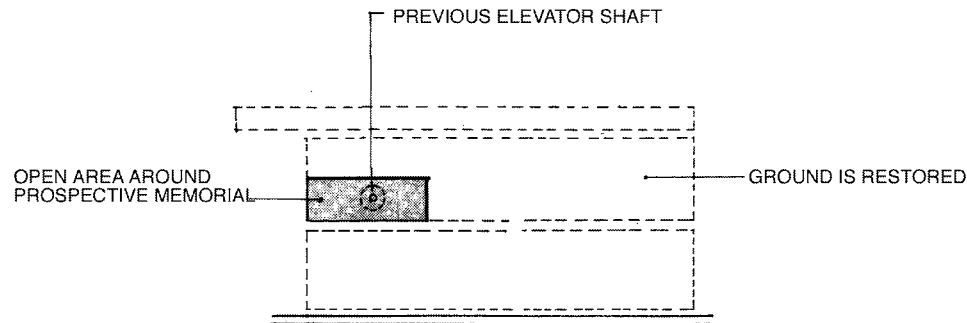

**OPERATIONAL AREA
 DECOMMISSIONING, ALTERNATIVE 1**

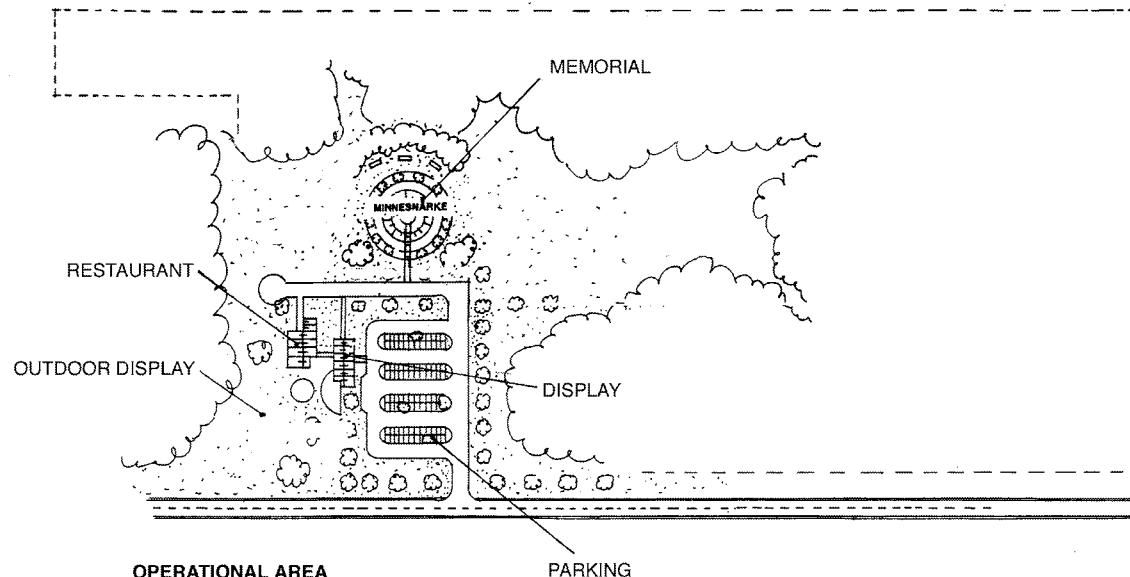

**OPERATIONAL AREA
 DECOMMISSIONING, ALTERNATIVE 2**

General

When the underground area has been backfilled and the shafts and ramp sealed, the project is completed. The remaining treatment of the parts of the facility on the surface depends on the circumstances and requirements that apply at the particular time. However, three main alternatives are envisaged, as follows.

Alternative 1

All buildings and other facilities should be demolished. This should be followed by ground treatment, designed to restore the site to more or less its original condition. Some sort of landmark should be placed on the surface, as a reminder of the existence of the underground facility.

Alternative 2

The operational area should be converted into a tourist attraction, where the visitors are reminded of the existence of the deep repository and can obtain information about the historical background.

All buildings will be demolished, with the exception of the information building. The entrance parking area and the main road through the site, Industry road, would be retained. The railway yard would be cleared, all other roads stripped out and the ground restored to more or less its original topography. Some sort of landmark should be erected at the point where the shaft was located. Suitable planted areas should be established. The final result would resemble the way old military sites now look in many places around the country. See the figure to the left.

The exhaust air plant is demolished. The ground will be restored to more or less original condition.

Alternative 3

The operational area will have been well established for 40 years. The area will have infrastructure and buildings of a general nature. Once the buildings that were specifically designed for the previous operations were demolished, this would be an excellent site for new enterprises in the area. Those parts of facility on the surface that can be used for other purposes, such as light industry, will be retained. Other parts will be demolished and new buildings will be constructed in the area, if required. By doing this, it will be possible to utilise the infrastructure, buildings, roads etc. that have been constructed, and which can be easily adapted for other activities.

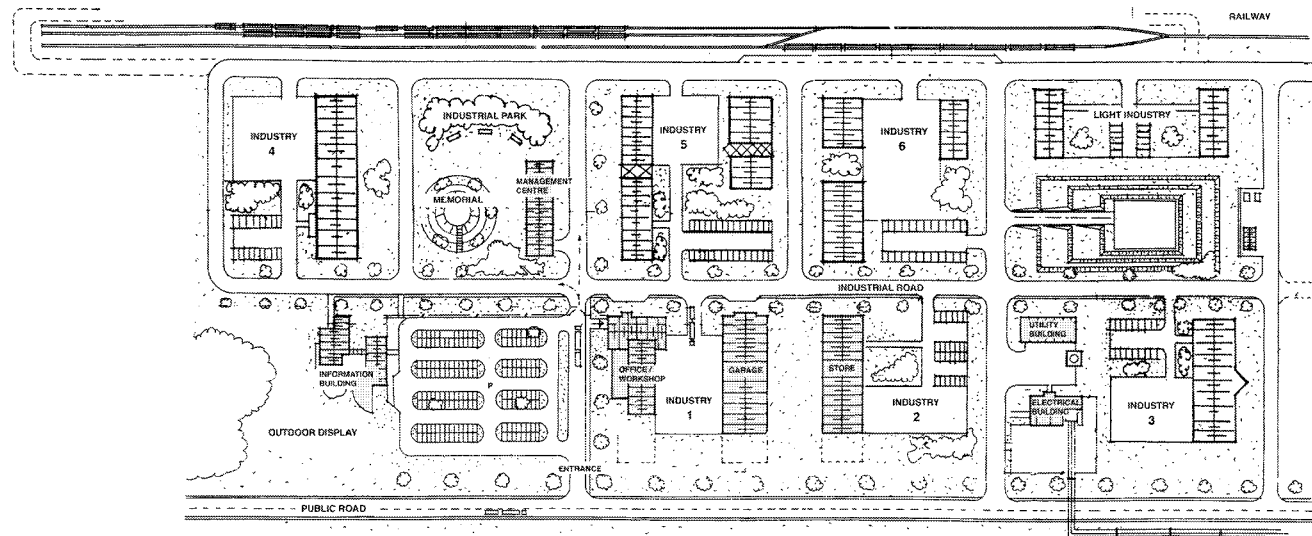

OPERATIONAL AREA
DECOMMISSIONING, ALTERNATIVE 3 [Hatched Box] = REUSED BUILDINGS

Alternative 3 (cont.)

Reuse - General

The infrastructure in the facility that has residual value, and which it should be possible to reuse, consists of:

- A site road with asphalted yards, parking areas, plantings and a number of function-neutral buildings.
- A utility building with water, heating and sewerage systems and a switchyard.
- An information building with adjoining restaurant.

Buildings and/or parts of buildings with functions designed for the underground facility will be demolished.

Reuse of the operational area

The proposal shows an industrial estate for small-scale industries, where some buildings, principally within the previous service area, are retained. Buildings around the ramp, such as the portal building, terminal building, production building and elevator/ventilation building have been demolished. The area has instead been supplemented with a number of industrial buildings.

This proposal assumes that the remaining buildings will be put to the following uses.

- The information building could continue be used for exhibition purposes. For example, the products and services of the businesses could be displayed here. This building could also act as a common conference and meeting building, which could be booked when required. The restaurant could be used for visitors and the employees of the businesses.
- The office and workshop building could be used for light industry.
- The electrical and utility building will continue to supply the area with electricity, water, heating etc.
- The storage and garage buildings are of a standard design, and could be used as they are for a number of purposes.
- The rail link expands the future possibilities of the site.

The above figure shows how the operational area might look after a transformation to other activities.

Exhaust air plant

The site is not suitable for reuse when deposition ends and the deep repository will be decommissioned. The ventilation building will be demolished and the land will be restored to its original condition.

21.1 Architectural objectives

21.2 Examples

21

VISIONS

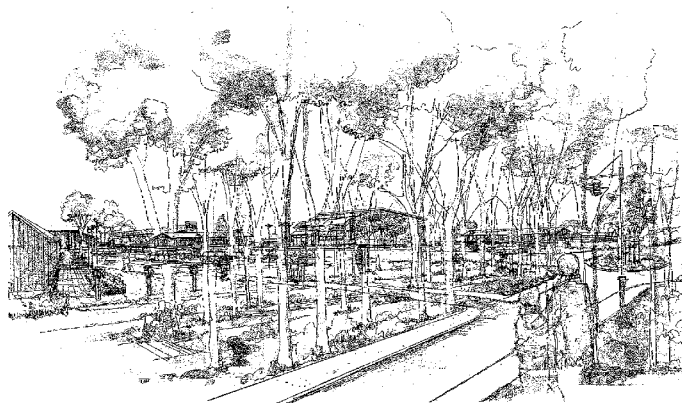

General

The operations in the deep repository are divided into a number of operational areas, which are spatially separated and of a variety of types, depending on the work carried out there. In terms of how they are perceived, it is possible to differentiate between the following units.

- Receiving harbour
- Operational area above ground
- Exhaust air plant
- Underground area
- Rock stockpile

The **receiving harbour** will probably be part of, or an extension of, an existing harbour, so its design is determined primarily by the circumstances that exist there.

The **operational area** is the part of the facility that is more or less comparable to conventional industrial installations. As the location of the operational area is determined by the design of the underground area, one cannot disregard the fact that this sub-area could be located in an environmentally sensitive area. It is therefore important to exercise special care with the design and placement of this unit in the landscape.

The **underground area** has special requirements, as the geological conditions play an enormous role in determining the design. The operations on the -500 metre level will be a permanent workplace for almost half a century, which is why the working environment should not be treated as a conventional mining worksite. Apart from excavation, the work is normally not as heavy as in the case of mining operations

The **exhaust air plant** consists of a single building, which will be specially designed to fit into the surrounding landscape.

The **rock stockpile** is temporary, but will still dominate the surrounding area for almost half a century. Even though the rock will be kept free of vegetation as far as possible, the stockpile must be designed such that the view of the landscape is not marred more than is absolutely necessary. The rock stockpile will be designed such that the habitats of the surrounding flora and fauna are not harmed. As the rock repository is only temporary, it is important that a plan be drawn up during the operational phase, so that, after the stockpile is decommissioned, the landscape can regain its original character.

Whichever sub-function is involved, there will be a common denominator in the design of the various parts of the facility, demonstrating that each unit is a sub-function in an overall complete solution.

As has been pointed out, the surface area of the deep repository is similar to a conventional industrial operation. SKB's facility will meet high environmental standards, with environment viewed in its broader sense. This means that we will not merely consider quantifiable values, but must also consider how the facility staff and the local community feel about various issues.

The design of an industrial installation is controlled primarily by the technical requirement, but its appearance is the business card the company presents to the outside world. The deep repository will reflect the optimal way to use new technology, where processes, buildings, form, materials and people are woven together into an efficient, complete solution. The integration into the community will be done so as to cause as little disruption as possible for those living in the surrounding area.

21. VISIONS 21.1 ARCHITECTURAL OBJECTIVES

A new industrial facility can, correctly implemented, bring with it considerable value for those living in the surrounding area, as long as the distinctive features of the area are considered and preserved, and the facility is designed in line with the long-term development plans of the chosen municipality. Experience from SFR (Repository for medium- and low-level waste) shows that the deep repository will attract a large number of visitors, who's positive or negative impressions will be a testimonial, not just for the facility, but also the surrounding area.

External environment

When assessing the appearance of industrial facilities, one normally speaks of three levels of experience, i.e. long-distance impression, close-up impression and the impression created by details.

The **long-distance impression** affects mainly those outside the site, and is a silhouette, which can be seen either as positive and exiting or as negative and terrifying. Industrial facilities often become landmarks and consequently a distinguishing feature for the area, in either positive or negative sense.

Greenfield facilities place great demands on landscape adaptation, in which surface blasting, clear felling and other dramatic alterations to the landscape should be avoided. Landscape architects should be consulted, so that any encroachment into the surrounding area is done in a considerate way, and the habitats of the surrounding flora and fauna are not altered. The facility will not dominate the landscape, but instead be a part of it, with the buildings grouped in an orderly fashion. Outside lighting is important for the long-distance impression. Although many industries are bathed in light at night, this is rarely necessary.

From a close-up impression, it is possible to get an overall view of the facility, with the shape, grouping, colour and materials of the different buildings, from this distance one can really "experience" the facility.

If possible, the site plan should place the various functions in different areas, to provide flexibility, create fire zones, and facilitate maintenance. Complex solutions lead to complex buildings and high costs.

Common levels, that connect different buildings, can be rooflines, skirtings etc. or uniformity in frequently occurring parts such as doors, windows, steel frames or corner details. Doors, windows and ventilation openings are combined in bands or recesses, which form design elements in the façade. Expected life, reusability and demolition costs should be considered when choosing materials and construction methods. Low investment costs often result in high operating and maintenance costs. Large buildings will get a light colour, so they don't have an undesirably dominant influence in the surrounding area, especially in the winter. All extensions in the form of projections and attachments should be avoided. Components that cannot be harmoniously co-ordinated into the overall picture should be intentionally emphasised with contrasting shapes and colours. Tanks and cisterns are arranged in groups, and are matched in shape and colour with one another.

The impression created by details is often the most overlooked, but perhaps the most important, element of design, the thing that determines the character of the facility. Details should be on a human scale, so they are easy to perceive. Rusty ventilation louvers on a light façade are just as irritating as stainless steel troughs instead of porcelain washbasins in washrooms. It is the details that the individual notices. Thoughtful detailed planning can make things easier when it comes to the building process. Uniformity in balustrades, handrails and door cornices gives a sober impression and reduces building costs.

Lighting and signs also contribute greatly to the overall impression. Excessive corporate signs that encroach on the surrounding area is negative for the facility, causes irritation and gives the wrong message. The machines and vehicles in the facility are also part of the impression given by details. Uniform colour and good maintenance convey the message that the facility itself is well organised on a smaller scale, as well, behind the façades.

Inside environment

The inside environment of the facility is principally controlled by the technical requirements. In industrial buildings, one usually differentiates between three categories of premises, i.e. premises with activities that are dirty and take up a lot of space, technical premises and staff premises. Each category has its special demands on

Materials, design and ease of maintenance. Whatever the category, a good environment should always be the goal. Well-sized, horizontal passageways will link the main vertical communication routes. They will make easy for staff to find their way around. Frequent outlook points will provide daylight and make orientation even easier. Stairs will have a comfortable step height and, as with the elevators, will be large enough for carrying a stretcher. The access requirements of handicapped people will be considered wherever possible. Noise protected zones are created where staff regularly work. Changing rooms with wet areas will always be of a high standard, and break rooms etc. will be designed in a "softer" way, preferably with elements of textiles and natural materials. The colours used will be simple and restrained, but effective. A colour scheme is produced at an early stage, so that the standard colour of the technical components does not decide the standard for the inside environment.

Site layout

The site layout is very important for the overall impression. The central axis of the facility is formed by the main road, which will have separate pedestrian and vehicle lanes. The road system will be differentiated from surrounding yards and open areas, e.g. by a row of concrete slabs.

The entrance zone is the facility's face to the outside world. It should be designed so that it gives a representative and pleasing impression, but also overcomes the traffic problems. A constantly recurring problem is that parking areas and bicycle stands are put in afterwards, as an afterthought. These should be considered from the beginning.

An industrial fence is a legal boundary, which should not be constructed so that it prevents people from looking in. The higher the walls and the stronger the doors, the more interesting the area will be to unwanted visitors. The land inside the industrial fence will have simple, large-scale plantings, which require little maintenance. Small-scale garden beds would sooner or later become neglected. In principle, no more area than is absolutely necessary should be asphalted. Asphalted areas become storage areas, whether or not they are needed. The interplay between gravelled areas and asphalt is an attractive design element.

21. VISIONS

21.1 ARCHITECTURAL OBJECTIVES

One specific problem is the rock that will be brought to the surface when the deep repository is being excavated. It is important to have a solution right from the start.

The design of the **underground area** is controlled by the geological conditions and the technical systems that are required to operate the facility. The primary objective is to create the best possible environment, in terms of safety, ventilation and lighting. Places where staff spend most time, such as the workshop vault, elevator vault and reloading station, should be designed with special care and fitted with a suspended ceiling and colour-co-ordinated lighting. Enclosures, dividing walls and doors will be of a uniform design and a light colour, which contrasts with the surrounding rock or its covering. The signs should be uniform and relevant throughout the facility.

In places with occasionally high work intensity, such as the deposition tunnels during excavation and the deposition and backfilling phases, mobile rescue chambers and toilets will be set up. The care and maintenance of these is an important part of the working environment.

Where tunnels with frequent traffic meet, the light level should be increased to raise attentiveness. Any bentonite that is dropped in central area and on roadways should be removed. Boot washing facilities should be arranged at the entrances to the vaults, as necessary. A detailed action plan for the environment in the underground area can be drawn up when the final site has been chosen.

Other

The architectural objectives for the deep repository will be simplicity, consistency and adaptation to local circumstances. The aim is to use today's technology to create tomorrow's "good" workplace, which will have a high technological standard but will always be based on human needs. This is not synonymous with exclusive materials and high costs, but rather with deliberate and dedicated planning, in which everyone is involved and responsible for a good final product.

Fritz Lange, architect SAR

21. VISIONS
21.2 EXAMPLES

The Älvkarleby/Tierp alternative assumes that the receiving harbour is in Skutskär, from where a railway line leads to operational area 1, close to a nearby community. Operational area 1 has, with only marginal alterations, the same layout as in the generic solution. From operational area 1, a ramp leads to the -500 metre level, at a point where the geological conditions are good.

The other locations assume that there will be a small operational area 2 above the central area of the underground facility. As operational area 1 is close to an existing community, it is assumed that electricity water and sewerage will be connected to the existing infrastructure in the community.

However, if the “good rock” is found in a place where the overlying landscape does not prevent large-scale development, it is, of course, an advantage if operational areas 1 and 2 are combined into a single unit, perhaps with a spiral ramp leading down to the deposition level. The advantage of having only one operational area is obvious, even if it means a longer access road and, Presumably, little reuse value for the buildings remaining after decommissioning. In this case, the deep repository will become an enclave in an undisturbed landscape, without any natural contact with existing communities. This variant, the so-called “spiral solution,” is dealt with in a separate report.

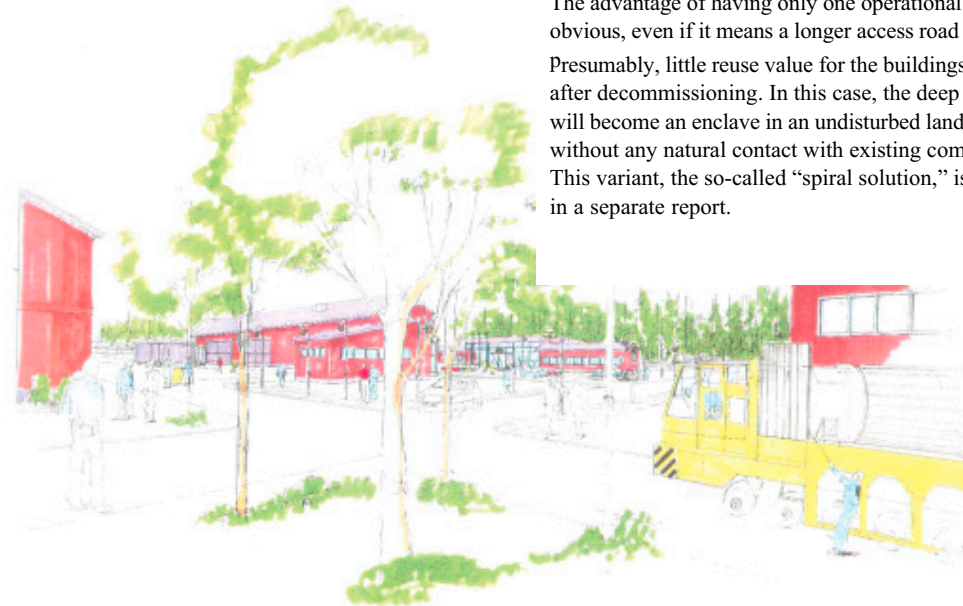
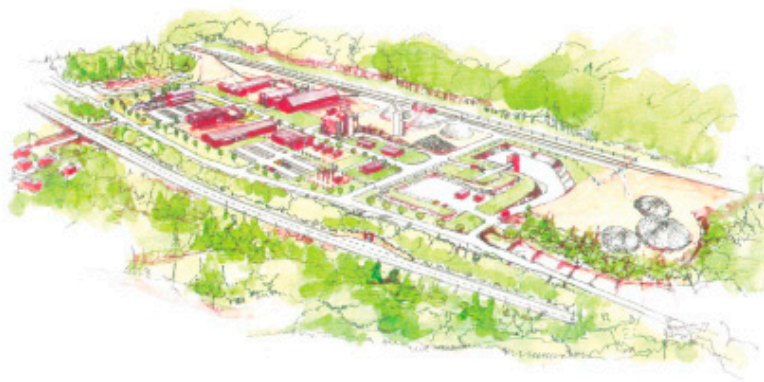

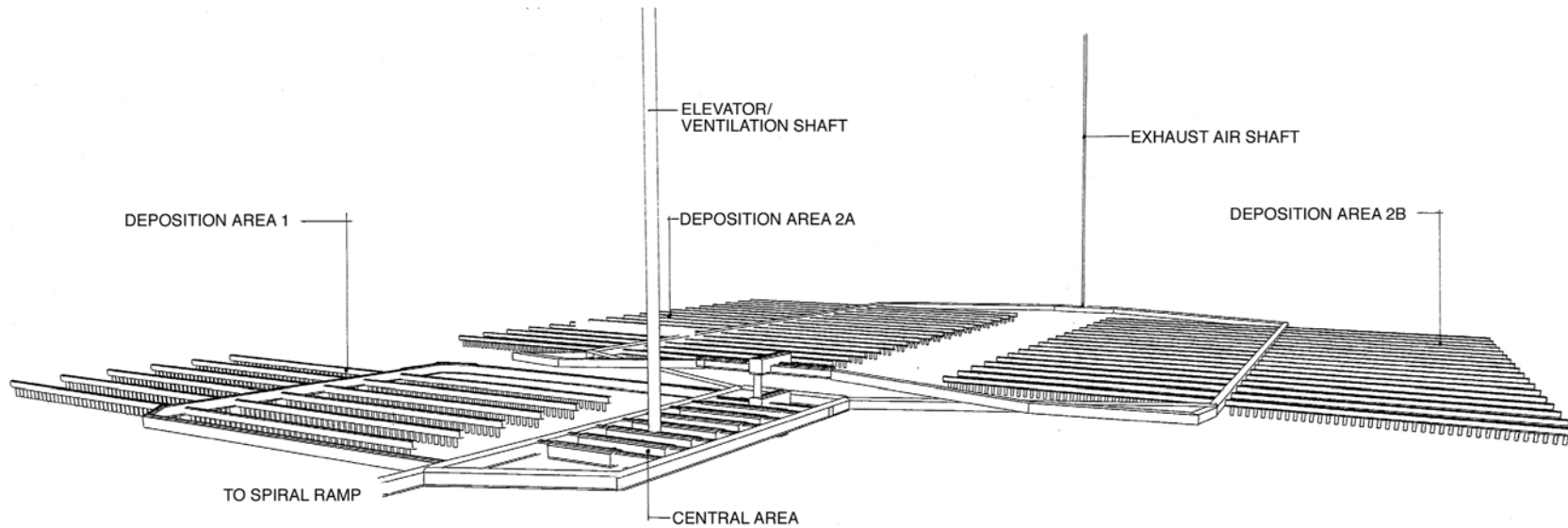

OVERVIEW OF THE UNDERGROUND AREA

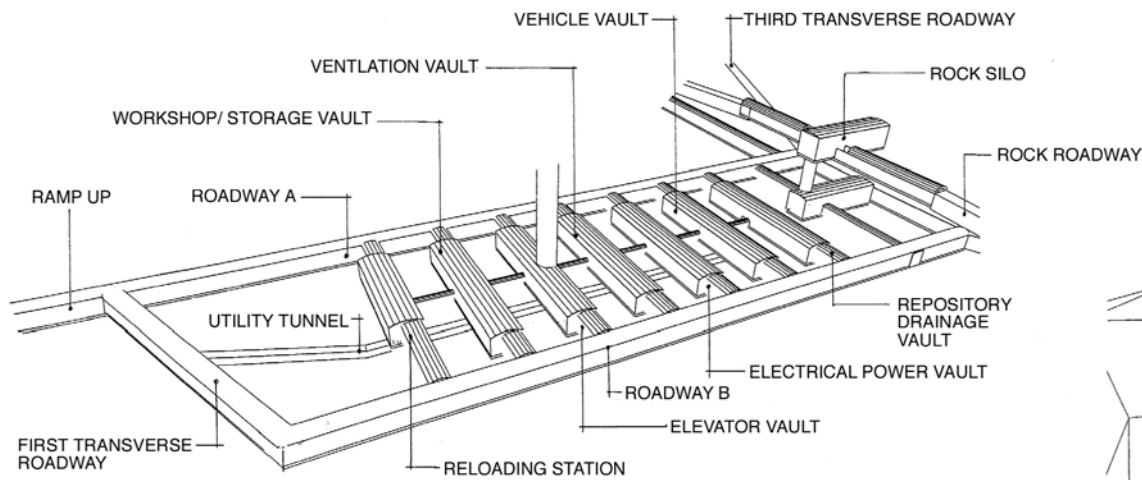

OVERVIEW OF THE CENTRAL AREA

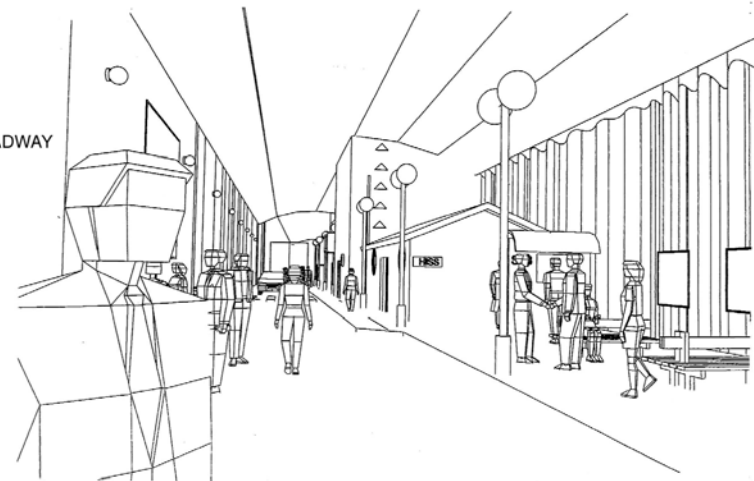

VIEW OF THE ELEVATOR VAULT

21. VISIONS
21.2 EXAMPLES



Cad view of operational area from rock stockpile direction

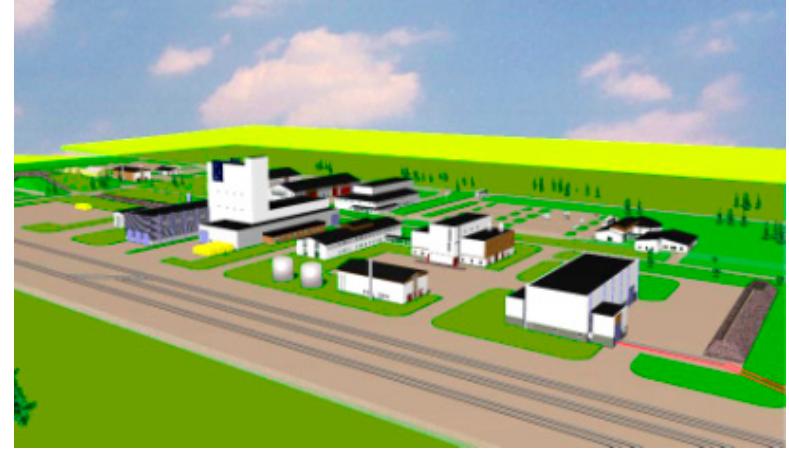

Cad view of operational area from railway yard

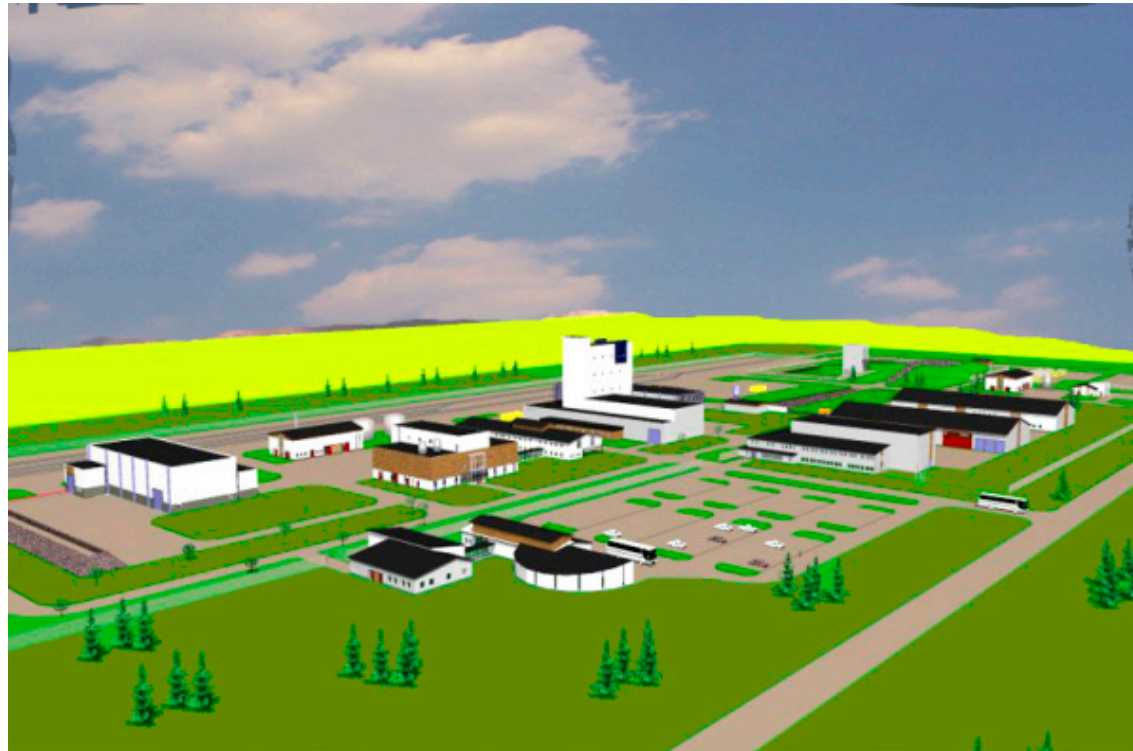

Cad view of operational area from front side

22. PRINCIPAL DATA FOR THE FACILITY

General data for the repository

Deposition depth	500	m
Number of repository levels	1	
Number of deposition areas	2	
Deposition area for initial operation	Separate area	
Number of operational areas on the surface	1	
Connection between surface and deposition level	Ramp and shaft	
Power for vehicles and machines	Predominantly electric	
Roadway in deposition tunnels	Macadam	
Assumed water leakage for the entire repository	40	l/s
Electricity supply:		
Number of connections to external grid	1	
Voltage	130	kV
Local auxiliary power source, diesel/gas turbine	1 unit	
Rated output (diesel)	1,000	kW

Tunnels, general

Tunnelling technique	Blasting	
----------------------	----------	--

Tunnels for depositing canisters

Height, approx.	5.5	m
Width, approx.	5.5	m
Length, approx.	265	m
Number of tunnels for regular operation	110	
Number of tunnels for initial operation	12	
Centre to centre distance between deposition tunnels	40	m
Volume per tunnel, approx.	8,000	m ³
Total tunnel volume	936,000	m ³

Deposition holes

Material in bottom screeding	Concrete	
Centre to centre distance between deposition holes	6	m
Positions for deposition holes/tunnel	40	
Canisters deposited per tunnel, approx.	37	
(Positions not suitable per tunnel)	3)	
Depth of deposition hole	8	m
Diameter of deposition hole	1.75	m
Total volume of holes	94,000	m ³

Buffer

The canisters are surrounded in the deposition holes by a buffer of bentonite.

The thickness of the buffer after saturation with water:

Radial	0.35	m
Bottom	0.5	m

The buffer is made of bentonite blocks with the following data:

Outside diameter	1.65	m
Inside diameter of ring blocks	1.07	m
Total height of ring blocks	4.8	m
Thickness of bottom block	0.5	m
Thickness of block above canister	1.5	m
Density of block	2.1	kg/dm ³

Backfilling material for deposition tunnels

The backfilling material is prepared from bentonite and crushed rock. The crushed rock is produced from excavated rock. The bentonite is transported to the facility by ship/train and is then ground.

Bentonite/crushed rock mix ratio 15/85 % by weight

Successive backfilling. Tunnel is sealed with a concrete plug.

Transport tunnels

Height, approx.	7	m
Width, approx.	7	m
Length, approx.	3,900	m
Volume, approx.	166,000	m ³

Main tunnels

Height, approx.	7	m
Width, approx.	10	m
Length, approx.	2,500	m
Volume, approx.	164,000	m ³

Vaults in the central area

Number	7	
Length, approx.	52/66	m
Volume	67,000	m ³

Transport ramp between the surface and the underground area

Height, approx.	7	m
Width, approx.	7	m
Length, approx.	5,400	m
Gradient, average	1:10	
Volume, approx.	261,000	m ³

Backfilling material. Main and transport tunnels

The material can deviate from that in the deposition tunnels. Backfilling is done when all deposition is finished.

Shafts

Diameter of elevator shaft	8.5	m
Diameter of ventilation shaft	3	m
Volume	33,000	m ³

Other spaces below ground

Total volume	12,000	m ³
--------------	--------	----------------

Total volumes of rock

Total volume of solid rock excavated, approx.	1,700,000	m ³
Equivalent volume of loose rock, approx.	3,100,000	m ³

General

1. **SKB**
R&D-programme 98
Treatment and final disposal of nuclear waste.
Programme for research, development and
demonstration of encapsulation and geological
disposal.
September 1998
2. **SKB**
Systemanalys - Omhändertagande av använt kärn-
bränsle enligt KBS-3-metoden
SKB R-00-29. Oktober 2000.
3. **SKB**
Plan 2000. Kostnader för kärnkraftens radioaktiva
restprodukter.
SKB. 2000.
4. **SKB**
Thechnical Report TR-01-03
Integrated account of metod, site selection and
programme prior to the site investigation phase.
December 2000
5. **SKB**
Rapport R-01-57.
Anläggningsbeskrivning - Layout E. Rak ramp med
två driftområden.
December 2001.
6. **SKB**
Rapport R-02-19.
Anläggningsbeskrivning - Layout E. Schaktalternativ.
Mars 2002

Chapter 1

7. **SKB**
Förstudie Oskarshamn R-98-47.
Anläggningsutformning, bemanning och transportmäs-
siga förutsättningar. Oktober 1998.
8. **SKB**
Förstudie Oskarshamn R-99-10
Inlandsläge - disponering av industrianläggningen,
transportmässiga förhållanden, markanvändning och
miljöaspekter. Maj 1999.
9. **SKB**
Förstudie Tierp R-99-60
Anläggningar och transporter. November 1999.
10. **SKB**
Förstudie Hultsfred R-00-05
Anläggningar och transporter. Februari 2000.
11. **SKB**
Förstudie Älvkarleby R-00-13.
Anläggningar och transporter. Februari 2000.

12. **SKB**

Avfall, försvarsutformning och platser.
Underlagsrapport till SR-97 .
SKB. Oktober 1999.

13. **SKB**

Geovetenskapligt inriktat program för undersökning
och utvärdering av platser för djupförvaret.
SKB R-00-30. SKB. 2000.

Chapter 2, 6, 1314. **SKB**

Säkerheten vid drift av djupförvaret.
SKB. R-98-13. Oktober 1998.

Chapter 415. **SKB**

Säkerheten vid transport av inkapslat bränsle
SKB. R-98-14. September 1998.

1. INTRODUCTION
 - 1.1 General
 - 1.2 Objective
2. GENERIC DESIGN
 - 2.1 Generic layout for the underground area
 - 2.2 Arrangement of the deep repository
 - 2.3 Construction phases
 - 2.4 Transport routes
 - 2.5 Repository drainage system
 - 2.6 Ventilation
 - 2.7 Electricity distribution
3. UNDERGROUND AREA
 - 3.1 Design and designations
 - 3.2 Site arrangement
 - 3.3 Geographical extent – comparison
 - 3.4 Perspective drawings
 - 3.5 Central area
 - 3.6 Deposition areas
 - 3.7 Ramps
 - 3.8 Tunnels
 - 3.9 Shafts
 - 3.10 Local utility shafts
 - 3.11 Local ramps
 - 3.12 Connection to the utility shafts

1. INTRODUCTION

1.1 General

This proposal for the design of the deep repository for spent nuclear fuel assumes that the underground facility is located at a level of approximately 500 metres deep.

To provide sufficient capacity, the deposition area will have to be quite large. It is, therefore, very likely that the area will be divided up by fracture zones. This increases the area and causes extra costs for longer tunnels and increased rock support work.

Against this background, it might be advantageous to divide the deposition area for regular operation (deposition area 2) onto two levels. This would make it possible to concentrate the underground part of the repository into a smaller area. By doing this, it would be easier to adapt the various parts of the repository to the existing zones.

1.2 Objective

This appendix describes a proposal for the design of deposition area 2 divided into two levels, at 500 metres and 600 metres deep. In this alternative, the central area and deposition area 1 are at a depth of -550 metres.

The changes in the underground area do not affect the design of the operational area on the surface. Most of the central part of the underground area and deposition area 1 are also unaffected by the alternative design of deposition area 2.

Consequently, the description of the design of the two-level alternative concentrates on deposition area 2. In general, please refer to the main document.

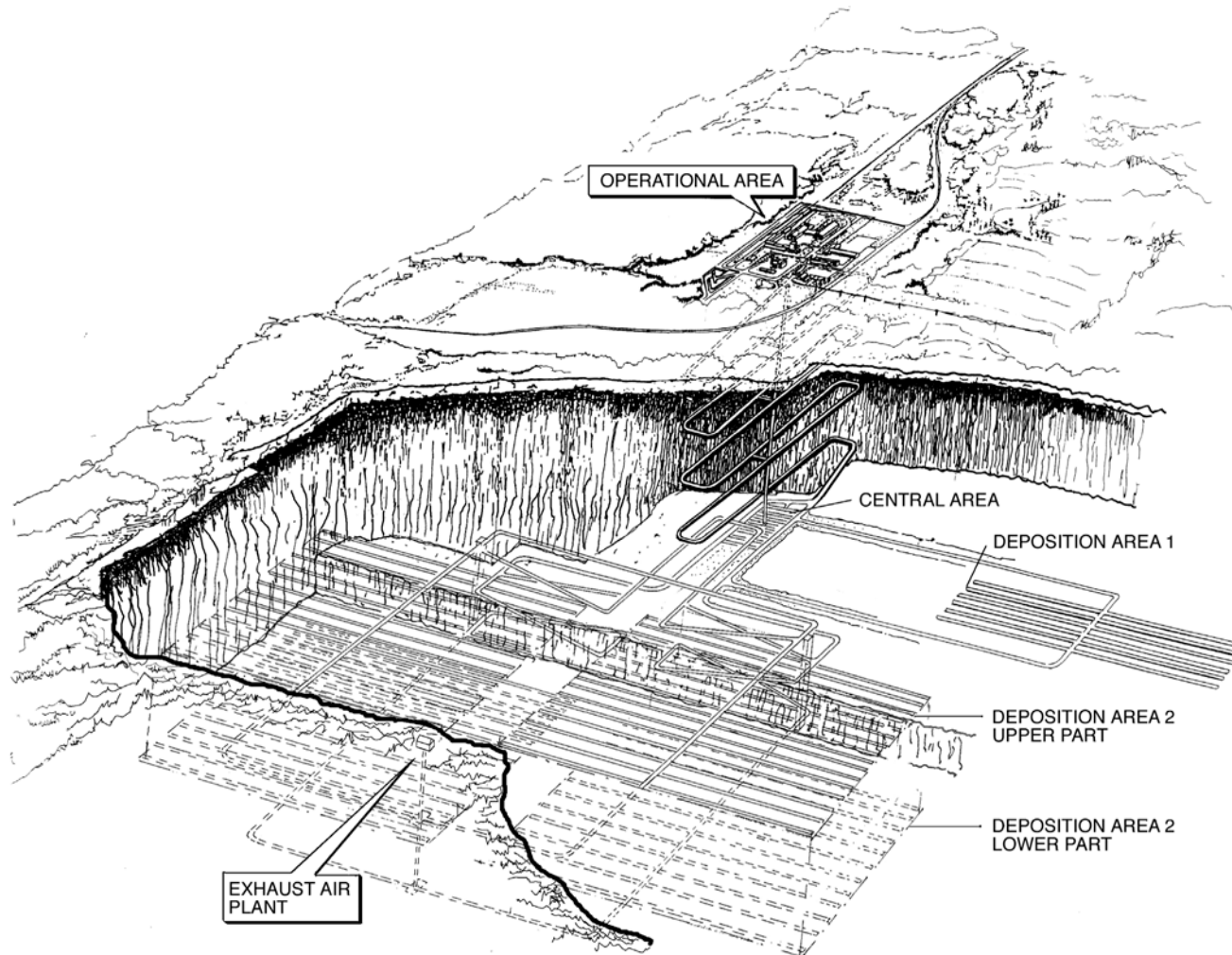

2. GENERIC DESIGN

2.1 GENERIC LAYOUT FOR THE UNDERGROUND AREA

The figure to the left shows the proposal for arranging deposition area 2 on two levels. The figure shows:

- The central area, containing deposition area 1, is unchanged from the main alternative, but is at 550 metres instead of 500 metres deep.
- The upper and lower levels of deposition area 2 are located above each other at depths of 500 and 600 metres.
- The central area is connected to sides A and B of the upper and lower levels of deposition area 2 by two separate ramps and two utility shafts.
- The exhaust airshaft connects both levels to the surface.
- Each level in deposition area 2 has the same shape as the single-level alternative, but half the number of deposition tunnels.

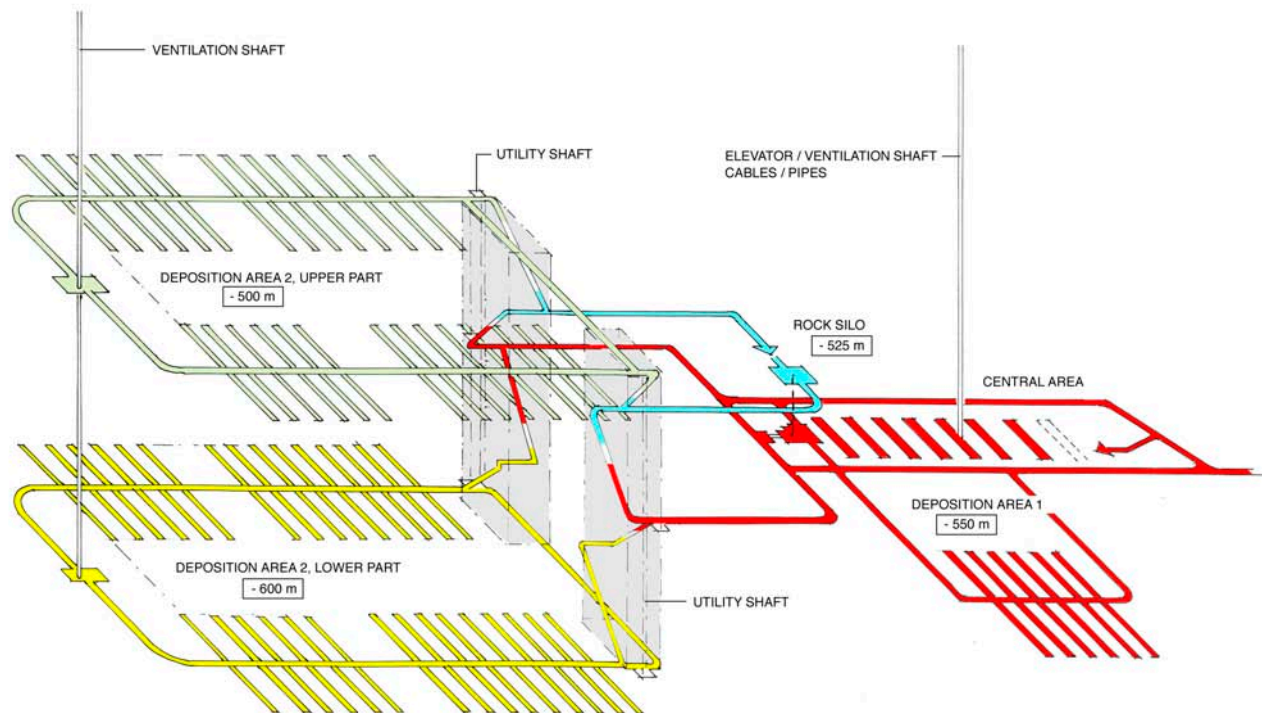

2. **GENERIC DESIGN**
2.2 **ARRANGEMENT OF THE DEEP REPOSITORY**

The figure shows the generic arrangement of the entire deep repository, including the underground and surface facilities.

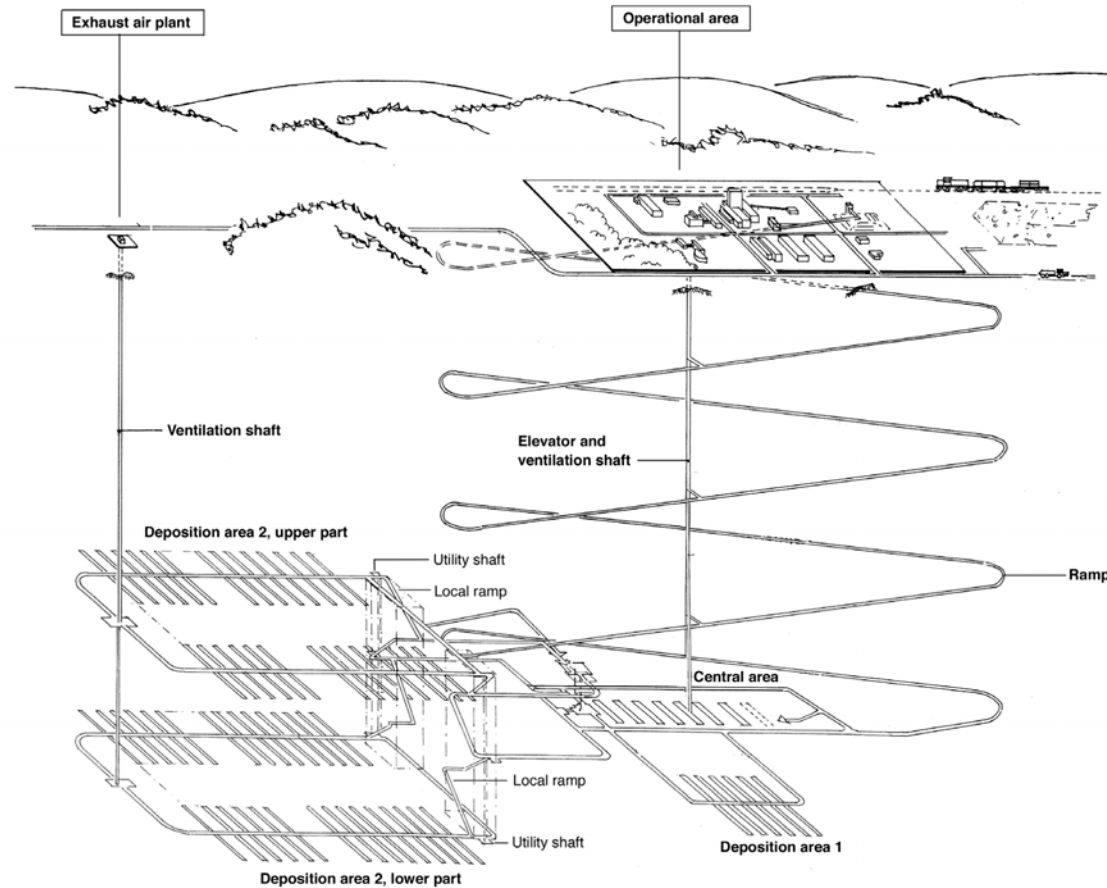

2. GENERIC DESIGN
2.3 CONSTRUCTION PHASES

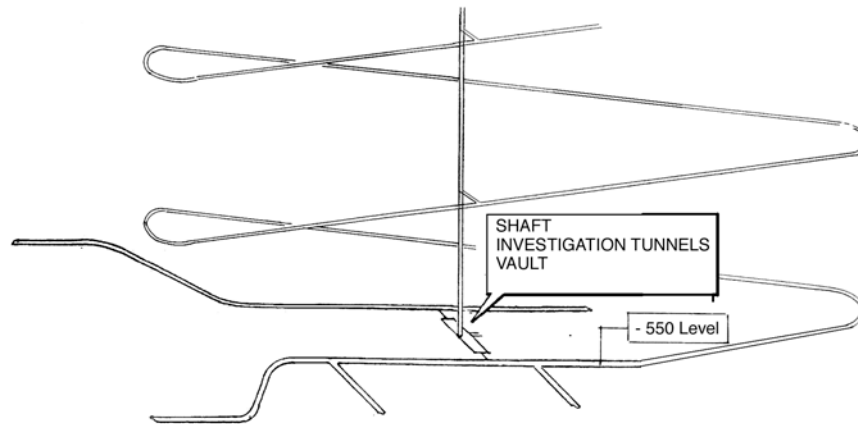

DETAILED INVESTIGATION

Detailed investigation

- Excavation of shaft and ramp to the deposition level.
- Excavation of transport and investigation tunnels on the deposition level.
- Excavation of some of the vaults in the central area.

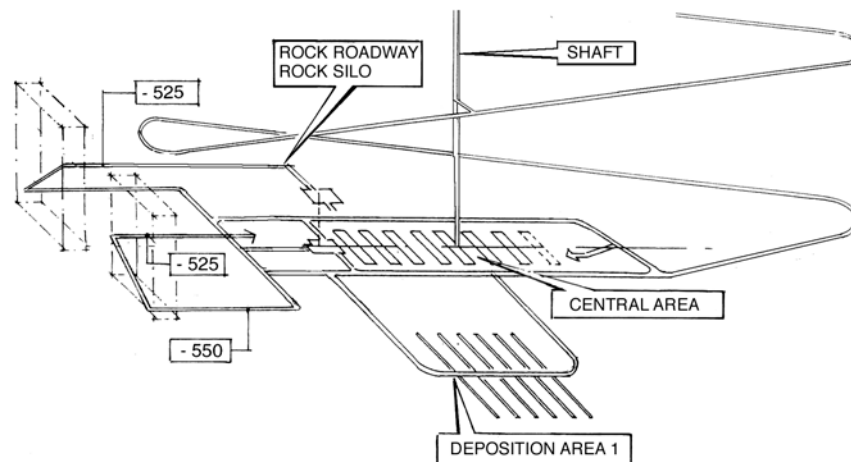

INITIAL OPERATION

Construction for initial operation

- Construction of the necessary vaults in the central area, including the rock silo and associated transport tunnels.
- Construction of all tunnels in deposition area 1 and drilling of most of the deposition holes.
- Installation of required service systems.

2. GENERIC DESIGN
2.3 CONSTRUCTION PHASES

Construction of the upper part of deposition area 2 for regular operation

- The ramps from the central area to the upper deposition level will be excavated.
- The investigation tunnels on the upper deposition level will be excavated, from the ramps to the point for the exhaust airshaft.
- The exhaust airshaft will be excavated to the surface.
- Two utility shafts will be excavated, from the central area to the upper deposition area.
- The investigation tunnels will be enlarged to main tunnel standard along a length of approximately 200 metres on both the A and B sides.
- Ten deposition tunnels will be excavated on one side of the deposition area, including drilling a number of deposition holes to permit the start of canister deposition.
- When deposition starts on one side, excavation work to prepare new deposition tunnels will start on the opposite side.

Construction of the lower part of deposition area 2 for regular operation

When deposition in the upper area is nearing completion, the following measures are necessary to put the lower deposition area into operation:

- The ramps will be excavated from the central area to the lower level.
- The utility shafts will be extended from the central area to the lower deposition area.
- Investigation tunnels will be excavated from the spiral ramps to a position immediately below the previously constructed exhaust airshaft.
- The exhaust airshaft will be extended from the upper level to the lower level.
- Basins for drainage water will be excavated next to each utility tunnel.
- The investigation tunnels will be enlarged to main tunnel standard along a stretch of approximately 200 metres on both the A and B sides.
- Ten deposition tunnels will be excavated and deposition holes are drilled on one side of the repository.
- Machines for deposition will be moved to the lower level, followed by the start of deposition on the prepared side and the beginning of excavation of new tunnels on the other side.

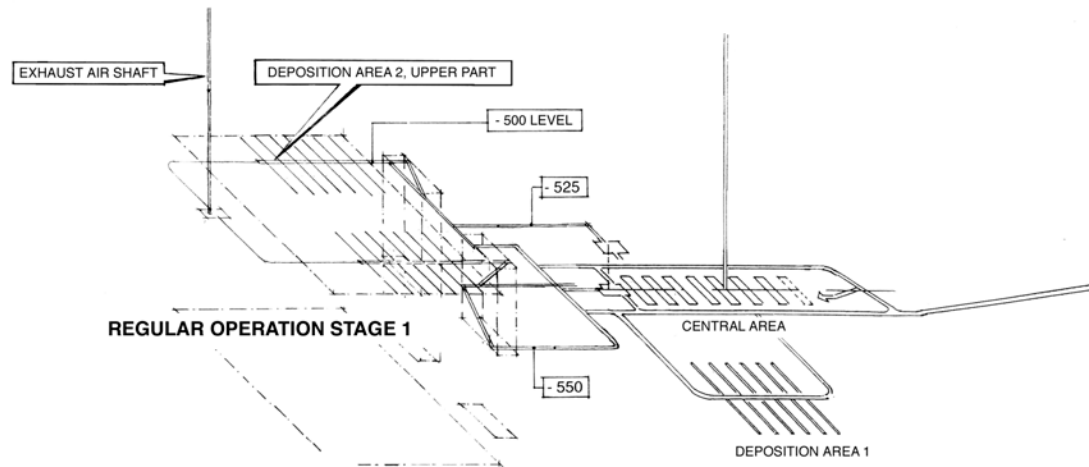

REGULAR OPERATION STAGE 1

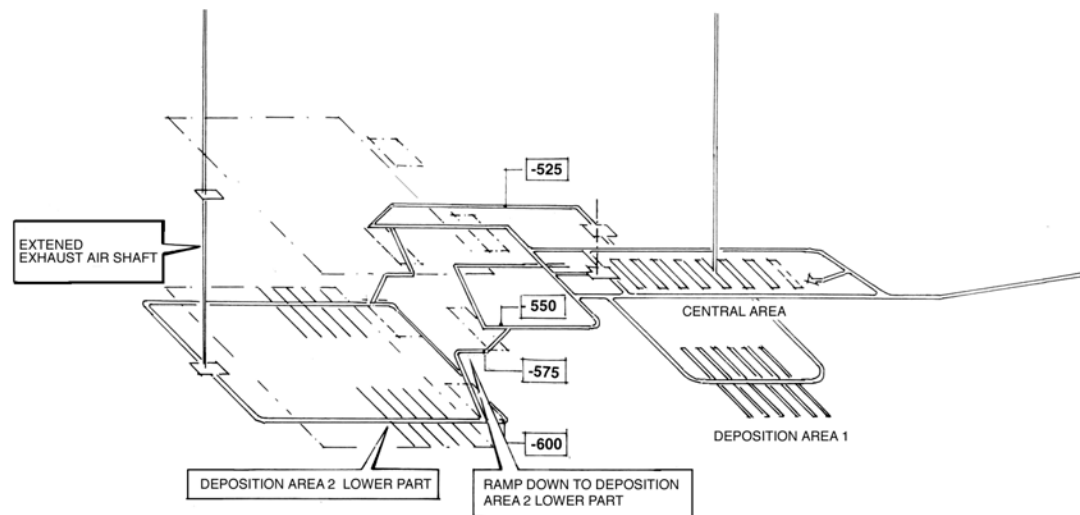

REGULAR OPERATION STAGE 2

2. GENERIC DESIGN
2.4 TRANSPORT ROUTES

The figure to the left shows the transport route between the central area and the lower part of deposition area 2.

As with the single-level alternative, activities during regular operation will be divided up into sides A and B.

The transport flow (yellow colour) on the construction side consists mainly of:

- rock
- construction materials
- explosives
- installation materials
- mechanical equipment
- staff

The transports (red colour) on the deposition side consist of:

- canisters in radiation shielding tubes
- buffer material in the form of compacted bentonite blocks
- backfilling material
- construction materials
- mechanical equipment
- staff

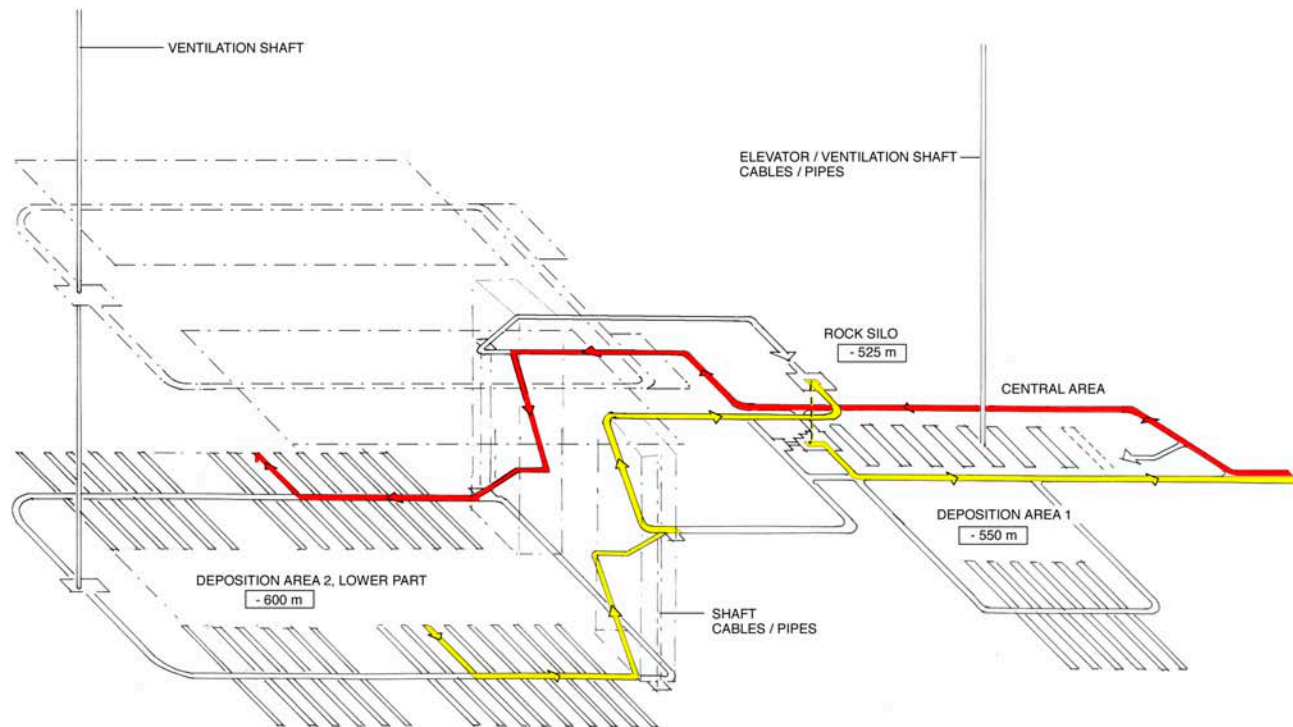

2. GENERIC DESIGN
2.5 REPOSITORY DRAINAGE SYSTEM

The upper level and the central area are drained using the same principle as the single-level solution. However, the lower level has two separate drainage basins, to which the water is led. From these, water is pumped to the repository drainage vault in the central area, where there are pumps to raise the water to the surface. The pipes from the lower level are installed in the utility shafts that connect the two levels.

The design of the drainage basins on the lower level is shown in section 3.12 of this appendix.

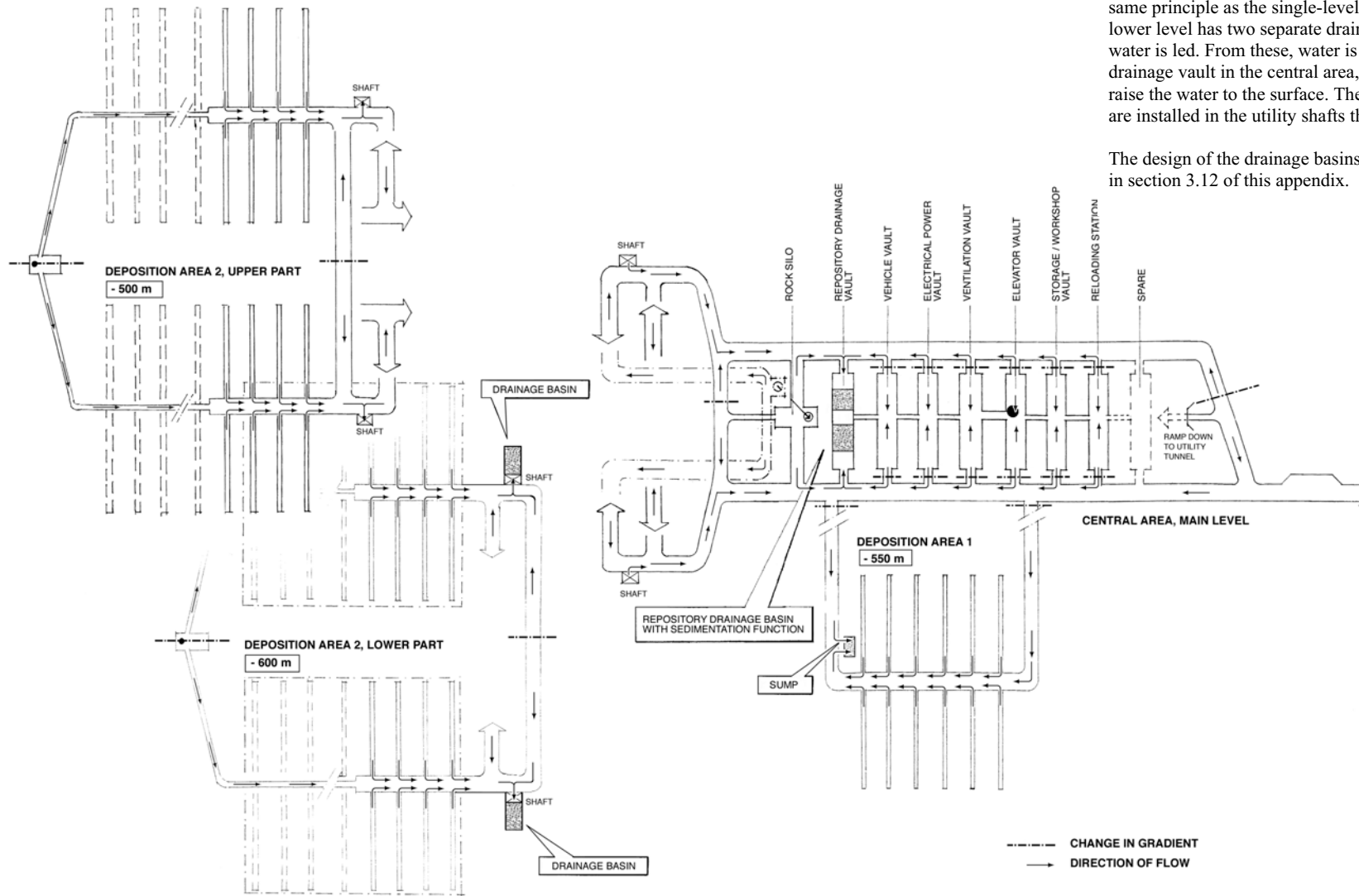

2. **GENERIC DESIGN**
2.6 **VENTILATION**

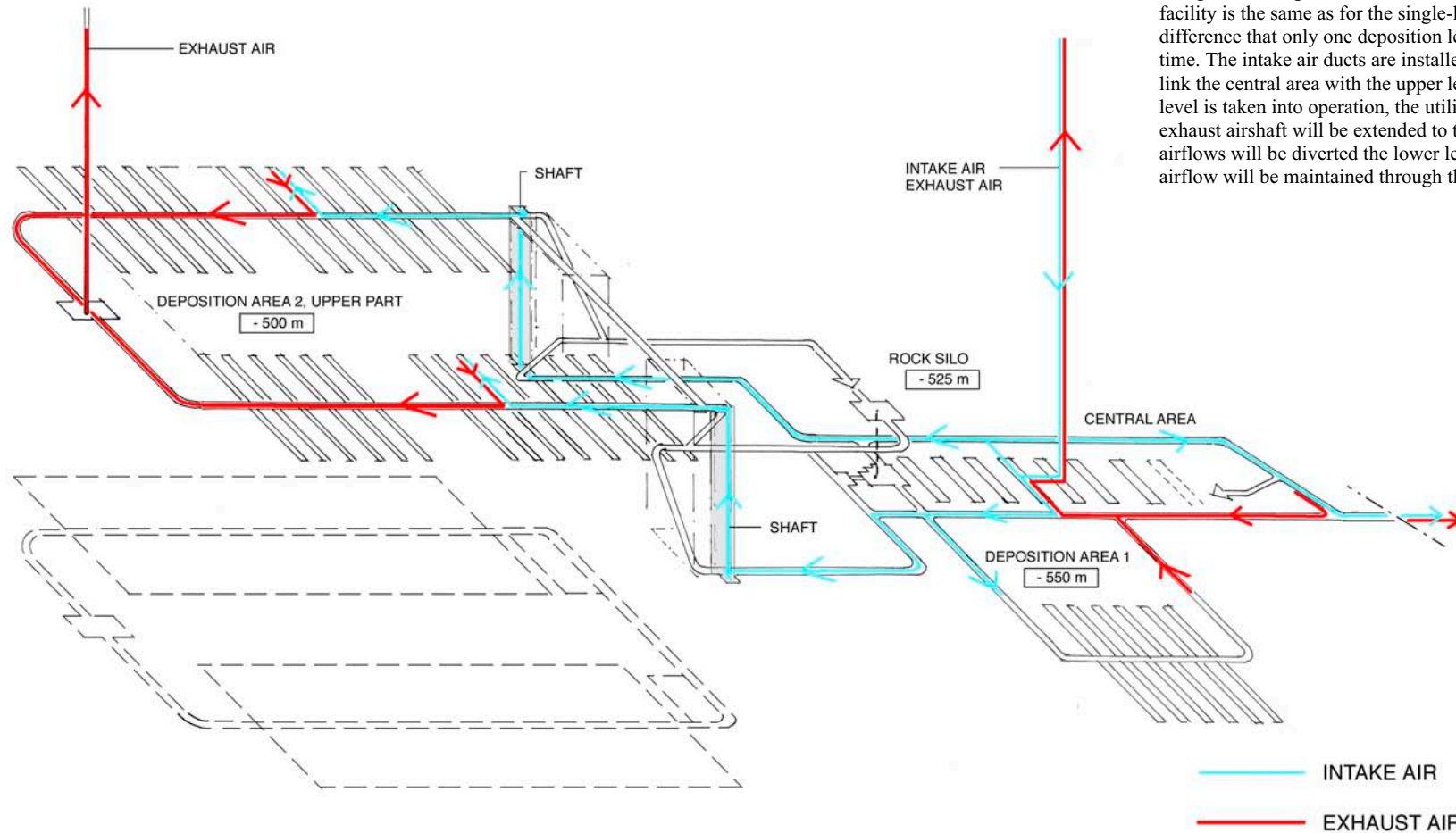

The generic design for the ventilation system for the facility is the same as for the single-level layout, with the difference that only one deposition level is ventilated at a time. The intake air ducts are installed in utility shafts that link the central area with the upper level. When the lower level is taken into operation, the utility tunnels and the exhaust airshaft will be extended to the lower level. The airflows will be diverted the lower level, and only a limited airflow will be maintained through the upper level.

2. GENERIC DESIGN
2.7 ELECTRICITY DISTRIBUTION

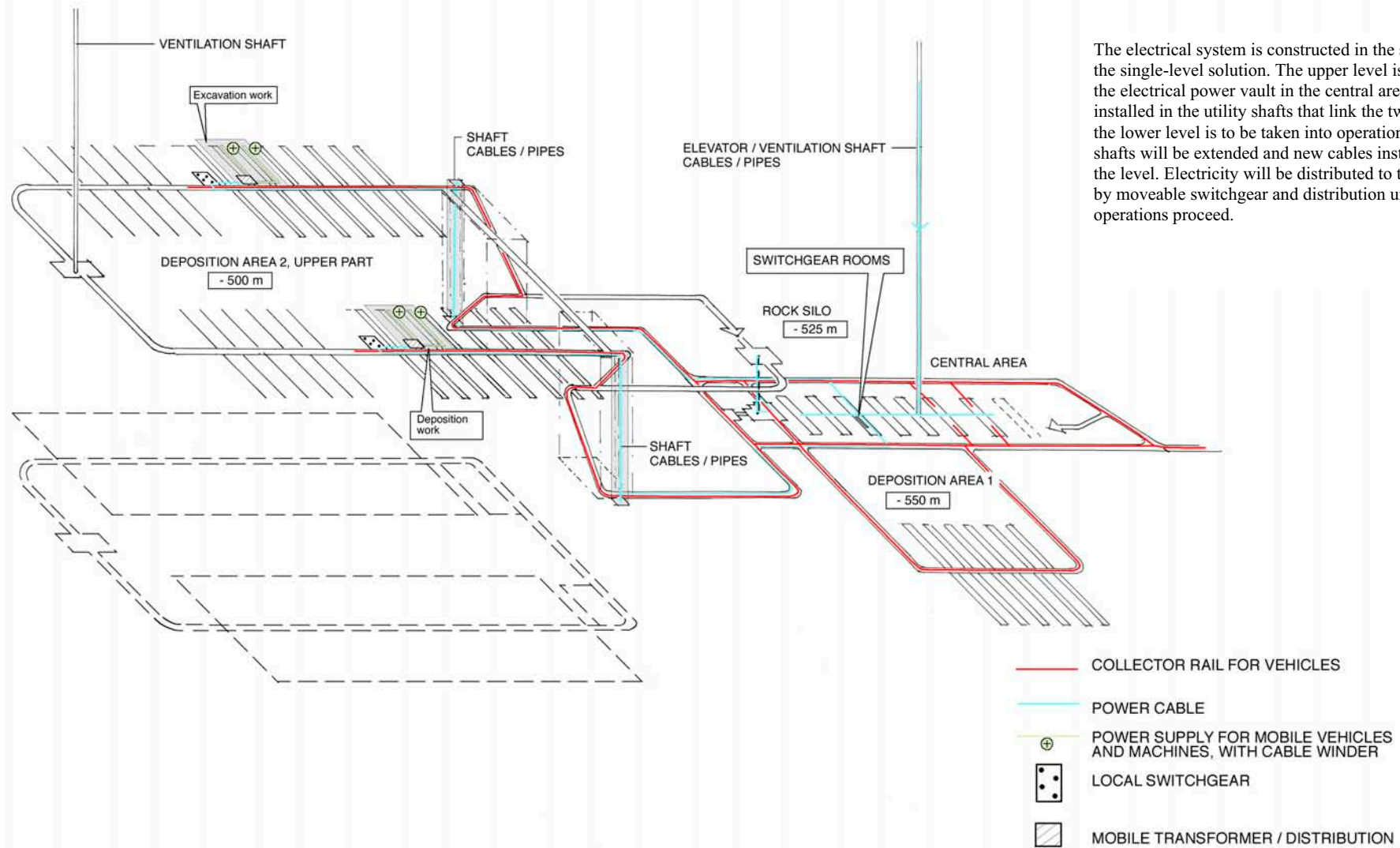

The electrical system is constructed in the same way as for the single-level solution. The upper level is supplied from the electrical power vault in the central area, via cables installed in the utility shafts that link the two levels. When the lower level is to be taken into operation, the utility shafts will be extended and new cables installed to supply the level. Electricity will be distributed to the various loads by moveable switchgear and distribution units, as the operations proceed.

**3. UNDERGROUND AREA
3.1 DESIGN AND DESIGNATIONS**

The figure to the left shows the two-level design of the underground area.

The central area and deposition area 1 are 50 metres deeper than in the design with a single deposition level. Other changes in design affect the area from the third transverse roadway.

The figure to the left shows the designations.

The upper and lower parts of deposition area 2 have been displaced sideways for clarity.

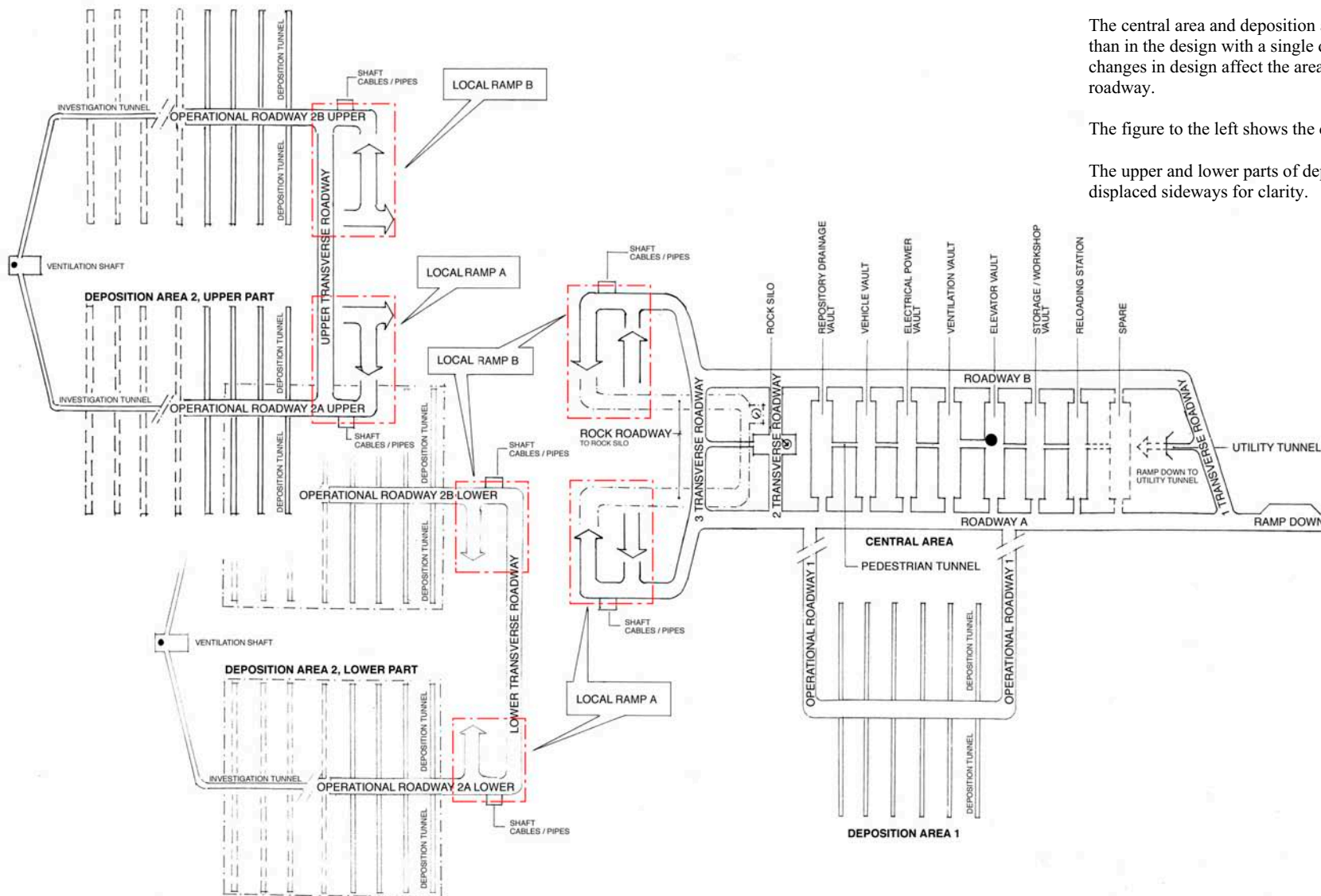

3. UNDERGROUND AREA
3.2 SITE ARRANGEMENT

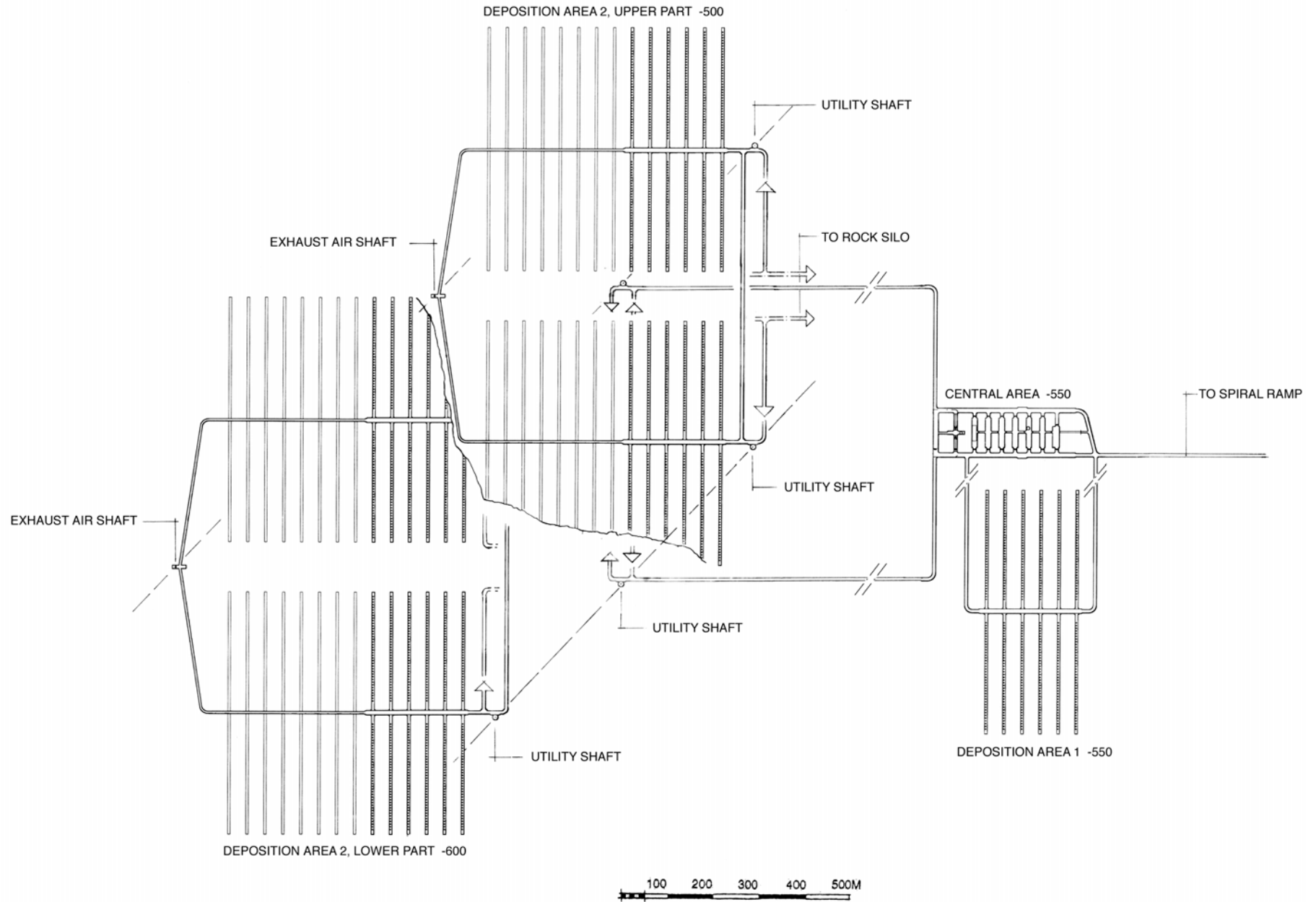

3. UNDERGROUND AREA

3.3 GEOGRAPHICAL EXTENT - COMPARISON

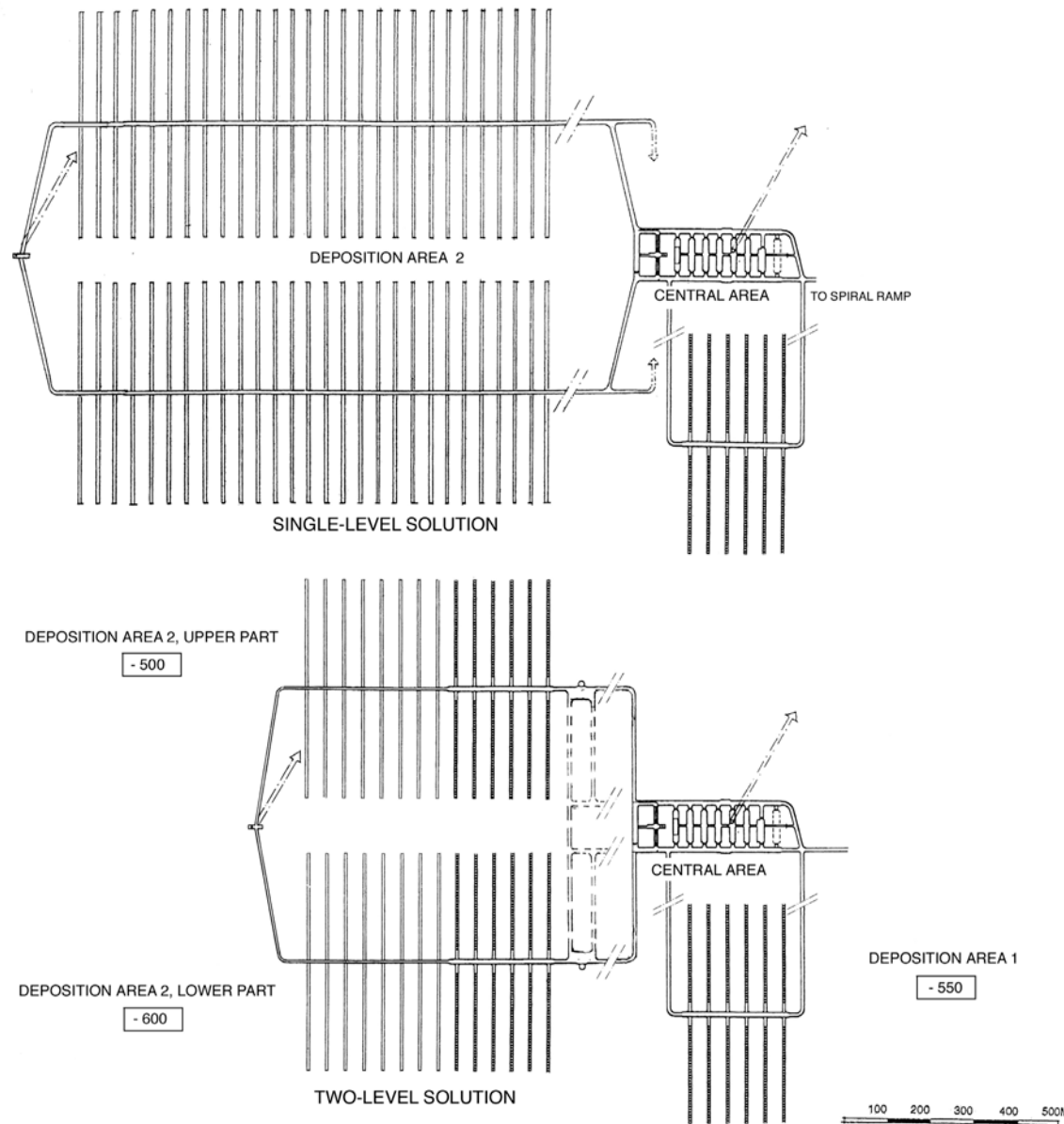

The figures to the left show the difference between the geographical extent in plan view of the single-level and two-level alternatives. The comparison shows that, in theory, the two-level alternative requires approximately 40 percent less area, assuming that the two levels can be located in one rock mass.

Deposition on one level

Advantages

- Avoidance of local transport in the vertical direction.
- Shorter transport tunnels between the central area and the deposition area.

Disadvantages

- Strong likelihood that fracture zones will cross the deposition area.
- Costs for longer transport tunnels and extra rock support and sealing when fracture zones are encountered.
- Disruptions due to these rock support measures.
- Need to investigate a considerably larger mass of rock.

Deposition on two levels

Advantages

- A considerably smaller area of rock will have to be investigated.
- Less risk of encountering fracture zones.
- Probably easier to find a suitable mass of rock.

Disadvantages

- Longer transport tunnels needed, to bridge the difference in levels.
- The deeper deposition level for the lower area might create problems in terms of rock mechanics, and lead to increased salinity.
- Certain work in the facility will have to be done in stages.

3. UNDERGROUND AREA
3.4 PERSPECTIVE DRAWINGS

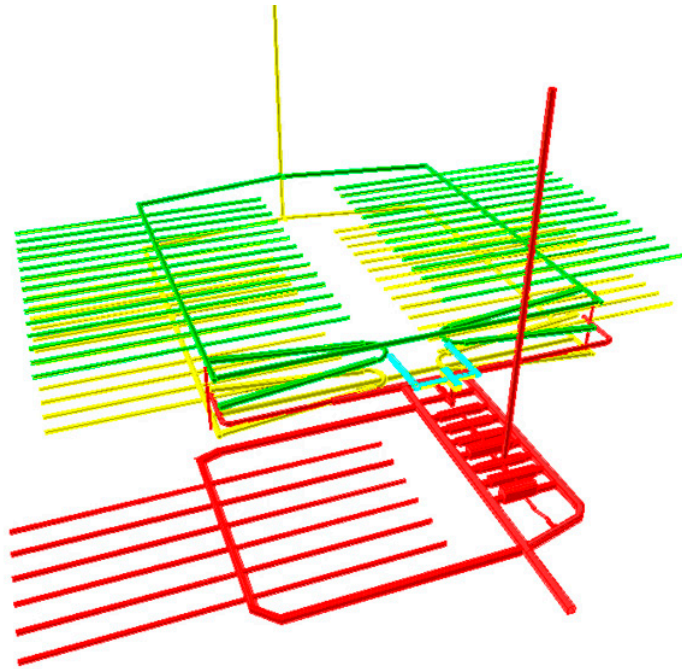

VIEW TOWARDS THE CENTRAL AREA

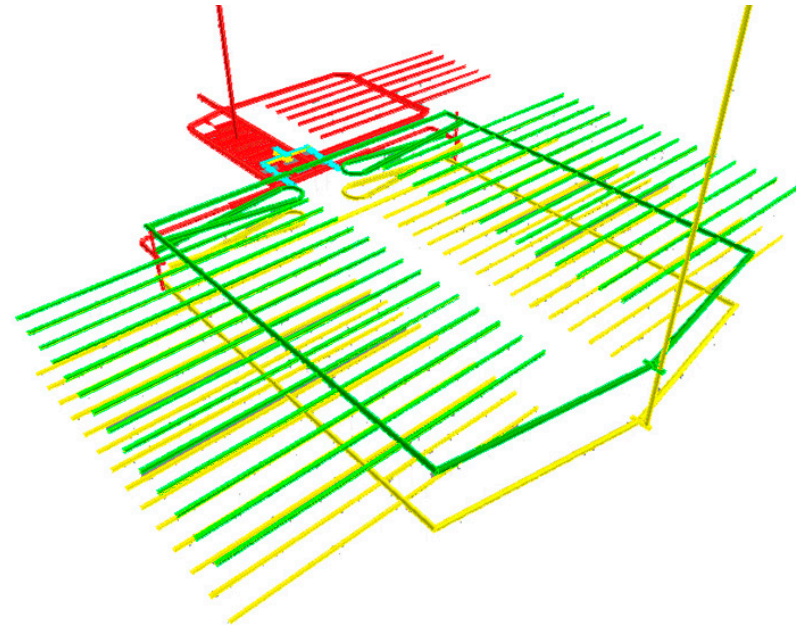

VIEW TOWARDS THE EXHAUST AIRSHAFT

3.5 Central area

The division of the deposition area 2 into two levels does not affect the design of the central area.

For detailed information about the central area, please refer to chapter 17 of the facility description, "Underground – Central area."

3.6 Deposition areas

The adaptation to two levels does not affect the design of the deposition areas, except that the upper and lower parts of deposition area 2 are shorter than in the single-level alternative.

3.7 Ramps

The division of deposition area 2 into two levels does not affect the ramp from the operational area to the central part of the underground area, except that the central area is 50 metres deeper than is the case in the single-level alternative.

The two-level alternative requires two local ramps, to link the central area with the upper and lower deposition levels.

The difference in level between the upper and lower connection points is 100 metres.

The cross section of the local ramp is 7.0 x 7.0 metres, with a gradient of 1:10, which is equivalent to the size of the ramp from the surface.

3. UNDERGROUND AREA

The local ramps are constructed in two stages.

The adjoining figure shows the location and generic design of the local ramps.

3.8 Tunnels

The tunnel system has the same design in the two-level solution as in the single-level solution. See chapter 16 in the main part of the facility description.

3.9 Shafts

The adjoining figure shows the basic design of the shafts adapted to the two-level alternative.

The elevator and ventilation shaft between the operational area and the central area is unchanged from the single-level alternative, except that the shaft is 550 metres deep as opposed to 500 metres.

The exhaust airshaft at the far end of the deposition area has the same dimensions as in the single-level alternative, but will be constructed in two stages and will be 600 metres deep when completed.

3.9 Local utility shafts

There are two smaller utility shafts in this alternative, to connect the upper and lower deposition areas with the central area in-between. The shafts, which are constructed in two stages, have a diameter of approximately 3 metres and are 100 metres high. See the adjoining figure.

The purpose of the shafts is to make it possible to install pipes, ventilation ducts and electrical cables.

In the lower connection on the 600 metre level, there is a drainage basin for collecting all of the drainage water from the lower deposition level.

The niches in the utility shafts are separated from the transport tunnel system by a wall with a door in it. The wall provides fire and ventilation segregation.

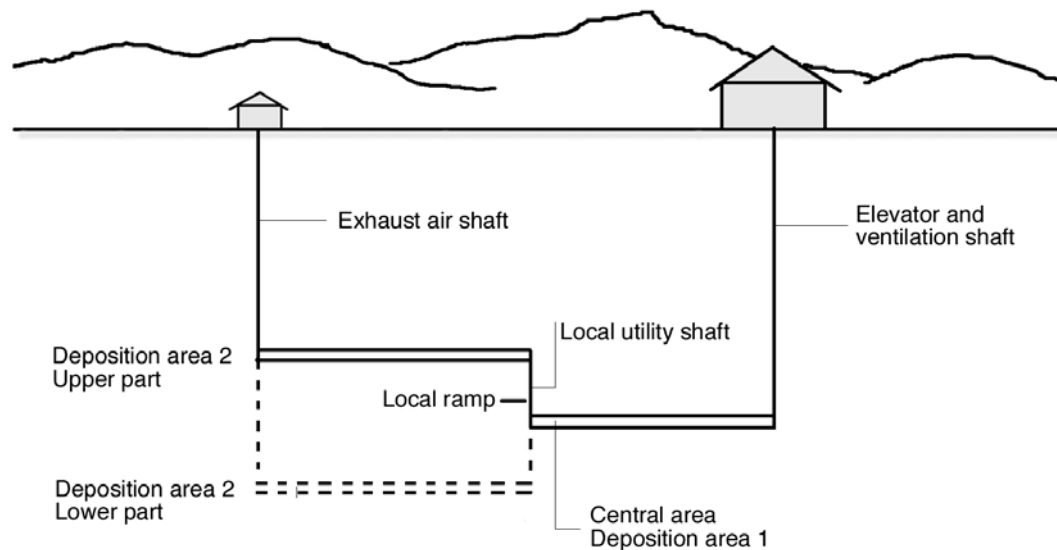

3. UNDERGROUND AREA
3.11 LOCAL RAMPS

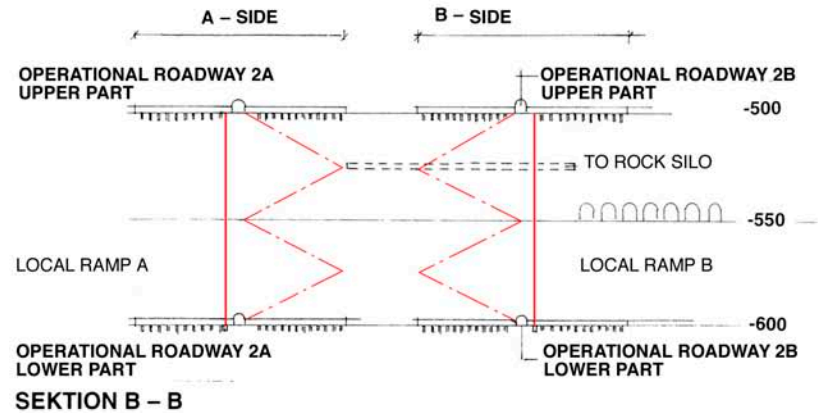
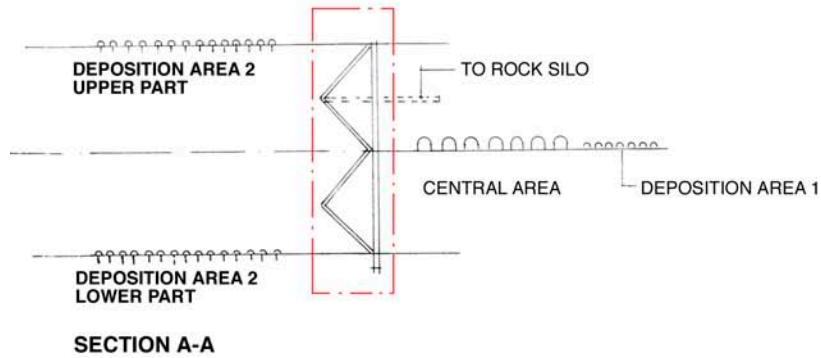
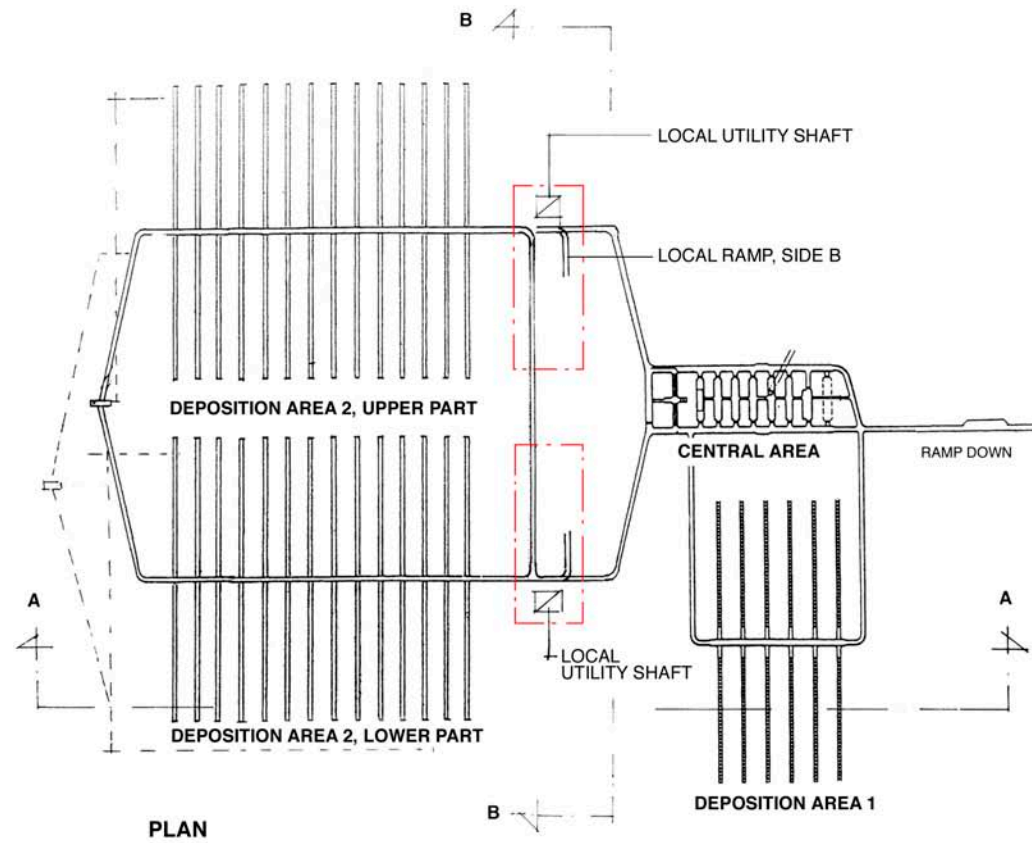

3. UNDERGROUND AREA
3.12 CONNECTION TO THE UTILITY SHAFTS

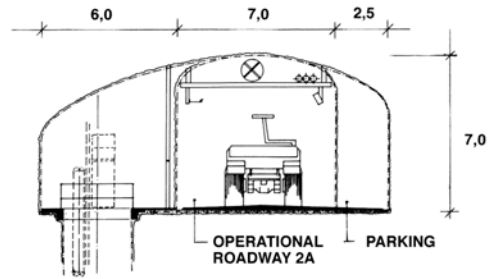

SHAFT CONNECTION TO PARKING AREA
 UPPER LEVEL -500
SECTION C-C

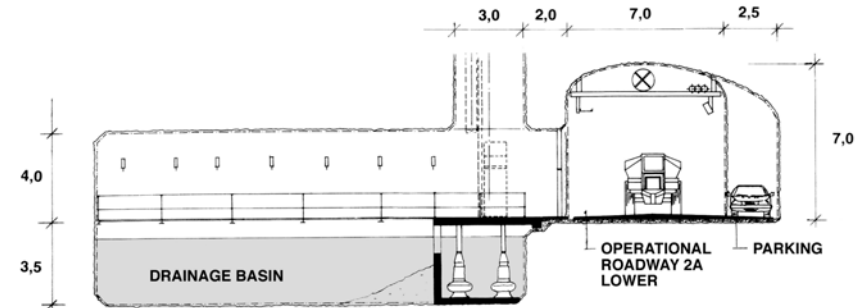

SHAFT CONNECTION TO DRAINAGE BASIN
 LOWER LEVEL -600
SECTION D-D

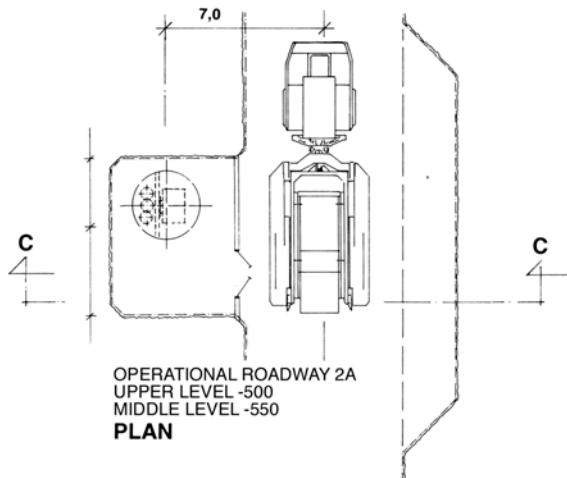

OPERATIONAL ROADWAY 2A
 UPPER LEVEL -500
 MIDDLE LEVEL -550
PLAN

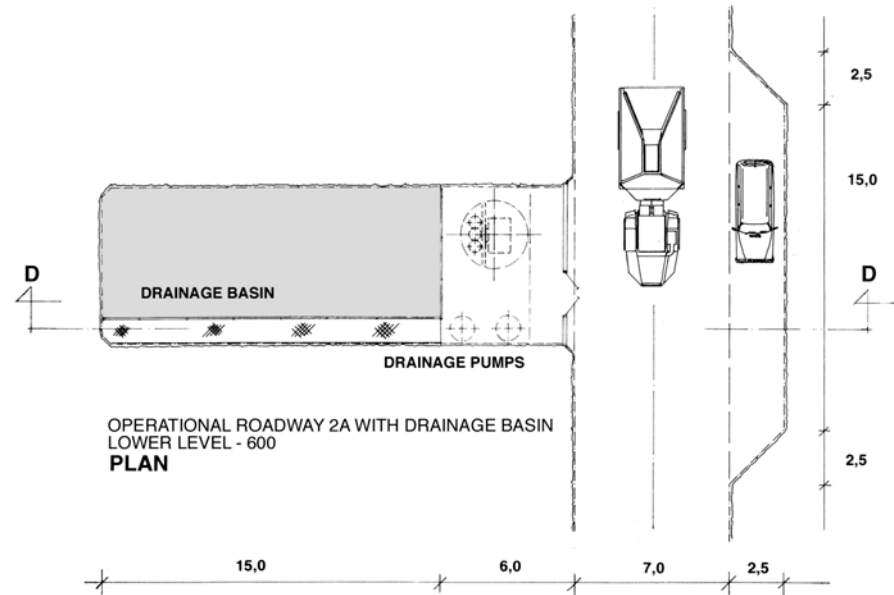

OPERATIONAL ROADWAY 2A WITH DRAINAGE BASIN
 LOWER LEVEL -600
PLAN

