

International  
Progress Report

**IPR-02-23**

# Äspö Hard Rock Laboratory

## Prototype Repository

### Installation of buffer, canisters, backfill and instruments in Section 1

Lennart Börgesson

David Gunnarsson

Lars-Erik Johannesson

Torbjörn Sandén

Clay Technology AB

March 2002

**Svensk Kärnbränslehantering AB**

Swedish Nuclear Fuel

and Waste Management Co

Box 5864

SE-102 40 Stockholm Sweden

Tel +46 8 459 84 00

Fax +46 8 661 57 19



**Äspö Hard Rock  
Laboratory**



Report no.	No.
IPR-02-23	F63K
Author	Date
Börgesson, Gunnarsson, Johannesson, Sandén	02-03-01
Checked by	Date
Approved	Date
Christer Svemar	

# Äspö Hard Rock Laboratory

## Prototype Repository

### Installation of buffer, canisters, backfill and instruments in Section 1

Lennart Börgesson  
David Gunnarsson  
Lars-Erik Johannesson  
Torbjörn Sandén  
Clay Technology AB

March 2002

*Keywords:* Fields test, buffer, canister, backfill, bentonite, temperature, relative humidity, pressure, compaction, instrumentation

This report concerns a study which was conducted for SKB. The conclusions and viewpoints presented in the report are those of the author(s) and do not necessarily coincide with those of the client.



# Abstract

During 2001 Section 1 of the Prototype Repository has been installed in Äspö Hard Rock Laboratory. Section 1 consists of four full-scale deposition holes, copper canisters equipped with electrical heaters, bentonite blocks (cylindrical and ring shaped) and a deposition tunnel backfilled with a mixture of bentonite and crushed rock and ends with a concrete plug. Temperature, water pressure, relative humidity, total pressure and displacements etc. are measured in numerous points in the test. The cables from the transducers are lead through the rock in watertight tubes to the data collection systems in the adjacent G-tunnel.

This report describes the work with the installations of the buffer, canisters, backfill and instruments and yields a description of the final location of all instruments. The report also contains a description of the materials that were installed and the densities yielded after placement.



# Sammanfattning

Under år 2001 har sektion 1 av Prototypförvaret installerats i Äspö Hard Rock Laboratory. Sektion 1 består av fyra fullskaliga deponeringshåll, fyra kopparkapslar utrustade med elektriska värmare, buffert av bentonitblock (cylindrar och ringar) och en deponerings tunnel som är återfylld med en blandning av bentonit och krossat berg. Sektion 1 avslutas med en betongplugg. Temperatur, vattentryck, relativa fuktigheten, totaltryck och förskjutningar mm mäts i otaliga punkter. Kablarna från mätgivarna leds genom berget i vattentäta rör fram till datainsamlingsystemen i den intilliggande G-tunneln.

Rapporten beskriver installationsarbetet med installation av buffert, kapslar, återfyllning och instrumentering och ger en beskrivning av de slutliga lägena för alla instrument. Rapporten innehåller också en beskrivning av de installerade materialen och de densiteter som uppnåddes efter inplacering.





# Table of contents

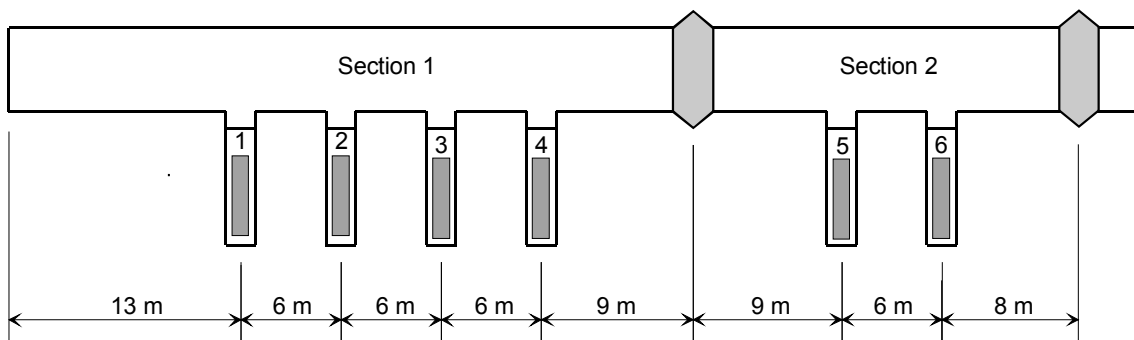
<b>Abstract</b>	<b>i</b>
<b>Sammanfattning</b>	<b>iii</b>
<b>1 Introduction</b>	<b>1</b>
<b>2 Handling of cables and tubes</b>	<b>3</b>
2.1 Design of lead throughs	3
2.1.1 Quantity and distribution of cables and tubes	7
2.2 Encapsulation of instruments and cables	9
2.2.1 Relative humidity sensors	9
2.2.2 Encapsulation of other sensors	10
2.3 Leading sensor cables in polyamide tubes	10
2.4 Preparation and mounting of “cable parcels”	11
2.4.1 Assembling of cable parcels	11
2.4.2 Parcels including cables from the canister	12
2.4.3 Parcels including cables from bentonite, backfill and rock	13
2.4.4 Procedure for installing a cable parcel	15
<b>3 Preparation of bentonite blocks for instruments and cables</b>	<b>17</b>
3.1 General	17
3.2 Location of instruments in the bentonite	17
3.2.1 Brief description of the instruments	17
3.2.2 Strategy for describing the position of each device	18
3.3 Position of each cable and tube on the bentonite block periphery	20
3.3.1 Cables and tubes from instruments in the bentonite	21
3.3.2 Cables from the canister	21
3.4 Preparation of the bentonite blocks	22
3.4.1 Clearances for instruments	22
3.4.2 Tracks for cables and tubes on the bentonite blocks surface	23
3.4.3 Clearances for cables through block R10	23
3.4.4 Clearances for the bottom of the canister in block C1	24
<b>4 Installation of the buffer and the canisters</b>	<b>27</b>
4.1 General	27
4.2 Procedures for deposition of buffer and canisters	29
4.2.1 Preparation of the deposition holes	29
4.2.2 Mounting of gantry-crane	30
4.2.3 Installation of water protection sheets in the deposition hole	31
4.2.4 Deposition of bentonite block C1 and R1-R10	31
4.2.5 Instrumentation of bentonite block C1, R5 and R10	32
4.2.6 Transportation of the canisters	33
4.2.7 Mounting of the deposition machine	34
4.2.8 Deposition of the canister	34

4.2.9	Connecting heaters and cables on the canister	36
4.2.10	Installation of small blocks on the lid of the canister	37
4.2.11	Deposition of bentonite blocks C2 – C4	38
4.2.12	Instrumentation of bentonite block C3 and C4	38
4.2.13	Covering of bentonite block C4 with plastic	39
4.2.14	Installation of temporary displacement and moisture transducers	39
4.2.15	Continuous registration of displacement and moisture	39
4.2.16	Filling bentonite pellets	39
4.3	Retrieval of the canister in deposition hole DA3581G01 (Dh2)	40
4.4	Density of the installed buffer	42
4.5	Installation of instruments	45
<b>5</b>	<b>Backfilling and instrumentation of the tunnel</b>	<b>47</b>
5.1	Description of the backfilling of the tunnel	47
5.1.1	Backfill material	47
5.1.2	Overview of the backfilling	48
5.1.3	Handling of water inflow to the inner part of the tunnel	50
5.1.4	Backfilling and instrumentation of the individual layers	50
5.1.5	Backfilling of the upper part of the deposition holes	57
5.1.6	Backfilling against the retaining wall	59
5.2	Measurement of density and water ratio	61
5.2.1	Scope of measurements	61
5.2.2	Equipment and Technique	62
5.2.3	Results from the density measurements	63
5.3	Instrumentation	67
5.3.1	Installations made during backfilling	67
5.3.2	Co-ordinate system and measurement of sensor positions	68
	<b>References</b>	<b>71</b>
	<b>Appendix I</b>	<b>73</b>
	<b>Appendix II</b>	<b>83</b>

# 1 Introduction

The Prototype Repository is located in the innermost part of the TBM-tunnel. Figure 1-1 shows the layout of the test. The test is divided into two sections and this report deals with the installation of the buffer, canisters, backfill, instruments and cables in Section 1, which was finished in the end of November 2001.

Section 1 consists of four full-scale deposition holes, copper canisters equipped with electrical heaters, bentonite blocks (cylindrical and ring shaped) and a deposition tunnel backfilled with a mixture of bentonite and crushed rock and ends with a concrete plug. Temperature, water pressure, relative humidity, total pressure and displacements etc. are measured in numerous points in the test. The cables from the transducers are lead through the rock in watertight tubes to the data collection systems in the adjacent G-tunnel.



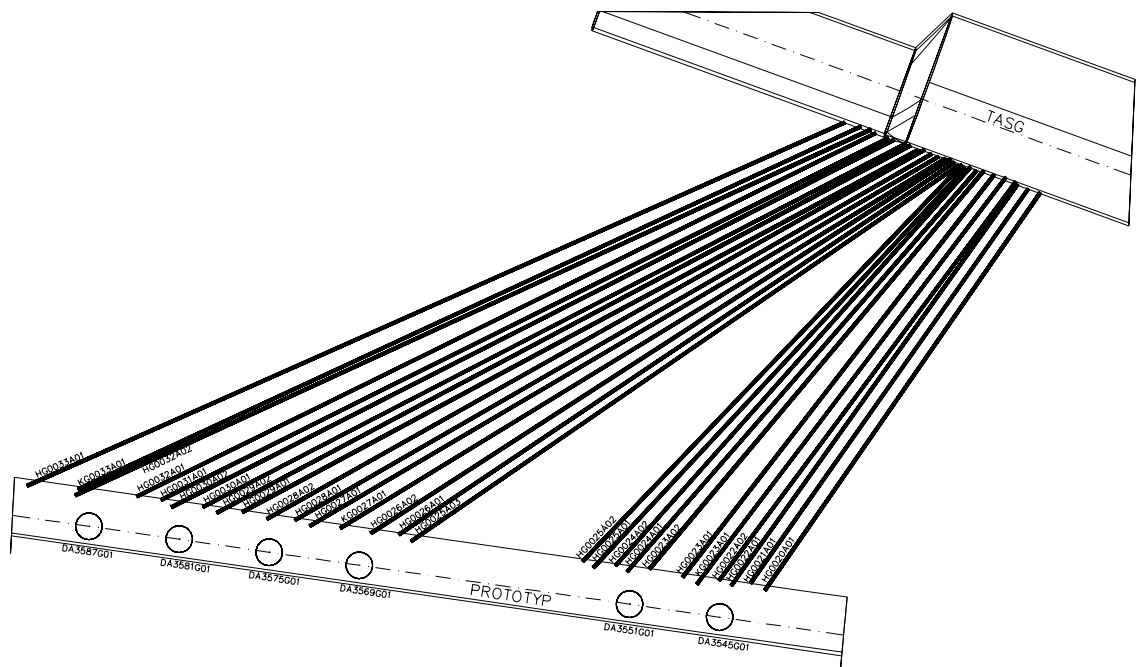
*Figure 1-1. Layout of the Prototype Repository.*



## 2 Handling of cables and tubes

### 2.1 Design of lead throughs

Cables and tubes from the different measuring points must be led through the rock into the adjacent tunnel (the G-tunnel), where a measuring house with data collection system is placed. 27 lead through holes, 16 holes from section 1 and 11 from section 2, were drilled through the rock in to the adjacent G-tunnel (see Figure 2-1) for this purpose.



*Figure 2-1. The lead through holes drilled between the Prototype Repository and the G-tunnel.*

The demands on the lead throughs are very high:

- They should be so watertight that they do not have a significant influence on the water pressure in the backfill.
- They should withstand a water pressure of 5 MPa.
- The long-term stability of the included materials must be high. They will be exposed to water with high salinity for about twenty years. The gauges, placed in the bentonite, will in addition also be exposed to a temperature of about 90° C.

The lead throughs are similar to those used in the Backfill and Plug Test. The number of cables and tubes that is led out is, however, more than twice as many. The variation of types and dimensions of the cables and tubes also made the work complicated. The distances through the rock are in some cases about twice as long as in the Backfill and Plug Test, i.e. 60 m instead of 30 m.

The principle is that a certain number of cables and tubes are collected and led through a steel flange and then further on through a steel pipe, which is placed in a borehole in the rock. The sealing of the cables and tubes in the flange is mainly done with ferrule connections of Swagelok type. For some of the cables, for example the power cables to the heaters, special lead throughs of submarine type were manufactured. The space between the steel pipes, leading cables and tubes, and the rock was sealed with bentonite rings at a length of about 1 meter at the test tunnel and 1 meter at the outlet of the tubes. The bentonite is supported with steel flanges and rubber sealings as well as cement plugs. The rest of the lengths was grouted with cement. Totally 27 bore holes, 16 in section 1 and 11 in section 2, were drilled in order to lead about 500 cables and tubes out.

The final design and the installation of the lead throughs are shown in Figures 2-2 and 2-3.

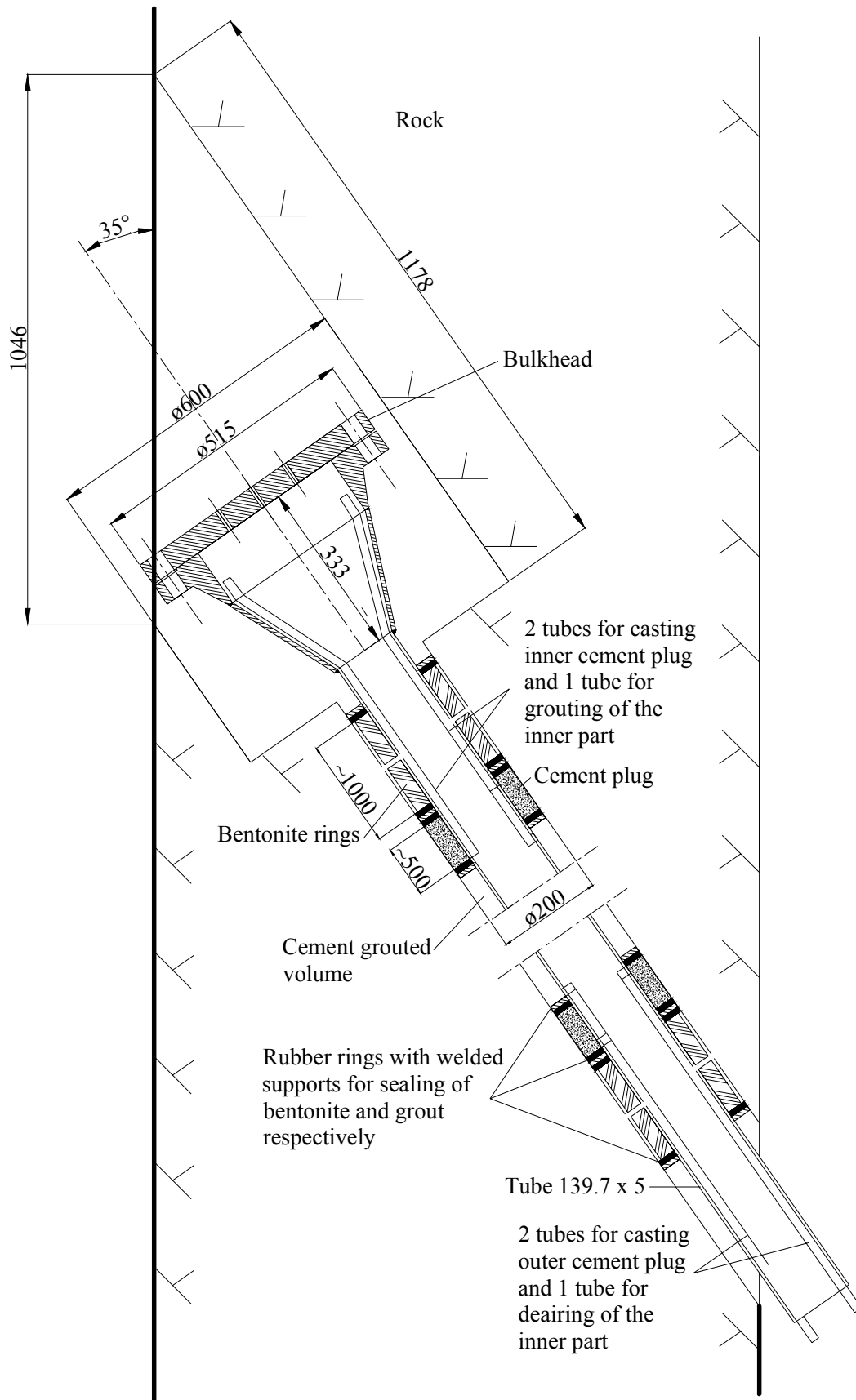


Figure 2-2. Schematic view of a lead through.



*Figure 2-3. Photos showing the installation of steel tubes in the rock (upper) and one completed lead through installed in the rock (without steel flange and cables).*



### 2.1.1 Quantity and distribution of cables and tubes

The total number of cables and tubes that were led through the rock from section 1 to the adjacent tunnel were as follows (see also Table 2-1):

#### **Canisters** (4 pcs.)

- 12 power cables with a diameter of 32 mm (Polyether-Polyurethane).
- 16 fiber optic temperature cables with a diameter of 2 mm (Inconel).
- 6 tubes leading fiber optic cables from gauges measuring displacement of the canisters (canister 3) with a diameter of 8 mm (Inconel)

#### **Bentonite** (2 instrumented deposition holes)

- 54 tubes with a diameter of 8 mm from total pressure gauges (Titanium/Polyamide)
- 28 tubes with a diameter of 8 mm from pore pressure gauges (Titanium/Polyamide)
- 54 cables with a diameter of 10 mm from relative humidity sensors (Titanium/Polyamide). 20 of the cables are supporting 2 sensors each
- 64 thermocouples with a diameter of 4.0 mm for temperature measurements (Cupronickel)

#### **Backfill** (2 sections type E (see Chapter 5) with 30 gauges, 3 sections type F with 12 gauges and 12 gauges in the rest of the backfill)

- 21 tubes with a diameter of 8 mm from total pressure gauges (Polyamide)
- 22 tubes with a diameter of 8 mm from pore pressure gauges (Polyamide)
- 45 tubes with a diameter of 8 mm from relative humidity gauges (Polyamide)
- 20 thermocouples with a diameter of 4.0 mm for temperature measurements. (Cupronickel)
- 1 cable with a diameter of 25.7 mm for resistivity measurements (Polyether-Polyurethane).

#### **Rock**

- 120 tubes with a diameter of 4 and 6 mm from pore pressure measurements (Polyamide/Steel/Peek)
- 8 tubes with a diameter of 1/8" from sampling of water and gas (PEEK).
- 37 thermocouples with a diameter of 4.0 mm (Cupronickel)
- 6 tubes used for water drainage with a diameter of 10 mm (Polyamide)

**Table 2-1. Table showing how the different cables and tubes were distributed in the lead through holes.**

Prototype Repository				Deposition hole 1				Deposition hole 2				Deposition hole 3				Deposition hole 4				Sum
Measuring place	Tube d mm	Lead through type	Material	Number of tubes/cables				Number of tubes/cables				Number of tubes/cables				Number of tubes/cables				
				LT 11	LT 12	LT 13	LT 14	LT 21	LT 22	LT 23	LT 24	LT 31	LT 32	LT 33	LT 34	LT 41	LT 42	LT 43	LT 44	
<b>Canister</b>																				
Power cables	32	Flange receptacle	PE-PUR				3				3				3				3	12
Optic fiber	2	Swagelok	Inconel				4				4				4				4	16
Displacement	8	Swagelok	Titanium												6					6
<b>Bentonite</b>																				
Total pressure	8	Swagelok	Titanium/Polyamid			27								27						54
Pore pressure	8	Swagelok	Titanium/Polyamid	14										14						28
Relative humidity R	8	Swagelok	Titanium/Polyamid			17						17								34
Relative humidity V	8	Swagelok	Titanium/Polyamid						20											20
Temperature	4	Swagelok	Cupronickel	32								32								64
<b>Backfill</b>																				
Total pressure	8	Swagelok	Polyamid						9										12	21
Pore pressure	8	Swagelok	Polyamid						11										11	22
Relative humidity W	8	Swagelok	Polyamid						20							25				45
Temperature	4	Swagelok	Cupronickel						9										11	20
Resistivity	25.7	Flange receptacle	Multicable											1						1
<b>Rock</b>																				
Hydro	4/6	Swagelok	Tecalan/Steel/Peek	40				49								31				120
Sampling	1/8"	Swagelok	PEEK	4												4				8
Resistivity	25.7	Flange receptacle	Multicable																	0
Temperature	4	Swagelok	Cupronickel	15										22						37
Rock mechanical	19	Swagelok	PE-PUR																	0
Acoustic emission	1/4"	Swagelok	PE-PUR																	0
Water drainage	8	Swagelok	Polyamid											6						6
Sum				59	46	44	7	49	49	20	7	49	41	13	29	35	25	34	7	514

## 2.2 Encapsulation of instruments and cables

### 2.2.1 Relative humidity sensors

The instruments measuring relative humidity were encapsulated in titanium. The instruments are delivered from three suppliers (Rotronic, Wescor and Vaisala). The principle of the Vaisala and Rotronic instruments is measurement of capacitance, while the Wescor instruments are psychrometers. A difference between Rotronic and Vaisala is that the Vaisala instruments have a maximum allowed length of the cable from the sensor to an electronic box (10 m). This means that the electronic box must be built in to a vessel and be left in the backfill. Rotronic have built in the required electronics in the sensor body and the rest can be placed at any distance from the sensor. Hence, these sensors had to be handled in different ways. A more detailed description of the instruments is given in /2-1/.

#### Rotronic

The sensor bodies were built into titanium cases, consisting of a house for the sensor body and a titanium tube for the cable. The titanium tubes were welded to the sensor houses. On top of the sensor houses, titanium filters were placed. The connections between the sensor bodies and the titanium were sealed with O-rings. In order to prevent water leakage through the sensor, after saturation of the bentonite, the bottom of the sensor houses was filled with epoxy and will withstand a water pressure of about 5 MPa. The length of the titanium tubes depends on the position of the sensors in the deposition holes.

The rest of the cables placed in the backfill were protected by polyamide tubes with an outer diameter of 10 mm and an inner diameter of 6 mm. Polyamide tubes of suitable lengths were thread over the electrical cables and connected to the titanium tubes with Swagelok ferrule connections. The gauges were then ready for installation on the intended flange. Ferrule connections were mounted on the flanges in advance (see Figure 2-4). The polyamide tubes were pulled through these to specified lengths in order to have suitable lengths left in the test tunnel together with the sensors. Before mounting the head flange on the cone, the ferrule connections were tightened.

#### Vaisala

The Vaisala gauges were delivered with 10 m long electrical cables, connecting the sensors to a box containing electronics. 10 m was the maximum lengths of each cable, which means that the electronic boxes had to be left in the test tunnel. The boxes were built in to special containers in pairs and the cables and sensor bodies were protected by titanium tubes. The work was done as follows:

1. The electrical cables were released from the electronic box by soldering.
2. The sensors were built in to titanium cases, consisting of houses for the sensor bodies and titanium tubes for the cables. The titanium tubes were welded to the sensor houses. On top of the sensor houses, titanium filters were positioned. The sensor bodies were sealed against the titanium with O-rings. In order to prevent water leakage through the sensors, after saturation of the bentonite, the bottom of the sensor houses was filled with epoxy. The length of each titanium tube before

changing to polyamide tube depends on the position of the sensor in the deposition holes.

3. Polyamide tubes were pulled over the rest of the cable, leaving about 30 cm free. Swagelok ferrule connectors were used to connect the titanium tubes and the polyamide tubes.
4. Swagelok ferrule connectors were mounted on the cap of the electronic box. The free ends of the electric cables were then pulled through these and connected to the electronic box. The ferrule connections were fastened.
5. Function tests and calibrations of the sensors were done after soldering.
6. Titanium filters were positioned on the top of the encapsulation.
7. The tubes containing multi wire cables, for voltage supply and output signals were pulled through a flange. They were pulled through from the low-pressure side in order to minimize the pulling length. One tube was connected to each vessel containing the electronic boxes. This was done after installation of the sensors.

## **Wescor**

The sensors were built into titanium cases, consisting of houses for the sensor bodies and titanium tubes for the cables. The titanium tubes were welded to the sensor houses. On top of the sensor houses, titanium filters were positioned. In order to prevent water leakage through the sensor after saturation of the bentonite, the bottom of the sensor houses was filled with epoxy. Before installation, the cable was split, exposing the leaders. Epoxy was then injected, sealing the leaders and the volume in the tube. Laboratory tests have shown that the sealing can withstand a water pressure of 5 MPa.

### **2.2.2 Encapsulation of other sensors**

The sensors from Geokon and Kulite were manufactured in titanium. The electrical cables from the sensors were protected by titanium tubes of different lengths in order to protect the cables the entire way through the bentonite. The titanium tubes were welded to the sensor bodies. When entering the backfill, the tubes were converted to polyamide tubes (see next chapter).

The thermocouples were manufactured in cupro nickel and did not need any additional protection.

## **2.3 Leading sensor cables in polyamide tubes**

All sensor cables were led in polyamide tubes in order to protect the cables and to make a secure sealing when they pass through the head flange. The following types of polyamide tubes were used:

1. Outer diameter 10 mm and inner diameter 6 mm. This tube was used for cables from Vaisala (20 pcs) and Rotronics (34 pcs).
2. Outer diameter 8 mm and inner diameter 5 mm. This tube was used for cables from Kulite(56 pcs), Geocon (69 pcs) and Wescor (45 pcs).

The work leading a cable through a polyamide tube was done as follows:

- A polyamide tube was uncoiled in its whole length, i.e. 80 m.
- A thin string was sucked through the polyamide tube by use of a vacuum pump.
- A Swagelok ferrule connector was mounted on the tube end in order to connect the polyamide tube to the sensor.
- The string was then connected to the cable with the sensor and pulled through.
- The Swagelok connector was fastened, connecting the polyamide tube to the sensor.

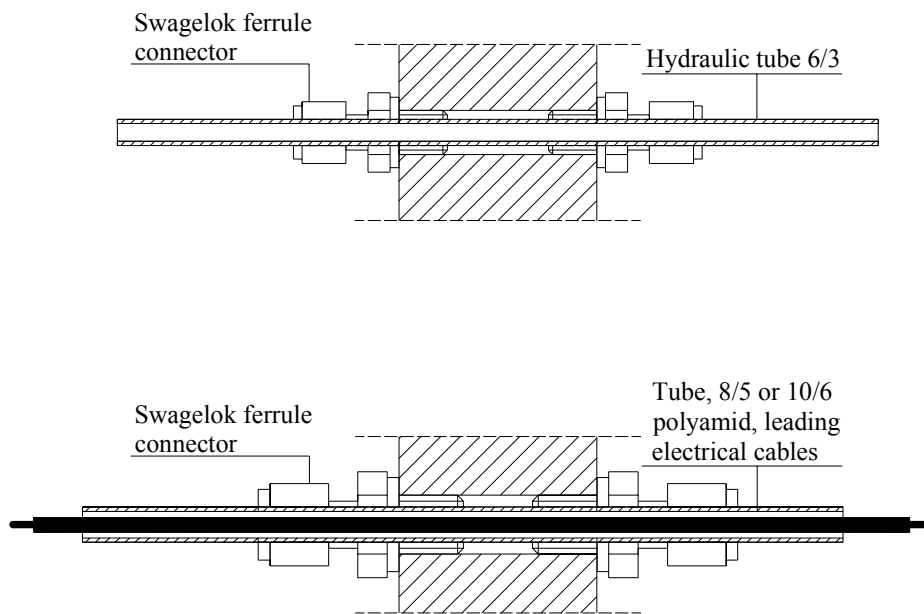
The tube with the connected sensor was then coiled and stored.

## **2.4 Preparation and mounting of “cable parcels”**

### **2.4.1 Assembling of cable parcels**

All cable/tube parcels, except for the one leading out cables from the canisters, were prepared in advance. The mounting was done in the A-tunnel, outside the Prototype tunnel. The parcels leading out cables from the canister could not be prepared in advance since the optic fiber cables was already fixed to the canister surface. This meant that these cable parcels had to be assembled when the canisters were installed.

Function testing of all instruments was done before mounting them on the flange except for the Rotronic relative humidity sensors and the Geokon pressure sensors. These sensors were tested after installation of the cable parcels.



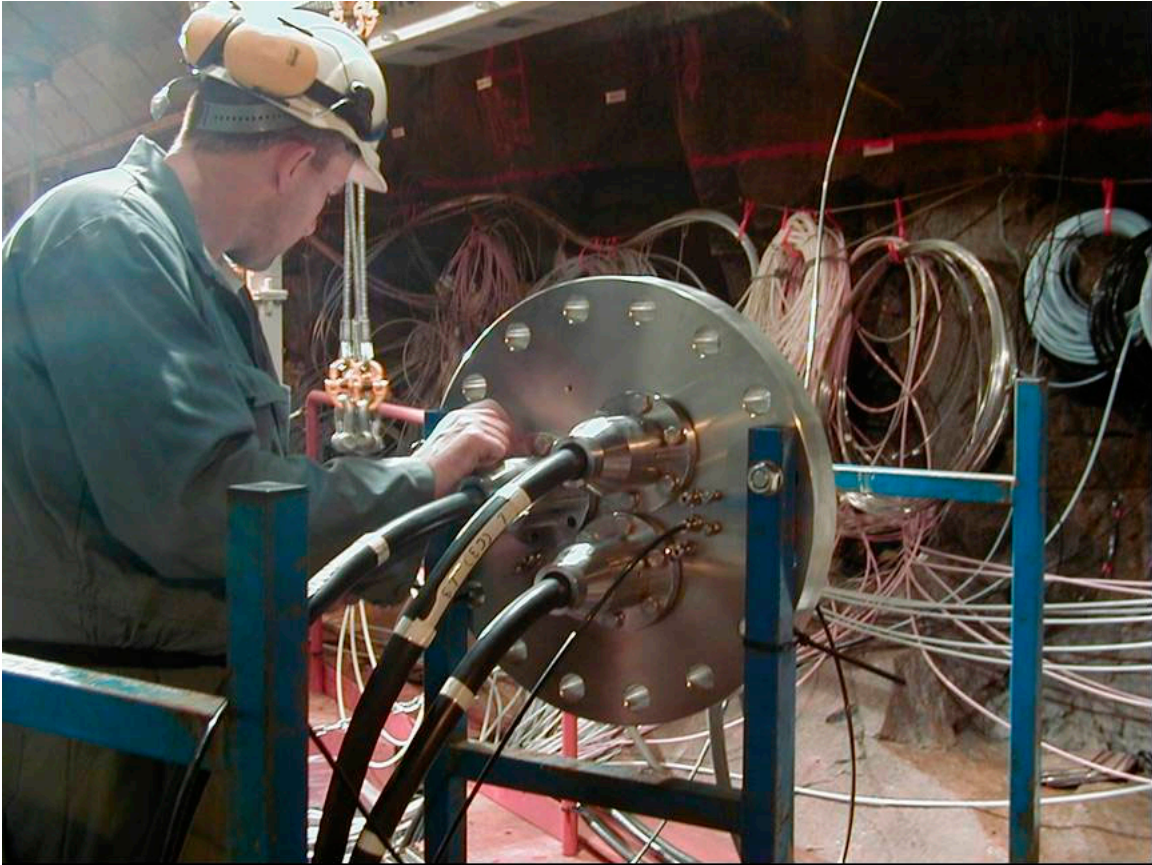
**Figure 2-4.** Schematic view, showing how the hydraulic tubes (upper) and electrical cables were sealed on their way through the head flanges.

#### 2.4.2 Parcels including cables from the canister

Each flange containing cables from the canister was mounted on a wagon with wheels designed for the purpose. The wagon with the cables was placed close to the deposition hole. Two types of cables were led in these parcels:

1. **Fiber optic cables, measuring temperature and displacement.** All tube fittings, for the fiber optic cables, were mounted on the flange. The cables were then pulled through the tube fittings, until a specified length remained.
2. **Electric power cables.** Flange receptacles were mounted on these cables in advance, which mean that the cables were pulled through holes in the head flange until the pre mounted flanges reached the head flange. They were then fixed to the head flange by bolts. Gaskets were mounted before pulling the cables through the head flange.

The cables were ID-marked in both ends and gathered by strings every meter. Depending on the cable lengths and the limited space in the tunnel, the tube parcels were led out from the TBM-tunnel and then back again to the specified lead through hole before the installation.



*Figure 2-5. Photo showing the assembling of a cable parcel with cables from canisters.*

### **2.4.3 Parcels including cables from bentonite, backfill and rock**

These parcels were installed in advance i.e. before the deposition of the bentonite blocks. The procedure was the same as described for the cables from the canisters except that the wagon with the flange was placed outside the Prototype tunnel where the assembling was done. The work was done as follows:

1. Each flange was mounted on the wagon. The flanges were fixed during mounting of the tube fittings and installation of the tubes. All tube fittings were mounted on the flange according to directions.
2. The tubes were pulled through the tube fittings. They were handled somewhat different depending on the type of tube as follows:

#### **Kulite, Geocon, Wescor and Rotronic:**

The tubes, with the sensors in one end and the electric cables covered with polyamide tubes in the other, were pushed through the flange from the high-pressure side. This means that about 90 m had to be pushed through.

### **Vaisala**

The tubes containing the electric cables (which were later connected to the vessels, containing the electronic boxes from two sensors) were pushed through the tube fittings from the low-pressure side, which means that about 15 m had to be pushed through.

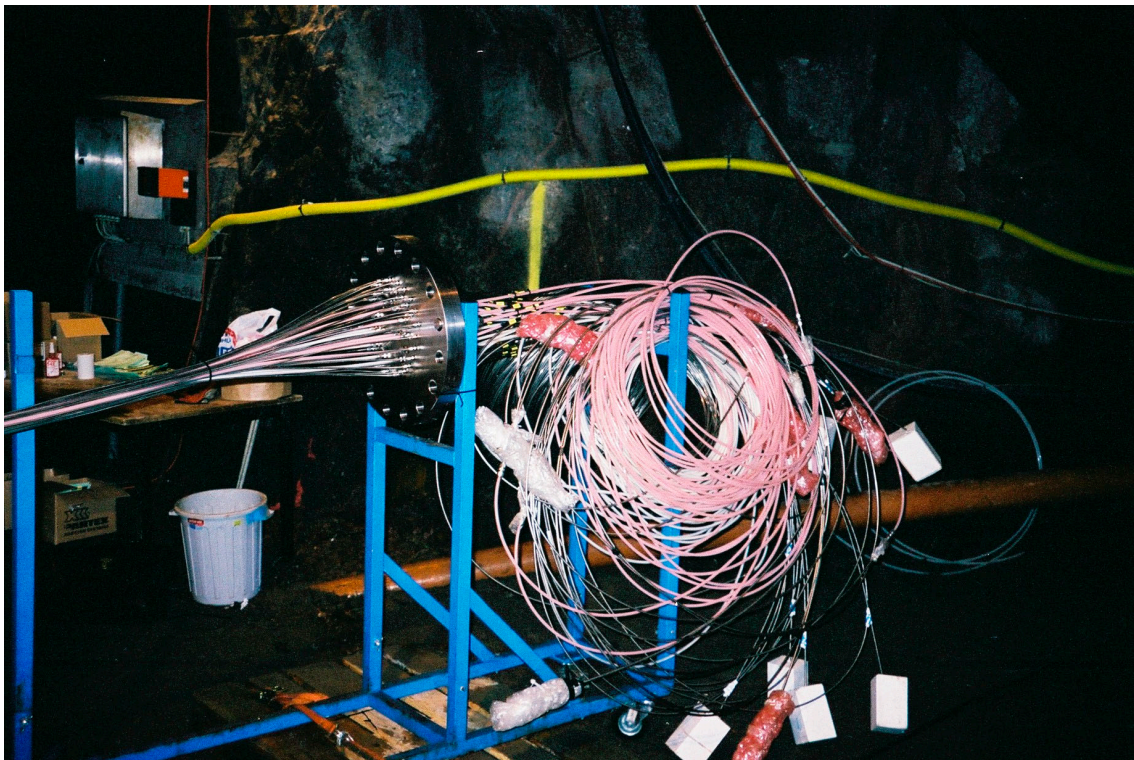
### **Thermocouples**

The thermocouples were pulled through the tube fittings from the low-pressure side, which means that about 15 m had to be pushed through.

### **Hydraulic tubes, sampling and hydro-chemical tubes**

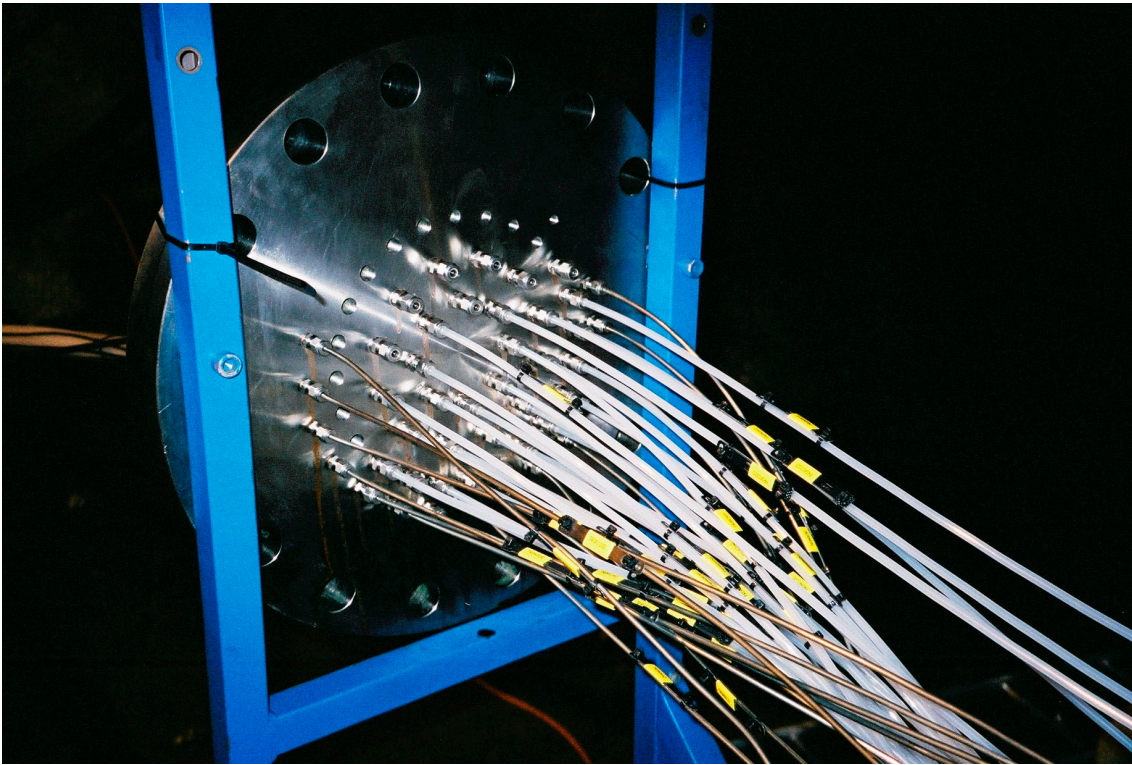
The hydraulic tubes were handled like the thermocouples i.e. they were pushed through from the low-pressure side to a specified length.

3. Each tube installed was marked with a special ID number in both ends.
4. When all tubes were mounted and the lengths on the high-pressure side had been controlled, the tube fittings on the flange were fastened.
5. The tubes on the low pressure side i.e. the tubes that later were pulled through the rock, were collected in a parcel by strings placed every meter. This facilitated the installation. The tubes on the high-pressure side were rolled together and locked with strings. These cable rolls were then hung on the rock wall until the sensors were installed in the bentonite, backfill or rock.



*Figure 2-6. A photo showing the assembling of a cable parcel including cables from the buffer and backfill.*

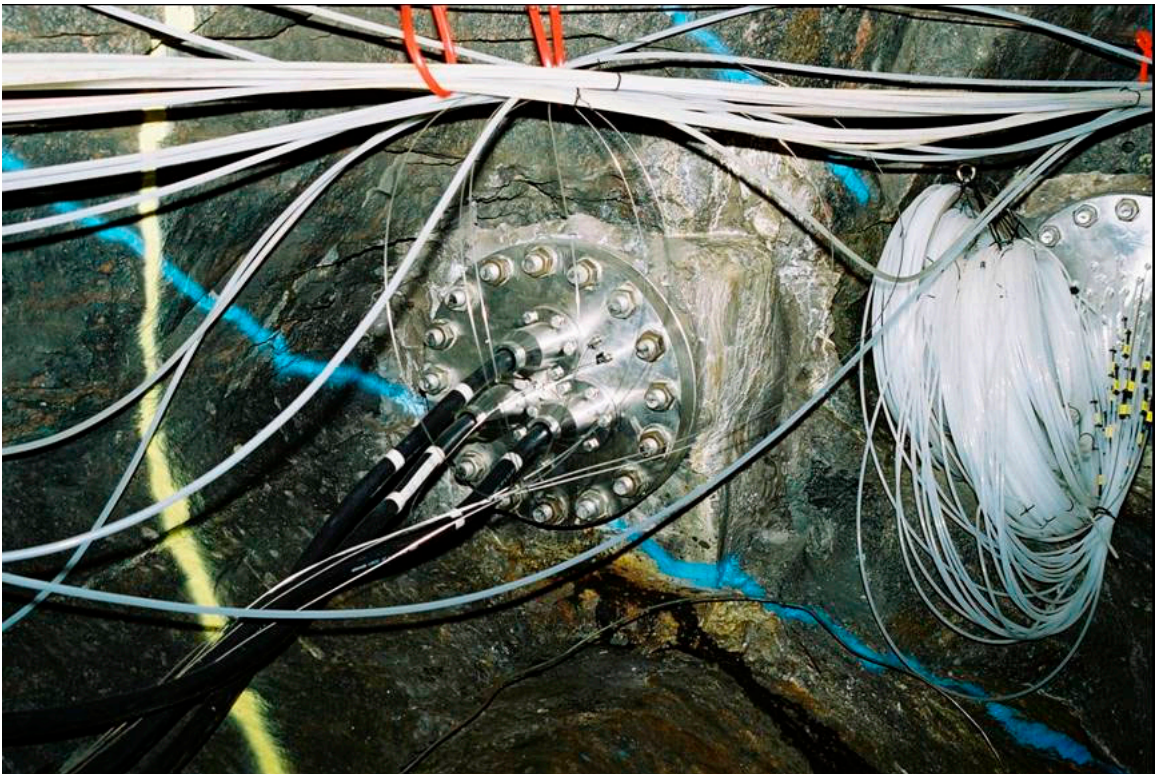
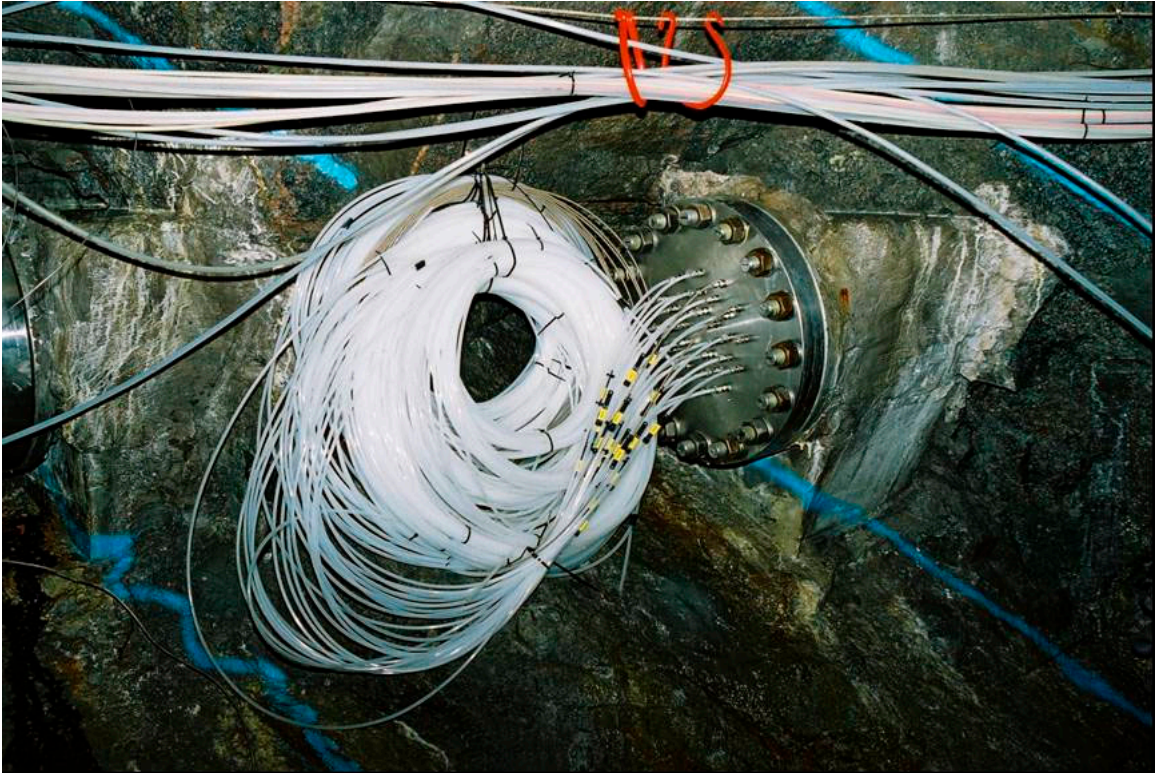




*Figure 2-7. A photo showing the assembling of a cable parcel, including cables from the buffer and backfill. Every tube was marked in several positions on both sides of the flange.*

#### **2.4.4 Procedure for installing a cable parcel**

1. All tube fittings on the flange were checked and fastened.
2. A steel wire was pushed through the lead through hole from the G-tunnel.
3. A gasket was mounted on the steel collar in the Prototype tunnel.
4. The end of the cable parcel was fastened to the steel wire.
5. The cable parcel could then be pulled through the borehole. One man pulled the wire from the G-tunnel and one guided the tubes when they were entering the borehole. Two or three man lifted and guided the cables in the Prototype tunnel.
6. When only a few meters remained, the head flange was released from the wagon and lifted by hand the final meters to the steel collar. The flange was then fastened to the collar by bolts.



**Figure 2-8.** Photos showing cable parcels installed in the rock. The upper photo shows a cable parcel containing tubes that are intended for rock measurements. The lower shows a parcel containing cables from a canister.

## **3 Preparation of bentonite blocks for instruments and cables**

### **3.1 General**

The main preparation of the bentonite blocks was done at Hydroweld in Ystad i.e. at the same place as where the blocks were manufactured. The activity required access to a large hall of about 100 m<sup>2</sup> and a truck in order to facilitate the lifting and covering the blocks.

The work on the block was done with the following equipment:

- A core-drilling machine (Hilti)
- A hand hold drilling machine
- A large vertical drilling machine
- A hand hold cutter
- Different rulers and a pair of compasses

### **3.2 Location of instruments in the bentonite**

#### **3.2.1 Brief description of the instruments**

The different instruments that were used in the experiment are briefly described in this section. A more detailed description is given in /2-1/.

#### **Measurements of temperature**

Thermocouples from Pentronic were used to measure temperature. Measurements are done in 32 points in each instrumented deposition hole. In addition, temperature gauges are built into the relative humidity sensors and the pressure gauges of vibrating wire type. Temperature is also measured on the surface of the canisters with optical fiber cables /2-1/.

#### **Measurement of total pressure**

Total pressure is the sum of the effective stress and the pore water pressure. It is measured in totally 27 points in each test hole with the following instrument types:

- Geokon total pressure cells with vibrating wire transducers. 16 cells of this type were installed in each instrumented test hole.
- Kulite total pressure cells with piezo resistive transducers. 11 cells of this type were installed in each instrumented test hole.

### **Measurement of pore water pressure**

The pore water pressure is measured in totally 14 points in each test hole with the following instrument types:

- Geokon pore pressure cells with vibrating wire transducers. 8 cells of this type were installed in each instrumented test hole.
- Kulite pore pressure cells with piezo resistive transducers. 6 cells of this type were installed in each instrumented test hole.

### **Measurement of the water saturation process**

The water saturation process is measured in totally 37 points in each instrumented test hole with the following techniques:

- Vaisala relative humidity sensors of capacitive type. 20 cells of this type were installed in each instrumented test hole.
- Rotronic relative humidity sensors of capacitive type. 17 cells of this type were installed in each instrumented test hole.

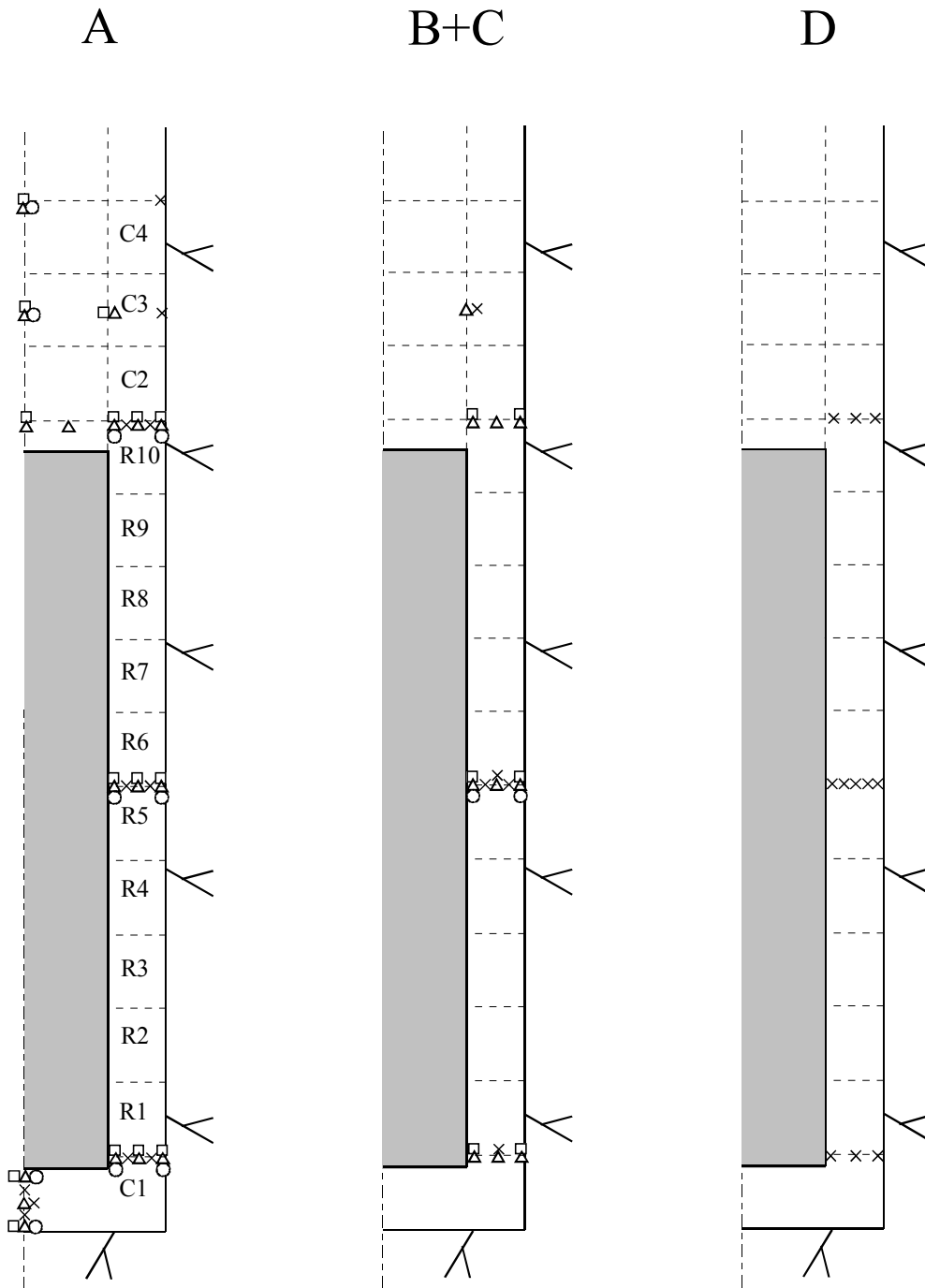
#### **3.2.2 Strategy for describing the position of each device**

The instrumented deposition holes in section 1 are termed DA3587G01 (hole 1) and DA3575G01 (hole 3). Measurements are done in four vertical sections A, B, C and D according to Figure 3-1 and 3-2. Direction A - C correspond to the direction of the tunnel axis with A headed against the end of the tunnel i.e. almost west.

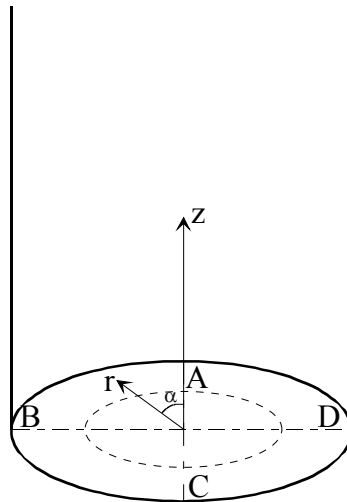
The bentonite blocks are called cylinders and rings. The cylinders are numbered C1-C4 and the rings R1-R10 respectively (Figure 3-1).

- pore water pressure + temp.
- total pressure + temp.
- × temp.
- △ relative humidity (+ temp.)

1m



**Figure 3-1.** Schematic view of the instrument positions in four vertical sections and the block designation.



**Figure 3-2** *The coordinate system used when describing the instrument positions in the deposition holes.*

Every instrument is named with a unique name consisting of 1 letter describing the type of measurement, 1 letter describing where the measurement takes place (buffer, backfill, rock or canister), 1 figure denoting the deposition hole (1-4) or A for the main tunnel, and 2 figures specifying the position in the buffer according to a separate list. Every instrument position is described with three coordinates according to Figure 3-2. The r-coordinate is the horizontal distance from the center of the hole and the z-coordinate is the height from the bottom of the hole (the block height is set to 500mm). The  $\alpha$ -coordinate is the angle from the vertical direction A (almost West).

The final position of each instrument in the deposition holes is presented in Chapter 4.5.

### **3.3 Position of each cable and tube on the bentonite block periphery**

All cables and tubes from the instruments in the bentonite blocks, the four optic cables the three power cables from the canister were planned to be led out of the hole along the bentonite block periphery surface.

Since the cables and tubes were led in the gap between rock and bentonite in the deposition holes it was important to distribute them on the block periphery in a prescribed order. Every cable or tube was assigned an  $\alpha$ -coordinate, which is the angle from direction A (Figure 3-2). The cables were led from the sensor in this direction in pre-manufactured tracks on the block surface.

### 3.3.1 Cables and tubes from instruments in the bentonite

All instrument cables were led in titanium tubes ( $\text{Ø}$  8 mm or  $\text{Ø}$  6 mm) except for the thermocouples ( $\text{Ø}$  4 mm), which are made of cupro nickel. Tracks were made on the block surface from the instrument position in the bentonite block to the specified position on the bentonite block periphery, where they were bent and led vertically along the bentonite blocks. Expandable strings were placed on every third block in order to fix the cables.

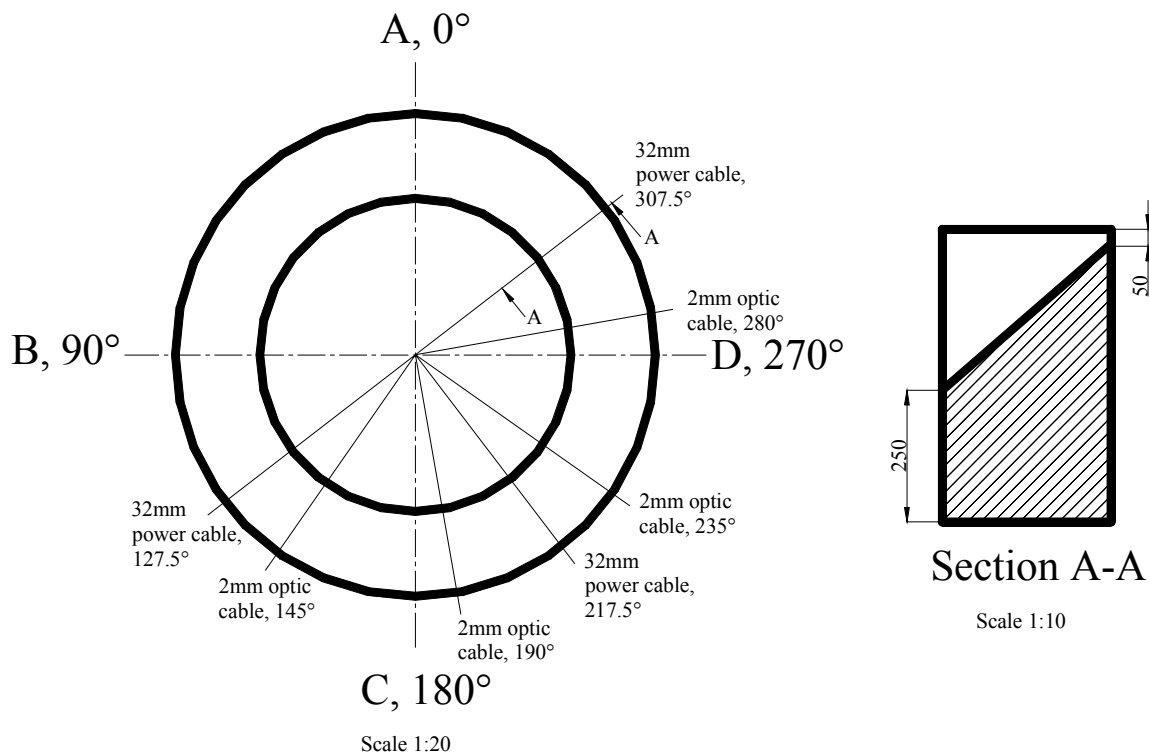
### 3.3.2 Cables from the canister

The following cables are coming from the canisters:

- 3 x 32 mm power cables from the electrical heaters
- 4 x 2 mm fiber optic cables (two loops) from the temperature measurements on the canister surface

The directions of the cables are shown in Figure 3-3.

The cables were led from the canister through the bentonite in slots sawed in advance in block no R10 (see Figure 3-3). The cables were then led out from the hole along the slot between the bentonite blocks and the rock surface.



**Figure 3-3** Figure showing the directions of cables from the canister relative the instrument directions A, B, C and D in block R10. In this block slots were sawed in order to let the cables from the canister pass through the bentonite and out to the rock. The widths of the slots are about 40 mm for the power cables and about 5 to 10 mm for the optic cables.

## 3.4 Preparation of the bentonite blocks

### 3.4.1 Clearances for instruments

Every instrumented block was prepared in advance. The preparation was somewhat different depending on instrument type.

#### Thermocouples

- The thermocouples have an outer diameter of 4.0 mm. A handhold boring-machine was used at installation. *Working:* Borehole Ø 5 mm; depth 50-450 mm.

#### Total pressure

- **Geokon.** The transducers are shaped as ice hockey pucks with a diameter of 125 mm and a thickness of 22 mm. The instruments were countersunk in the bentonite block surface by use of a handhold cutter. *Working:* Borehole Ø 126-130 mm; depth 25 mm.
- **Kulite.** The transducers are shaped as ice hockey pucks with a diameter of 55 mm and a thickness of 23 mm. All instruments were placed vertically, which means that an almost rectangular hole is needed. The clearances were done by drilling 2-3 holes with a diameter of 25 mm in a row and then form the hole with a chisel. *Working:* Borehole Ø 25mm; depth 160-250 mm. The shape of the rectangular hole was cut with a chisel.

#### Pore pressure

- **Geokon.** Shaped as cylindrical tubes with 25 mm outer diameter and 127 mm length. The holes for these gauges were bored with a drilling machine of Hilti-type fixed with a vacuum plate. *Working:* Borehole Ø 27mm; depth 250mm.
- **Kulite.** Shaped as a cylindrical tube with 19 mm outer diameter and 55 mm length. The holes for these gauges were bored with a drilling machine of Hilti-type fixed with a vacuum plate. *Working:* Borehole Ø 20mm; depth 160-250 mm.

#### Relative humidity

- **Vaisala.** Shaped as cylindrical tubes with 22 mm outer diameter and 63 mm length. The holes for these gauges were bored with a drilling machine of Hilti-type fixed with a vacuum plate. *Working:* Borehole Ø 23 mm; depth 160-250 mm.
- **Rotronic.** Shaped as cylindrical tubes with 22 mm outer diameter and 135 mm length. The holes for these gauges were bored with a drilling machine of Hilti-type fixed with a vacuum plate. *Working:* Borehole Ø 23mm; depth 250 mm.
- **Wescor.** Shaped as a cylindrical tube with 22 mm outer diameter and 70 mm length. The holes for these gauges were bored with a drilling machine of Hilti-type fixed with a vacuum plate. *Working:* Borehole Ø 23mm; depth 160-250 mm.



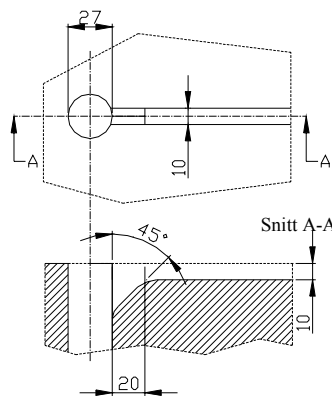
## Other measurements

- **Aitemin.** Aitemin are measuring canister displacements. The instruments are located in deposition hole 3, in block C1. Most of the preparation was done during installation. Three vertical holes were drilled in advance. *Working:* Borehole  $\text{\O} 40$  mm, through the block.

### 3.4.2 Tracks for cables and tubes on the bentonite blocks surface

Tracks for the cables from each instrument to the block periphery were made on the block surface. The tracks were made by a handhold cutter.

*Working:* For all tubes from the instruments, except for the thermocouples, tracks with the dimension 10 x 10 mm were made. For the thermocouples tracks with the dimension 6 x 6 mm were made. Close to the sensor holes, the tracks were made deeper in order to let the tube have a smooth bend (Figure 3-4).



**Figure 3-4.** Schematic view showing an example of how the tracks on the bentonite block surface were connected to the sensor holes.

### 3.4.3 Clearances for cables through block R10

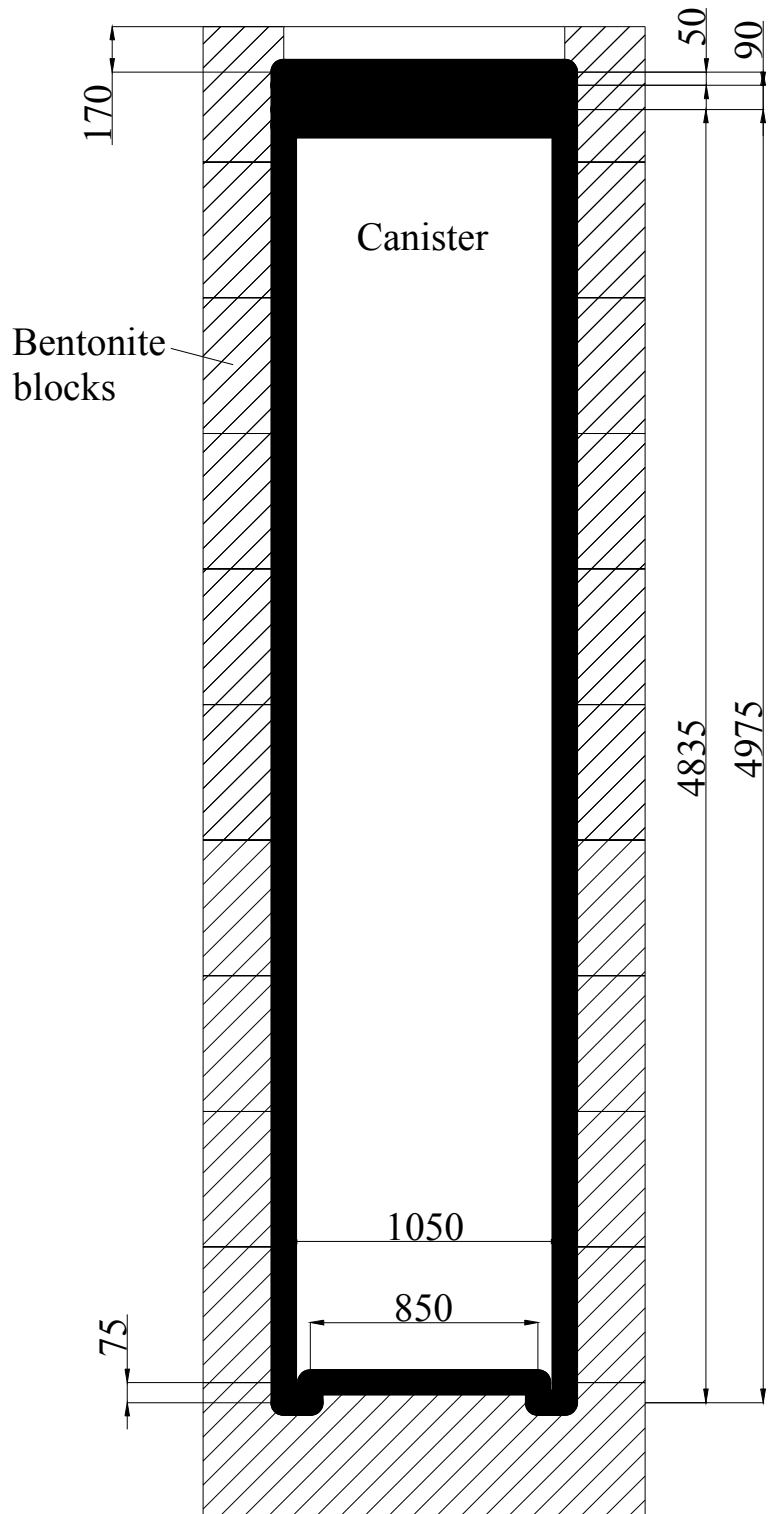
The cables from the canisters were led through the bentonite in block R10 by sawing slots in the bentonite block in advance (see Figure 3-3). The slots have different width depending on the cable type. They were sawed with an alligator-type of saw.

*Working:* The depth and shape of the slots are shown in Figure 3-3. The widths of the slots are about 40 mm for the power cables and 5 mm for the fiber optic cables.

#### **3.4.4 Clearances for the bottom of the canister in block C1**

The canisters are standing on the cylindrical bottom block. The canisters are by design equipped with a skirt on the bottom (see Figure 3-5). A corresponding track was drilled with a drilling machine of Hilti-type fixed with a vacuum plate.

*Working:* Holes with a diameter of 120 mm were seam-drilled to a depth of 85 mm. The track was then worked out by cutting with chisels.



**Figure 3-5** Schematic view of a canisters position in relation to the position of the bentonite blocks.



## 4 Installation of the buffer and the canisters

### 4.1 General

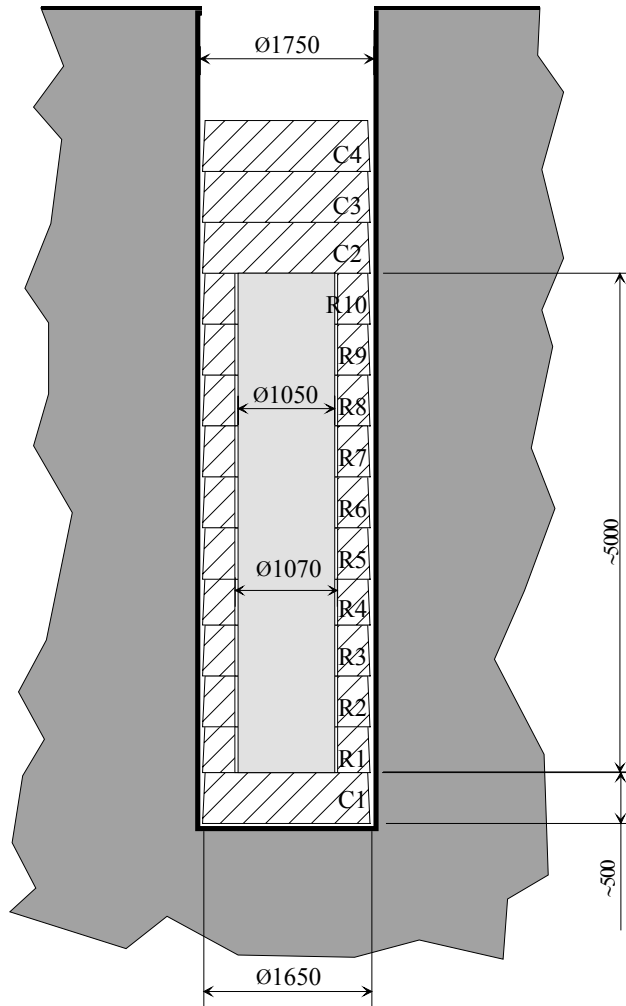
The blocks used for buffer material in the Prototype Repository were made of Na-bentonite MX-80 mixed with tap water and were compacted to two different shapes; ring shaped blocks, which are placed around the canister and massive cylindrical blocks, which are placed above and under the canister. The blocks were uniaxially compacted in a rigid form to an outer diameter of about 1650 mm and a height of about 500 mm. The inner diameter of the ring shaped blocks is about 1070 mm. In order to have similar average density everywhere (including the slots), the two types of blocks were compacted to different densities (see Chapter 4.4 in this report). The initial average weight, water ratio, density and void ratio of the two types of block are listed in Table 4-1. The table also shows the load and compaction pressure used at the compaction. The technique for compacting the blocks is described in detail in /4-1/.

**Table 4-1 Determined parameters for blocks used in the test.**

Block type	Weight (kg)	Water ratio (%)	Density (kg/m <sup>3</sup> )	Degree of saturation	Void ratio	Compact. load (MN)	Compact. pressure (MPa)
Ring	1278	17.1	2105	0.870	0.546	121	100
Cylinder	2147	17.8	2034	0.810	0.610	84	40

The buffer material and canisters have been installed in DA3587G01 (Deposition hole 1, Dh 1), DA3581G01 (Dh 2), DA3575G01 (Dh 3) and DA3569G01 (Dh 4). Transducers were installed in the buffer in deposition holes Dh1 and Dh3. The deposition was done in the following order: Dh2, Dh4, Dh3 and Dh1. During preparation and installation the blocks were designated according to Figure 4-1. The activities carried out during the installation of the buffer are listed in Table 4-2. The table is valid for deposition holes Dh1 and Dh3 where transducers were installed. For the two other deposition holes activities with number 5, 7, 9, 16 and 18 were not performed. The activities are described in detail in Chapter 4.2.

After installation of the canister and the buffer in Dh 2, it was discovered that one of the connectors for the heaters had been damaged. In order to repair the canister it had to be taken up from the deposition hole. This work is described in Chapter 4.3.



**Figure 4-1** Designation of blocks in the deposition hole (prefix Dh 1, Dh 2 Dh 3 and Dh 4 for the different deposition holes).

**Table 4-2 List of activities performed during the installation.**

<b>ID</b>	<b>Activity</b>
1	Preparation of the deposition hole
2	Mounting of gantry-crane
3	Installation of water protection sheet in the deposition hole
4	Deposition of bentonite block C1.
5	Instrumentation of bentonite block C1
6	Deposition of bentonite blocks R1-R5.
7	Instrumentation of bentonite block R5
8	Deposition of bentonite blocks R6-R10.
9	Instrumentation of bentonite block R10
10	Transportation of canister
11	Mounting of the deposition crane
12	Deposition of canister
13	Connecting heaters and cables
14	Installation of small blocks on the lid of the canister
15	Deposition of bentonite blocks C2 and C3
16	Instrumentation of bentonite block C3
17	Deposition of bentonite block C4
18	Instrumentation of bentonite block C4
19	A plastic sheet was placed over the uppermost block C4
20	Installation of displacement and moisture transducers
21	Restoring the road bed
22	Continuous registration of displacement and moisture
23	Filling bentonite pellets

## **4.2 Procedures for deposition of buffer and canisters**

### **4.2.1 Preparation of the deposition holes**

The following preparations of the deposition holes were done before start deposition:

#### **Cleaning of the deposition holes**

The deposition holes were cleaned before the installation of the buffer. This work was done with a vacuum cleaner.

## **Placing pumps in the sump in the tunnel inside deposition hole 1 (DA3587G01)**

Two pumps were placed in the sump in the tunnel inside deposition hole 1. The electrical cables for each pump were led through the rock mass to the G-tunnel in three separate tecalan tubes. The water coming from the pumps was led in 6 tecalan tubes through the rock in to the G-tunnel. The tubes have an inner diameter of 6 mm.

## **Mounting of pumps in the deposition holes**

One pump was temporarily installed in each of the deposition holes 2, 3 and 4. In hole 1, two pumps were installed. The pipes used for pumping up water had an inner diameter of 21 mm. The length of the pipes was about 7.5 m. The pipes were cut in 45° at one end. The pipes were placed standing in the sump with the 45° end in the sump and the other end attached to the surface of the deposition hole. A hose leading from the drainage pipe to the pump and from the pump to the spillway was mounted.

A separate float switch was placed together with the drainage pipes in the sump to secure that the water level never exceeded the top of the concrete slab.

## **Installation of a system for filling the slot between the bentonite blocks and the surface of the deposition hole with water**

Four tecalan tubes were installed in each deposition hole. The tubes were attached to the rock surface at the bottom of the deposition hole so that they could be removed after filling of bentonite pellets and water in the slot. The water filling of the voids between the pellets was never performed.

### **4.2.2 Mounting of gantry-crane**

The mounting of the gantry-crane over the deposition hole was done in the following steps:

- The gantry-crane was transported to the Prototype tunnel with a front loader.
- The position of the gantry-crane in the tunnel during deposition was determined (input for the calculation is the co-ordinates of the centre of the deposition hole and the dimensions of the gantry-crane)
- A surveyor's assistant marked the positions of the four feet of the gantry-crane on the tunnel floor.
- The gantry-crane was placed over the deposition hole with its feet placed in the marked positions.
- A check was made that the gantry-crane was placed in a horizontal position (with a spirit level)
- The gantry-crane was operated according to the manual for the crane.



### **4.2.3 Installation of water protection sheets in the deposition hole**

A plastic sheet formed as a large tube with a diameter of 1910 mm was attached to the rock surface of the deposition hole in order to prevent wetting of the bentonite buffer during the installation phase. The sheet was attached to the concrete slab with an O-ring. The O-ring was removed after the installation of the buffer and the canister and the plastic sheet was pulled up from the deposition hole before the slot between the compacted bentonite blocks and the rock surface was filled with pellets of bentonite.

### **4.2.4 Deposition of bentonite block C1 and R1-R10**

The deposition of the bentonite blocks was made in the following steps:

- The bentonite block was transported to the gantry-crane in its case with a loader.
- The cap of the case was removed with the loader.
- The number on the case was noted and the height of the blocks measured in four positions. The diameter of the block was also measured and noted.
- The block was examined by eye. Any observed damages on the blocks were noted
- The block was attached to the lifting equipment with four straps and moved in position and lowered in the deposition hole with a gantry-crane (see Figure 4-2).
- The block was centred in the deposition hole. The final adjustment of the position of the block was made just before the block was put in place in the deposition hole.
- After placement, the four straps were released from the block and the lifting equipment was removed from the deposition hole.
- The depth from the upper part of the deposition hole to the upper surface of the block was measured with a tape measure in four positions and noted in a protocol. Also the radial distance from the rock surface to the outer diameter of the block was measured in four points.
- The final height of the bentonite buffer was measured by levelling the uppermost block.



*Figure 4-2 A bentonite block attached to the lifting equipment with four straps.*

#### **4.2.5 Instrumentation of bentonite block C1, R5 and R10**

The preparation of the bentonite blocks for the instrumentation is described in Chapter 3 in this report. The installation of each instrument was done in the following steps:

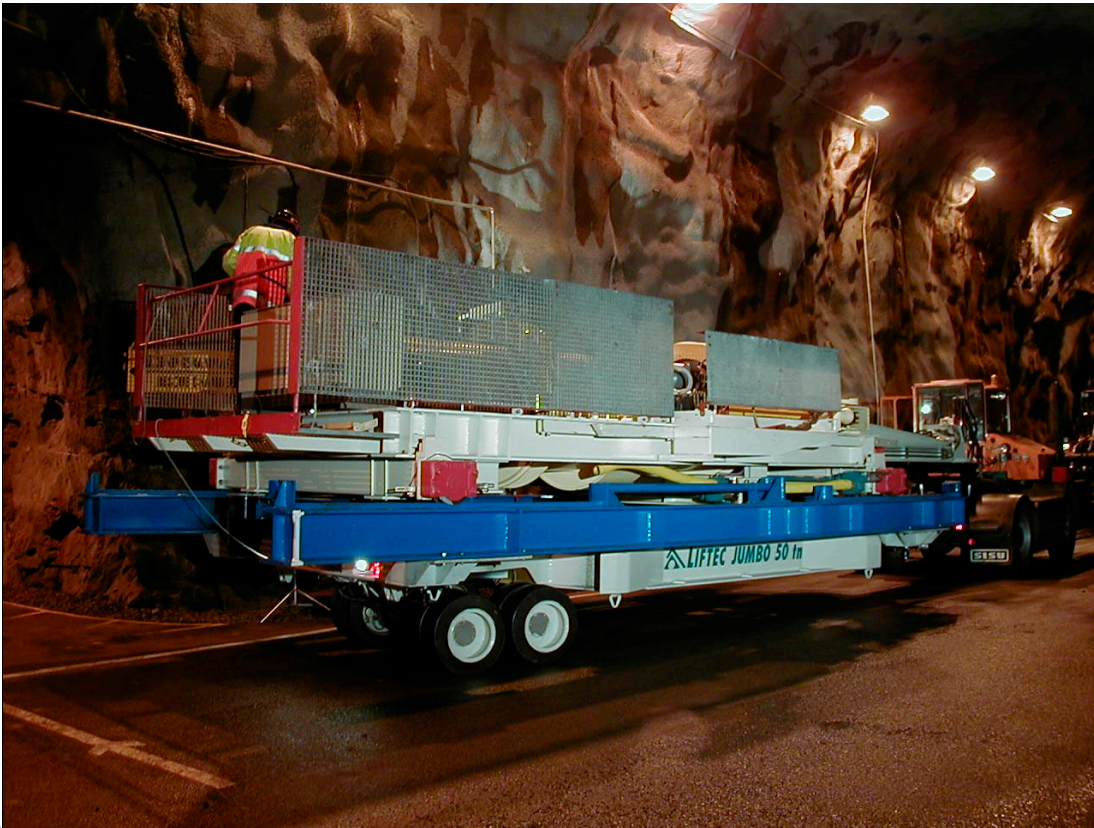
- The tube with the transducer was taken from the packages hanging on the tunnel wall. The mark on the transducer was checked against the list in protocols.
- The tube with the transducer was lowered in the deposition hole.
- The position of the transducer was checked and noted.
- The tube was bent to fit the holes and the grooves in the block and the transducer was installed.



*Figure 4-3* A photo taken after installation of the bottom block and the first bentonite ring, showing also the plastic sheet and several transducers installed in the bottom block.

#### **4.2.6 Transportation of the canisters**

The canisters were transported in to the tunnel placed on the deposition-machine in a horizontal position. A trailer had been constructed for the transportation of the machine. The deposition-machine with the canister was placed on the trailer, which was attached to a heavy vehicle and transported down the Äspö tunnel to the level -420 m. During transportation a front loader had to be connected to the back of the trailer in order to keep the trailer in the right position. Finally, a small truck of type SISU was used for transportation of the trailer with the canister from level -420 to the Prototype Tunnel.



*Figure 4-4 The canister and deposition-machine placed on a trailer.*

#### **4.2.7 Mounting of the deposition machine**

The trailer with the deposition-machine was placed over the deposition hole with the SISU truck. The position of the adjustable four legs of the deposition machine was marked on the roadbed by a surveyor's assistant in advance. Small adjustments of the trailer were made in order to get the legs over the marked positions. The deposition machine was then lifted with the adjustable legs and the trailer was pulled out from the tunnel. The deposition machine was levelled, the sidewalks were mounted and the transport locking devices of the canister were removed.

#### **4.2.8 Deposition of the canister**

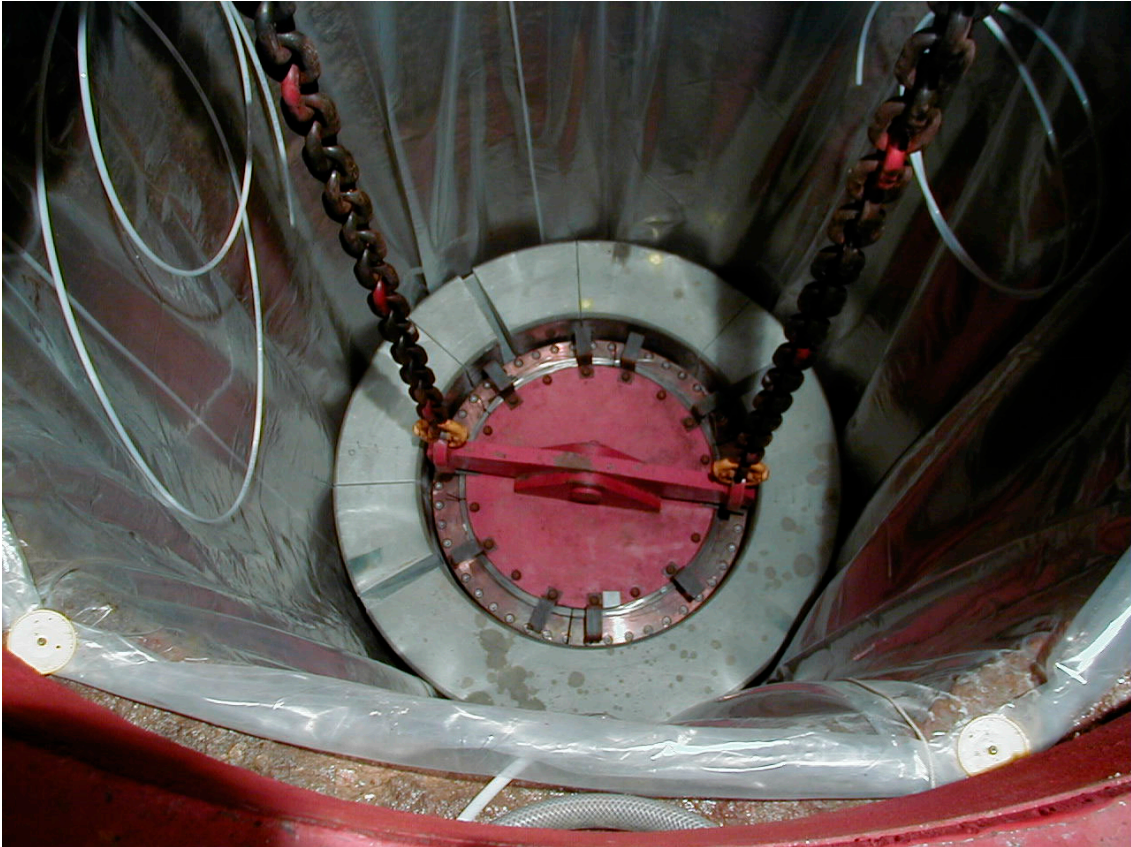
The canister was placed horizontally on the deposition machine in a frame which could be moved both horizontally and vertically relative the rest of the machine. A lifting plate with two large chains was attached to the lid of the canister. The chains were used for lifting the canister into the deposition hole. The work was done in the following steps:

- The canister was placed in a vertical position over the deposition hole by tilting the canister and at the same time move the frame both in horizontal and vertical direction.
- By using the chains the canister was moved vertically in to the deposition hole in steps.

- The lifting plate was unscrewed from the lid of the canister and lifted from the deposition hole with the chains in steps.
- The frame was tilted to a horizontal position. The sidewalks on the sides were removed and the transport locking devices were put in place.
- The trailer was placed under the deposition-machine with the SISU truck and the deposition machine was placed on the trailer by shorten the adjustable legs. The trailer was then pulled out from the tunnel.



*Figure 4-5 The canister tilted into the deposition hole.*



*Figure 4-6 The canister placed in the deposition hole.*

#### **4.2.9 Connecting heaters and cables on the canister**

The cables from the heaters were connected to the system for generating power. Furthermore the optical cables for measuring the temperature on the surface of the canister were connected to the data acquisition equipment. This work was done as follows:

- When the canister was placed in the deposition hole the lifting oak was demounted from the canister and removed from the deposition hole.
- A surveyor's assistant checked the position of the canister.
- The connectors for the power cables on top of the canister lid were checked. The result from the checking was noted in a protocol. Also the optical cables were checked.
- 12 bolts were unscrewed from the canister lid and 2 guide taps were attached to the boltholes.
- A ring of copper was mounted on the top of the canister and several intermediate partitions were attached to the lid of the canister.
- Three power cables with their outer plugs were attached to the canister. The cables were checked before they were attached to the canister.

- The cables from the heaters were lead through the intermediate partitions and out from the canister. The cables were sealed to the ring with silicon.
- The lid of the canister was cleaned with a vacuum cleaner
- The volume between the ring, the lid of the canister and the intermediate partitions was filled with a mixture of 30% bentonite and 70% sand.
- An upper lid was fastened to the canister with 12 bolts.
- Both the power cables and the optical cables were checked after the installation. The results from the measurements were noted in a protocol.



*Figure 4-7 The three connectors on top of canister lid are checked.*

#### **4.2.10 Installation of small blocks on the lid of the canister**

Highly compacted ring-shaped bentonite blocks will, after installation, surround the canister. The rings have a total height larger than the length of the canister. The resulting volume between the top of the canister and the top of the last ring was filled with small bentonite blocks (bricks with the dimensions  $233 \times 114 \times 65 \text{ mm}^3$ ). The average height of 10 ring shaped blocks is about 5050 mm and the length of the canister 4900 mm. The height of the volume filled with small bentonite blocks was thus about 150 mm. In order to have the same density at saturation at the top of the canister as the rest of the buffer, the bulk density of the volume filled with bricks had to be about  $1950 \text{ kg/m}^3$ .

The bricks were made of MX-80 bentonite with a water ratio of 17% at Höganäs Bjuv AB in Bjuv. They were made by uniaxial compaction of MX-80 bentonite with a water content of about 17%. Each block had a density of  $1.7 \text{ g/cm}^3$  and a weight of about 4 kg.

The placement of the small bentonite blocks was made as follows:

- The blocks were lowered in a basket to the top of the canister in the deposition hole.
- The placement was made by hand.
- In order to fill the volume above the canister some of the blocks were cut in smaller pieces. This was made with a saw.
- The weight of all the blocks installed was noted in a protocol for the purpose of calculating of the final bulk density. The slots between the blocks were filled with bentonite pellets and powder. The weight of the powder and the pellets was also noted in a protocol.



*Figure 4-8 Bricks of bentonite placed on top of the lid of the cansiter.*

#### **4.2.11 Deposition of bentonite blocks C2 – C4**

See Chapter 4.2.4.

#### **4.2.12 Instrumentation of bentonite block C3 and C4**

See Chapter 4.2.5.



#### **4.2.13 Covering of bentonite block C4 with plastic**

A plastic sheet was placed over the uppermost bentonite block (C4) and attached to the plastic sheet on the wall of the deposition hole with tape.

#### **4.2.14 Installation of temporary displacement and moisture transducers**

Two types of transducers were installed in order to measure the condition of the blocks during the time between the deposition of the bentonite blocks and the installation of the pellets. One transducer (Solartron B.I.C.M) for measuring the temporary deformation of the buffer was installed on top of the plastic sheet. The transducer was placed in a holder attached to the surface of the deposition hole. Another transducer was installed for measuring relative humidity (Vaisala RH transducer HPM 237) in the slot between the bentonite blocks and the rock surface inside the plastic sheet. The cables from the transducers were led through the A-tunnel to the G-tunnel and connected to the data acquisition equipment.

#### **4.2.15 Continuous registration of displacement and moisture**

RH in the deposition hole and displacements of block C4 were recorded every hour with the data acquisition equipment.

#### **4.2.16 Filling bentonite pellets**

In order to get a buffer with a sufficiently high density the slot between the bentonite blocks and the rock surface was filled with pellets of bentonite. The bentonite pellets had the width and length of 16.3 mm and a maximum thickness of 8.3 mm. The bulk density of the separate pellets varied between 1970 and 2110 kg/m<sup>3</sup>. The expected bulk density of the filling was between 1100 and 1300 kg/m<sup>3</sup>. The pellets were placed just before backfilling the uppermost part of the deposition hole.

The sequence was as follows:

- The plastic sheet on top of the bentonite block C4 was removed and the plastic sheet between the bentonite blocks and the wall of the deposition hole was pulled out of the hole.
- The pellets were delivered in big bags containing about 1 ton. The weight of all bentonite pellets used for the filling was noted.
- Several large tubes were attached to a vacuum cleaner and applied close to the slot between the bentonite blocks and the rock surface. With this arrangement it was possible to minimize the dust in the tunnel during the filling.
- The pellets blowing machine was filled with pellets. From the top of the last installed bentonite block the pellets were blown into the slot through a nozzle.

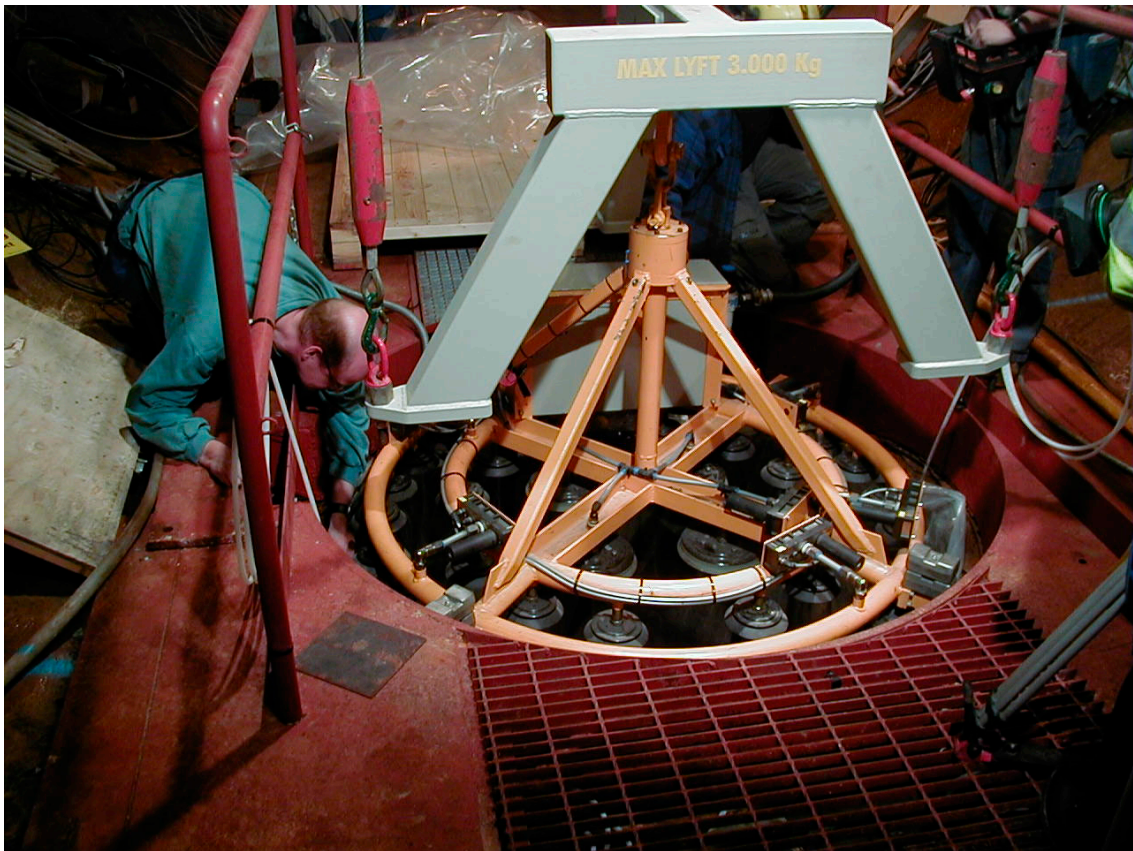
The installation of the buffer and the deposition of the canisters were carried out during the period 2001-05-10--08-24. The pellets filling in the slots of the deposition holes was carried out when the backfilling had reached the edge of the different holes during the period 2001-09-17--10-22.

### **4.3 Retrieval of the canister in deposition hole DA3581G01 (Dh2)**

After deposition of the canister and the buffer in Dh2 it was discovered that one of the connectors for the heater cables was not properly installed. The canister had to be retrieved from the deposition hole and repaired. The reparation of the canister was made while the canister was standing in deposition hole Dh1 on top of 4 concrete blocks so the level of the canister lid was above the tunnel floor. This Chapter deals with the uptake and reinstallation of the canister and buffer. The work was done as follows:

- 4 concrete blocks with the same dimensions as the bentonite blocks were placed in deposition hole DA3587G01 (Dh1) with the gantry-crane.
- The temporary transducers and the plastic sheet in Dh2 were removed.
- A vacuum oak was lifted into the deposition hole with the gantry-crane (see Figure 4-9). This oak is normally used for handling the bentonite blocks during the manufacturing process.
- The vacuum oak was attached to the upper surface of the block by applying a vacuum in the small cups on the oak, with a vacuum pump placed outside the test tunnel.
- The three upper bentonite blocks were removed from the deposition hole, placed on pallets and wrapped in plastic.
- The small bricks of bentonite placed on top of the canister lid were removed.
- The upper lid of the canister was unscrewed and hoisted from the deposition hole.
- The 30/70 mixture of bentonite/sand was removed from the lower lid of the canister. The ring and the intermediate partitions of copper were hoisted from the deposition hole. The lid was cleaned with a vacuum cleaner.
- The power cables were unscrewed from the connectors on the canister. A control of the connectors was made and showed that the damage of one of the connectors was located inside the canister lid. Also the optical cables were cut.
- The gantry-crane was removed from the tunnel and the deposition machine was placed over the deposition hole.
- The retrieval the canister with the deposition machine was made as described in Chapter 4.2.8 but in reverse order.
- The deposition machine with the canister was placed over Dh1 and the canister was placed on top of the 4 concrete blocks as described in Chapter 4.2.8.

- The deposition machine was removed from the tunnel and the gantry-crane was placed over the hole.
- The canister lid was unscrewed from the canister and hoisted with the gantry-crane. The connector was repaired and the lid was put back in place.
- The gantry-crane was removed from the tunnel, the deposition machine was placed over the hole and the canister was lifted with the deposition machine.
- The deposition machine was then placed over DA3581G01 (Dh2) and the canister and the buffer were placed in the deposition hole.
- The optical cables were repaired and the splices were placed in small tubes of stainless steel on the floor of the tunnel.



*Figure 4-9 The vacuum oak placed in the deposition hole*



*Figure 4-10* A bentonite block hoisted from the deposition hole, placed on a pallet and wrapped in plastic.

#### **4.4 Density of the installed buffer**

As described in previous chapters, the buffer of bentonite consists of highly compacted large blocks, small bricks of bentonite on top of the canister lid and pellets of bentonite in the outer slot between the bentonite blocks and the surface of the deposition hole. In Table 4-3 the weights and the water ratios of the different parts of the installed bentonite buffer are listed. About 21300 kg bentonite were used in each deposition hole for the large blocks. The weight of the pellets varied from 2700 kg to about 3000 kg. The weight of the installed small bricks varied between 280-360 kg. Using the weight and water ratio of the bentonite together with the measured dimensions of the deposition holes it is possible to calculate the average density of the buffer (or the void ratio). These parameters are also listed in Table 4-3. The calculations are made with the assumption that no axial swelling of the buffer will occur during the water uptake. The calculated average density at saturation varies between 2030-2040 kg/m<sup>3</sup>.

homogenous buffer as possible after the installation. The blocks placed underneath and above the canister (cylindrical blocks) were compacted to a bulk density of about 2030 kg/m<sup>3</sup> while the ring shaped blocks, placed in the canister sections, were compacted to a density of about 2110 kg/m<sup>3</sup>. In Table 4-4 the densities and void ratio for the buffer calculated at three different sections in the deposition holes are listed. These three sections correspond to underneath the canister (Section A), between the canister and the rock (Section B) and just above the lid of the canister, where the bricks of bentonite were placed (Section C). The largest variation in density was yielded in deposition hole DA3575G01 (Dh3), where the calculated density varied between 2020 and 2045 kg/m<sup>3</sup>. Also these calculations are made with the assumption that no axial swelling of the buffer will occur.

**Table 4-3. The weight and water ratio of the blocks and pellets installed in the deposition holes and the average density of the buffer**

Deposition hole	Blocks		Bricks		Pellets		Average	
	Weight (kg)	Water ratio (%)	Weight (kg)	Water ratio (%)	Weight (kg)	Water ratio (%)	Density at sat. (kg/m <sup>3</sup> )	Void ratio
DA3587G01 (Dh1)	21354	17,5	277	19,7	2908	13,0	2036	0,717
DA3581G01 (Dh2)	21346	17,3	355	16,6	3018	13,5	2037	0,716
DA3575G01 (Dh3)	21314	17,3	283	17,4	2718	13,1	2028	0,731
DA3569G01 (Dh4)	21384	17,2	283	16,4	2886	12,8	2036	0,718

**Table 4-4. Calculated density at saturation and void ratio for different parts of the buffer in the four deposition holes**

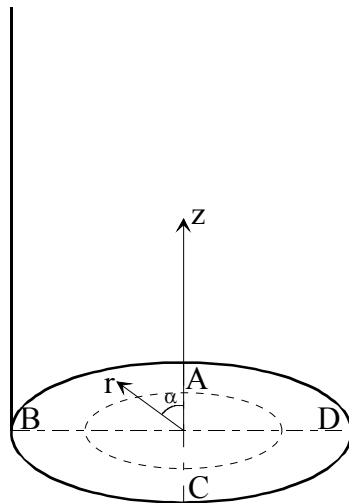
Deposition hole	Section A		Section B		Section C	
	Density at sat. (kg/m <sup>3</sup> )	Void ratio	Density at sat. (kg/m <sup>3</sup> )	Void ratio	Density at sat. (kg/m <sup>3</sup> )	Void ratio
DA3587G01 (Dh1)	2048	0,699	2028	0,732	2051	0,694
DA3581G01 (Dh2)	2048	0,698	2031	0,726	2040	0,712
DA3575G01 (Dh3)	2044	0,705	2017	0,750	2041	0,710
DA3569G01 (Dh4)	2046	0,701	2029	0,729	2036	0,719

## 4.5 Installation of instruments

220 instruments were installed in the buffer. They are described in detail in Chapter 3. Five of the transducers were spoilt during the installation. Two of these transducers were total pressure transducers in deposition hole DA3587G01 (Dh1). They were broken during the bending of the titanium tube for the cables. The other three spoilt transducers were RH-transducers in the same deposition hole. The transducers were spoilt due to mechanical damages on the electronic boxes placed outside the deposition hole. These transducers are also measuring the temperature and for two of them the temperature sensors were still functioning after installation.

Sample collectors for collecting pore water from the buffer were also installed (totally 14 of them). A sample collector consists of a cup of titanium with a titanium filter on its top. After the buffer is saturated the cup will be filled with water. When the test is over and the excavation of the buffer has started, the cups will be located and the water analyzed. At the bottom of two of the cups there are tubes of PEEK going from the collector's trough the rock to the G-tunnel with the purpose to take in situ samples of the pore water during the test period.

All the instruments and their coordinates are listed in Appendix I. Two types of coordinates are used for describing the position of the transducers. With the first type of coordinates the position of the instruments are described with a radius and an angle together with a depth coordinate ( $z$ -coordinate) as shown in Figure 4-11. The  $z$ -coordinate is the distance from the bottom of the hole (the concrete/bentonite interface). The second type of coordinates describes the positions of the instruments with the ÄSPÖ 96 coordinate system ( $X$ -,  $Y$ -,  $Z$ -coordinates).



**Figure 4-11** Figure describing the coordinate system used for the instrument positions. Direction  $A - C$  are placed in the axial direction of the tunnel with  $A$  headed against the end of the tunnel i.e. almost at West.





## 5 Backfilling and instrumentation of the tunnel

### 5.1 Description of the backfilling of the tunnel

#### 5.1.1 Backfill material

The backfill material in the tunnel and upper meter of the deposition holes is composed of a mixture of 30% bentonite, 70% crushed rock and water to yield a water ratio of 12%.

#### Bentonite

The bentonite originates from Milos in Greece (Silver and Baryte Ores Mining Co). Some properties of the raw material determined by the supplier after addition of Soda are shown in Table 5-1.

**Table 5-1. Properties of the Milos bentonite after processing (shipment 15/3 2001)**

Quartz content	1.04 %
Silica content	51.4 %
K <sub>2</sub> O	0.85 %
N <sub>2</sub> O	2.90 %
Sulphur content	0.318 %
CaO	6.40 %
Water ratio	13.3 %

The bentonite was ground and dried by LKAB in Luleå. It was grind to a fine powder with 90-95% of the dry particles smaller than 0.074 mm.

#### Ballast material

The ballast material was made from the rest product of the TBM drilling (TBM-muck) that was crushed to a maximum grain size of 20 mm.

#### Water

Water was added in order to yield a final water ratio of 12%. The backfill was mixed with water that originates from the site during the actual mixing process at the production of backfill. As reference water for the laboratory tests, water taken from borehole KG0048A01 was used. The most important component of this water is the salt content. Laboratory analyses yielded that the following amount of different salts was found in the water:

NaCl: 4230 mg/l

CaCl<sub>2</sub>: 1670 mg/l

This corresponds to a salt content of 0.75%.

## 5.1.2 Overview of the backfilling

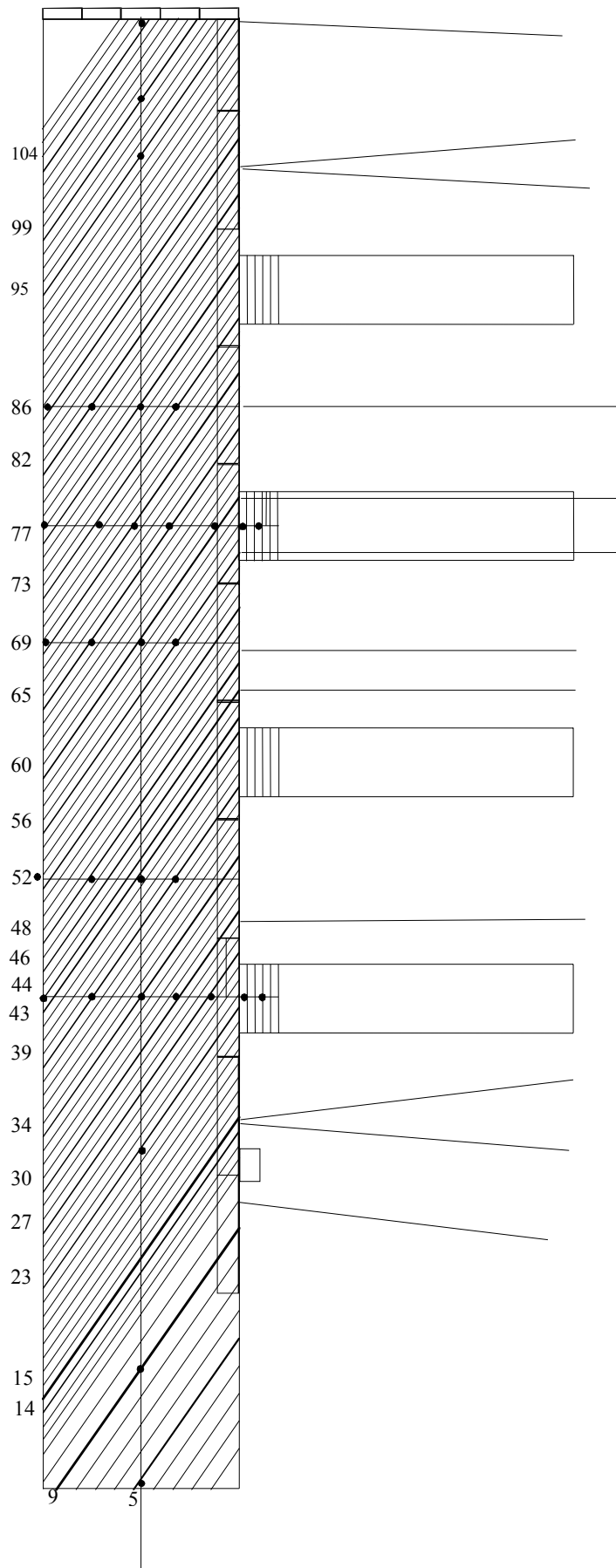
The tunnel was backfilled with layers given the inclination 35°. An overview of the backfill layers is presented in Figure 5-1. The first 11 m of the tunnel were backfilled with drainage material in 40 cm thick layers to help handle the water inflow. Bentonite blocks were placed in the 10 cm slot left between the backfill and the roof. The rest of section 1 was backfilled in 20 cm thick layers with a mixture of 30% bentonite and 70% crushed TBM muck (30/70).

When the backfilling had progressed to the first deposition hole (DA3587G01) the plastic protection of the bentonite blocks in the deposition holes was removed and the slot between the blocks and the rock was filled with bentonite pellets. After completed pellets filling the remaining upper part of the deposition hole was backfilled and instrumented. When the last backfill layer in the hole had been compacted the backfilling of the tunnel continued. The same procedure was repeated for all four deposition holes.

In the first deposition hole (DA3587G01) the water inflow was high, which affected the installation procedure. Once the plastic was removed and the pellets were filled they began to take up water from the rock and swell. It was important to get support from the backfill as soon as possible. Therefore the backfilling continued without interruption with two shifts (also during weekends) until the position of the second deposition hole was reached. The whole procedure took 10 days. For the remaining deposition holes there were no backfilling during weekends.

When the backfilling had progressed to the position of the plug the first prefabricated concrete beam was put in place. The beams were fixed with angle irons bolted to the walls of the tunnel. The backfilling continued with 20 cm thick layers until the upper edge of the beam was reached. Then the next beam was put in place. The procedure was repeated until it was not possible to reach any higher with the compaction equipment. The remaining volume was filled with blocks containing 20% bentonite and 80% sand. Bentonite pellets were used for adjusting the density and hence the swelling pressure. When the last beam was in place the backfilling was finished and the construction of the plug started.

The instruments in the backfill and in the rock were installed as the backfilling progressed. Ventilation and lamps were also dismantled during the course of the backfilling. It was necessary for the carrier of the vibrating plate to come close to the base of the backfill layer in order to make compaction possible. A special telescopic roadbed segment was constructed for this purpose. When the backfilling front come close to a roadbed segment, it was moved out of the tunnel and replaced by the telescopic roadbed.



*Figure 5-1. Overview and numbering of the backfill layers*

### 5.1.3 Handling of water inflow to the inner part of the tunnel

The roof and walls of the wet inner part of the tunnel was covered with a plastic mat to collect the water coming from fractures in the rock. The lower edge of the mat was sealed. The water was lead from the mat through tubes to a sump that had been excavated in the floor of the tunnel (see Figure 5-2). The sump was equipped with two pumps that pumped the water out of the tunnel. The mats collected most of the water but there was a small amount coming from the bottom of the tunnel. It was important to collect also this water. For this purpose the inner wet part was filled with drainage material from the sump to the end of the tunnel.



*Figure 5-2. The sump and pumps in the inner part of the tunnel.*

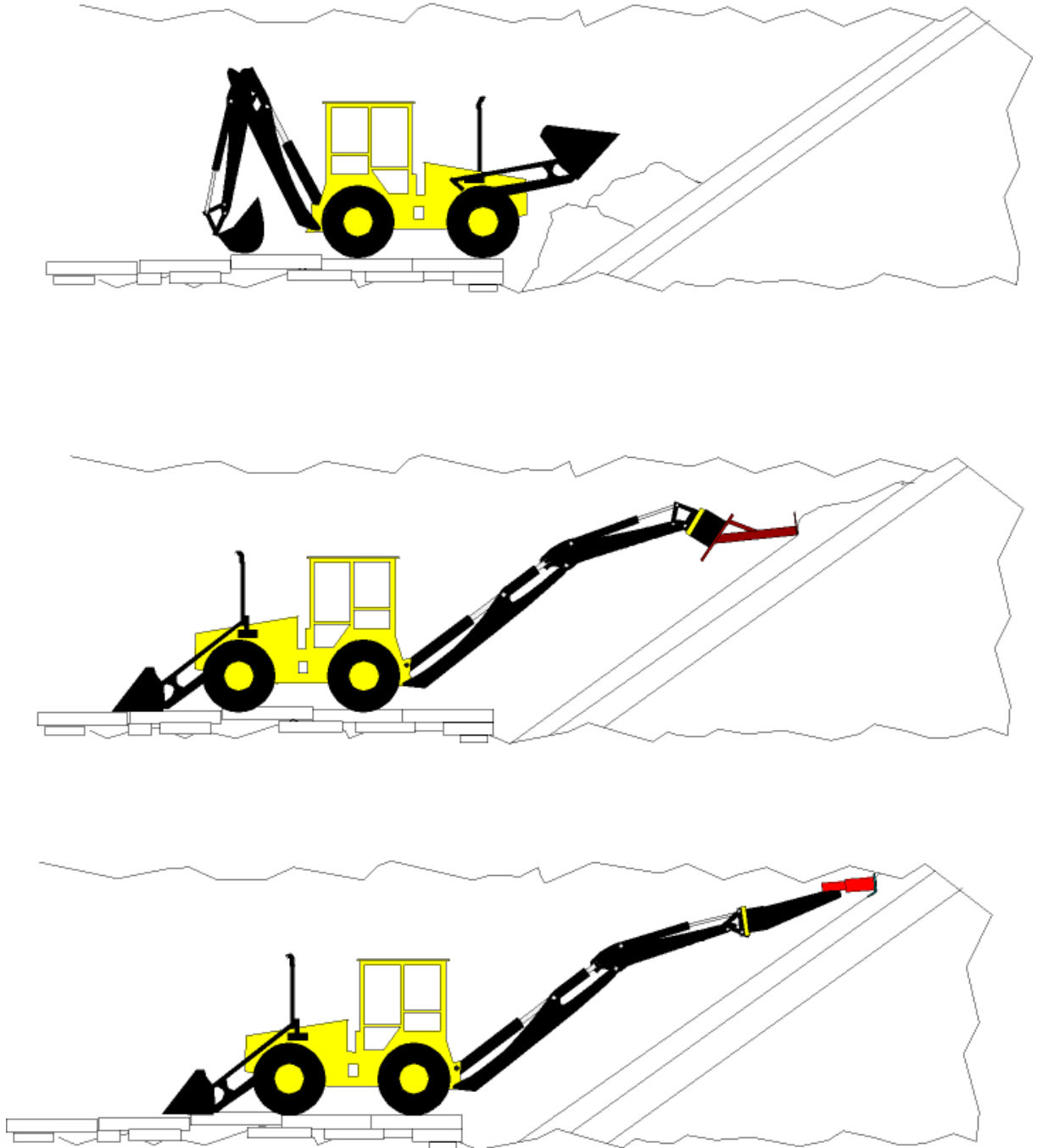
### 5.1.4 Backfilling and instrumentation of the individual layers

The backfilling of one layer is described below and in Figures 5-3 and 5-4, a photo of the roof compactor is shown in Figure 5-5 and a photo of the slope compactor is shown in Figure 5-6.

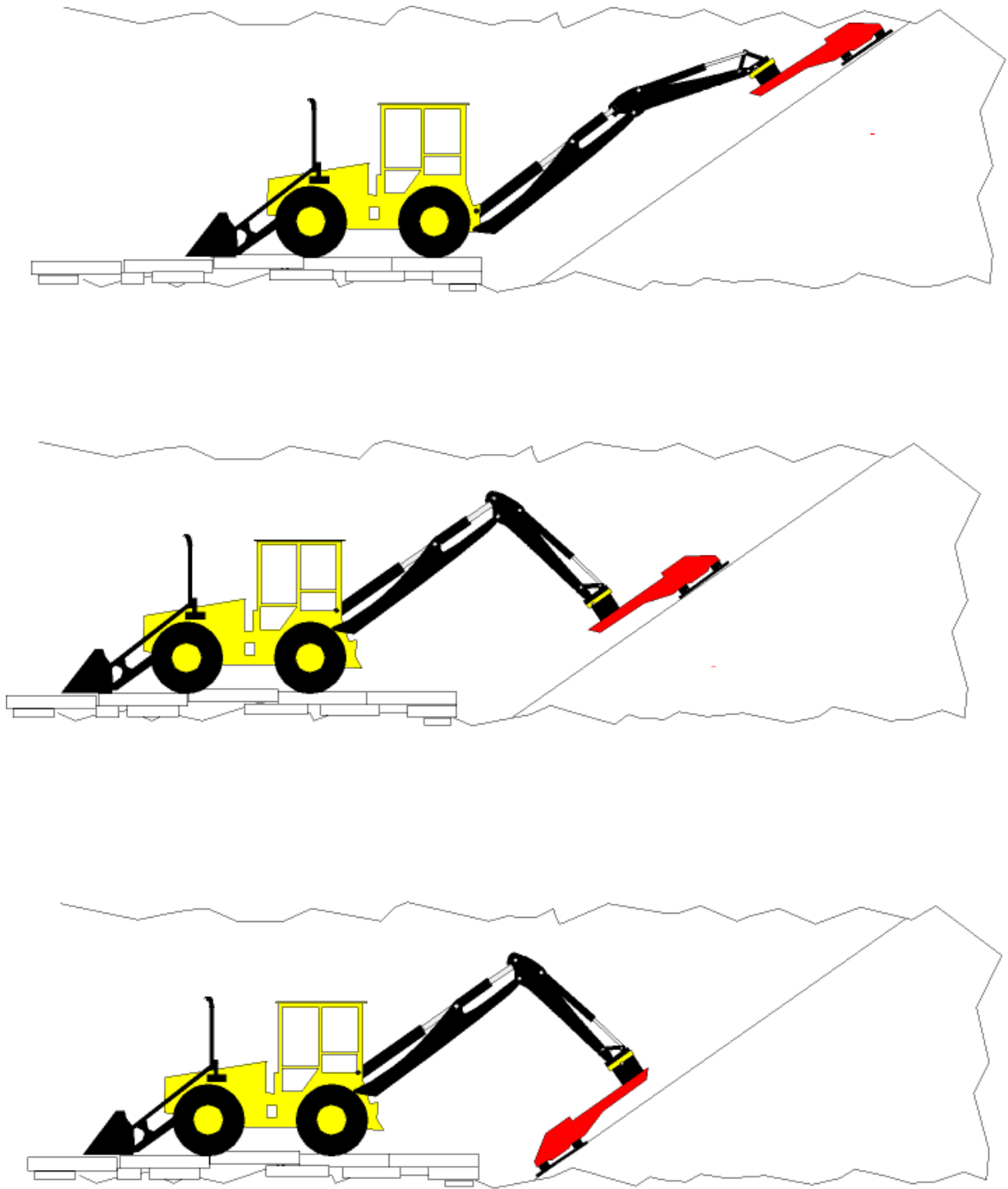
The backfilling was carried out in the following steps:

1. 30/70 material for one layer was transported to the backfilling front. The mass of one layer was about 12 tons.
2. The material was pushed in place with the pushing tool. The layer was given a slightly concave shape.

3. The roof compactor was then used for compacting the material close to the roof. The purpose of this activity was to achieve a high density at the roof and to ensure a good contact between the backfill and the rock.
4. The rest of the layer was then compacted with the slope compactor. The compactor was placed 1.5 m from the floor and moved sideways over the layer. The compactor was moved from side to side over the layer and after each sweep the compactor was moved up the slope some 30 –50 cm and the sweeping motion repeated. This activity continued as high up as the compactor could reach. Then the compaction continued down the layer with horizontal sweeps. This procedure was repeated until the density was high enough. The last step was to compact the material close to the tunnel floor by turning the compactor 180 degrees (see Figure 5-4).



*Figure 5-3. The backfilling sequence for one layer*



*Figure 5-4. The backfilling sequence for one layer.*



*Figure 5-5. The roof compactor.*



*Figure 5-6. The slope compactor.*



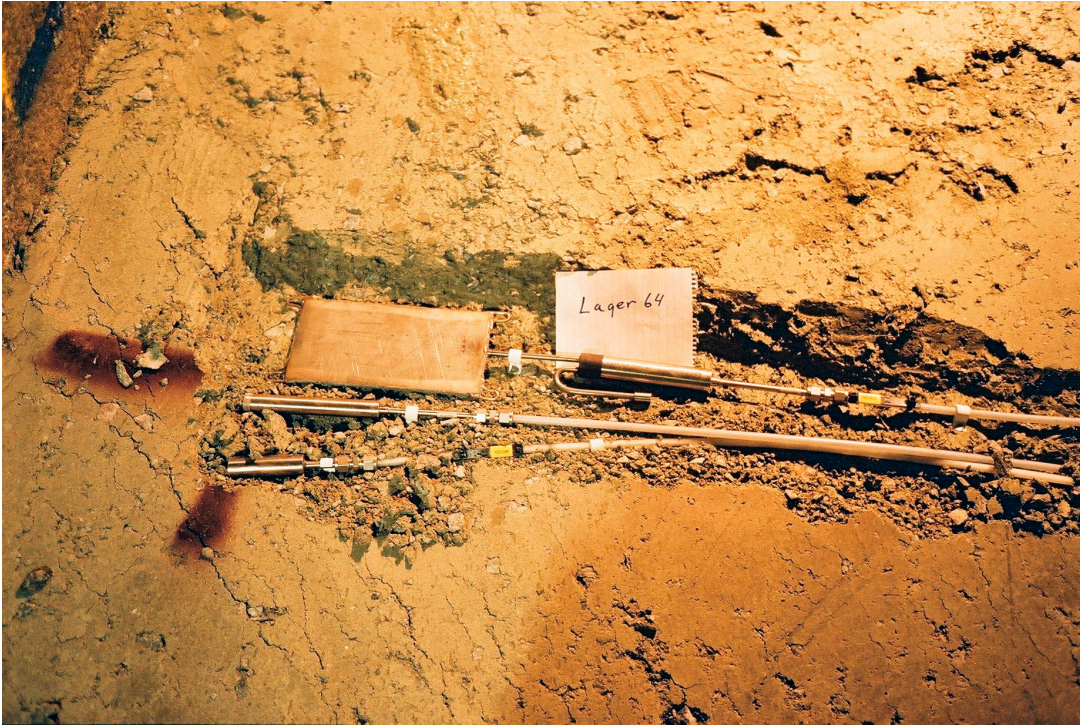
The final locations of the sensors in the backfill are described in Chapter 5.3 and Appendix II. Before start backfilling of the tunnel the cables and tubes for the instrumentation had been installed in lead-through holes leading to a neighbouring tunnel (see Figure 5-7).

The sensors and the related cables and tubes needed in the prototype tunnel had been made into bundles and temporarily hung on the walls of the tunnel. Each sensor was then installed when the backfilling had progressed to the location intended for the sensor. To create as little disturbance in the backfill as possible the tubes and sensors were laid in about 3 cm deep ditches in the backfill (see Figure 5-8).

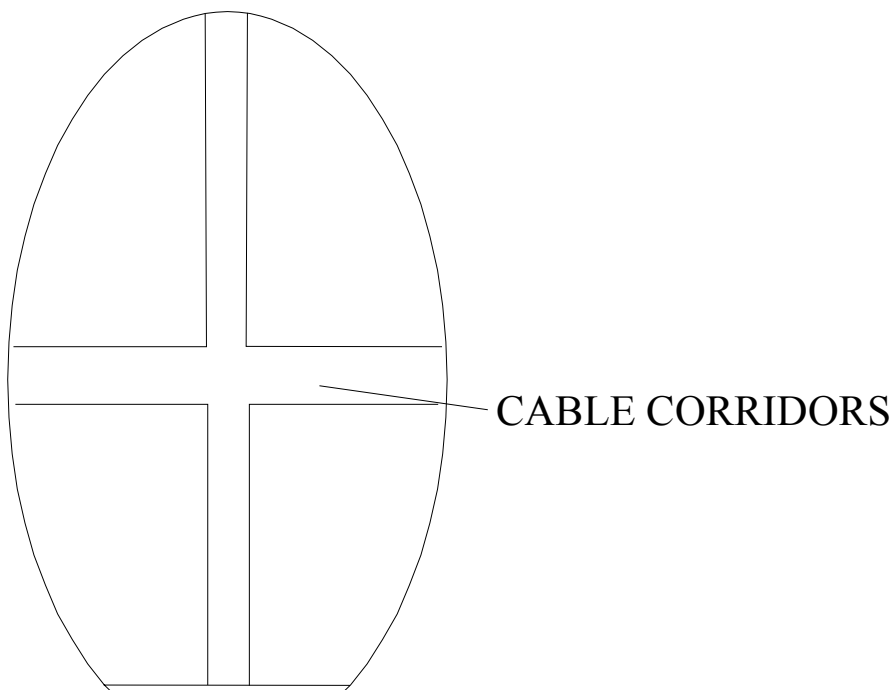
Bentonite powder was placed on and between the cables. The ditches were then filled with backfill material before the next backfill layer was compacted. The cables were laid in assigned cable corridors on the surface of the compacted layers (Figure 5-9). This was made to keep the areas where density measurements were made free from cables and tubes.



*Figure 5-7. Cable package in place.*



**Figure 5-8.** Installation of sensors in the backfill.



**Figure 5-9.** Principle drawing showing the areas where cables and tubes were laid on the surface of the compacted layer

### 5.1.5 Backfilling of the upper part of the deposition holes

Ten 10 cm thick backfill layers of 30/70 were compacted in each deposition hole. In the first layer the water ratio was low (about 5%) in order to avoid that the top bentonite block adsorbed water and started to swell. In the two deposition holes that were instrumented (DA3587G01 and DA3575G01) the tubes with cables were led between the bentonite blocks and the rock and further on along the rock surface. The other end of the tubes was fixed beforehand in the lead-through plates. Each instrument had 5 to 15 meters of excess tube that was placed in the upper part of the deposition holes and in the tunnel. About ten sensors in each instrumented hole were connected to an amplifier box ten meters from the sensor. These boxes were placed in the excavations at the lead-through and at the inner side of the deposition holes (see Figure 5-10).

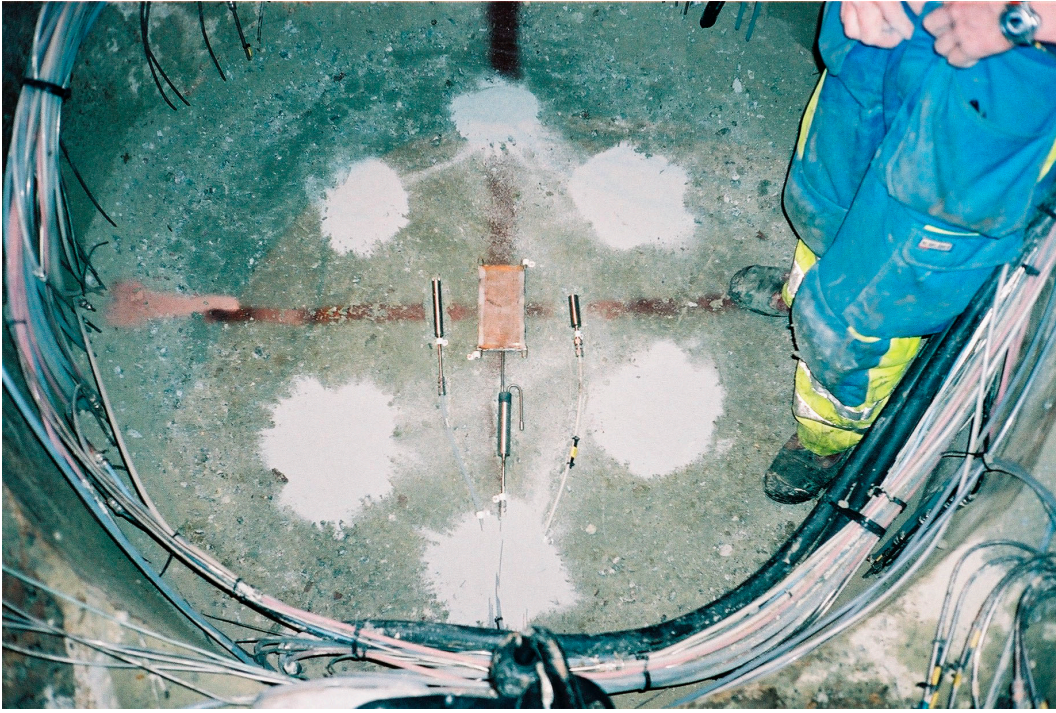
When slot had been filled with bentonite pellets the tubes were led in the periphery of the hole to a slot in the rock leading to the lead through connection (see Figure 5-11).

The aim was to cross as few cables as possible. The excess tubes were made into bundles close to the lead-through plate (see Figure 5-12).

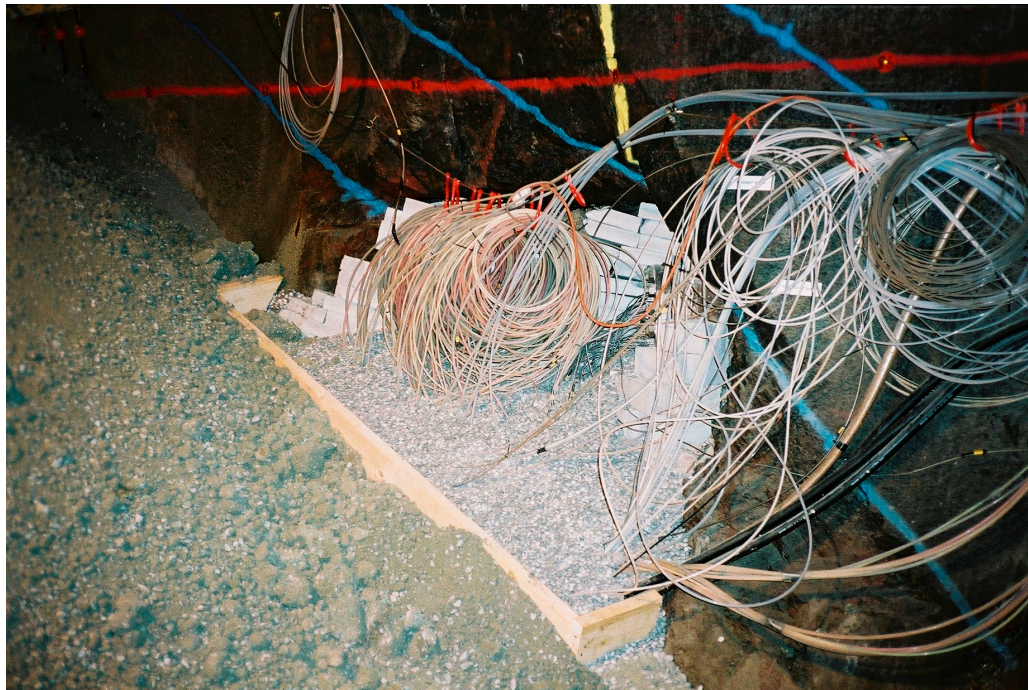
The backfill in the deposition holes was compacted to a high density without harming the tubes from the sensors. To accomplish this a hand held compaction device was used for compaction layers with 10 cm thickness. The procedure was tested in a concrete ring before it was used in the Prototype Repository (see Figure 5-13).



*Figure 5-10. Vaisala amplifier boxes.*



*Figure 5-11. Backfilling and instrumentation on top of DA35875G01.*



*Figure 5-12. Handling of cables and tubes.*



*Figure 5-13. Test compaction for the deposition holes.*

The layers were given a concave shape in order to allow compaction against the rock wall. The density was measured in eight points every second layer. The instruments were installed in the same way as in the backfill in the tunnel. The sensors and the tubes were laid in ditches and bentonite powder was placed on and in-between the tubes.

#### **5.1.6 Backfilling against the retaining wall**

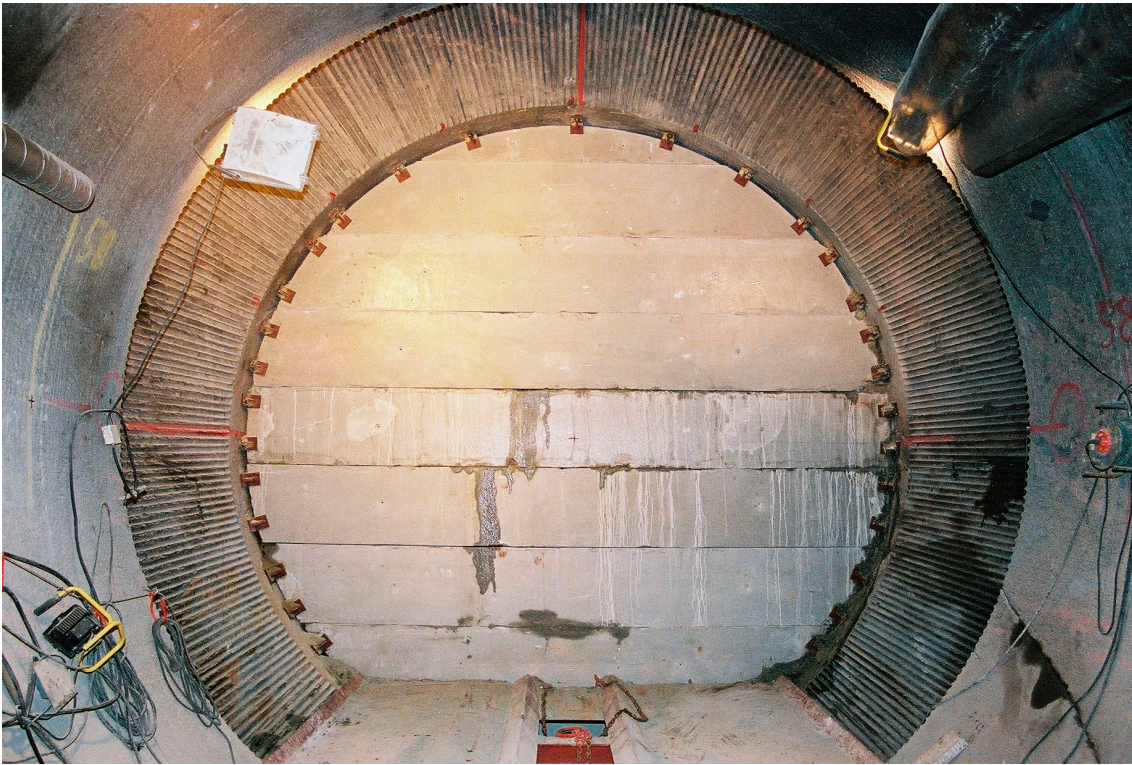
The emplacement of the retaining wall and the backfilling against it worked well. It was possible to compact backfill material behind 7 of totally 9 beams. The remaining space was filled with blocks containing 20% bentonite and 80% sand and bentonite pellets. Some water coming from boltholes in the rock trickled through the joints between the concrete beams. The joints were filled with mortar, which reduced the water flow. The installation procedure had to be changed since it was not possible to get the angle irons and prefabricated concrete beams in place in the upper part of the tunnel. The angle irons that kept the beams in place in the upper part had to be welded in place. Pictures from the installation are shown in Figure 5-14 to 5-16.



*Figure 5-14. Installation of the concrete beams for the retaining wall.*



*Figure 5-15. Placing blocks and pellets in the space at the roof.*

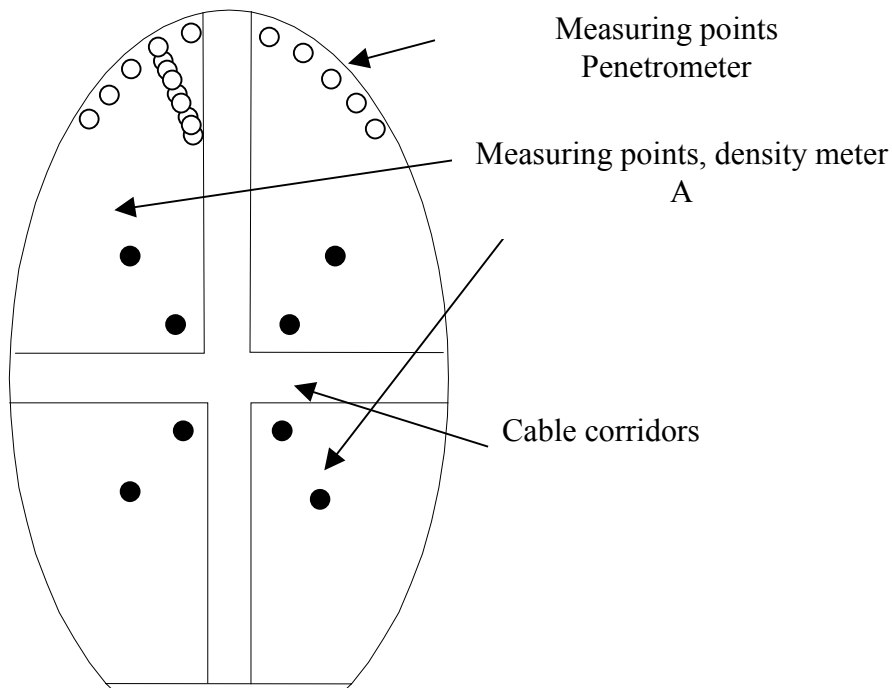


*Figure 5-16. All nine concrete beams in place.*

## **5.2 Measurement of density and water ratio**

### **5.2.1 Scope of measurements**

The first 16 layers were backfilled with drainage material and the density and water ratio were determined in layers 5, 8, 12, 14 and 16. Layers 17-104 were backfilled with a mixture of 30% bentonite and crushed rock and density and water ratio were measured in all these layers except for every second layer in layers 30-69, which were omitted. The pattern of measurements on a measured layer is shown in Figure 5-17. Samples for determining water ratio were taken in the points where density meter A was used for measuring density. Two principles were used for measuring density. Equipment, technique and results from these measurements are presented in this chapter.



*Figure 5-17. Standardised pattern of density measurements in the backfill layers.*

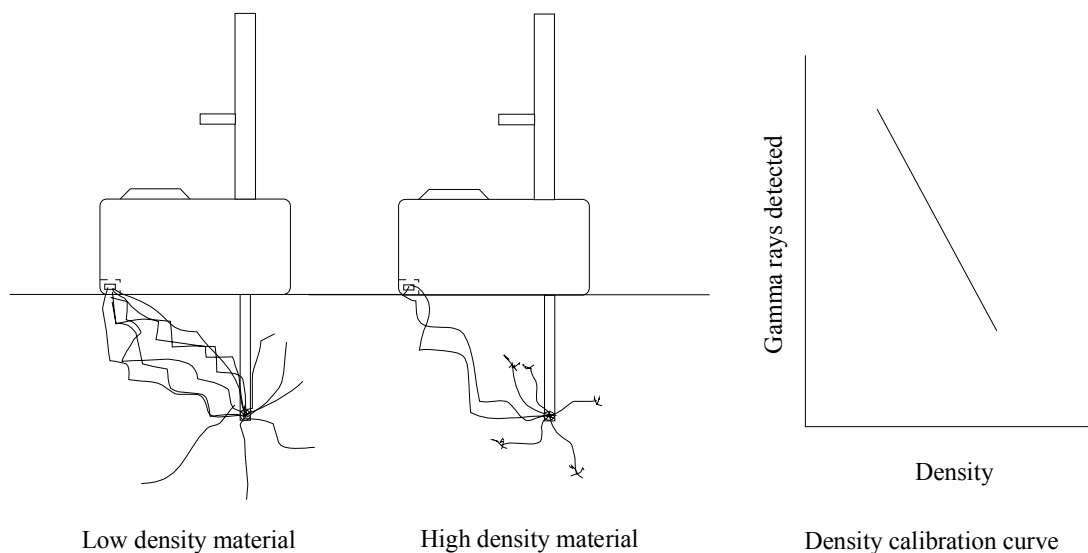
## 5.2.2 Equipment and Technique

### Nuclear gauge

The performance of the Campel Pacific MC-3 Port probe (referred to as density meter A) is based on the use of radio physics. A gamma source emits radiation that passes through the soil. The density is calculated on the basis of the amount of radiation that is absorbed by the soil. Schematic drawings of the gauge are shown in Figure 5-18.

A slide hammer and a plate were used for making a hole perpendicular to the compacted surface and the rod with the gamma source was pushed down into it. The recording time was 1 minute. Density meter A measures an average density between the source and the soil surface. The gauge is described in detail in /5-1/.





**Figure 5-18.** Pacific MC-3 Portaprobe (density meter A)

### Penetrometer

A penetrometer was used where it was not possible to use the nuclear gauge, i.e. close to the roof and walls of the tunnel.

The principle of the penetrometer is to measure the resistance when a steel rod is pushed into the material. The average resistance for different densities of a certain material with a certain water ratio can be calibrated. This is a rough method and it is used for estimating the density of the backfill.

### Water ratio

One sample was taken in every place where density was measured with density meter A. The samples were weighed, dried at 105 °C for 24 hours and then weighed again for determining the loss of water. The water ratio was calculated as the weight of water divided by the dry weight of the sample.

### 5.2.3 Results from the density measurements

The average dry density per layer measured with the nuclear gauge and the average measured water ratio per layer is shown in Figure 5-19. The measurements were made according to Figure 5-17, i.e. in the central area of the tunnel. In the first half of the test tunnel the measured dry densities barely reached the intended 1.65 g/cm<sup>3</sup> so the compaction time with the slope compactor was increased from about 40 to 80 minutes per layer. The reason for this might be that the backfill material had a slightly different composition compared to the backfill used in the Backfill and Plug Test, where 40 minutes were enough. In order to keep the time schedule the compaction time was not increased until layer 65. When the compaction time with the slope compactor was increased to about 80 minutes the densities were high enough. Figure 5-20 shows the increase in density with compaction time. The average dry density measured with nuclear gauge A of all layers was 1.70 g/cm<sup>3</sup>.

A few measurements towards the rock wall and floor were also made (see Figure 5-21). The measurements indicate that the density is high at the walls and that the density decreases very much with decreasing distance to the floor.

The results from the penetrometer measurements indicate that the densities at the roof were higher than  $1,45 \text{ g/cm}^3$  for most parts, i.e. the density was out of the measuring range of the penetrometer, since it was been possible to penetrate the material.

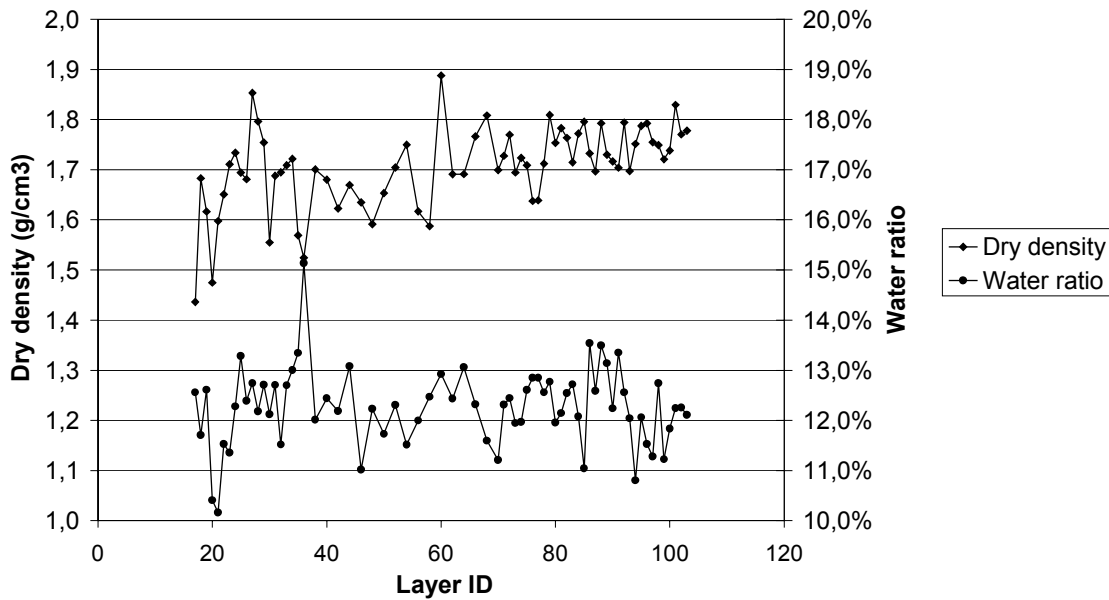


Figure 5-19. The average measured water ratio and dry density.

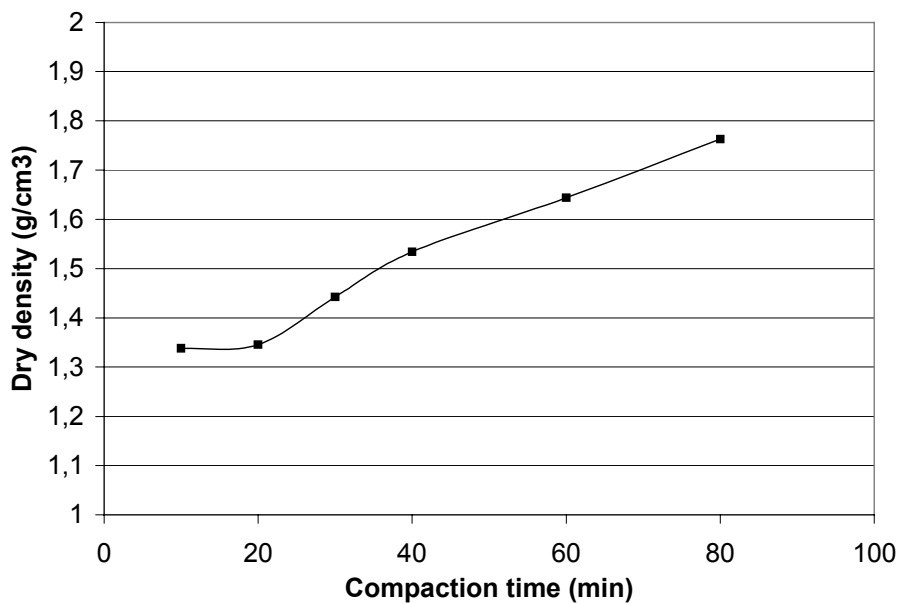
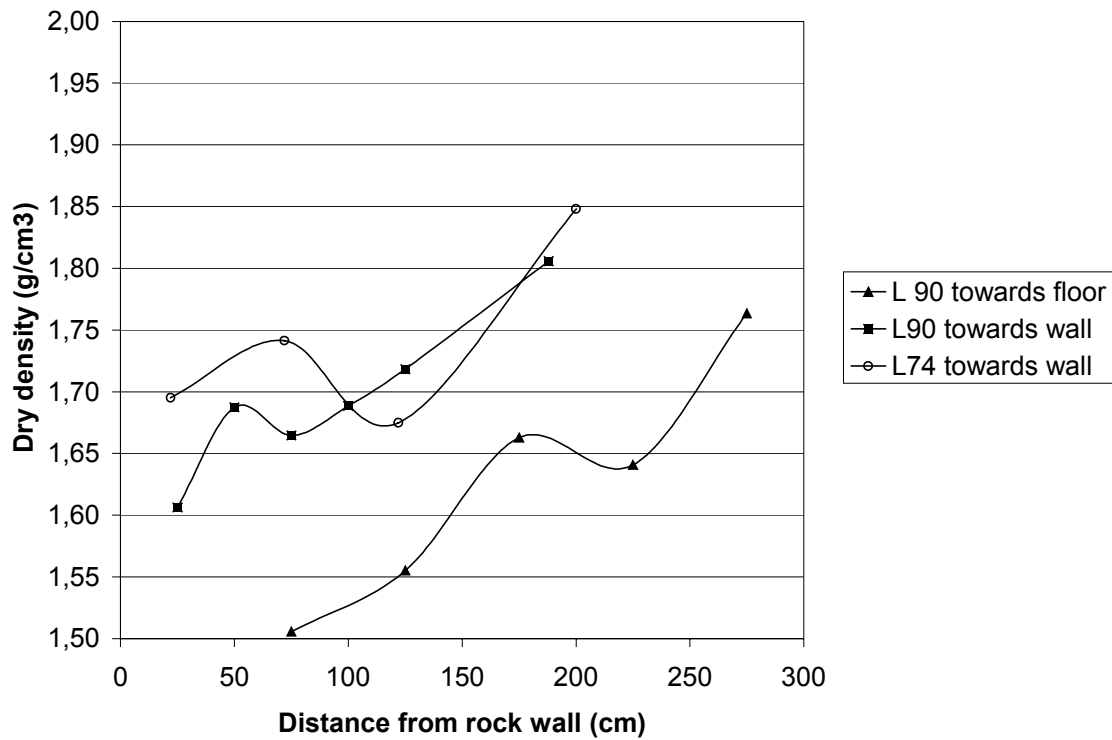


Figure 5-20. Increase in density with compaction time. The test was made on layer 84.

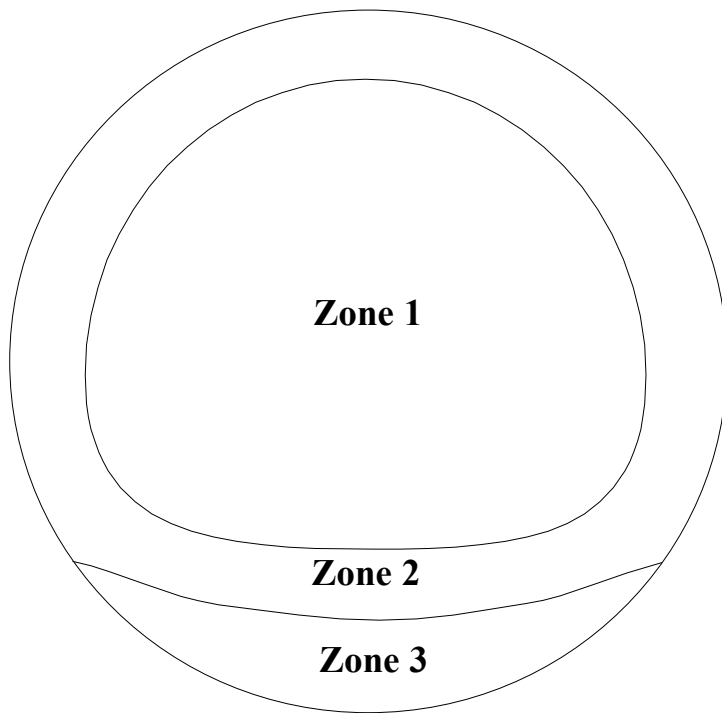


*Figure 5-21. Measured density as function of the distance to the walls and floor of the tunnel.*

Using the results presented in Figures 5-19 and 5-21 the total dry density in the tunnel is estimated to 1.65 g/cm<sup>3</sup>. To make this estimation the tunnel area was divided into three different density zones (see Figure 5-22). The properties of the zones used in the estimation are shown in Table 5-2.

**Table 5-2. Properties of the three zones used for estimation of the average dry density.**

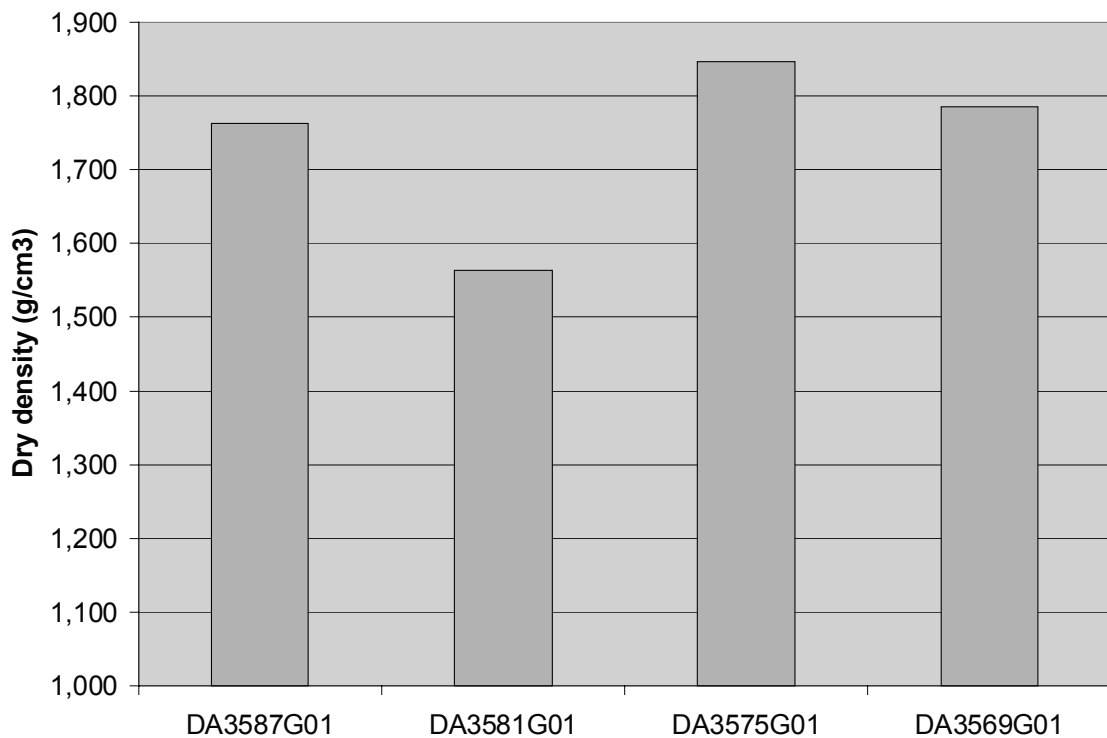
	Cross section (m <sup>2</sup> )	Dry density (g/m <sup>3</sup> )
Zone 1	9.41	1.7
Zone 2	8.10	1.6
Zone 3	2.12	1.5



*Figure 5-22. The three density zones used for estimating total density.*

The total density has also been estimated to  $1.58 \text{ g/cm}^3$  by dividing the total mass of backfill material with the total volume and assuming that 5% of the cross section was filled with other materials (bentonite pellets and blocks at the lead-throughs, plastic mats, cables, bentonite powder). The difference in density may partly be explained by local disturbances owing to instrumentation leading to locally lower densities, which are not treated in the density estimation based on measurements with the nuclear gauge and that the accuracy of the scale used for weighing material is  $\pm 5\%$ . The number of measurements in Zone 2 and 3 is also small which affects the accuracy of the estimations based on the nuclear gauge.

The average measured dry densities of 30/70 in the deposition holes are presented in Figure 5-23. Before the backfilling of the first deposition hole (DA3587G01) a compaction test was made. The compacted layer thickness was set to 10 cm and the compaction time was set to 20 min per layer. This compaction time was used for the two first holes, but it yielded too low density in hole 2. In the last two holes the compaction time was increased to 30 min per layer and hence the density was increased.



*Figure 5-23. The average measured dry density of 30/70 backfill in the upper part of the deposition holes.*

## 5.3 Instrumentation

### 5.3.1 Installations made during backfilling

All devices installed during backfilling and their locations are shown in Appendix II. A total of 95 sensors (excluding GRS electrodes) were planned to be installed in the backfill. Two total pressure cells were damaged during the installation of the lead-throughs and one tube for a titanium cup for water sampling was lost during the backfilling.

The following sensors were installed in the backfill:

- 45 sensors for monitoring water saturation (WBA...) (Table AII:7)
- 23 sensors for measuring pore water pressure (UBA...) (Table AII:6)
- 5 titanium cups for water sampling (KBU...) (Table AII:3)
- 20 thermocouples (TBA...) (Table AII:5)
- 18 sensors for measuring the total pressure (PBA...) (Table AII:4)

The following installations were also made during the backfilling:

- 20 concrete parcels containing cellulose were installed in the backfill (CBA...) (Table AII:1)

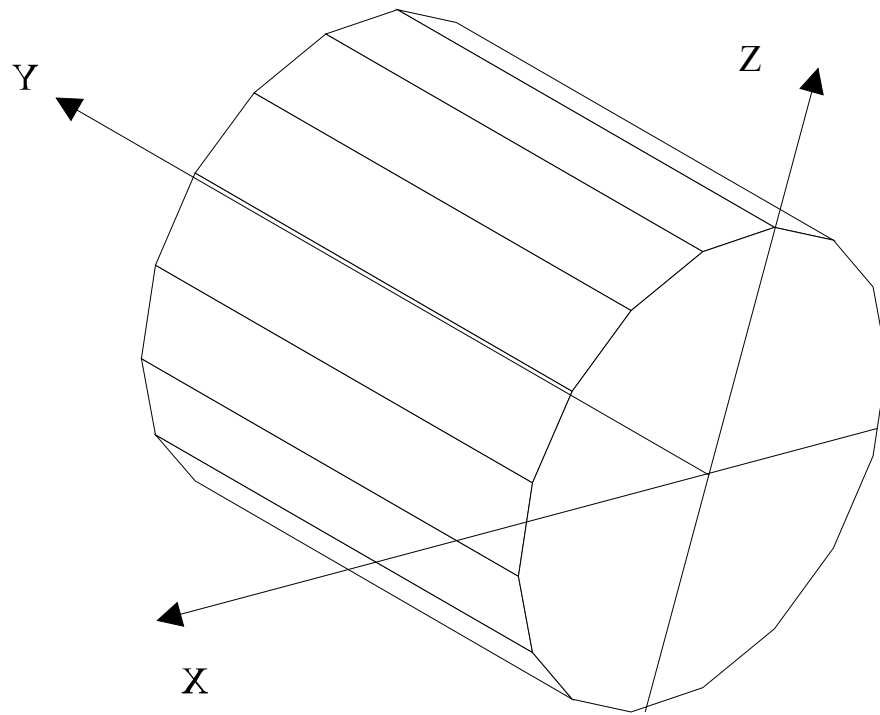
- Two titanium cups were installed in the pellet filled gap between the top bentonite ring and the rock one in each instrumented deposition hole (not listed here).
- A total of 37 thermocouples were installed in boreholes in the rock (not listed here)
- 89 tubes were connected to packers installed in boreholes for measuring water pressure in the rock (not listed here).
- Four sensors for measuring the horizontal displacement of the top bentonite block were installed (DBU...) (Table AII:2).
- GRS installed 36 electrodes for measuring the water content of the backfill in layer 65 (not listed here).

### **5.3.2 Co-ordinate system and measurement of sensor positions**

For measuring the position of the instruments and layers three lines were drawn on the rock walls; one in the centre of the roof and two along the walls 2.5 m from the roof, i.e. at the intersection between the z- and x-axes and the rock surface (see Figure 5-24). The tunnel length was marked on the lines. The position of every fourth layer was also marked on the walls. The position of each backfilled layer was measured in the three points where the layers intersect the lines and in the centre of the tunnel.

Two laser planes were also established. One intersected the two lines on the walls and thus created a horizontal plane at mid height tunnel. The other one created a vertical plane that intersected the line in the roof. The laser planes were thus placed in the z- and x-axes of the coordinate system showed in Figure 5-24. The laser planes marked the x and z-axes on the backfill layers, which made it easy to measure the positions and place the sensors.

The co-ordinates were noted in this local co-ordinate system and then transformed into Äspö 96 co-ordinates, which were reported to SICADA. The co-ordinates of all sensors are shown in Appendix II.



*Figure 5-24. The local co-ordinate system. The y-coordinate corresponds to the length coordinate of the tunnel with  $y=0$  at the tunnel entrance on ground.*





## References

- /2-1/ **Collin M. and Børgesson L., 2002.** Prototype Repository. Instrumentation of buffer and Backfill for measuring THM processes. SKB International Progress Report IPR-02-09.
- /4-1/ **Johannesson L.-E., 1999.** Compaction of full size blocks of bentonite for the KBS-3 concept. Initial tests for evaluating the technique. SKB Report R-99-66.
- /5-1/ **Gunnarsson D., et.al. 1996.** Field test of tunnel backfilling. SKB report HRL -96-28.



# Appendix I

Final position of the instruments in the buffer material



Dh1 (DA3587G01) Measurement of temperature						
ID CODE	Local coordinate system			Äspö 96 coordinate system		
	Z	alfa	r mm	X	Y	Z
TBU10001	0,054	270	50	7 275,548	1 878,928	-456,269
TBU10002	0,254	270	50	7 275,548	1 878,928	-456,069
TBU10003	0,454	270	50	7 275,548	1 878,928	-455,869
TBU10004	0,454	355	635	7 275,644	1 878,303	-455,869
TBU10005	0,454	355	735	7 275,666	1 878,205	-455,869
TBU10006						
TBU10007	0,454	175	685	7 275,340	1 879,584	-455,869
TBU10008	0,454	270	585	7 276,075	1 879,000	-455,869
TBU10009	0,454	270	685	7 276,174	1 879,014	-455,869
TBU10010	0,454	270	785	7 276,273	1 879,029	-455,869

TBU10011	2,980	0	635	7 275,589	1 878,292	-453,343
TBU10012	2,980	0	735	7 275,603	1 878,193	-453,343
TBU10013	2,980	90	585	7 274,920	1 878,838	-453,343
TBU10014	2,980	90	685	7 274,821	1 878,824	-453,343
TBU10015	2,980	90	785	7 274,722	1 878,809	-453,343
TBU10016	2,980	175	585	7 275,366	1 879,491	-453,343
TBU10017	2,980	175	685	7 275,343	1 879,588	-453,343
TBU10018	2,980	175	735	7 275,332	1 879,637	-453,343
TBU10019	2,980	270	585	7 276,078	1 879,004	-453,343
TBU10020	2,980	270	635	7 276,128	1 879,011	-453,343
TBU10021	2,980	270	685	7 276,177	1 879,018	-453,343
TBU10022	2,980	270	735	7 276,227	1 879,025	-453,343
TBU10023	2,980	270	785	7 276,276	1 879,033	-453,343

TBU10024	5,508	0	635	7 275,589	1 878,292	-450,815
TBU10025	5,508	0	735	7 275,603	1 878,193	-450,815
TBU10026	5,508	270	585	7 276,078	1 879,004	-450,815
TBU10027	5,508	270	685	7 276,177	1 879,018	-450,815
TBU10028	5,508	270	785	7 276,276	1 879,033	-450,815

TBU10029	6,317	0	785	7 275,605	1 878,140	-450,006
TBU10030	6,317	95	585	7 274,909	1 878,885	-450,006
TBU10031	6,317	185	585	7 275,461	1 879,501	-450,006

TBU10032	7,026	0	785	7 275,611	1 878,141	-449,297
----------	-------	---	-----	-----------	-----------	----------

**Table AI:1 Temperature sensors in Dh 1**

Dh1 (DA3587G01) Measurement of total pressure						
ID CODE	Local coordinate system			Äspö 96 coordinate system		
	Z	alfa	r mm	X	Y	Z
PBU10001	0,000	0	0	7 275,493	1 878,917	-456,323
PBU10002	0,504	0	100	7 275,507	1 878,818	-455,819
PBU10003	0,504	5	585	7 275,525	1 878,333	-455,819
PBU10004	0,504	5	685	7 275,531	1 878,233	-455,819
PBU10005	0,504	5	785	7 275,536	1 878,133	-455,819
PBU10006	0,504	95	635	7 274,859	1 878,882	-455,819
PBU10007	0,504	105	735	7 274,763	1 879,004	-455,819
PBU10008	0,504	185	635	7 275,458	1 879,551	-455,819
PBU10009	0,504	195	735	7 275,580	1 879,647	-455,819

PBU10010						
PBU10011	2,780	5	685	7 275,534	1 878,238	-453,543
PBU10012	3,030	5	785	7 275,539	1 878,138	-453,293
PBU10013	2,780	95	585	7 274,912	1 878,890	-453,543
PBU10014	2,780	95	785	7 274,712	1 878,879	-453,543
PBU10015	3,030	185	535	7 275,466	1 879,456	-453,293
PBU10016	2,870	185	825	7 275,450	1 879,746	-453,453

PBU10017	5,558	0	50	7 275,506	1 878,872	-450,765
PBU10018						
PBU10019	5,558	5	685	7 275,537	1 878,237	-450,765
PBU10020	5,558	5	785	7 275,542	1 878,137	-450,765
PBU10021	5,558	90	635	7 274,870	1 878,831	-450,765
PBU10022	5,558	100	735	7 274,764	1 878,945	-450,765
PBU10023	5,558	190	735	7 275,523	1 879,656	-450,765
PBU10024	5,558	180	635	7 275,409	1 879,550	-450,765

PBU10025	6,317	0	50	7 275,500	1 878,868	-450,006
PBU10026	6,567	5	585	7 275,525	1 878,333	-449,756

PBU10027	7,076	0	50	7 275,506	1 878,869	-449,247
----------	-------	---	----	-----------	-----------	----------

**Table AI:2 Total pressure cells in Dh 1**

Dh1 (DA3587G01) Measurement of pore water pressure						
ID CODE	Local coordinate system			Äspö 96 coordinate system		
	Z	alfa	r mm	X	Y	Z
UBU10001	0,054	90	50	7 275,444	1 878,910	-456,269
UBU10002	0,254	90	100	7 275,394	1 878,903	-456,069
UBU10003	0,344	355	585	7 275,626	1 878,347	-455,979
UBU10004	0,344	355	785	7 275,672	1 878,153	-455,979
UBU10005	2,780	355	585	7 275,629	1 878,352	-453,543
UBU10006	2,870	355	785	7 275,675	1 878,158	-453,453
UBU10007	2,870	85	535	7 274,975	1 878,800	-453,453
UBU10008	2,870	85	825	7 274,693	1 878,734	-453,453
UBU10009	2,780	175	535	7 275,374	1 879,443	-453,543
UBU10010	2,780	175	825	7 275,308	1 879,725	-453,543
UBU10011	5,398	355	585	7 275,632	1 878,351	-450,925
UBU10012	5,308	355	785	7 275,678	1 878,157	-451,015
UBU10013	6,317	90	50	7 275,444	1 878,910	-450,006
UBU10014	6,916	90	50	7 275,444	1 878,910	-449,407

**Table AI:3 Pore water pressure gauges in Dh 1**

Dh1 (DA3587G01) Measurement of the water saturation process						
ID CODE	Local coordinate system			Äspö 96 coordinate system		
	Z	alfa	r mm	X	Y	Z
WBU10001	0,054	180	50	7 275,486	1 878,966	-456,269
WBU10002	0,254	0	400	7 275,550	1 878,521	-456,069
WBU10003	0,344	180	100	7 275,479	1 879,016	-456,069
WBU10004	0,344	350	785	7 275,738	1 878,171	-455,979
WBU10005	0,344	350	685	7 275,707	1 878,266	-455,979
WBU10006	0,344	350	585	7 275,675	1 878,361	-455,979
WBU10007	0,344	80	585	7 274,937	1 878,735	-455,979
WBU10008	0,254	80	685	7 274,842	1 878,703	-456,069
WBU10009	0,254	80	785	7 274,747	1 878,672	-456,069
WBU10010	0,254	170	585	7 275,311	1 879,473	-456,069
WBU10011	0,254	170	685	7 275,279	1 879,568	-456,069
WBU10012	0,254	170	785	7 275,248	1 879,663	-456,069

WBU10013	2,870	350	585	7 275,678	1 878,366	-453,453
WBU10014	2,870	350	685	7 275,710	1 878,271	-453,453
WBU10015	2,870	350	785	7 275,741	1 878,176	-453,453
WBU10016	2,780	80	535	7 274,988	1 878,755	-453,543
WBU10017	2,780	80	685	7 274,845	1 878,708	-453,543
WBU10018	2,780	80	785	7 274,750	1 878,677	-453,543
WBU10019	2,870	180	535	7 275,420	1 879,452	-453,453
WBU10020	2,870	180	685	7 275,399	1 879,600	-453,453
WBU10021	2,780	180	785	7 275,384	1 879,699	-453,543

WBU10022	5,418	0	50	7 275,506	1 878,872	-450,905
WBU10023	5,428	180	362	7 275,448	1 879,279	-450,895
WBU10024	5,398	350	585	7 275,681	1 878,365	-450,925
WBU10025	5,398	350	685	7 275,713	1 878,270	-450,925
WBU10026	5,398	350	785	7 275,744	1 878,175	-450,925
WBU10027	5,308	80	585	7 274,943	1 878,739	-451,015
WBU10028	5,308	80	685	7 274,848	1 878,707	-451,015
WBU10029	5,308	80	785	7 274,753	1 878,676	-451,015
WBU10030	5,398	170	585	7 275,317	1 879,477	-450,925
WBU10031	5,308	170	785	7 275,254	1 879,667	-451,015

WBU10032	6,317	270	50	7 275,542	1 878,924	-450,006
WBU10033	6,317	350	585	7 275,675	1 878,361	-450,006
WBU10034	6,317	90	585	7 274,914	1 878,834	-450,006
WBU10035	6,317	180	585	7 275,410	1 879,496	-450,006

WBU10036	6,916	180	50	7 275,492	1 878,967	-449,407
WBU10037	6,756	270	50	7 275,548	1 878,925	-449,567

**Table AI:4 Relative humidity sensors in Dh 1**



Dh3 (DA3575G01) Measurement of temperature						
ID CODE	Local coordinate system			Äspö 96 coordinate system		
	Z	alfa	r mm	X	Y	Z
TBU30001	0,095	270	50	7 273,843	1 890,806	-456,448
TBU30002	0,295	270	50	7 273,843	1 890,806	-456,248
TBU30003	0,445	270	50	7 273,843	1 890,806	-456,098
TBU30004	0,445	355	635	7 273,939	1 890,181	-456,098
TBU30005	0,445	355	735	7 273,961	1 890,083	-456,098
TBU30006	0,445	85	685	7 273,127	1 890,643	-456,098
TBU30007	0,445	175	685	7 273,638	1 891,466	-456,098
TBU30008	0,445	270	585	7 274,373	1 890,882	-456,098
TBU30009	0,445	270	685	7 274,472	1 890,896	-456,098
TBU30010	0,445	270	785	7 274,571	1 890,911	-456,098

TBU30011	2,971	0	635	7 273,882	1 890,172	-453,572
TBU30012	2,971	0	735	7 273,896	1 890,073	-453,572
TBU30013	2,971	90	585	7 273,213	1 890,718	-453,572
TBU30014	2,971	90	685	7 273,114	1 890,704	-453,572
TBU30015	2,971	90	785	7 273,015	1 890,689	-453,572
TBU30016	5,394	329	410	7 274,051	1 890,483	-451,149
TBU30017	2,971	175	685	7 273,636	1 891,468	-453,572
TBU30018	2,971	175	735	7 273,625	1 891,517	-453,572
TBU30019	2,971	270	585	7 274,371	1 890,884	-453,572
TBU30020	2,971	270	635	7 274,421	1 890,891	-453,572
TBU30021	2,971	270	685	7 274,470	1 890,898	-453,572
TBU30022	2,971	270	735	7 274,520	1 890,905	-453,572
TBU30023	2,971	270	785	7 274,569	1 890,913	-453,572

TBU30024	5,504	0	635	7 273,887	1 890,169	-451,039
TBU30025	5,504	0	735	7 273,901	1 890,070	-451,039
TBU30026	5,504	270	585	7 274,376	1 890,881	-451,039
TBU30027	5,504	270	685	7 274,475	1 890,895	-451,039
TBU30028	5,504	270	785	7 274,574	1 890,910	-451,039

TBU30029	6,134	0	785	7 273,899	1 890,017	-450,229
TBU30030	6,134	95	585	7 273,203	1 890,762	-450,229
TBU30031	6,134	185	585	7 273,755	1 891,378	-450,229

TBU30032	7,015	0	785	7 273,900	1 890,024	-449,528
----------	-------	---	-----	-----------	-----------	----------

**Table AI:5 Temperature sensors in Dh 3**

Dh3 (DA3575G01) Measurement of total pressure						
ID CODE	Local coordinate system			Äspö 96 coordinate system		
	Z	alfa	r mm	X	Y	Z
PBU30001	0,000	0	0	7 273,794	1 890,799	-456,543
PBU30002	0,495	0	100	7 273,808	1 890,700	-456,048
PBU30003	0,495	5	585	7 273,826	1 890,215	-456,048
PBU30004	0,495	5	685	7 273,832	1 890,115	-456,048
PBU30005	0,495	5	785	7 273,837	1 890,015	-456,048
PBU30006	0,495	95	635	7 273,160	1 890,764	-456,048
PBU30007	0,495	105	735	7 273,064	1 890,886	-456,048
PBU30008	0,495	185	635	7 273,759	1 891,433	-456,048
PBU30009	0,495	195	735	7 273,881	1 891,529	-456,048

PBU30010	3,021	5	535	7 273,822	1 890,267	-453,522
PBU30011	2,771	5	685	7 273,830	1 890,117	-453,772
PBU30012	3,021	5	825	7 273,838	1 890,023	-453,522
PBU30013	2,771	95	585	7 273,208	1 890,769	-453,772
PBU30014	2,771	95	785	7 273,008	1 890,758	-453,772
PBU30015	3,021	185	535	7 273,762	1 891,335	-453,522
PBU30016	2,971	185	825	7 273,746	1 891,625	-453,572

PBU30017	5,556	0	50	7 273,804	1 890,749	-450,987
PBU30018	5,556	5	585	7 273,829	1 890,214	-450,987
PBU30019	5,556	5	685	7 273,835	1 890,114	-450,987
PBU30020	5,556	5	785	7 273,840	1 890,014	-450,987
PBU30021	5,556	90	635	7 273,168	1 890,708	-450,987
PBU30022	5,556	100	735	7 273,062	1 890,822	-450,987
PBU30023	5,556	190	735	7 273,821	1 891,533	-450,987
PBU30024	5,556	180	635	7 273,707	1 891,427	-450,987

PBU30025	6,314	0	50	7 273,794	1 890,745	-450,229
PBU30026	6,564	5	585	7 273,819	1 890,210	-449,979

PBU30027	7,065	0	50	7 273,795	1 890,752	-449,478
----------	-------	---	----	-----------	-----------	----------

**Table AI:6 Total pressure cells in Dh 3**

Dh3 (DA3575G01) Measurement of pore water pressure						
ID CODE	Local coordinate system			Äspö 96 coordinate system		
	Z	alfa	r mm	X	Y	Z
UBU30001	0,045	90	50	7 273,745	1 890,792	-456,498
UBU30002	0,245	90	100	7 273,695	1 890,785	-456,298
UBU30003	0,335	355	585	7 273,927	1 890,229	-456,208
UBU30004	0,335	355	785	7 273,973	1 890,035	-456,208
UBU30005	2,771	355	585	7 273,925	1 890,231	-453,772
UBU30006	2,861	355	785	7 273,971	1 890,037	-453,682
UBU30007	2,861	85	535	7 273,271	1 890,679	-453,682
UBU30008	2,861	85	825	7 272,989	1 890,613	-453,682
UBU30009	2,771	175	535	7 273,670	1 891,322	-453,772
UBU30010	2,771	175	825	7 273,604	1 891,604	-453,772
UBU30011	5,396	355	585	7 273,930	1 891,228	-451,147
UBU30012	5,306	355	785	7 273,976	1 890,034	-451,237
UBU30013	6,314	90	50	7 273,738	1 890,787	-450,229
UBU30014	6,910	90	50	7 273,739	1 890,794	-449,633

**Table AI:7 Pore water pressure gauges in Dh 3**

Dh3 (DA3575G01) Measurement of the water saturation process						
ID CODE	Local coordinate system			Äspö 96 coordinate system		
	Z	alfa	r mm	X	Y	Z
WBU30001	0,045	180	50	7 273,787	1 890,848	-456,498
WBU30002	0,215	0	400	7 273,851	1 890,403	-456,328
WBU30003	0,245	180	100	7 273,780	1 890,898	-456,298
WBU30004	0,335	350	785	7 274,039	1 890,053	-456,208
WBU30005	0,335	350	685	7 274,008	1 890,148	-456,208
WBU30006	0,335	350	585	7 273,976	1 890,243	-456,208
WBU30007	0,335	80	585	7 273,238	1 890,617	-456,208
WBU30008	0,245	80	685	7 273,143	1 890,585	-456,298
WBU30009	0,245	80	785	7 273,048	1 890,554	-456,298
WBU30010	0,245	170	585	7 273,612	1 891,355	-456,298
WBU30011	0,245	170	685	7 273,580	1 891,450	-456,298
WBU30012	0,245	170	785	7 273,549	1 891,545	-456,298

WBU30013	2,861	350	585	7 273,974	1 890,245	-453,682
WBU30014	2,861	350	685	7 274,006	1 890,150	-453,682
WBU30015	2,861	350	785	7 274,037	1 890,055	-453,682
WBU30016	2,771	80	535	7 273,284	1 890,634	-453,772
WBU30017	2,771	80	685	7 273,141	1 890,587	-453,772
WBU30018	2,771	80	785	7 273,046	1 890,556	-453,772
WBU30019	2,861	180	535	7 273,716	1 891,331	-453,682
WBU30020	2,861	180	685	7 273,695	1 891,479	-453,682
WBU30021	2,771	180	785	7 273,680	1 891,578	-453,772

WBU30022	5,416	180	50	7 273,790	1 890,847	-451,127
WBU30023	5,396	352	262	7 273,870	1 890,546	-451,147
WBU30024	5,396	350	585	7 273,979	1 890,242	-451,147
WBU30025	5,396	350	785	7 273,824	1 890,209	-451,147
WBU30026	5,396	350	685	7 274,011	1 890,147	-451,147
WBU30027	5,306	80	585	7 273,241	1 890,616	-451,237
WBU30028	5,306	80	685	7 273,146	1 890,584	-451,237
WBU30029	5,306	80	785	7 273,051	1 890,553	-451,237
WBU30030	5,396	170	585	7 273,615	1 891,354	-451,147
WBU30031	5,306	170	785	7 273,552	1 891,544	-451,237

WBU30032	6,314	180	50	7 273,780	1 890,843	-450,229
WBU30033	6,314	350	585	7 273,969	1 890,238	-450,229
WBU30034	6,314	90	585	7 273,208	1 890,711	-450,229
WBU30035	6,314	180	585	7 273,704	1 891,371	-450,229

WBU30036	6,910	180	50	7 273,781	1 890,850	-449,633
WBU30037	6,750	270	50	7 273,837	1 890,808	-449,793

Table AI:8 Relative humidity sensors in Dh 3

## Appendix II

Final position of all instruments in the backfill



ID CODE	Layer	Installed	Local coordinate system			Äspö 96 coordinate system		
			X	Z	Y	X	Y	Z
CBA101A	51	01-10-05	-2,000	0,000	3580,270	7 272,559	1 885,314	-445,838
CBA101B	51	01-10-05	-1,000	0,000	3580,400	7 273,567	1 885,327	-445,835
CBA102A	51	01-10-05	0,000	0,000	3580,370	7 274,553	1 885,499	-445,836
CBA102B	51	01-10-05	1,000	0,000	3580,400	7 275,547	1 885,611	-445,835
CBA103A	51	01-10-05	2,000	0,000	3580,280	7 276,520	1 885,872	-445,838
CBA106A	76	01-10-31	-2,000	0,000	3570,050	7 271,107	1 895,428	-446,042
CBA106B	76	01-10-31	-1,000	0,000	3570,150	7 272,11	1 895,47	-446,040
CBA107A	76	01-10-31	0,000	0,000	3570,150	7 273,10	1 895,61	-446,040
CBA107B	76	01-10-31	1,000	0,000	3570,130	7 274,09	1 895,78	-446,040
CBA108A	76	01-10-31	2,000	0,000	3570,020	7 275,06	1 896,03	-446,042
CBA108B	87	01-11-07	-2,000	0,000	3565,580	7 270,473	1 899,852	-446,131
CBA109A	87	01-11-07	-1,000	0,000	3565,760	7 271,488	1 899,816	-446,127
CBA109B	87	01-11-07	0,000	0,000	3565,780	7 272,481	1 899,938	-446,127
CBA110A	87	01-11-07	1,000	0,000	3565,710	7 273,461	1 900,149	-446,128
CBA110B	87	01-11-07	2,000	0,000	3565,530	7 274,425	1 900,470	-446,132
CBA13B	64	01-10-17	-2,000	0,000	3576,000	7 271,953	1 889,539	-445,923
CBA14A	64	01-10-17	-1,000	0,000	3576,000	7 272,942	1 889,682	-445,923
CBA14B	64	01-10-17	0,000	0,000	3576,000	7 273,932	1 889,824	-445,923
CBA15A	64	01-10-17	1,000	0,000	3576,000	7 274,922	1 889,966	-445,923
CBA15B	64	01-10-17	2,000	0,000	3576,000	7 275,912	1 890,108	-445,923

**Table All:1 Concrete parcels containing cellulose**

ID CODE	Layer	Installed	Local coordinate system			Äspö 96 coordinate system		
			X	Z	Y	X	Y	Z
DBU101		01-09-17	0,000	-3,547	3 587,20	7 275,533	1 878,668	-449,246
DBU201		01-09-24	0,000	-3,505	3 581,00	7 274,653	1 884,804	-449,328
DBU301		01-09-25	0,000	-3,520	3 575,22	7 273,831	1 890,526	-449,458
DBU401		01-10-22	0,000	-3,515	3 569,00	7 272,948	1 896,680	-449,577

**Table All:2 Devices for measuring horizontal displacements**

ID CODE	Layer	Installed	Local coordinate system			Äspö 96 coordiante system		
			X	Z	Y	X	Y	Z
KBU101	23	01-09-20	0,000	2,450	3595,000	7 276,626	1 871,055	-443,094
KBU102	10	01-09-05	0,000	-2,400	3591,815	7 276,187	1 874,112	-448,007
KBU103	65	01-10-24	0,000	2,400	3578,000	7 274,210	1 887,892	-443,484
KBU104	47	01-10-03	0,000	-2,400	3578,000	7 274,223	1 887,797	-448,283
KBU105	97	01-11-14	0,000	2,400	3565,000	7 272,370	1 900,710	-443,742

**Table All:3 Titanium cups for water sampling**

ID CODE	Layer /Dep. hole	Installed	Local coordinate system			Äspö 96 coordinate system		
			X	Z	Y	X	Y	Z
PBA101	28	01-09-22	0,200	0,100	3588,750	7 275,943	1 877,223	-445,569
PBA102	33	01-09-23	0,000	0,000	3587,300	7 275,539	1 878,629	-445,698
PBA103	25	01-09-20	0,000	-1,770	3587,000	7 275,501	1 878,891	-447,473
PBA104	8/1	01-09-18	0,000	-2,600	3 587,00	7 275,502	1 878,886	-448,303
PBA105	4/1	01-09-17	0,000	-3,120	3 587,00	7 275,504	1 878,876	-448,823
PBA106	33	01-09-23	-2,300	0,100	3587,000	7 273,219	1 878,601	-445,604
PBA107	41	01-10-01	0,150	2,300	3587,000	7 275,637	1 879,004	-443,404
PBA108	41	01-09-27	0,000	0,000	3584,120	7 275,086	1 881,788	-445,761
PBA109	36	01-09-25	-0,120	-1,800	3584,000	7 274,955	1 881,854	-447,563
PBA110	56	01-10-12	0,000	-0,200	3578,000	7 274,217	1 887,840	-446,083
PBA111	48	01-10-03	0,000	-2,300	3578,000	7 274,223	1 887,799	-448,183
PBA113	56	01-10-12	0,000	-1,820	3575,000	7 273,795	1 890,777	-447,763
PBA115	3/3	01-10-08	0,000	-3,115	3 575,00	7 273,799	1 890,752	-449,057
PBA116	64	01-10-18	-2,300	0,000	3575,000	7 271,514	1 890,486	-445,943
PBA117	73	0110/30	0,000	0,000	3574,800	7 273,755	1 891,056	-443,698
PBA118	77	01-10-29	0,000	0,000	3572,000	7 273,364	1 893,782	-446,003
PBA119	63	01-10-18	0,000	-2,300	3572,000	7 273,371	1 893,737	-448,302
PBA120	97	01-11-14	0,000	0,000	3561,470	7 271,868	1 904,203	-446,213

**Table All:4 Total pressure sensors**



ID CODE	Layer /Dep. hole	Installed	Local coordinate system			Äspö 96 coordinate system		
			X	Z	Y	X	Y	Z
TBA101	33	01-09-23	-1,250	-0,100	3587,200	7 274,288	1 878,548	-445,800
TBA102	39	01-09-27	0,100	1,250	3587,000	7 275,590	1 878,976	-444,454
TBA103	31	01-09-22	-0,040	-0,800	3587,000	7 275,459	1 878,904	-446,503
TBA104	8/1	01-09-18	-0,500	-2,600	3 587,00	7 275,007	1 878,815	-448,303
TBA105	8/1	01-09-18	0,500	-2,600	3 587,00	7 275,997	1 878,957	-448,303
TBA106	41	01-10-01	-0,100	2,300	3587,000	7 275,389	1 878,969	-443,404
TBA107	33	01-09-23	1,250	-0,100	3587,200	7 276,762	1 878,903	-445,800
TBA108	47	01-10-03	0,000	1,255	3584,000	7 275,065	1 881,931	-444,509
TBA109	36	01-09-25	-0,120	-1,325	3584,035	7 274,958	1 881,828	-447,088
TBA110	61	01-10-17	0,000	1,150	3578,000	7 274,213	1 887,867	-444,734
TBA111	52	01-10-11	0,000	-1,240	3578,000	7 274,220	1 887,820	-447,123
TBA112	73	01-10-30	-0,100	2,25	3574,750	7 273,649	1 891,091	-443,699
TBA113	70	01-10-26	0,000	1,250	3575,000	7 273,787	1 890,838	-444,693
TBA114	61	01-10-17	0,000	-0,860	3575,000	7 273,793	1 890,796	-446,803
TBA115	8/3	01-10-08	-0,500	-2,570	3 575,00	7 273,303	1 890,692	-448,513
TBA116	8/3	01-10-08	0,500	-2,570	3 575,00	7 274,292	1 890,834	-448,513
TBA117	64	01-10-18	-1,250	0,000	3575,000	7 272,553	1 890,636	-445,943
TBA118	64	01-10-18	1,250	0,000	3575,000	7 275,028	1 890,991	-445,943
TBA119	76	01-10-31	-0,030	1,160	3572,000	7 273,331	1 893,801	-444,843
TBA120	67	01-10-25	0,000	-1,250	3571,970	7 273,363	1 893,787	-447,253

**Table All:5 Thermocouples**

ID CODE	Layer	Installed	Local coordinate system			Äspö coordinate system		
			X	Z	Y	X	Y	Z
UBA101	28	01-09-22	-0,230	-0,090	3588,750	7 275,518	1 877,158	-445,759
UBA102	20	01-09-13	0,000	0,000	3592,170	7 276,231	1 873,808	-445,600
UBA103	25	01-09-20	-0,190	-0,093	3590,323	7 275,781	1 875,607	-445,730
UBA104	33	01-09-23	0,000	-0,100	3587,300	7 275,539	1 878,627	-445,798
UBA105	25	01-09-20	-0,180	-1,770	3587,110	7 275,339	1 878,756	-447,471
UBA106	8/1	01-09-18	0,100	-2,600	3 586,90	7 275,587	1 878,999	-448,305
UBA107	4/1	01-09-17	0,400	-3,150	3 587,00	7 275,900	1 878,932	-448,853
UBA108	33	01-09-23	-2,300	0,000	3587,000	7 273,220	1 878,599	-445,704
UBA109	41	01-10-01	0,000	2,300	3587,000	7 275,488	1 878,983	-443,404
UBA110	41	01-09-27	0,000	0,000	3584,200	7 275,097	1 881,708	-445,760
UBA111	36	01-09-25	0,140	-1,810	3584,000	7 275,212	1 881,890	-447,573
UBA112	56	01-10-12	0,000	-0,200	3578,000	7 274,217	1 887,840	-446,083
UBA113	48	01-10-03	0,000	-2,300	3578,000	7 274,223	1 887,799	-448,183
UBA114	64	01-10-18	0,000	0,000	3575,000	7 273,790	1 890,813	-445,943
UBA115	56	01-10-12	0,000	-1,820	3575,000	7 273,795	1 890,777	-447,763
UBA116	8/3	01-10-08	0,250	-2,570	3 575,00	7 274,045	1 890,798	-448,513
UBA117	3/3	01-10-08	-0,100	-3,115	3 575,00	7 273,700	1 890,738	-449,057
UBA118	64	01-10-18	-2,300	0,000	3575,000	7 271,514	1 890,486	-445,943
UBA119	73	01-10-18	0,000	0,000	3574,700	7 273,741	1 891,155	-443,700
UBA120	77	01-10-29	0,000	0,000	3572,000	7 273,364	1 893,782	-446,003
UBA121	63	01-10-18	0,000	-2,300	3572,000	7 273,371	1 893,737	-448,302
UBA122	89	01-11-07	0,000	0,000	3565,000	7 272,370	1 900,710	-446,142
UBA123	97	01-11-14	0,100	0,000	3561,550	7 271,979	1 904,138	-446,211

**Table All:6 Pore water pressure sensors**

ID CODE	Layer	Installed	Local coordinate system			Äspö 96 coordinate system		
			X	Z	Y	X	Y	Z
WBA101	28	01-09-22	0,000	0,000	3588,750	7 275,745	1 877,193	-445,669
WBA102	20	01-09-13	0,000	0,000	3592,170	7 276,231	1 873,808	-445,600
WBA103	25	01-09-20	0,090	-0,100	3590,280	7 276,052	1 875,689	-445,738
WBA107	41	01-10-01	0,250	2,300	3587,000	7 275,736	1 879,018	-443,404
WBA105	39	01-09-27	0,000	1,250	3587,000	7 275,491	1 878,962	-444,454
WBA106	33	01-09-23	0,000	0,100	3587,300	7 275,539	1 878,631	-445,598
WBA107	31	01-09-22	0,070	-0,785	3587,000	7 275,568	1 878,920	-446,488
WBA108	25	01-09-20	0,000	-1,730	3587,150	7 275,523	1 878,743	-447,430
WBA109	8/1	01-09-18	-0,100	-2,600	3 587,10	7 275,417	1 878,773	-448,301
WBA110	4/1	01-09-17	-0,500	-3,130	3 587,00	7 275,009	1 878,805	-448,833
WBA111	33	01-09-23	-2,300	-0,100	3587,000	7 273,220	1 878,597	-445,804
WBA112	33	01-09-23	-1,250	0,000	3587,200	7 274,288	1 878,550	-445,700
WBA113	33	01-09-23	1,250	0,000	3587,200	7 276,762	1 878,905	-445,700
WBA114	33	01-09-23	2,300	0,000	3587,000	7 277,773	1 879,252	-445,704
WBA115	47	01-10-03	-0,010	1,255	3584,000	7 275,055	1 881,930	-444,509
WBA116	51	01-10-04	0,000	2,300	3584,000	7 275,062	1 881,952	-443,464
WBA117	41	01-09-27	0,000	0,000	3584,170	7 275,093	1 881,738	-445,760
WBA118	36	01-09-25	0,030	-1,285	3584,030	7 275,106	1 881,856	-447,048
WBA119	41	01-09-27	0,000	0,000	3584,170	7 275,093	1 881,738	-445,760
WBA120	41	01-09-27	0,000	0,000	3584,235	7 275,102	1 881,674	-445,759
WBA121	65	01-10-23	0,000	2,280	3578,000	7 274,210	1 887,889	-443,604
WBA122	61	01-10-17	0,000	1,150	3578,000	7 274,213	1 887,867	-444,734
WBA123	56	01-10-12	0,000	-0,200	3578,000	7 274,217	1 887,840	-446,083
WBA124	52	01-10-11	0,000	-1,240	3578,000	7 274,220	1 887,820	-447,123
WBA125	56	01-10-12	-1,250	0,000	3578,000	7 272,979	1 887,667	-445,883
WBA126	56	01-10-12	1,250	0,000	3578,000	7 275,454	1 888,022	-445,883
WBA127	73	01-10-12	0,000	2,450	3574,700	7 273,811	1 891,164	-443,700
WBA128	70	01-10-26	0,000	1,250	3575,000	7 273,787	1 890,838	-444,693
WBA129	64	01-10-18	0,000	0,000	3575,000	7 273,790	1 890,813	-445,943
WBA130	61	01-10-17	0,000	-0,860	3575,000	7 273,793	1 890,796	-446,803
WBA131	56	01-10-12	0,000	-1,590	3575,000	7 273,795	1 890,782	-447,533
WBA132	8/3	01-10-08	-0,250	-2,570	3 575,00	7 273,550	1 890,727	-448,513
WBA133	3/3	01-10-08	0,100	-3,115	3 575,00	7 273,898	1 890,766	-449,057
WBA134	64	01-10-18	-2,300	0,000	3575,000	7 271,514	1 890,486	-445,943
WBA135	64	01-10-18	-1,250	0,000	3575,000	7 272,553	1 890,636	-445,943
WBA136	64	01-10-18	1,250	0,000	3575,000	7 275,028	1 890,991	-445,943
WBA137	64	01-10-18	2,300	0,000	3575,000	7 276,067	1 891,140	-445,943
WBA138	80	01-11-01	0,000	2,300	3572,000	7 273,36	1 893,83	-443,703
WBA139	76	01-10-31	0,030	1,160	3572,000	7 273,391	1 893,809	-444,843
WBA140	77	01-10-29	0,000	0,000	3572,000	7 273,364	1 893,782	-446,003
WBA141	67	01-10-25	0,000	-1,250	3572,030	7 273,372	1 893,728	-447,252
WBA142	77	01-10-29	-1,250	0,000	3572,000	7 272,127	1 893,605	-446,003
WBA143	77	01-10-29	1,250	0,000	3572,000	7 274,601	1 893,960	-446,003
WBA144	89	01-11-07	0,000	0,000	3565,000	7 272,370	1 900,710	-446,142
WBA145	97	01-11-14	-0,100	0,000	3561,570	7 271,784	1 904,090	-446,211

**Table All:7 Wescor psychrometers for measuring the relative humidity**