

**Development of fabrication  
technology for copper canisters  
with cast inserts**

**Status report in August 2001**

Claes-Göran Andersson  
Svensk Kärnbränslehantering AB

April 2002

**Svensk Kärnbränslehantering AB**

Swedish Nuclear Fuel  
and Waste Management Co  
Box 5864  
SE-102 40 Stockholm Sweden  
Tel 08-459 84 00  
+46 8 459 84 00  
Fax 08-661 57 19  
+46 8 661 57 19



# **Development of fabrication technology for copper canisters with cast inserts**

**Status report in August 2001**

Claes-Göran Andersson  
Svensk Kärnbränslehantering AB

April 2002

## Summary

This report contains an account of the results of trial fabrication of copper canisters with cast inserts carried out during the period 1998–2001. The work of testing of fabrication methods is being focused on a copper thickness of 50 mm. Occasional canisters with 30 mm copper thickness are being fabricated for the purpose of gaining experience and evaluating fabrication and inspection methods for such canisters. For the fabrication of copper tubes, SKB has concentrated its efforts on seamless tubes made by extrusion and pierce and draw processing. Five tubes have been extruded and two have been pierced and drawn during the period. Materials testing has shown that the resultant structure and mechanical properties of these tubes are good. Despite certain problems with dimensional accuracy, it can be concluded that both of these methods can be developed for use in the serial production of SKB's copper tubes. No new trial fabrication with roll forming of copper plate and longitudinal welding has been done. This method is nevertheless regarded as a potential alternative.

Copper lids and bottoms are made by forging of continuous-cast bars. The forged blanks are machined to the desired dimensions. Due to the Canister Laboratory's need for lids to develop the technique for sealing welding, a relatively large number of forged blanks have been fabricated. It is noted in the report that the grain size obtained in lids and bottoms is much coarser than in fabricated copper tubes. Development work has been commenced for the purpose of optimizing the forging process.

Nine cast inserts have been cast during the three-year period. The results of completed material testing of test pieces taken at different places along the length of the inserts have in several cases shown an unacceptable range of variation in strength properties and structure. In the continued work, insert fabrication will be developed in terms of both casting technique and iron composition.

Development work on the alternative welding method Friction Stir Welding is described in a special chapter in the report. A machine for full-scale welding of lids or bottoms to copper tubes has been designed and built in cooperation with TWI (The Welding Institute, near Cambridge in England). The machine is now being used for optimization of process parameters and tools.

Seven complete canisters of the current design with cast insert have so far been assembled and another two are under fabrication. Five canisters have so far been deposited in the Äspö HRL, both in the Retrieval Project and in the Prototype Repository.

The results in the report show that fabrication methods are available for all parts of canisters and that these methods can probably be developed and gain acceptance for use in serial production.

# Contents

<b>1</b>	<b>Introduction</b>	<b>7</b>
<b>2</b>	<b>Canister, current design and choice of materials</b>	<b>9</b>
2.1	General	9
2.2	Detailed canister design	10
2.3	Identity numbers and marking of components and canisters	11
2.4	Choice of materials	12
2.4.1	Material in copper shell	12
2.4.2	Material in insert	14
<b>3</b>	<b>Current fabrication technology</b>	<b>19</b>
3.1	Fabrication of copper tubes	19
3.2	Fabrication of copper lids and bottoms	25
3.3	Welding of bottoms on copper tubes	26
3.4	Fabrication of cast inserts	28
<b>4</b>	<b>Results of trial fabrication</b>	<b>33</b>
4.1	Overview	33
4.2	Fabrication of copper tubes	34
4.3	Fabrication of copper lids and bottoms	37
4.4	Fabrication of cast inserts	39
<b>5</b>	<b>Assembled complete canisters</b>	<b>43</b>
<b>6</b>	<b>Development of welding technology – Friction Stir Welding</b>	<b>45</b>
6.1	Background	45
6.2	Development of FSW of copper	46
6.2.1	Welding of copper plates	46
6.2.2	Machine for welding of lid or bottom to copper tube	48
6.2.3	Results of completed weldings	52
6.2.4	Further development of method. Parking of exit hole	55
<b>7</b>	<b>Quality assurance</b>	<b>57</b>
<b>8</b>	<b>Future serial production – Canister factory</b>	<b>59</b>
<b>9</b>	<b>Continued work</b>	<b>61</b>
<b>10</b>	<b>References</b>	<b>65</b>

<b>Appendix 1</b>	Drawings. Canister with insert of spheroidal graphite cast iron for 12 BWR assemblies	67
<b>Appendix 2</b>	Technical specification KTS 001 “Material for Copper Canisters”	83
<b>Appendix 3</b>	Technical specification KTS 011 “Nodular Cast Iron SS 0717 Insert”	89
<b>Appendix 4</b>	Technical specification KTS 021 “Steel Section Cassette”	93
<b>Appendix 5</b>	Drawings. Adaptation of copper tube and bottom for EB welding	97
<b>Appendix 6</b>	Contents of Quality Manual – Canister Fabrication and list of procedure descriptions	101
<b>Appendix 7</b>	Planning of canister factory	105

# 1 Introduction

In order to further develop the fabrication technology for copper canisters and cast inserts, continued fabrication trials have been carried out on a full scale during the past few years in accordance with the programme described in RD&D 98 [1]. Results obtained up to August 1998 were described in a previous report [4].

Full-scale trial fabrication provides experience of different fabrication methods and an opportunity to find and optimize the most suitable fabrication technique. The work is being pursued of necessity in close cooperation with available suppliers, but also with research institutes, colleges and universities. This makes it possible to forge long-term relationships and find the best suppliers of stock material and technology. The research projects that are being conducted at institutes, colleges and universities are leading to a deeper knowledge and understanding of the factors that influence and are crucial for the results of a fabrication process. Some of the fabrication methods being considered for canister components, such as fabrication of copper tubes and welding of copper, have required development work from the ground up and in the front line of the relevant field of technology. This has given SKB unique knowledge in some respects and even the sole right to some technology.

The quality system for canister fabrication is being applied and further developed in conjunction with ongoing trial fabrication. This system is intended to cover the entire chain from material suppliers to delivery of finished canisters. The quality system is a part of SKB's certified quality systems in accordance with ISO 9001 and ISO 14001.

In a future fabrication process at an encapsulation plant, complete canisters will be manufactured in a specially designed factory. After approved inspection, the canisters will be delivered to the encapsulation plant. Full-scale trial fabrication provides experience that will be applied in designing this factory.

The purpose of this report has been to compile the results and conclusions of completed trial fabrication and technology development with regard to canister fabrication during the past three-year period up to and including August 2001. The report also presents plans for continued work.

## 2 Canister, current design and choice of materials

### 2.1 General

In its fundamental design (see Figure 2-1), the canister consists of an inner container of cast iron and an outer shell of copper. The inner container, the insert, is designed to withstand the pressure to which the canister will be subjected in the deep repository, while the copper shell provides protection against corrosion in the repository environment.

The insert can be cast in one piece with bottom. It contains channels for the fuel assemblies and has a separate steel lid designed to be screwed on. The copper shell consists of a tube with lid and bottom. Both lid and bottom are designed to be welded to the copper tube.

The thickness of the copper shell on SKB's reference canister is set at 50 mm. In RD&D 98 [1] and in [5], SKB arrives at the conclusion that when the requirements on corrosion resistance and other design premises are weighed together, a 30 mm thickness of the copper shell is found to be sufficient. Testing of fabrication methods and optimization of canister design are focused on a 50 mm copper thickness. Canisters with a 30 mm wall thickness are being fabricated for the purpose of gaining experience and evaluating fabrication and inspection methods for such canisters. This knowledge will comprise a basis for a possible later decision to change the wall thickness. The outside diameter of the copper canister is the same whether the wall thickness is 30 or 50 mm. With a 30 mm copper thickness, the insert will therefore have a larger diameter (40 mm) and the inside diameter of the copper tube will increase equally. Since the copper lid and bottom are also thinner, the length of the canister will be slightly less.

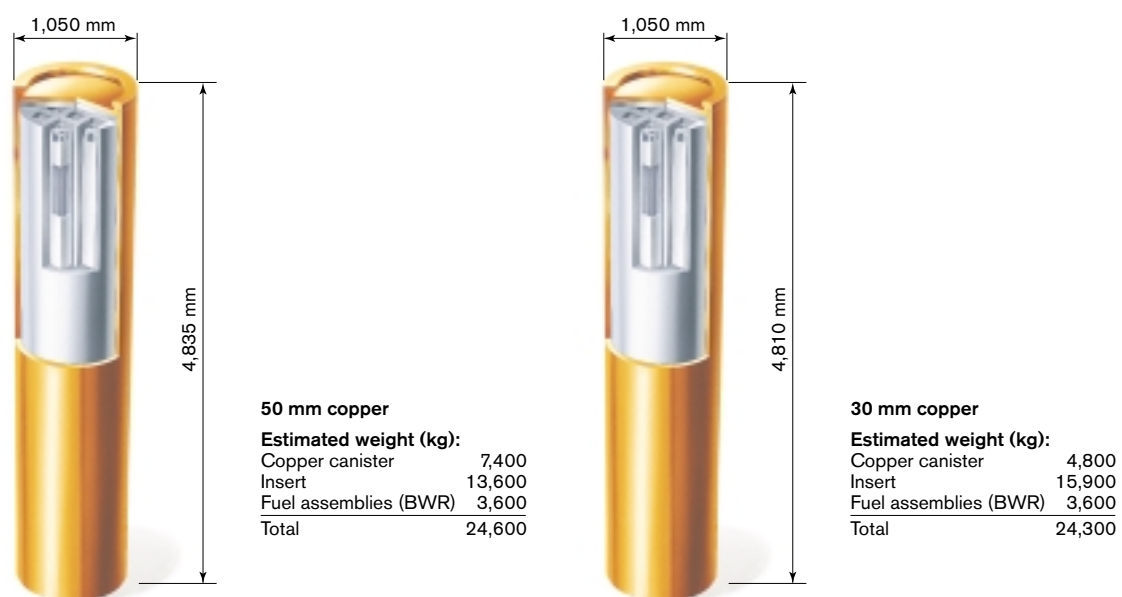
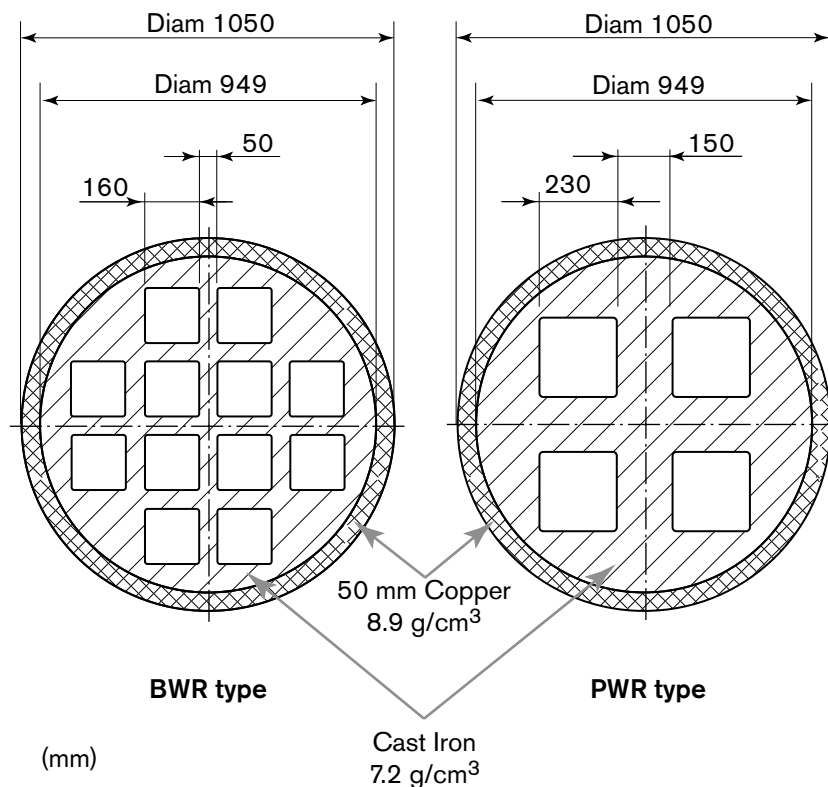


Figure 2-1. Dimensions and weights of canister with 50 mm and 30 mm wall thickness.

The cast insert is designed in two different variants: to hold 12 BWR assemblies or 4 PWR assemblies, Figure 2-2. Since the outside dimensions, length and diameter of the inserts are the same, only one design of the copper shell is needed, for either 50 mm or 30 mm copper thickness.

## 2.2 Detailed canister design

A set of detailed drawings has been produced for the different fabrication trials. The drawings are revised as needed. Drawings and drawing changes are managed in accordance with procedures included in the quality system for canister fabrication. Complete series of drawings exist for all relevant canister variants, i.e. canisters with 50 or 30 mm copper walls and inserts for either BWR or PWR assemblies. A set of drawings for a canister with 50 mm copper and an insert for BWR assemblies are shown as an example in Appendix 1 (14 pages). The drawing tree on page 68 in the appendix shows the structure of the system, how the drawings are based on each other and form the canister fabrication chain. The principle is that blank drawings are at the bottom of the hierarchy and the degree of finish machining and assembly increases upwards in the tree. Detailed information including drawing number and revision number is shown in the lower right-hand corner of each drawing.



*Figure 2-2. The figure shows the schematic design of inserts for 12 BWR or 4 PWR assemblies for canisters with a 50 mm thick copper shell.*



A similar set of drawings was found in the previous report from 1998 [4]. Some comments can be made regarding the development of the canister's detailed design during the past three years:

- Drawings of copper tubes that are fabricated seamlessly, without longitudinal welds, have been developed. See Appendix 1, page 72. (Drawing 00004-111, rev C). In comparison with copper tubes made by roll forming of tube halves that are welded together, seamless copper tubes require slightly greater machining allowances for finish machining. (Cf. Appendix 1, pages 5 and 6 in reference [4]).
- Appendix 1, page 74 in this report shows the design of a forged and rough-machined blank for lid or bottom. This blank drawing has been prepared so that the same blank can be used for fabrication of both lids and bottoms.
- The design of the steel lid for inserts has been changed. The current design is shown in Appendix 1, pages 78 and 79. The steel lid is now conical with double O-rings in grooves on the conical surface. (Cf. Appendix 1, pages 10 and 11 in reference [4]). The change is intended to make the lid easier to fit tightly in the mounting on the insert.

## 2.3 Identity numbers and marking of components and canisters

The previous status report from August 1998 describes the principle of the serial number system for identification of canister components and complete canisters that had then begun to be applied. All fabricated components are given a unique serial number for identification and traceability according to the following principle:

<b>Component</b>	<b>Identity number</b>
Copper tubes	T 1, T 2, T 3 etc
Blanks for copper lids or bottoms	TX 1, TX 2, TX 3 etc
Bottoms for copper tubes	TB 1, TB 2, TB 3 etc
Lids for copper tubes	TL 1, TL 2, TL 3 etc
Inserts for BWR assemblies	I 1, I 2, I 3 etc
Inserts for PWR assemblies	IP 1, IP 2, IP 3 etc
Lids for inserts	IL 1, IL 2, IL 3 etc
Complete canisters	C 1, C 2, C 3 etc

There is a special procedure for this marking that belongs to the quality system for canister fabrication. The quality system is discussed in its entirety in Chapter 7. The serial numbers are stamped mechanically into the surface of the part in a location indicated on each drawing. See e.g. "Note 2" on the drawing, page 73 in Appendix 1. SKB specifies which identity numbers are to be used in each order. The locations for the marking have been chosen so that when a complete canister is assembled, the identity numbers on all canister parts will be concealed on the inside of the canister. The complete canister's ID number C XX is on the top of the lid according to the drawing on page 69 in Appendix 1, and this is the only marking on the outside of the canister.

## 2.4 Choice of materials

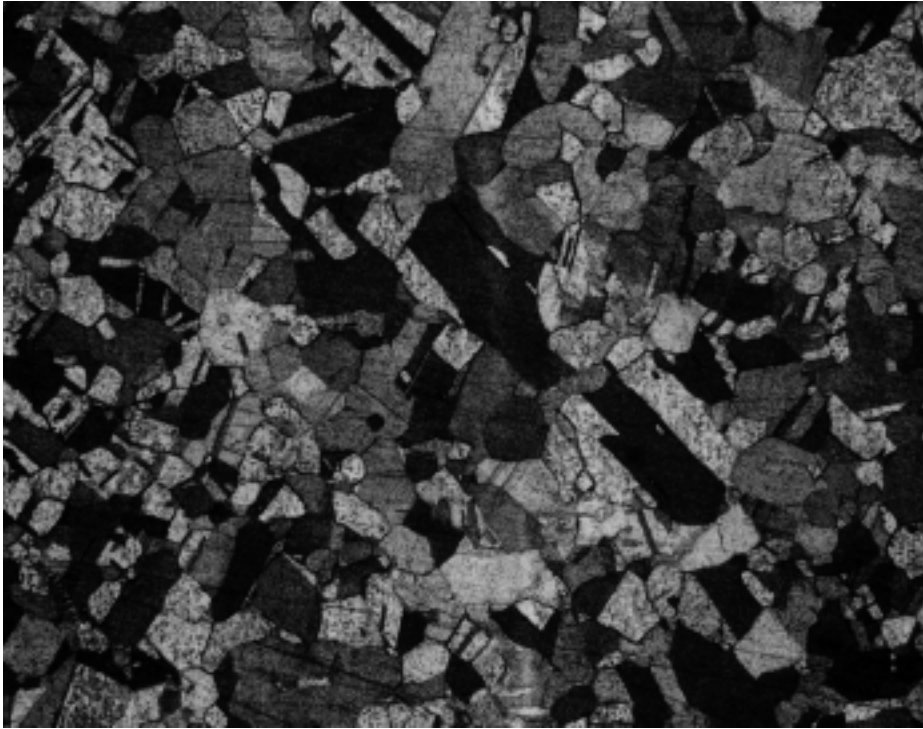
### 2.4.1 Material in copper shell

In order to satisfy the requirement on chemical resistance in the environment prevailing in the deep repository, copper has been chosen as a barrier to corrosion. Copper is judged to have the required life, combined with minimum impact on other barriers in the deep repository. The technical considerations and tests of properties that have led to the choice of copper grade have been thoroughly described in reference [5]. With this background, SKB has compiled a technical specification with requirements on the copper material, see Appendix 2, which contains the relevant specification (KTS 001, revision 2). The fundamental requirement on corrosion resistance has led to the decision to use pure oxygen-free copper. Due to SKB's other special requirements on the material, there is no direct equivalent in Swedish or international standards. As can be seen from Appendix 2, the material according to KTS 001 shall fulfil the requirements in the standards ASTM UNS C10100 (Cu-OFE) or EN133/63:1994 Cu-OF1, with the additional requirements: O<5 ppm, P 40–60 ppm, H<0.6 ppm, S<8 ppm, and that the grain size in forged blanks for lids and bottoms, in rolled plate for tube fabrication, and in seamless tubes shall be less than 360 µm. The reason for the (in some respects) tougher requirements compared with international standard can be summarized as follows:

- For fabrication-related reasons, there must be a clearance of a mm or so between the insert and the copper shell. This means that the copper shell will be deformed plastically by up to 4% in the deep repository. This deformation will take place chiefly via creep. The material must have a ductility that allows this with good margin. Elements such as hydrogen and sulphur have a negative effect and must be reduced to low concentrations. Phosphorus has been found to have a favourable effect on creep ductility and is therefore specified in KTS 001 at a concentration of 40–60 ppm.
- The material must be able to be welded by means of electron beam welding (EBW). The oxygen concentration has a negative influence and must lie at a low level.
- A large and uneven grain size is unfavourable for the properties of the material and therefore also leads to difficulties in ultrasonic testing. The permissible grain size in the copper shell has therefore been set at 360 µm. (Average grain size according to ASTM E112-95.)

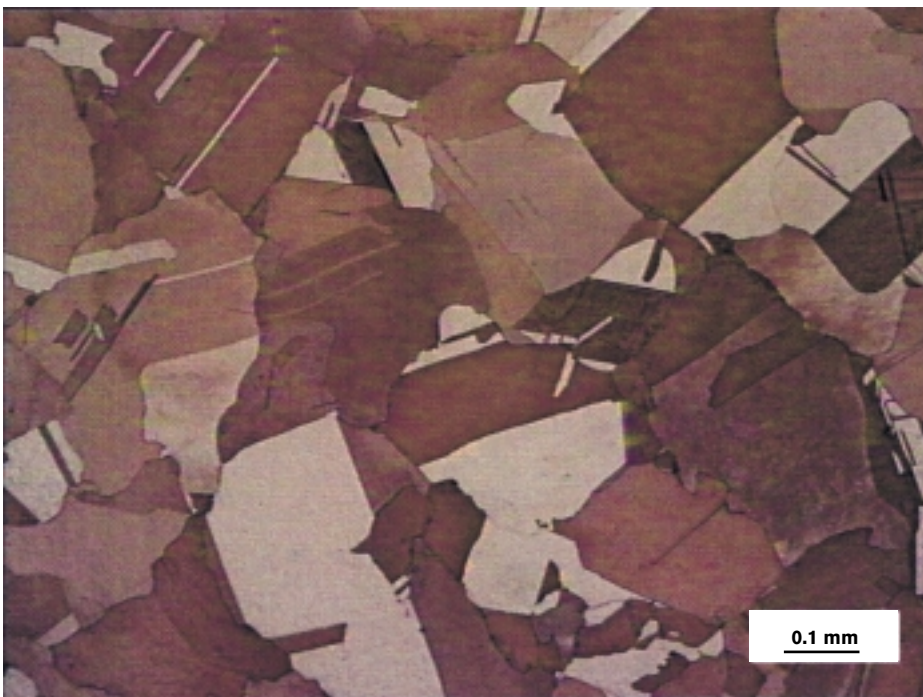
Figure 2-3 shows micrographs from two different fabricated components with different grain sizes.

Besides pure material requirements, KTS 001 also contains requirements on technical documentation in the fabrication of canister components of copper as well as certain delivery provisions.



*Figure 2-3A.*

100x



*Figure 2-3B.*

100x

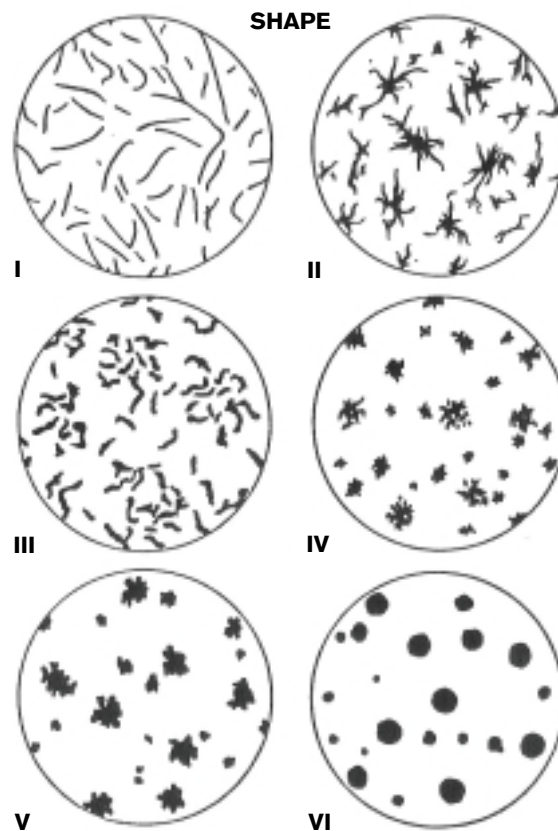
*Figure 2-3A–B.* The microstructure of two fabricated copper components with different grain sizes. Photo A is a micrograph of the structure in tube T 23, fabricated by extrusion. The average grain size in this part of the tube is about 60  $\mu\text{m}$ . As a comparison, the microstructure of a forged blank for lid or bottom TX 38 is shown in B. The grain size in this case has been set at about 300  $\mu\text{m}$ . Both components meet the set requirement on grain size.

## 2.4.2 Material in insert

In the canister design in question, the inserts for both BWR and PWR assemblies are designed to be fabricated by casting. The canister insert is the pressure-bearing component in the canister and must fulfil the strength requirements that follow from this. Materials that have been discussed and even tested to a varying extent are bronze, cast steel and cast iron. The exact choice of cast alloy is also guided by casting-related aspects and the fact that it must be possible to machine the material to the required specifications in a rational manner. Examples of casting-related aspects are that the inserts must be able to be cast so that a sufficiently homogeneous and flawless structure is obtained in their entire volume, and that the channels for the fuel assemblies should not be deformed in an unacceptable manner.

The development of materials in inserts up to the use of cast iron is described in reference [4]. The same kind of cast iron has been used in all fabricated inserts starting with insert No. I 7. The most recently fabricated insert was No. I 23. Only one insert for PWR assemblies, IP 1, has been cast so far.

Cast iron is the name given to iron-carbon alloys with more than approximately 2 percent carbon by weight. The cast irons used usually have carbon concentrations in the range 2.5–4.0%. In one group of cast irons, carbon that is not bound in any other way is precipitated as free graphite when the molten iron cools and solidifies. The graphite can appear in different forms, and it is the form of the free graphite that determines different types of graphitic cast iron. These types have been standardized and are shown in Figure 2-4, which is taken from EN-ISO 945.



*Figure 2-4. Graphite shape in cast iron according to EN-ISO 945. The dominant graphite shape in spheroidal graphite cast iron is No. VI. (Nodular graphite)*

Iron with graphite shape I is usually called grey iron. Grey iron is the most widely manufactured cast metal and is used in many different contexts. Spheroidal graphite (SG) cast iron, also called nodular iron, with graphite shape VI is also produced in large volumes. Components of the same or larger size compared with SKB's insert are produced in many foundries in both grey iron and SG iron. Other less widely occurring irons are malleable cast iron with graphite shape V and compact graphite iron with graphite shape III. None of these has been judged to be suitable as a material in the canister insert.

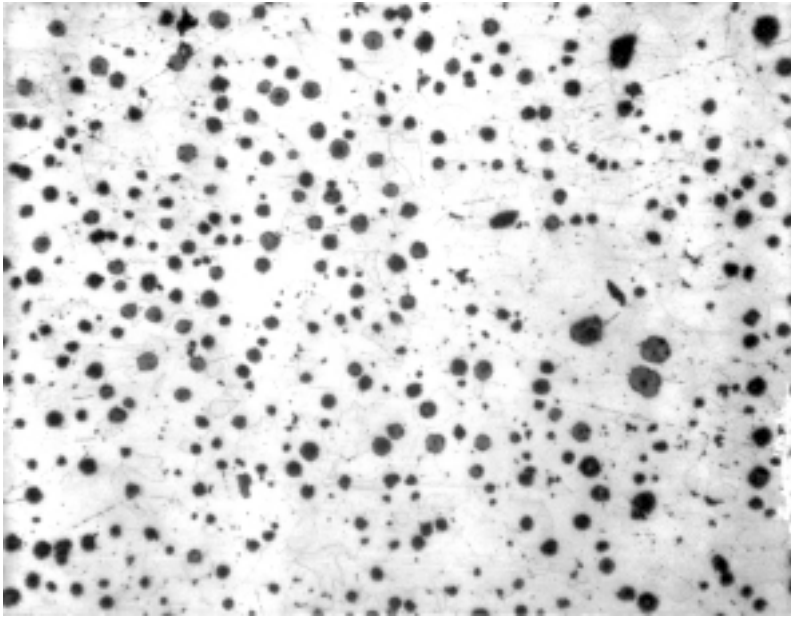
The shape of the graphite has a great influence on the properties of the material. In grey iron, the flakes of graphite act as stress concentrators inside the material, and grey iron is therefore generally a brittle material. SG iron has a much higher strength and toughness than grey iron since the graphite is of nodular shape. Requirements on strong and tough cast iron have given SG iron wide usage in many components, especially within the automotive industry. These strength properties, plus the fact that SG iron has good casting properties and is easy to machine, have made SG or nodular iron SKB's first choice for cast inserts.

The nodular shape of the graphite in SG iron is obtained by the addition of small quantities of magnesium to the melt. Besides the shape, the size and distribution of the graphite particles are influenced by the addition of an "inoculant" (generally ferrosilicon) as well as by the casting temperature and cooling conditions. The size and distribution of the nodules also affect the properties of the SG iron.

In addition to carbon, the cast iron also always contains silicon, manganese, phosphorus and sulphur. Silicon, manganese and phosphorus can also be used in different concentrations as alloying elements to control the properties of the iron. Other alloying elements such as copper, nickel, molybdenum and chromium are also commonly used as additives to control the properties and increase the strength of the iron.

A number of SG irons are standardized in SS-EN 1563. The standard makes no requirements on chemical composition. It does, however, specify that the graphite shape shall mainly be V and VI and contains specific requirements on mechanical properties. To achieve the high demands on toughness made on SG iron, the graphite must exist in the form of nodules in the matrix. Figure 2-5 shows the structure in a sample from insert No. I 16 with an even distribution of graphite nodules.

Mechanical properties are tested by tensile testing on test bars, which in the case of cast iron can be taken out in different ways. In this context we will differentiate between cast-on test bars and test bars made directly from a part of the casting. The latter of these alternatives should be the most representative of the properties of the finished component. Cast-on test bars are obtained by providing suitable cavities in the mould wall that produce a test body attached directly to the casting. See Figure 2-6, which illustrates the principle of this in the manufacture of SKB's inserts. The cast-on test bodies harden and cool together with the insert and should therefore have a structure and thereby properties equivalent to the cast iron in the insert. The cast-on test body can be sawn away from the insert wall without damaging the insert. In order to enable the properties to be determined in a cross-section through the insert, a number of extra-long inserts have been cast so that a disc (200 mm) can be cut out of the top of the insert while still obtaining a full-length insert. This is also indicated in Figure 2-6.



*Figure 2-5. Structure in insert I 16. Cast-on test bar near bottom of insert (100x).*



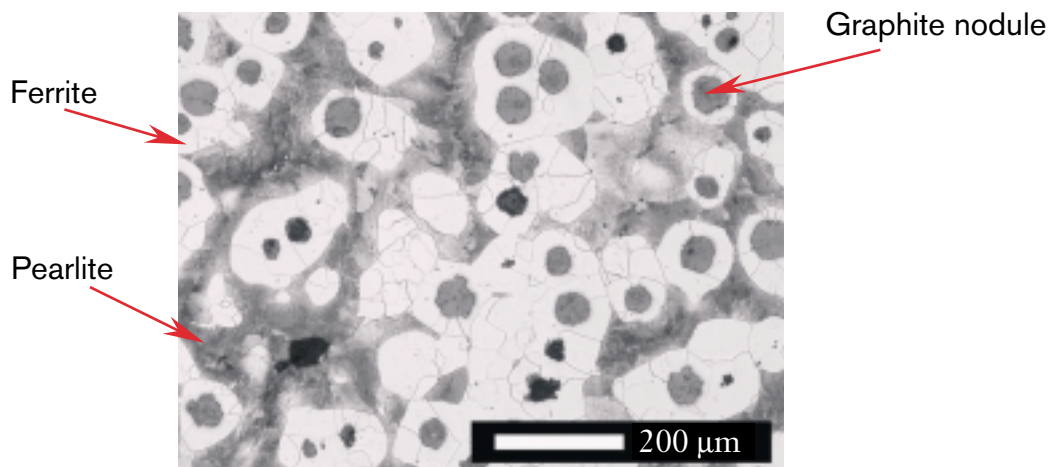
*Figure 2-6. Cast-on test bodies near bottom, middle and top of insert. The extra length of the insert also enables a disc with a height of 200 mm to be cut out of the top part of the insert.*

The properties in the cast metal are dependent on the dimensions of the piece and can vary in different parts of large components. The standard SS-EN 1563 also says that a buyer of castings and a supplier can, depending on the product, agree on where test pieces are to be cut out, what properties are to be determined and what values are to be fulfilled. For fabrication of cast inserts, SKB has developed a technical specification KTS 011, Appendix 3. The requirements on the material in accordance with this specification correspond to spheroidal graphite iron in accordance with Swedish Standard SS 140717-00, revision 4, 1981. In the newer, more up-to-date standard SS-EN 1563, the equivalent is EN-GJS-400-15U. Table 2-1 contains a comparison of the requirements on this material and an SG iron with a slightly higher strength (EN-GJS-500-7U).

As is evident from the table, the properties are dependent on the dimensions of the casting. Due to the relatively large agglomerations of metal in the inserts, SKB has so far chosen values for the dimensions 60–200 mm as reasonable target values. The strength calculations that are currently being performed for the insert will enable more exact strength requirements on cast-on test bars and/or test bars taken from the insert itself to be determined. If it proves necessary, an SG iron with a higher strength, EN-GJS-500-7U, may be an alternative. This is obtained by alloying so that a ferritic-pearlitic matrix is obtained. The matrix in EN-GJS-400-15U is solely ferritic. The soft ferrite lends this iron higher toughness. As a comparison with Figure 2-5, Figure 2-7 shows the ferritic-pearlitic structure of SG iron EN-GJS-500-7U.

**Table 2-1. Material for inserts. Cast-on test bars.**

Material designation	Relevant wall thickness (mm)	Yield strength $R_{p0.2}$ (MPa) min.	Tensile strength $R_m$ (MPa) min.	Elongation A (%) min.
EN-GJS-400-15U (Equivalent to SS 140717-00)	$T \leq 30$	250	400	15
	$30 < T \leq 60$	250	390	14
	$60 < T \leq 200$	240	370	11
EN-GJS-500-7U (Equivalent to SS 140727-02)	$60 < T \leq 200$	290	420	5



**Figure 2-7.** Ferritic-pearlitic SG iron EN-GJS-500-7U. The structure consists of graphite nodules, ferrite (white) and pearlite (grey). Cf. Figure 2-5, where the entire white matrix consists of ferrite. (Swedish Materials and Mechanical Standard, SMS).

## 3 Current fabrication technology

### 3.1 Fabrication of copper tubes

In the previous status report from August 1998, reference [4], there is a relatively thorough account of possible methods for fabrication of the different parts of the canister. As far as fabrication of copper tubes is concerned, SKB has concentrated its research on three alternatives: roll forming of copper plate to tube halves which are welded together, or fabrication of seamless (solid-drawn) tubes by extrusion or pierce and draw processing. All three of these methods have long been established in industrial fabrication of steel tubes in sizes equivalent to SKB's canister tubes. However, when SKB began development of the fabrication technology for the canisters in 1994–1995, very little experience existed of fabrication in copper using these methods. As of August 2001, a total of 26 copper tubes have been fabricated: 13 by roll forming and longitudinal welding, 10 by extrusion and 3 by pierce and draw. All of these methods produce a copper cylinder that must be machined both internally and externally as well as on the end surfaces to the desired finished dimensions. The applicable drawing requirements before and after machining are shown in Appendix 1, page 72.

In its review of RD&D-Programme 98, SKI was critical to the fabrication of copper tubes by roll forming and longitudinal welding. SKI questioned the method with regard to both the grain size obtained in the rolled copper plates and the quality of the longitudinal welds. SKI was, on the other hand, positive to the results achieved in trial fabrication employing extrusion and pierce and draw processing, and believed that SKB should continue to develop these methods.

**Roll forming and longitudinal welding** can, however, probably be developed into a functional fabrication method for copper tubes. Altogether, 13 full-size copper tubes have been fabricated in this manner. In twelve of these, the stock material consisted of 60 or 65 mm thick plates intended for 50 mm wall thickness in the finished tubes. Welding of all tubes was carried out in TWI's vacuum chamber. The number of weldings carried out has, however, been far from enough for the method to be considered fully tested. The presence of both porosities and superficial defects in the welded joint was detected by means of nondestructive testing (NDT). The welding method has been progressively improved, however, and the most recent welds were judged to be significantly better than the early ones. TWI has also made the judgement that welding in a modified welding chamber at reduced pressure instead of high vacuum will make it easier to achieve adequate weld quality. It could also be concluded that longitudinal welding of a single tube with a thinner wall thickness (40 mm, intended for 30 mm finished thickness) was simpler and gave a better result than the more thick-walled tubes. A possible future focus on a wall thickness of 30 mm in finished canisters may be favourable for the application of roll forming and longitudinal welding in tube fabrication. The alternative rigging with welding vertically down towards the workpiece that is described in section 3.3 below in conjunction with welding of bottoms on copper tubes can be employed for longitudinal welding as well and provide a further improvement. The development of friction stir welding (FSW), see Chapter 6 in this report, may also provide an alternative welding method for longitudinal welding of copper tubes.



However, experience of the two methods for seamless tube fabrication has led to the use of either extrusion or pierce and draw processing for all tubes fabricated after 1998. The starting stock in both methods is a homogeneous cylindrical copper ingot, see Figure 3-1A. Figure 3-1B shows the structure of a cross-section through such an ingot that has been etched to bring out the coarse crystalline structure.

In both extrusion and pierce and draw, the degree of deformation of the material must be sufficient and the temperature must be optimized to produce a material with a grain size that meets the stipulated requirements. Ten tubes have thus been fabricated by means of **extrusion**. All have been fabricated at Wyman Gordon Ltd in Scotland. The method was also described in the preceding report [4]. As far as SKB knows, Wyman Gordon Ltd, with plants in the USA as well as Scotland, is the only company with presses of sufficient size (30,000 tonnes press force) to extrude such large tubes.



*Figure 3-1A.*

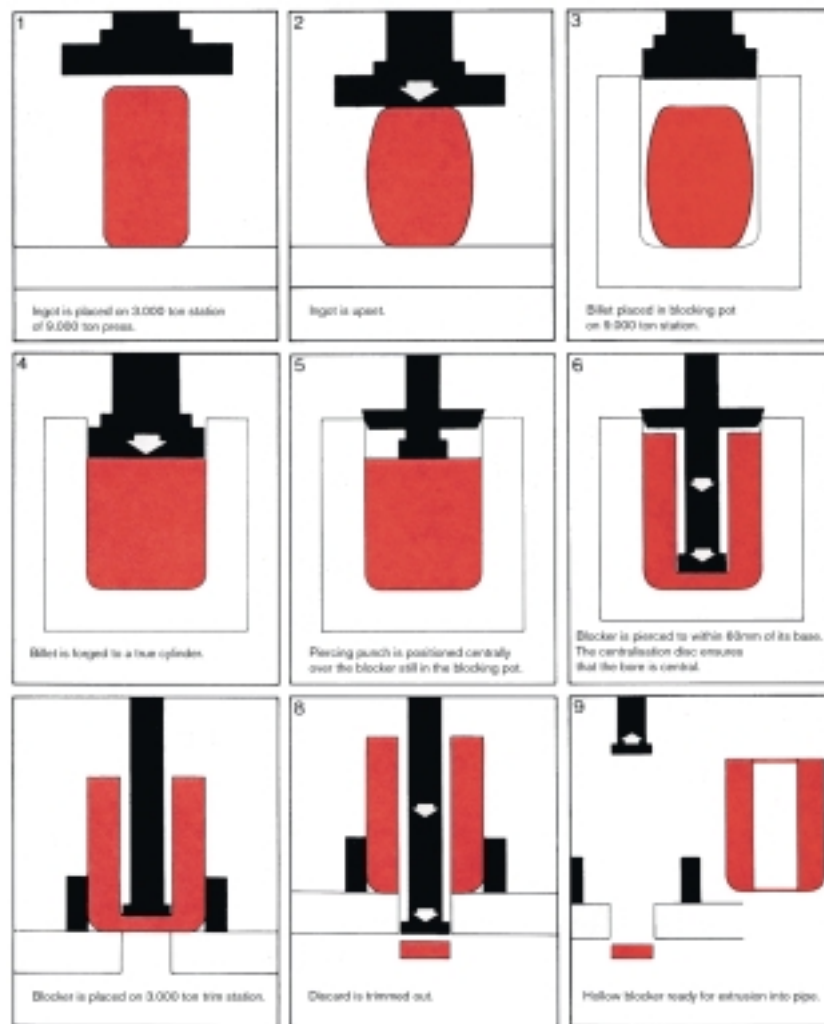


*Figure 3-1B.*

*Figure 3-1A–B.* Copper ingot for extrusion or pierce and draw processing. The ingot in photo A has a diameter of about 840 mm and a length of about 2.3 m, and weighs 12–13 tonnes. Photo B shows the coarse crystalline structure in an ingot of the same size.

The ingot is heated and placed upright in a smaller press, where it is compressed (upset) to a shorter length and a larger diameter, Figure 3-2. A hole is then made straight through the centre with a mandrel. The result is a relatively short tubular workpiece as shown in Figure 3-3. This hollow cylinder is then placed in the extrusion press and extruded in one step to its final size, as illustrated schematically in Figure 3-4. Figure 3-5 shows three extruded but not finish-machined tubes. Two of these are made for a finished wall thickness of 50 mm, and one for a finished wall thickness of 30 mm.

As a part of a research project at KTH (Stockholm Institute of Technology), references [7]–[9], extrusion of copper has been studied by means of laboratory experiments and computer simulation. The results have provided support for establishing process parameters for full-scale extrusion.



*Figure 3-2. Step 1 in extrusion. Upsetting and piercing of the copper ingot to a hollow cylinder for extrusion.*



Figure 3-3. Hollow cylinder for extrusion.

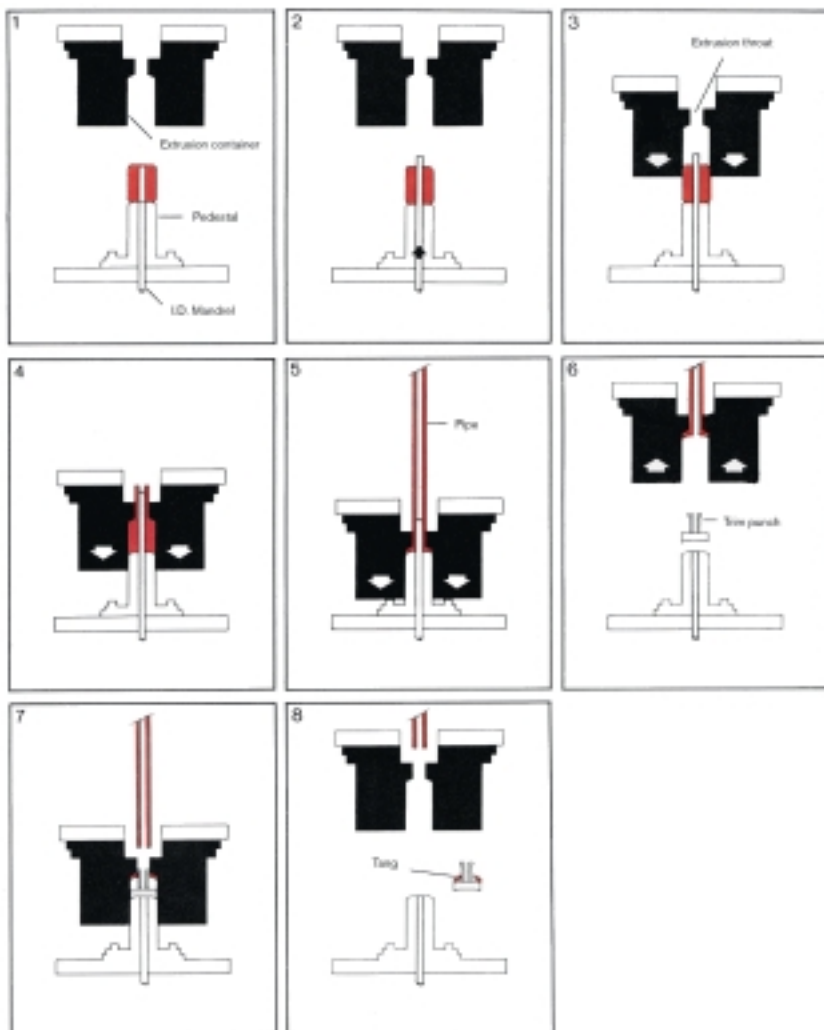
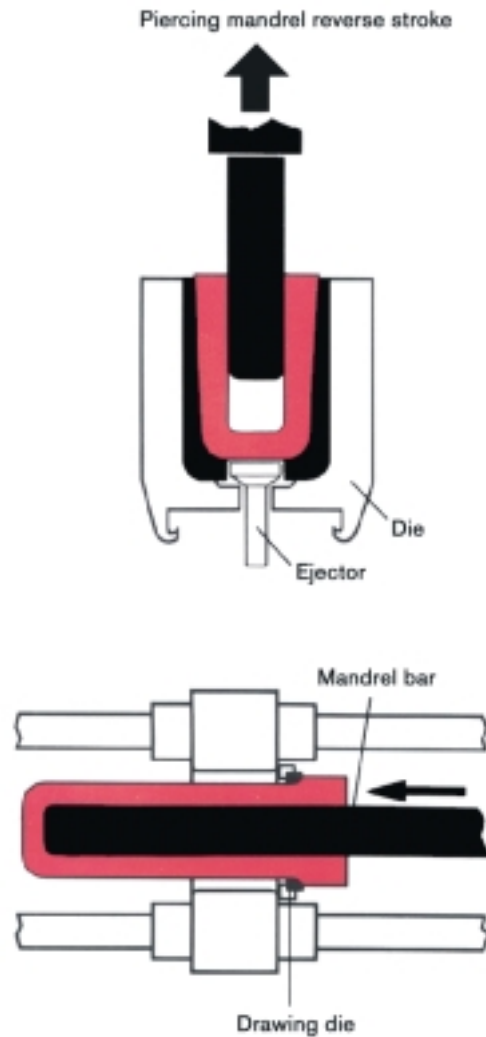


Figure 3-4. Principle of extrusion of the hollow cylinder in a 30,000-tonne press. The extruded tube is pressed vertically upward as the press die is pressed downward.



*Figure 3-5. Extruded copper tube. At the top tube T 22 made for 30 mm wall thickness and at the bottom tubes T 23 and T 29, which will be machined to 50 mm wall thickness.*

The principle for **pierce and draw processing** was also described in reference [4]. Three tubes have been fabricated by means of this method at Vallourec & Mannesmann in Germany. Vallourec & Mannesmann is the only company in Europe that uses this method. As in extrusion, the process starts with a homogeneous cylindrical copper ingot, Figure 3-1. The principle of the method is illustrated in Figure 3-6. As in extrusion, the ingot is first hot-formed by upsetting, resulting in a shorter billet with a larger diameter. It is then placed in a special tool and pierced with a mandrel as shown in the upper picture in Figure 3-6. These steps are carried out in a 4,000-tonne press. In contrast to the extrusion procedure, however, a bottom is retained in the workpiece, which provides a support for the mandrels in the subsequent forming operation, as shown in the lower picture in Figure 3-6. This forming to the finished tube is done by means of a number of draws. In the drawing operations, the inside diameter of the workpiece can be expanded and the outside diameter reduced, at the same time as the tube is elongated, by successive tool changes. The tube must be reheated between steps. The drawing and expansion operations are carried out at Vallourec & Mannesmann in a horizontal 1,500-tonne press.



*Figure 3-6. Principle of pierce and draw process.*

Figure 3-7 shows two photos from the fabrication of a copper tube for SKB. Photo A shows the preformed cylinder with retained bottom, which has been made by means of the procedure illustrated in the upper picture in Figure 3-6. Photo B shows the beginning of the first draw over a mandrel. The bottom of the cylinder provides sufficient support when the mandrel presses the hot hollow workpiece through the annular die. After the operation, the cylinder has been drawn out in length and reduced in diameter.

Fabrication trials have shown that both extrusion and pierce and draw processing can be developed into practical methods for production of SKB's copper tubes. (See also Chapter 4.) There are a few essential differences between the methods that may be worth noting.

- Extrusion is performed with a smaller number of steps, and the final step (the actual extrusion) is done in a single step. Piercing and drawing requires a greater number of steps with repeated tool changes and intervening reheatings of the workpiece.
- Extrusion requires a press with extremely great press force. As was stated above, there is as far as SKB knows only one company in the world with such presses. Piercing and drawing is normally carried out at much lower press forces and with relatively "simpler" equipment, providing increased availability of possible suppliers.



*Figure 3-7A.*



*Figure 3-7B.*

*Figure 3-7A–B. Pierce and draw fabrication of tube T 18.*

- Piercing and drawing is carried out with the bottom retained in the cylinder. SKB is currently studying the possibility of fabricating copper tubes with integral bottoms. A crucial factor is whether the material structure in the bottom is sufficiently fine-grained and whether the tubes can be internally machined to the required dimensions.

Both extrusion and pierce and draw processing are hot forming methods. The material must be heated to a temperature at which it is sufficiently formable but not so high that the structure in the final tube will be coarse-grained. A suitable temperature for copper has been found to be 675°C. One consequence of the hot forming and the subsequent relatively slow cooling is that the tubes do not have to be stress-relief annealed to get rid of residual stresses that can lead to undesirable deformations. When the tubes are made by roll forming, which is done at room temperature, and longitudinal welding, the tubes have to be stress-relief annealed.

### **3.2 Fabrication of copper lids and bottoms**

Lids and bottoms of copper are machined to the desired dimensions from blanks preformed by hot forging. Forging results in a blank shape that reduces the quantity of material that needs to be machined off. Furthermore, the hot working gives the material the desired homogeneous and fine-grained structure. This forging can be done in a conventional forging press. There are suitable forging companies in Sweden and Finland, as well as in other European countries.

The starting stock for this process is cylindrical copper ingots, see Figure 3-8A. The ingots in the picture are continuous-cast to a diameter of 350 mm and cut to a length of 1.4 m. After heating, the ingots are stood on end and pressed in several steps between flat tools to a round, low cylinder, Figure 3-8B. The final forming operation takes place in a specially designed die, Figure 3-8C.

A forged blank has such dimensions that it can be used to fabricate either a lid or a bottom. A research project at KTH aimed at modelling hot working was mentioned in the above section on extrusion. In a continuation of this work, similar calculations have been begun regarding forging of blanks for lids and bottoms. The intention is to obtain a basis for being able to optimize the dimensions of the copper ingots and the design of the forging die.



*Figure 3-8A.*



*Figure 3-8B.*



*Figure 3-8C.*

*Figure 3-8A–C. Forging of blanks for copper lids and bottoms.*

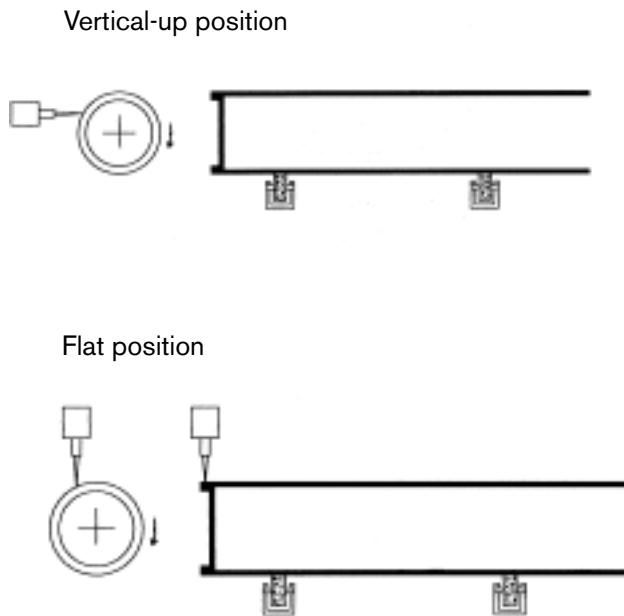
### **3.3 Welding of bottoms on copper tubes**

Welding of bottoms on copper tubes has so far been done on a full scale in 10 cases. All have been done with electron beam welding (EBW) in TWI's vacuum chamber, Figure 3-9. The tubes are placed horizontally on a rig with a drive device that rotates the tube during welding. The picture shows the location of the electron gun as well.

Machining of bottoms and tubes before EBW has been carried out in accordance with the drawings in Appendix 5. These call for a modification of welding with horizontal tubes compared with the drawings in Appendix 1, pages 72 and 73. The latter are adapted for welding of bottoms on upright copper tubes. Welding of bottoms has been carried out in two fundamentally different ways, Figure 3-10. The upper sketch shows the same welding position as in Figure 3-9. The electron beam strikes the joint horizontally. The lower sketch in Figure 3-10 shows instead a rigging where the electron



*Figure 3-9. Electron beam welding of bottom on a copper tube.*



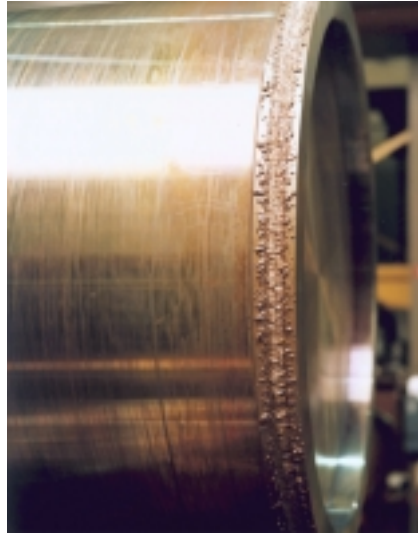
*Figure 3-10. Different positionings of the electron gun and workpiece in EBW of bottoms on copper tubes.*

beam strikes the joint vertically from above. The bottom weldings that have been carried out have produced better results with the latter technique. This rigging will be used and further refined in future weldings of bottoms.

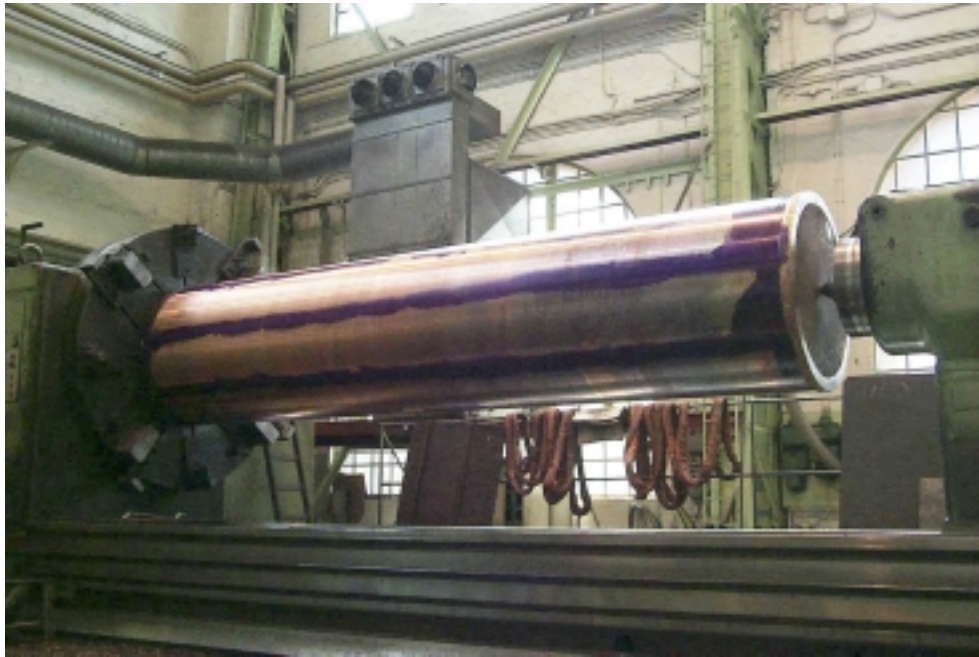
After welding of a bottom, the weld bead looks like the one in Figure 3-11. The picture shows tube T 22 with welded bottom TB 12. Tube and bottom have in this case a thickness of 30 mm. After welding, the end of the tube has to be turned to its finished dimensions. Turning of tube T 22 after welding is shown in Figure 3-12.

An alternative welding method for welding of bottoms is Friction Stir Welding (FSW). Development of this technique is described in Chapter 6.





*Figure 3-11. Welded joint in 30 mm copper tube T 22 with bottom TB 12.*



*Figure 3-12. Turning of tube T 22 after bottom welding.*

### **3.4 Fabrication of cast inserts**

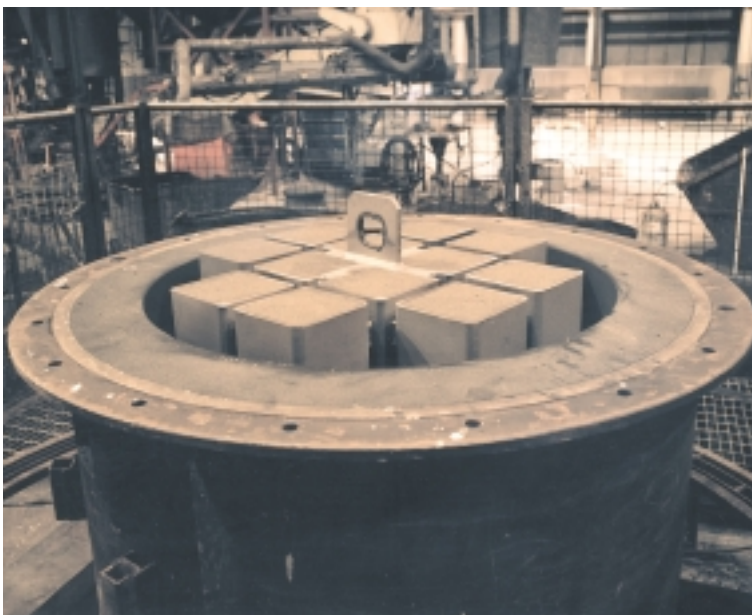
The principle of fabrication of cast inserts of SG cast iron is also described in reference [4]. The inserts are cast as shown in Figure 2-2 with 12 channels for BWR assemblies or 4 channels for PWR assemblies. For practical reasons, the channels are formed with the aid of square steel tubes that are embedded in the casting. The steel tubes are solid-drawn or welded, but in the latter case with the internal weld seam removed to guarantee smooth inside surfaces. In the BWR version, the square tubes have inside dimensions of  $160 \times 160$  mm and a wall thickness of 10 mm. The square tubes are welded together to a cassette as shown in Appendix 1, page 74. The cassette is designed in such a way that the inserts are cast with an integral bottom. The photo in Figure 3-13 shows a finished cassette. For a more detailed specification of the cassettes, see Appendices 3 and 4.



*Figure 3-13. Welded cassette with 12 channels for BWR assemblies.*

The cassette is placed in the mould as shown in Figure 3-14. Before casting the square tubes have been filled with compacted sand. This is necessary so that the walls of the steel tubes will not be deformed inward by the pressure from the molten metal during casting.

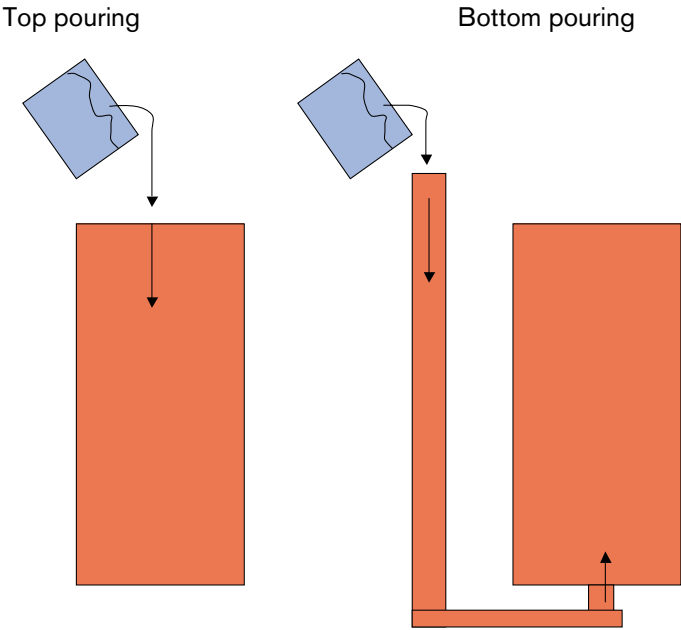
Moulds and gating systems can vary from foundry to foundry. Both sand moulds and steel chill moulds have been used. The mould can be filled with molten iron either from the top straight down into the mould (top pouring) or by means of bottom pouring, where the molten metal is poured through a runner down to the bottom of



*Figure 3-14. Welded cassette placed in the mould. The channels have been filled with sand to resist the external pressure of the molten iron.*

the mould and then rises upwards inside the mould. The two principles are illustrated schematically in Figure 3-15. Both methods have been used in the casting of inserts. No difference between the methods in the quality of the cast inserts has been observed thus far. Variants of bottom pouring have been used with the sprue (where the molten metal enters the runner) located at levels between the bottom and top of the mould. However, the powerful entry stream of molten iron caused deformation of the cassette, and in a few cases the walls in the square tubes were observed to melt. A photo taken during casting of an insert is shown in Figure 3-16.

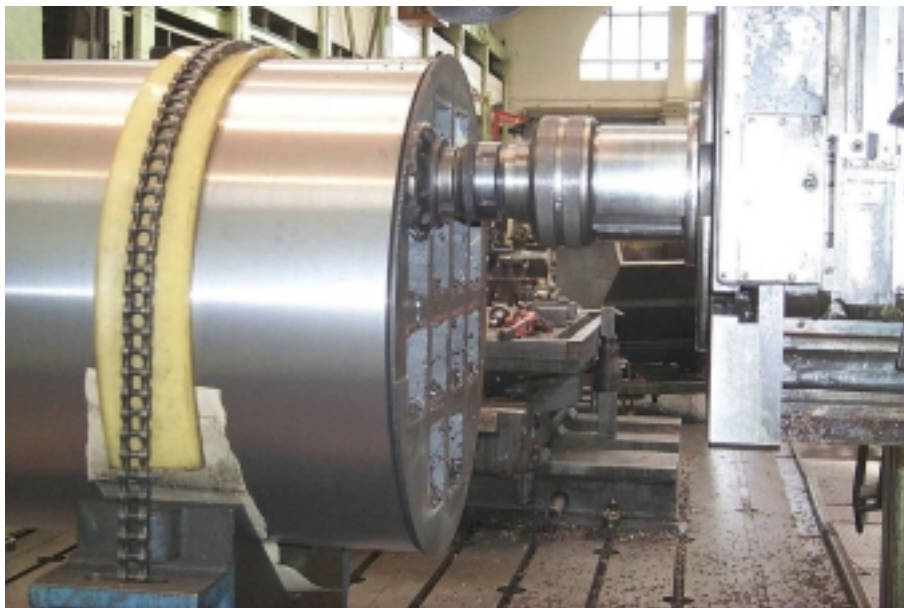
After casting, the insert is allowed to cool in the mould, which takes a few days (the casting weighs between 15 and 17 tonnes). The insert is then knocked out of the mould and cleaned to remove the remains of the gating system, and cast-on test pieces are recovered for analysis. After the top of the insert is cut off as shown in the schematic drawing in Figure 2-6, the straightness of the channels is checked using specially made gauges which every supplier foundry has. The requirement for a BWR insert is that a gauge with a cross-section of  $152 \times 152$  mm shall be able to be passed freely to the bottom of every channel. This has been stipulated in the technical specification in Appendix 3. After rough turning and ultrasonic testing, the insert is ready for delivery from the foundry. After finish machining, the insert is ready to be lowered into a copper tube with welded-on bottom. Machining of the top end of an insert is shown in Figure 3-17.



*Figure 3-15. Casting of inserts with A, top pouring or B, bottom pouring.*



*Figure 3-16. Casting of an insert.*



*Figure 3-17. Machining of cast insert.*

## 4 Results of trial fabrication

### 4.1 Overview

In the previous report R-98-09 [4], previous trial fabrication between 1994 and 1995 was commented on and the new (at that time) results for the period 1996–1998 were presented. Table 4-1 shows an overview of components fabricated and canisters assembled during the period 1999–2001, and as a comparison fabrication during the previous three-year period 1996–1998.

In comparison with the preceding three-year period, no copper tubes were fabricated during the period 1999–2001 by roll forming of copper plate and longitudinal welding. The work has been concentrated on fabrication of seamless tubes by extrusion or pierce and draw processing. Nor has any insert been cast in steel. No PWR insert has been fabricated, due to the fact that PWR inserts have been deemed to be easier to fabricate, so trial fabrication has been concentrated on developing the technology for BWR inserts. The relatively large number of lids and bottoms is largely due to the Canister Laboratory's need for lids in the work of developing the technique for sealing welding.

**Table 4-1. Overview of fabricated canister components and complete canisters during the period 1996–2001.**

Component	Fabrication method	Quantity fabricated 1996–1998 and identity number	Quantity fabricated 1999–2001 and identity number
Copper tubes	Roll forming from rolled plate	10 (T 6–T 15)	No fabrication
"	Pierce and draw processing	1 (T 16)	2 (T 17–T 18)
"	Extrusion	3 (T 19–T 21)	5 (T 22–T 24 and T 28–T 29)
Forged blanks and finish-machined lids and bottoms of copper	Forging and machining	42	49
Inserts for BWR assemblies	Steel casting	1½ (I 5–I 6)	No fabrication
"	SG cast iron	7 (I 7–I 13)	9 (I 14–I 19 and I 21–I 23)
Inserts for PWR assemblies	SG cast iron	1 (IP 1)	No fabrication
Lids for inserts	Machining from rolled steel plate	1 (IL 5)	8 (IL 6–IL 13)
Assembled complete canisters		1 (C 3)	6 (C 4–C 9)

## 4.2 Fabrication of copper tubes

As described in Chapter 3, the stock material in seamless tube fabrication by means of either extrusion or pierce and draw processing consists of cylindrical ingots. Due to their size, the ingots cannot be made by continuous strand casting and cutting to length. Fabrication can be described as semi-continuous strand casting with production of one ingot at a time. This means that the top of each ingot has to be cut off to remove the defects that always form at the top of an ingot. Since trial fabrication of tubes for a canister wall thickness of 50 mm has revealed problems in producing tubes of sufficient length, as much of the ingots as possible has been used. Figure 4-1A-B are two photos of a copper ingot that has been cut off at both ends. Photo A shows the top part of the ingot and photo B the bottom. In order to discover cracks and other open defects in the ingot, penetrant testing has been performed on all used ingots. Photo B shows the presence of cracks at the bottom of the ingot. This has occurred in several ingots and always at the bottom. The ingots have been used for both extrusion and pierce and draw processing. Since the defects have always been located at one end of the ingot, this end has been turned facing down in both methods in the preforming stage (see Figures 3-2 and 3-6) so that any remains of the defects will be located at the bottom, which is removed. Not in any case have defects been found in fabricated tubes that can be related to these centre defects. The goal in the continued work of optimizing of ingots in terms of both size and quality is to eliminate these defects.

The technical specification KTS 001, Appendix 2, describes the requirements on the copper material and also contains requirements on documentation and certain delivery conditions. The material requirements have been discussed in section 2.4. A compilation of the chemical analysis of a number of copper ingots for tube fabrication is presented in Table 4-2.

The chemical analysis of the ingots used for the tubes in Table 4-2 is representative of this ingot manufacture. As evident from the table, the consistency in chemical composition is striking. The concentrations of impurities – i.e. elements such as sulphur, iron, lead, tin etc – are very low, and the total copper concentration complies with the requirement in the standard: >99.99%. Phosphorus is the only element that has been added deliberately to improve the creep properties of the copper. The concentrations of phosphorus in Table 4-2 are in several cases slightly below the lower limit in the specified interval 40–60 ppm. The manufacture of these large ingots has systematically shown that it has been difficult to obtain a uniform phosphorus content throughout the



*Figure 4-1A.*



*Figure 4-1B.*

*Figure 4-1A–B.* Copper ingots for extrusion or pierce and draw processing. Photo A shows the cut-off end surface at the top of the ingot and photo B the cut-off end near the bottom of the ingot.

**Table 4-2. Chemical composition of delivered ingots for tube fabrication according to certificate.**

Element	Requirement in KTS 001 (ppm)	Chemical analysis of ingots used for tube Nos.:				
		T 22 (ppm)	T 23 (ppm)	T 24 (ppm)	T 28 (ppm)	T 29 (ppm)
P	40–60	47/42	39/45	38	36.2	36.8
O	<5	3	4	2	2.6	2.3
H	<0.6	0.5	0.4	0.5	0.35	0.37
S	<8	5	5	5	6.4	6.3
Ag	<25	12	11	11	12	11
As	<5	1	1	1	1.39	1.33
Fe	<10	<1	<1	<1	7.5	8.6
Sb	<4	<1	<1	<1	0.31	0.29
Te	<2	<2	<2	<2	0.52	0.53
Pb	<5	<1	<1	<1	0.79	0.73
Bi	<1	<0.4	<0.4	<0.4	0.4	0.4
Cd	<1	<0.4	<0.4	<0.4	0.0	0.0
Mn	<0.5	<0.2	<0.2	<0.2	<0.2	<0.2
Mg	<1	–	–	–	<0.2	<0.2
Ni	<10	1	1	1	0.4	1.0
Sn	<2	<1	<1	<1	0.26	0.22
Zn	<1	<1	<1	<1	<0.3	<0.3

ingot, and that the interval 40–60 ppm is tight. In a coming revision of KTS 001, the interval may be changed to 30–70 ppm to better match the actual situation. Nothing in available results from completed creep testing suggests that such a broadening of the interval would be deleterious for the properties of the material.

The results of the fabrication of tubes T 17–T 18 by pierce and draw processing and T 22–T 24 plus T 28–T 29 by extrusion have been compiled in tabular form below. Tables 4-3, 4-4 and 4-5 show obtained dimensions and 4-6 and 4-7 obtained structure, as well as the results of hardness measurement and tensile testing for certain tubes.

The tension and expansion steps were carried out at 675°C for both tubes T 17 and T 18. It is clear that pierce and draw processing can be developed into a functioning method for the fabrication of copper tubes. The tests carried out to date have been done with mandrels and other tools available at the supplier's but not adapted for SKB's tubes. The fabrication of tube T 18 was interrupted before the tube had reached full length. For dimensional optimization of the outcome, one or more mandrels with accessories will have to be designed and manufactured.

All extruded tubes reached full length. However, certain problems were encountered with regard to the straightness of the tubes and the possibilities of performing a straightening operation. A couple of the tubes in Table 4-4 could not be fully machined. Certain surfaces on both the inside and outside could not be completely finish-machined. An increased permissible out-of-straightness introduced for the extruded tube was compensated for by an increased wall thickness to permit finish-machining. This in turn led to a need for slightly larger copper ingots. The reasons for the obtained out-of-straightness will be examined and the technique for straightening improved in the continued development work.

**Table 4-3. Obtained dimensions of pierced-and-drawn tubes.**

Dimensions of tubes after pierce and draw processing					
Tube No.	Weight of ingot (kg)	Inside diameter Target value 940 mm (952 mm in finished tube)	Outside diameter Target value 1 060 mm (1 050 mm in finished tube)	Wall thickness Target value 60 mm (49 mm in finished tube)	Length Target value >4 900 mm (Finished tube 4 725 mm)
T 17	11,470	946–950	1,070–1,076	–	5,060
T 18	11,550	–	1,075–1,081	77–87	4,220

**Table 4-4. Obtained dimensions of extruded tubes intended for 50 mm wall thickness.**

Dimensions of tubes after extrusion					
Tube No.	Weight of ingot (kg)	Inside diameter Target value 937 mm (952 mm in finished tube)	Outside diameter Target value 1 063 mm (1 050 mm in finished tube)	Wall thickness Target value 63 mm (49 mm in finished tube)	Length Target value >4 900 mm (Finished tube 4 725 mm)
T 23	10,770	936–949	1,060–1,072	63–65	5,024
T 24	10,930	935–942	1,059–1,069	64–66	5,025
T 28	12,154	930–941	1,068–1,079	68–71	4,907
T 29	12,254	927–944	1,066–1,075	67–69	4,902

**Table 4-5. Obtained dimensions of extruded tubes intended for 30 mm wall thickness.**

Dimensions of tubes after extrusion					
Tube No.	Weight of ingot (kg)	Inside diameter (mm) 989 mm in finished tube	Outside diameter (mm) 1 050 mm in finished tube	Wall thickness (mm) 30 mm in finished tube	Length (mm) Finished tube 4 720 mm
T 22	9,654	975–980	1,068–1,073	46–48	5,650

**Table 4-6. Obtained structure in pierced-and-drawn tubes.**

Tube No.	Grain size (μm) Requirement <360 μm
T 17	42–85
T 18	106–238

**Table 4-7. Mechanical properties and obtained structure in extruded tubes.**

Tube No.	Yield strength R <sub>p0,2</sub> (MPa)	Tensile strength R <sub>m</sub> (MPa)	Elongation A (%) Req. >40%	Hardness (HRF)	Ave. grain size (μm) Req. <360 μm
T 22 (30 mm)	–	–	–	–	26–44
T 23	75	214	64	63–75	105–125
T 24	80	219	62	72–76	44–177
T 28	74	218	62	94–98	62 (Zone with coarser grains)
T 29	71	218	59	82–93	62



The results of material investigations performed on fabricated tubes have been compiled in Tables 4-6 and 4-7. Specimens from the two pierced-and-drawn tubes T 17 and T 18 were examined with respect to grain size and the results are presented in Table 4-6. The specimens were taken at both ends of the tubes. The coarser grain size is found in the portion of the tube bordering on the existing bottom during fabrication. Both tubes have an acceptable grain size. The coarser grain size in T 18 is explained by the fact that the tube has not been drawn to full length.

The extruded tubes also have a grain size that is well below the upper limit of 360  $\mu\text{m}$ . This agrees well with previous results from extruded tubes [4]. T 22, which was extruded to a smaller wall thickness, has the finest-grained structure. Test bars for tensile testing were also taken from the other tubes. Obtained results are shown in the Table. The only specified requirement according to KTS 001 Appendix 2 is the material's elongation before failure. As is evident from the table, this requirement is easily met by these tubes.

### 4.3 Fabrication of copper lids and bottoms

Fabrication of lids and bottoms has been described in section 3.2. The cylindrical copper ingots that comprise the starting stock for forging are made by continuous strand casting. The strand has a diameter of 350 mm and the ingots are cut into lengths of 140 cm. In the normal case, six lengths of 140 cm can be taken from each strand, i.e. six blanks for lids or bottoms will be made of material from this strand. Continuous casting ensures that the chemical composition of the copper will vary little between ingots from the same strand. To show variations in chemical composition, a number of analysis results from different manufacturing occasions have been compiled in Table 4-8.

**Table 4-8. Chemical composition of blanks for lids or bottoms according to certificate. The ingots derive from different strands.**

Element	Chemical analysis					
	Req. in KTS 001 (ppm)	TX 10 (ppm)	TX 18 (ppm)	TX 26 (ppm)	TX 32 (ppm)	TX 39 (ppm)
P	40-60	47	52	44	46	32
O	<5	2.40	2.40	1.50	1.20	1.40
H	<0.60	0.42	0.49	0.47	0.40	0.50
S	<8	6.60	6.70	6.60	6.20	7.70
Ag	<25	13	13	12	13	12
As	<5	1.64	1.53	1.71	1.19	1.55
Fe	<10	2.40	2.30	2.30	2.50	2.50
Sb	<4	0.22	0.20	0.21	0.25	0.21
Te	<2	0.76	0.64	0.71	0.33	0.67
Pb	<5	1.13	1.18	1.31	0.92	0.85
Bi	<1	0.50	0.40	0.40	0.30	0.40
Cd	<1	<0.05	<0.05	<0.05	<0.05	<0.05
Mn	<0.50	<0.20	<0.20	<0.20	<0.20	<0.20
Mg	<1	<0.20	<0.20	<0.20	<0.20	0.50
Ni	<10	0.80	0.80	0.50	0.70	0.70
Sn	<2	0.72	0.76	0.97	0.83	0.53
Zn	<1	0.30	0.30	0.40	0.90	<0.30

A comparison with the chemical composition of the larger ingots for tube fabrication in Table 4-2 shows very small differences. The delivered copper material consistently has very high purity. It is easier to control the phosphorus content in the casting of these 350 mm strands than in the semi-continuous casting of the large ingots. In Table 4-8, only the phosphorus concentration in blank TX 39 falls below the lower limit.

No indications of centre cracks or other defects have been observed in the ingots used for fabrication of lids and bottoms. Specimens have so far been taken in the periphery of each forged blank for a lid or a bottom for structural examination and tensile testing. Each blank is delivered with a certificate where the results of this testing have been compiled together with the chemical analysis and the results of nondestructive testing.

Typical values from structural determination and strength testing have been compiled in Table 4-9.

It can be concluded that the obtained grain size according to Table 4-9 is much coarser than in the fabrication of seamless tubes by extrusion or pierce and draw processing, even though the measured grain size values meet the requirement (with one exception). Compare with Tables 4-6 and 4-7. The specimens used for the grain size determination in the forged lid and bottom blanks were taken out in the periphery of the blanks. It can be assumed that the grain size is coarser in the centre of the forging. In the research work that has been started at KTH and is commented on in section 3.2, the forging of lid/bottom blanks will be investigated. The modelling that will be done will be an aid in optimizing e.g. tools, starting dimensions of ingots and forging temperature. This, together with new trial forgings, should permit an optimization of the forging in terms of obtained structure and material yield.

**Table 4-9. Mechanical properties and structure in forged blanks for lids or bottoms.**

	<b>Yield strength</b> <b>R<sub>p0,2</sub> (MPa)</b>	<b>Tensile strength</b> <b>R<sub>m</sub> (MPa)</b>	<b>Elongation</b> <b>A (%)</b> <b>Req. &gt;40%</b>	<b>Hardness</b> <b>(HRF)</b>	<b>Ave. grain size</b> <b>(µm)</b> <b>Req. &lt;360 µm</b>
<b>TX 10</b>	57	209	48	–	300–400
<b>TX 18</b>	81	210	49	42	200–300
<b>TX 26</b>	91	207	52	–	300–350
<b>TX 32</b>	65	203	52	–	250–300
<b>TX 39</b>	61	204	52	–	150

## 4.4 Fabrication of cast inserts

The results from fabrication of inserts with serial numbers up to and including I 13 were reported in the previous report [4]. During the period 1999–2001, 10 new inserts with numbers I 14–I 23 were fabricated at three different foundries in Sweden. All of these were cast in SG (nodular) iron in accordance with the technical specification KTS 011. All 10 of these inserts were of the version for BWR assemblies. Casting was done with both top and bottom pouring and with both sand moulds and cast iron chill moulds.

The material properties of SG cast iron have been discussed in section 2.4.2. To date, all inserts of SG iron have been cast in accordance with the specification KTS 011, Appendix 3. The grade of SG iron in question is SS 140717-00, or with a more recent designation EN-GJS-400-15U. Material data for the most recently fabricated inserts – both chemical analysis and strength values from certificates and the results of some own testing – have been compiled in Tables 4-10, 4-11 and 4-12.

The material standard does not stipulate any direct requirements on chemical composition, but primarily specifies what strength requirements are to be met. This has also been discussed in section 2.4.2. As is evident from Table 4-10, the analysis differences are small between the different foundries. Foundry No. 1 has a consistently moderate copper content, while the other two foundries have some nickel content. None of this is any disadvantage. Additions of alloying metals such as copper, nickel, chromium etc are used to control the properties obtained in the casting.

Strength values reported in delivery certificates have been compiled in Table 4-11. The test bars were made from cast-on test pieces or from a runner in a position near the bottom of the insert.

As Table 4-11 shows, the results have a relatively large range of variation. Some values from one specimen are quite acceptable, while another specimen from the same insert has given lower results than the specified target values. See e.g. obtained values of elongation for insert I 16. Low elongation values are generally indicative of a poorly developed nodularity of the graphite.

**Table 4-10. Chemical analysis for inserts according to certificate.**

Insert No.	Foundry No.	C (%)	Si (%)	Mn (%)	P (%)	S (%)	Cr (%)	Ni (%)	Cu (%)	Mg (%)
I 14	1	3.59	2.22	0.31	0.020	0.010	0.03	0.04	0.25	0.044
I 15	2	3.52	2.27	0.33	0.030	0.011	0.04	0.54	0.01	0.035
I 16	3	3.59	2.06	0.21	0.018	0.005	0.03	0.66	–	0.068
I 17	1	3.65	2.53	0.31	0.019	0.008	0.03	0.04	0.26	0.049
I 19	2	3.51	2.18	0.37	0.030	0.007	–	0.72	–	0.060
I 20	2	3.51	2.34	0.34	0.030	0.011	–	0.67	–	0.061
I 21	3	3.65	2.18	0.23	0.016	0.006	0.04	0.04	–	0.069
I 22	1	3.59	2.33	0.31	0.030	0.009	0.04	0.07	0.22	0.045
I 23	2	3.51	2.42	0.43	0.040	0.008	–	1.01	–	0.064

**Table 4-11. Strength values obtained according to certificate for cast-on test pieces on inserts. Specified target values on the top row in the table are taken from Swedish Standard SS-EN 1563:1997 and material EN-GJS-400-15U with a specified relevant thickness of  $60 < t \leq 200$  mm. (The material is equivalent to SS 0717-00).**

Insert No.	Foundry No.	Specimen location	Yield strength $R_{p0.2}$ (MPa) >240	Tensile strength $R_m$ (MPa) >370	Elongation A (%) >11	Comment
I 14	1	Cast-on	276	411	21	100% ferrite
I 15	2	Cast-on	277	428	8	
		Runner near bottom	285	393	10	
I 16	3	Cast-on				
		Middle	242/246	287/335	4/5	
		Bottom	265/265	403/407	18/20	
I 17	1	Average of 3 specimens	264	401	23	100% ferrite
I 19	2	Cast-on	318	545	14	60% pearlite
		Runner near bottom	214	351	12	15% pearlite
I 20	2	Cast-on	353	542	8	39% pearlite
		Runner near bottom	285	357	6	14% pearlite
I 21	3	Cast-on				
		Top	243	373	17	100% ferrite
		Middle	242	373	17	
		Bottom	243	373	16	
I 22	1	Cast-on				
		Top	255	405	19	100% ferrite
		Bottom	264	413	19	
I 23	2	Cast-on	340	457	16	12% pearlite
		Runner near bottom	330	424	6	9% pearlite

Varying results and in some cases low values of elongation of the test bars have furthermore been found in testing of the material in the 200 mm thick discs that have been cut out of the tops of a number of inserts as shown in Figure 2-6. 13–14 test bars have been taken out from different positions in each such disc for tensile testing. The results of 4 inserts have been compiled in Table 4-12.

The fabrication of inserts will be reviewed with regard to both iron composition and foundry technique as regards e.g. inoculation, addition of magnesium, casting temperature and mould filling technique. A project has been initiated in cooperation with the Association of Swedish Foundries in Jönköping. Gating system, mould filling and cooling processes will be studied by modelling, and the results obtained will be used in future trial castings. In parallel with this, discussions are being held with concerned foundries on changes in the technique used for addition of inoculant and magnesium as well as choice of alloying elements. The purpose of these inquiries is to find technical solutions for fabricating inserts of more uniform quality and, if necessary, of higher strength.

This work, along with the strength calculations now under way which were commented on in section 2.4.2, will make it possible to better specify the requirements on strength in KTS 011.

**Table 4-12. Results of tensile testing and hardness measurement of test bars taken from 200 mm disc cut out of the top of cast inserts.**

<b>Insert No.</b>	<b>Yield strength R<sub>p0.2</sub> (MPa) &gt;240</b>	<b>Tensile strength R<sub>m</sub> (MPa) &gt;370</b>	<b>Elongation A (%) &gt;11</b>	<b>Hardness (HB 10/300)</b>
<b>I 16</b> 14 test bars	227–269	252–354	1–6	134–140
<b>I 21</b> 13 test bars	248–253	279–386	3–11	131–140
<b>I 22</b> 14 test bars	269–279	321–376	3–7	137–149
<b>I 23</b> 14 test bars	334–351	347–468	0–13	159–170

## **5 Assembled complete canisters**

Seven complete canisters of the current design with cast insert have thus far been assembled for various purposes and another two are under fabrication. Six of the complete canisters were fabricated during the past three-year period. One of the canisters (C 4) is being used for development of the deposition technology and is being used in handling trials with the big deposition machine in the Äspö HRL. Another 5 complete canisters have been assembled for the different projects with deposited canisters that are under way at the Äspö HRL. Canister C 6 has been deposited in the Retrieval Project, and 4 canisters – C 3, C 5, C 7 and C 9 – have been deposited in the Prototype Repository. Another 2 canisters for the Prototype Repository, C 10 and C 11, are currently under fabrication and will be deposited in early 2002.

Lids have not been welded onto any of the canisters. All lids are screwed on. The first sealing weld of a complete canister (C 8) is planned to be carried out shortly at SKB's Canister Laboratory in Oskarshamn by means of electron beam welding.

## 6 Development of welding technology – Friction Stir Welding

### 6.1 Background

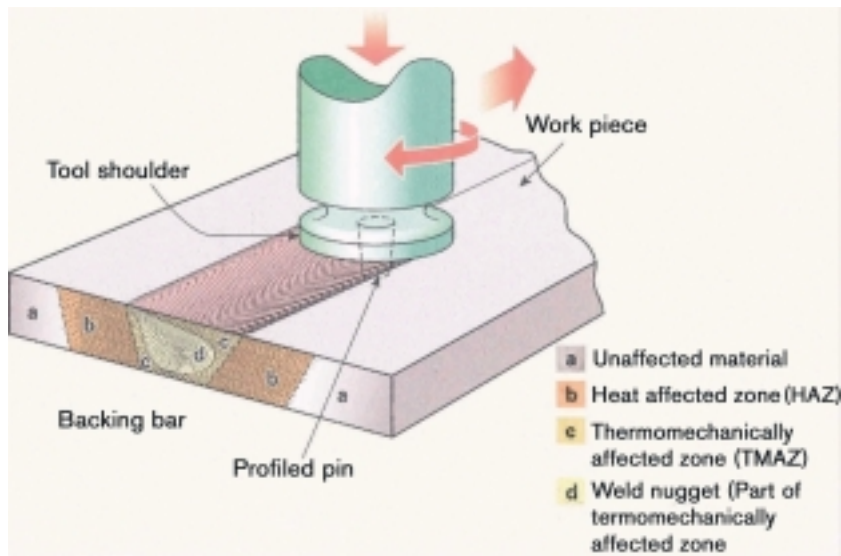
The previous status report from 1998, reference [4], described the preliminary experiments in the use of Friction Stir Welding (FSW) for joining of copper which SKB had then begun in cooperation with TWI. Since then, extensive development has been carried out and at present the method can be regarded as a very interesting alternative to electron beam welding (EBW).

The method was invented in 1991 at TWI, which also holds the earliest patent describing the method (EP 0 615 480 and US 5 460 317, both submitted and registered on 6 December 1991). During the past ten-year period, the technique has been refined by licensees in many countries and is used today on a relatively large scale as a production method, above all for joining aluminium alloys within the aerospace, shipbuilding and automotive industries.

Friction Stir Welding is a special variant of the larger concept of friction welding. The conventional technique for friction welding, which has also been used for many years on a relatively large scale within the metalworking industry, entails that two parts to be joined are rotated in opposite directions (or only one is rotated) while being pressed against each other. The frictional heat makes the metal soft. At the right temperature the rotation is stopped and the parts are pressed together. This results in a fusion of the workpieces and, with proper joint design, a very good metallic bond without the material having reached the melting point. The method is used in many contexts. One of its advantages is that different metals with different properties can be joined together. An example is certain valves for internal combustion engines, where the shaft is welded to the valve disc in this manner. Two other examples where this type of friction welding is used on highly loaded components are in the manufacture of propeller shafts and rear axles for trucks.

Friction Stir Welding involves friction welding with a rotating tool. Figure 6-1 illustrates the principle of FSW. The specially designed rotating tool is equipped with a “pin” or “probe” that is plunged down between the joint surfaces. The length of the probe is adjusted to the thickness of the joint. The tool has a larger diameter at the top and a flat bottom part (“shoulder” in Figure 6-1) which is pressed against the workpiece during the welding process. As the tool rotates, frictional heat is generated, the metal becomes soft and formable, and as the tool moves along the joint the specially designed probe brings about a mechanical stirring of the soft metal. Soft metal from both workpieces being joined is mixed, and after the tool has passed the material cools. The pieces have been welded together without melting of the metal.

As shown in Figure 6-1, certain characteristic structural zones can be defined. Zone “a” is the unaffected parent material, “b” is the heat affected zone, “c” is a zone that is subjected to a thermomechanical working, and “d” is the fine-grained core of the thermomechanically affected zone (“weld nugget”).



*Figure 6-1. Principle of Friction Stir Welding.*

## 6.2 Development of FSW of copper

### 6.2.1 Welding of copper plates

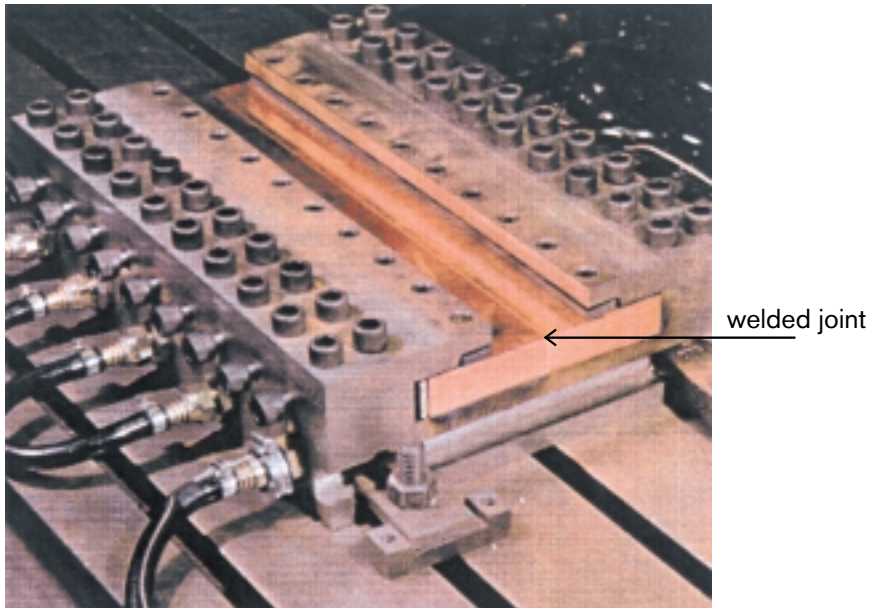
When the development work started in 1997 there was little experience applying FSW to copper. Welding of copper with a material thickness of up to 50 mm had never been done before. Aluminium alloys of such thickness had, however, been welded before. This, plus the fact that copper, with a melting point of 1,083°C, is soft and formable at much lower temperatures, led to the judgement that FSW could be a suitable method. By comparison, pure aluminium has a melting point of 659°C.

In the first tests, copper plates 510 mm long and 50 mm wide and with a thickness of 10 mm were welded. The welding tests were done in a conventional, but modified, milling machine. The plates were clamped in a fixture that was screwed to the machine's movable work table, Figure 6-2. The purpose of the first tests was to study:

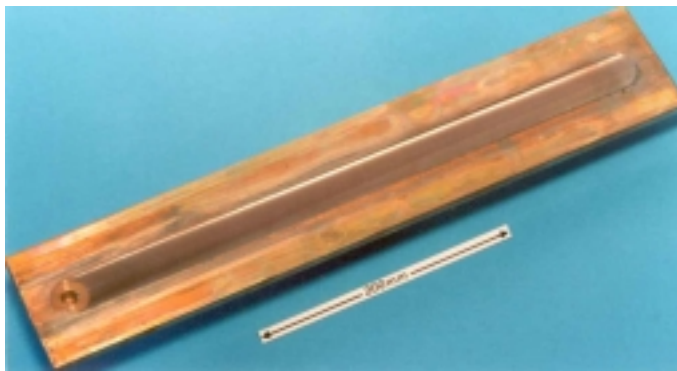
- Suitable tool materials and influence of different tool geometries.
- What power and forces are needed.
- Other welding parameters.

The next step in the development work was to demonstrate that the method could be applied to copper with a thickness of up to 50 mm. A large number of weldings were done with progressively increasing plate thickness up to 50 mm. Figure 6-4 shows examples of the structure in two welds of good quality in 50 mm thick copper.

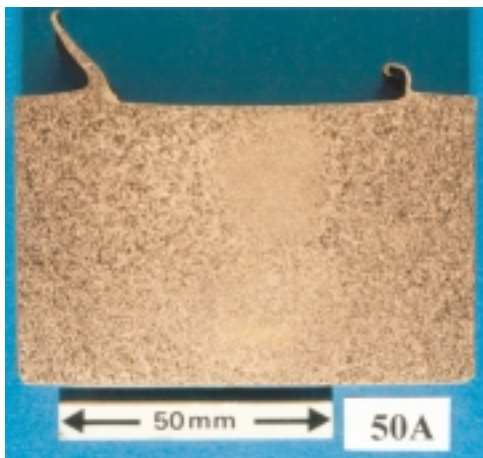




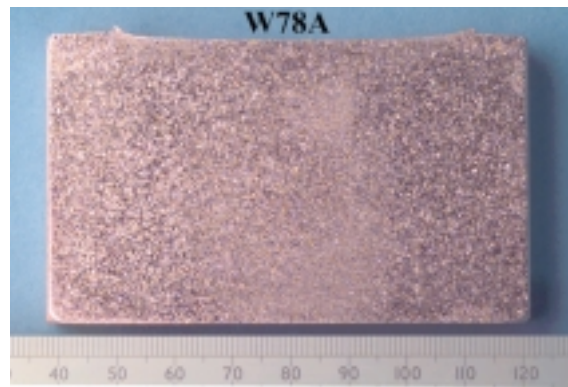
*Figure 6-2. Water-cooled fixture for joining of copper plates by FSW.*



*Figure 6-3. Weld in 10 mm thick copper plate.*



*Figure 6-4A.*



*Figure 6-4B.*

*Figure 6-4A–B. The structure in cross-sections through welds in 50 mm copper plate. The weld in photo A has a clearly defined fine-grained core (“weld nugget”) and larger curls or “flash” of squeezed-out copper than the weld in photo B. The dissimilarities can be influenced by controlling temperature and press force.*

## 6.2.2 Machine for welding of lid or bottom to copper tube

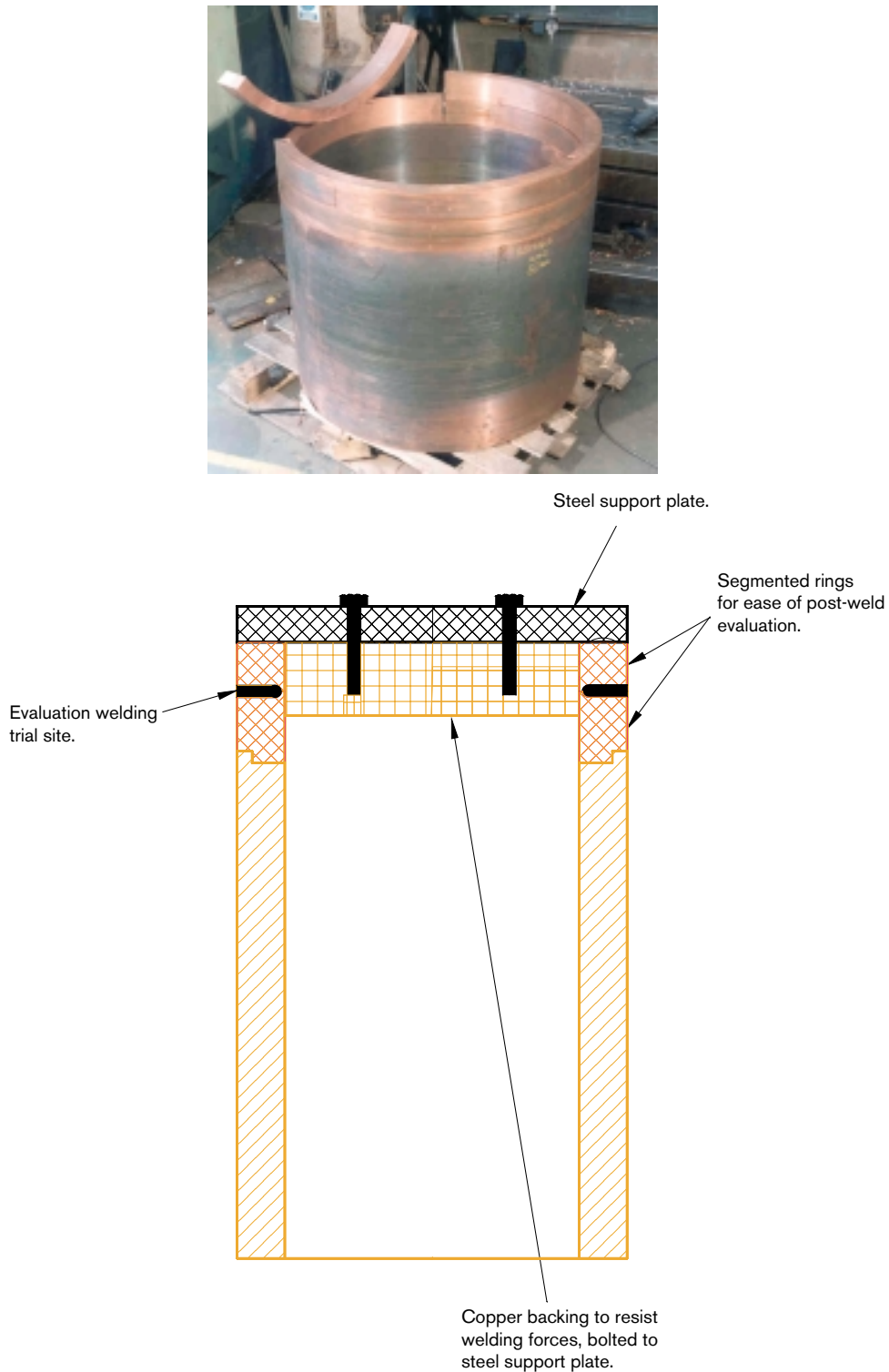
Initial trials had shown that it was possible to weld 50 mm thick copper plate by FSW with good results. SKB therefore decided to proceed and design a machine for FSW with which full-scale welding of lids or bottoms to copper tubes could be developed. Figure 6-5 shows the finished machine. In its current version, the machine is not designed for welding of full-length copper tubes, but welding can be carried out with short copper tubes (about 2 m in length) with other dimensions of the tube and lid or bottom in accordance with the current canister design.

As shown in Figure 6-5, the machine is designed for welding in the horizontal plane. The copper tube is positioned vertically in the machine and the rotating tool works horizontally from the side. The toolholder is fixed while the copper tube rotates during welding.



*Figure 6-5. Machine for FSW of lids or bottoms on copper tubes.*

With the new machine, a thorough try-out of welding parameters, tool materials and tool design was necessary. In order to limit material consumption in the initial phase, the weldings were performed on cut-out rings as shown in Figure 6-6. The figure shows how 120° segments with a length of about 1 m are mounted on a copper tube for welding. After welding the arrangement is disassembled for evaluation of the weld in the segments. Two new segments can then be mounted in the same way for the next welding test, and so on.



*Figure 6-6. Arrangement for welding of 120° segments.*

Welding is started by setting the tool in rotation and inserting the probe in a predrilled hole in the joint line, see Figure 6-7A. A thermocouple has been mounted near this start area. When the probe has entered the hole and the shoulder of the tool is pressed against the copper surface, the friction causes a temperature increase, which is registered by the thermocouple. At a given temperature the canister starts rotating and the tool advances along the joint. Due to the frictional heat, the tool will constantly be surrounded by a volume of copper of such high temperature that the material is plastic and can (without having reached the melting point) flow around the probe. Figure 6-7B shows the tool during welding. The shoulder of the tool moves forward in a surface zone and causes some curling-up of superficial copper.

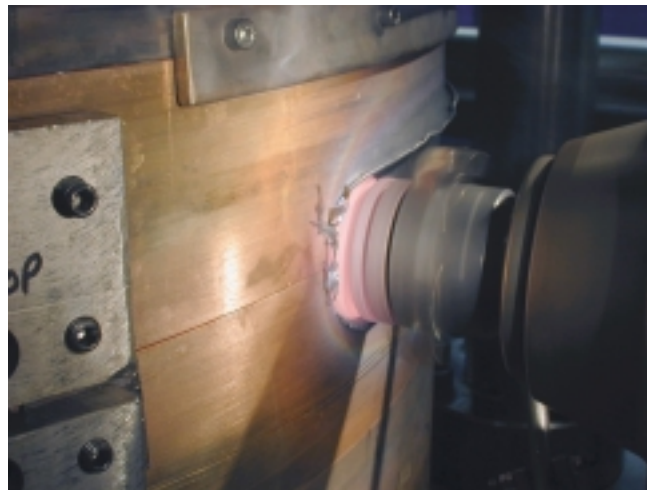
In conjunction with welding tests it has been possible to test and evaluate a number of variables that are of importance for the welding results. Such parameters are:

- Tool design. The configuration of the probe and the tool's wear surface.
- Tool material. Need for heat treatment and/or surface treatment.
- Rotational speed of tool.
- Press force of the tool.
- Temperature of tool and temperature in the plastic zone during welding.
- Angle of tool with surface of workpiece.
- Rotational speed of canister (travel rate).
- Forces acting on the tool (torque and bending moment).

A large number of tool designs and tool materials have been tested. Figure 6-8 shows examples of different tools. Tool materials that have been tested include different kinds of cemented carbide, high-temperature alloys and so-called superalloys.

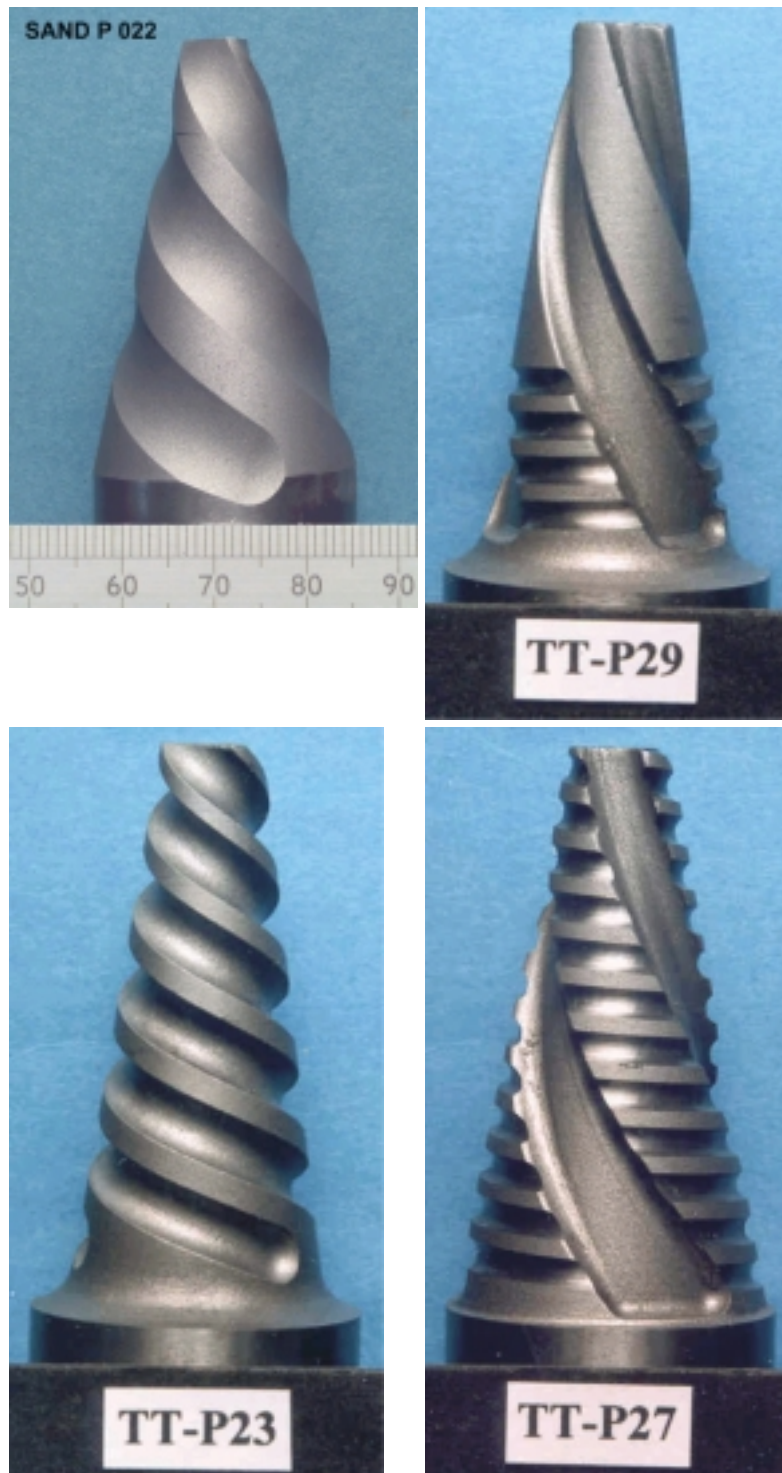


*Figure 6-7A.*



*Figure 6-7B.*

*Figure 6-7A-B. Welding of 120° segment.*



*Figure 6-8. Examples of different tool designs.*

The machine is equipped with a number of different sensors for registration of the parameters mentioned above. These parameters are recorded by a plotter. A schematic example is shown in Figure 6-9. This documentation of every weld is an important complement to subsequent evaluation of welding results by nondestructive testing, e.g. ultrasonic and radiographic inspection, as well as by metallographic studies with a microscope.

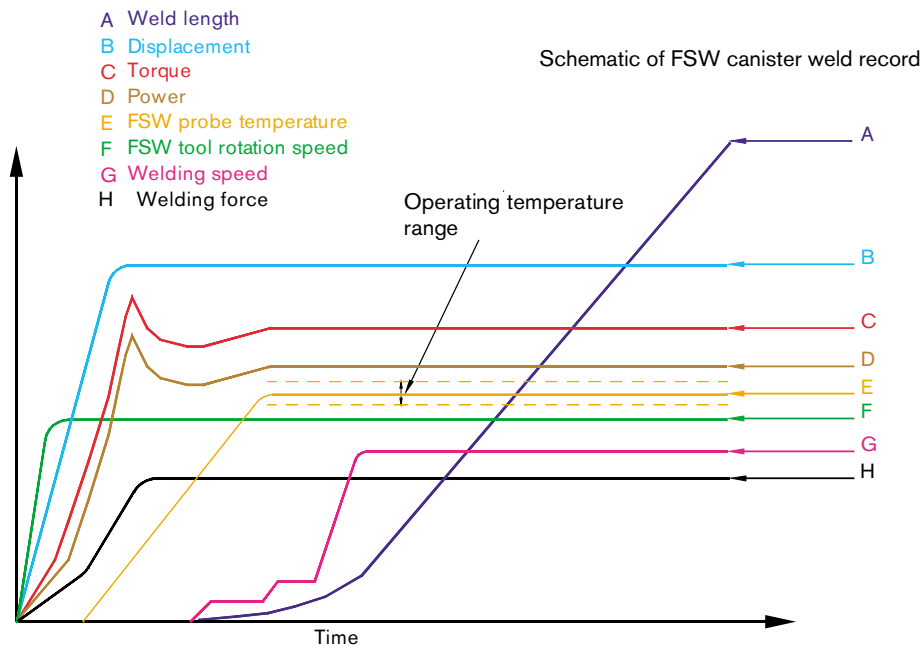


Figure 6-9. Recording of welding parameters.

### 6.2.3 Results of completed weldings

The systematic work of testing tools and welding parameters in full-scale tests in the facility at TWI has gradually led to improved quality of the welds. At the present time there is a tool concept and tried-and-tested values of welding parameters that give a good result, even though the technique is not yet fully developed. A relatively large number of weldings of 120° segments have been carried out. As time has progressed, tools that have not worked satisfactorily due to material properties and/or tool design have been eliminated. It has happened that tools have broken during welding or been deformed by the high working temperature, or that softened copper has gummed up the tool's pattern. In some cases, defects have been observed in the finished weld. An example of this is shown in Figure 6-10, where a small void or discontinuity is indicated by an arrow. It is observed to be near the borderline between the fine-grained "nugget" (see Figure 5-1) and the adjacent thermomechanically affected zone. This location has proved in many cases to be typical of where discontinuities tend to form.

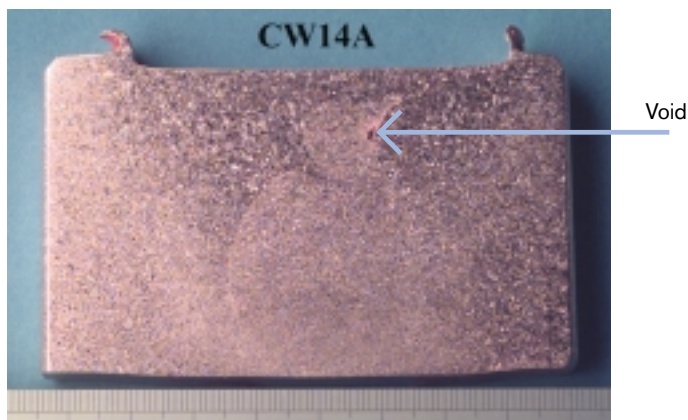
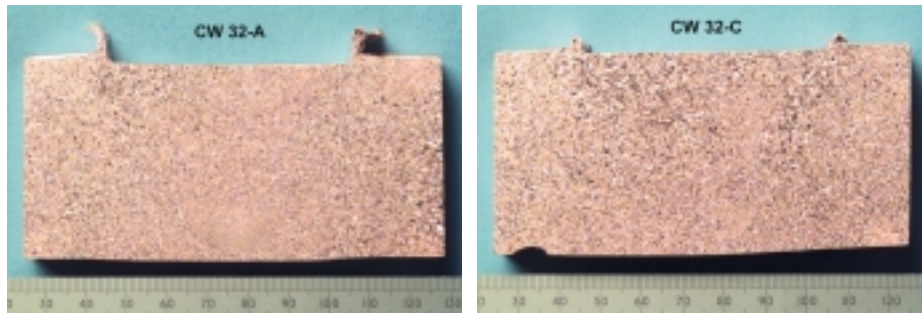
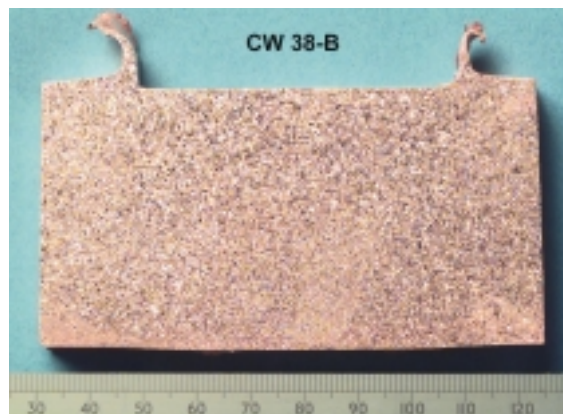
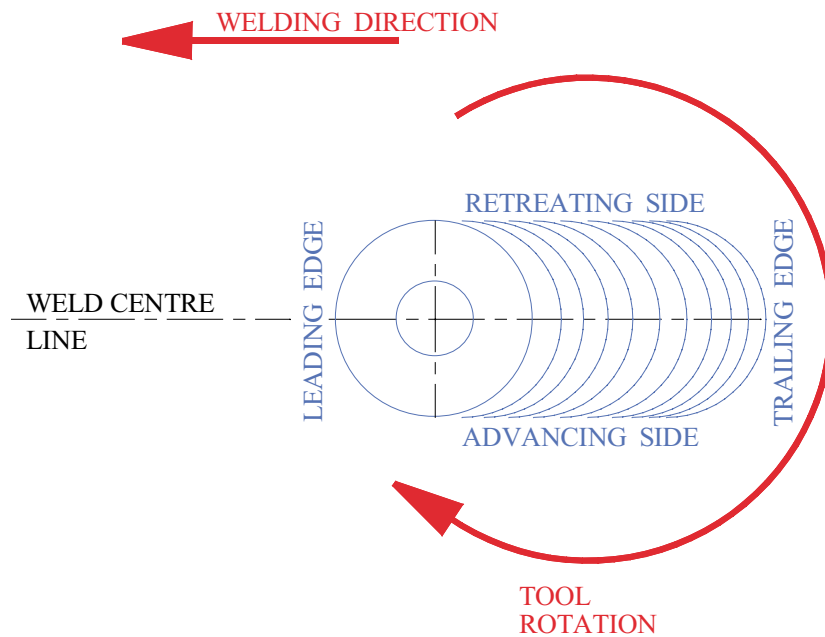


Figure 6-10. Defect in weld metal near the borderline between the fine-grained "nugget" and the adjacent thermomechanically affected zone.

It has been found that such a clear, fine-grained nugget as that shown in Figure 6-10 does not necessarily form during welding. Figure 6-11 shows an example of a weld with a much less pronounced nugget, and Figure 6-12 shows a weld with a very uniform structure from the parent metal through the whole weld. The difference has been found to be temperature-dependent, with the clear, fine-grained nugget appearing at lower temperatures.



**Figure 6-11.** Two sections through weld CW 32. Position A represents the starting zone and position C the end of the weld.



**Figure 6-12.** Section through weld CW 38.

The next step in the development work was to perform welds around the entire circumference instead of on 120° segments. However, the weldings have still been done on rings cut from copper tubes instead of on actual lids or bottoms of copper. Such a weld is shown in Figure 6-13.

Thorough material investigations of completed welds are an important part of the development work. Nondestructive testing can be performed by means of ultrasonic and radiographic inspection. SKB's equipment at the Canister Laboratory in Oskarshamn is being used to study welds and develop methods for nondestructive testing. Special material investigations are under way at the Swedish Institute for Metals Research (SIMR) in Stockholm. Strength is tested by means of tensile testing and creep testing on specimens taken out at different places around the entire circumference of the weld. Specimens will also be examined metallographically by microscopy and, where necessary, by microprobe analysis. Figure 6-14 shows a weld sent to SIMR for such investigations. The weld has been cut up so that different positions around the circumference can be examined.

Together with TWI, SKB has presented the development of FSW on copper canisters at different international conferences, references [10]–[12]. The unique application of FSW has also led to a first patent application which SKB holds together with TWI, [13].



*Figure 6-13. Weld around entire circumference.*





*Figure 6-14. Weld CW 77 sent to IM for investigation.*

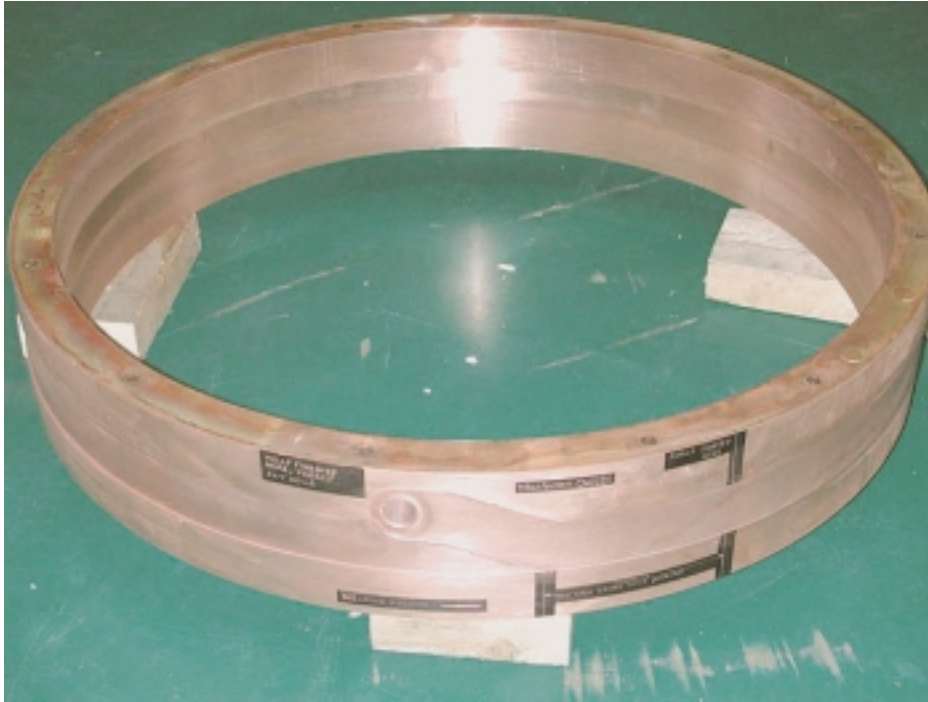
#### **6.2.4 Further development of method. Parking of exit hole**

The method will now be further developed. Basic development will continue at TWI, aimed at optimization of tools and process parameters. It is also important to develop technology for control and monitoring of certain process parameters. Welding will be performed in both 50 and 30 mm thick tubes. In the continued development work at TWI, welding will be carried out on real lids or bottoms instead of on rings.

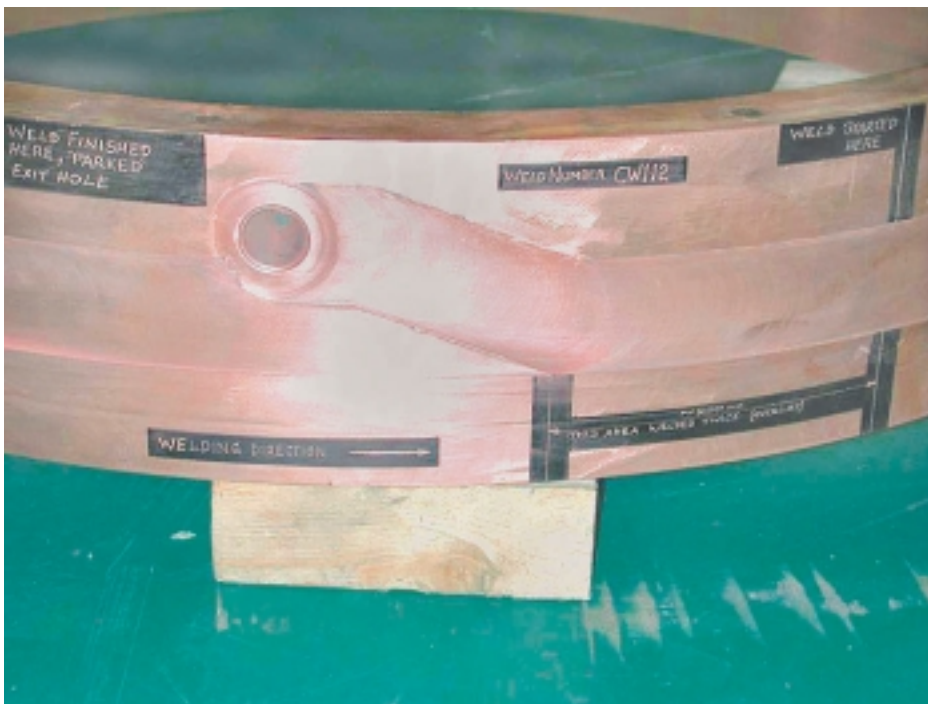
In cooperation with KTH, a doctoral project has been begun involving modelling of the FSW process. The intention is to gain a better understanding of the flow of material around the tool, where possible strains in the material could lead to the formation of defects, and to devise a model for structural changes in the different zones in the weld and how the structure can be influenced.

The technology for nondestructive testing will be developed at the Canister Laboratory and in cooperation with Uppsala University.

Different methods will be tested for solving the problem of the exit hole that is formed by the rotating probe on the tool after a completed revolution. One method is to allow the tool to move out of the welded joint after one complete revolution plus some overlap and park the exit hole at a place where it will do no harm. Preliminary experiments have been performed at TWI and Figure 6-15 shows the result.



*Figure 6-15A.*



*Figure 6-15B.*

*Figure 6-15A–B. Parking of exit hole after completed revolution.*

## 7 Quality assurance

The quality system for canister fabrication is a part of SKB's quality system, which is certified according to ISO 9001 and 14001. The controlling documents for canister fabrication are compiled in Quality Manual – Canister Fabrication, and in a special binder with “Drawings, specifications and procedures”. The quality system for canister fabrication covers the entire chain from material suppliers up to and including delivery of finished canisters.

The manual refers to special procedure descriptions and other controlling documents. The current contents of the Quality Manual are shown in Appendix 6, page 102 (in Swedish only).

The separate binder “Drawings, specifications and procedures” contains current design drawings and technical specifications. Two of these, KTS 001 “Material for Copper Canisters” and KTS 011 “Nodular Cast Iron SS 0717 Insert”, have been discussed in Chapter 2 above and are appended to this report as Appendices 2 and 3. This binder also contains the current procedure descriptions. A list of these is found on page 103 of Appendix 6. Procedure descriptions and technical specifications are written in English so that they can also be used by non-Swedish-speaking suppliers.

An important area for continued work is to establish acceptance criteria for all parts of the canister including welds. Such criteria are material requirements and acceptance limits for both superficial defects and defects inside the material. A consequence analysis will be carried out showing what happens if there are more or larger defects than the acceptance criteria indicate.

Established acceptance criteria regarding defects must be able to be verified by nondestructive testing. The ongoing work of selecting suitable equipment and methodology will continue in cooperation with suppliers and experts at colleges and universities.

Relevant fabrication processes and inspection and testing procedures will be qualified. This work will be systematized and carried out over the next few years.

One step in the ongoing work of development of the quality system for canister fabrication is to find the necessary network of suitable sub-suppliers and to establish long-term and businesslike relations with them. In conjunction with ongoing trial fabrication, continuous assessment of potential suppliers will take place through regular quality audits and analysis of pricing, delivery reliability and probable future development.

## 8 Future serial production – Canister factory

SKB is planning to manufacture canisters in a special canister factory. Complete but empty canisters will be transported from the canister factory to the encapsulation plant. The previous report from 1998, reference [4], described a preliminary study of the design of such a plant. Additional analyses have been conducted since then, references [14] and [15]. In the first report [14], copper tubes are fabricated in the factory by roll forming of rolled copper plates to tube halves, which are then joined together by longitudinal electron beam welding. In report [15], the copper tubes are made from seamless not machined tubes that are delivered to the factory from external suppliers. In both cases, cast and rough-machined inserts are delivered to the factory for finish-machining. Appendix 7 from reference [15] shows the planned layout of the factory. The layout is planned so that stock in the form of seamless unmachined tubes, forged copper blanks for lids and bottoms, cast and rough-machined inserts and blanks for steel insert lids are delivered to the factory from external suppliers. The factory is planned with two separate machining lines – one for copper machining and one for machining of steel and cast iron.

Copper tubes, lids and bottoms are turned in the machining line for copper. After check measurement, the bottom is welded onto the copper tube by electron beam welding and the weld is inspected by nondestructive ultrasonic and radiographic examination. After approved inspection, the weld zone is turned to final dimensions and the copper tube undergoes cleaning by high-pressure washing and drying.

In the other machining line, inserts and steel lids are turned to specified dimensions, which are checked in a special measurement station. After turning of the inserts, all channels for fuel assemblies are blast-cleaned. Machining of inserts and steel lids is performed dry, which means that these parts do not have to be washed.

The final step in canister fabrication consists of insertion of the insert in the copper tube. After assembly, the finished canister is placed in a special-purpose transport cradle. The canister is thereby ready to be delivered together with insert lid and copper lid to the encapsulation plant.



*Figure 8-1. Exterior of SKB's canister factory.*

The study of the factory has also included a preliminary assessment of suitable production machines. The factory must be able to produce 210 canisters per year. Discussions have been held with machine manufacturers, who have also provided concrete proposals for suitable machines and other equipment for every step of canister fabrication. As Appendix 7 shows, premises have also been planned for a maintenance workshop, an inspection laboratory and a storeroom for finished canisters.

It has been calculated that the factory building described in reference [15] requires a floor space of about 5,800 m<sup>2</sup> and will cost approximately SEK 78 million to build. The total investment cost for machines and other equipment has been estimated at SEK 99 million and the personnel requirement at 21 persons.

SKI has carried out an analysis and assessment of SKB's study and planning of the canister factory, reference [16]. The conclusion is that SKB's proposed fabrication methods, choice of equipment and organization should make it possible to create a functioning production of canisters. But further studies are recommended in some cases.

## 9 Continued work

The work of full-scale trial fabrication of all canister parts will continue over the next few years. SKI has stated that prior to the time of permit application, SKB must have demonstrated that methods for fabrication and inspection are actually available and are suitable for serial production. This means that a sufficiently large number of canisters must have been fabricated and inspected and shown to satisfy established requirements.

The results of the work reported in this report show that fabrication methods are available for all canister parts. The results to date also show that these methods can, with a high degree of probability, be developed and gain acceptance for use in serial production. In most sections of the report, concrete questions have been dealt with within various areas, where additional development work is required in the form of both research and development projects at institutes and universities. The following checklist has been compiled to provide an outline of important continued work during the next few years

### **Fabrication of copper tubes with lid and bottom**

- Continued fabrication of seamless copper tubes for 50 mm wall thickness, and to some extent for 30 mm wall thickness, will be carried out primarily by means of the two methods extrusion and pierce and draw processing. The work will be aimed at demonstrating that full-scale copper tubes can be fabricated by these methods and satisfy established requirements. Important interim goals are optimizing material yield, process parameters and inspection methods.
- Alternative fabrication methods for copper tubes will be tested to a certain extent. One technique is forging of tubes. Development of alternative methods will depend on the results obtained in each case.
- Fabrication of copper tubes with 30 mm wall thickness by roll forming of rolled plate and longitudinal welding by EBW or FSW may be an alternative if fabrication of seamless tubes results in unexpected problems.
- Fabrication of forged blanks for lids and bottoms will continue. Important interim goals are optimizing the grain size obtained in the forged blanks and improving material yield and inspection methods. To achieve these goals, different designs of forging tools and different sizes of the ingots to be forged will be tried together with different process parameters.
- In parallel with development and trial fabrication at different suppliers, research projects will be conducted at institutes, colleges and universities. Concrete ongoing projects include computer simulations and tests on a laboratory scale of relevant fabrication methods, as well as material testing. The results of these projects will provide knowledge that can contribute to the desired optimization of material specifications and fabrication techniques.

- Development of the technique for welding of bottoms on copper tubes will continue. Welding will be carried out by means of both EBW and FSW at TWI and SKB's Canister Laboratory. Full-scale welding using both methods will be able to be performed at the Canister Laboratory during the next few years. Methods for nondestructive testing of bottom welds will be tried out in parallel with the development of testing methods for sealing welding.

#### **Fabrication of cast inserts with steel lids**

- Continued fabrication of cast inserts of SG (nodular) iron will be carried out in cooperation with various foundries. The work will be concentrated on optimizing the fabrication process, material specifications and testing methods.
- In parallel with development and trial fabrication at selected foundries, development work will be pursued in cooperation with the Association of Swedish Foundries. This will include simulation of casting processes and materials testing. The purpose is to gain knowledge that can contribute to optimization of material specifications and fabrication techniques.
- Steel lids for inserts will be fabricated to meet the need for fabrication of complete canisters. The objective of the continued work is to further refine the design with associated material specifications and criteria for quality assurance.

#### **Continued development of FSW**

- The fundamental development work at TWI with the existing equipment will continue during 2002. The work is aimed at further refinement of tools and process parameters. It is also important to develop technology for monitoring and control of certain process parameters. Welding will be carried out in both 50 and 30 mm thick tubes. In the continued work, welding will be done on real lids and bottoms. Finished welds are continuously evaluated by metallography and nondestructive testing.
- Thorough material investigations of welds are under way and will continue at the Institute for Metals Research in Stockholm. Strength will be tested by means of tensile testing and creep testing on specimens taken out at different places around the entire circumference of the weld. The welds will also be examined metallographically by microscopy and, where necessary, by microprobe analysis.
- In cooperation with KTH, a research project has begun involving modelling of the FSW process. The intention is to gain an understanding of the flow of material around the tool and where possible strains in the material could lead to defects, as well as to construct a model for how the structure evolves in different zones in the weld and how the resultant structure can be influenced.
- Different methods will be tested for solving the problem of the exit hole that is formed by the rotating probe on the tool after a completed revolution.
- The technology for nondestructive testing will be developed at the Canister Laboratory and in cooperation with Uppsala University.

## **Quality assurance**

- The work of canister fabrication is being conducted in accordance with the requirements in ISO 9001 and 14001. The quality activities are described in detail in the quality manual for canister fabrication with associated fabrication drawings, technical specifications and procedure descriptions. The quality system is being continuously developed, and associated documents are revised as needed.
- An important area is to establish acceptance criteria for all parts of the canister including welds. Such criteria are material requirements and acceptance limits for both superficial defects and defects inside the material. A consequence analysis will be carried out showing what happens if there are more or larger defects than the acceptance criteria indicate.
- Established acceptance criteria relating to defects must be able to be verified by nondestructive testing. The ongoing work of selecting suitable equipment and methodology will continue in cooperation with suppliers and experts at colleges and universities.
- Relevant fabrication processes and inspection and testing procedures will be qualified. This work will be systematized and carried out over the next few years.

## **Canister factory**

- Experience gained from the trial fabrication of all canister parts will be drawn on in the further development of the factory. The work of investigating and establishing acceptance criteria and testing methods will enable modified equipment for nondestructive testing and other quality inspection to be specified more precisely. A deeper investigation of modified production machinery and testing equipment will be carried out in cooperation with potential suppliers. This will permit a more exact analysis of the factory's layout and investment costs.
- If the development of FSW shows that the technique can be used for canister fabrication, the consequences of this will be studied and weighed into factory layout and investment costs.
- A study will be made of the environmental impact of canister fabrication.
- One step in the ongoing work of development of the quality system for canister fabrication is to find the necessary network of suitable sub-suppliers and to establish long-term and businesslike relations with them. In conjunction with ongoing trial fabrication, continuous assessment of potential suppliers will take place through regular quality audits and analysis of pricing, delivery reliability and probable future development.
- In order to get a complete picture of potential uncertainties, a risk analysis will be conducted of operations in the planned canister factory.



## 10 References

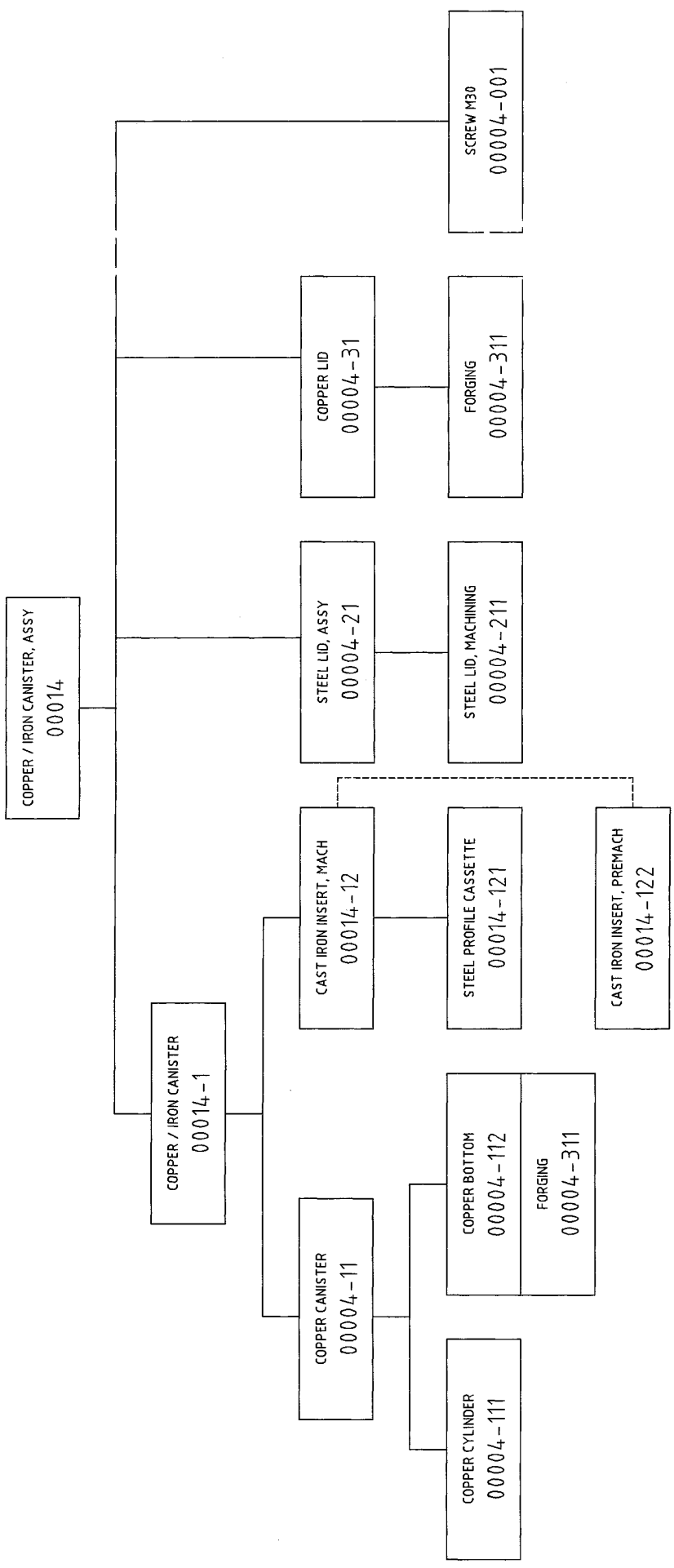
1. **SKB RD&D-Programme 98.** Treatment and final disposal of nuclear waste. Programme for research, development and demonstration of encapsulation and geological disposal. SKB Stockholm, September 1998.
2. **The Swedish Nuclear Power Inspectorate's Evaluation of SKB's RD&D Programme 98.** SKI Report 99:31.
3. **Bowyer W H.** Comments on "SKB RD&D-Programme 98". Focused on Canister Integrity and Corrosion. SKI Report 99:20.
4. **Andersson C-G.** Test manufacturing of copper canisters with cast inserts. Assessment report August 1998. SKB Technical Report TR-98-09.
5. **Werme L.** Design premises for canister for spent nuclear fuel. SKB Technical Report TR-98-08.
6. **Bowyer W H.** A Study of Defects Which Might Arise in The Copper Steel Canister. SKI Report 00:19.
7. **Ssemakula H.** Manufacturing of heavy rings and large copper canisters by plastic deformation. Licentiate Thesis. KTH Stockholm, May 2001.
8. **Ssemakula H, Ståhlberg U.** Grain size as influenced by process parameters in copper extrusion. Scandinavian Journal of Metallurgy 49 (2000) ISSN-0459.
9. **Ssemakula H.** Manufacturing of large copper canisters by extrusion. Submitted to the Scandinavian Journal of Metallurgy for publication.
10. **Andersson C-G, Andrews R E.** Fabrication of Containment Canisters for Nuclear Waste by Friction Stir Welding. In: Proc. of the 1<sup>st</sup> Int. Symposium on Friction Stir Welding, 14–16 June 1999. Rockwell Science Center, Thousand Oaks, California, USA.
11. **Andersson C-G, Andrews R E, Dance B G I, Russell M J, Olden E J, Sanderson R M.** A Comparison of Copper Canister Fabrication by the Electron Beam and Friction Stir Processes. In: Proc. of the 2<sup>nd</sup> Int. Symposium on Friction Stir Welding, 26–28 June 2000, Gothenburg Sweden.
12. **Andersson C-G, Andrews R E.** The Development of Advanced Welding Techniques for Sealing Nuclear Waste Canisters. In: Proc. of the 2001, MRS Spring Meeting, April 16–20, San Francisco, USA.
13. **Patent application EP 1073538.** Corrosion Resistant Enclosure and Methods for its Manufacture.
14. **Burström M.** Kostnadsanalys av processen, att genom rullformning och elektronstrålesvetsning tillverka kapslar för djupförvaring av använt kärnbränsle med koppartjockleken 50 mm alt. 30 mm. SKB Projekt PM TI-99-01 A. Februari 2000.

15. **Burström M.** Kostnadsanalys av processen att från sömlösa kopparrör tillverka kapslar för djupförvaring av använt kärnbränsle med koppertjockleken 50 mm alt. 30 mm. SKB Projekt PM TI-00-03. February 2000.
16. **Lundin M, Gustafsson O, von Brömsen B, Troell E.** Granskning av SKB:s förslag till inkapslingsteknik. SKI Rapport 01:9.

## **Appendix 1**

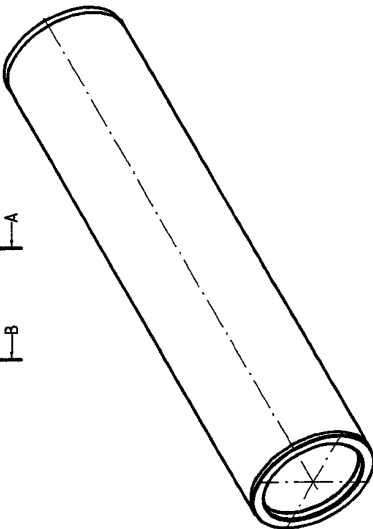
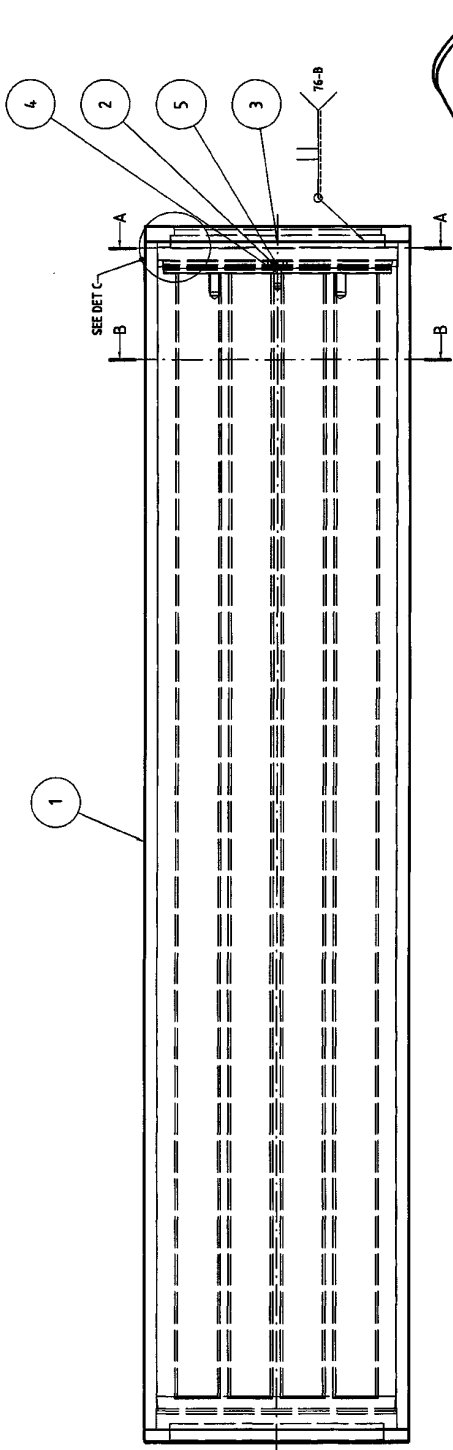
**Drawings. Canister with insert of spheroidal graphite cast iron for  
12 BWR assemblies**

Rev	Date	Revision	Partition	Drawn	Check	Approv.



Designed by Richard Isenhardt, AB in cooperation with SKB KAS file No. SKB-2004L-999	Drawn / Date KZP 2000-06-20	Checked / Date [Signature] 2000-06-20	Approved / Date [Signature] 2000-06-20	Projection [Symbol]	General Tolerances see SKB 2004L-999 and/or SKS 733-B
Scale: 1:1 A2 Form: A2				BWR SERIAL 2 <b>DRAWING LIST</b> COPPER / IRON CANISTER	
<b>SKB</b> SKANSK KÄRNREANSLAGS- HANTERING AB				Drawing No. <b>00014-999</b>	Page <b>1 / (1)</b>
					Rev. <b>A</b>

Rev	Date	Revision	Drawn	Checked	Appr.
B	2004-08-14	Pos 1/2 and det C changed	KJP	W	CGA



1

SEE DET C

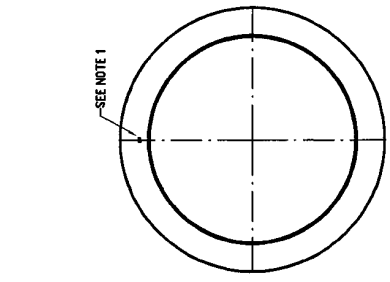
A

B

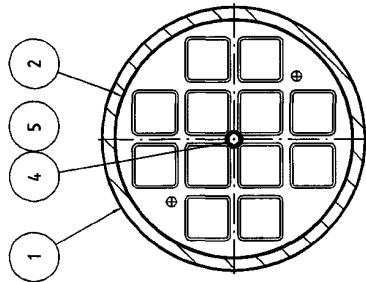
76-B

A

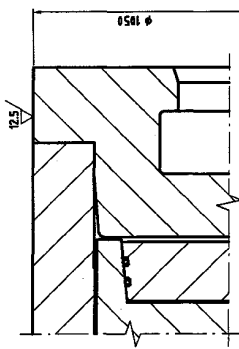
B



SEE NOTE 1

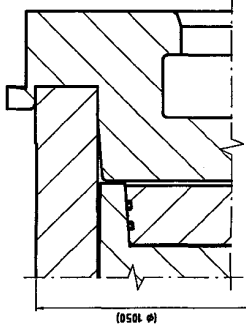


SECTION A-A



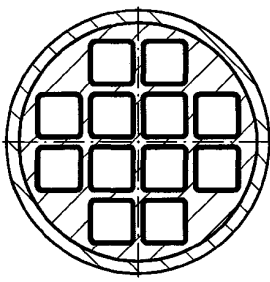
DETAIL C

AFTER WELDING AND MACHINING  
SCALE 5:2



DETAIL C

BEFORE WELDING AND MACHINING  
SCALE 5:2



SECTION B-B

NOTE

ANM.

1. NUMBER OF CANISTER TO BE PUNCH MARKED ACCORDING TO SKB'S DIRECTIONS

1. NUMMER PÅ BEHÅLLARE STANSAS IN LÄNDRIGT MED ANVISNING FRÅN SKB

1	1	COPPER / IRON CANISTER	00014-1
5	1	WASHER 30x36x2	COPPER
4	1	SCREW R30	00014-001
3	1	COPPER LID	00014-31
2	1	STEEL LID, ASSY	00014-21

Part	Qty	Description	Material/Finishing
1	1	COPPER / IRON CANISTER	
5	1	WASHER 30x36x2	
4	1	SCREW R30	
3	1	COPPER LID	
2	1	STEEL LID, ASSY	

Drawn by	Checked by	Approved by	Date
KJP	W	CGA	2004-08-14

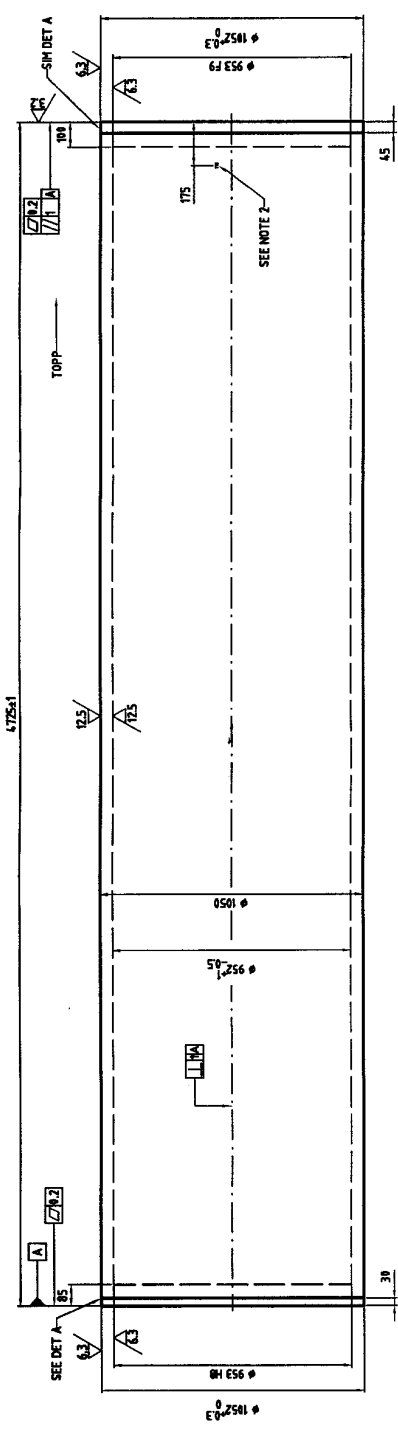
  

Scale	1/10
Sheet	A1
Order No.	00014
Project No.	00014
Rev	1/11

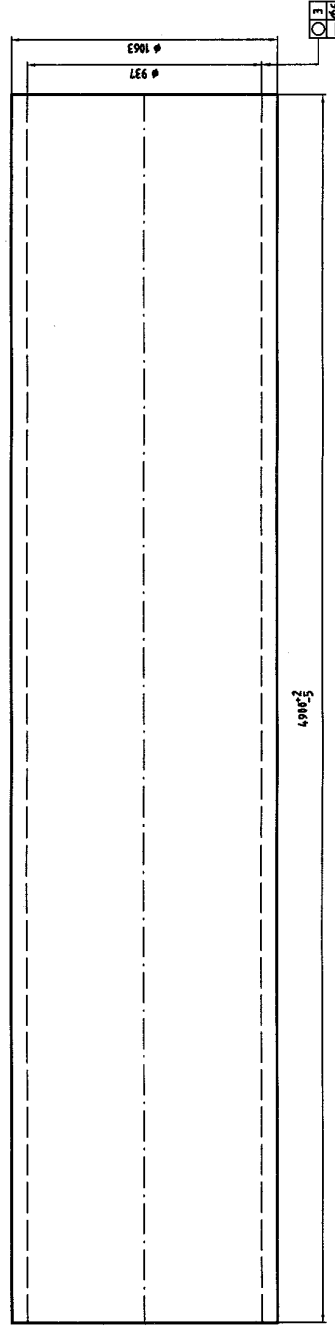




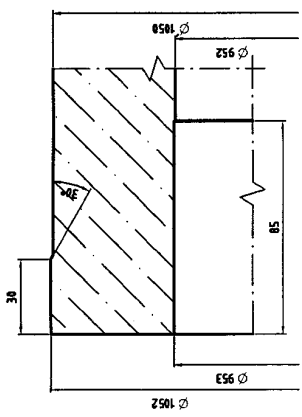
REV	DATE	BY	CHKD	DESCRIPTION
B	2010-07-14	DM	DM	BEFORE MACHINING CHANGED
C	2011-11-17	DM	DM	Dim & straightener changed



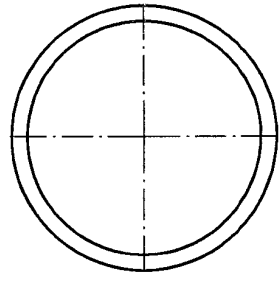
AFTER MACHINING



BEFORE MACHINING



DETAIL A  
SCALE 1:1



NOTE  
ANM.

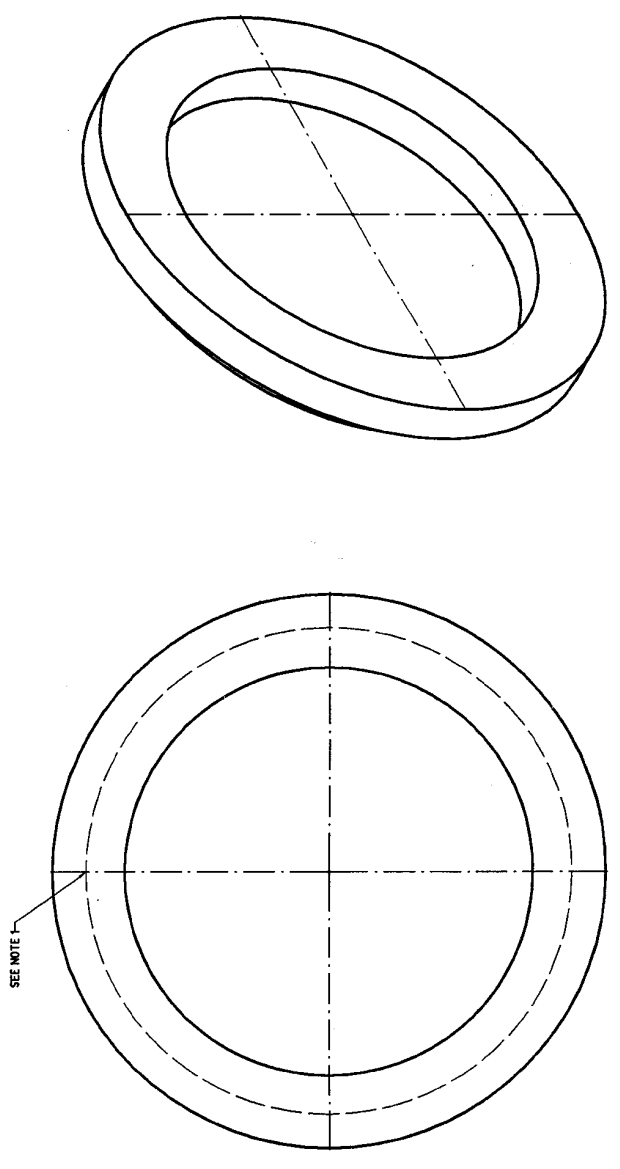
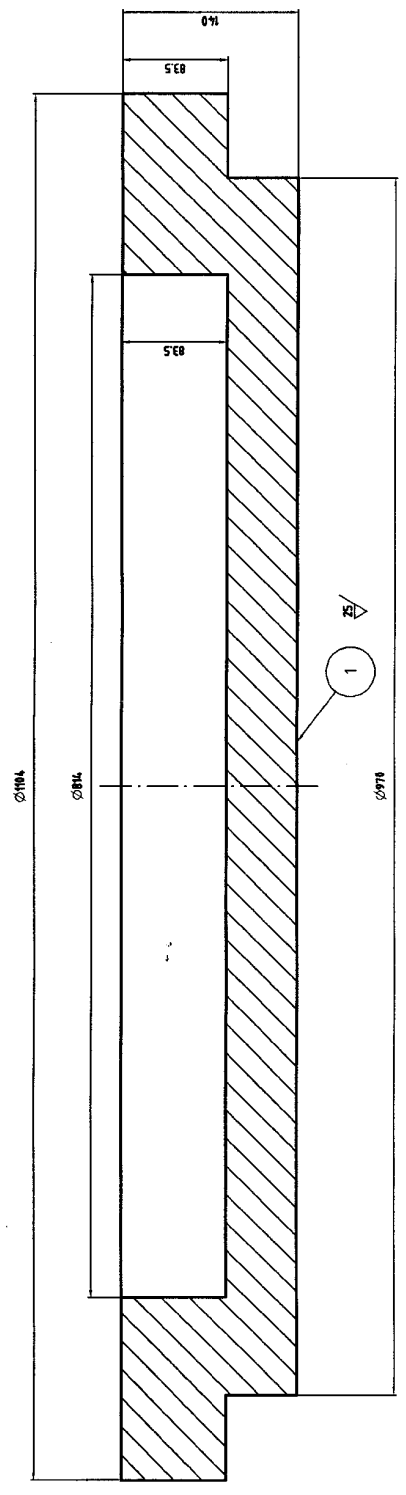
- SHARP EDGES BROKEN
- SKARPA KANTER BRYTES
- NUMBER OF CYLINDER TO BE PUNCHED ON INSIDE
- NUMMER PÅ CYLINDER STANSAS PÅ INSIDAN

Part Name		Description		Material/Quantity		Status	
EXTRUDED COPPER CYLINDER		COPPER CYLINDER		COPPER / BOM CYLINDER		1/10 C	
Part No.	00004-111	Rev.	1/10	Material	COPPER	Quantity	1
City	Stockholm	Country	Sweden	Part No.	00004-111	Rev.	1/10
Company	SKB	Address	Stensånsvägen 1	City	Stockholm	Country	Sweden
Phone	+46 8 736 9000	Fax	+46 8 736 9001	Part No.	00004-111	Rev.	1/10
Website	www.skb.se	E-mail: order@s-k-b.se		Part No.		00004-111	
Part No.		00004-111		Rev.		1/10	
Part Name		EXTRUDED COPPER CYLINDER		Material/Quantity		Status	
COPPER CYLINDER		COPPER / BOM CYLINDER		COPPER		1	





2000-11-09	INTE RÖRRE	REP	1	1	1
------------	------------	-----	---	---	---

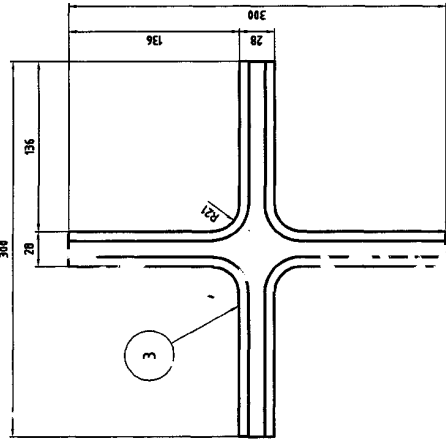
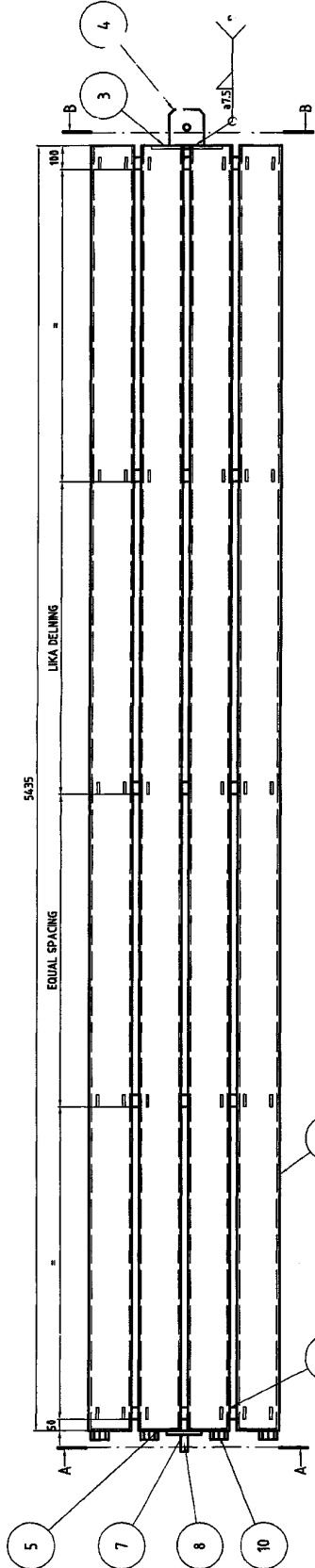


NOTE  
 ANM.  
 1. NUMBER OF COPPER FORGING TO BE PUNCH MARKED ACCORDING TO  
 SKB'S DIRECTIONS  
 1. NUMMER PÅ KOPPAR SHIDE STANSAS IN I ENLIGHET MED ANVISNING  
 FRÅN SKB

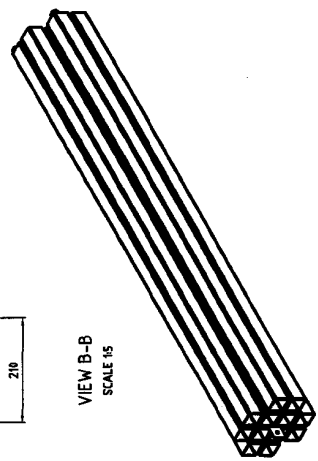
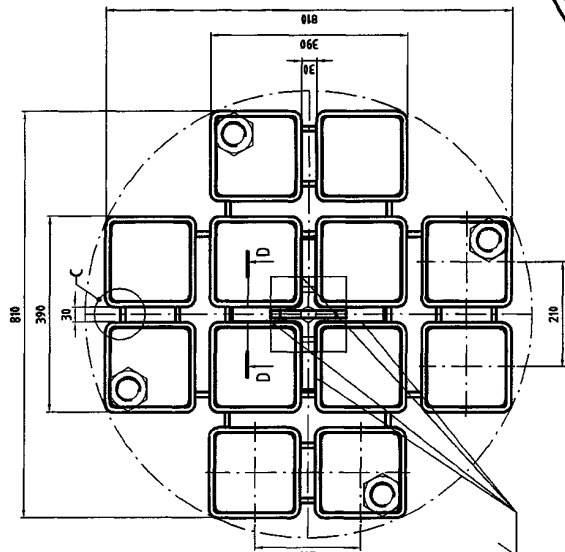
COPPER FORGING		S.S. 5011	
Part No.	00004-311	Material	COPPER / BRON CARBIDE
City	SKB	Quantity	1/10
Original By	SKB	Material / Size	Ø 270
Manufactured By	SKB	Material / Size	Ø 214
Inspected By	SKB	Material / Size	Ø 184
Approved By	SKB	Material / Size	Ø 140
Drawn By	SKB	Material / Size	Ø 93.5
Checked By	SKB	Material / Size	Ø 93.5
Reviewed By	SKB	Material / Size	Ø 93.5
Final Approved By	SKB	Material / Size	Ø 93.5
Part No.	00004-311	Material	COPPER / BRON CARBIDE
City	SKB	Quantity	1/10
Original By	SKB	Material / Size	Ø 270
Manufactured By	SKB	Material / Size	Ø 214
Inspected By	SKB	Material / Size	Ø 184
Approved By	SKB	Material / Size	Ø 140
Drawn By	SKB	Material / Size	Ø 93.5
Checked By	SKB	Material / Size	Ø 93.5
Reviewed By	SKB	Material / Size	Ø 93.5
Final Approved By	SKB	Material / Size	Ø 93.5



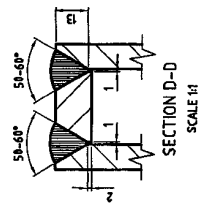
Rev	Desc	Issued	By	Checked	Approved



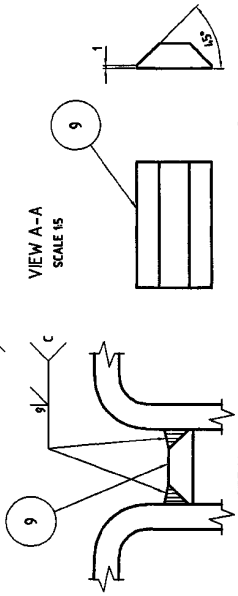
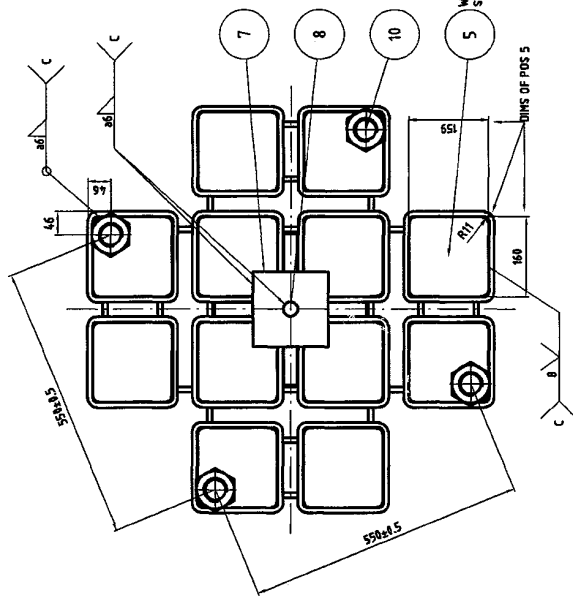
DETAIL OF POS 3  
SCALE 1:2



VIEW B-B  
SCALE 1:5



SECTION D-D  
SCALE 1:1



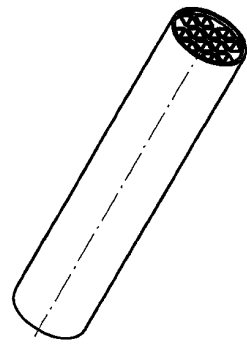
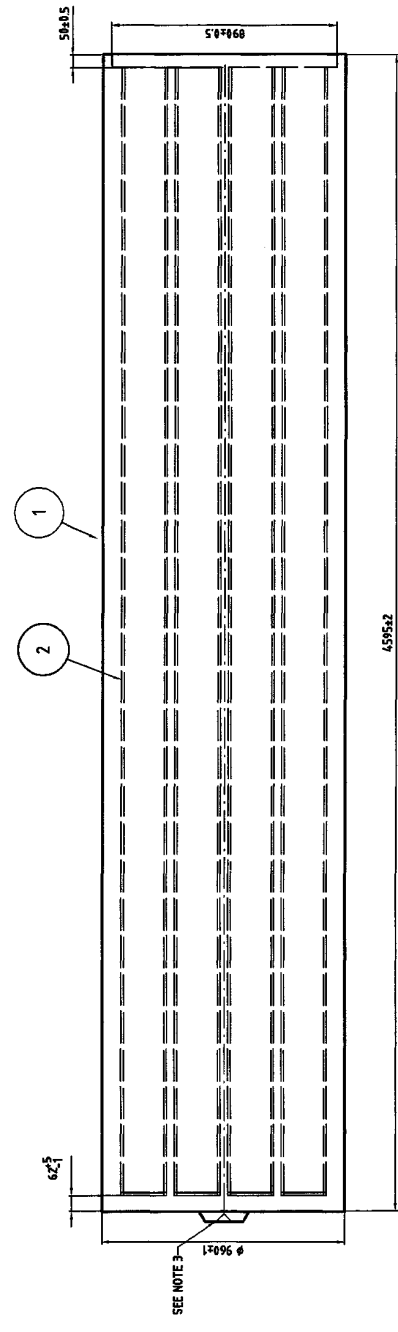
VIEW A-A  
SCALE 1:5

DETAIL OF POS 9  
SCALE 1:1

10	4	NUT M6x14-8.8 OBER DIMPS4	1/10	A1
9	1	FLAT BAR 30x10 L58 S355JR	1/10	A1
8	1	ROUND BAR DIA=30 L=78 S355JR	1/10	A1
7	1	PLATE L=15 B=60 S355J03	1/10	A1
5	1	PLATE L=15 B=60 S355J03	1/10	A1
4	1	PLATE L=15 B=60 S355J03	1/10	A1
3	1	PLATE L=15 B=60 S355J03	1/10	A1
2	1	PLATE L=15 B=60 S355J03	1/10	A1
1	1	YR BAR DIA=18 S355J03 L=435	1/10	A1

**SKB**  
 TECHNICAL DEPARTMENT  
 00014-121  
 STEEL PROFILE CASSETTE  
 COPPER / ROOF CASSETTE  
 DWG SERIAL 2  
 1/10  
 A

Rev	Rev	Rev	Rev	Rev	Rev	Rev	Rev



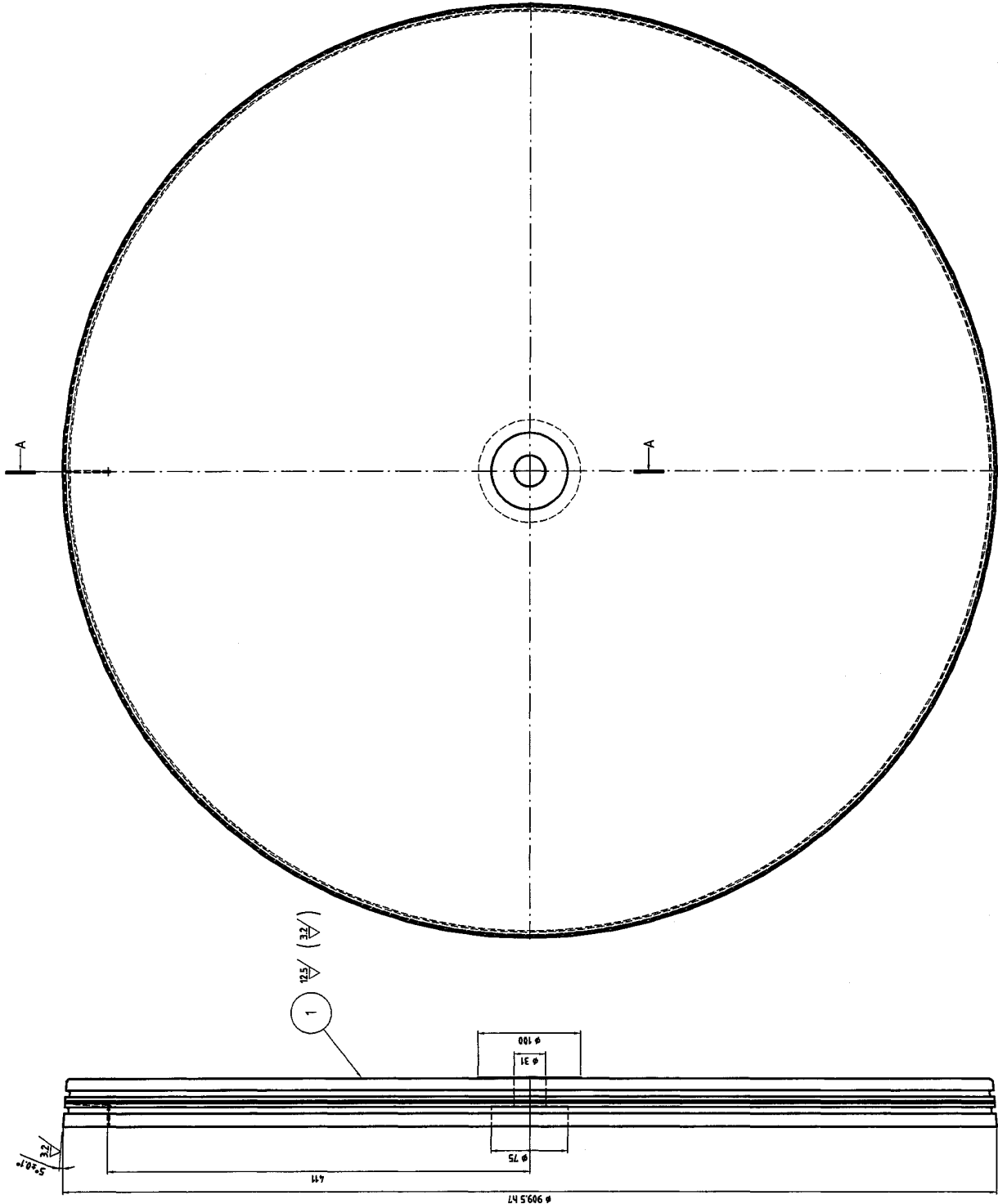
NOTE  
 ANM.  
 1. SHARP EDGES BROKEN  
 1. SKARPA KANTER BRUTNA  
 2. NUMBER OF INSERT TO BE PUNCH MARKED ACCORDING TO SKB'S DIRECTIONS  
 2. NUMMER PÅ INSATTS STANSAS NI ENLIGHET MED ANVISNING FRÅN SKB  
 3. CENTRE TO REMAIN  
 3. DOBBHÅL SPARAS

2	1	STEEL PROFILE CASSETTE	0004-121															
1	1	CAST IRON																
<table border="1"> <tr> <th>Part</th> <th>Qty</th> <th>Description</th> <th>Material/Drucking</th> <th>Notes</th> </tr> <tr> <td>1</td> <td>1</td> <td>STEEL PROFILE CASSETTE</td> <td>0004-121</td> <td></td> </tr> <tr> <td>1</td> <td>1</td> <td>CAST IRON</td> <td></td> <td></td> </tr> </table>				Part	Qty	Description	Material/Drucking	Notes	1	1	STEEL PROFILE CASSETTE	0004-121		1	1	CAST IRON		
Part	Qty	Description	Material/Drucking	Notes														
1	1	STEEL PROFILE CASSETTE	0004-121															
1	1	CAST IRON																
<p>Checked by: <i>[Signature]</i> Date: 2011-06-28        Drawn by: <i>[Signature]</i> Date: 2011-06-28        Scale: 1:10 A1        Project: <i>[Signature]</i></p>																		
<p>SKB        SKANSKA        SKANSKA        SKANSKA</p>			<p>0004-122        CAST IRON INSERT, PREMACH        COPPER / IRON CASSETTE        110 A</p>															



Rev	Date	By	Check	Appr
B	2004-05-25	KZP	LON	CGA
C	2011-06-11	KZP	LON	CGA

Revision  
 Total change of lid  
 Angle and dim changed

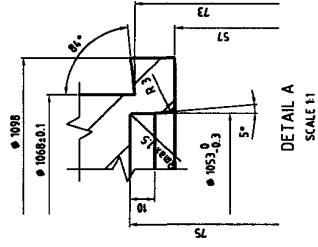
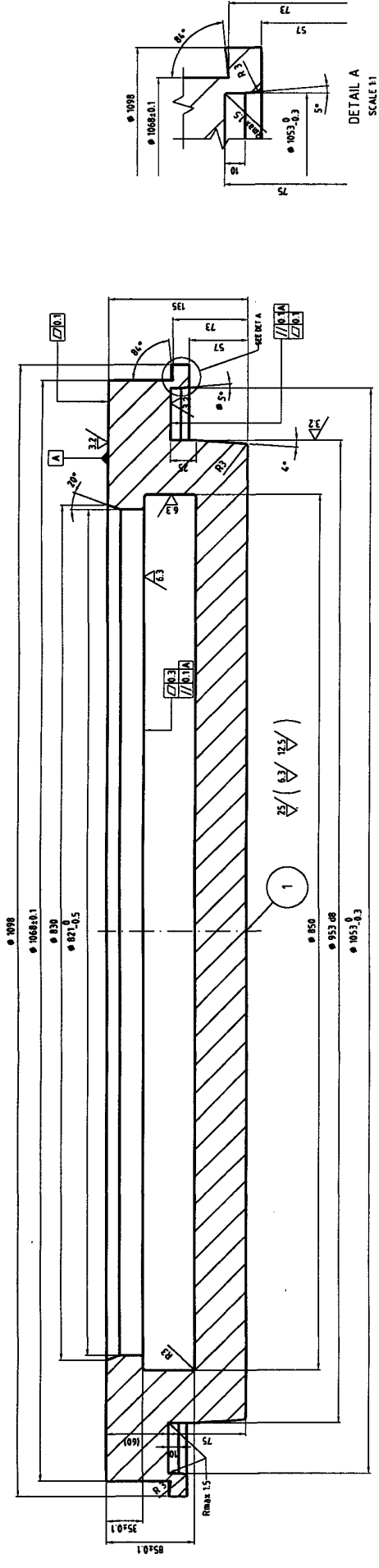


SECTION A-A  
SCALE 1:1

Part	Qty	Description	Material/Drinking	Notes
1	1	PLATE T-50 DIA-920	S235JR02	
1	1	307/GA_LV		
1	1	191656		
1	1	191657		

BWR SERIAL 1  
 STEEL LID MACHINING  
 COPPER / BWR CENTER  
 00004-211  
 1/11  
 C

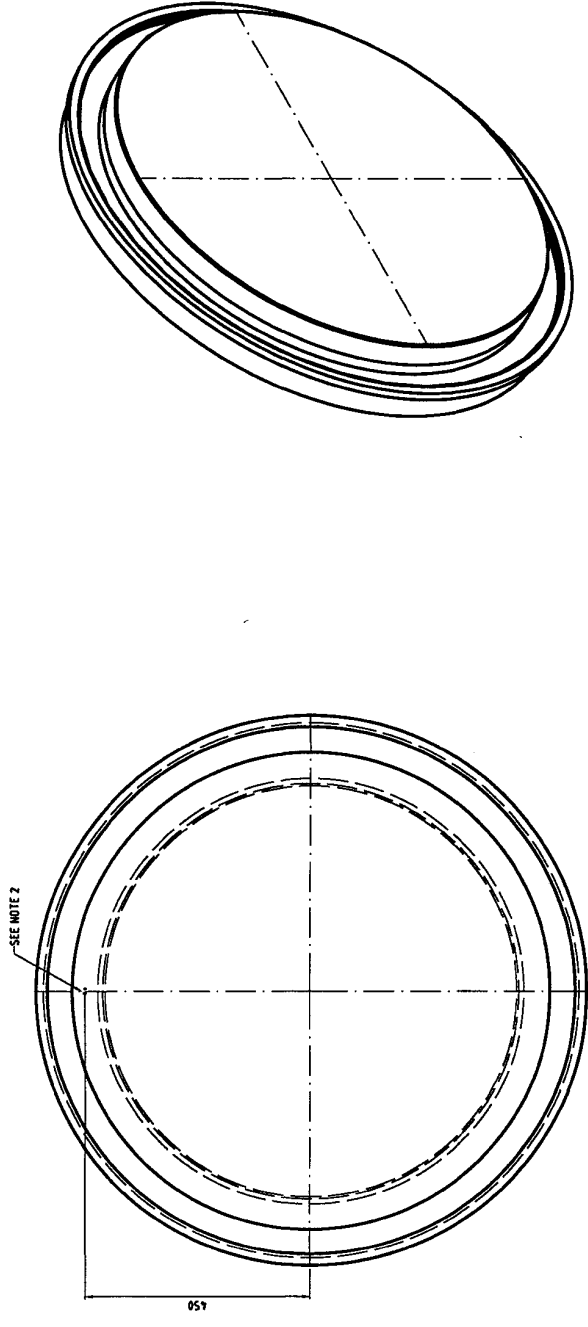
Rev	Date	Author	Checked	Drawn	Appr.



DETAIL A  
SCALE 1:1

NOTE  
ANM!

1. SHARP EDGES BROKEN
1. SKARPA KANTER BRUTNA
2. NUMBER OF COPPER LID TO BE PUNCH MARKED ACCORDING TO SHB'S DIRECTIONS
2. NUMMER PÅ KOPPAR LOCK STANSAS IN I ENLIGHET MED ANVISNING FRÅN SHB

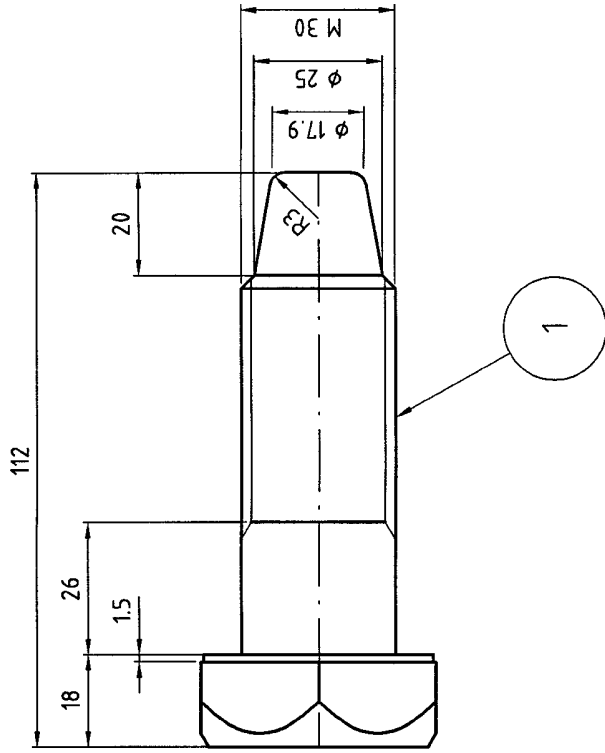
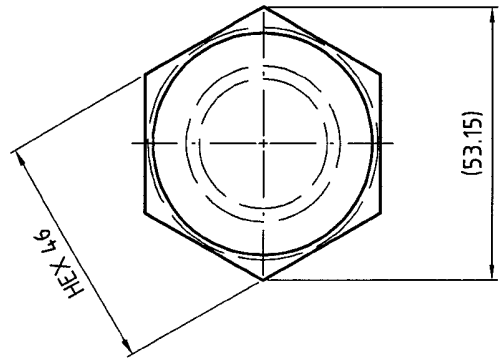
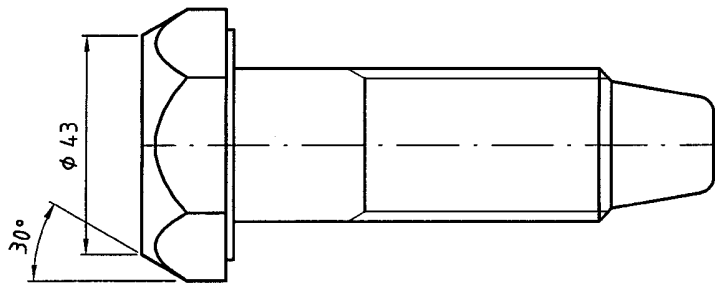


BOTTOM VIEW  
SCALE 1:5

Proj. No.	00004-311	Proj. Name	00004-311
City	FORSGÅNG	Description	MATERIAL/DRAWING
Design by	Andreas Malmberg AB	Checked by	Andreas Malmberg
Drawn by	Andreas Malmberg	Scale	1:2
Issue No.	00004-311	Issue Date	2012-03-14
Issue Reason		Issue By	Andreas Malmberg
Part No.	00004-31	Part Name	00004-31
Material	SHB	Material	SHB
Quantity	1	Quantity	1
Unit	PC	Unit	PC
Drawn by	Andreas Malmberg	Checked by	Andreas Malmberg
Issue No.	00004-31	Issue Date	2012-03-14
Issue Reason		Issue By	Andreas Malmberg
Part No.	00004-31	Part Name	00004-31
Material	SHB	Material	SHB
Quantity	1	Quantity	1
Unit	PC	Unit	PC



Rev	Date	Revision	Position	Drawn	Check.	Approv.



1	1	ROUND BAR DIA 55 L=115	S355JR	Material/Drawing	Mass
Pos	Qty	Description	Checked / Date	Projection	General Tolerance:
Designed by	Drawn / Date	Checked / Date	200808	CSA	SS-ISO 2768-1 Middle and/or SMS 723-B
Kocums Indutrier AB	KZP	2000-05-26	200808	CSA	
on commission from SKB	2000-05-26	2000-05-26	CSA		
SKB dnr: No. SKB80-06084-401	Scale	Format			
	1:1	A3			
<p><b>SKB</b> SVENSK KÄRNBRÄNSLE-HANTERING AB</p>			<p>BWR SERIAL 1 SCREW M30 COPPER / IRON CANISTER</p>		
<p>Drawing No. 00004-001</p>			<p>Page 1/(1) Rev. A</p>		

## **Appendix 2**

### **Technical specification KTS 001 “Material for Copper Canisters”**

Technical Specification No KTS001

Revision No 2

Valid from 1 Nov 1999

Prepared by

Reviewed by

Approved by

*Maule Westman*  
*Jan Welin*  
*Christer Adner*

**Material for Copper Canisters**

**KTS001 Material for Copper Canisters**

**1 Purpose**

The purpose of this technical specification, KTS001, is to define technical requirements and documentation routines for copper ingots, copper forgings, rolled copper plates or seamless copper pipes produced by pierce and draw process or extrusion.

**2 Technical requirements**

**2.1 Material specification**

The material for copper canisters shall fulfil the specification in the standard UNS C10100 (Cu-OFE, table 2) or En 133/63:1994 Cu-OF1 (table 3) with the following additional requirements: O < 5 ppm, P 40 – 60 ppm, H < 0,6 ppm, S < 8 ppm and in **forgings, rolled plates or seamless copper pipes** a grain size of < 360 µm. The grain size is measured according to ASTM's comparison method E112-95.

**2.2 Chemical composition, grain size, and mechanical properties**

Table 1. Requirements and comments concerning various properties

Property	Specification	Comments
Weldability	O < 5 ppm	Higher levels give a reduced weldability.
Ductility	H < 0,6 ppm	Higher levels give reduced mechanical properties. (Hydrogen embrittlement).
Tensile strength, ductility	S < 8 ppm	Higher levels give reduced mechanical properties caused by non-dissolved sulphur which will be concentrated to grain boundaries.
Creep ductility	P 40 – 60 ppm	A phosphorus content of this order reduces the influence of sulphur impurities, increases creep ductility, increases recrystallisation temperature and has a minor influence on the weldability.
Microstructure	Grain size < 360 µm (Hot formed material)	This grain size gives a resolution at ultrasonic testing comparable to X-ray testing of 50 mm thick copper.
Ductility	Elongation > 40% RT – 100°C (Hot formed material)	The canister will be deformed 4% in final repository.
Creep ductility	Elongation at creep-rupture > 10% RT – 100°C (Hot formed material)	Same comment as above.

Technical Specification No KTS001

Revision No 2  
Valid from 1 Nov 1999  
Prepared by M Westman  
Reviewed by L Werme  
Approved by C-G Andersson

**Material for Copper Canisters**

Table 2. UNS C10100 composition

Element	Cu	Ag	As	Fe	S	Sb	Se	Te	Pb
	%	ppm <sup>2</sup> →							
	99,99 <sup>1</sup>	25	5	10	15	4	3	2	5
		Bi	Cd	Mn	Hg	Ni	O	Sn	Zn
		ppm <sup>2</sup> →							
		1	1	0,5	1	10	5	2	1

Table 3. EN 133/63 Cu-OF1 composition

Element	Cu	Ag	As	Fe	S	Sb	Se	Te	Pb
	(rem.)	ppm →							
		25 <sup>2</sup>	5 <sup>3</sup>	10 <sup>4</sup>	15 <sup>2</sup>	4 <sup>2</sup>	2 <sup>5</sup>	2 <sup>6</sup>	5 <sup>2</sup>

- 1 Including Ag
- 2 Maximum content
- 3  $\Sigma \text{As} + \text{Cd} + \text{Cr} + \text{Mn} + \text{Sb} \leq 15 \text{ ppm}$
- 4  $\Sigma \text{Co} + \text{Fe} + \text{Ni} + \text{Si} + \text{Sn} + \text{Zn} \leq 20 \text{ ppm}$
- 5  $\Sigma \text{Bi} + \text{Se} + \text{Te} \leq 3 \text{ ppm}$
- 6  $\Sigma \text{Se} + \text{Te} \leq 3,0 \text{ ppm}$

2.3 Size and tolerances

*Copper ingot*

Nominal weight, size and surface condition according to SKB order.

*Forged copper disk*

Nominal weight, size and surface condition according to SKB order.

*Rolled plate*

Nominal length, width and thickness according to SKB order.

Tolerances:

- Thickness +5% / -0 mm
- Width +5 / -0 mm
- Length +5 / -0 mm
- Flatness 5 mm

*Seamless pipe*

Length, diameter, wall thickness and tolerances according to SKB order.

Technical Specification No KTS001

Revision No 2  
Valid from 1 Nov 1999  
Prepared by M Westman  
Reviewed by L Werme  
Approved by C-G Andersson

**Material for Copper Canisters**

**3 Inspection and testing of forging, plate or pipe prior to delivery**

3.1 Soundness

The forging, plate or pipe shall be controlled by 100% ultrasonic testing. Size and shape of reference defect and acceptance criteria shall be as stated in SKB order.

3.2 Mechanical properties and structure

Test pieces for tensile testing (Rp 0,2; Rm; A 50 mm), shall be taken from each **plate** or **pipe**. Specimens for hardness test (HRF) and grain size/structure inspection shall be taken from each **forging, plate** or **pipe**. All sampling is to be described in the quality plan.

Tensile testing shall be performed in the normal manner. Hardness and grain size/structure shall be determined close to the surface and also in the centre of the material. For forgings the centre part refers to one surface part of the disk centre. The structure shall be documented by photos at circa 100 x magnification.

**4 Documentation**

4.1 Certification of copper ingots

The copper ingot manufacturer shall issue a certificate according to EN 10204 3.1.B, stating as a minimum:

- the manufacturer's name and address,
- date of issue,
- SKB order number,
- heat or cast number,
- copper ingot dimensions and weight,
- applicable standard,
- chemical composition,
- result of hydrogen embrittlement test (ASTM B 477 – method to be stated in the certificate), determination of electrical conductivity and density,
- illustrated description of sampling of solid material,<sup>1</sup>
- a declaration that the material has been produced in accordance with the company's own current quality system,
- any other requirement specified in SKB order.

<sup>1</sup> Requirements on sampling, including sample positions, may be added in a later revision of this document.

Technical Specification No KTS001

Revision No 2  
Valid from 1 Nov 1999  
Prepared by M Westman  
Reviewed by L Werme  
Approved by C-G Andersson

**Material for Copper Canisters**

**4.2 Hot forming process**

The hot forming process shall be performed in such a manner that the specified properties of the delivered product are met. The process shall be controlled and documented by the manufacturer of forging, plate or pipe to the extent necessary for ensuring reproducibility.

**4.3 Certification of processed copper material**

The forging, plate or pipe manufacturer shall issue a certificate according to EN 10204 3.1.B, stating as a minimum:

- the manufacturer's name and address,
- date of issue,
- SKB order number,
- original heat or cast number,
- lot number and/or number of the forging, plate or pipe,
- dimensions and weight of the forging, plate or pipe,
- material temperatures at each forming step,
- results of ultrasonic testing, tensile and hardness testing, and determination of grain size and structure,
- illustrated description of sampling,<sup>1</sup>
- a declaration that the material has been produced in accordance with the company's own current quality system,
- any other requirement specified in SKB order.

**4.4 Submission of documents and information**

Before hot forming, the copper ingot certificate according to 4.1 shall be sent to SKB by mail or telefax for authorization.

The certification according to 4.3 shall be sent to SKB for authorization prior to delivery of the forging, plate or pipe.

The supplier shall, without delay, give complete information to SKB on all observations and other circumstances in connection with the production which may influence the design of the copper canister. SKB shall have the right to use this information without any restriction.

**5 Document control**

QA Co-ordinator Canister Manufacturing Technique is responsible for document control, including distribution, of this technical specification.<sup>2</sup>

-----  
1 Requirements on sampling, including sample positions, may be added in a later revision of this document.  
2 Procedure KT1001

## **Appendix 3**

### **Technical specification KTS 011 “Nodular Cast Iron SS 0717 Insert”**

Technical Specification No KTS011

Revision No 1

Valid from 30 Mar 2000

Prepared by *Marika Westman*

Reviewed by *Jan Wenne*

Approved by *Cher Co Aden*

**Nodular Cast Iron SS 0717 Insert**

**KTS011 Nodular Cast Iron SS 0717 Insert**

**1 Purpose**

The purpose of this technical specification, KTS011, is to define the technical requirements and documentation for nodular cast iron inserts.

**2 Technical requirements**

**2.1 Material specification**

The material specification for nodular cast iron inserts coincides with the requirements in SS 14 07 17- 00, issue 4 1981.

**3 Production**

**3.1 Drawings**

Drawings according to applicable SKB order shall be used for the production and inspection of inserts.

**3.2 Steel section cassette<sup>1</sup>**

The cassette shall be shot blasted and stored under dry conditions to prevent rusting. The shot blasting shall be done as closely in time as possible prior to casting.

**3.3 Casting**

The melt temperature at the beginning of the casting shall be recorded.

Sample for chemical analysis shall be taken in accordance with normal praxis.

The time from casting to the knocking out shall be recorded.

-----  
1 Specification KTS021



Technical Specification No KTS011

Revision No 1  
Valid from 30 Mar. 2000  
Prepared by Marika Westman  
Reviewed by L Werme  
Approved by C-G Andersson

**Nodular Cast Iron SS 0717 Insert**

**4 Inspection and testing**

4.1 Tensile testing and micro structure evaluation

Test pieces for tensile testing shall be taken from cast-on test samples close to the top and bottom of the casting. Normal tensile testing shall be performed. Requirements for separately cast test samples according to SS 14 07 17- 00 shall apply.

Hardness testing (HB) and micro structure evaluation shall also be performed on the test pieces. The structure shall be documented in micrographs at circa 100x magnification.

4.2 Size and shape inspection

The casting shall be measured to check its conformity with the specified size.

For BWR fuel canister prototypes with cassettes made from square sections (VKR) 180 x 180 x 10 mm (outer size x thickness) the straightness of the channels shall be sufficient to permit a 152 x 152 mm square profile template in accordance with applicable SKB drawing to freely move down the entire channel.

For PWR fuel canister prototypes with cassettes sections 250 x 250 x 10 mm the corresponding template size is 224 x 224 mm.

4.3 Ultrasonic testing

The casting shall be tested from the outside with regard to inner defects such as non-metallic inclusions and other inhomogeneities. 100% outside testing shall be performed. A 6 mm diameter flat bottom hole shall be used as the reference defect. Inhomogeneities giving indications equal to or greater than 50% of the reference level shall be recorded. The position and size shall be recorded on sketches.

Operators shall have a documented competence according to ASNT-TC-1A Level 2.

**5 Documentation**

5.1 Photographic documentation

The production sequence shall be photographically documented when required by SKB. The extent is to be agreed with SKB from case to case.

Technical Specification No KTS011

Revision No 1  
Valid from 30 Mar. 2000  
Prepared by Marika Westman  
Reviewed by L Werme  
Approved by C-G Andersson

**Nodular Cast Iron SS 0717 Insert**

**5.2 Certification**

A certificate according to EN 10204 3.1.B shall be issued by the producer stating as a minimum:

- the producer's name and address,
- SKB order number,
- SKB drawing number,
- casting date,
- cast or heat number,
- weight of casting,
- chemical composition,
- results of tensile testing, micro structure evaluation, size and shape inspection, and ultrasonic testing,
- a declaration that the material has been produced in accordance with the company's own current quality system.

**5.3 Submission of documents and information**

The documentation according to 3.3, 5.1 and 5.2 shall be sent to SKB for authorisation prior to delivery.

The supplier shall, without delay, give complete information to SKB on all observations and other circumstances in connection with the production which may influence the design of the insert. SKB shall have the right to use this information without any restriction.

**6 Document control**

QA Administration is responsible for document control, including distribution, of this technical specification.<sup>1</sup>

-----  
1 Procedure KT1001

**Technical specification KTS 021 “Steel Section Cassette”**

Technical Specification No KTS021

Revision No 1

Valid from 30 Mar. 2000

Prepared by

Reviewed by

Approved by

*Marika Westman*  
*Lars Wenne*  
*Klas Göran Aden*

**Steel Section Cassette**

**KTS021 Steel Section Cassette**

**1 Purpose**

The purpose of this technical specification, KTS021, is to define the technical requirements and documentation for the manufacture of steel section cassettes intended for cast canister inserts.

**2 Technical requirements**

**2.1 Material specification for square sections**

The material specification for VKR<sup>1</sup> (RHS<sup>2</sup>) square hollow sections coincides with the requirements in SS 14 21 34-04, issue 4 1993, concerning chemical composition and mechanical properties (ReL, Rm, A5). Test pieces for determination of lower yield strength, tensile strength and elongation according to SS 11 21 10 shall be used.

For BWR fuel canisters 180 x 180 x 10 mm (outer size [D] x thickness [t]) VKR square section size applies, and for PWR fuel canisters the corresponding size is 250 x 250 x 10 mm.

Size and shape tolerances, based on SS 21 28 20 and SS 21 28 30:

- D:  $\pm 1\%$  of D
- t:  $- 6\%$  of t
- squareness:  $90^\circ \pm 1^\circ$
- flatness deviation:  $\leq 1\%$  of D (across section, inwards or outwards)
- skewness: max 2 mm + 0,5 mm/m section length
- outer corner radius: max 3 t
- length: +10 – 0 mm
- straightness: 0,20% of total length

Seamless sections as well as welded sections can be used. In the latter case the weld bead shall be flush against the section inner wall, if necessary machined.

**2.2 Material specification for plates and flat bars**

The material specification for steel plates and flat bars coincides with the requirements in SS 14 13 12, issue 11 1990.

Plate and bar sizes are specified on applicable SKB drawings.

- 
- 1 Hot finished square structural hollow sections (Varmbearbetade konstruktionsrör)
  - 2 Rectangular hollow sections

Technical Specification No KTS021

Revision No 1  
Valid from 30 Mar. 2000  
Prepared by M Westman  
Reviewed by L Werme  
Approved by C-G Andersson

**Steel Section Cassette**

**2.3 Material specification for tubes**

The material specification for steel tubes coincides with the requirements in SS 14 21 72, issue 11 1990.

The tube size is specified on the applicable SKB drawing.

**3 Production**

**3.1 Drawings**

Drawings according to applicable SKB order shall be used for the manufacture of cassettes.

**3.2 Manufacture of steel section cassette**

The cassette shall be assembled by welding. The selection of welding method is at the discretion of the manufacturer but shall follow a welding procedure specification (WPS), issued by the manufacturer. Precautions shall be taken to prevent deformation of the sections as well as burning-through during the welding operation.

**4 Inspection and testing**

**4.1 Size and shape inspection**

The completed manufactured cassette shall be measured to check its conformity with the specified size and shape. For prototype cassettes made from square sections (VKR) 180 x 180 x 10 mm (outer size x thickness) the straightness of the channels shall be sufficient to permit a 156 x 156 mm square profile template, manufactured according to applicable SKB drawing, to freely move down the entire channel.

For cassettes made from 250 x 250 x 10 mm sections the corresponding square profile template shall be 226 x 226 mm.

**4.2 Inspection of welds**

The complete, welded cassette shall be visually inspected for welding defects, and the welded bottom ends of the sections shall be penetrant tested. Cracks and incomplete welds at the bottom ends are not permitted. Any defects of such a type shall be repaired by welding and subsequently inspected by the manufacturer.

Technical Specification No KTS021

Revision No 1  
Valid from 30 Mar. 2000  
Prepared by M Westman  
Reviewed by L Werme  
Approved by C-G Andersson

**Steel Section Cassette**

**5 Documentation**

5.1 Steel section certificates

The steel section producer shall issue a certificate according to EN 10204 2.2, or higher, stating, as a minimum:

- the steel section producer's name and address,
- reference to applicable material/product standard,
- result of chemical analysis and mechanical testing of material according to clause 2.

5.2 Photographic documentation

The cassette manufacture shall be photographically documented when required by SKB. The extent is to be agreed with SKB from case to case.

5.3 Other documentation

The cassette manufacturer shall issue a report indicating

- weight of cassette,
- result of size and straightness inspection,
- result of visual and penetrant inspection of welds.

5.4 Submission of documents and information

The documentation mentioned in 5.1, 5.2 and 5.3 shall be submitted to SKB by the party receiving the SKB order (foundry or cassette manufacturer).

The supplier shall also, without delay, give complete information to SKB and to the foundry concerned on all observations and other circumstances in connection with the production which may influence the design of the cassette. SKB shall have the right to use this information without any restriction.

**6 Document control**

QA Administration is responsible for document control, including distribution, of this technical specification<sup>1</sup>.

-----  
1 Procedure KT1001

## **Appendix 5**

### **Drawings. Adaptation of copper tube and bottom for EB welding**









## **Appendix 6**

### **Contents of Quality Manual – Canister Fabrication and list of procedure descriptions**

Kapitel 1

Rev nr 4

**Översikt**

Giltig från 2001-03-09

 Granskad av *Kajsa Torra Brudman*

 Godkänd av *Anders Johansson*

## Innehållsförteckning

Kapitel	Rubrik	Rev
1	Översikt	4
2	Policies, verksamhetsinriktning och mål	3
3	Organisation, ansvar och befogenheter	2
4	Relation till handboken för Inkapslingsteknik	2
5	Kvalitets- och miljöledningssystem, kvalitetsrevisioner	3
6	Utveckling av kapsel och kapseltillverkning	3
7	Styrning av kapseltillverkning	4
8	Styrning av stödprocesser (inköp, mottagningskontroll m m)	3
9	Flödesschema material och produkt	2
10	Styrning och behandling av dokument och data	3
11	Behandling av avvikelser	3
12	Korrigerande och förebyggande åtgärder, ständiga förbättringar	4
13	Utbildning och kompetens	2
14	Speciella termer och förkortningar	3
15	Standarder	3
16	Korsreferenslistor	3
17	Förteckning över Procedures	4
18	Ordlista – Glossary	3
19	Sökregister	3

**Förteckning över Rutiner**

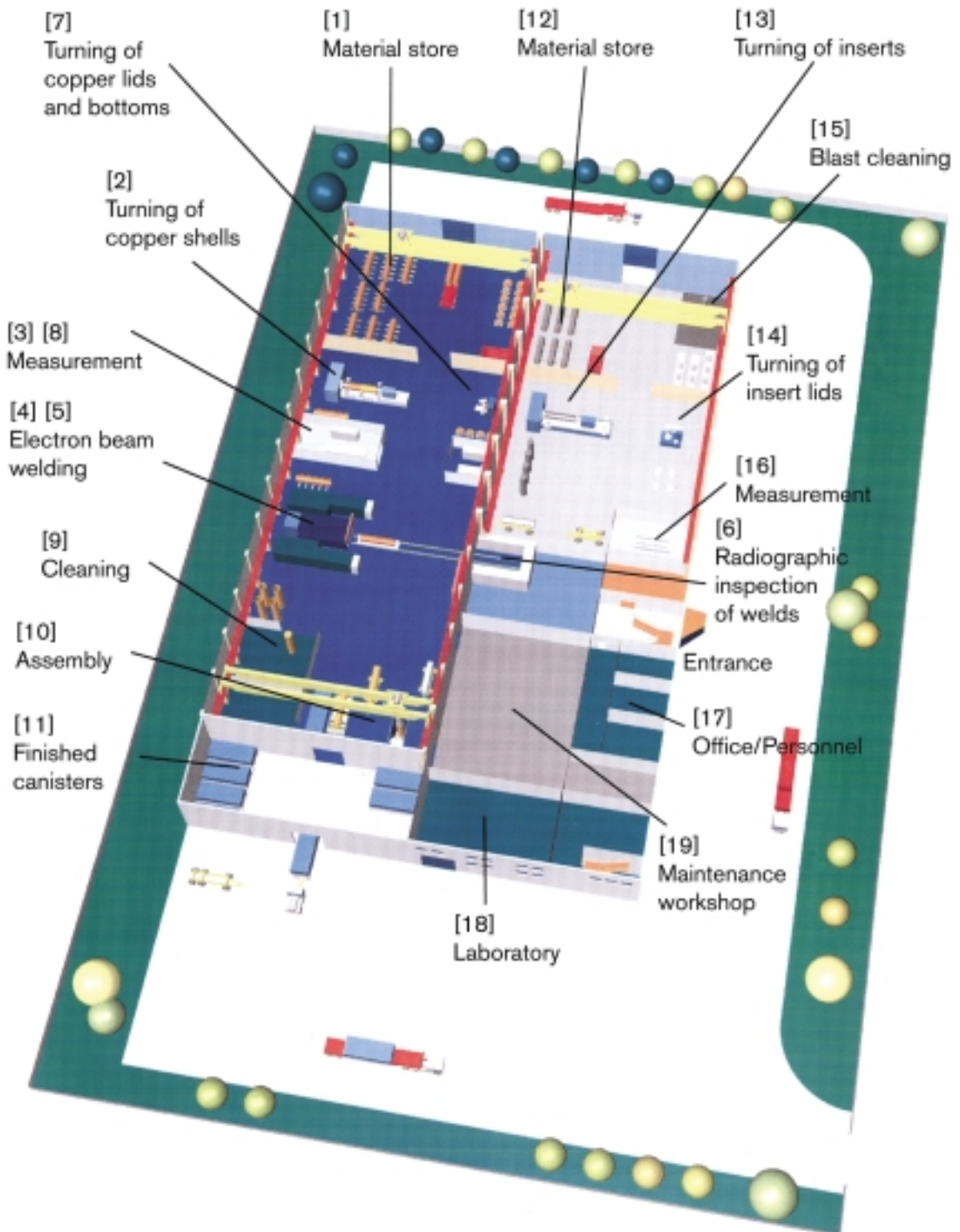
Rev nr 3  
 Giltig från 2000-03-30  
 Granskad av *Marika Westman*  
 Godkänd av *Ches Tom A. dunn*

**Förteckning över Rutiner (Procedures)**

<b>Rutin</b>	<b>Rubrik</b>	<b>Rev</b>
KT0501	Requirements for external quality auditing	3
KT0601	Techniques for quality analysis	1
KT0602	Qualification of manufacturing process	1
KT0603	Qualification of supplier/subcontractor (manufacturing)	1
KT0604	Qualification of supplier/subcontractor (inspection and metrological confirmation)	1
KT0605 (x)	Qualification of non-destructive testing methods	
KT0701	Final inspection and testing	1
KT0702	Packing and transport of canisters and/or canister components	1
KT0703	Delivery of canisters and/or canister components, documentation	1
KT0704	Requirements on quality plan and manufacturing and inspection plan	2
KT0705	Identification of canister components	1
KT0801	Control of inspection, measuring and test equipment	0
KT0803 (x)	Receiving inspection	
KT1001	Establishing and control of procedures	1
KT1002	Retaining of quality documents and records	2
KT1003	Handling of documents regarding canisters from trial manufacture	2
KT1004	Establishing and control of technical specifications	1
KT1101	Control of nonconformities at SKB	0
KT1102	Request for concession	1
KT1103	Control of nonconformities at supplier	1

(x) under framtagning

Planning of canister factory



ISSN 1404-0344

CM Digitaltryck AB, Bromma, 2002