

P-08-77

Oskarshamn site investigation

Complete chemical characterisation in borehole KLX27A

Results from borehole section 641.5 to 650.6 m

Anette Bergelin, Kersti Nilsson, Anna Lindquist, Pia Wacker
Geosigma AB

October 2008

Svensk Kärnbränslehantering AB
Swedish Nuclear Fuel
and Waste Management Co
Box 250, SE-101 24 Stockholm
Phone +46 8 459 84 00



Oskarshamn site investigation

Complete chemical characterisation in borehole KLX27A

Results from borehole section 641.5 to 650.6 m

Anette Bergelin, Kersti Nilsson, Anna Lindquist, Pia Wacker
Geosigma AB

October 2008

Keywords: Groundwater, Measurements on line, *In situ* sampling, Measurements *in situ*, Redox potential, Dissolved gas, Chemical analyses, Isotope determinations, Humic and fulvic acids, Colloids, Laser Induced Breakdown Detection, Scanning Electron Microscopy, Microbes, AP PS 400-08-008.

This report concerns a study which was conducted for SKB. The conclusions and viewpoints presented in the report are those of the authors and do not necessarily coincide with those of the client.

Data in SKB's database can be changed for different reasons. Minor changes in SKB's database will not necessarily result in a revised report. Data revisions may also be presented as supplements, available at www.skb.se.

A pdf version of this document can be downloaded from www.skb.se.

Abstract

Complete chemical characterisation is the most extensive chemical investigation method performed in core-drilled boreholes. The method entails pumping, measurements on-line and water sampling for chemical analyses in isolated borehole sections during approximately three weeks per section at a flow rate of between 50 and 270 mL/min.

This report presents results from the section at 641.5 to 650.6 m borehole length (vertical depth 576.0 to 583.9 m) in borehole KLX27A. The results obtained include on-line measurements of redox potential, pH, dissolved oxygen, electrical conductivity and water temperature in the borehole section together with chemical analyses of major constituents, trace metals and isotopes as well as gas content and composition. Furthermore, inorganic and organic colloids were investigated by fractionation, laser-induced breakdown colloid detection (LIBD) and scanning electron microscopy (SEM).

The water composition in section 641.5 to 650.6 m was stable during the pumping and sampling period. The flushing water content was very low, c. 0.02%, and the chloride concentrations amounted to approximately 1,700 mg/L.

The redox potentials for the electrodes were not completely stable and the final measured value was about -190 mV.

The colloid content measured by LIBD amounted to between 230 and 330 µg/L. The colloidal particles consisted mainly of iron.

Sammanfattning

Fullständig kemikaraktisering är den mest omfattande kemiska undersökningsmetoden för kärnborrhål. Metoden innebär pumpning, mätning on-line och regelbunden vattenprovtagning för kemiska analyser i avgränsade borrhålssektioner under cirka tre veckor per sektion och vid ett pumpflöde på mellan 50 och 270 mL/min.

Denna rapport presenterar resultat från sektion 641,5 till 650,6 m borrhålslängd (vertikalt djup 576,0 till 583,9 m) i borrhål KLX27A. Resultaten omfattar mätningar on-line av redoxpotential, pH, löst syre, elektrisk konduktivitet och vattentemperatur (i borrhålssektionen) liksom kemiska analyser av huvudkomponenter, spårelement och isotoper samt bestämning av gasinnehåll och sammansättning. Vidare undersöktes oorganiska och organiska kolloider (humus och fulvosyror) med fraktioneringsteknik, detektering genom laserinducerad nedbrytning (LIBD) och svep-elektronmikroskopi (SEM).

Vattensammansättningen i sektionen 641,5 till 650,6 m var stabil under pump/provtagningsperioden. Spolvattenhalten var mycket låg, 0,02 %, och kloridkoncentrationerna uppgick till ca 1 700 mg/L.

Redoxpotentialerna för de två relevanta borrhålelektroderna var inte helt stabila, och det sista uppmätta värdet var ca -190 mV.

Koncentrationen av kolloider mätt med LIBD uppgick till mellan 230 och 330 µg/L. De kolloidala partiklarna bestod huvudsakligen av järn.

Contents

1	Introduction	7
2	Objectives and scope	9
3	Background	11
3.1	Flushing water history	11
3.2	Previous activities in the borehole	12
3.3	Choice of borehole sections	12
4	Equipment	13
4.1	The mobile field laboratory	13
4.2	Equipment for enrichment of humic and fulvic acids	15
4.3	Equipment for fractionation of humic and fulvic acids	15
5	Performance	17
5.1	General	17
5.2	Chemical characterisation	17
5.2.1	Overview of field work procedure	17
5.2.2	Performance in section 641.5 to 650.6 m	18
5.3	Water sampling, sample treatment and analyses	20
5.4	Collection of <i>in situ</i> water samples	20
5.5	Enrichment of humic and fulvic acids	21
5.6	Fractionation of humic and fulvic acids	21
5.7	Nonconformities	22
6	Data handling and interpretation	23
6.1	Chemmac measurement data	23
6.1.1	Data file types and calculation software	23
6.1.2	Calculations and evaluation of pH and redox potential	23
6.2	Water analysis data	24
6.3	Data from special sampling methods	26
6.3.1	Dissolved gases	26
6.3.2	Enrichment of humic and fulvic acids	26
6.3.3	Fractionation of humic and fulvic acids	26
7	Results	27
7.1	Chemmac measurements	27
7.2	Water analyses	28
7.2.1	Basic water analyses	28
7.2.2	Trace elements (rare earth metals and others)	31
7.2.3	Stable and radioactive isotopes	31
7.3	Dissolved gas	32
7.4	Colloids	33
7.4.1	Inorganic colloids – LIBD (Laser Induced Breakdown Detection)	34
7.4.2	Inorganic colloids – fractionation	34
7.5	Humic and fulvic acids – fractionation	35
8	Summary	37
9	References	39

Appendix 1	Design of cored borehole KLX27A	41
Appendix 2	Selected results from difference flow logging in KLX27A	43
Appendix 3	Selected images from BIPS logging in KLX27A	45
Appendix 4	Measurement information, KLX27A	47
Appendix 5	Flow and pressure measurements, KLX27A	53
Appendix 6	Chemmac measurements in KLX27A, section 641.5 to 650.6 m	55
Appendix 7	Sampling and analytical methods	59
Appendix 8	Quantification of Colloids in Natural Groundwater from Laxemar Borehole KLX27A, Section (641.5 to 650.56) m	63
Appendix 9	Compilation of water analysis data	75

1 Introduction

This document reports performance of and results from the activity *Complete chemical characterisation* in the cored borehole KLX27A performed within the Oskarshamn site investigation area /1, 2, 3/. The work was conducted according to the activity plan AP PS 400-08-008. The report presents hydrogeochemical data from field work carried out during the period of March to June 2008.

The controlling documents for the activity are listed in Table 1-1. The activity plan, the method description and the measurement system descriptions constitute SKB's internal controlling documents. The obtained data from the activity are reported to the SICADA database and are traceable by the activity plan number. Sampling for microbe studies was also performed within the present activity. The microbe investigations are reported in a separate primary data report /4/.

Borehole KLX27A is a 650.6 m long telescopic borehole drilled at Laxemar and inclined 65° from the horizontal plane. The interval 0 to 75.6 m is percussion-drilled with a diameter of c. 200 mm and the interval 77.0 to 650.6 m is core-drilled with a diameter of 76 mm. The percussion borehole HLX10 served as the source of flushing water for the drilling of KLX27A. The location of KLX27A is shown in Figure 1-1. The borehole design of KLX27A is presented in Appendix 1. The borehole is of the so-called SKB chemical-type, see method descriptions MD 620.003 (Method description for drilling cored boreholes) and MD 610.003 (Method description for percussion drilling, Table 1-1). A SKB chemical-type borehole requires that cleaning procedures are carried out on all downhole equipment to be used in the borehole, both during and after drilling, according to level 2 in the cleaning instructions outlined in MD 600.004 (Instruktion för rengöring av borrhålsutrustning och viss markbaserad utrustning, Table 1-1.)

Table 1-1. Controlling documents for performance of the activity.

Activity plan	Number	Version
Fullständig kemikaraktärisering i KLX27A.	AP PS 400-08-008	1.0
Method description	Number	Version
Metodbeskrivning för fullständig kemikaraktärisering med mobilt fältlaboratorium.	SKB MD 430.017	2.0
Measurement system descriptions		
Instruktion för rengöring av borrhålsutrustning och viss markbaserad utrustning.	SKB MD 600.004	1.0
Mätsystembeskrivningar för mobil kemienhet allmän del, slangvagn, borrhålsutrustning, mobil ytChemmac och dataapplikation.	SKB MD 434.004 SKB MD 434.005 SKB MD 434.006 SKB MD 434.007 SKB MD 434.018	1.0 1.0 1.0 1.0 1.0
Mätsystembeskrivning för fraktionering av humus- och fulvosyror.	SKB MD 431.043	
Mätsystembeskrivning för kolloidfiltreringssystem, handhavandedel.	SKB MD 431.045	In progress
Instructions		
Provtagning och analys-kemilaboratorium.	SKB MD 452.001-019	–

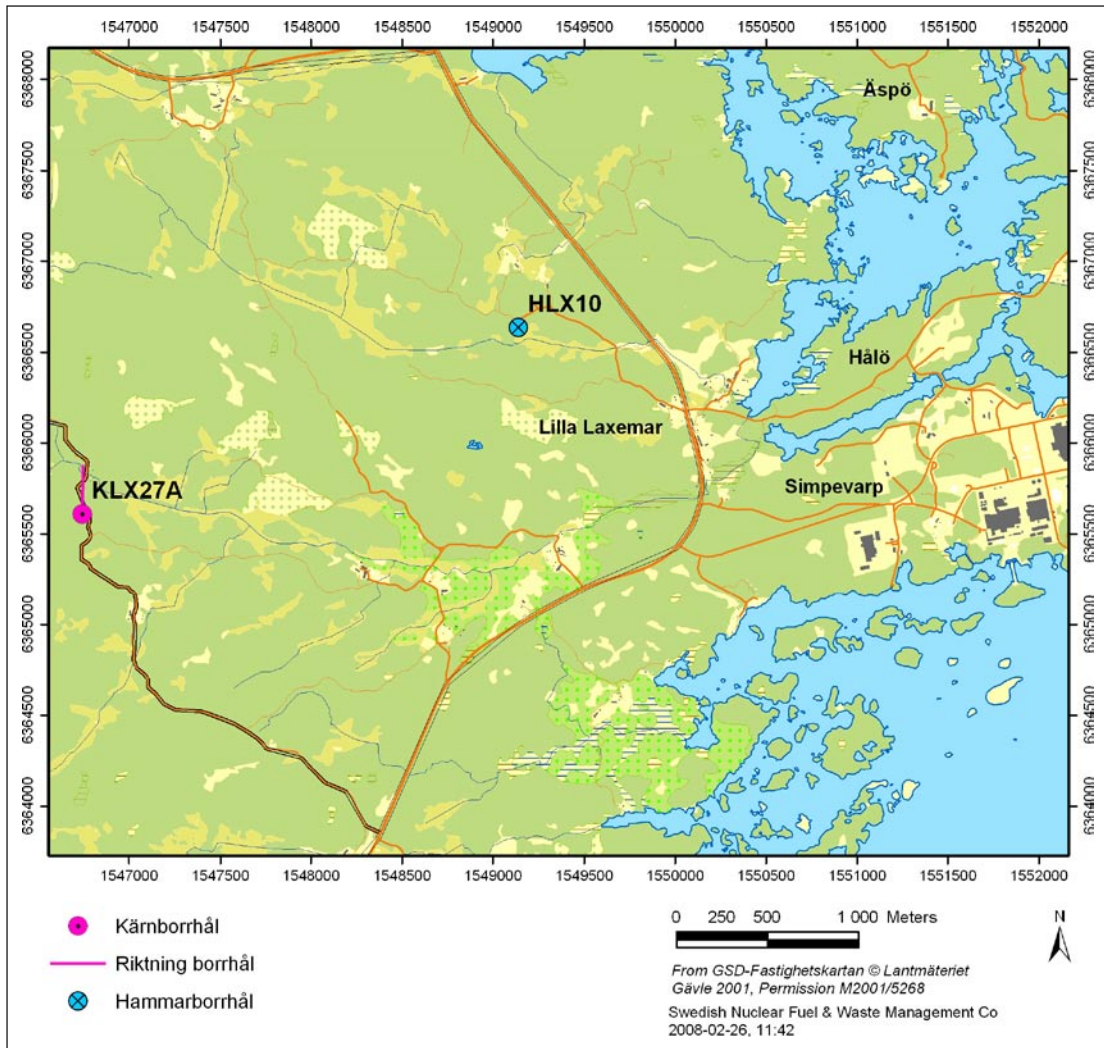

Figure 1-1. Locations of the core-drilled borehole KLX27A and the percussion-drilled borehole HLX10, which served as the source of flushing water for the drilling, within the Oskarshamn site investigation area.

2 Objectives and scope

Complete chemical characterisation is the most extensive chemical investigation method performed in core-drilled boreholes. The method is carried out in order to obtain as complete information as possible about the groundwater chemical conditions in individual water-bearing fractures or local minor fracture zones. Considerable effort is made to obtain representative samples from a limited rock volume. Careful pumping and continuous control of the pressure in the sampled borehole section, as well as above the section, is maintained in order to minimise the risk of mixing with groundwater from other fracture systems.

The analytical programme was carried out according to SKB chemistry class 4 and class 5 including all options except for uranium and thorium isotopes, analysed only on the last sample /1/. Furthermore, pH, redox potential (Eh) and water temperature were measured in flow-through cells downhole as well as at the ground surface. The flow-through cell at the surface also measured electrical conductivity and dissolved oxygen. In addition, samples were collected *in situ* in the borehole section for determination of gas content and composition, microbe content /4/ and their characterisation as well as for determination of colloid content by LIBD and SEM techniques. Fractionation of organic acids and inorganic species was performed in order to investigate size distribution (DOC and ICP analyses), and enrichment of organic acids was conducted in order to determine $\delta^{13}\text{C}$ and pmC in organic constituents.

3 Background

3.1 Flushing water history

The core drilling /5/ of the 650.6 m long borehole consumed 564 m³ of flushing water and the volume of returned water pumped from the borehole by air-lift pumping during drilling was 1,920 m³.

Uranine was added automatically to the flushing water tank that supplies flushing water to the drilling head. The uranine concentration in the flushing water and returned water was checked regularly and a total of 90 samples of each were analysed. The uranine concentrations in the flushing water and in the returned water are presented in Figure 3-1. The amounts of uranine added to the borehole via the flushing water and the estimated amount recovered in the return water, respectively, are given in Table 3-1.

Table 3-1. Amount of uranine added to KLX27A via the flushing water during core drilling and the amount recovered from the air-lift pumping.

Uranine	(g)
Added, calculated from the average uranine concentration added and the total volume of flushing water.	130
Recovered, estimated from the average uranine concentration recovered and the total volume of returned water.	261

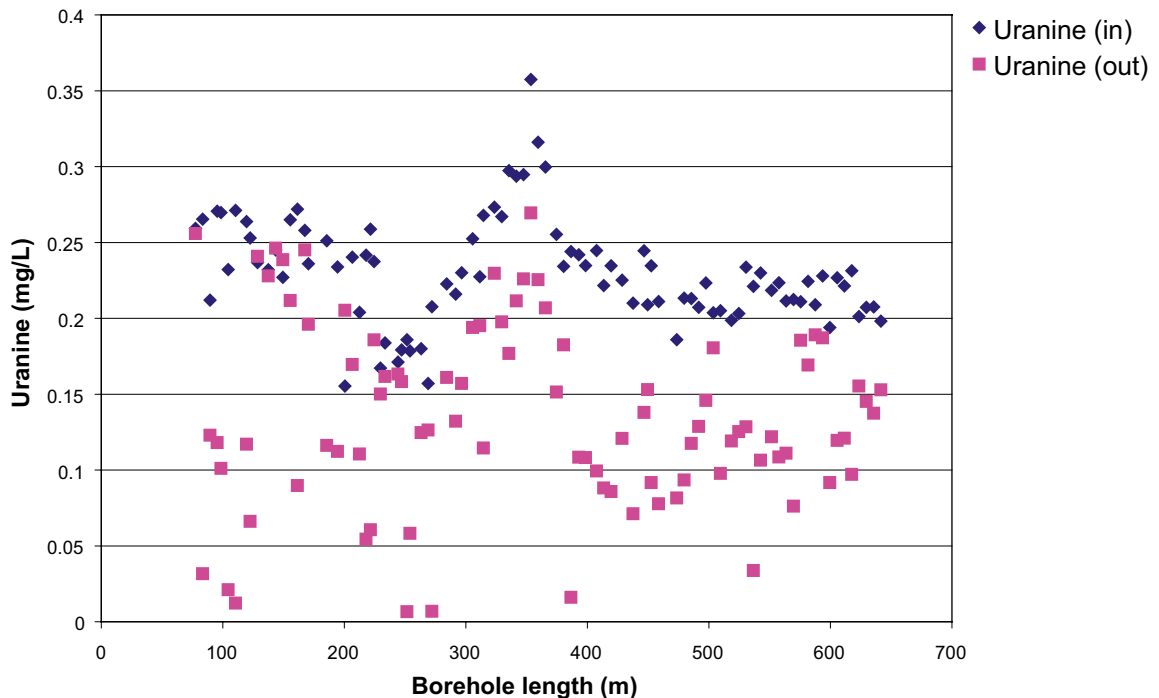

Figure 3-1. Uranine concentrations in the flushing water and in the recovered water versus borehole length.

The uranium budget in Table 3-1 suggests that no flushing water has been lost to the borehole and the adjacent host bedrock during drilling, which is unusual. The value of returned flushing water in this borehole is very uncertain and since a higher amount of uranium cannot be recovered from the borehole than added to it, the uranium budget is in this case considered unreliable.

3.2 Previous activities in the borehole

KLX27A is a SKB chemistry-type core borehole intended for *Complete chemical characterisation*. Only activities that are necessary in order to select borehole sections are carried out in the borehole prior to the chemistry campaign. The more downhole equipment used in the borehole, the greater is the risk of contamination and effects on, for example, the *in situ* microbiological conditions. The activities/investigations performed in KLX27A prior to the chemistry campaign are listed in Table 3-2 below.

3.3 Choice of borehole sections

The main objective for the *complete chemical characterisation* in KLX27A was to investigate the groundwater at repository depth (c. 400 to 550 m).

Section 641.5 to 650.6 m, vertical depth 576.0 to 583.9 m, was selected because of its location near repository depth (borehole inclination 61%) and was the primary choice. The flow yield was high and the pumping was carried out without any significant drawdown.

The difference flow logging for the relevant part of the borehole is presented in Appendix 2 and the corresponding images from BIPS-logging (Borehole Image Processing System) are presented in Appendix 3.

Table 3-2. Activities performed in KLX27A prior and in connection to the chemical characterisation.

Activity	Date of completion	Length or section (m)	Reference
Percussion drilling	2007-08-27	0.16–75.60	
Core drilling	2007-11-21	75.60–650.56	/5/
BIPS-logging	2007-12-06	14.00–646.00	/6/
Difference flow logging	2008-01-09	10.40–646.15	/7/
Injection tests	2008-02-09	77.30–650.56	/8/
Geophysical logging	2008-02-19	0.00–649.90	/9/

4 Equipment

4.1 The mobile field laboratory

The mobile field laboratories used by SKB for water sampling and downhole measurements consist of a laboratory unit, a hose unit with downhole equipment and a Chemmac measurement system, Figure 4-1; the system is presented schematically in Figure 4-2. It is also possible to include a separate unit for computer work (MYC). The different parts of the system are described in the SKB internal controlling documents SKB MD 434.004, 434.005, 434.006, 434.007 and SKB MD 433.018 (Mätsystembeskrivningar för mobil kemienhet allmän del, slangvagn, borrhålsutrustning, mobil ytChemmac och dataapplikation).

The Chemmac measurement facilities include communication systems, measurement application and flow-through cells with electrodes and sensors at the ground surface (surface Chemmac) and downhole (borehole Chemmac).

The downhole equipment comprises inflatable packers, pump, borehole Chemmac and the *in situ* sampling unit (PVP), allowing measurement and sampling *in situ* in the borehole section. The four sampled portions of groundwater collected with the PVP sampling unit maintain the pressure from the borehole section when raised to the surface. The portions are used for colloid and gas analyses and for microbe investigations.

The mobile units used for the investigation of borehole KLX27A consisted of the hose unit S2, the laboratory unit L2 and the computer unit MYC 2 including surface Chemmac.



Figure 4-1. The mobile units used at KLX27A; (from left to right) hose unit with downhole equipment, laboratory unit, container for collecting the water from the borehole and a unit for computer work.

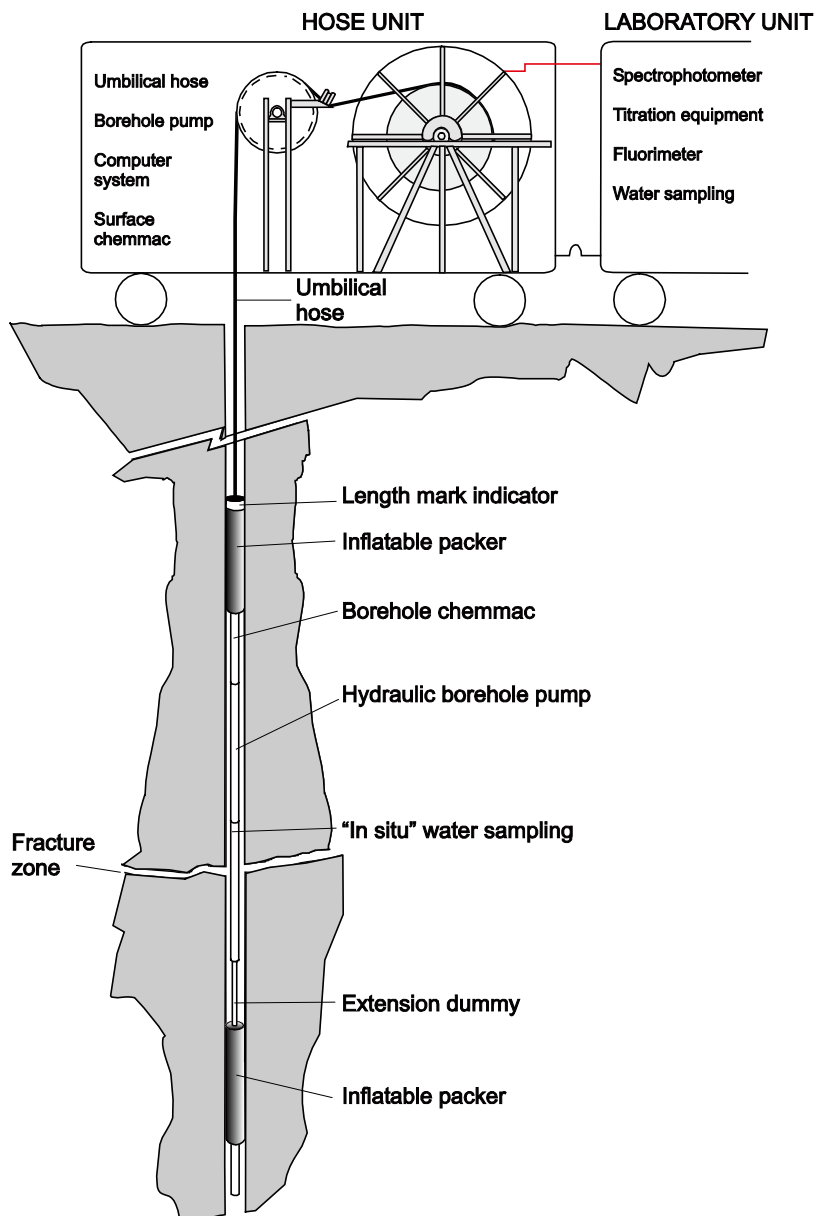

Figure 4-2. The mobile laboratory including laboratory unit, hose unit and downhole equipment. The configuration of the downhole units in the borehole can be varied depending on desired section length. However, the in situ water sampler must always be positioned first in the sample water path.

4.2 Equipment for enrichment of humic and fulvic acids

Enrichment of humic and fulvic acids is conducted in order to collect enough material to determine $\delta^{13}\text{C}$ and pmC (percent modern carbon) on organic constituents in the groundwater. The equipment for enrichment includes a porous column filled with an anion exchanger (DEAE-cellulose) and a textile filter with a well-defined pore size. The textile filter is placed inside the column in order to prevent the ion exchange resin from diffusing through the column. The equipment and performance is described in SKB MD 431.044 (Mätssystembeskrivning för uppkoncentrering av humus- och fulvosyror, SKB internal controlling document). Figure 4-3 shows the equipment setup. Since the ion exchange resin in the column creates a counter-pressure, which disturbs the water flow through the surface Chemmac, a pump was used for pumping a portion of the outlet water through the column (approximately 3.5 L/hour).

4.3 Equipment for fractionation of humic and fulvic acids

The equipment consists of membrane filters with a defined cut-off (pore size), a membrane pump, flexible tubing and vessels. Generally, one water sample from each section is filtered through two filters with different pore sizes (1,000 D and 5,000 D, D=Dalton, 1D=1 g/mol). The equipment and performance are described in SKB MD 431.043 (Mätssystembeskrivning för fraktionering av humus- och fulvosyror, SKB internal controlling document).

Figure 4-4 shows the equipment setup.

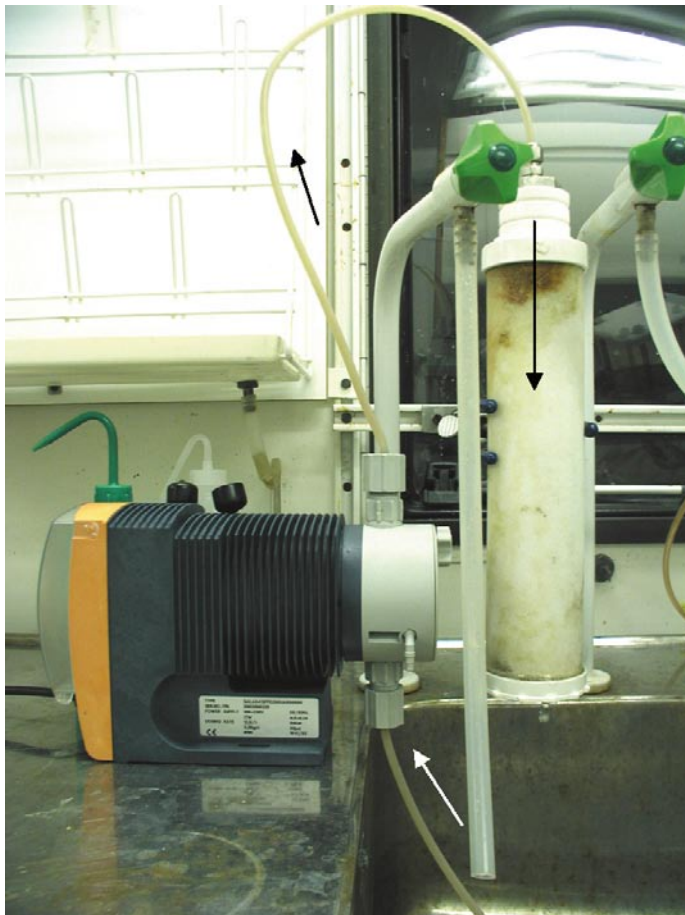

Figure 4-3. The ion exchange column. The arrows show the water flow direction.

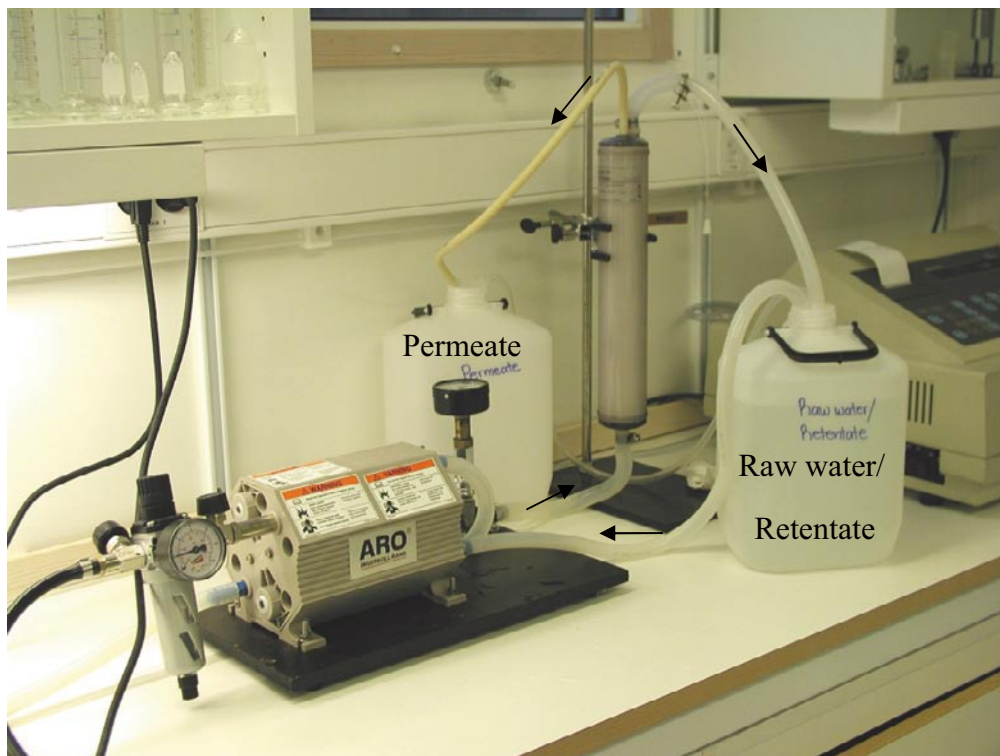

Figure 4-4. Equipment for fractionation of humic and fulvic acids.

5 Performance

5.1 General

Chemical characterisation in borehole KLX27A was conducted according to activity plan AP PS 400-08-008 following the method described in the SKB internal controlling document MD 430.017 (Metodbeskrivning för fullständig karakterisering med mobilt fältlaboratorium), Table 1-1. Table 5-1 gives an overview of the investigation sequence in KLX27A.

5.2 Chemical characterisation

5.2.1 Overview of field work procedure

A short chronological summary of the different steps that constitute chemical characterisation of groundwater in a borehole section is given below. Preparations before the downhole equipment is lowered in the borehole include:

- Cleaning of the inside of the umbilical hose (the sample water channel) with de-ionised and de-oxygenated water. Finally, the sample water channel is filled with de-ionised and de-oxygenated water prior to lowering.
- Cleaning and preparation of the four sample containers (PVB) belonging to the *in situ* water sampling unit (PVP). The containers are cleaned on the outside using 70% denatured ethanol and on the inside using chlorine dioxide. One of the containers is used for microbe sampling and sterile conditions are desirable. The containers are purged with nitrogen gas and a small nitrogen gas pressure is maintained in the containers. The magnitude of the pressure depends on the depth of the section to be sampled.
- Calibration of the pH and redox electrodes in the borehole Chemmac.

The different downhole units are assembled during lowering of the equipment in the borehole and the following steps are taken:

- The outside of the umbilical hose is cleaned with 70% denatured ethanol (SKB MD 600.004; SKB internal controlling document, Table 1-1).
- Calibration of the umbilical hose length is conducted at least once for each borehole. For this, a length mark detector unit (calliper) is mounted together with the downhole equipment. The length mark detector indicates length calibration marks milled into the borehole wall at almost every 50 m along the borehole. At each indication, a reading is made of the corresponding length mark on the umbilical hose. The correct distance to each length mark is obtained from the SICADA database.

Table 5-1. Investigation sequence in KLX27A.

Start date/Stop date	Section (m)	Comment
2008-03-10/2008-06-09	641.5 to 650.6	Pumped volume = 24.6 m ³ Flow rate approx. 170 to 280 mL/min

When the pump is started and the packers are inflated at the desired positions in the borehole, a pumping and measurement period begins. Typical measures taken and activities carried out during this period are:

- Calibration of the pH and redox electrodes as well as the electrical conductivity and oxygen sensors in the surface Chemmac is conducted when the pumped water from the borehole section has reached the surface.
- Careful attention is paid to ensure that the packed off section is well isolated from the rest of the borehole. A significant drawdown in the section during pumping is one indication that the section is properly sealed off. Leakage would cause pumping of water from the borehole column above and/or below the packers and not only from the fracture zone of interest. However, the drawdown in the borehole section must not be too large, because the greater the drawdown, the larger the bedrock volume affected by the pumping and the risk of mixing with groundwater from other shallower and/or deeper fracture systems increases. The pumping flow rate is adjusted depending on the flow yield from the fracture or fracture zone (to between 50 and 300 mL/min) and maintained more or less constant during the pumping and measurement period.
- Water samples are collected regularly once or twice a week during the pumping period. Changes in water composition are monitored by measuring pH and conductivity and by immediate analyses (pH, uranine, chloride, alkalinity, ammonium, ferrous and total iron).
- A decision when to terminate the sampling work in the section is made during a suitable stage of the pumping and measurement period. The investigation might be prolonged if the concentration of flushing water exceeds 1% or if the redox potential measurements have not reached stable values. A final SKB Class 5 sample including all options is collected the day before termination.

Completion of the investigation in the section and lifting of the downhole equipment entails:

- Collection of *in situ* samples prior to lifting the equipment. The valves to the PVB sampling containers in the borehole section are opened in order to rinse the system and fill the containers. After a few hours the valves are closed and the water sample portions for analyses of colloids, dissolved gases and microbes are secured.
- Following stopping of the borehole pump and deflation of the packers, the equipment is lifted and the different downhole units are dismantled.
- Calibration of the electrodes in the borehole Chemmac and surface Chemmac.

The following section (5.2.2) shortly describes the performance in the section. The main activities are presented in the events table together with SKB sample numbers of the corresponding water samples.

5.2.2 Performance in section 641.5 to 650.6 m

The chemical characterisation in section 641.5 to 650.6 m was performed using the following configuration of the downhole equipment in the borehole. From the top: umbilical hose, length mark detector, borehole Chemmac, borehole pump, upper packer and *in situ* water sampler (PVP), see Appendix 4. The pressures above and within the section were measured using the borehole Chemmac unit and the PVP water sampling unit, respectively.

The pumping flow rate was about 170 to 280 mL/min and the drawdown was insignificant at the end of the measurement period (maximum 0.4 m by the end of the first pumping period). The turnover time (time for one exchange of the water volume in the borehole section) corresponds to c. 12 hours at the current flow rate and 150 borehole section volumes had been exchanged by the end of the investigation period. Diagrams showing the pressures above and within the borehole section and the flow rate during the pumping/measurement period are presented in Appendix 5. Diagrams showing the results from the measurements of redox potential (Eh), pH, electric conductivity, dissolved oxygen and water temperature are shown in Appendix 6. The events during the investigation are listed in Table 5-2.

Table 5-2. Events during the pumping/measurement period in section 641.5 to 650.6 m.

Date	Event	Sample no.
080310	Calibration of borehole Chemmac	
080311	Lowering of downhole equipment S2 (641.50 to 650.56 m) Start of borehole pump	
080312	Start of Chemmac measurements Water sampling: uranine Calibration of surface Chemmac	15427
080314	Water sampling: SKB class 2 Humic and fulvic acids; enrichment start	15471
080318	Water sampling: SKB class 5	15424
080319	Water sampling: SKB class 4	15425
080320	Stop of borehole pump due to broken spring	
080326	Lifting Replacement of borehole pump Calibration of borehole Chemmac Exchange of borehole probe due to malfunction of pH electronics Polishing of borehole electrodes	
080327	Polishing of borehole electrodes Calibration of borehole Chemmac Lowering of downhole equipment S2 (641.50 to 650.56 m)	
080328	Water sampling: SKB class 2	15428
080331	Water sampling: SKB class 5	15426
080403	Water sampling: SKB class 4	15429
080407	Water sampling: SKB class 5 Analysis of Ra/Rn cancelled due to laboratory closedown	15430
080410	Water sampling: SKB class 4	15431
080414	Humic and fulvic acids; fractionation 1,000 D Humic and fulvic acids; fractionation 5,000 D Discharge of borehole water due to open water tap in the collection tank	
080415	Water sampling: SKB class 5 ¹³ C, pmC, ³ H and ³⁷ Cl flasks were stored in a refrigerator and sent to the laboratory 2008-04-22	15432
080417	Water sampling: SKB class 4	15433
080418	Enrichment of humic and fulvic acids interrupted. The inner column was damaged during the procedure and the enrichment was stopped.	
080426	Stop of borehole pump due to broken spring	
080427	Lifting Calibration of borehole Chemmac Lowering of downhole equipment S2 (641.50 to 650.56 m)	
080428	Water sampling: uranine Calibration of surface Chemmac	15436
080430	Water sampling: SKB class 5 (analysis of pH, conductivity, alkalinity, F ⁻ , Br ⁻ , Cl ⁻ , SO ₄ ²⁻ , uranine, Fe ²⁺ , Fe-tot, NH ₄ ⁺ and HS ⁻). No Ra/Rn sampling	15434
080508	Stop of borehole pump due to broken spring	
080509	Lifting Exchange of borehole pump Lowering of downhole equipment S2 (641.50 to 650.56 m)	
080513	Water sampling: SKB class 5 (analysis of pH, conductivity, alkalinity, F ⁻ , Br ⁻ , Cl ⁻ , SO ₄ ²⁻ , uranine, Fe ²⁺ , Fe-tot, NH ₄ ⁺ , HS ⁻ and Ra-, Rn-isotopes)	15435
080515	Water sampling: SKB class 5 (analysis of pH, conductivity, alkalinity, F ⁻ , Br ⁻ , Cl ⁻ , SO ₄ ²⁻ , uranine, Fe ²⁺ , Fe-tot, NH ₄ ⁺ , HS ⁻ and Ra-, Rn-isotopes)	15437

Date	Event	Sample no.
080519	Water sampling: SKB class 5 (analysis of pH, conductivity, alkalinity, F ⁻ , Br ⁻ , Cl ⁻ , SO ₄ ²⁻ , uranine, Fe ²⁺ , Fe-tot, NH ₄ ⁺ , HS ⁻ and Ra-, Rn-isotopes)	15438
080522	Water sampling: SKB class 5 (analysis of pH, conductivity, alkalinity, F ⁻ , Br ⁻ , Cl ⁻ , SO ₄ ²⁻ , uranine, Fe ²⁺ , Fe-tot, NH ₄ ⁺ , HS ⁻ and Ra-, Rn-isotopes)	15558
080525	Loss of Chemmac measurements ~3 hours due to power failure. Restart of measurement application	
080527	Water sampling: SKB class 5 (analysis of pH, conductivity, alkalinity, F ⁻ , Br ⁻ , Cl ⁻ , SO ₄ ²⁻ , uranine, Fe ²⁺ , Fe-tot, NH ₄ ⁺ , HS ⁻ and Ra-, Rn-isotopes)	15559
080529	Water sampling: SKB class 5 (analysis of pH, conductivity, alkalinity, F ⁻ , Br ⁻ , Cl ⁻ , SO ₄ ²⁻ , uranine, Fe ²⁺ , Fe-tot, NH ₄ ⁺ , HS ⁻ and Ra-, Rn-isotopes)	15560
080603	Water sampling: SKB class 5 (analysis of pH, conductivity, alkalinity, F ⁻ , Br ⁻ , Cl ⁻ , SO ₄ ²⁻ , uranine, Fe ²⁺ , Fe-tot, NH ₄ ⁺ , HS ⁻ and Ra-, Rn-isotopes)	15561
080605	Water sampling: SKB class 5, including density. No Ra/Rn sampling	15587
080606	Stop of borehole pump due to broken spring	
080608	PVP-sampler: opening of valve at 14:01 Sampling for microbes, gases and colloids (analyses with LIBD and SEM)	
080609	PVP-sampler: closure of valve at 05:14 End of Chemmac measurements Lifting Calibration of borehole Chemmac Calibration of surface Chemmac	

5.3 Water sampling, sample treatment and analyses

The pumped water from the borehole section is led from the hose unit into the laboratory unit where sampling and sample filtration is carried out. Filtration of sample portions is performed on-line by connecting the filter holders directly to the water outlet. During the entire sampling procedure, laboratory gloves were used to minimize the risk of contaminating the samples. A water sample is defined as groundwater collected during one day and consists of several sample portions, labelled with the same sample number.

An overview of sample treatment and analysis methods is given in Appendix 7. The routines are applicable independently of sampling method or type of sampling object.

5.4 Collection of *in situ* water samples

The *in situ* water sampling was conducted successfully in the borehole section. The *in situ* sampling in the section was only performed once due to time constraints. Therefore dissolved gases was analysed only by one laboratory and the colloid filtration followed by ICP analyses was omitted. In addition filters from colloid filtration was analysed by SEM. The purpose of each sample portion is given in Table 5-3.

The PVB containers were all quality controlled before use. This procedure includes de-assembling the container, thorough cleaning, re-assembling and measurement of piston friction. After sampling the filled PVB containers were packed together with ice packs in insulated bags immediately at entering ground surface and sent to the laboratories by express delivery.

Table 5-3. Collection and purpose of *in situ* water sample portions in section 641.5 to 650.6 m.

Sample portion no.	Section 641.5 to 650.6 m 2008-06-09
1	Microbes
2	Colloids (LIBD, SEM)
3	Dissolved gas, N ₂
4	Colloids (LIBD, SEM)

5.5 Enrichment of humic and fulvic acids

Enrichment of humic and fulvic acids was conducted in order to collect enough material to determine $\delta^{13}\text{C}$ and pmC in organic constituents in the groundwater. The method is described in the SKB internal controlling document SKB MD 431.044 (Mätssystembeskrivning för uppkoncentrering av humus- och fulvosyror), Table 1-1. The enrichment method entails collection of organic acids on an ion exchanger, elution of the resin and evaporation of the resulting solution. The dry residue is used for isotope determination and a minimum amount of 10 mg organic carbon is needed. In addition to organic material, the residue also contains sodium hydroxide from the elution. The sample is acidified in order to prevent the formation of carbon dioxide.

Estimations of total duration and water volume through the ion exchanger for the section are given in Table 5-4.

5.6 Fractionation of humic and fulvic acids

Humic and fulvic acids were fractionated with respect to molecular weight using an ultra-filtration technique. The method is described in SKB MD 431.043 (Mätssystembeskrivning för fraktionering av humus- och fulvosyror, SKB internal controlling document).

Sampled water from the investigated sections was first filtered through a 0.45 μm filter and then filtered through membrane filters with cut-off sizes of 1,000 D and 5,000 D, respectively. The initial water volume, prior to filtration, was approximately 5 litres. The final retentate and permeate volumes following the filtration runs were approximately 1 and 4 litres, respectively, which gave an enrichment factor of five in the retentate.

Water samples were collected from the retentate and permeate as well as from the untreated groundwater. Each sample was analysed for dissolved organic carbon (DOC), major constituents and common trace metals. The analyses of metal ions should indicate if metals such as Al, Si, Mn and Fe exist as colloidal species.

Table 5-4. Enrichment time and water volume through the ion exchanger.

Borehole section [m]	Duration of enrichment [days]	Volume through ion exchanger [L]
641.5 to 650.6 m	22	1,915

5.7 Nonconformities

The *Complete chemical characterisation* in KLX27A has been conducted according to the SKB internal controlling documents AP PS 400-08-008 and SKB MD 430.017 with the following deviations and remarks:

- Extended period of Chemmac measurements.
- Some equipment malfunctions were encountered during the investigation:
 - broken spring in borehole pump (2008-03-20, 2008-04-26, 2008-05-08 and 2008-06-06)
 - exchanged borehole probe due to malfunction of borehole pH electrodes
 - loss of connection with the borehole Chemmac due to power failure
- No samples were sent for analysis of ^{13}C and pmC in inorganic constituents due to low alkalinity.
- SKB sample number 15430 (sampling date 2008-04-07): analysis of Ra/Rn was cancelled due to laboratory closedown.
- Discharge of borehole water due to open water tap in the collection tank (2008-04-14).
- SKB sample number 15432 (sampling date 2008-04-15): Flasks intended for analysis of ^3H and ^{37}Cl were stored in a refrigerator and sent to the laboratory 2008-04-22.
- Radon and radium for two of the “SKB class 5” samples (15434 and 15587) were not analysed due to transportation problems.
- Enrichment of humic and fulvic acids was interrupted 2008-04-18. The inner column was damaged during the procedure and the enrichment was stopped.
- Loss of Chemmac measurement ~3 hours (2008-05-25) due to power failure.
- The *in situ* sampling in the section was performed only once due to time constraints. Therefore one of the two gas samples and the colloid filtration followed by ICP analyses were omitted.
- The planned last sample (2008-06-08), including the control sample and the sample for analysis by a second laboratory, was cancelled due to the pump stop 2008-06-06 and the sample from 2008-06-05 is considered as the last sample.
- The sampling procedure for the *in situ* sampling was performed when the pumping had been stopped for three days. The long pump stop time caused a deterioration of the quality of the sampled water, possibly because of stratification of the stagnant borehole water.

6 Data handling and interpretation

6.1 Chemmac measurement data

The processing of Chemmac data are described in SKB MD 434.007-02 (Mätssystembeskrivning för Chemmac mätsystem, SKB internal controlling document, in progress).

6.1.1 Data file types and calculation software

The on-line measurements in a borehole section produce the following types of raw data files:

- Calibration files from calibration measurements (*.CRB) and corresponding comment files (*.CI). The files are used for calculation of calibration constants (pH and Eh) and the calibration factor (electrical conductivity). For surface Chemmac ten *.CRB and ten *.CI files are produced, and for borehole Chemmac six *.CRB and six *.CI files.
- Raw data file containing the logged measurements from the borehole section and the surface (*K.MRB) as well as a corresponding comment file (*.MI). The logged voltage values need to be converted to pH and Eh values (also in mV) using the calibration constants obtained from calibration.
- Measurement file including equipment and environment parameters (*O.MRB), such as power consumption in the downhole Chemmac unit and temperature inside the hose unit.

The original raw data files listed above are stored in the SICADA file archive. Furthermore, the files are re-calculated and evaluated to obtain pH and redox potential values and to correct the electrical conductivity values using the specially designed calculation software (Hilda). The resulting files containing calculated and evaluated values as well as comments on the performance are:

- A file **constants.mio* containing all of the calculated calibration constants (one constant for each electrode in each buffer solution). The file is stored in the SICADA file archive and is useful in order to follow the development of single electrodes.
- A file **measurements.mio* containing the calculated and evaluated measurement values (pH, redox potential, electrical conductivity and water temperature). The data from the file are exported to the data tables “redox” and “ph_cond” in SICADA. As the file also contains some measured parameters that are not included in the tables mentioned above (e.g. pressure registrations) the complete file is also stored in the SICADA file archive.
- A file **comments.mio* containing comments on the field work and the calculation/evaluation. The comments in the file are imported as activity comments in SICADA.

6.1.2 Calculations and evaluation of pH and redox potential

The redox potential is measured by three electrodes at the surface and three in the borehole section. In addition, pH is measured using two electrodes at the surface and two in the borehole section. The registrations from the redox and the pH electrodes are logged each hour during a measurement period of approximately three weeks and a calibration is performed before and after the measurement period. The treatment of the raw data includes the following steps:

- Calculation and choice of calibration constants.
- Calculation of one pH and one redox potential sequence for each electrode (i.e. three or six redox electrodes and two or four pH electrodes).
- Determination of representative pH and redox potential values as well as estimated measurement uncertainties for the investigated borehole section.

One calibration constant is selected for each electrode using one of the following alternatives:

- Case 1: Calculation of the average calibration constant value and the standard deviation. The initial and the final calibration measurements results in four constants for each redox electrode (in pH 4 and pH 7 buffer solutions) and six constants for each pH electrode (in pH 4, 7 and 10 buffer solutions).
- Case 2: The calibration constant obtained from the initial calibration measurement at pH 7 is selected because it is closest to the pH of the borehole water. This alternative is chosen if the calibration constants obtained in the different buffers show a large variation in value (generally a difference larger than 20 mV between the highest and the lowest value). The standard deviation is calculated in the same way as in Case 1.
- Case 3: If the final calibration constants turn out to be very different (more than 20 mV) from the initial constants, a linear drift correction is needed. The reason is most often a drift in the reference electrode. The values and standard deviations are calculated for the initial and the final calibration constants separately and a linear correction is made between the selected initial and the selected final constant. The higher of the two standard deviation values is used in the estimation of the total measurement uncertainty.

The values in the measurement raw data file are converted to pH and Eh measurement sequences for each pH and redox electrode using the calibration constant selected as stated above.

The next step is to choose a logging occasion in a stable part of the measurement period and select a representative result for each electrode. The average values are calculated for each electrode group in order to obtain one representative value of redox potential, pH (borehole Chemmac) and pH (surface Chemmac), respectively. Electrodes giving obviously erroneous values are excluded from the calculations. The corresponding total measurement uncertainties are estimated using the standard deviations of the calibration constants and the standard deviations of the Eh and the pH values obtained by the different sets of electrodes. It is useful to evaluate pH at the surface and pH in the borehole section separately, since pH in the pumped water might differ from the pH measured in the borehole section. This is due to changing gas pressure conditions and its effects on the carbonate system.

Factors considered when evaluating the measurement uncertainties in pH and redox potential (Eh) values are:

- Difference in calibration constants for each electrode and calibration/buffer solution.
- Drift in calibration constants between the initial and the final calibration.
- Stability in voltage value during the final part of the on-line measurement. A successful measurement shows no tendency of drift.
- Agreement between the different pH and redox electrodes on the surface and in the downhole borehole Chemmac.
- Number of electrodes showing reasonable agreement. Electrodes giving obviously erroneous values are excluded from the calculations.

6.2 Water analysis data

The following routines for quality control and data management are generally applied for hydrogeochemical analysis data, independently of sampling method or sampling object.

Some components are determined by more than one method and/or laboratory. Moreover, duplicate analyses by an independent laboratory are performed as a standard procedure on each fifth or tenth collected sample. All analytical results are stored in the SICADA database. The applied hierarchy path "Hydrochemistry/Hydrochemical investigation/Analyses/Water in the database" contains two types of tables, raw data tables and primary data tables (final data tables).

Data on *basic water analyses* are inserted into the raw data tables for further evaluation. The evaluation results in a final reduced data set for each sample. These data sets are compiled in a primary data table named “water composition”. The evaluation is based on:

- Comparison of the results from different laboratories and/or methods. The analyses are repeated if a large disparity is noted (generally more than 10%).
- Calculation of charge balance errors according to the equation below. Relative errors within $\pm 5\%$ are considered acceptable (in surface waters $\pm 10\%$).

$$\text{Relative error (\%)} = 100 \times \frac{\sum \text{cations (equivalents)} - \sum \text{anions (equivalents)}}{\sum \text{cations (equivalents)} + \sum \text{anions (equivalents)}}$$

- General expert judgement of plausibility based on earlier results and experience.

All results from *special analyses of trace metals and isotopes* are inserted directly into primary data tables. In cases where the analyses are repeated or performed by more than one laboratory, a “best choice” notation indicates the results that are considered most reliable.

An overview of the data management is given in Figure 6-1.

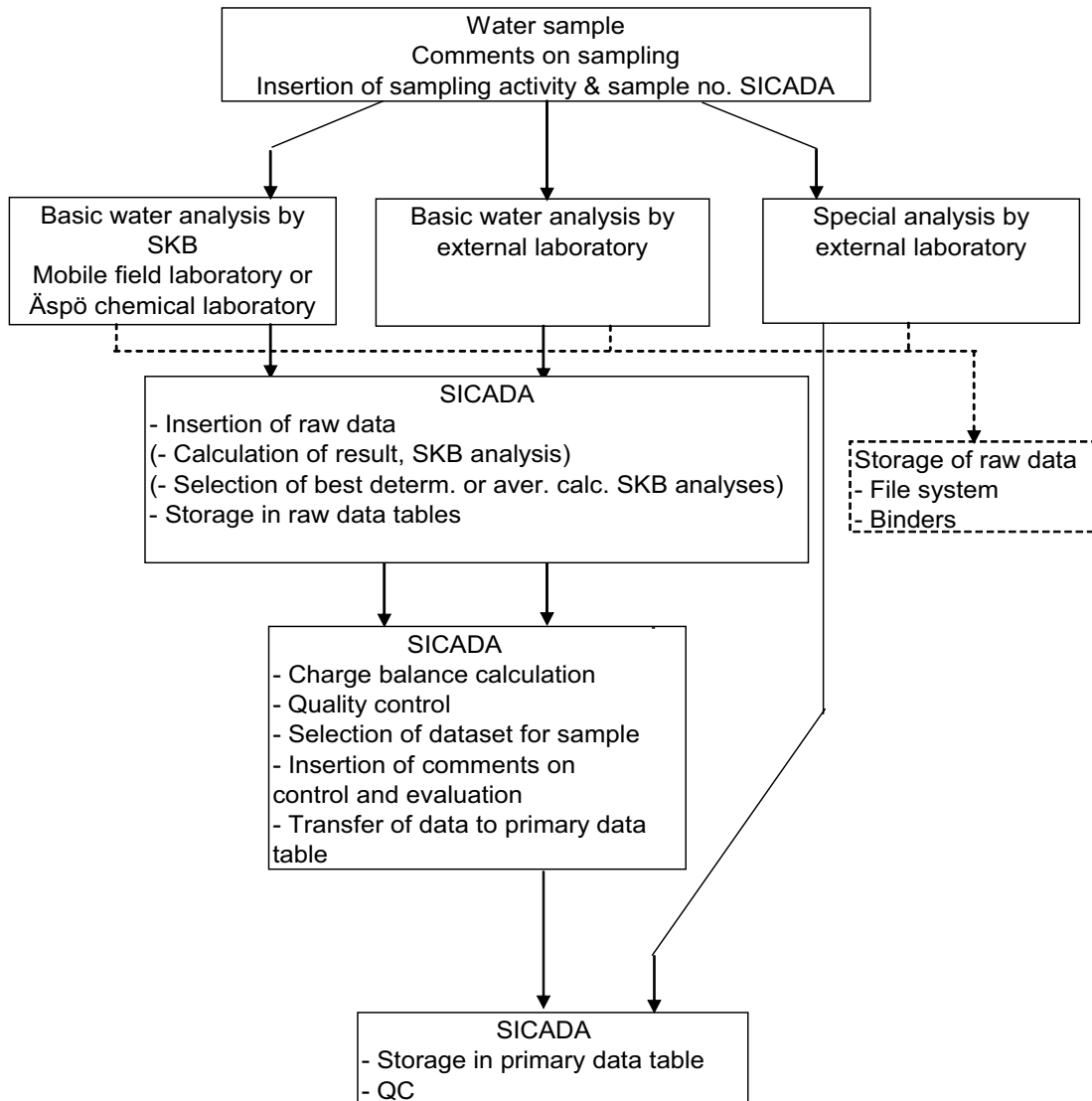

Figure 6-1. Overview of data management for hydrogeochemical data.

6.3 Data from special sampling methods

Special sampling methods include collection of *in situ* samples (colloid filtration and dissolved gases), enrichment and fractionation of humic and fulvic acids.

Separate sampling activities, methods and sample numbers are defined for data on dissolved gases, colloids, fractions of humic and fulvic acids and $\delta^{13}\text{C}$ and pmC determined on organic constituents. All analytical data are subjected to quality control and stored in the SICADA database.

6.3.1 Dissolved gases

The results of the gas analyses are stored in the primary data tables in SICADA.

6.3.2 Enrichment of humic and fulvic acids

The pmC and $\delta^{13}\text{C}$ values for enriched organic acids are stored in SICADA without processing or interpretation.

6.3.3 Fractionation of humic and fulvic acids

The concentrations of organic and inorganic constituents in the retentate and permeate are re-calculated to concentrations of each fraction of carbon and metal ions with molecular weight lower or higher than the cut-off size of the filter. This is done using mass balance equations as described in the SKB internal controlling document SKB MD 431.043, (Mätsystembeskrivning för fraktionering av humus- och fulvosyror). Comparison of the four concentration values from the two filters results in values for three fractions i.e. less than 1,000 D, 1,000 to 5,000 D and more than 5,000 D.

7 Results

Original data from the reported activity are stored in the primary database SICADA. Data are traceable in SICADA by the Activity Plan number (AP PS 400-08-008). Only data in databases are accepted for further interpretation and modelling. The data presented in this report are regarded as copies of the original data. Data in the databases may be revised, if needed. However, such revision of the database will not necessarily result in a revision of this report, although the normal procedure is that major data revisions entail a revision of P-reports. Minor data revisions are normally presented as supplements, available at www.skb.se.

7.1 Chemmac measurements

The data sequences of pH, Eh, electrical conductivity, oxygen and temperature values from the Chemmac measurements in borehole section 641.5 to 650.6 m are plotted versus time in Appendix 6. The measured time series were evaluated in order to obtain a representative value of pH, Eh, electrical conductivity and dissolved oxygen for the borehole as described in Section 6.1. Data were selected from the very last part of the measured time series (although the electrodes did not show completely stable values), marked with an arrow in the diagrams in the Appendices. The evaluated results from the measurements in the investigated sections are given in Table 7-1 together with the corresponding results from the LIBD measurements.

The redox potentials and pH of the electrodes in borehole Chemmac were consistent but not yet quite stable. Two borehole electrodes have been used in the calculation of an average Eh value, while all three electrodes were used for calculation of the measurement uncertainty. The recorded redox potentials from the on-line measurements were approximately -190 mV, while the measured redox potential from the LIBD experiment was -95 mV (container no 1). An explanation for the discrepancy could be the limited time of measurement in container no 1. However, in container no 2, the redox potential was 70 mV and considering also the results from the chemical analyses, the water in the container cannot be regarded as representative for the section. A possible reason for the difference in composition between sampled section water and water from the container is the long time (three days) between pump stop (due to broken spring) and the water sampling. The difference in salinity and dissolved anions between the samples could have developed because of stratification of the water over time. The surface electrodes showed positive and even increasing redox values, and were omitted in the calculations. Possible reasons are intrusion of air in the long umbilical hose leading water to the surface or gas bubbles on the electrode surfaces.

The pH-value was about 8.9. One of the borehole electrodes showed erroneous values and the second borehole pH electrode measured fluctuating values by the last third of the measurement period, shown in the graph in Appendix 6. However, most of the pH-values from the borehole electrode seem to be close to pH 8.9, which is consistent with the results from the surface electrodes and the laboratory pH measurements.

The oxygen electrode was affected when the equipment was lifted, but the oxygen value decreased again when the water was pumped.

Table 7-1. Evaluated results from the Chemmac and LIBD measurements in KLX27A.

Borehole section [m]	Electrical conductivity* [mS/m]	pH (borehole chemmac)**	pH (surface chemmac)**	Eh ** [mV]	Dissolved oxygen*** [mg/L]
641.5 to 650.6	547 ± 16	8.9 ± 0.8	8.9 ± 0.5	-189 ± 21 ^B	0.01 ± 0.01
PVB (LIBD)(1)****	553	–	7.74	-95	< 0.094
PVB (LIBD)(2)****	587	–	6.44	70	3.2

* The electrical conductivity is measured between 0 to 10,000 mS/m with a total uncertainty of 3%.

** Evaluated result and measurement uncertainty calculated as described in section 6.1.

*** Measurement interval 0 to 15 mg/L, resolution and measurement uncertainty ± 0.01 mg/L.

**** See Appendix 8.

^B = only values from borehole Chemmac have been used in the calculation.

7.2 Water analyses

7.2.1 Basic water analyses

The basic water analyses include the major constituents Na, K, Ca, Mg, S, Sr, SO₄²⁻, Cl⁻, Br⁻, Si and HCO₃⁻ as well as the minor constituents Fe, Li, Mn, DOC, F⁻, I⁻, HS⁻ and NH₄⁺. Furthermore, batch measurements of pH (lab-pH) and electrical conductivity (lab-EC) are included. Another important parameter is the flushing water content in each sample. The basic water analysis data and relative charge balance errors are compiled in Appendix 9, Table A9-1. Existing batch measurement values of pH and electrical conductivity are compared with the corresponding on-line Chemmac measurement values in Appendix 6.

The charge balance errors give an indication of the quality and uncertainty of the analyses of major constituents. The errors did not exceed ± 5%. A comparison between results from different laboratories and methods shows that the agreement is acceptable in most cases; in general less than 10% for each analysed constituent.

The flushing water content in the section was ~ 0.02% and should not exceed 1% in order for a sample to be considered representative for the groundwater. The flushing water content is calculated using the average uranine concentration in the added flushing water during core drilling of the sampled fracture zone.

The concentration levels of sodium, calcium and chloride are presented in Figure 7-1. The concentrations of all major constituents were constant during the pumping and sampling period.

The iron concentrations determined by ICP-AES (total Fe) and by spectrophotometry (Fe (+II) and Fe-tot) are compared in Figure 7-2. The total iron concentrations determined by ICP agree reasonably well with the results obtained by spectrophotometry in most cases, considering the very low concentrations.

Sulphate analysed by ion chromatography (IC) is compared with sulphate determined as total sulphur by ICP-AES in Figure 7-3. The sulphate concentrations remained constant during the pumping and sampling period. The IC results are somewhat lower than the ICP results in all of the samples but within the uncertainty of the measurements.

The chloride concentrations are plotted versus the corresponding electrical conductivity values in Figure 7-4. The plot gives a rough check of the data. As shown, the data from the borehole section agree well with data obtained from earlier investigations at the Äspö Hard Rock Laboratory.

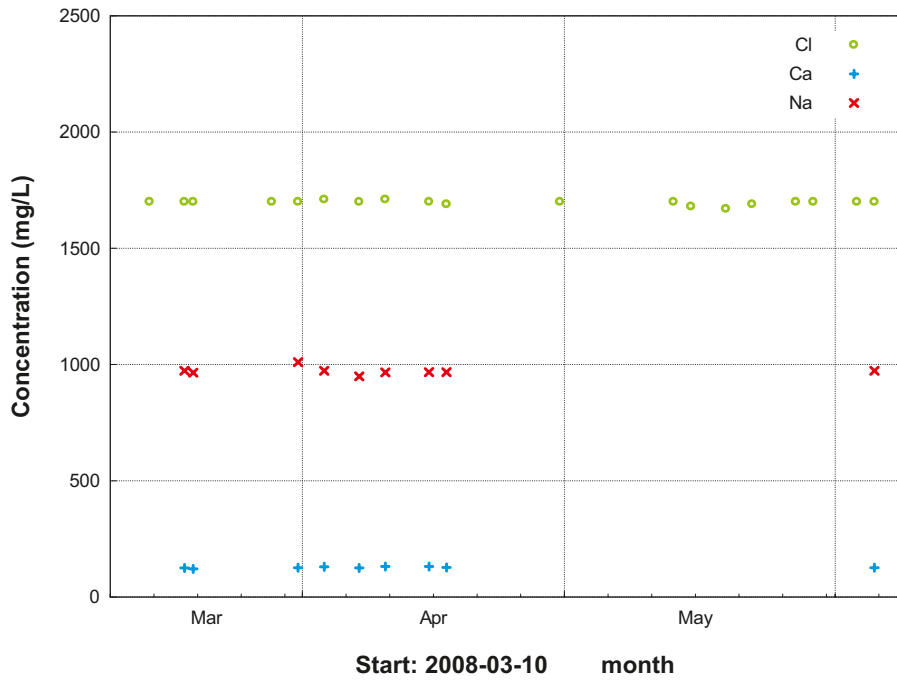

Figure 7-1. Chloride, calcium and sodium concentrations from sample series at 641.5 to 650.6 m in borehole KLX27A.

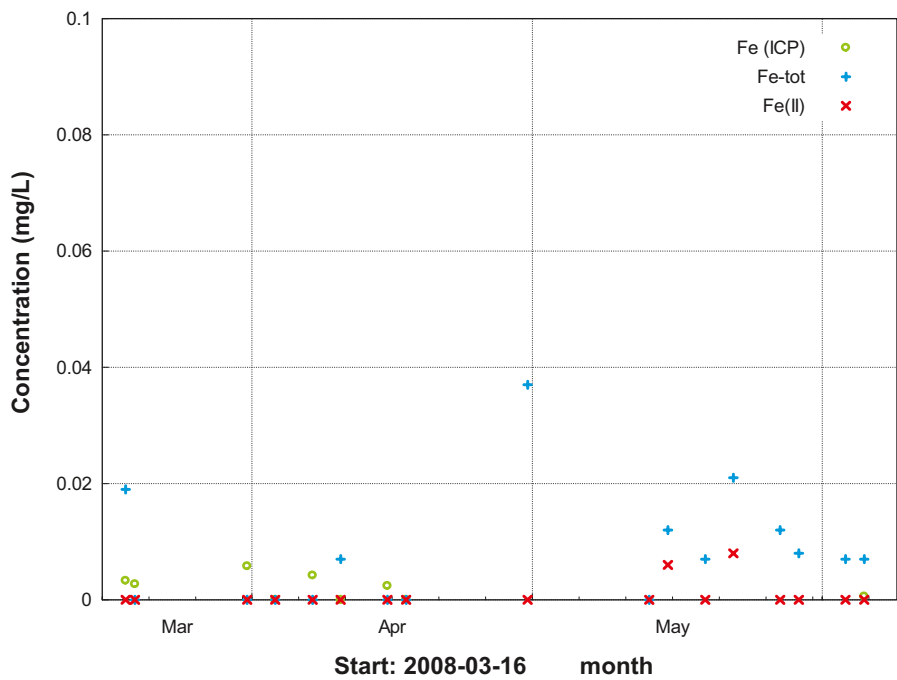

Figure 7-2. Comparison of iron concentrations obtained by ICP-AES and by spectro-photometry, borehole section 641.5 to 650.6 m in borehole KLX27A.

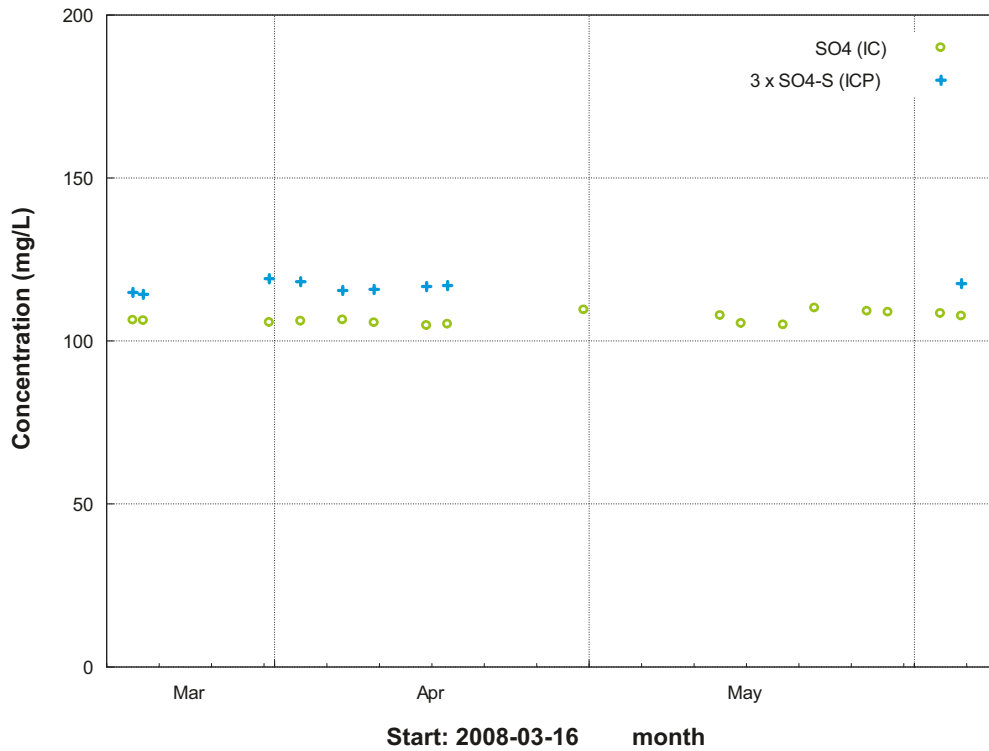

Figure 7-3. Sulphate (SO_4 by IC) to total sulphate calculated from total sulphur ($3 \times SO_4-S$ by ICP) versus date, borehole KLX27A section 641.5 to 650.6 m.

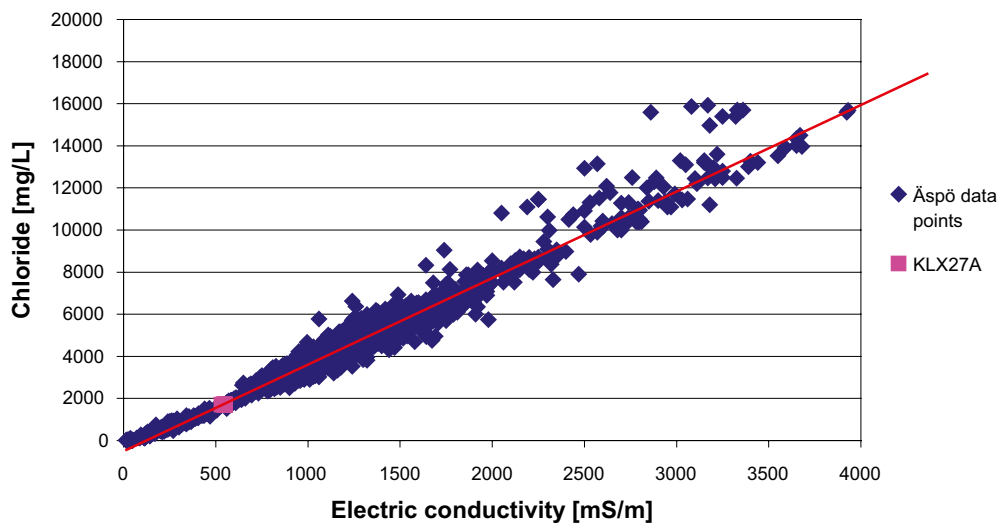

Figure 7-4. Chloride concentration versus electrical conductivity. Data from earlier investigations at the Äspö Hard Rock Laboratory are used to show the linear relationship. The data from KLX27A are consistent with previous investigations.

7.2.2 Trace elements (rare earth metals and others)

The analyses of trace and rare earth metals include U, Th, As, Sc, Cd, Hg, V, Rb, Y, Zr, In, Cs, Ba, La, Hf, Tl, Ce, Pr, Nd, Sm, Eu, Gd, Tb, Dy, Ho, Er, Tm, Yb and Lu. Commonly occurring metals, such as Cu, Zn, Pb and Mo are not included in the analysis programme due to contamination considerations. The trace element data are compiled in Appendix 9, Table A9-2.

7.2.3 Stable and radioactive isotopes

The isotope determinations include the stable isotopes $\delta^2\text{H}$, $\delta^{18}\text{O}$, $^{10}\text{B}/^{11}\text{B}$, $\delta^{34}\text{S}$, $\delta^{13}\text{C}$ and $^{87}\text{Sr}/^{86}\text{Sr}$ as well as the radioactive isotopes ^3H (tritium), ^{14}C (pmC), ^{238}U , ^{234}U , ^{230}Th , ^{226}Ra and ^{222}Rn . Isotope data are compiled in Appendix 9, Tables A9-3 and A9-4. The B-isotope ratio is given as $^{10}\text{B}/^{11}\text{B}$ (the result reported from the consulting laboratory). If one wants to use the notation according to international standard for environmental isotopes, $^{11}\text{B}/^{10}\text{B}$, it is necessary to invert the $^{10}\text{B}/^{11}\text{B}$ value ($1/^{10}\text{B}/^{11}\text{B}$).

The ^3H and $\delta^{18}\text{O}$ results are presented in Figure 7-5. The $\delta^{18}\text{O}$ ratios remained stable during the end of the sampling period. The ^3H content was below the detection limit (0.8 Tritium Units) in all samples except three.

$\delta^{13}\text{C}$ and pmC were determined only in inorganic constituents, as the amount of inorganic carbon (hydrogen carbonate) in the groundwater was insufficient. The results are presented in Table 7-2. Enrichment of organic carbon was necessary in order to collect enough organic material.

Table 7-2. Organic $\delta^{13}\text{C}$ and pmC in the water sample from KLX27A.

Borehole section (m)	Org. $\delta^{13}\text{C}$ (dev, PDB)	Org. pmC (%)
641.5 to 650.6 m	-27.2	44.8

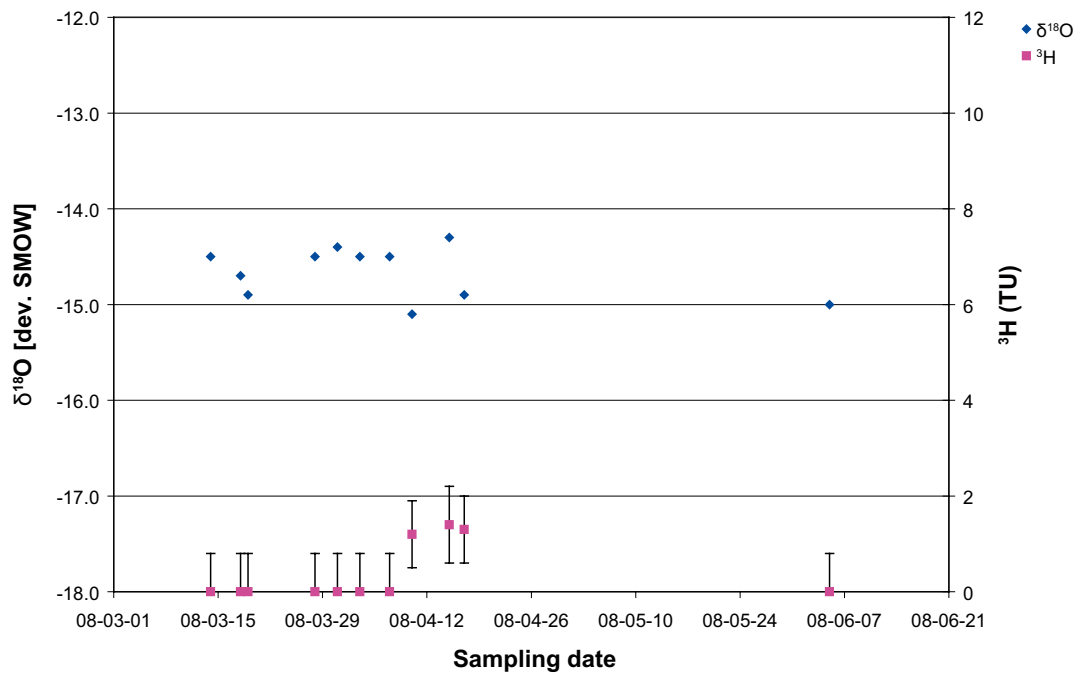

Figure 7-5. ^3H and $\delta^{18}\text{O}$ (‰ SMOW) data versus sampling date, section 641.5 to 650.6 m in borehole KLX27A.

7.3 Dissolved gas

Sampling for gas was performed in section 641.5 to 650.6 m. One container from the section was sent for analysis. Nitrogen gas was used for purging the samples. The analyses of dissolved gases include argon (Ar), helium (He), nitrogen (N₂), carbon dioxide (CO₂), carbon monoxide (CO) methane (CH₄), oxygen (O₂), hydrogen (H₂), ethane (C₂H₆), ethene (C₂H₄), ethyne (C₂H₂), propane (C₃H₈) and propene (C₃H₆). The gas data are presented in Figures 7-6 and 7-7 and compiled in Appendix 9, Table A9-5.

Total gas content in the groundwater as well as the detected oxygen content is given in Table 7-3.

The amount of gas in the sample was very high and consisted almost entirely of nitrogen, 10 times higher than usual for the investigated depth in other boreholes in Laxemar. This might be an effect of a leaking piston but could also be a correct analysis, as the result also deviates from the normal in Laxemar considering hydrogen gas, with a 10 times higher amount than usual.

Table 7-3. Total content of dissolved gas.

Section 641.5 to 650.6 m	
Total gas content [mL/L]	594
Oxygen content [mL/L]	<0.044

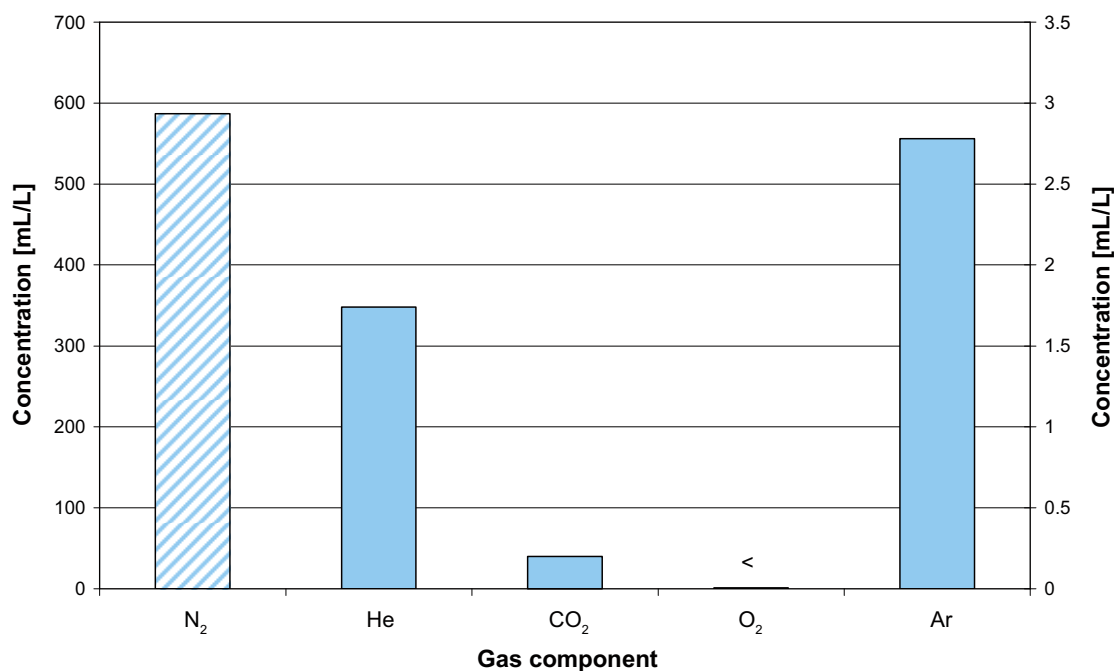

Figure 7-6. Gas components of high concentrations (N₂, He, CO₂, O₂, and Ar) in samples collected in KLX27A using the in situ sampling equipment. Striped and non-striped bars refer to the scales on left and right axis, respectively.

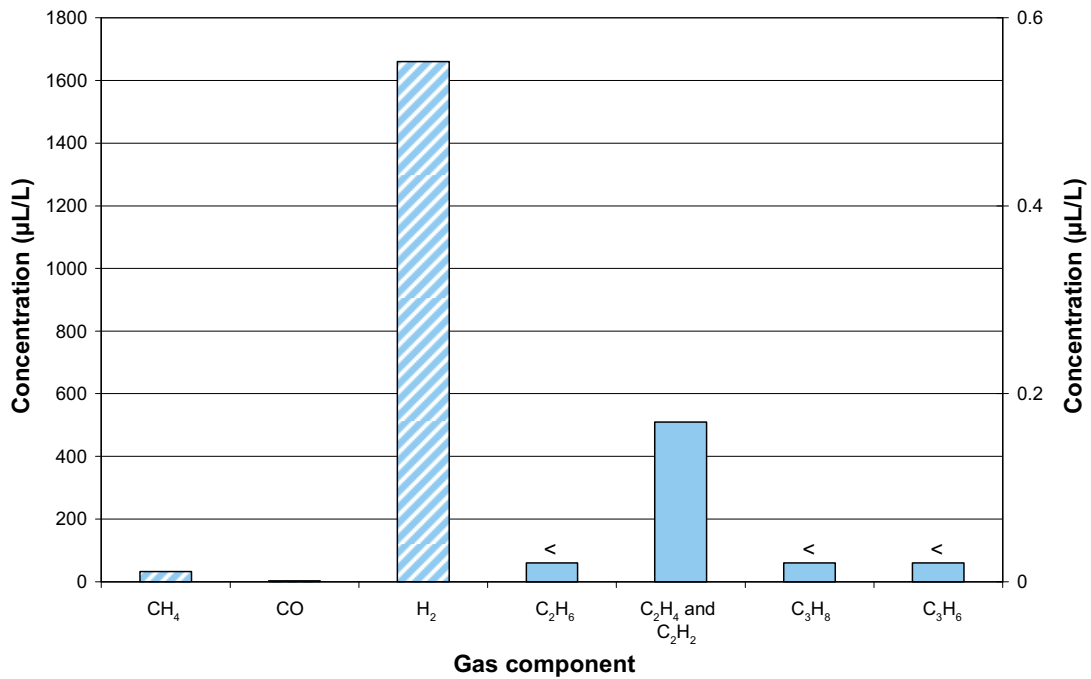

Figure 7-7. Gas components of low concentrations (CH₄, CO, H₂, C₂H₆, sum of C₂H₄ and C₂H₂, C₃H₈ and C₃H₆) in samples collected in KLX27A using the in situ sampling equipment. Striped and non-striped bars refer to the scales on left and right axis, respectively.

7.4 Colloids

The presence of colloids was investigated using two methods, 1) Laser-Induced Breakdown Detection, LIBD (Appendix 8) and 2) fractionation/ultra filtration using two cylindrical filters with cut-offs of 1,000 D and 5,000 D.

The results from the two methods 1) and 2) are difficult to compare quantitatively but a qualitative agreement is usually identified.

An overview of colloid concentrations determined by LIBD in groundwater samples from boreholes at the Forsmark site investigation; KFM06A, KFM07A, KFM08A, and KFM01D, has been presented previously /10/.

In Table 7-4, the corresponding results from Laxemar are presented.

There are some difficulties associated with colloid determinations. Generally, it is expected that the measured colloid concentrations turn out higher than the natural amount of background colloids in the groundwater as additional colloids are easily generated by artefacts. The sources may be:

- Oxygen intrusion and formation of iron hydroxide.
- Decrease of pressure and precipitation of calcite.
- The sampling process or the equipment.

7.4.1 Inorganic colloids – LIBD (Laser Induced Breakdown Detection)

The colloid content and colloid size in section 641.5 to 650.6 m, run number 2 was much higher than in run number 1. Together with the results from the chemical analyses, it seems that the water in container number 2 is not representative for the borehole water, and the results are not reported here, see “Nonconformities”. The amount of colloids (230 to 330 µg/L) compared with the chloride content in KLX27A follows the trend from previous investigations with higher colloid contents at lower chloride concentrations, see Appendix 8, Fig. 8. The colloid composition is dominated by iron, followed by aluminium, silicon and calcium, and in some larger particles sulphur and zinc. A very high DOC content (c. 1,000 mg/L) was reported in both PVB containers and a GC-MS analysis was performed in order to find out what the contamination consisted of. However, no compound corresponding to this amount of organic material was found in the analysis and the source is still unknown.

7.4.2 Inorganic colloids – fractionation

In addition to the DOC analyses, the samples from fractionation experiments were also analysed by ICP. The determined elements were; Ca, Fe, K, Mg, Na, S, Si, Al, Ba, Cd, Co, Cr, Cu, Hg, Li, Mn, Mo, Ni, P, Pb, Sr, V and Zn. Only Fe (iron), Si (silicon), Ca (calcium), S (sulphur), Al (aluminium) and Mn (manganese) were considered important as colloid species.

Table 7-4. Colloid concentrations measured in the groundwater samples. Comparison of results obtained by “Filtration – ICP”, “Filtration – SEM (Scanning Electron Microscopy)” and LIBD. /11–13/

Filtration through series of connected filters								LIBD/SEM		
Idcode/ secup/ filter pore size (µm)	Filtrate volume (mL) ICP/SEM	Element content on each filter per litre of water (µg/L)					Mineral phases (µg/L)		Idcode/secup/run no.	Content (µg/L)
		Al	Fe	Mn	Ca	S	Total/filter*	Sum**/ three filters		
KLX13A/ 432.0/0.2	307	0.320	2.12	0	0	0	6.02		KLX13A/432.0/1	2–5
KLX13A/ 432.0/0.05	307	0.119	2.90	0	0	0	6.28	12.3	KLX13A/432.0/2	2
KLX17A/ 416.0/0.05 and 0.2	108.5								KLX17A/416.0/1	240/96
									KLX17A/416.0/2	110
KLX17A/ 642.0/0.2	177.0	70.6	32.4	0.091	0	0	103		KLX17A/642.0/1	Above analysis range
KLX17A/ 642.0/0.05	177.0	13.6	35.2	0	0	0	48.9			
KLX17A/ 642.0/0.05	177.0	1.40	11.9	0.091	0	0	13.4	165	KLX17A/642.0/2	Above analysis range
KLX15A/ 623.0/0.4	162.5	0	0	0	0	0	0			
KLX15A/ 623.0/0.2	162.5	0	0	0	0	0	0		KLX15A/623/1	<1–5/20
KLX15A/ 623.0/0.05	162.5	0	0.38	0.02	48	20	140	140	KLX15A/623/2	0.008–4/–
KLX27A									KLX27A/641.5/1	230–330

* Total content on each filter. In order to be able to compare results from the filtration with results from LIBD, the metal ion amounts have been calculated as their most probable mineral phases. Aluminium is calculated as 2.3 Al in K–Mg-illite (383.9 g/mol), iron is calculated as Fe(OH)₃ (106.8 g/mol) and manganese is calculated as Mn(OH)₂ (88.9 g/mol). The silicon, calcium and sulphur contents on the filters were below detection limit.

** Sum of content (mineral phases) on the three filters.

*** Fraction number.

The results presented in Table 7-5 were calculated using mass balance equations. Silicon, aluminium, manganese, calcium and sulphur exist as species (associated or non-associated with humic and fulvic acids) with a molecular weight less than 1,000 D (g/mol).

The results for iron are omitted because of the concentration below the detection limit. The iron colloids detected with the LIBD method had an average diameter of 1.5 µm and could not be detected in the fractionation experiment as the water had been filtrated with a filter of pore size 0.45 µm prior to the investigation.

The blanks (de-ionised water collected after passing through the washed filters) showed insignificant concentrations of iron, silicon, aluminium, manganese, calcium and sulphur.

7.5 Humic and fulvic acids – fractionation

The results from fractionation of organic acids are summarised in Table 7-6. The water mainly contains a fraction of organic acids with molecular weight less than 1,000 D. This fraction consists of fulvic acids and possibly other low molecular weight organic acids such as citric acid and oxalic acids.

The results from the 5,000 D filter were not reliable. The concentration of organic carbon in the permeate was higher than the concentration of organic carbon in the borehole water. Contamination from the filter is unlikely since the sample blank contained organic carbon less than 1 mg/l. It is possible that contamination from the vessel used for sampling of the permeate has occurred. The results from the 1,000 D and 5,000 D filters are consistent and indicate that the water mainly contains a fraction of organic acids with molecular weight less than 5,000 D.

Table 7-5. Inorganic fractions (<1,000 D, 1,000 D to 5,000 D and >5,000 D) in section 641.5 to 650.6 m.

Fraction	Si [mg/L]	Al [µg/L]	Mn [µg/L]	Ca [mg/L]	S [mg/L]
< 1,000 D	5.1 ± 0.7	19.0 ± 4.0	13.6 ± 2.3	118 ± 14	35.0 ± 4.2
< 5,000 D	5.0 ± 0.7	20.7 ± 4.3	13.1 ± 2.2	119 ± 14	36.4 ± 4.4
> 1,000 D but < 5,000 D	< 1.1	< 3.6	< 1.6	< 9.0	< 3.7
> 5,000 D	< 0.4	< 3.4	< 1.1	< 6.8	< 2.9
Adsorption 1,000 D	< 1.2	< 7.1	< 6.1	< 25	< 8.1
Adsorption 5,000 D	< 1.3	< 4.9	< 4.0	< 23	< 8.7

Table 7-6. Summary of fractionation results in KLX27A.

Fraction	DOC [mg/L]
< 1,000 D	1.0 ± 0.1
< 5,000 D	1.5 ± 0.2
> 1,000 D but < 5,000 D	0.12 ± 0.06
> 5,000 D	0.13 ± 0.09
Adsorption 1,000 D	<0.5
Adsorption 5,000 D	<0.8

8 Summary

The *Complete chemical characterisation* in KLX27A was, on the whole, performed successfully.

The main conclusions from the experimental results are:

- An upper limit for the allowed flushing water content in a representative water sample is set to 1%. This condition was met in the investigated section 641.5–650.6 m (0.02%).
- The chloride concentrations and electrical conductivity were about 1,700 mg/L and 550 mS/m, respectively. These values are similar to the ones from the two deepest investigated sections (476.0 to 485.6 m and 609.0 to 618.5 m) in borehole KLX08.
- The stable salinity indicates that no mixing occurred with water from other fracture systems with a different water composition.
- The total turnover for the water was 150 section volumes, and thus the groundwater compositions can be considered as fairly representative for the water bearing fractures in the investigated section.
- The magnitude of $\delta^{18}\text{O}$ indicates mixing with glacial meltwater, also supported by the low ^3H concentrations. The high salinity combined with low bromide values indicates an origin of deeper saline water.
- The quality of the water analyses is generally high, based on comparison between results from different laboratories, methods and acceptable charge balance errors. The relative errors are all within $\pm 5\%$.
- The redox potential measurements were not completely stable, however the borehole electrodes (gold, glassy carbon and platinum) reached consistent values; about -190 mV. The measured potential in connection with the LIBD analysis was -95 mV.
- The results from the colloid determination using LIBD show a fairly high content of colloids (230–330 $\mu\text{g/L}$). Only the result from one container out of two has been reported due to sampling problems. The results from the SEM images suggest that the colloid content is dominated by iron, followed by aluminium, silicon and calcium, and in some larger particles sulphur and zinc.
- The organic constituents are mainly present as fulvic acids and possibly other low molecular weight organic acids (such as citric and oxalic acids).

9 References

- /1/ **SKB, 2001.** Site investigations. Investigation methods and general execution programme. SKB TR-01-29, Svensk Kärnbränslehantering AB.
- /2/ **SKB, 2002.** Geovetenskapligt program för platsundersökning vid Simpevarp. SKB R-01-44, Svensk Kärnbränslehantering AB.
- /3/ **SKB, 2005.** Platsundersökning Oskarshamn. Program för fortsatta undersökningar av berggrund, mark, vatten och miljö inom delområde Laxemar. SKB R-05-37, Svensk Kärnbränslehantering AB.
- /4/ **Pedersen K, 2008.** Oskarshamn site investigation. Microorganisms in groundwater from borehole KLX27A-numbers, viability and metabolic diversity. Results from one section: 641.50 to 650.56 m in KLX27A. SKB P-08-83, Svensk Kärnbränslehantering AB
- /5/ **Ask H, Morosini M and Hedqvist I, 2008.** Drilling of cored borehole KLX27A. Oskarshamn site investigation.
- /6/ **Gustafsson J and Gustafsson C, 2008.** Oskarshamn site investigation. RAMAC, BIPS and deviation logging in borehole KLX27A. SKB P-08-30, Svensk Kärnbränslehantering AB.
- /7/ **Pöllänen J, Pekkanen J, and Väisäsvaara J, 2008.** Oskarshamn site investigation. Difference flow logging in borehole KLX27A. Subarea Laxemar. SKB P-08-22, Svensk Kärnbränslehantering AB.
- /8/ **Enachescu C, Wolf P, Rohs S and van der Wall R, 2008.** Oskarshamn site investigation, subarea Laxemar. Hydraulic injection tests in borehole KLX27A. SKB P-08-27, Svensk Kärnbränslehantering AB.
- /9/ **Nielsen U T and Ringgaard J, 2008.** Oskarshamn site investigation. Geophysical borehole logging in boreholes KLX27A. SKB P-08-03, Svensk Kärnbränslehantering AB.
- /10/ **Nilsson K, Bergelin A, Lindquist A and Nilsson A-C, 2006.** Forsmark site investigation. Hydrochemical characterisation in borehole KFM01D. Results from seven investigated borehole sections: 194.0–195.0 m, 263.8–364.8 m, 314.5–319.5 m, 354.9–355.9 m, 369.0–370.0 m, 428.5–435.6 m, 568.0–575.1 m. SKB P-06-227, Svensk Kärnbränslehantering AB.
- /11/ **Bergelin A, Nilsson K, Lindquist A, Wacker, P, 2007.** Oskarshamn site investigation. Complete chemical characterisation in KLX13A. Results from two investigated borehole sections: 432.0–439.2 m, 499.5–506.7 m. SKB P-07-149, Svensk Kärnbränslehantering AB.
- /12/ **Bergelin A, Nilsson K, Lindquist A and Wacker, P, 2007.** Oskarshamn site investigation. Complete chemical characterisation in KLX17A. Results from two investigated borehole sections: 416.0–437.5 m, 642.0–701.1 m. SKB P-07-164, Svensk Kärnbränslehantering AB.
- /13/ **Bergelin A, Nilsson K, Lindquist A and Wacker, P, 2007.** Oskarshamn site investigation. Complete chemical characterisation in KLX15A. Results from the investigated borehole section: 623.0–634.5 m. SKB P-08-69, Svensk Kärnbränslehantering AB.

Design of cored borehole KLX27A

Technical data

Borehole KLX27A

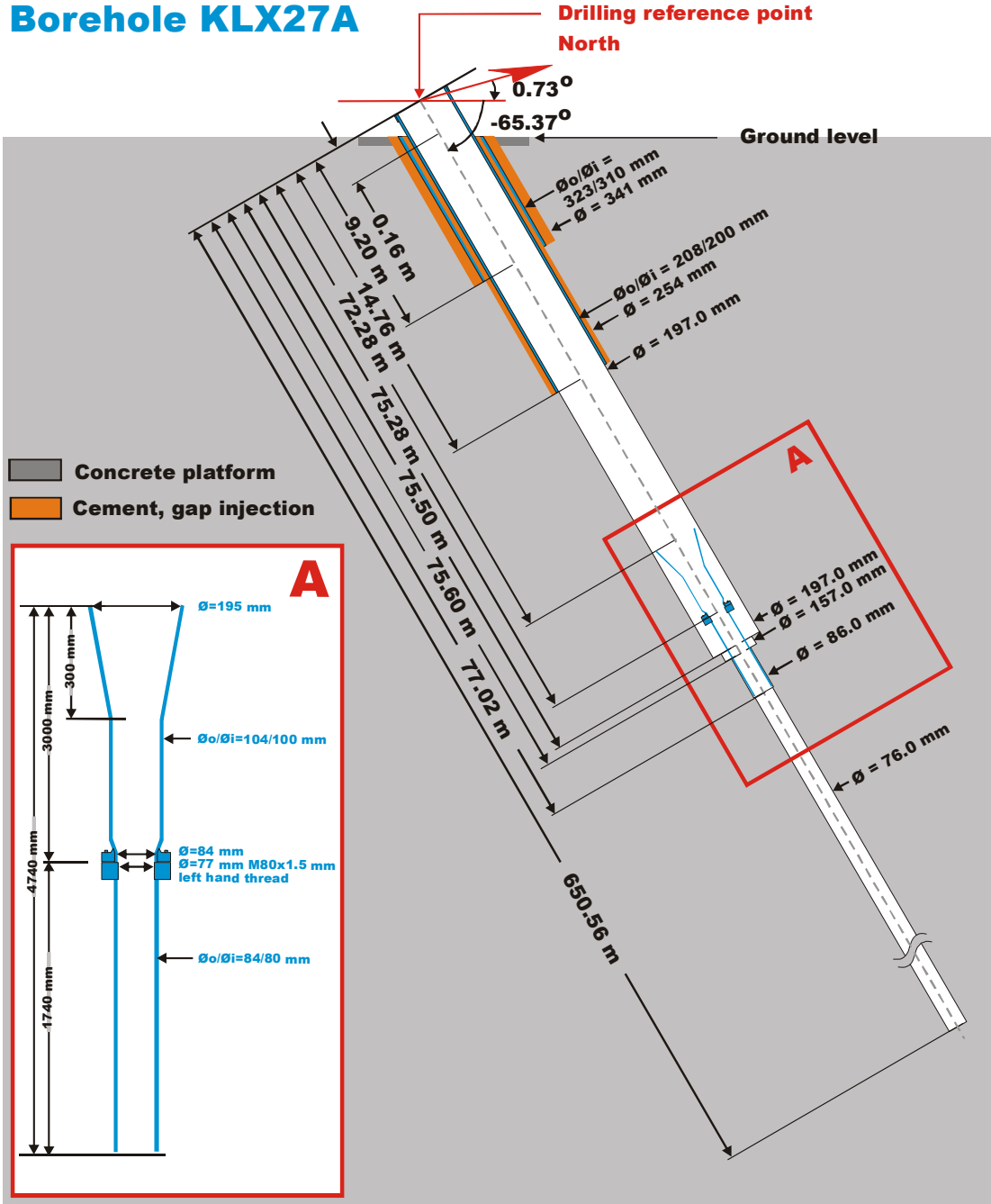

Drilling reference point
Northing: 6365608.29 (m), RT90 2,5 gon V 0:-15
Easting: 1546742.63 (m), RT90 2,5 gon V 0:-15
Elevation: 16.98 (m), RHB 70

Drilling period
2007-08-15 - 2007-08-27, 0.16 - 75.60 m
2007-10-08 - 2007-11-21, 75.60 - 650.56 m

Ver 2007-12-12

Selected results from difference flow logging in KLX27A

Laxemar, borehole KLX27A
Flow rate, caliper and single point resistance

- ▲ Without pumping (L=5 m, dL=5 m), (Flow direction = into the hole)
- ▼ Without pumping (L=5 m, dL=5 m), (Flow direction = into the bedrock)
- ▲ With pumping (L=5 m, dL=5 m), (Flow direction = into the hole)
- Without pumping (L=5 m, dL=0.5 m), 2007-12-15 - 2007-12-16
- With pumping (Drawdown=10 m, L=5 m, dL=0.5 m), 2008-01-08 - 2008-01-09
- With pumping (Drawdown=10 m, L=1 m, dL=0.1 m), 2008-01-05 - 2008-01-06
- With pumping during fracture-EC (Drawdown=10 m, L=0.5 m, dL=0.1 m), 2008-01-07 - 2008-01-08
- Lower limit of flow rate

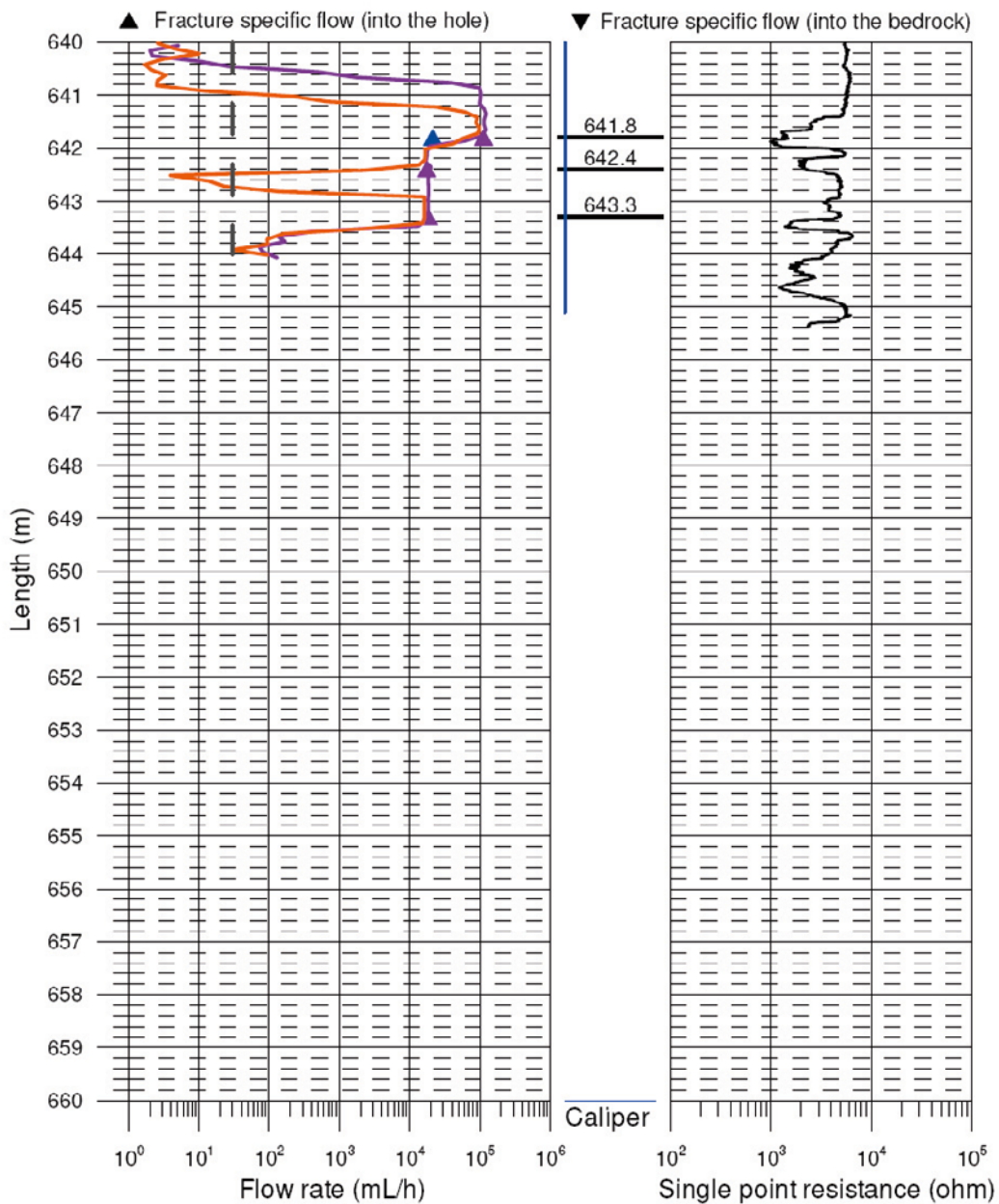

Figure A2-1. Borehole KLX27A: Differential flow measurements from 640 to 645 m including the water bearing fracture zone at ca 642 to 644 m /8/.

Selected images from BIPS logging in KLX27A

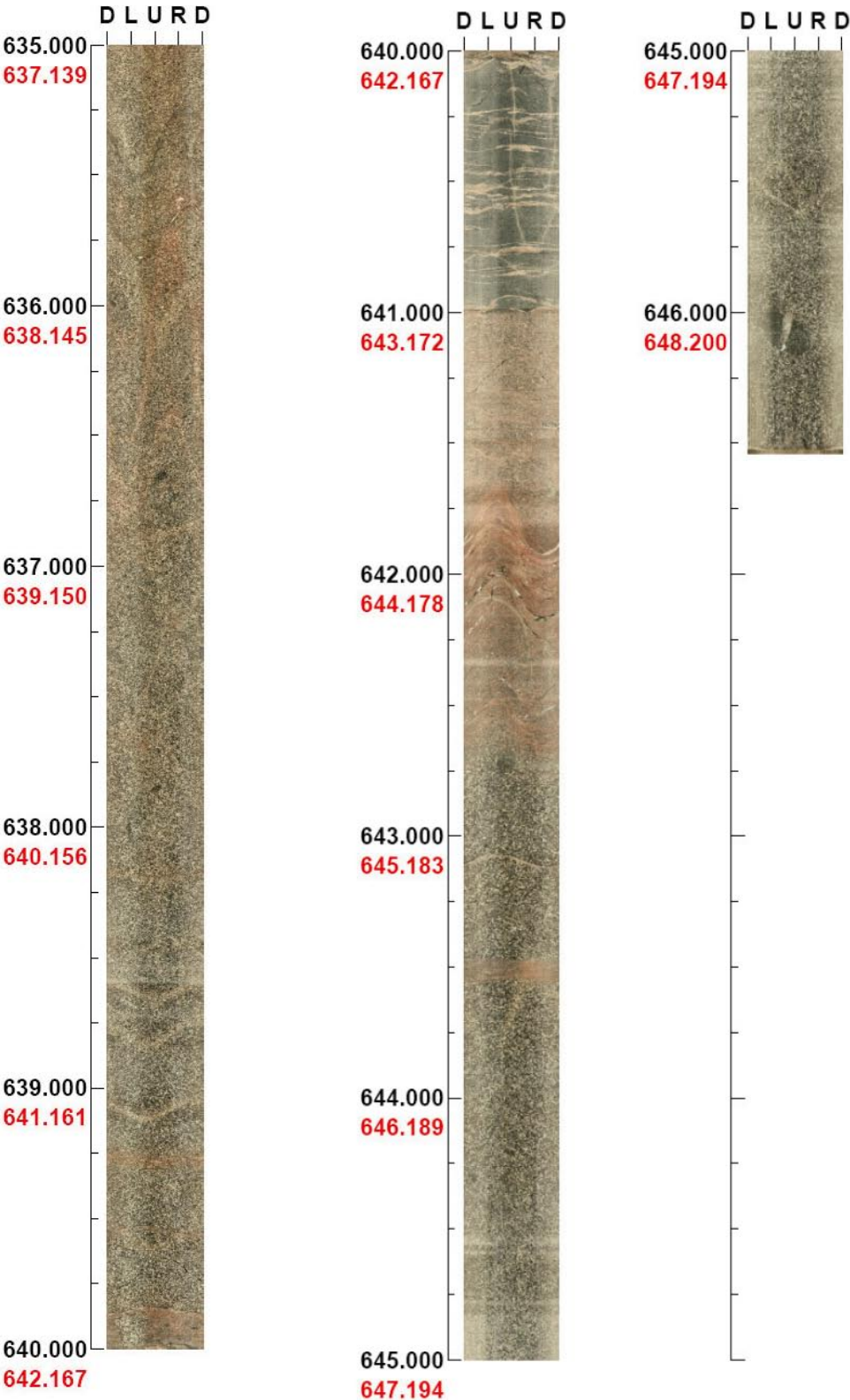

Figure A3-1. Borehole KLX27A: selected BIPS logging image from 637.1 to 648.2 m including the water bearing fracture zone at ca 642 to 644 m. The non-adjusted length is marked with black and the adjusted true length is marked with red /6/.

Measurement information, KLX27A

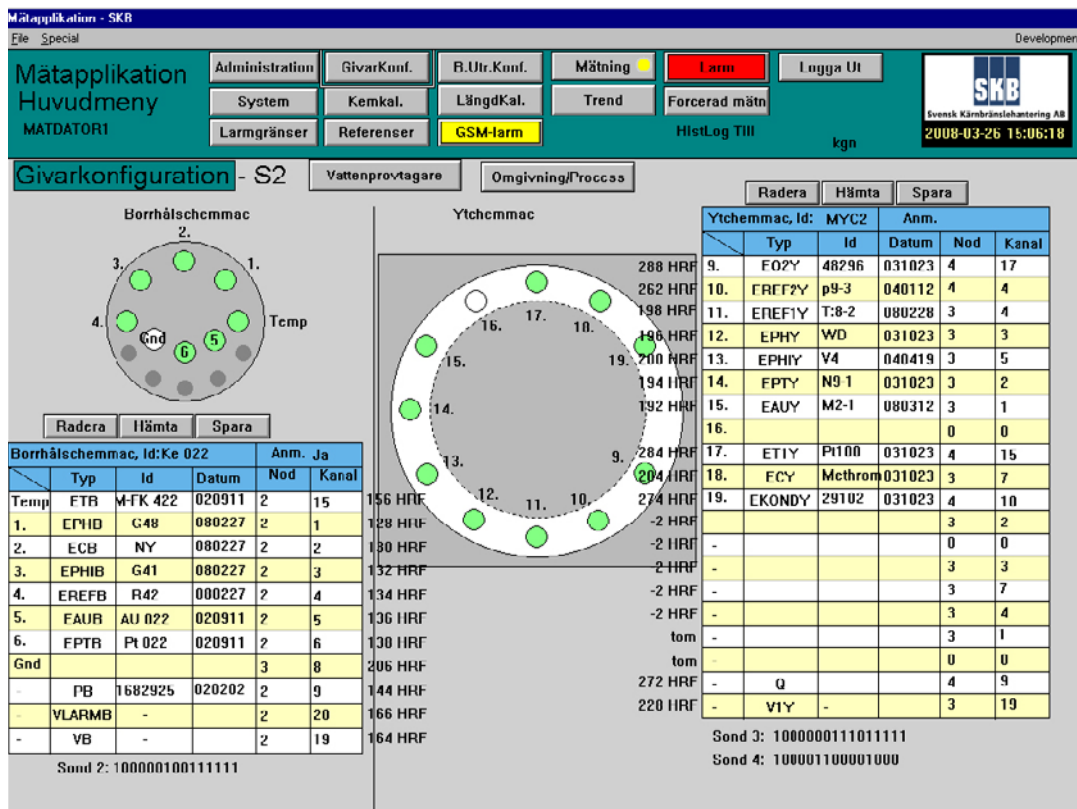

Figure A4-1. Electrode configuration, section 641.5 to 650.6 m, 2008-03-26.

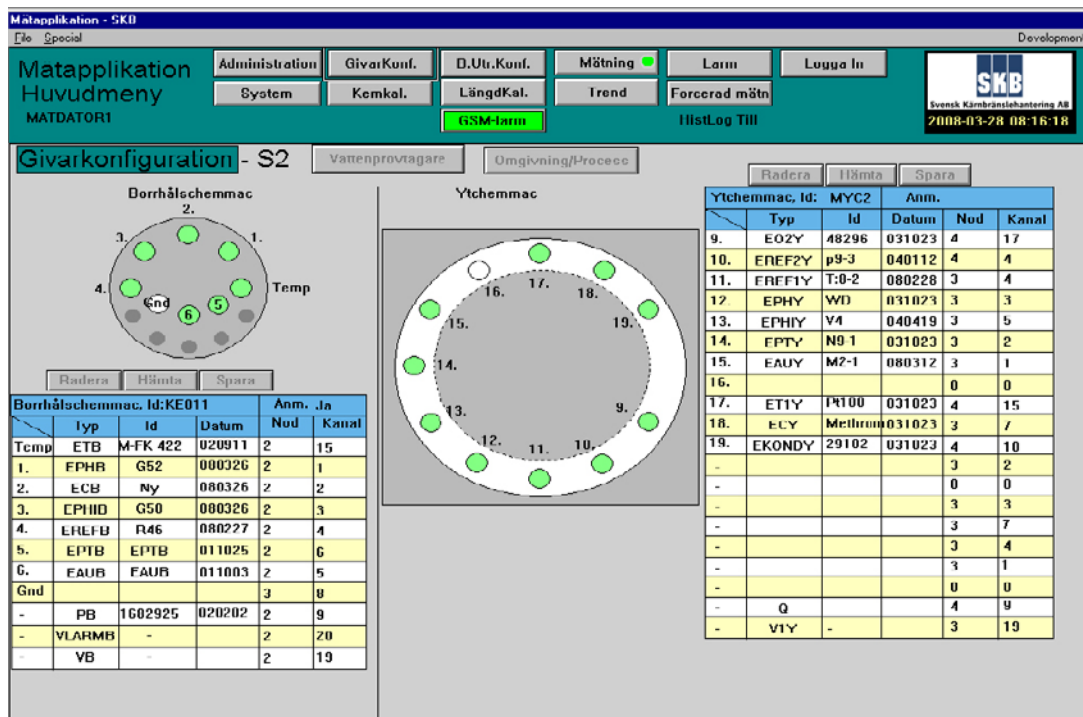

Figure A4-2. Electrode configuration, section 641.5 to 650.6 m, 2008-03-28.

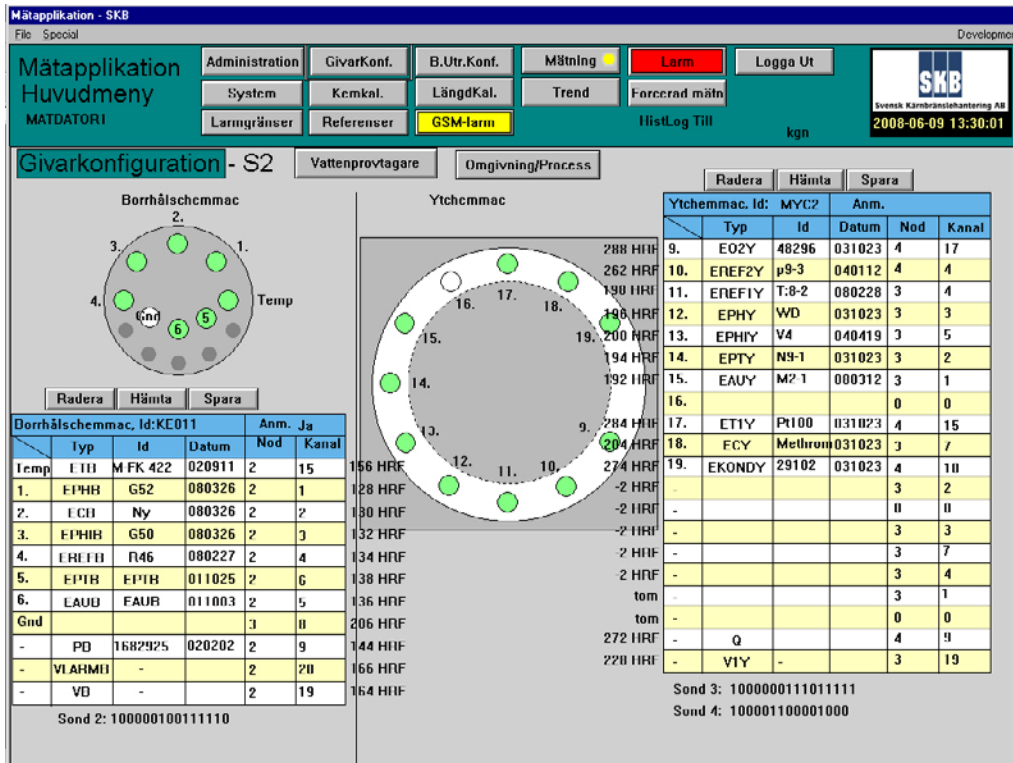

Figure A4-3. Electrode configuration, section 641.5 to 650.6 m, 2008-06-09.

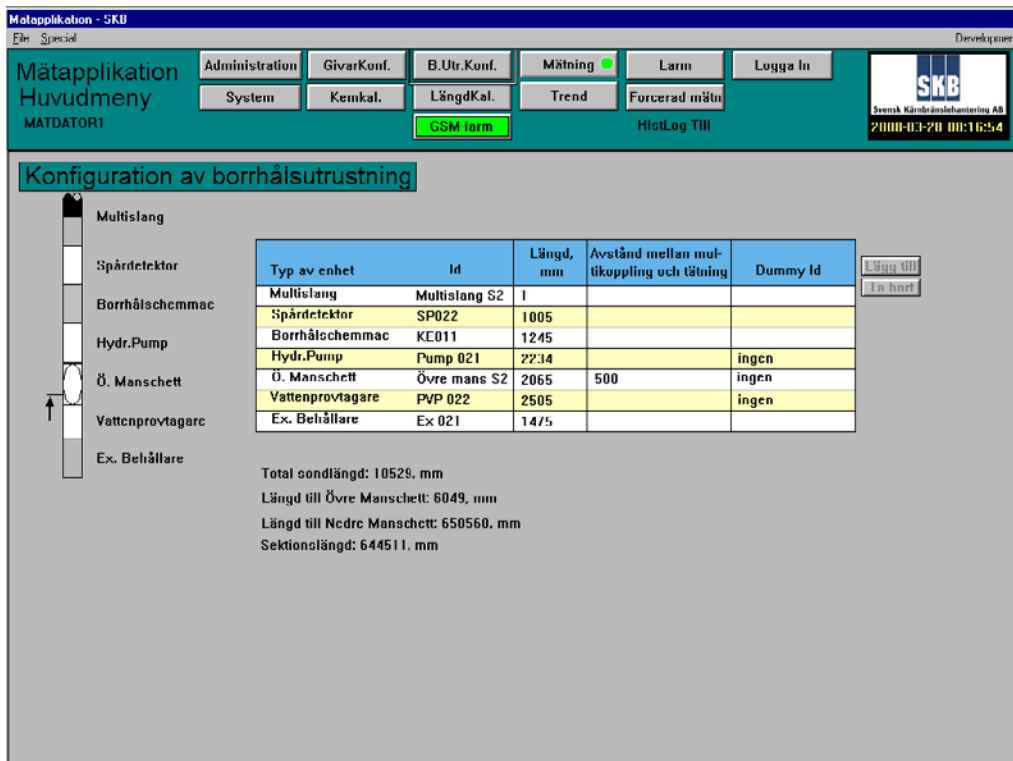

Figure A4-4. Configuration of downhole equipment, section 641.5 to 650.6 m, 2008-03-28.

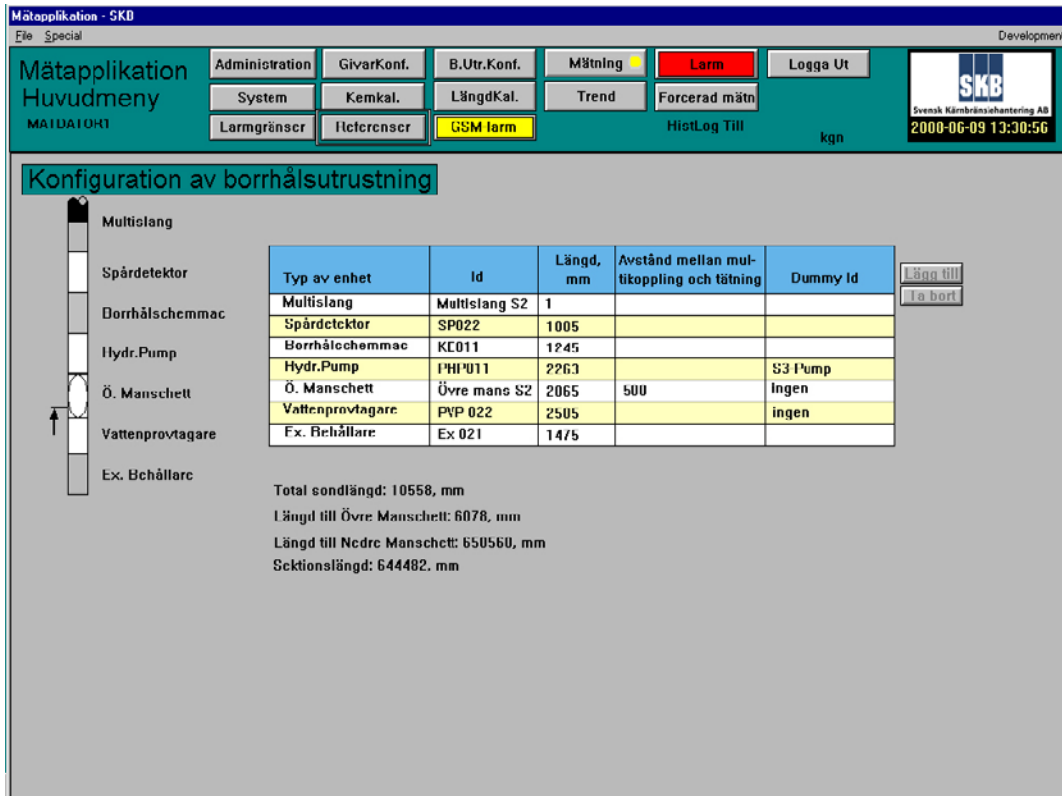

Figure A4-5. Configuration of downhole equipment, section 641.5 to 650.6 m, 2008-06-09.

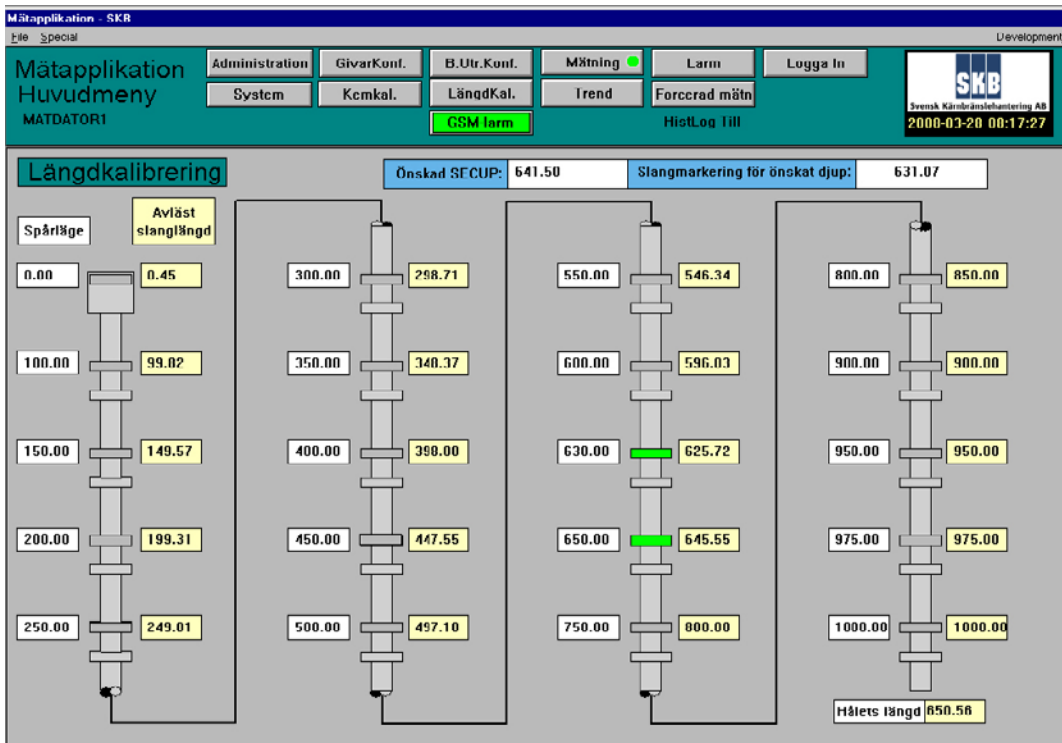

Figure A4-6. Length calibration, section 641.5 to 650.6 m, 2008-03-28.

Mätapplikation - SKB
File Special Development

Mätapplikation Huvudmeny
MATDATOR1

Administration GivarKonf. B.Utr.Konf. Mätning Larm Logga Ut
System Kemkal. I ängdKal. Trend Forcerad mätning
Larmgränser Referenser GSM-larm HistLog Till kgn

SKB
Svensk Kärnbränslehantering AB
2008-03-26 15:07:15

Administration

Utskrift
Export av mätfiler

Allmänt

Rörnr	K1 X27a
Operatör	kgn
SECUP	641.50
SECIDP	650.56
Starttid	2008-03-12 11:35:20
Sluttid	2008-03-26 14:26:08
Kemdata	K1 X27a0312641K.MRB
OPData	K1 X27a0312641O.MRB
Kommentar	K1 X27a0312641K.MI
FilniSiock	D:\Mätfiler\K1X27a0003\0642_0651

D:\Mätfiler\K1X27a0003\0642-0651\K1 X27a0312641K.029

CHEMMAC	Filer - inkalibrering		Filer - utkalibrering	
	Data	Kommentar	Data	Kommentar
Y T	p114	K1X27a0312ipH4Y.CRB	K1X27a0312ipH4Y.CI	
	p117	K1X27a0312ipH7Y.CRD	K1X27a0312ipH7Y.CI	
	p110	K1X27a0312ipH10Y.CRB	K1X27a0312ipH10Y.CI	
	0.01M	K1X27a0312ikc01Y.CR	K1X27a0312ikc01Y.CI	
	0.1M	K1X27a0312ikc1Y.CRD	K1X27a0312ikc1Y.CI	
B O R Ä R L	pH4	K1X27a0326ipH4B.CRB	K1X27a0326UpH4B.CRB	K1X27a0326UpH4B.CI
	pH7	K1X27a0311ipH7B.CRB	K1X27a0326UpH7B.CI	K1X27a0326UpH7B.CI
	pH10	K1X27a0311ipH10B.CRB	K1X27a0311ipH10B.CI	

Enhetsidentiteter

YtChemmac	MYC2
Multislang	Multislang S2
Spårdetektor	SP022
Borrhålschemmac	Ke 022
Hydr.Pump	Pump 022
O. Manschett	Övre mans S2
Vattenprovtagare	PVP 022
F.v. Behållare	Fv 021

BorrhålsChemmac/PVP/OP

CTB	M FK 422
CPIID	G48
ECB	NY
EPHIB	G41
EKEFB	R42
EAUB	AU 022
F-PIH	PI 022
PA	1682925
PjV	1555780
P2V	1555701
INTEMP	in56
UTTEMP	ut78
ATMP	at67
CNIV	1632330
PMPP	pu78
MANSOP	ma90

YtChemmac

Q	
EOZY	48296
EREF2Y	p9-3
EREF1Y	T:8-2
EPHY	WD
EPHY	V4
EPTY	N9-1
FAHY	M2-1
ET1Y	PI100
ECY	Methrom
EKONDY	29102

Figure A4-7. Administration, section 641.5 to 650.6 m, 2008-03-26.

Mätapplikation - SKB
File Special Development

Mätapplikation Huvudmeny
MATDATOR1

Administration GivarKonf. D.Utr.Konf. Mätning Larm Logga In
System Kemkal. LängdKal. Trend Forcerad mätning
Larmgränser Referenser GSM-larm HistLog Till

SKB
Svensk Kärnbränslehantering AB
2008-03-28 08:15:49

Administration

Utskrift
Export av mätfiler

Allmänt

Rörnr	K1 X27a
Operatör	kgn
SECUP	641.50
SECIDP	650.56
Starttid	2008-03-27 09:05:17
Sluttid	2008-03-26 14:26:08
Kemdata	K1X27a0327641K.MRD
OPData	K1X27a0327641O.MRB
Kommentar	K1X27a0327641K.MI
FilniSiock	D:\Mätfiler\K1X27a0003\0642_0651

D:\Mätfiler\K1X27a0003\0642-0651\K1X27a0327641K.040

CHEMMAC	Filer - inkalibrering		Filer - utkalibrering		
	Data	Kommentar	Data	Kommentar	
Y T	pH4	K1X27a0312ipH4Y.CRB	K1X27a0312ipH4Y.CI		
	pH7	K1X27a0312ipH7Y.CRB	K1X27a0312ipH7Y.CI		
	pH10	K1X27a0312ipH10Y.CRB	K1X27a0312ipH10Y.CI		
	0.01M	K1X27a0312ikc01Y.CR	K1X27a0312ikc01Y.CI		
	0.1M	K1X27a0312ikc1Y.CRD	K1X27a0312ikc1Y.CI		
B O R Ä R L	p114	K1X27a0327ipH4B.CRB	K1X27a0327ipH4B.CI	K1X27a0326UpH4B.CRB	K1X27a0326UpH4B.CI
	p117	K1X27a0327ipH7B.CRB	K1X27a0327ipH7B.CI	K1X27a0326UpH7B.CRB	K1X27a0326UpH7B.CI
	pH10	K1 X27a0327ipH10B.CRB	K1 X27a0327ipH10B.CI		

Enhetsidentiteter

YtChemmac	MYC2
Multislang	Multislang S2
Spårdetektor	SP022
Borrhålschemmac	KE011
Hydr.Pump	Pump 021
O. Manschett	Övre mans S2
Vattenprovtagare	PVP 022
F.v. Behållare	Fv 021

BorrhålsChemmac/PVP/OP

CTB	M FK 422
FPHB	G52
F-CH	NY
EPHIB	G50
EKEFB	R46
EPTB	EPTB
EAUB	EAUB
PA	1682925
PjV	1555780
P2V	1555781
INTEMP	in56
UTTEMP	ut70
ATMP	at67
CNIV	1632330
PMPP	pu70
MANSOP	ma90

YtChemmac

Q	
EOZY	48296
EREF2Y	p9-3
EREF1Y	T:8-2
EPHY	WD
EPHY	V4
EPTY	N9-1
FAHY	M2-1
ET1Y	PI100
ECY	Methrom
EKONDY	29102

Figure A4-8. Administration, section 641.5 to 650.6 m, 2008-03-28.

Mätapplikation - SKD
File Special Development

Mätapplikation Huvudmeny
MATDATOR1

Administration GivarKonf. B.Utr.Konf. Mätning **Larm** Logga Ut
System Kemkal. LängdKal. Trend Forcerad mätning
Larmgränscr Referenser **GSM larm** HistLog Till kgn

Administration

Utskrift
Export av mätfiler

Allmänt

Borrhål	KLX27a
Operatör	TBJ
Nytt	641.5
SEKID	650.56
Starttid	2008-05-09 10:49:54
Stopptid	2008-06-09 06:53:21
Komdata	KLX27a050910410.MRB
OPdata	KLX27a050910410.MRB
Kommentar	KLX27a050910410.MI
Filnämnd	D:\Mätfiler\KLX27a0803\0642-0651

D:\Mätfiler\KLX27a0803\0642-0651\KLX27a0609Ukl1Y.035

FörhållsChemmac/PVP/OP	
ETB	M-FK 422
CPIID	G52
ECD	Ny
EPHIB	G50
ERLFB	R46
EPTB	EPTB
CAUD	CAUD
FB	1682925
P1Y	1555780
P2Y	1555781
INTEMP	in56
UTTEMP	ut78
ATP	a167
LYBY	1632338
MMP	pu79
MASC+	ma90

YChemmac	
Q	
EO2Y	40296
EREF2Y	p9-3
EREF1Y	T:8-2
FPHY	WD
EPHY	V4
EPTY	H9 1
CAUY	M2 1
E11Y	D1100
ECY	Methrom
EKONDY	29102

CHEMMAC	Filer - Inkallbrering		Filer - utkallbrering	
	Data	Kommentar	Data	Kommentar
Y	pH4	KLX27a05091pH4Y.CRD	KLX27a06091pH4Y.CRB	KLX27a0609UpH4Y.CI
	pH7	KLX27a05091pH7Y.CRR	KLX27a06091pH7Y.CRB	KLX27a0609UpH7Y.CI
	pH10	KLX27a05091pH10Y.CRB	KLX27a0609UpH10Y.CRB	KLX27a0609UpH10Y.CI
	0.01M	KLX27a05091kcl01Y.CR	KLX27a06091kcl01Y.CR	KLX27a0609Ukcl01Y.CI
	0.1M	KLX27a05091kcl1Y.CRB	KLX27a0609Ukcl1Y.CRB	KLX27a0609Ukcl1Y.CI
D O H I Ä R L	pH4	KLX27a05091pH4B.CRB	KLX27a0609UpH4B.CRB	KLX27a0609UpH4B.CI
	pH7	KLX27a05091pH7B.CRB	KLX27a0609UpH7B.CRB	KLX27a0609UpH7B.CI
	pH10	KLX27a05091pH10B.CRD	KLX27a0609UpH10B.CRD	KLX27a0609UpH10B.CI

Figure A4-9. Administration, section 641.5 to 650.6 m, 2008-06-09.

Flow and pressure measurements, KLX27A

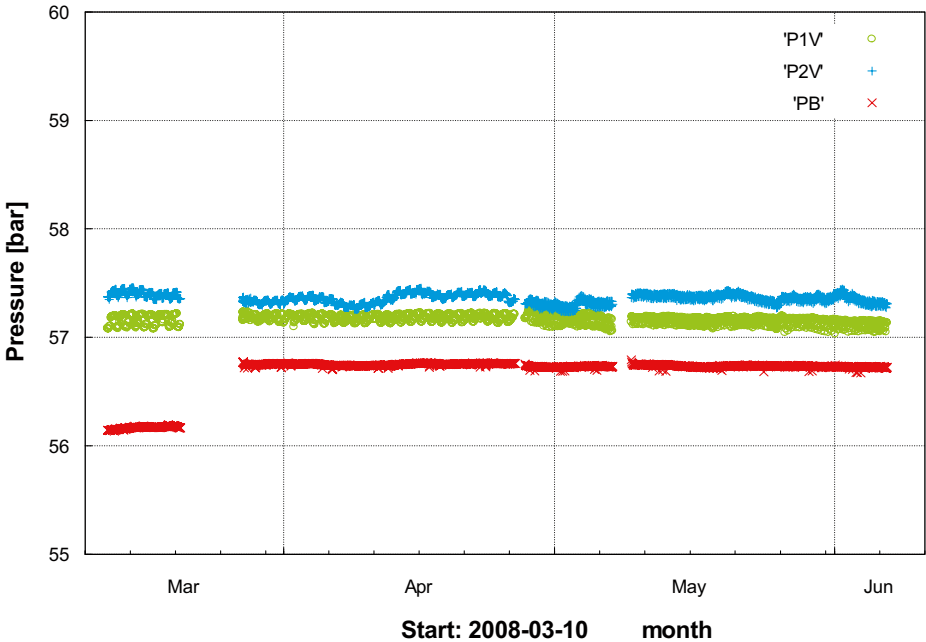

Figure A5-1. Pressure measurements (P1V, P2V and PB), section 641.5–650.6 m. The sensors P1V and P2V measure the pressure within the section and are both placed in the in situ sampling unit. The sensor PB, placed in the borehole Chemmac, measures the pressure above the section.

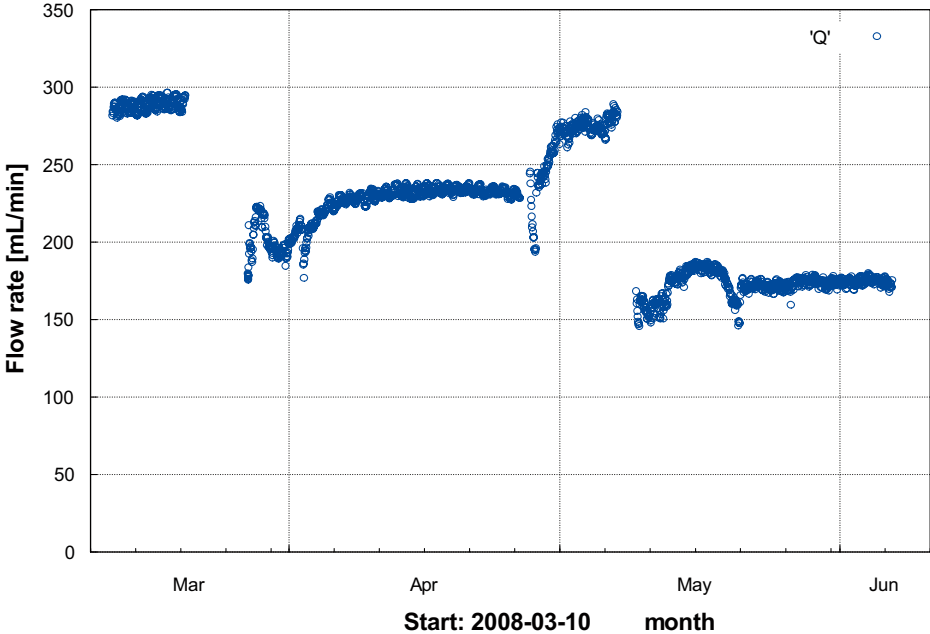

Figure A5-2. Pumping flow rate (Q), section 641.5–650.6 m.

Chemmac measurements in KLX27A, section 641.5 to 650.6 m

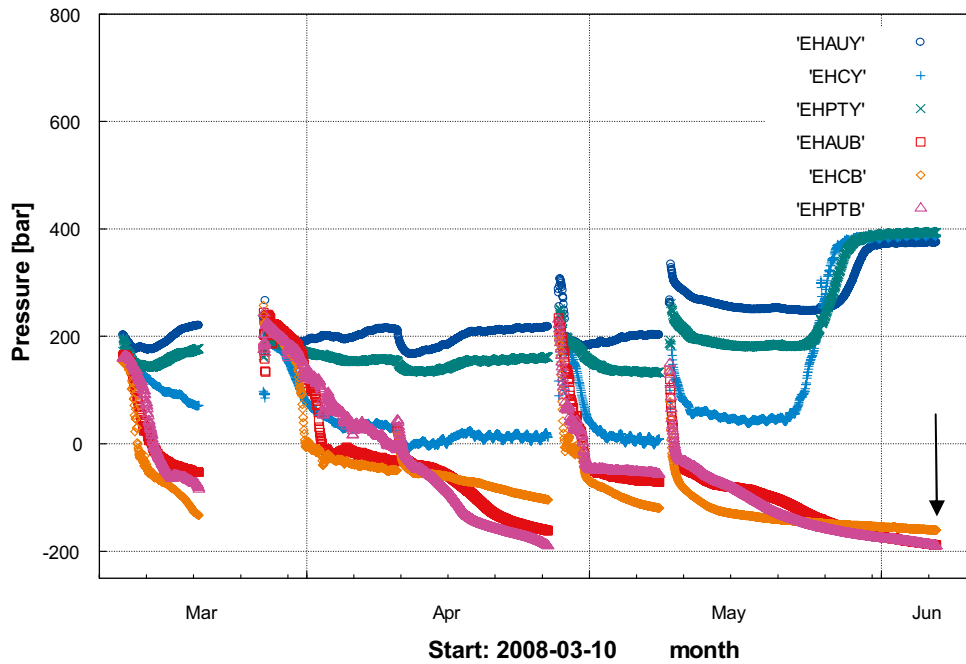

Figure A6-1. Redox potential measurements (Eh) by gold, glassy carbon and platinum electrodes in the borehole section (EHAUB, EHCB and EHPTB) and at the surface by gold, glassy carbon and platinum (EHAUY, EHCY and EHPTY).

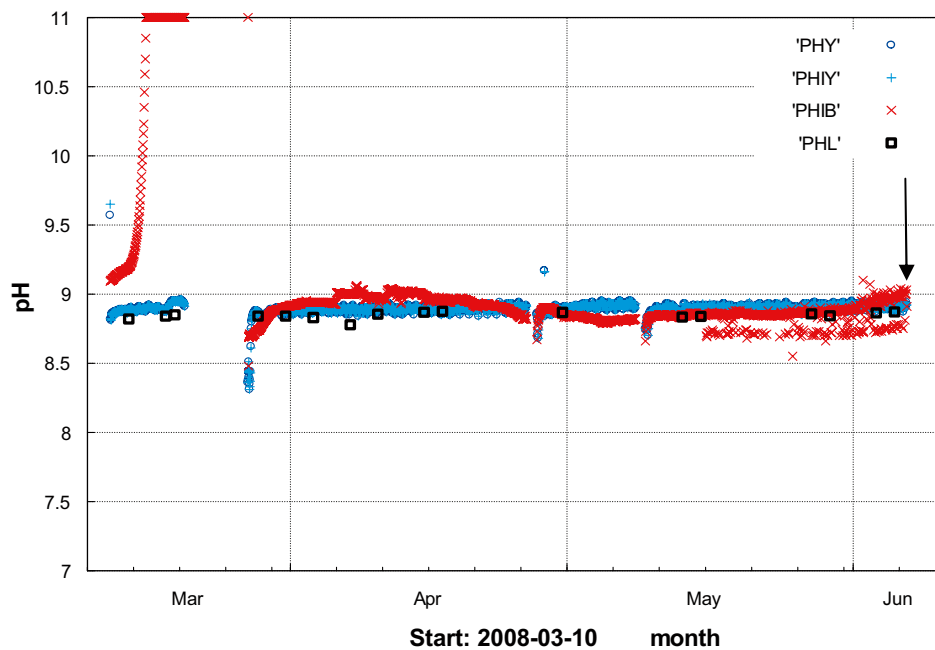

Figure A6-2. Measurements of pH by one glass electrode in the borehole section (PHIB; PHB was malfunctioning) and two glass electrodes at the surface (PHY and PHIY). The laboratory pH in each collected sample (PHL) is given for comparison. The arrow shows the chosen representative pH values for the borehole section.

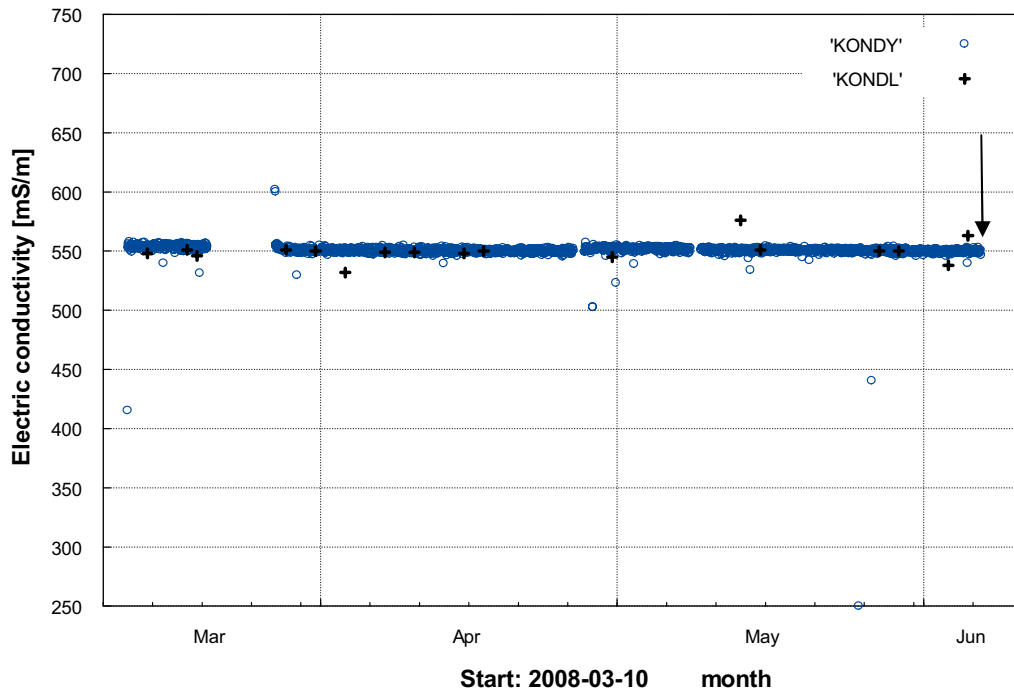

Figure A6-3. Electric conductivity measurements in the surface Chemmac cell (KONDY). The laboratory conductivity in each collected sample (KONDL) is given for comparison. The arrow shows the chosen representative electric conductivity value for the borehole section.

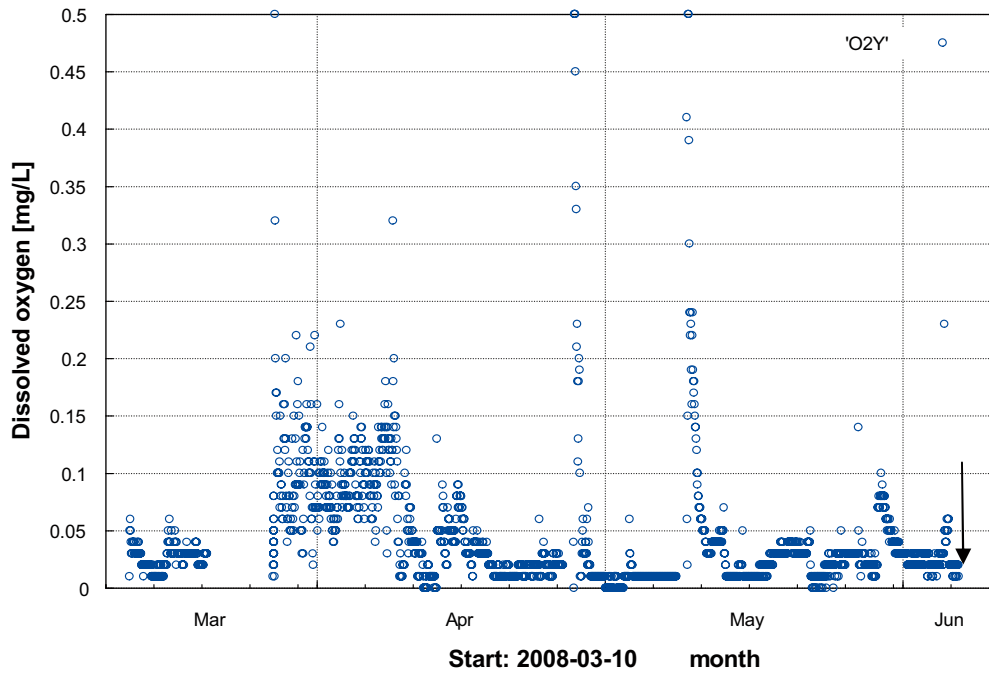

Figure A6-4. Dissolved oxygen measurements (O2Y) in the surface measurement cell. The arrow shows the chosen representative oxygen value for the borehole section.

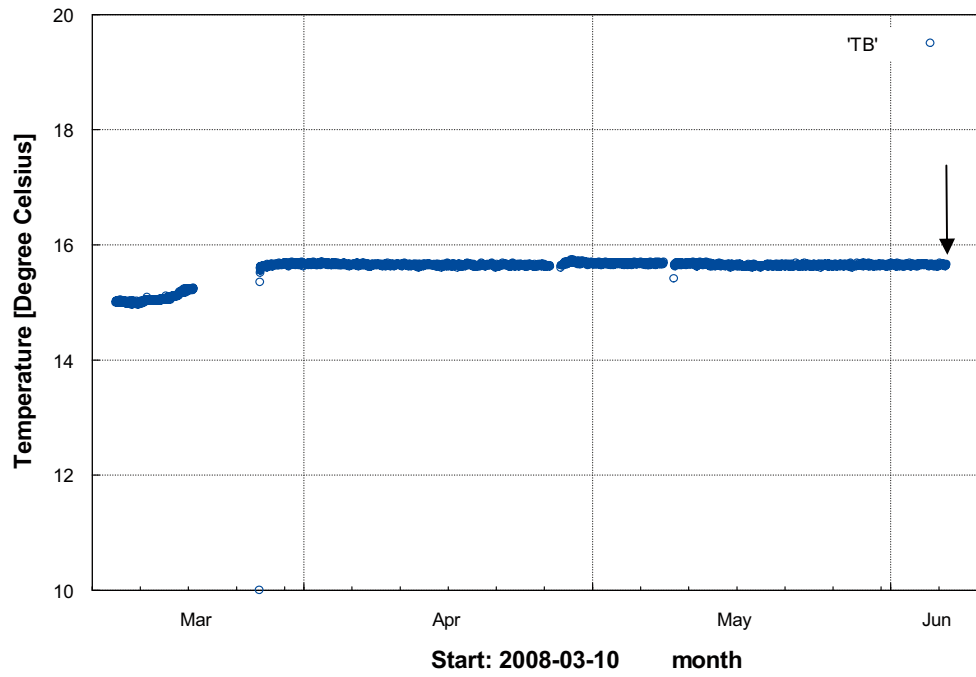

Figure A6-5. Temperature of the groundwater in the borehole section (TB).

Sampling and analytical methods

Table A7-1. Sample handling routines and analytical methods

Component group	Component/ element	Sample container (material)	Volume (mL)	Filtering	Preparation/Conservation*	Analysis method	Analysis within – or delivery time to lab.
Drill water	Uranine	Plastic (brown)	100	No	No	Spectrofluorometry	–
Anions	HCO ₃ ⁻ pH (lab) Cond. (lab)	Plastic	250	No	No	Titration Pot. meas, Cond. meas.	The same day – maximum 24 hours
	Cl ⁻ , SO ₄ ²⁻ , Br ⁻ , F ⁻	Plastic	250	Yes (in connection to the analysis)	No	Titration (Cl ⁻) IC (Cl ⁻ , SO ₄ ²⁻ , Br ⁻ , F ⁻) ISE (F ⁻)	Not critical (month)
	Br ⁻ (control sample to external laboratory)	Plastic	100	Yes	No	ICP MS	Not critical (month)
	I ⁻	Plastic	100	Yes	No	ICP MS	Not critical (month)
Cations etc	Na, K, Ca, Mg, S(tot), Si(tot), Fe, Mn, Li, Sr	Plastic (acid washed)	100	Yes	Yes (1 mL HNO ₃)	ICP AES ICP MS	Not critical (month)
Fe(II), Fe(tot)	Fe(II), Fe(tot)	Plastic-PEH (acid washed)	500	Yes	Yes (5 mL HCl)	Spectrophotometry Ferrozine method	As soon as possible the same day
Hydrogen sulphide	HS ⁻	Glass (Winkler)	About 120×2	Yes	1 mL 1 M NaOH+ 1 mL 1M ZnAc	Spectrophotometry	Immediately or if conserved, a few days
Nutrient salts	NO ₂ -N, NO ₃ -N+NO ₂ -N, PO ₄ -P	Plastic	250	Yes	Frozen, transported in isolated bag	Spectrophotometry	Short transportation time
	NH ₄ -N	Glass (measuring flask)	50	No	No	Spectrophotometry	Maximum 24 hours
Environmental metals etc	Al, As, Ba, B, Cd, Co, Cr, Cu, Hg, Mo, Ni, P, Pb, V, Zn, In	Plastic	100	Yes	Yes (1 mL HNO ₃)	ICP AES ICP MS	Not critical (month)
Lanthanoids, U, Th, etc	Sc, Rb, Y, Zr, I, Sb, Cs, La, Hf, Tl, Ce, Pr, Nd, Sm, Eu, Gd, Tb, Dy, Ho, Er, Tm, Yb, Lu, U, Th	Plastic	100	Yes	Yes (1 mL HNO ₃)	ICP AES ICP MS	Not critical (month)
Dissolved organic Carbon	DOC	Plastic	250	Yes	Frozen, transported in isolated bag	UV oxidation, IR	Short transportation time
Total organic Carbon	TOC	Plastic	250	No	Frozen, transported in isolated bag	UV oxidation, IR	Short transportation time
Environmental isotopes	δ ² H, δ ¹⁸ O	Plastic	100	No	– –	MS	Not critical (month)
Tritium	³ H (enhanced.)	Plastic (dry bottle)	500	No	–	LSC	Not critical (month)
Chlorine-37	δ ³⁷ Cl	Plastic	500	No	–	ICP MS	Not critical (month)

Component group	Component/ element	Sample container (material)	Volume (mL)	Filtering	Preparation/Conservation*	Analysis method	Analysis within – or delivery time to lab.
Carbon isotopes	$\delta^{13}\text{C}$, pmC (^{14}C)	FLPE	125×2	No	–	(A)MS	A few days
Sulphur isotopes	$\delta^{34}\text{S}$	Plastic	1,000	No	–	Combustion, ICP MS	No limit
Strontium-isotopes	$^{87}\text{Sr}/^{86}\text{Sr}$	Plastic	100	No	–	TIMS	Days or Week
Uranium and Thorium isotopes	^{234}U , ^{235}U , ^{238}U , ^{232}Th , ^{230}Th ,	HDPE	1,000	No	–	Chemical separat. Alfa/ gamma spectrometry	No limit
Boron isotopes	$^{10}\text{B}/^{11}\text{B}$	Plastic	100	Yes	Yes (1 mL HNO_3)	ICP MS	No limit
Radon and Radium isotopes	^{222}Rn , ^{226}Ra	HDPE	1,000	No	No	LSC	Immediate transport
Dissolved gas (content and composition)	Ar, He, N_2 , CO_2 , O_2 , CH_4 , H_2 , CO , C_2H_6 , C_2H_4 , C_2H_2 , C_3H_8 , C_3H_6	Cylinder of stainless steel	200	No	No	GC	Immediate transport
Colloids	Filter series and fractionation (Analysis of cations and environmental metals)	Polycarbonate filters	2.0, 0.4, 0.2 and 0.05 μm	–	Ar atmosphere	ICP AES ICP MS	Immediate transport
Density	Density	Plastic	250	No	–	Pycnometer	–
Archive samples with acid	–	Plastic (washed in acid)	100×2 **	Yes	Yes (1 mL HNO_3)	–	Storage in freeze container
Archive samples without acid	–	Plastic	250×2 **	Yes	No	–	Storage in freeze container

* Suprapur acid is used for conservation of samples.

** Minimum number, the number of archive samples can vary depending on how many similar samples collected at the same occasion.

Abbreviations and definitions:

IC	Ion Chromatograph
ISE	Ion Selective Electrode
ICP AES	Inductively Coupled Plasma Atomic Emission Spectrometry
ICP MS	Inductively Coupled Plasma Mass Spectrometry
IR	Infra Red detection
MS	Mass Spectrometry
LSC	Liquid Scintillation Counting
(A)MS	(Accelerator) Mass Spectrometry
TIMS	Thermal Ionization Mass Spectrometry
GC	Gas Chromatography

Table A7-2. Reporting limits and measurement uncertainties (updated in 2008)

Component	Method ¹	Reporting limits (RL), detection limits (DL) or range ²	Unit	Measurement uncertainty ³
HCO ₃ ⁻	Alkalinity titration	1	mg/L	4%
pH	Potentiometric	3–10	pH unit	±0.10 pH units
Cond.	Electrical Conductivity Meas.	1–150	mS/m	5%
		150–10,000		3%
Cl ⁻	Mohr titration	≥70	mg/L	5%
Cl ⁻	IC	0.5–70		8%
SO ₄ ²⁻	IC	0.5	mg/L	12%
Br ⁻	IC	DL 0.2, RL 0.5	mg/L	15%
Br ⁻	ICP SFMS	0.001, 0.004, 0.010 ⁴		25%
F ⁻	IC	DL 0.2, RL 0.5	mg/L	13%
F ⁻	ISE	DL 0.1, RL 0.2		12%
I ⁻	ICP SFMS	0.001, 0.004, 0.010 ⁴	mg/L	25% ⁵
Na	ICP AES	0.1	mg/L	13%
K	ICP AES	0.4	mg/L	12%
Ca	ICP AES	0.1	mg/L	12%
Mg	ICP AES	0.09	mg/L	12%
S(tot)	ICP AES	0.16	mg/L	12%
Si(tot)	ICP AES	0.03	mg/L	14%
Sr	ICP AES	0.002	mg/L	12%
Li	ICP AES	4	µg/L	12%
Fe	ICP AES	0.02	mg/L	13.3% ⁶
Fe	ICP SFMS	0.0004, 0.002, 0.004 ⁴	µg/L	20% ⁶
Mn	ICP AES	0.003	µg/L	12% ⁵
Mn	ICP SFMS	0.00003, 0.00004, 0.0001 ⁴	mg/L	53% ⁶
Fe(II), Fe(tot)	Spectrophotometry	DL 0.006, RL 0.02	µg/L	0.005 (0.02–0.05 mg/L) 9% (0.05–1 mg/L) 7% (1–3 mg/L)
HS ⁻	Spectrophotometry	DL 0.006, RL 0.02	µg/L	25%
NO ₂ -N	Spectrophotometry	0.1	µg/L	2%
NO ₂ -N +NO ₃ -N	Spectrophotometry	0.2	µg/L	0.2 (0.2–20µg/L) 2%(> 20 µg/L)
NH ₄ -N	Spectrophotometry	11	µg/L	30% (11–20 µg/L) 25% (20–50 µg/L) 12% (50–1,200 µg/L)
PO ₄ -P	Spectrophotometry	0.7	µg/L	0.7 (0.7–20µg/L) 3% (> 20 µg/L)
Al	ICP SFMS	0.2, 0.3, 0.7 ⁴	µg/L	18% ⁶
Zn	ICP SFMS	0.2, 0.8, 2 ⁴	µg/L	16, 18, 26% ⁶
Ba, Cr, Mo	ICP SFMS	0.01, 0.04, 0.1 ⁴	µg/L	Ba 15% ⁴ , Cr 22% ⁵ Mo 39% ⁶
Pb	ICP SFMS	0.01, 0.1, 0.3 ⁴	µg/L	15% ⁶
Cd	ICP SFMS	0.002, 0.02, 0.5 ⁴	µg/L	16% ⁶
Hg	ICP AFS	0.002	µg/L	11% ⁶
Co	ICP SFMS	0.005, 0.02, 0.05 ⁴	µg/L	26% ⁶
V	ICP SFMS	0.005, 0.03, 0.05 ⁴	µg/L	18% ⁶
Cu	ICP SFMS	0.1, 0.2, 0.5 ⁴	µg/L	14% ⁶
Ni	ICP SFMS	0.05, 0.2, 0.5 ⁴	µg/L	16% ⁶
P	ICP SFMS	1, 5, 40 ⁴	µg/L	16% ⁶
As	ICP SFMS	0.01 (520 mS/m)	µg/L	59% ⁶
La, Ce, Pr, Nd, Sm, Eu, Gd, Tb, Dy, Ho, Er, Tm, Yb, Lu	ICP SFMS	0.005, 0.02, 0.05 ⁴	µg/L	20%, 20%, 25% ⁶
Sc, In, Th	ICP SFMS	0.05, 0.2, 0.5 ⁴	µg/L	25% ⁶
Rb, Zr, Sb, Cs	ICP SFMS	0.025, 0.1, 0.25 ⁴	µg/L	15%, 20%, 20% ⁵ , 25% ⁶

Component	Method ¹	Reporting limits (RL), detection limits (DL) or range ²	Unit	Measurement uncertainty ³
Tl	ICP SFMS	0.025, 0.1, 0.25 ⁴	µg/L	14% ^{5,6}
Y, Hf	ICP SFMS	0.005, 0.02, 0.05 ⁴	µg/L	15%, 20%, 20% ⁵ , 25% ⁶
U	ICP SFMS	0.001, 0.005, 0.01 ⁴	µg/L	14%, 16% ⁵ , 19%, 18%, 21% ⁶
DOC	UV oxidation, IR Carbon analysator	0.5	mg/L	8%
TOC	UV oxidation, IR Carbon analysator	0.5	mg/L	10%
δ ² H	MS	2	‰ SMOW ⁸	0.9 (one standard dev.)
δ ¹⁸ O	MS	0.1	‰ SMOW ⁸	0.1 (one standard dev.)
³ H	LSC	0.8	TU ⁹	0.8 TU
δ ³⁷ Cl	ICP MS	0.2	‰ SMOC ¹⁰	0.2 ¹⁷
δ ¹³ C	A (MS)	–	‰ PDB ¹¹	0.3 ¹⁷
pmC (¹⁴ C)	A (MS)	–	pmC ¹²	0.4 ¹⁷
δ ³⁴ S	MS	0.2	‰ CDT ¹³	0.4 (one standard dev.)
⁸⁷ Sr/ ⁸⁶ Sr	TIMS	–	No unit (ratio) ¹⁴	0.00002
¹⁰ B/ ¹¹ B	ICP SFMS	–	No unit (ratio) ¹⁰	–
²³⁴ U, ²³⁵ U, ²³⁸ U, ²³² Th, ²³⁰ Th	Alfa spectr.	0.0001	Bq/L ¹⁵	≤ 5% (Counting statistics uncertainty)
²²² Rn, ²²⁶ Ra	LSC	0.015	Bq/L	≤5% (Counting statistics uncertainty)

- Many elements may be determined by more than one ICP technique depending on concentration range. The most relevant technique and measurement uncertainty for the concentrations normally encountered in groundwater are presented. In cases where two techniques were frequently used, both are displayed.
- Reporting limits (RL), generally 10×standard deviation, if nothing else is stated. Measured values below RL or DL are stored as negative values in SICADA (i.e. –RL value and –DL value).
- Measurement uncertainty reported by the laboratory, generally as ± percent of measured value in question at 95% confidence interval.
- Reporting limits at electrical cond. 520 mS/m, 1,440 mS/m and 3,810 mS/m respectively.
- Measurement uncertainty at concentrations 100×RL.
- Measurement uncertainty at concentrations 10×RL.
- Determined only in surface waters. PON, POP and POC refers to Particulate Organic Nitrogen, Phosphorous and Carbon, respectively.
- Per mille deviation¹⁶ from SMOW (Standard Mean Oceanic Water).
- TU=Tritium Units, where one TU corresponds to a tritium/hydrogen ratio of 10⁻¹⁸ (1 Bq/L Tritium = 8.45 TU).
- Per mille deviation¹⁶ from SMOC (Standard Mean Oceanic Chloride).
- Per mille deviation¹⁶ from PDB (the standard PeeDee Belemnite).
- The following relation is valid between pmC (percent modern carbon) and Carbon-14 age:

$$\text{pmC} = 100 \times e^{((1950-y-1.03t)/8274)}$$
where y = the year of the C-14 measurement and t = C-14 age.
- Per mille deviation¹⁶ from CDT (the standard Canyon Diablo Troilite).
- Isotope ratio without unit.
- The following expressions are applicable to convert activity to concentration, for uranium-238 and thorium-232: 1 ppm U = 12.4 Bq/kg²³⁸U, 1 ppm Th = 3.93 Bq/kg²³²Th.
- Isotopes are often reported as per mill deviation from a standard. The deviation is calculated as:

$$\delta\text{‰} = 1,000 \times (K_{\text{sample}} - K_{\text{standard}}) / K_{\text{standard}}$$
where K= the isotope ratio and ‰ = ²H, ¹⁸O, ³⁷Cl, ¹³C or ³⁴S etc.
- SKB estimation from duplicate analyses by the contracted laboratory.

Quantification of Colloids in Natural Groundwater from Laxemar Borehole KLX27A, Section (641.5 to 650.56) m

W. Hauser, R. Götz, T. Schäfer, H. Geckeis.

Forschungszentrum Karlsruhe GmbH, Institut für Nukleare Entsorgung (INE) P.O. Box 3640, D-76021 Karlsruhe, Germany.

Introduction

Colloid analysis has been performed in groundwater samples collected during the site investigation program at Laxemar (Oskarshamns kommun), close to the nuclear power station Oskarshamn, Sweden. Samples from one borehole have been collected in two stainless steel cylinders, preventing as much as possible the oxidation of the anoxic groundwater samples. They were sent to INE for laboratory analysis. Colloid analysis was subsequently performed by the laser-induced breakdown detection (LIBD) in the laboratory using a closed flow-through detection cell, again without atmosphere contact. Furthermore, a complete geochemical analysis of the water samples was performed.

The geological situation in Laxemar may be different from that found at various places in the Äspö tunnel. The aim of this study is to investigate the natural background colloid concentration in this specific Laxemar borehole section. Additionally, we compared the data with those obtained from other sites.

Experimental

LIBD instrumentation

The principle of LIBD is based on the generation of a dielectric breakdown in the focus region of a pulsed laser beam. As the threshold energy (irradiance) to induce a breakdown is lower for solids than for liquids or gas, the breakdown can be generated selectively in particles dispersed in solution at a suitable pulse energy.

A schematic diagram of the mobile LIBD set-up used in the present work is shown Figure A8-1. A pulsed laser beam with a frequency of 15 Hz at 532 nm wavelength from a small Nd:YAG-laser (Continuum Minilite I) is focused (15 mm focal length) into the center of a flow-through detection cell, after passing through a variable attenuator and a beam splitter. The plasma generated at a breakdown event is monitored by a microscope equipped with a CCD monochrome camera triggered by the incident laser pulse and recorded by a PC controlled image processing system. A breakdown shock wave propagated in the sample solution is detected simultaneously by an acoustic sensor (piezoelectric transducer) that is connected to the surface of the cell. Both, the energy and the acoustic signal are recorded by an analog-digital converter interface in a PC. Colloid concentrations are derived from the respective breakdown probability, represented by the number of breakdown events per number of laser shots, and the range of breakdown events within the laser beam axis determined by optical inspection of the laser focus area within the flow through cell. Colloid number concentrations (N/ml) are given relative to a calibration with polystyrene reference colloids. Mass concentrations are calculated by assuming an average colloid density of 2.7 g/cm³ and spherical particle shape. A more detailed description of data evaluation is given in 1.

The mobile instrumentation of LIBD is combined with a Millipore ultra-pure water processing unit for on-line cleaning the flow-through detection cell of LIBD and to allow for the frequent control of the instrument background. The whole system, which is set up to a compact mobile unit can be transported by a van for field experiments.

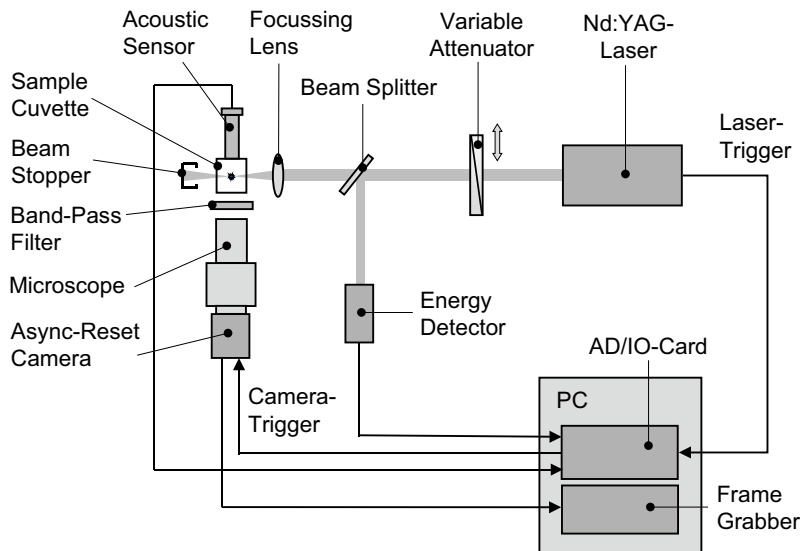

Figure A8-1. Schematic diagram of the mobile laser-induced breakdown detection system.

High-pressure flow-through detection cell

The LIBD has been operated in the CRR migration experiments (Grimsel Test-Site, Switzerland)¹ under low pressure conditions with commercially available quartz detection cells (fluorescence cells) for batch (laboratory experiments) or flow-through sampling. These cells have a sample volume of 3 ml at 10 mm absorption length. A new flow-through detection cell has been developed constraining water pressures of about 35 bar for *in situ* investigations in the Äspö Hard Rock Laboratory access tunnel (Sweden)², and in the Kraftwerke Oberhasli (KWO) access tunnel close to the Grimsel Test Site³. This detection cell has also been applied in connection with a borehole sampling system for the detection of groundwater colloids sampled at a natural analogue site (Ruprechtov, Czech Republic).

Figure A8-2 presents the high-pressure detection cell developed by INE. Without changing the optical path of the laser light, the detection cell fits into the same mount used for the silica cell. The new cell, fabricated from PEEK (polyether etherketone) is lined outside with a stainless steel housing (black parts in Figure A8-2). Four optical windows, one at each side are applied for the passing laser light (absorption length 12 mm), the microscope and for inspection. They consist of sapphire with 2 mm thickness. The groundwater flow enters the inner cell volume of 0.8 ml from the base via a PEEK tubing. The outlet is on the top of the cell. The high-pressure detection cell is successfully tested for a water pressure up to 60 bar.

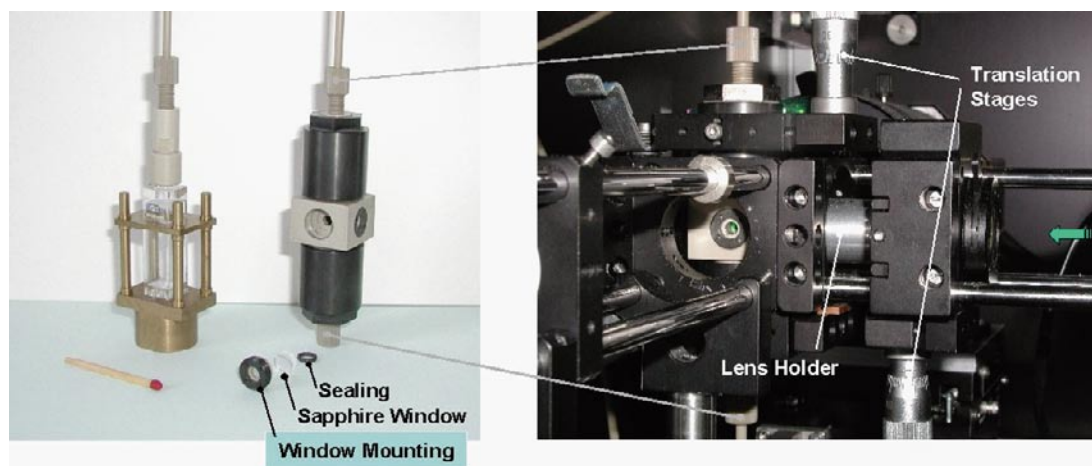

Figure A8-2. LIBD high-pressure flow-through detection cell (left: conventional flow-through silica detection cell).

Borehole sampling

Samples were taken at June 9, 2008 from Laxemar borehole KLX27A, section between (641.5 to 650.56) m. The vertical depth was approximately 572 m with a measured pressure in the borehole section of 57 bar. The samples have been filled in the SKB steel cylinders PVB 220 and PVB 9506-1.

Three days after sampling the cooled samples arrived at the INE where they have been stored in a fridge (Temp. about 10°C) until colloid detection on June 17 and 19, respectively.

Configuration of laboratory experiments

Each sampling cylinder was connected with the LIBD detection cell and the detection cells for pH-, Eh-, electrical conductivity-, oxygen content-detection and for taking samples for chemical groundwater analysis. As far as possible pressure resistant versions of the sensors are selected. In the specifications of the pH-/Eh-electrodes (Hamilton POLILYTE PLUS/OXYTRODE) a maximum groundwater pressure of 50 bar/16 bar is designated. The maximum pressure for the oxygen-detector (Mettler Toledo InPro 6900) is specified with 6 bar and the electrical conductivity-detector (InPro 7000-VP) is 34 bar.

A scheme of the corresponding laboratory setup is plotted in Figure A8-4 with an image of the experimental configuration in Figure A8-5.

At first the tubings around the sampling cylinder are intensively cleaned by evacuation and flushing with Argon. Then a HPLC-pump is used to fill all tubings on the water side of the sampling cylinder with ultra-pure water and to set the water pressure according the hydrostatic pressure of the samples. This was the expected water pressure in the sampling cylinder. The gas side of the sampling cylinder is then filled with the corresponding Argon gas pressure.

Now one of the top valves of the sampling cylinder can be opened without contact of the sampled groundwater with atmospheric oxygen. With Argon gas the groundwater is pressed out from the sampling cylinder through the LIBD detection cell via a degasser to avoid occasionally occurring gas bubbles which interfere the colloid detection. Behind the LIBD detection cell a back pressure regulator (BPR 1) set to 34 bar is installed. Additional detection cells with pressure resistant electrodes for Eh, pH, Oxygen, a sensor for electrical conductivity and a sensor for the pressure detection are arranged downstream.

Before the sampling outlet an additional back pressure regulator (BPR 2), set to 7 bar, is installed. This overpressure in the whole system avoids further contact to oxygen. Data of this geo-monitoring system are stored on a personal computer with a data logger as a function of time. This allows to separate temporary fluctuating data, especially during the starting period when the detection cell and the geo-monitoring system are contaminated and do not contain the sampled groundwater, respectively.

Groundwater batch samples are collected at the outlet of the pressure regulator for chemical analysis with ICP-AES, ICP-MS and for the detection of inorganic carbon (IC) and dissolved organic carbon (DOC).

Additionally, track-etched Polycarbonate filter samples (pore size 50 nm) have been taken for colloid analysis with SEM/EDX.



Figure A8-3. SKB stainless steel sampling cylinder (left: piston side, right: mounting adapter side).

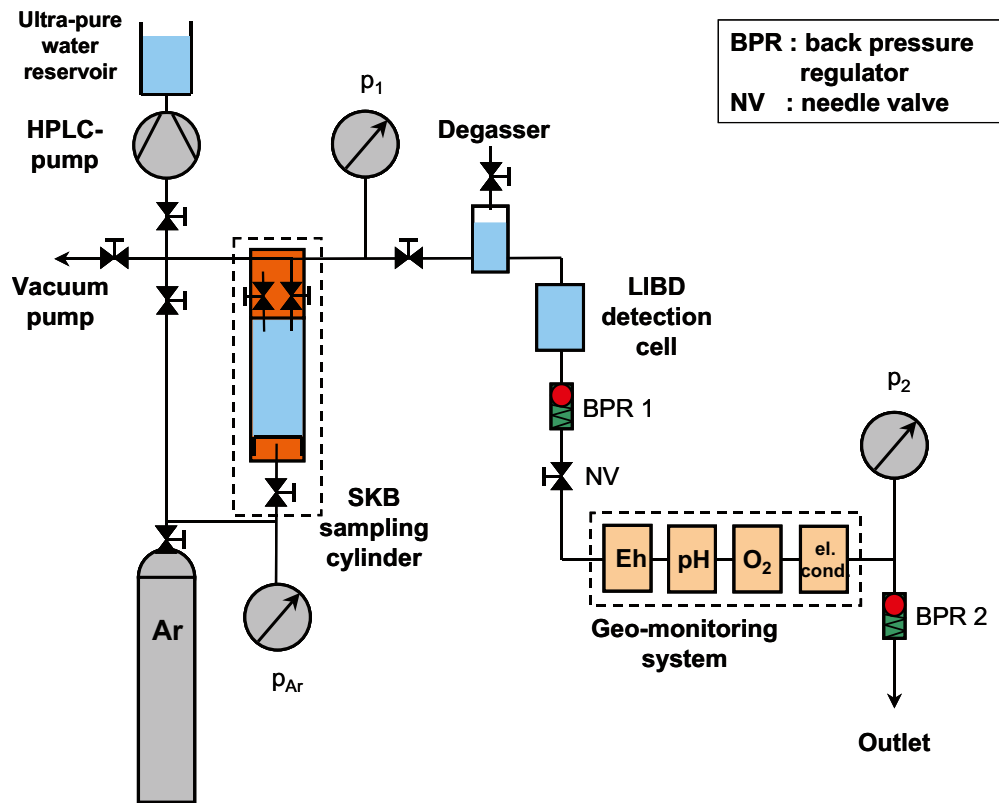

Figure A8-4. Scheme of the laboratory setup for in-line LIBD colloid analysis and groundwater monitoring.



Figure A8-5. Experimental configuration.

Results

Chemical analysis

Data from geo-monitoring as well as the chemical composition of the two groundwater samples are displayed in Table A8-1.

In the groundwater sample from container PVB220 a pH 7.74 was detected. It is equivalent to the pH detected so far in Laxemar (7.6 to 8.5). Not plausible is the much lower pH 6.44 detected in the parallel sample of the 'same' groundwater but from container PVB9506-1.

In the sample from container PVB220 the measured Eh indicates reducing conditions as expected from other measurements. Less reducing conditions have been detected in the parallel sample (Table A8-1). This seems to be caused by access of oxygen to the sampled groundwater (... see detected O₂ content).

Additionally, the chemical analysis of the parallel samples (Table A8-1) shows for most elements significantly higher concentrations in case of the sample from container PVB9506-1.

This Laxemar groundwater is determined by a Cl⁻-content of 1,700 mg/l.

The detected DOC of 811 mg/l and 1,462 mg/L are far too high and not plausible for a natural groundwater from Laxemar. It's rather an artefact.

Table A8-1. Monitored data of pH, Eh, el. conductivity, oxygen content and chemical analysis of the groundwater samples from Laxemar borehole KLX27A.

Borehole ID		KLX27A	
Secup - Seclow	m	641.5 - 650.56	
Sampling depth	m	572	
Hydr. pressure	bar	57	
Container ID		SKB PVB 220	SKB PVB 9506-1
Sample ID		LX10A	LX11A
pH		7.74	6.44
Redox (Ag/AgCl)	mV	-95	70
Eh (SHE)	mV	119	284
el. cond.	mS/m	553	587
O ₂ content	mg/l	<0.094	3.202
Na ⁺	mg/l	937.2	963.2
K ⁺	mg/l	0.846	1.315
Ca ²⁺	mg/l	112.5	202.9
Mg ²⁺	mg/l	0.63	3.37
Al ²⁺	mg/l	<	0.076
HCO ₃ ⁻ (a)	mg/l	8.65	7.49
Cl ⁻	mg/l	1704.4	1850.5
SO ₄ ²⁻	mg/l	99.14	112.5
Br ⁻	mg/l	14.8	14.1
F ⁻	mg/l	3.55	3.86
Si ⁴⁺	mg/l	2.6	3.68
Fe-ICP	mg/l	<	<
Mn ²⁺	mg/l	0.038	0.477
Li ⁺	mg/l	0.089	0.103
Si ²⁺	mg/l	1.05	2.53
DOC	mg/l	810.9	1461.5
IC	mg/l	1.7	1.47

(a) calculated from IC

Our estimate was that it may be caused by a “leaching of the gel electrolyte” of the Hamilton pH-/Eh-electrodes and a successive contamination of the sample with organic compounds. Additional investigations with the same experimental configuration (same flow-conditions and contact time) and a groundwater (KA2512A) from Äspö (because of limited Laxemar groundwater) led to a moderate increase of DOC from 7.1 mg/l (without contact with pH-/Eh-electrodes) to 7.8 mg/l (with contact to pH-/Eh-electrodes). A massive alternating pressure load of the electrodes resulted in an increase of DOC to 8.5 mg/L. This effect in the region of 1 mg/l can not explain the exceptionally high DOC in this Laxemar groundwater samples.

Other possible effects for such high DOC contents in this samples might result from sample contact with organic borehole drilling fluids, contamination of the steel cylinders with organic cleaning fluids, etc.

Colloid analysis

Data determined with the laser-induced breakdown detection system are listed in Table A8-2. Again, the volume of the samples was sufficient to perform four and seven colloid measurements with each PVB container (see logged raw data). So temporal variations in the colloid concentration during the elution of the groundwater are detected.

After evaluation of image processed data an average colloid size and concentration are derived. For the groundwater sample in container PVB 220 average particle diameters from 1,300–1,500 nm with corresponding mass concentrations of 230–330 µg/l are calculated.

Notably larger particles and higher mass concentrations are evaluated for the groundwater sample from container PVB 9506-1. Here diameters from 1,500 to 1,800 nm and mass concentrations of 700 to 1,000 µg/l are determined.

Figure A8-6 and Figure A8-7 show the corresponding SEM images of groundwater KLX27A colloids from sampling container PVB 220 and PVB 9506-1, respectively. The SEM images from sample PVB 220 show single colloids with sizes starting from about 100 nm (Figure A8-6a) up to agglomerates in the micron region (Figure A8-6d, f, g). With EDX analyzed elements of the agglomerates are mainly Fe, then Al, Si, Ca, and in some larger particles S, Zn.

Higher particle densities and larger agglomerates are found in the groundwater sample from container PVB 9506-1 (Figure A8-7). This is in accordance with the LIBD detected results in Table A8-2. It seems that the higher oxygen-content of the groundwater sample (Table A8-1) increased the amount and the size of the iron hydroxide colloids.

Table A8-2. LIBD data with average colloid diameter and colloid concentration of the analyzed groundwater from Laxemar borehole KLX27A, (641.5 to 650.6) m

Borehole ID		KLX27A				KLX27A			
Secup - Seclow	m	641.5-650.56				641.5-650.56			
Sampling depth	m	572				572			
Hydr. pressure	bar	57				57			
Container ID		SKB PVB 220				SKB PVB 9506-1			
LIBD /det. ID		LX10A	LX10B	LX10C	LX10D	LX11A	LX11B	LX11C	LX11D
BD-events		1221	1160	1252	1294	1377	1007	1283	940
Trigger-pulses		10000	10000	10000	10000	5000	3513	5000	3458
BD-probability		0.122	0.116	0.125	0.129	0.275	0.287	0.257	0.272
coll. num. density	N/ml	7.7E+04	7.2E+04	7.3E+04	6.6E+04	1.3E+05	1.4E+05	1.2E+05	1.4E+05
coll. diam.	nm	1300	1308	1372	1525	1773	1724	1745	1666
coll. mass conc.	µg/l	238	228	268	333	1003	1002	897	887
LIBD /det. ID					LX11F	LX11G	LX11H		
BD-events					1077	999	1056		
Trigger-pulses					4000	4000	4000		
BD-probability					0.269	0.25	0.264		
coll. num. density	N/ml				1.5E+05	1.4E+05	1.3E+05		
coll. diam.	nm				1499	1533	1674		
coll. mass conc.	µg/l				732	697	865		

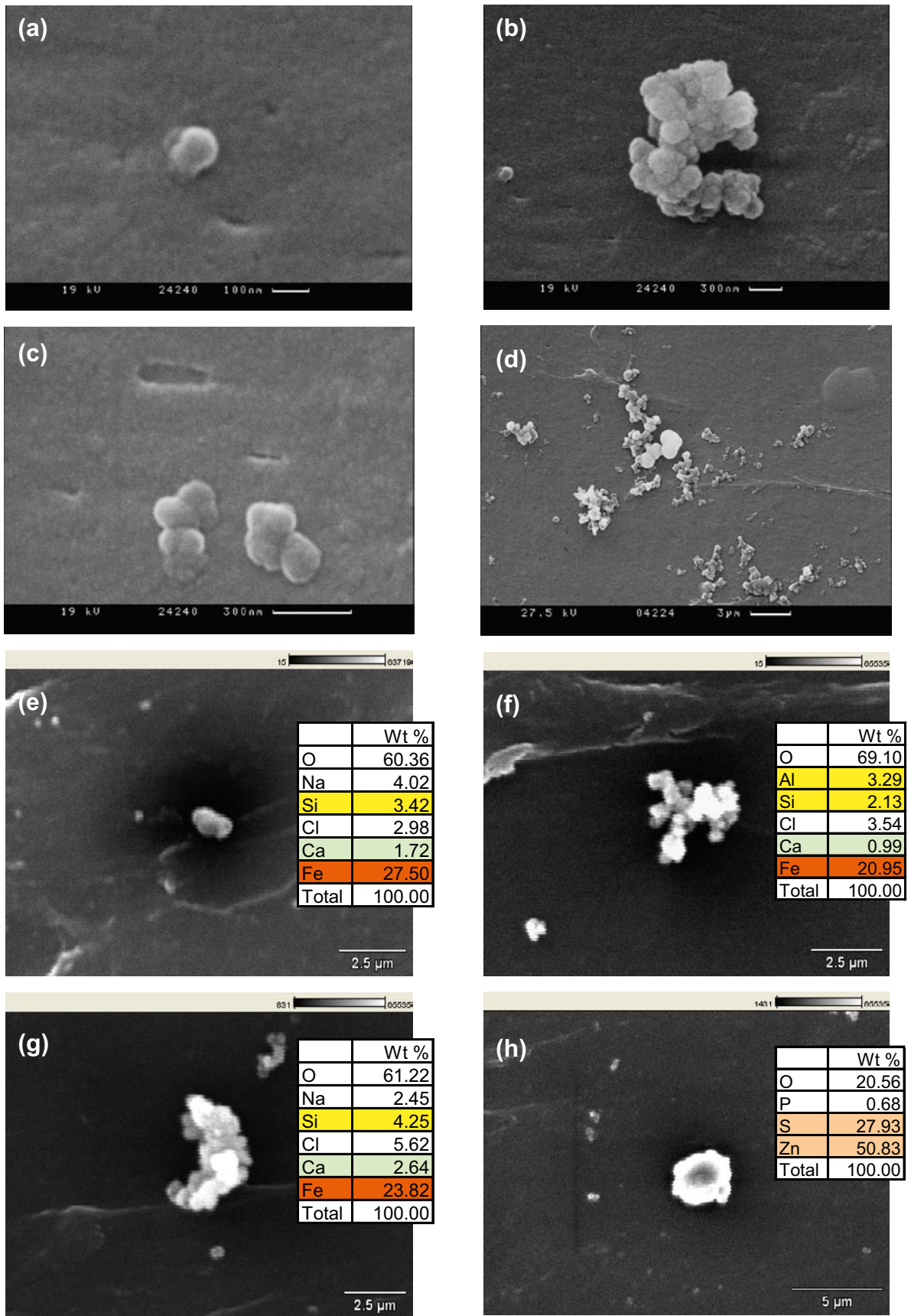

Figure A8-6. SEM images of groundwater KLX27A (641.5 to 650.56) m colloids on a 50 nm track-etched Polycarbonate filter (Sample from container PVB 220).

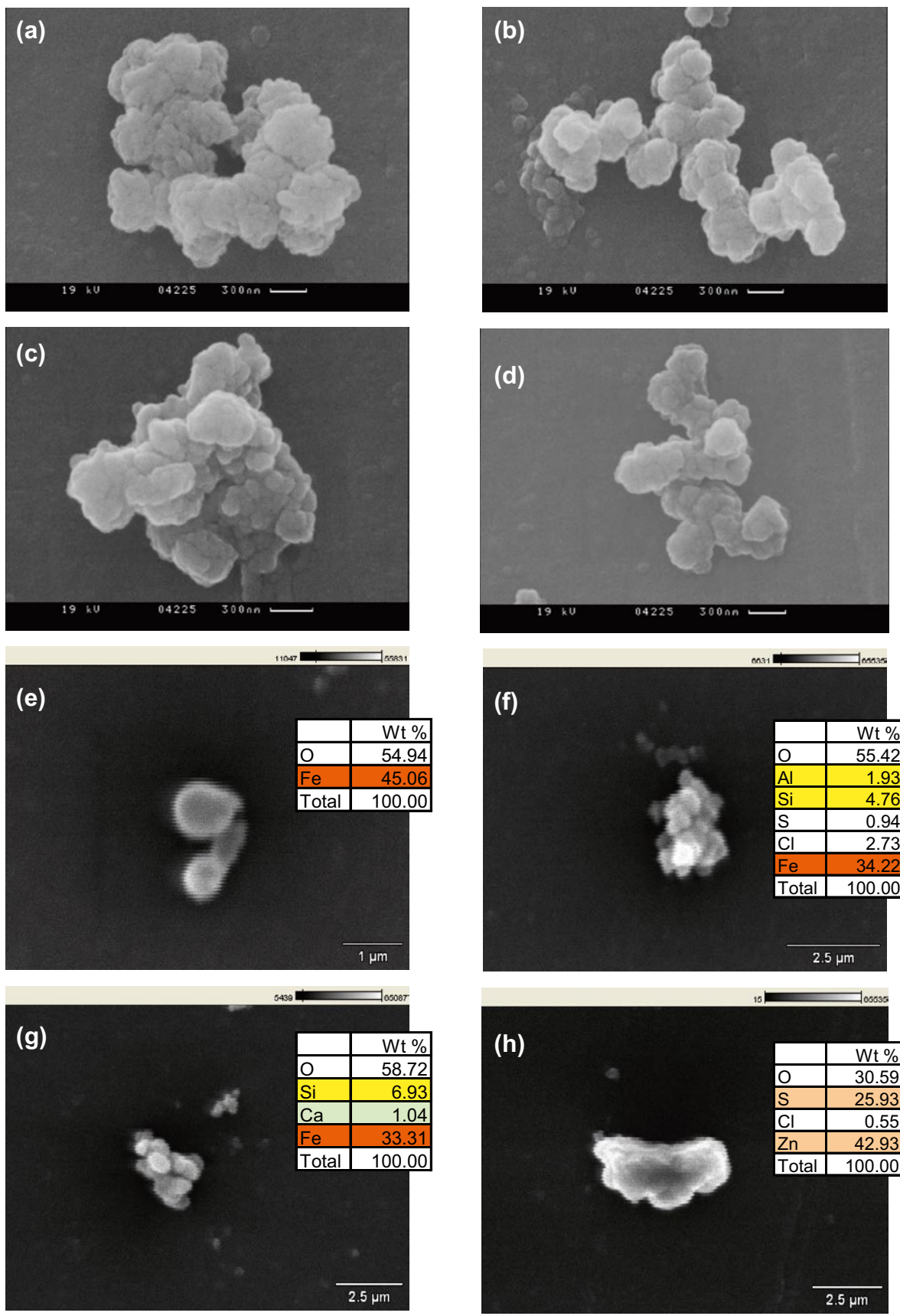

Figure A8-7. SEM images of groundwater KLX27A (641.5 to 650.56) m colloids on a 50 nm track-etched Polycarbonate filter (Sample from container PVB 9506-1).

Comparison with Äspö and Forsmark data

In the Äspö colloid project⁶ a series of boreholes along the access tunnel have been sampled and their groundwater was directly analyzed with the mobile LIBD system. A correlation was drawn (Figure A8-8) between the colloid concentration and the Cl⁻ concentration of the groundwater. At a Cl⁻ concentration of about 4,000 mg/l a remarkable decrease of the colloid concentration over 4 orders of magnitude down to the LIBD detection limit of about 10 ng/l was observed.

The new Laxemar KLX27A sample data and the previously reported Laxemar KLX17A, KLX13A data fit quite well into this correlation. But according to the colloid concentration correlation with groundwater salinity we expected a much lower colloid concentration for groundwater KLX15A from ~ 478 m sampling depth (Figure A8-8).

For the groundwater from KLX15A, vertical depth ~ 478 m it was possible to perform a 2 fraction evaluation of the LIBD data. This evaluation of a small 1st colloid fraction with particle sizes around the detection limit (20 nm) agreed well with the data derived from SEM images (see previous report). If one postulates that the large 2nd colloid fraction (Calcite, Alumino-Silicates, Silicates, ...) are mainly mechanically eroded particles from borehole drilling, then the 1st colloid fraction may represent the undisturbed colloids of the natural groundwater in this borehole zone.

This new Laxemar data come close to the Cl⁻ concentration dependency of the insitu-detected groundwater colloids in the Äspö-tunnel (Figure A8-8), as well as for groundwater with Cl⁻ concentrations > 5,000 mg/l.

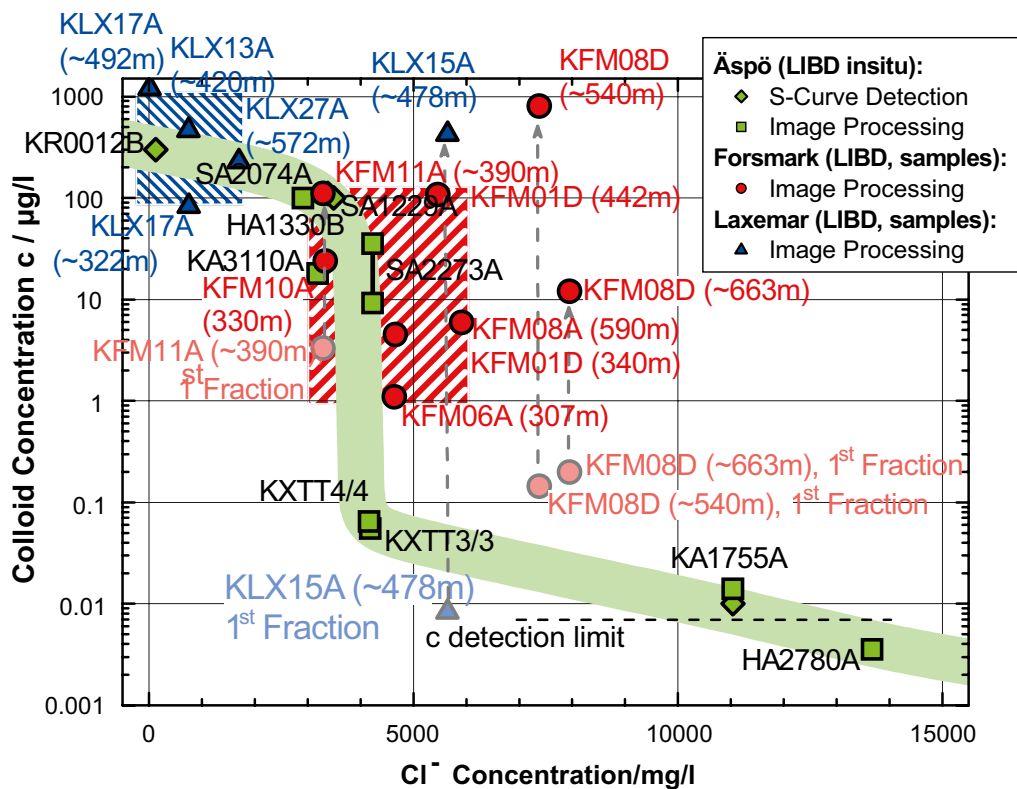
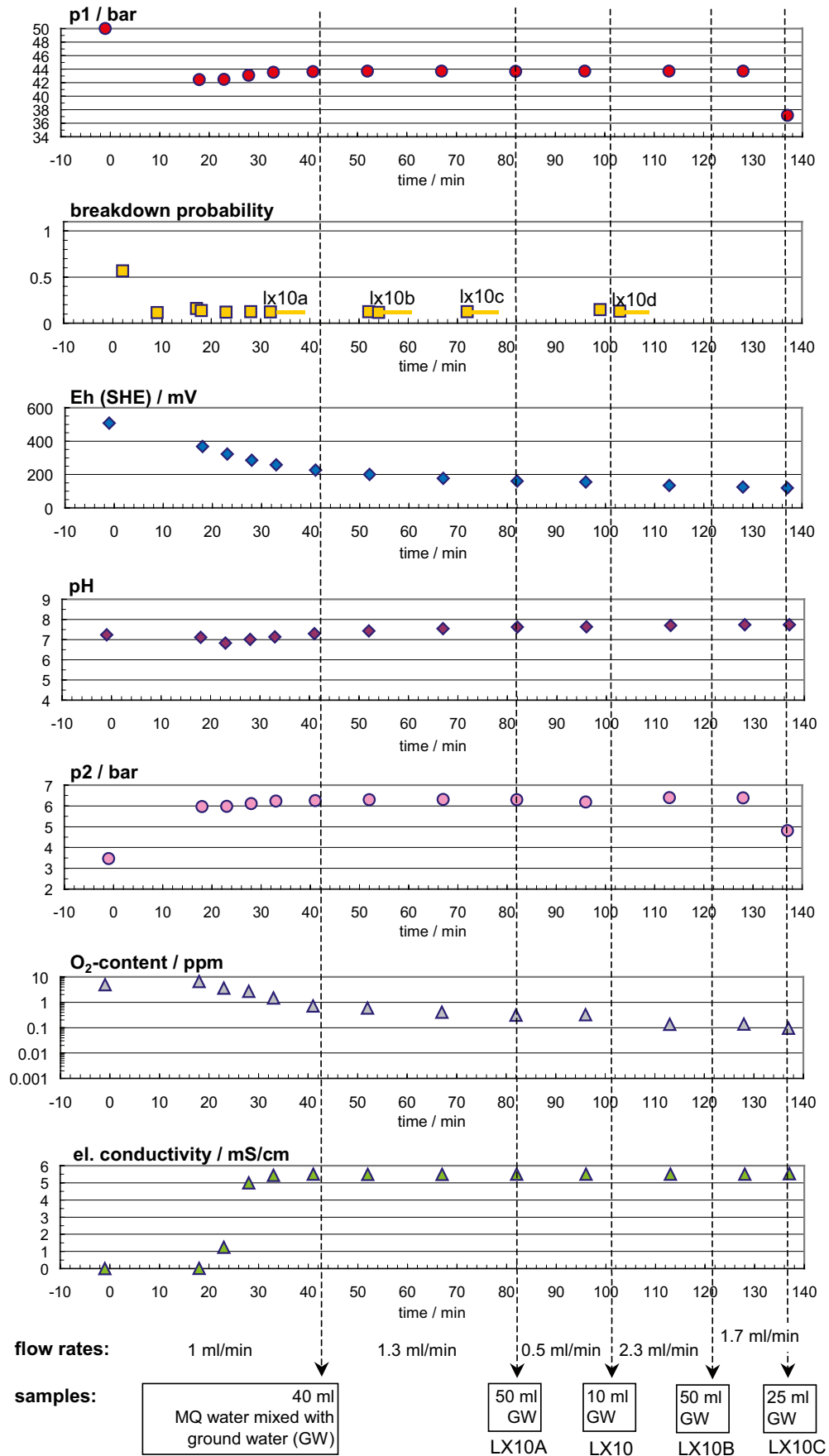

Figure A8-8. Correlation between colloid concentration and chloride concentration in different groundwater from Äspö /2/, /6/, Laxemar and Forsmark samples. (): sampling depths.

References

- ¹ **Hauser W, Geckeis H, Kim J I, Fierz Th, 2002.** A mobile laser-induced breakdown detection system and its application for the *in situ*-monitoring of colloid migration, Coll. Surf. 203, 2002, 37–45.
- ² **Hauser W, Geckeis H, Götz R, 2003.** *In situ* determination of natural groundwater colloids in granite shear zones along the Äspö HRL Tunnel by LIBD, 27th Int. conf. on Scientific Basis for Nuclear Waste Management, Kalmar, S, June 15–18, 2003.
- ³ **Geckeis H, Schäfer T, Rabung T, Hauser W, Möri A, Missana T, Eikenberg J, Degueldre C, Fierz T, Alexander W R, 2003.** Inorganic colloid borne actinide migration studied under *in situ* conditions at the Grimsel test site, 9th Int. conf. on Chemistry and Migration Behavior of Actinides and Fission Products in the Geosphere, Migration '03, Gyeongju, Korea, Sept. 21–26, 2003.
- ⁴ **Källgarden J, Andersson P, Holmqvist M, 2001.** Äspö HRL, TRUE-1 continuation project, History and current status on flow, pressure, water chemistry and installations at the TRUE-1 site, SKB International Progress Report IPR-02-46, Stockholm, S.
- ⁵ **Cornell R M, Schwertmann U, 1996.** The Iron Oxides-structure, properties, reactions, occurrence and uses. VCH-Verlag, Weinheim, 573 pp.
- ⁶ **Hauser W, Götz R, Geckeis H, Kienzler B, 2003.** *In situ* colloid detection in granite groundwater along the Äspö Hard Rock Laboratory access tunnel, In Laaksoharju, M, Äspö Hard Rock Laboratory, Status report of the Colloid investigation conducted at the Äspö HRL during the years 2000–2003, SKB International Progress Report IPR-03-38, Stockholm, S.

Logged raw data from elution of sampling container SKB PVB220 (KLX27A (641.5-650.56m))



Logged raw data from elution of sampling container SKB PVB9506-1 (KLX27A (641.5-650.56m))

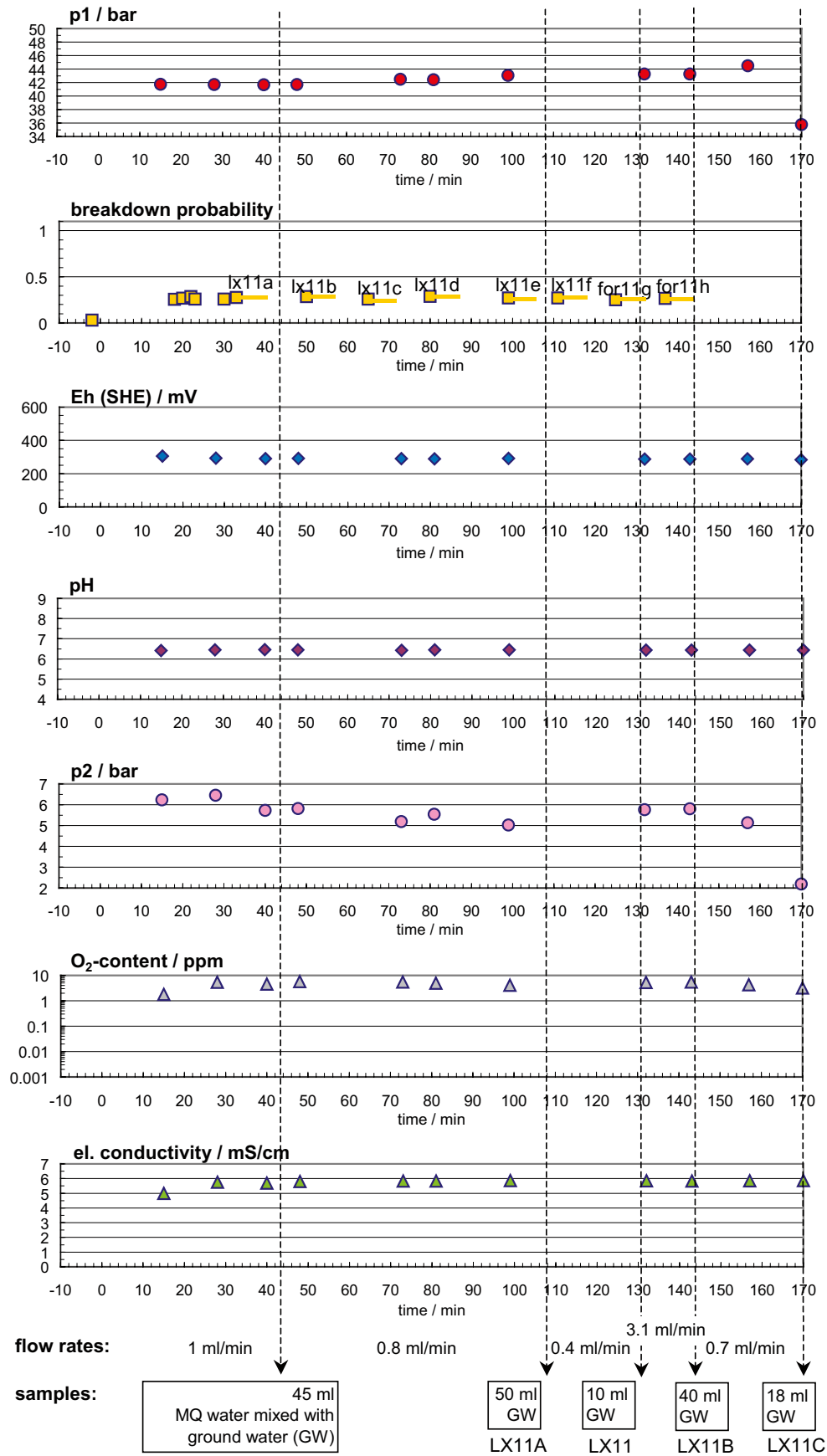

Compilation of water analysis data

Table A9-1. Water composition.

Idcode	Secup m	Seclow m	Sample no.	Sampling date	Charge Bal %	Na mg/L	K mg/L	Ca mg/L	Mg mg/L	HCO ₃ ⁻ mg/L	Cl ⁻ mg/L	SO ₄ ²⁻ mg/L	SO ₄ -S mg/L	Br ⁻ mg/l	F ⁻ mg/L	Si mg/L	Fe mg/L	Fe-tot mg/L	Fe(II) mg/L	Mn mg/L	Li mg/L	Sr mg/L
KLX27A	641.50	650.56	15427	2008-03-12	-	-	-	-	-	-	-	-	-	-	-	-	-	-	-	-	-	-
KLX27A	641.50	650.56	15471	2008-03-14	-	-	-	-	-	13.2	1700	-	-	-	-	-	-	-	-	-	-	-
KLX27A	641.50	650.56	15424	2008-03-18	-2.06	973	2.87	125	1.29	13.1	1700	106	38.3	8.50	3.45	5.22	0.0033	0.019	<0.006	0.0115	0.0842	2.06
KLX27A	641.50	650.56	15425	2008-03-19	-2.61	965	2.99	121	1.26	13.2	1700	106	38.1	8.58	3.52	5.08	0.0027	<0.006	<0.006	0.0116	0.0893	2.06
KLX27A	641.50	650.56	15428	2008-03-28	-	-	-	-	-	13.2	1700	-	-	-	-	-	-	-	-	-	-	-
KLX27A	641.50	650.56	15426	2008-03-31	-0.48	1010	3.01	126	1.31	13.4	1700	106	39.7	8.40	3.63	5.38	0.0058	<0.006	<0.006	0.0113	0.0921	2.14
KLX27A	641.50	650.56	15429	2008-04-03	-2.16	973	2.63	130	1.32	13.3	1710	106	39.4	8.89	3.45	5.21	<0.02	<0.006	<0.006	0.0118	0.0833	2.04
KLX27A	641.50	650.56	15430	2008-04-07	-3.16	949	2.67	125	1.30	13.2	1700	106	38.5	9.07	3.39	5.16	0.0042	<0.006	<0.006	0.0118	0.0821	2.00
KLX27A	641.50	650.56	15431	2008-04-10	-2.37	966	2.73	131	1.30	13.2	1710	106	38.6	8.35	3.55	5.10	<0.02	0.007	<0.006	0.0126	0.0844	2.03
KLX27A	641.50	650.56	15432	2008-04-15	-2.07	967	2.79	131	1.30	13.7	1700	105	38.9	8.10	3.60	5.12	0.0024	<0.006	<0.006	0.0121	0.0840	2.04
KLX27A	641.50	650.56	15433	2008-04-17	-2.01	967	2.52	127	1.31	13.6	1690	105	39.0	8.53	3.55	5.26	<0.02	<0.006	<0.006	0.0120	0.0831	2.03
KLX27A	641.50	650.56	15436	2008-04-28	-	-	-	-	-	-	-	-	-	-	-	-	-	-	-	-	-	-
KLX27A	641.50	650.56	15434	2008-04-30	-	*	*	*	*	13.9	1700	110	*	8.93	3.38	*	*	0.037	<0.006	*	*	*
KLX27A	641.50	650.56	15435	2008-05-13	-	*	*	*	*	13.2	1700	108	*	5.57	3.80	*	*	<0.006	<0.006	*	*	*
KLX27A	641.50	650.56	15437	2008-05-15	-	*	*	*	*	12.8	1680	105	*	7.07	3.73	*	*	0.012	0.006	*	*	*
KLX27A	641.50	650.56	15438	2008-05-19	-	*	*	*	*	13.2	1670	105	*	7.65	3.53	*	*	0.007	<0.006	*	*	*
KLX27A	641.50	650.56	15558	2008-05-22	-	*	*	*	*	13.0	1690	110	*	5.85	3.70	*	*	0.021	0.008	*	*	*
KLX27A	641.50	650.56	15559	2008-05-27	-	*	*	*	*	13.3	1700	109	*	6.20	3.63	*	*	0.012	<0.006	*	*	*
KLX27A	641.50	650.56	15560	2008-05-29	-	*	*	*	*	13.2	1700	109	*	6.08	3.43	*	*	0.008	<0.006	*	*	*
KLX27A	641.50	650.56	15561	2008-06-03	-	*	*	*	*	13.1	1700	108	*	5.80	3.48	*	*	0.007	<0.006	*	*	*
KLX27A	641.50	650.56	15587	2008-06-05	-2.02	973	3.02	126	1.45	13.1	1700	108	39.2	6.05	3.48	5.48	0.0006	0.007	<0.006	0.0130	0.084	2.08

- = Not analysed

< "value" = result less than detection limit

* Stored in freezer/refrigerator

ChargeBal % = Rel. charge balance error %

SICADA: water_composition

Idcode	Secup m	Seclow m	Sample no.	Sampling date	I ⁻ mg/L	pH	DOC mg/L	TOC mg/L	HS ⁻ mg/L	Drill water %	ElCond mS/m	NH ₄ -N mg/L	NO ₂ -N mg/L	NO ₃ -N mg/L	NO ₂ -N+NO ₃ -N mg/L	PO ₄ -P mg/L	P mg/L	Density g/mL
KLX27A	641.50	650.56	15427	2008-03-12	-	-	-	-	-	0.02	-	-	-	-	-	-	-	-
KLX27A	641.50	650.56	15471	2008-03-14	-	8.82	-	-	-	0.02	548	-	-	-	-	-	-	-
KLX27A	641.50	650.56	15424	2008-03-18	0.0763	8.84	1.3	1.2	<0.006	0.02	551	0.0075	<0.0002	0.0006	0.0007	0.0009	<0.005	-
KLX27A	641.50	650.56	15425	2008-03-19	0.0819	8.85	1.1	-	<0.006	0.02	546	0.0159	<0.0002	<0.0003	0.0004	0.0008	<0.005	-
KLX27A	641.50	650.56	15428	2008-03-28	-	8.84	-	-	-	0.02	551	-	-	-	-	-	-	-
KLX27A	641.50	650.56	15426	2008-03-31	0.0833	8.84	1.2	1.3	<0.006	0.02	550	0.0051	<0.0002	0.0039	0.0040	0.0006	<0.005	-
KLX27A	641.50	650.56	15429	2008-04-03	0.0832	8.83	1.3	-	<0.006	0.02	532	<0.0030	<0.0002	<0.0003	<0.0003	0.0006	-	-
KLX27A	641.50	650.56	15430	2008-04-07	0.0780	8.78	1.0	1.2	0.016	0.02	549	<0.0030	<0.0002	0.0023	0.0023	0.0007	0.0028	-
KLX27A	641.50	650.56	15431	2008-04-10	0.0808	8.86	1.2	-	0.013	0.02	549	0.0030	<0.0002	0.0005	0.0005	0.0007	-	-
KLX27A	641.50	650.56	15432	2008-04-15	0.0766	8.87	1.1	1.0	0.010	0.02	548	<0.0030	<0.0002	<0.0003	<0.0003	0.0007	<0.005	-
KLX27A	641.50	650.56	15433	2008-04-17	0.0730	8.88	1.3	-	<0.006	0.01	550	0.0088	<0.0002	<0.0003	0.0003	0.0007	-	-
KLX27A	641.50	650.56	15436	2008-04-28	-	-	-	-	-	0.03	-	-	-	-	-	-	-	-
KLX27A	641.50	650.56	15434	2008-04-30	*	8.87	*	*	0.006	0.01	545	0.0046	*	*	*	*	*	-
KLX27A	641.50	650.56	15435	2008-05-13	*	8.83	*	*	<0.006	0.03	576	0.0059	*	*	*	*	*	-
KLX27A	641.50	650.56	15437	2008-05-15	*	8.84	*	*	<0.006	0.02	551	<0.0030	*	*	*	*	*	-
KLX27A	641.50	650.56	15438	2008-05-19	*	8.87	*	*	<0.006	0.01	550	0.0065	*	*	*	*	*	-
KLX27A	641.50	650.56	15558	2008-05-22	*	8.81	*	*	<0.006	0.01	583	0.0042	*	*	*	*	*	-
KLX27A	641.50	650.56	15559	2008-05-27	*	8.86	*	*	<0.006	0.01	550	0.0037	*	*	*	*	*	-
KLX27A	641.50	650.56	15560	2008-05-29	*	8.84	*	*	<0.006	<0.03	550	<0.0030	*	*	*	*	*	-
KLX27A	641.50	650.56	15561	2008-06-03	*	8.86	*	*	<0.006	0.01	538	0.0040	*	*	*	*	*	-
KLX27A	641.50	650.56	15587	2008-06-05	0.0740	8.87	1.4	1.4	<0.006	0.01	563	<0.0030	<0.0002	0.0003	0.0003	0.0005	<0.001	0.9993

- = Not analysed

< "value" = result less than detection limit

* Stored in freezer/refrigerator

ChargeBal % = Rel. charge balance error %

SICADA: water_composition

Table A9-2. Trace elements.

Idcode	Secup m	Seclow m	Sample no.	Sampling date	U µg/L	Th µg/L	As µg/L	Sc µg/L	Cd µg/L	Hg µg/L	Se µg/L	V µg/L	Rb µg/L	Y µg/L	Zr µg/L	In µg/L	Cs µg/L	Ba µg/L
KLX27A	641.50	650.56	15424	2008-03-18	0.0105	<0.2	<0.5	<0.4	<0.02	<0.002	0.085	0.0388	10.4	0.0078	<0.1	<0.2	0.746	66.8
KLX27A	641.50	650.56	15425	2008-03-19	0.0100	<0.2	<0.5	<0.4	<0.02	<0.002	-	0.112	10.9	0.0105	<0.1	<0.2	0.775	67.1
KLX27A	641.50	650.56	15426	2008-03-31	0.0110	<0.2	<0.5	<0.4	<0.02	<0.002	-	0.0911	11.0	0.0112	<0.1	<0.2	0.802	69.6
KLX27A	641.50	650.56	15429	2008-04-03	-	-	-	-	-	-	0.059	-	-	-	-	-	-	-
KLX27A	641.50	650.56	15430	2008-04-07	0.0088	<0.2	<3	<0.05	<0.002	<0.002	-	0.0995	11.3	0.0136	0.549	<0.05	0.830	64.7
KLX27A	641.50	650.56	15432	2008-04-15	0.0072	<0.2	<5	<0.4	<0.02	<0.002	0.030	0.0941	11.5	0.0109	0.138	<0.2	0.760	66.1
KLX27A	641.50	650.56	15437	2008-05-15	-	-	-	-	-	-	0.029	-	-	-	-	-	-	-
KLX27A	641.50	650.56	15560	2008-05-29	-	-	-	-	-	-	0.065	-	-	-	-	-	-	-
KLX27A	641.50	650.56	15561	2008-06-03	-	-	-	-	-	-	0.091	-	-	-	-	-	-	-
KLX27A	641.50	650.56	15587	2008-06-05	0.0060	<0.02	<0.1	<0.05	<0.004	<0.002	0.054	0.0438	10.1	0.0088	1.18	<0.05	0.723	66.5

< "value" = result less than detection limit

- = Not analysed

SICADA: trace_elements_1, trace_elements_2

Idcode	Secup m	Seclow m	Sample no.	Sampling date	La µg/L	Hf µg/L	Tl µg/L	Ce µg/L	Pr µg/L	Nd µg/L	Sm µg/L	Eu µg/L	Gd µg/L	Tb µg/L	Dy µg/L	Ho µg/L	Er µg/L	Tm µg/L
KLX27A	641.50	650.56	15424	2008-03-18	<0.02	<0.02	<0.05	<0.02	<0.02	<0.02	<0.02	<0.02	<0.02	<0.02	<0.02	<0.02	<0.02	<0.02
KLX27A	641.50	650.56	15425	2008-03-19	<0.02	<0.02	<0.05	<0.02	<0.02	<0.02	<0.02	<0.02	<0.02	<0.02	<0.02	<0.02	<0.02	<0.02
KLX27A	641.50	650.56	15426	2008-03-31	<0.02	<0.02	<0.05	<0.02	<0.02	<0.02	<0.02	<0.02	<0.02	<0.02	<0.02	<0.02	<0.02	<0.02
KLX27A	641.50	650.56	15429	2008-04-03	-	-	-	-	-	-	-	-	-	-	-	-	-	-
KLX27A	641.50	650.56	15430	2008-04-07	<0.005	0.129	<0.01	0.0066	<0.005	<0.005	<0.005	<0.005	<0.005	<0.005	<0.005	<0.005	<0.005	<0.004
KLX27A	641.50	650.56	15432	2008-04-15	<0.02	<0.02	<0.05	<0.02	<0.02	<0.02	<0.02	<0.02	<0.02	<0.02	<0.02	<0.02	<0.02	<0.02
KLX27A	641.50	650.56	15437	2008-05-15	-	-	-	-	-	-	-	-	-	-	-	-	-	-
KLX27A	641.50	650.56	15560	2008-05-29	-	-	-	-	-	-	-	-	-	-	-	-	-	-
KLX27A	641.50	650.56	15561	2008-06-03	-	-	-	-	-	-	-	-	-	-	-	-	-	-
KLX27A	641.50	650.56	15587	2008-06-05	<0.005	0.301	<0.01	<0.005	<0.005	<0.005	<0.005	<0.005	<0.005	<0.005	<0.005	<0.005	<0.005	<0.004

< "value" = result less than detection limit

- = Not analysed

SICADA: trace_elements_1, trace_elements_2

Idcode	Secup m	Seclow m	Sample no.	Sampling date	Yb µg/L	Lu µg/L
KLX27A	641.50	650.56	15424	2008-03-18	<0.02	<0.02
KLX27A	641.50	650.56	15425	2008-03-19	<0.02	<0.02
KLX27A	641.50	650.56	15426	2008-03-31	<0.02	<0.02
KLX27A	641.50	650.56	15429	2008-04-03	-	-
KLX27A	641.50	650.56	15430	2008-04-07	<0.005	<0.005
KLX27A	641.50	650.56	15432	2008-04-15	<0.02	<0.02
KLX27A	641.50	650.56	15437	2008-05-15	-	-
KLX27A	641.50	650.56	15560	2008-05-29	-	-
KLX27A	641.50	650.56	15561	2008-06-03	-	-
KLX27A	641.50	650.56	15587	2008-06-05	<0.005	<0.005

< "value" = result less than detection limit

- = Not analysed

SICADA: trace_elements_1, trace_elements_2

Table A9-3. Isotopes I (H-, O-, B-, S-, C-, Sr- and Cl-isotopes).

Idcode	Secup m	Seclow m	Sample no	Sampling date	$\delta^2\text{H}$ dev SMOW	^3H TU	$\delta^{18}\text{O}$ dev SMOW	$^{10}\text{B}/^{11}\text{B}$ no unit	$\delta^{34}\text{S}$ dev CDT	$\delta^{13}\text{C}$ dev PDB	$^{87}\text{Sr}/^{86}\text{Sr}$ no unit	^{14}C pmC	AGE_BP years	$\delta^{37}\text{Cl}$ dev SMOC
KLX27A	641.50	650.56	15471	2008-03-14	-108.9	<0.8	-14.5	-	-	-	-	-	-	-
KLX27A	641.50	650.56	15424	2008-03-18	-109.4	<0.8	-14.7	0.2322	20.6	x	0.715373	x	x	0.74
KLX27A	641.50	650.56	15425	2008-03-19	-116.2	<0.8	-14.9	0.2415	-	-	-	-	-	-
KLX27A	641.50	650.56	15428	2008-03-28	-106.0	<0.8	-14.5	-	-	-	-	-	-	-
KLX27A	641.50	650.56	15426	2008-03-31	-107.5	<0.8	-14.4	0.2415	19.7	x	0.715388	x	x	0.79
KLX27A	641.50	650.56	15429	2008-04-03	-115.5	<0.8	-14.5	-	-	-	-	-	-	-
KLX27A	641.50	650.56	15430	2008-04-07	-113.4	<0.8	-14.5	0.2348	20.8	x	0.715334	x	x	0.83
KLX27A	641.50	650.56	15431	2008-04-10	-116.8	1.2	-15.1	-	-	-	-	-	-	-
KLX27A	641.50	650.56	15432	2008-04-15	-116.0	1.4	-14.3	0.2351	21.8	x	0.715347	x	x	0.62
KLX27A	641.50	650.56	15433	2008-04-17	-105.0	1.3	-14.9	-	-	-	-	-	-	-
KLX27A	641.50	650.56	15587	2008-06-05	-106.0	<0.8	-15.0	0.2355	20.1	x	0.715306	x	x	0.49

- = Not analysed

x = Not analysed due to analytical problems

< "value" = result less than detection limit

SICADA: isotopes_1

Table A9-4. Isotopes II (U-, Th, Ra- and Rn-isotopes).

Idcode	Secup m	Seclow m	Sample no.	Sampling date	²³⁸ U mBq/L	²³⁵ U mBq/L	²³⁴ U mBq/L	²³² Th mBq/L	²³⁰ Th mBq/L	²²⁶ Ra Bq/L	²²² Rn	
											Bq/L	Bq/L
KLX27A	641.50	650.56	15424	2008-03-18	*	*	*	*	*	0.061	27	42
KLX27A	641.50	650.56	15426	2008-03-31	*	*	*	*	*	0.043	26	42
KLX27A	641.50	650.56	15430	2008-04-07	*	*	*	*	*	**	**	**
KLX27A	641.50	650.56	15432	2008-04-15	*	*	*	*	*	0.043	20	41
KLX27A	641.50	650.56	15434	2008-04-30	*	*	*	*	*	***	***	***
KLX27A	641.50	650.56	15435	2008-05-13	*	*	*	*	*	<0.015	25	40
KLX27A	641.50	650.56	15437	2008-05-15	*	*	*	*	*	<0.015	15	35
KLX27A	641.50	650.56	15438	2008-05-19	*	*	*	*	*	<0.015	24	44
KLX27A	641.50	650.56	15558	2008-05-22	*	*	*	*	*	<0.015	11	31
KLX27A	641.50	650.56	15559	2008-05-27	*	*	*	*	*	0.053	22	36
KLX27A	641.50	650.56	15560	2008-05-29	*	*	*	*	*	<0.015	17	41
KLX27A	641.50	650.56	15561	2008-06-03	*	*	*	*	*	<0.015	25	41
KLX27A	641.50	650.56	15587	2008-06-05	<0.01	<0.02	1.05	0.07	0.14	***	***	***

81

* = Sample stored in freezer/refrigerator

** = Laboratory closed

*** = No sampling due to transportation problems

< "value" = result less than detection limit

SICADA: u_th_isotope_t, ra_rn_isotope_t

Table A9-5. Dissolved gases.

Idcode	Secup m	Seclow m	Sample no.	Sampling date	Ar mL/L	He mL/L	N ₂ mL/L	CO ₂ mL/L	CH ₄ mL/L	O ₂ mL/L	H ₂ μL/L	CO μL/L	C ₂ H ₆ μL/L	C ₂ H ₄ μL/L	C ₂ H ₂ μL/L	C ₂ H ₂ +C ₂ H ₄	C ₃ H ₈ μL/L	C ₃ H ₆ μL/L	DISS_GAS mL/L H ₂ O
KLX27A	641.50	650.56	15587	2008-06-08	2.78	1.74	587	0.199	0.032	<0.006	1660	3.12	<0.02	0.17	<0.02	0.17	<0.02	<0.02	594.00

< "value" = result below detection limit
 SICADA: Dissolved_gases