

**International  
Progress Report**

**IPR-08-15**

# **Äspö Hard Rock Laboratory**

## **Prototype Repository**

**Sensors data report  
(Period 010917-071201)  
Report No:18**

### **Compiled by**

Reza Goudarzi

Lars-Erik Johannesson

Clay Technology AB

December 2007

### **Svensk Kärnbränslehantering AB**

Swedish Nuclear Fuel  
and Waste Management Co

Box 250, SE-101 24 Stockholm  
Phone +46 8 459 84 00



**Äspö Hard Rock  
Laboratory**



|                              |                      |
|------------------------------|----------------------|
| Report no.                   | No.                  |
| <b>IPR-08-15</b>             | <b>F63K</b>          |
| Author                       | Date                 |
| <b>Reza Goudarzi</b>         | <b>December 2007</b> |
| <b>Lars-Erik Johannesson</b> |                      |
| Checked by                   | Date                 |
| <b>Lars-Erik Johannesson</b> | <b>2008-08-14</b>    |
| Approved                     | Date                 |
| <b>Anders Sjöland</b>        | <b>2008-08-21</b>    |

# Äspö Hard Rock Laboratory

## Prototype Repository

### Sensors data report (Period 010917-071201) Report No:18

#### *Compiled by*

Reza Goudarzi  
Lars-Erik Johannesson

Clay Technology AB

December 2007

**Keywords:** Fields test, Data, Prototype, Bentonite, Rock, Canister measurements, Water, Pressure, Total pressure, Relative humidity, Temperature, Displacements, Geoelectric

This report concerns a study which was conducted for SKB. The conclusions and viewpoints presented in the report are those of the author(s) and do not necessarily coincide with those of the client.





# Abstract

The Prototype Repository Test consists of two sections. The installation of the first Section of Prototype Repository was made during summer and autumn 2001 and Section 2 was installed in spring and summer 2003.

This report presents data from measurements in the Prototype Repository during the period 010917-071201. The report is organized so that the actual measured results are shown in Appendix 1-10, where Appendix 8 deals with measurements of canister displacements (by AITEMIN), Appendix 9 deals with geo-electric measurements in the backfill (by GRS), Appendix 10 deals with stress and strain measurement in the rock (by BBK) and Appendix 11 deals with measurement of water pressure in the rock (by VBB/VIAK). The main report and Appendix 1-7 deal with the rest of the measurements.

## Section 1

The following measurements are made in the bentonite in each of the two instrumented deposition holes in Section 1 (1 and 3): Temperature is measured in 32 points, total pressure in 27 points, pore water pressure in 14 points and relative humidity in 37 points. Temperature is also measured by all relative humidity gauges. Every measuring point is related to a local coordinate system in the deposition hole.

The following measurements are made in the backfill in Section 1. Temperature is measured in 20 points, total pressure in 18 points, pore water pressure in 23 points and relative humidity in 45 points. Temperature is also measured by all relative humidity gauges. Furthermore, water content is measured by an electric chain in one section. Every measuring point is related to a local coordinate system in the tunnel.

The following measurements are made on the surface of the canisters in Section 1: Temperature is measured every meter along two fiber optic cables. Furthermore, displacements of the canister in hole 3 are measured with 6 gauges.

The following measurements are made in the rock in Section 1: Temperature is measured in 37 points in boreholes in the floor. Water pressure is measured in altogether 64 points in 17 boreholes all around the tunnel.

## Section 2

The following measurements are made in the bentonite in each of the two instrumented deposition holes in Section 2 (5 and 6): Temperature is measured in 29 points, total pressure in 27 points, pore water pressure in 14 points and relative humidity in 47 points deposition hole 5 and in 65 points in deposition hole 6. Temperature is also measured by all relative humidity gauges.

The following measurements are made in the backfill in Section 2. Temperature is measured in 16 points, total pressure in 16 points, pore water pressure in 18 points and relative humidity in 32 points. Temperature is also measured by all relative humidity gauges. Furthermore, water content is measured by an electric chain in one section. Every measuring point is related to a local coordinate system in the tunnel.

The following measurements are made on the surface of the canisters in Section 2: Temperature is measured every meter along two fiber optic cables. Additional to this temperature measurement three conventional thermocouples are placed on each canister. Furthermore, displacements of the canister in hole 6 are measured with 6 gauges.

The following measurements are made in the rock in Section 2: Temperature is measured in 24 points in boreholes close to the deposition holes. Relative humidity is also measured in 6 points in the rock close to deposition hole 6.

### Conclusions

A general conclusion is that the measuring systems work well, but the number of sensors that has failed is increasing. 225 out of 363 sensors in Section 1 (excluding water pressure sensors in the rock, geo-electric measurements) are out of order, the majority being RH-sensors that fail at water saturation. 97 out of 394 sensors in Section 2 (excluding water pressure sensors in the rock, geo-electric measurements, stress and strain in the rock and displacement of canister) are out of order.

Furthermore some suction sensors (20) placed in the backfill is not giving reliable values due to high degree of saturation (RH 100%). A new calibration of the fiber optic cables for temperature measurement on the surface of the canisters has been made but it is still preliminary, which means that adjustments of the results may be done afterwards.

The drainages of the inner section together with the drainage of the outer plug were closed at the beginning of November. The pressure (pore pressure and total pressure) both in the backfill and in some parts of the buffer in the six deposition holes increased after this date. At the beginning of December 2004 damages was observed on two of the canisters (canister No 2 and No 6). The power to all of the canisters was then switched off and the drainage of the tunnel was opened. The power of canisters was switched on again on December 15 except for canister No 2 which was out of order. The drainage of the tunnel was kept open. The increase in pore pressure affected the saturation rate of the backfill and the buffer. The failure of canister No 2 and the time when the power was switched off affected also the measurements especially the temperature measurements in the buffer. At the beginning of September 2005 more problems with the power to canister 6 was observed. The power to the canister was switched off for about 2 months. The power to canister 6 was switched on again on November 2 2005. This affected the measured temperature and pressure in the buffer in deposition hole 6. Over a period of 5 days in October 2007 the power to canister 6 was switched off for a third time. Also this small stop of the power to the canister affected measured pressure and temperature. A packer installed in the rock in Section 1 was broken around the 18<sup>th</sup> of April 2006. The broken packer caused an increase in the measured total and pore pressure in the backfill in Section 1. At the beginning of April 2007 some of the installed sensors for measuring pore pressure and total pressure in the backfill measured an increased pressure. The change in the measure pressures is probably related to the work with the excavation of a new tunnel near by the Prototype-tunnel which was initialized at that time.

# Sammanfattning

Prototypförvaret består av två sektioner. Den första sektionen installerades under sommaren och hösten 2001 och Sektion 2 installerades under våren och sommaren 2003.

I denna rapport presenteras data från mätningar i Prototypförvaret för perioden 010917-071201. Rapporten är uppdelad så att själva mätresultaten redovisas i Appendix 1-10, varvid Appendix 8 behandlar mätning av kapselförskjutningar (görs av AITEMIN), Appendix 9 behandlar geoelektriska mätningar i återfyllningen (görs av GRS), Appendix 10 behandlar mätningar av spänning och töjning i berget (handhas av BBK) och Appendix 11 behandlar vattentrycksmätningar i berget (handhas av VBB/VIAK). I själva huvudrapporten och Appendix 1-7 behandlas alla övriga mätningar.

## Sektion 1

Följande mätningar görs i bentoniten i vardera av de två instrumenterade deponeringshålen i Sektion 1 (1 och 3): Temperatur mäts i 32 punkter, totaltryck i 27 punkter, porvattentryck i 14 punkter och relativa fuktigheten i 37 punkter. Temperaturen mäts även med relativa fuktighetsmätare. Varje mätpunkt relateras till ett lokalt koordinatsystem i deponeringshålet.

Följande mätningar görs i återfyllningen i Sektion 1: Temperaturen mäts i 20 punkter, totaltryck i 18 punkter, porvattentryck i 23 punkter och relativa fuktigheten i 45 punkter. Temperaturen mäts även med alla relativa fuktighetsmätare. Varje mätpunkt relateras till ett lokalt koordinatsystem i tunneln. Dessutom mäts vatteninnehållet i en sektion med en geoelektrisk mätkedja.

Följande mätningar görs på ytan i kapselns kopparhölje i samtliga 4 kapslar i Sektion 1: Temperaturen mäts varje meter längs två fiberoptiska kablar från två håll. Dessutom mäts förskjutningar av kapseln i hål 3 med 6 givare.

Följande mätningar görs i berget i Sektion 1: Temperatur mäts i borrhål i 37 punkter i golvet. Vattentryck mäts i sammanlagt 64 punkter i 17 borrhål runt hela tunneln.

## Sektion 2

Följande mätningar görs i bentoniten i vardera av de två instrumenterade deponeringshålen i Sektion 2 (5 och 6): Temperatur mäts i 29 punkter, totaltryck i 27 punkter, porvattentryck i 14 punkter och relativa fuktigheten i 47 punkter i deponeringshål 5 och 65 punkter i deponeringshål 6. Temperaturen mäts även i alla relativa fuktighetsmätare.

Följande mätningar görs i återfyllningen i Sektion 2: Temperaturen mäts i 16 punkter, totaltryck i 16 punkter, porvattentryck i 18 punkter och relativa fuktigheten i 32 punkter. Temperaturen mäts även med alla relativa fuktighetsmätare. Varje mätpunkt relateras till ett lokalt koordinatsystem i tunneln. Dessutom mäts vatteninnehållet i en sektion med en geoelektrisk mätkedja.

Följande mätningar görs på ytan i kapselns kopparhölje i de två kapslarna i Sektion 2: Temperaturen mäts varje meter längs två fiberoptiska kablar från två håll. Vidare mäts temperaturen i tre punkter på varje kapsel med konventionella termoelement. Även förskjutningen av kapseln i deponeringshål 6 mäts med 6 givare.

Temperatur mäts i berget kring varje kapsel i 24 punkter. Vidare mäts RH i berget kring deponeringshål 6 i 6 punkter.

### Slutsatser

En generell slutsats är att mätsystemen tycks fungera bra. 225 av 363 givare i Sektion 1 (med undantag av vattentrycksmätare i berget) fungerar inte. Många av dessa (64 stycken) är RH-mätare som slutar fungera vid vattenmättnad. 97 av 394 givare i Sektion 2 (med undantag av vattentrycksmätare i berget) fungerar inte. Dessutom har en del psychrometrar (21) placerade i återfyllningen slutat att ge relevanta värden på grund av att fyllningen närmar sig vattenmättnad. Kalibrering av de fiberoptiska kablarna för temperaturmätning på kapselytorna har gjorts men den är fortfarande preliminär varför nya efterjustering av resultaten kan bli aktuell.

Dräneringen av den inre sektionen och den yttre pluggen stängdes i början av november. Portrycket och totaltrycket både i återfyllnaden och i bufferten ökade markant efter stängningen av dränaget. Ökningen av portrycket påverkade också vattenmättnaden i vissa delar av buffert och återfyllnade. Skador observerades på två av kapslarna i början av december 2004, varefter effekten till samtliga kapslar stängdes av samtidigt som dräneringen av tunneln öppnades. Effekten till alla kapslar utom kapsel nr. 2 sattes på igen den 15:e december. Skadorna på kapsel 2 var så omfattande att det inte var möjligt att koppla in någon effekt på denna. Dräneringen av tunneln förblev öppen. I början av september 2005 uppstod nya problem med kapsel Nr 6. Effekten till kapseln stängdes av under ca 2 månader. Från och med den 2:a november 2005 sattes effekten till kapsel Nr 6 på igen. Detta påverkade de uppmätta temperaturerna och trycken i bufferten i deponeringshål 6. Under en period av 5 dagar i oktober 2007 var effekten till kapsel Nr 6 avstängd en tredje gång. Även detta korta stopp påverkade de mätta trycken och temperaturerna. En packer installerad i berget i Sektion 1 gick sönder kring den 18:e april 2006. Den läckande packern medförde att totaltrycken och portrycken i återfyllningen i Sektion 1 ökade markant. I början av april 2007 mätte några av de i återfyllningen installerade portrycks- och totaltrycksgivare en ökning i trycken. Detta orsakades förmodligen av det arbete med sprängningen av en ny tunnel när prototyp-tunneln som startade vid den tidpunkten.

# Contents

|          |  |           |
|----------|--|-----------|
| <b>1</b> | <b>Introduction</b>  | <b>11</b> |
| <b>2</b> | <b>Geometry and coordinate systems</b>   | <b>13</b> |
| <b>3</b> | <b>Brief description of the instruments</b>  | <b>15</b> |
|          | Measurements of temperature  | 15        |
|          | Measurement of total pressure in the buffer and backfill   | 15        |
|          | Measurement of pore water pressure in the buffer and backfill  | 15        |
|          | Measurement of the water saturation process in the buffer and backfill   | 15        |
| <b>4</b> | <b>Location of instruments in Section 1</b>  | <b>17</b> |
| 4.1      | Strategy for describing the position of each device in the bentonite and rock in and around the deposition holes | 17        |
| 4.2      | Position of each instrument in the bentonite in hole 1 (DA3587G01)   | 19        |
| 4.3      | Position of each instrument in the bentonite in hole 3 (DA3575G01)   | 23        |
| 4.4      | Instruments on the canister surface in holes 1-4   | 27        |
| 4.5      | Position of temperature sensors in the rock  | 29        |
| 4.6      | Strategy for describing the position of each device in the backfill in section 1                                 | 31        |
| 4.7      | Position of each instrument in the backfill  | 33        |
| <b>5</b> | <b>Results and comments for Section 1</b>  | <b>37</b> |
| 5.1      | General  | 37        |
| 5.2      | Deposition hole 1  | 38        |
|          | 5.2.1 Total pressure   | 38        |
|          | Geokon (App. 1\pages 89-91)  | 38        |
|          | Kulite (App. 1\page 92)  | 38        |
|          | 5.2.2 Relative humidity  | 39        |
|          | Vaisala (App. 1\pages 93-96)   | 39        |
|          | Rotronic (App. 1\pages 97-101)   | 39        |
|          | 5.2.3 Pore water pressure  | 39        |
|          | Geokon (App. 1\page 102)   | 39        |
|          | Kulite (App. 1\page 103)   | 39        |
|          | 5.2.4 Temperature in the buffer (App. 1\pages 104-110)   | 40        |
|          | 5.2.5 Canister power in dep. hole 1 (App. 1\page 114)  | 40        |
|          | 5.2.6 Temperature on the canister surface (App. 1\pages 115-116)   | 40        |
| 5.3      | Deposition hole 3  | 40        |
|          | 5.3.1 Total pressure   | 40        |
|          | Geokon (App. 2\pages 119-121)  | 40        |
|          | Kulite (App. 2\pages 122-123)  | 41        |
|          | 5.3.2 Relative humidity  | 41        |
|          | Vaisala (App. 2\pages 124-127)   | 41        |
|          | Rotronic (App. 2\pages 128-132)  | 41        |
|          | 5.3.3 Pore water pressure.   | 41        |
|          | Geokon (App. 2\page 133)   | 41        |
|          | Kulite (App. 2\page 134)   | 41        |
|          | 5.3.4 Temperature in the buffer (App. 2\pages 135-141 and 144)   | 42        |
|          | 5.3.5 Canister power (App. 2\page 145)   | 42        |
|          | 5.3.6 Temperature on the canister surface (App. 2\pages 146-147)   | 42        |

|          |  |           |
|----------|--|-----------|
| 5.4      | Deposition hole 2  | 42        |
| 5.4.1    | Canister power (App. 3\page 152)   | 42        |
| 5.4.2    | Temperature on the canister surface (App. 3\pages 153-155)   | 43        |
| 5.5      | Deposition hole 4  | 43        |
| 5.5.1    | Canister power (App. 3\page 157)   | 43        |
| 5.5.2    | Temperature on the canister surface (App. 3\pages 158-159)   | 43        |
| 5.6      | Backfill in Section 1  | 43        |
| 5.6.1    | Total pressure in the backfill   | 43        |
|          | Geokon (App. 4\pages 163-164)  | 43        |
|          | Kulite (App. 4 \pages 165-166)   | 44        |
| 5.6.2    | Suction in the backfill (App. 4\pages 167-173)   | 44        |
| 5.6.3    | Pore water pressure in the backfill  | 44        |
|          | Geokon (App. 4\pages 174-175)  | 44        |
|          | Kulite (App. 4\pages 176-177)  | 44        |
| 5.6.4    | Temperature in the backfill (App. 4\pages 178-182)   | 45        |
| 5.7      | Temperature in the rock  | 45        |
| 5.7.1    | Near hole 1 (App. 1\pages 111-113)   | 45        |
| 5.7.2    | Near hole 2 (App. 3\page 151)  | 45        |
| 5.7.3    | Near hole 3 (App. 2\pages 142-143)   | 45        |
| 5.7.4    | Near hole 4 (App. 3\page 156)  | 45        |
| 5.8      | Analyze of data from Section 1   | 45        |
| 5.8.1    | Deposition hole 1  | 45        |
| 5.8.2    | Deposition hole 3  | 48        |
| 5.8.3    | Backfill.  | 51        |
| <b>6</b> | <b>Location of instruments in Section 2</b>  | <b>53</b> |
| 6.1      | Strategy for describing the position of each device in the bentonite and rock in and around the deposition holes | 53        |
| 6.2      | Position of each instrument in the bentonite in hole 5 (DA3551G01)   | 54        |
| 6.3      | Position of each instrument in the bentonite in hole 6 (DA3545G01)   | 59        |
| 6.4      | Instruments on the canister surface in holes 5-6   | 64        |
| 6.5      | Position of temperature sensors in the rock  | 64        |
| 6.6      | Strategy for describing the position of each device in the backfill in section 2                                 | 66        |
| 6.7      | Position of each instrument in the backfill in Section 2   | 66        |
| <b>7</b> | <b>Results and comments for Section 2</b>  | <b>71</b> |
| 7.1      | General  | 71        |
| 7.2      | Deposition hole 5  | 72        |
| 7.2.1    | Total pressure   | 72        |
|          | Geokon (App. 5\pages 185-188)  | 72        |
|          | Kulite (App. 5\page 189)   | 72        |
| 7.2.2    | Relative humidity/suction in dep. hole 5   | 72        |
|          | Vaisala (App. 5\pages 190-193)   | 72        |
|          | Rotronic (App. 5\pages 194-198)  | 73        |
|          | Wescor Psychrometers (App.5\page 199)  | 73        |
| 7.2.3    | Pore water pressure  | 73        |
|          | Geokon (App. 5\page 200)   | 73        |
|          | Kulite (App. 5\page 201)   | 73        |
| 7.2.4    | Temperature in the buffer (App. 5\pages 202-213)   | 74        |
| 7.2.5    | Canister power (App. 5\page 217)   | 74        |
| 7.2.6    | Temperature on the canister surface (App. 5\pages 218-220)   | 74        |

|          |  |            |
|----------|--|------------|
| 7.3      | Deposition hole 6  | 75         |
| 7.3.1    | Total pressure   | 75         |
|          | Geokon and Kulite (App. 6\pages 223-226)                   | 75         |
| 7.3.2    | Relative humidity/Suction                                  | 75         |
|          | Vaisala and Rotronic (App. 6\pages 227-233)                | 75         |
|          | Wescor Psychrometers (App. 6\page 234-238)                 | 76         |
| 7.3.3    | Pore water pressure  | 76         |
|          | Geokon and Kulite (App. 6\pages 239-241)                   | 76         |
| 7.3.4    | Temperature in the buffer (App. 6\pages 242-254)           | 76         |
| 7.3.5    | Canister power (App. 6\page 258)                           | 77         |
| 7.3.6    | Temperature on the canister surface (App. 6\pages 259-261) | 77         |
| 7.4      | Backfill in Section 2                                      | 77         |
| 7.4.1    | Total pressure   | 77         |
|          | Geokon (App. 7\page 265)                                   | 77         |
|          | Kulite (App.7 \page 266)                                   | 78         |
| 7.4.2    | Suction (App. 7 \pages 267-273)                            | 78         |
| 7.4.3    | Pore water pressure  | 78         |
|          | Geokon (App. 7\pages 274-276)                              | 78         |
|          | Kulite (App. 7\page 277)                                   | 79         |
| 7.4.4    | Temperature (App. 7\pages 278-280)                         | 79         |
| 7.5      | Temperature in the rock                                    | 79         |
| 7.5.1    | Near hole 5 (App. 5\pages 214-216)                         | 79         |
| 7.5.2    | Near hole 6 (App. 6\pages 255-257)                         | 79         |
| 7.6      | Analyze of data from Section 2                             | 79         |
| 7.6.1    | Deposition hole 5  | 79         |
| 7.6.2    | Deposition hole 6  | 82         |
| 7.6.3    | Backfill   | 85         |
| <b>8</b> | <b>References</b>  | <b>85</b>  |
|          | <b>Appendix 1. Deposition hole 1</b>                       | <b>87</b>  |
|          | <b>Appendix 2. Deposition hole 3</b>                       | <b>117</b> |
|          | <b>Appendix 3. Deposition holes 2 and 4</b>                | <b>149</b> |
|          | <b>Appendix 4. Backfill in Section 1</b>                   | <b>161</b> |
|          | <b>Appendix 5. Deposition hole 5</b>                       | <b>183</b> |
|          | <b>Appendix 6. Deposition hole 6</b>                       | <b>221</b> |
|          | <b>Appendix 7. Backfill in Section 2</b>                   | <b>263</b> |
|          | <b>Appendix 8. Canister displacements</b>                  | <b>281</b> |
|          | <b>Appendix 9. Geo-electric monitoring</b>                 | <b>301</b> |
|          | <b>Appendix 10 Stress and strain in the rock</b>           | <b>351</b> |
|          | <b>Appendix 11. Water pressure in the rock</b>             | <b>385</b> |
|          | <b>Quick guide</b>   | <b>453</b> |





# 1 Introduction

The Prototype Repository Test consists of two sections. The installation of the first Section of Prototype Repository was made during summer and autumn 2001 and Section 2 was installed in spring and summer 2003.

Section 1 consists of four full-scale deposition holes, copper canisters equipped with electrical heaters, bentonite blocks and a deposition tunnel backfilled with a mixture of bentonite and crushed rock and ends with a concrete plug as shown in Figure 1-1. Section 2 consists of two full-scale deposition holes with a backfilled tunnel section and ends also with a concrete plug.

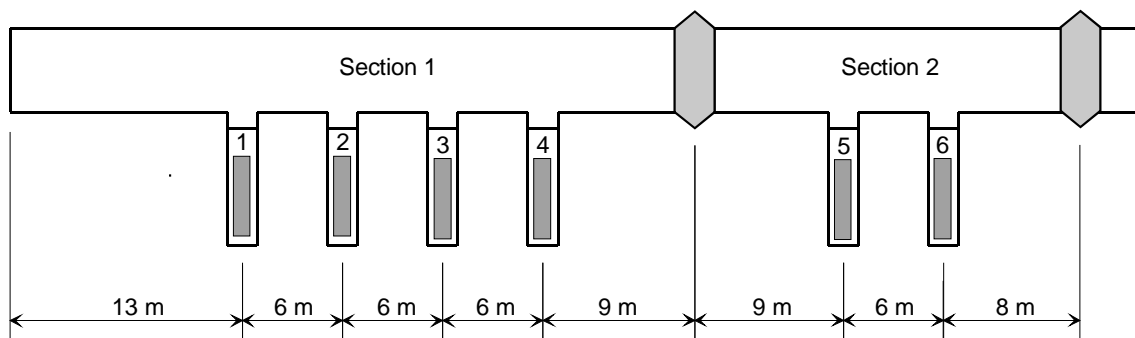

*Figure 1-1. Schematic view of the Prototype Repository.*

The bentonite buffer in deposition holes 1, 3, 5 and 6, the backfill and the surrounding rock are instrumented with gauges for measuring temperature, water pressure, total pressure, relative humidity, resistivity and canister displacement. The instruments are connected to data collection systems by cables protected by tubes, which are led through the rock in watertight lead throughs.

In general the data for Section 1 in this report are presented in diagrams covering the time period 2001-09-17 to 2007-12-01. The time axis in the diagrams represent number of days from start 2001-09-17, which is the day the heating of the canister in hole 1 was started. For Section 2 the date are presented in diagrams covering the time period 2003-05-08 to 2007-12-01, where 2003-05-08 is the day when the heating of the canister in hole 5 was started.

This report consists of several parts. In chapters 2, 3, 4 and 6 a test overview with the positions of those measuring points and a brief description of the instruments are shown. In chapter 5 the measured results from all measurements in Section 1, except canister displacement, stress and strain and water pressure in the rock and resistivity in the backfill and buffer, are presented and commented. Corresponding presentations and comments for Section 2 are made in chapter 7. The diagrams of those measured results are attached in Appendix 1-7. The results and comments of the measurements of canister displacement, resistivity in the backfill, stress and strain in the rock and water pressure in the rock are presented separately in Appendix 8-11.

A quick guide to the positions of the instruments in the buffer and backfill is enclosed as the last page.



## 2 Geometry and coordinate systems

The Prototype Repository consists of two sections as shown in Figure 1-1. The geometry and the coordinate system for the sensors are different for the deposition holes and the tunnel. The temperature sensors in the rock are defined with the same coordinate system as the deposition holes.

### Deposition holes

In Section 1 the deposition holes are termed 1-4 according to Figure 1-1 and in Section 2 the deposition holes are termed 5 and 6. The coordinate system for these holes is shown in Figure 2-1. With the  $z$ -axis starting from the cement casting and the angle  $\alpha$  counted anti-clockwise from direction A. Measurements are mainly made in four vertical sections A, B, C and D according to Figure 2-1. Direction A and C are placed in the tunnels axial direction with A headed against the end of the tunnel i.e. almost towards West.

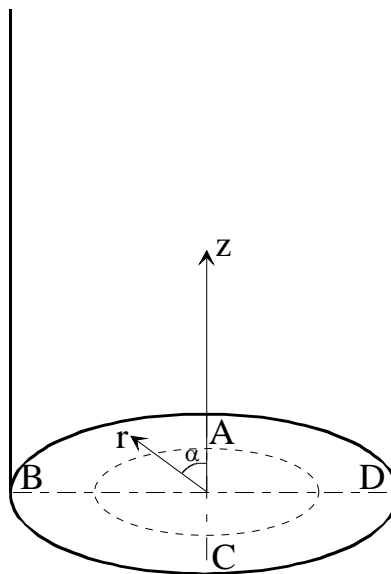

**Figure 2-1.** Figure describing the instrument planes (A-D) and the coordinate system used when describing the instrument positions.

## Tunnel

The coordinate system of the backfill in the tunnel is shown in Figure 3-2. The coordinate  $y$  starts at the entrance on ground, which means that the tunnel ends at  $y = 3599, 8$ . The  $y$ -axis runs in the center of the tunnel, which means that the tunnel walls intersect the  $z$  and  $x$ -axes at  $\pm 2.5$  m. The  $z$ -coordinate is determined positive upwards and the  $x$ -coordinate is determined positive to the right when facing the end of the tunnel.

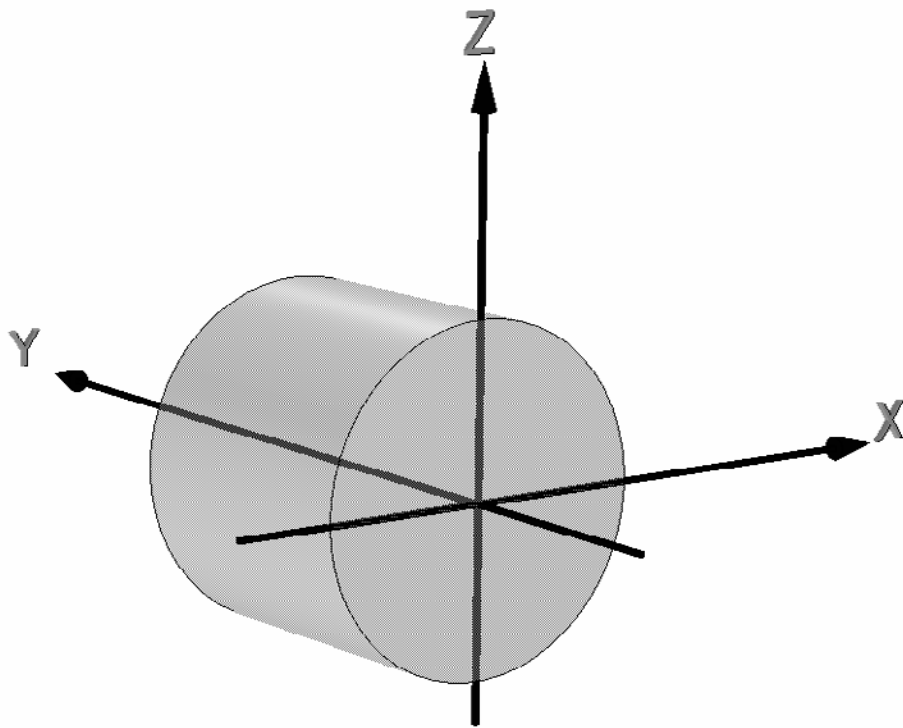

*Figure 2-2. Coordinate system of the tunnel.*

### **3 Brief description of the instruments**

The different standard instruments that are used in the buffer, backfill and rock (temperature) are briefly described in this chapter.

#### **Measurements of temperature**

##### ***Buffer, backfill and rock***

Thermocouples from Pentronic have been used to measure temperature. Measurements are done in 32 points in each instrumented hole (hole1 and hole 3). In addition, temperature gauges are built into the capacitive relative humidity sensors and some of the other sensor types as well.

##### ***Canister***

Temperature is measured on the surface of the canister with optical fiber cables. An optical measuring system called FTR (Fiber Temperature Laser Radar) is used. In Section 2 are also three thermocouples of type Pentonic installed on each canister.

#### **Measurement of total pressure in the buffer and backfill**

Total pressure is the sum of the swelling pressure and the pore water pressure. It is measured with the following instrument types:

- Geocon total pressure cells with vibrating wire transducers.
- Kulite total pressure cells with piezo resistive transducers.

#### **Measurement of pore water pressure in the buffer and backfill**

Pore water pressure is measured with the following instrument types:

- Geocon pore pressure cells with vibrating wire transducer.
- Kulite pore pressure cells with piezo resistive transducer.

#### **Measurement of the water saturation process in the buffer and backfill**

The water saturation process is recorded by measuring the relative humidity in the pore system, which can be converted to total suction (negative water pressure). The following techniques and devices are used:

- Vaisala relative humidity sensor of capacitive type. The measuring range is 0-100 % RH.
- Rotronic relative humidity sensors of capacitive type. The measuring range is 0-100 % RH.
- Wescor soil psychrometer. The sensor is measuring the dry and the wet temperature in the pore volume of the material. The measuring range is 95.5-99.6 % RH corresponding to the pore water pressure  $-0.5$  to  $-6$  MPa. Psychrometers are placed in the backfill in both sections and in the buffer in the two deposition holes in Section 2.



## 4 Location of instruments in Section 1

### 4.1 Strategy for describing the position of each device in the bentonite and rock in and around the deposition holes

The same principles are used for describing the position of all sensors in the bentonite inside the deposition holes as well as the thermocouples in the rock around the deposition holes. The principles are described in the quick guide inserted as a folded A3 page at the end of the report.

Every instrument is named with a unique name consisting of 1 letter describing the type of measurement, 2 letters describing where the measurement takes place (buffer, backfill, rock or canister), 1 figure denoting the deposition hole (1-4) and 4 figures specifying the instrument according to a separate list (see Table 2-1 to 2-10). Every instrument position is then described with three coordinates according to Figure 3-1.

The  $r$ -coordinate is the horizontal distance from the center of the hole and the  $z$ -coordinate is the height from the surface of the bottom casting of the hole (the block height is set to 500mm). The  $\alpha$ -coordinate is the angle from the vertical direction A (almost West).

Figure 4-1 shows an overview of the instruments in the buffer. The bentonite blocks are called cylinders and rings. The cylinders are numbered C1-C4 and the rings R1-R10 respectively.

- pore water pressure + temp.
- total pressure + temp.
- × temp.
- △ relative humidity (+ temp.)

1m

A

B+C

D

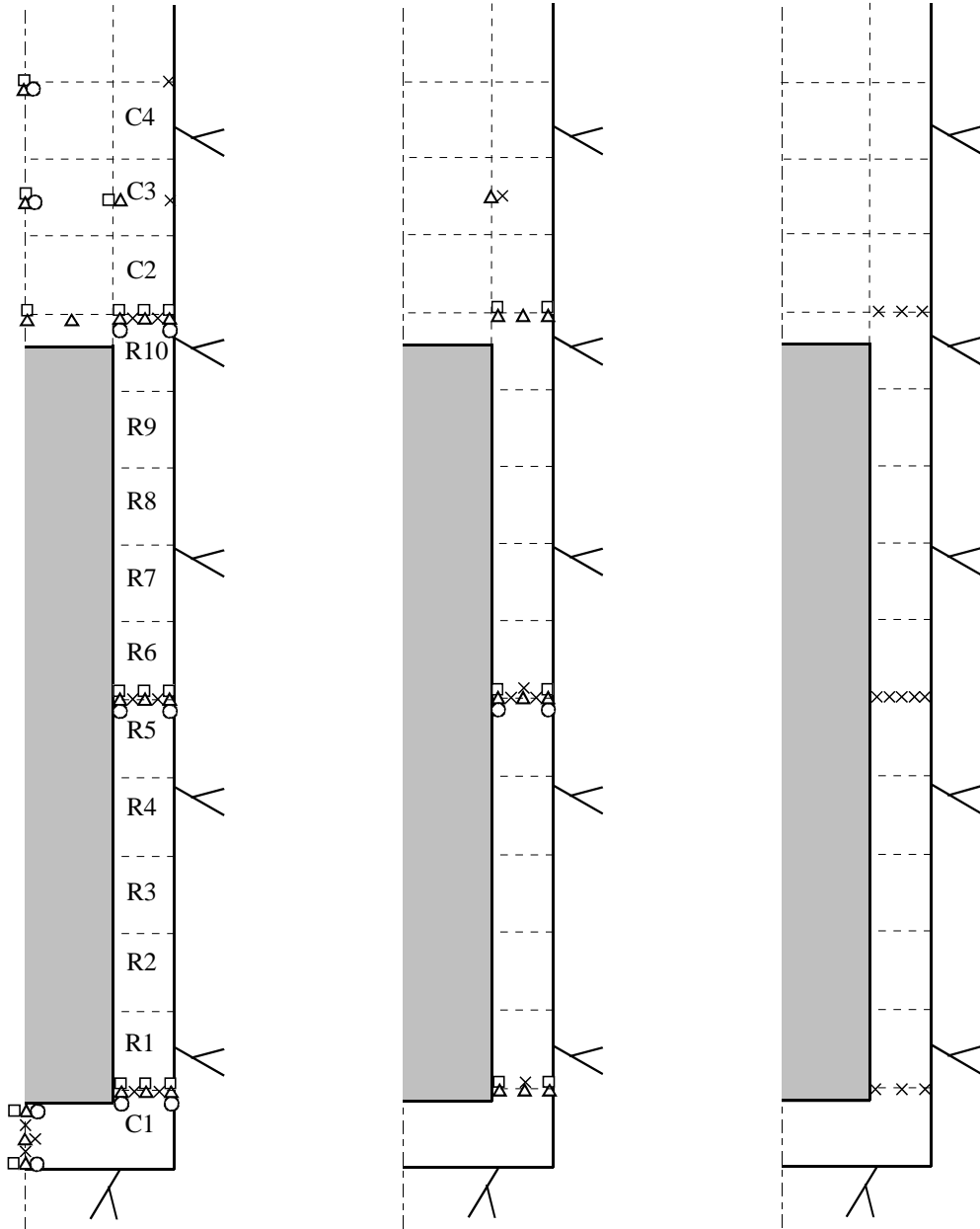

**Figure 4-1.** Schematic view over the instruments in four vertical sections and the block designation.



## 4.2 Position of each instrument in the bentonite in hole 1 (DA3587G01)

The instruments are located in three main levels in the blocks, 50 mm, 160 mm and 250 mm, from the upper surface. The thermocouples are mostly placed in the 50 mm level and the other gauges in the 160 mm level except for the Geokon type 1 pressure sensors and the Rotronic humidity sensors, which are placed in the 250 mm level depending on the size of the sensor house.

Exact positions of the sensors are described in Tables 4-1 to 4-4.

**Table 4-1. Numbering and position of instruments for measuring temperature (T) in the buffer in hole 1.**

| Type and number | Block                            | Instrument position |                    |        |        | Fabricate | Remark |
|-----------------|----------------------------------|---------------------|--------------------|--------|--------|-----------|--------|
|                 |                                  | Direction           | $\alpha$<br>degree | r<br>m | Z<br>m |           |        |
| TBU10001        | Cyl. 1                           | Center              | 270                | 0,050  | 0,054  | Pentronic |        |
| TBU10002        | Cyl. 1                           | Center              | 270                | 0,050  | 0,254  | Pentronic |        |
| TBU10003        | Cyl. 1                           | Center              | 270                | 0,050  | 0,454  | Pentronic |        |
| TBU10004        | Cyl. 1                           | A                   | 355                | 0,635  | 0,454  | Pentronic |        |
| TBU10005        | Cyl. 1                           | A                   | 355                | 0,735  | 0,454  | Pentronic |        |
| TBU10006        | On top of the canister in hole 2 |                     |                    |        |        | Pentronic |        |
| TBU10007        | Cyl. 1                           | C                   | 175                | 0,685  | 0,454  | Pentronic |        |
| TBU10008        | Cyl. 1                           | D                   | 270                | 0,585  | 0,454  | Pentronic |        |
| TBU10009        | Cyl. 1                           | D                   | 270                | 0,685  | 0,454  | Pentronic |        |
| TBU10010        | Cyl. 1                           | D                   | 270                | 0,785  | 0,454  | Pentronic |        |
| TBU10011        | Ring 5                           | A                   | 0                  | 0,635  | 2,980  | Pentronic |        |
| TBU10012        | Ring 5                           | A                   | 0                  | 0,735  | 2,980  | Pentronic |        |
| TBU10013        | Ring 5                           | B                   | 90                 | 0,585  | 2,980  | Pentronic |        |
| TBU10014        | Ring 5                           | B                   | 90                 | 0,685  | 2,980  | Pentronic |        |
| TBU10015        | Ring 5                           | B                   | 90                 | 0,785  | 2,980  | Pentronic |        |
| TBU10016        | Ring 5                           | C                   | 175                | 0,585  | 2,980  | Pentronic |        |
| TBU10017        | Ring 5                           | C                   | 175                | 0,685  | 2,980  | Pentronic |        |
| TBU10018        | Ring 5                           | C                   | 175                | 0,735  | 2,980  | Pentronic |        |
| TBU10019        | Ring 5                           | D                   | 270                | 0,585  | 2,980  | Pentronic |        |
| TBU10020        | Ring 5                           | D                   | 270                | 0,635  | 2,980  | Pentronic |        |
| TBU10021        | Ring 5                           | D                   | 270                | 0,685  | 2,980  | Pentronic |        |
| TBU10022        | Ring 5                           | D                   | 270                | 0,735  | 2,980  | Pentronic |        |
| TBU10023        | Ring 5                           | D                   | 270                | 0,785  | 2,980  | Pentronic |        |
| TBU10024        | Ring 10                          | A                   | 0                  | 0,635  | 5,508  | Pentronic |        |
| TBU10025        | Ring 10                          | A                   | 0                  | 0,735  | 5,508  | Pentronic |        |
| TBU10026        | Ring 10                          | D                   | 270                | 0,585  | 5,508  | Pentronic |        |
| TBU10027        | Ring 10                          | D                   | 270                | 0,685  | 5,508  | Pentronic |        |
| TBU10028        | Ring 10                          | D                   | 270                | 0,785  | 5,508  | Pentronic |        |
| TBU10029        | Cyl. 3                           | A                   | 0                  | 0,785  | 6,317  | Pentronic |        |
| TBU10030        | Cyl. 3                           | B                   | 95                 | 0,585  | 6,317  | Pentronic |        |
| TBU10031        | Cyl. 3                           | C                   | 185                | 0,585  | 6,317  | Pentronic |        |
| TBU10032        | Cyl. 4                           | A                   | 0                  | 0,785  | 7,026  | Pentronic |        |

**Table 4-2. Numbering and position of instruments for measuring total pressure (P) in the buffer in hole 1.**

| Type and number | Block   | Instrument position |                    |        |        | Fabricate | Remark      |
|-----------------|---------|---------------------|--------------------|--------|--------|-----------|-------------|
|                 |         | Direction           | $\alpha$<br>degree | r<br>m | Z<br>m |           |             |
| PBU10001        | Cyl. 1  | Center              | 0                  | 0,000  | 0,000  | Geokon    | In cement   |
| PBU10002        | Cyl. 1  | Center              | 0                  | 0,100  | 0,504  | Geokon    |             |
| PBU10003        | Cyl. 1  | A                   | 5                  | 0,585  | 0,504  | Kulite    | Vertical    |
| PBU10004        | Cyl. 1  | A                   | 5                  | 0,685  | 0,504  | Kulite    | Vertical    |
| PBU10005        | Cyl. 1  | A                   | 5                  | 0,785  | 0,504  | Kulite    | Vertical    |
| PBU10006        | Cyl. 1  | B                   | 95                 | 0,635  | 0,504  | Geokon    |             |
| PBU10007        | Cyl. 1  | B                   | 105                | 0,735  | 0,504  | Geokon    |             |
| PBU10008        | Cyl. 1  | C                   | 185                | 0,635  | 0,504  | Geokon    |             |
| PBU10009        | Cyl. 1  | C                   | 195                | 0,735  | 0,504  | Geokon    |             |
| PBU10011        | Ring 5  | A                   | 5                  | 0,685  | 2,780  | Geokon I  |             |
| PBU10012        | Ring 5  | A                   | 5                  | 0,785  | 3,030  | Kulite    | In the slot |
| PBU10013        | Ring 5  | B                   | 95                 | 0,585  | 2,780  | Geokon I  |             |
| PBU10014        | Ring 5  | B                   | 95                 | 0,785  | 2,780  | Geokon I  |             |
| PBU10015        | Ring 5  | C                   | 185                | 0,535  | 3,030  | Geokon I  | In the slot |
| PBU10016        | Ring 5  | C                   | 185                | 0,825  | 2,870  | Kulite    | In the slot |
| PBU10017        | Ring 10 | Center              | 0                  | 0,050  | 5,558  | Geokon    |             |
| PBU10019        | Ring 10 | A                   | 5                  | 0,685  | 5,558  | Kulite    | Vertical    |
| PBU10020        | Ring 10 | A                   | 5                  | 0,785  | 5,558  | Kulite    | Vertical    |
| PBU10021        | Ring 10 | B                   | 90                 | 0,635  | 5,558  | Geokon    |             |
| PBU10022        | Ring 10 | B                   | 100                | 0,735  | 5,558  | Geokon    |             |
| PBU10023        | Ring 10 | C                   | 190                | 0,735  | 5,558  | Geokon    |             |
| PBU10024        | Ring 10 | C                   | 180                | 0,635  | 5,558  | Geokon    |             |
| PBU10025        | Cyl. 3  | Center              | 0                  | 0,050  | 6,317  | Kulite    | Vertical    |
| PBU10026        | Cyl. 3  | A                   | 5                  | 0,585  | 6,567  | Geokon    |             |
| PBU10027        | Cyl. 4  | Center              | 0                  | 0,050  | 7,076  | Kulite    | Vertical    |

**Table 4-3. Numbering and position of instruments for measuring pore water pressure (U) in the buffer in hole 1.**

| Type and number | Block   | Instrument position |                    |        | Fabricate | Remark |             |
|-----------------|---------|---------------------|--------------------|--------|-----------|--------|-------------|
|                 |         | Direction           | $\alpha$<br>degree | r<br>m |           |        | Z<br>m      |
| UBU10001        | Cyl. 1  | Center              | 90                 | 0,050  | 0,054     | Kulite |             |
| UBU10002        | Cyl. 1  | Center              | 90                 | 0,050  | 0,254     | Geokon | Horizontal  |
| UBU10003        | Cyl. 1  | A                   | 355                | 0,585  | 0,344     | Geokon |             |
| UBU10004        | Cyl. 1  | A                   | 355                | 0,785  | 0,344     | Kulite |             |
| UBU10005        | Ring 5  | A                   | 355                | 0,585  | 2,780     | Geokon |             |
| UBU10006        | Ring 5  | A                   | 355                | 0,785  | 2,870     | Kulite |             |
| UBU10007        | Ring 5  | B                   | 85                 | 0,535  | 2,870     | Kulite | In the slot |
| UBU10008        | Ring 5  | B                   | 85                 | 0,825  | 2,870     | Kulite | In the slot |
| UBU10009        | Ring 5  | C                   | 175                | 0,535  | 2,780     | Geokon | In the slot |
| UBU10010        | Ring 5  | C                   | 175                | 0,825  | 2,780     | Geokon | In the slot |
| UBU10011        | Ring 10 | A                   | 355                | 0,585  | 5,398     | Kulite |             |
| UBU10012        | Ring 10 | A                   | 355                | 0,785  | 5,308     | Geokon |             |
| UBU10013        | Cyl. 3  | Center              | 90                 | 0,050  | 6,317     | Geokon |             |
| UBU10014        | Cyl. 4  | Center              | 90                 | 0,050  | 6,916     | Geokon |             |

**Table 4-4. Numbering and position of instruments for measuring water content (W) in the buffer in hole 1.**

| Type and number | Block   | Instrument position |                    |        |        | Fabricate | Remark      |
|-----------------|---------|---------------------|--------------------|--------|--------|-----------|-------------|
|                 |         | Direction           | $\alpha$<br>degree | r<br>m | Z<br>m |           |             |
| WBU10001        | Cyl. 1  | Center              | 180                | 0,050  | 0,054  | Rotronic  |             |
| WBU10002        | Cyl. 1  | Center              | 0                  | 0,400  | 0,254  | Rotronic  |             |
| WBU10003        | Cyl. 1  | Center              | 180                | 0,100  | 0,254  | Rotronic  | Horizontal  |
| WBU10004        | Cyl. 1  | A                   | 350                | 0,785  | 0,344  | Vaisala   |             |
| WBU10005        | Cyl. 1  | A                   | 350                | 0,685  | 0,344  | Vaisala   |             |
| WBU10006        | Cyl. 1  | A                   | 350                | 0,585  | 0,344  | Vaisala   |             |
| WBU10007        | Cyl. 1  | B                   | 80                 | 0,585  | 0,344  | Vaisala   |             |
| WBU10008        | Cyl. 1  | B                   | 80                 | 0,685  | 0,254  | Rotronic  |             |
| WBU10009        | Cyl. 1  | B                   | 80                 | 0,785  | 0,254  | Rotronic  |             |
| WBU10010        | Cyl. 1  | C                   | 170                | 0,585  | 0,254  | Rotronic  |             |
| WBU10011        | Cyl. 1  | C                   | 170                | 0,685  | 0,254  | Rotronic  |             |
| WBU10012        | Cyl. 1  | C                   | 170                | 0,785  | 0,254  | Rotronic  |             |
| WBU10013        | Ring 5  | A                   | 350                | 0,585  | 2,870  | Vaisala   |             |
| WBU10014        | Ring 5  | A                   | 350                | 0,685  | 2,870  | Vaisala   |             |
| WBU10015        | Ring 5  | A                   | 350                | 0,785  | 2,870  | Vaisala   |             |
| WBU10016        | Ring 5  | B                   | 80                 | 0,535  | 2,780  | Rotronic  | In the slot |
| WBU10017        | Ring 5  | B                   | 80                 | 0,685  | 2,780  | Rotronic  |             |
| WBU10018        | Ring 5  | B                   | 80                 | 0,785  | 2,780  | Rotronic  |             |
| WBU10019        | Ring 5  | C                   | 180                | 0,535  | 2,870  | Vaisala   | In the slot |
| WBU10020        | Ring 5  | C                   | 180                | 0,685  | 2,870  | Vaisala   |             |
| WBU10021        | Ring 5  | C                   | 180                | 0,785  | 2,780  | Rotronic  |             |
| WBU10022        | Ring 10 | Center              | 0                  | 0,050  | 5,418  | Vaisala   |             |
| WBU10023        | Ring 10 | A                   | 180                | 0,362  | 5,428  | Vaisala   |             |
| WBU10024        | Ring 10 | A                   | 350                | 0,585  | 5,398  | Vaisala   |             |
| WBU10025        | Ring 10 | A                   | 350                | 0,685  | 5,398  | Vaisala   |             |
| WBU10026        | Ring 10 | A                   | 350                | 0,785  | 5,398  | Vaisala   |             |
| WBU10027        | Ring 10 | B                   | 80                 | 0,585  | 5,308  | Rotronic  |             |
| WBU10028        | Ring 10 | B                   | 80                 | 0,685  | 5,308  | Rotronic  |             |
| WBU10029        | Ring 10 | B                   | 80                 | 0,785  | 5,308  | Rotronic  |             |
| WBU10030        | Ring 10 | C                   | 170                | 0,585  | 5,398  | Vaisala   |             |
| WBU10031        | Ring 10 | C                   | 170                | 0,785  | 5,308  | Rotronic  |             |
| WBU10032        | Cyl. 3  | Center              | 270                | 0,050  | 6,317  | Vaisala   |             |
| WBU10033        | Cyl. 3  | A                   | 350                | 0,585  | 6,317  | Vaisala   |             |
| WBU10034        | Cyl. 3  | B                   | 90                 | 0,585  | 6,317  | Vaisala   |             |
| WBU10035        | Cyl. 3  | C                   | 180                | 0,585  | 6,317  | Rotronic  |             |
| WBU10036        | Cyl. 4  | Center              | 180                | 0,050  | 6,916  | Vaisala   |             |
| WBU10037        | Cyl. 4  | Center              | 270                | 0,050  | 6,756  | Vaisala   |             |

### 4.3 Position of each instrument in the bentonite in hole 3 (DA3575G01)

The instruments are located according to the same system as those in hole 1.

The positions of each instrument are described in Tables 4-6 to 4-10.

**Table 4-6. Numbering and position of instruments for measuring temperature (T) in the buffer in hole 3.**

| Type and number | Block   | Instrument position |                    |        |        | Fabricate | Remark                  |
|-----------------|---------|---------------------|--------------------|--------|--------|-----------|-------------------------|
|                 |         | Direction           | $\alpha$<br>degree | r<br>m | Z<br>m |           |                         |
| TBU30001        | Cyl. 1  | Center              | 270                | 0,050  | 0,095  | Pentronic |                         |
| TBU30002        | Cyl. 1  | Center              | 270                | 0,050  | 0,295  | Pentronic |                         |
| TBU30003        | Cyl. 1  | Center              | 270                | 0,050  | 0,445  | Pentronic |                         |
| TBU30004        | Cyl. 1  | A                   | 355                | 0,635  | 0,445  | Pentronic |                         |
| TBU30005        | Cyl. 1  | A                   | 355                | 0,735  | 0,445  | Pentronic |                         |
| TBU30006        | Cyl. 1  | B                   | 85                 | 0,685  | 0,445  | Pentronic |                         |
| TBU30007        | Cyl. 1  | C                   | 175                | 0,685  | 0,445  | Pentronic |                         |
| TBU30008        | Cyl. 1  | D                   | 270                | 0,585  | 0,445  | Pentronic |                         |
| TBU30009        | Cyl. 1  | D                   | 270                | 0,685  | 0,445  | Pentronic |                         |
| TBU30010        | Cyl. 1  | D                   | 270                | 0,785  | 0,445  | Pentronic |                         |
| TBU30011        | Ring 5  | A                   | 0                  | 0,635  | 2,971  | Pentronic |                         |
| TBU30012        | Ring 5  | A                   | 0                  | 0,735  | 2,971  | Pentronic |                         |
| TBU30013        | Ring 5  | B                   | 90                 | 0,585  | 2,971  | Pentronic |                         |
| TBU30014        | Ring 5  | B                   | 90                 | 0,685  | 2,971  | Pentronic |                         |
| TBU30015        | Ring 5  | B                   | 90                 | 0,785  | 2,971  | Pentronic |                         |
| TBU30016        | Ring 10 | A                   | 329                | 0,410  | 5,394  | Pentronic | Just above canister lid |
| TBU30017        | Ring 5  | C                   | 175                | 0,685  | 2,971  | Pentronic |                         |
| TBU30018        | Ring 5  | C                   | 175                | 0,735  | 2,971  | Pentronic |                         |
| TBU30019        | Ring 5  | D                   | 270                | 0,585  | 2,971  | Pentronic |                         |
| TBU30020        | Ring 5  | D                   | 270                | 0,635  | 2,971  | Pentronic |                         |
| TBU30021        | Ring 5  | D                   | 270                | 0,685  | 2,971  | Pentronic |                         |
| TBU30022        | Ring 5  | D                   | 270                | 0,735  | 2,971  | Pentronic |                         |
| TBU30023        | Ring 5  | D                   | 270                | 0,785  | 2,971  | Pentronic |                         |
| TBU30024        | Ring 10 | A                   | 0                  | 0,635  | 5,504  | Pentronic |                         |
| TBU30025        | Ring 10 | A                   | 0                  | 0,735  | 5,504  | Pentronic |                         |
| TBU30026        | Ring 10 | D                   | 270                | 0,585  | 5,504  | Pentronic |                         |
| TBU30027        | Ring 10 | D                   | 270                | 0,685  | 5,504  | Pentronic |                         |
| TBU30028        | Ring 10 | D                   | 270                | 0,785  | 5,504  | Pentronic |                         |
| TBU30029        | Cyl. 3  | A                   | 0                  | 0,785  | 6,314  | Pentronic |                         |
| TBU30030        | Cyl. 3  | B                   | 95                 | 0,585  | 6,314  | Pentronic |                         |
| TBU30031        | Cyl. 3  | C                   | 185                | 0,585  | 6,314  | Pentronic |                         |
| TBU30032        | Cyl. 4  | A                   | 0                  | 0,785  | 7,015  | Pentronic |                         |

**Table 4-7. Numbering and position of instruments for measuring total pressure (P) in the buffer in hole 3.**

| Type and number | Block   | Instrument position in block |                    |         |         |           | Remark      |
|-----------------|---------|------------------------------|--------------------|---------|---------|-----------|-------------|
|                 |         | Direction                    | $\alpha$<br>degree | r<br>mm | Z<br>mm | Fabricate |             |
| PBU30001        | Cyl. 1  | Center                       | 0                  | 0       | 0       | Geokon    | In cement   |
| PBU30002        | Cyl. 1  | Center                       | 0                  | 100     | 495     | Geokon    |             |
| PBU30003        | Cyl. 1  | A                            | 5                  | 585     | 495     | Kulite    | Vertical    |
| PBU30004        | Cyl. 1  | A                            | 5                  | 685     | 495     | Kulite    | Vertical    |
| PBU30005        | Cyl. 1  | A                            | 5                  | 785     | 495     | Kulite    | Vertical    |
| PBU30006        | Cyl. 1  | B                            | 95                 | 635     | 495     | Geokon    |             |
| PBU30007        | Cyl. 1  | B                            | 105                | 735     | 495     | Geokon    |             |
| PBU30008        | Cyl. 1  | C                            | 185                | 635     | 495     | Geokon    |             |
| PBU30009        | Cyl. 1  | C                            | 195                | 735     | 495     | Geokon    |             |
| PBU30010        | Ring 5  | A                            | 5                  | 535     | 3021    | Kulite    | In the slot |
| PBU30011        | Ring 5  | A                            | 5                  | 685     | 2771    | Geokon I  |             |
| PBU30012        | Ring 5  | A                            | 5                  | 825     | 3021    | Kulite    | In the slot |
| PBU30013        | Ring 5  | B                            | 95                 | 585     | 2771    | Geokon I  |             |
| PBU30014        | Ring 5  | B                            | 95                 | 785     | 2771    | Geokon I  |             |
| PBU30015        | Ring 5  | C                            | 185                | 535     | 3021    | Geokon I  | In the slot |
| PBU30016        | Ring 5  | C                            | 185                | 825     | 2971    | Kulite    | In the slot |
| PBU30017        | Ring 10 | Center                       | 0                  | 50      | 5556    | Geokon    |             |
| PBU30018        | Ring 10 | A                            | 5                  | 585     | 5556    | Kulite    | Vertical    |
| PBU30019        | Ring 10 | A                            | 5                  | 685     | 5556    | Kulite    | Vertical    |
| PBU30020        | Ring 10 | A                            | 5                  | 785     | 5556    | Kulite    | Vertical    |
| PBU30021        | Ring 10 | B                            | 90                 | 635     | 5556    | Geokon    |             |
| PBU30022        | Ring 10 | B                            | 100                | 735     | 5556    | Geokon    |             |
| PBU30023        | Ring 10 | C                            | 180                | 735     | 5556    | Geokon    |             |
| PBU30024        | Ring 10 | C                            | 190                | 635     | 5556    | Geokon    |             |
| PBU30025        | Cyl. 3  | Center                       | 0                  | 50      | 6314    | Kulite    | Vertical    |
| PBU30026        | Cyl. 3  | A                            | 5                  | 585     | 6564    | Geokon    |             |
| PBU30027        | Cyl. 4  | Center                       | 0                  | 50      | 7065    | Kulite    | Vertical    |

**Table 4-8. Numbering and position of instruments for measuring pore water pressure (U) in the buffer in hole 3.**

| Type and number | Block   | Instrument position in block |                    |         |         | Fabricate | Remark      |
|-----------------|---------|------------------------------|--------------------|---------|---------|-----------|-------------|
|                 |         | Direction                    | $\alpha$<br>degree | r<br>mm | Z<br>mm |           |             |
| UBU30001        | Cyl. 1  | Center                       | 90                 | 50      | 45      | Kulite    |             |
| UBU30002        | Cyl. 1  | Center                       | 90                 | 100     | 245     | Geokon    | Horizontal  |
| UBU30003        | Cyl. 1  | A                            | 355                | 585     | 335     | Geokon    |             |
| UBU30004        | Cyl. 1  | A                            | 355                | 785     | 335     | Kulite    |             |
| UBU30005        | Ring 5  | A                            | 355                | 585     | 2771    | Geokon    |             |
| UBU30006        | Ring 5  | A                            | 355                | 785     | 2861    | Kulite    |             |
| UBU30007        | Ring 5  | B                            | 85                 | 535     | 2861    | Kulite    | In the slot |
| UBU30008        | Ring 5  | B                            | 85                 | 825     | 2861    | Kulite    | In the slot |
| UBU30009        | Ring 5  | C                            | 175                | 535     | 2771    | Geokon    | In the slot |
| UBU30010        | Ring 5  | C                            | 175                | 825     | 2771    | Geokon    | In the slot |
| UBU30011        | Ring 10 | A                            | 355                | 585     | 5396    | Kulite    |             |
| UBU30012        | Ring 10 | A                            | 355                | 785     | 5306    | Geokon    |             |
| UBU30013        | Cyl. 3  | Center                       | 90                 | 50      | 6314    | Geokon    |             |
| UBU30014        | Cyl. 4  | Center                       | 90                 | 50      | 6910    | Geokon    |             |

**Table 4-9. Numbering and position of instruments for measuring water content (W) in the buffer in hole 3.**

| Type and number | Block   | Instrument position |                    |        |        | Fabricate | Remark      |
|-----------------|---------|---------------------|--------------------|--------|--------|-----------|-------------|
|                 |         | Direction           | $\alpha$<br>degree | r<br>m | Z<br>m |           |             |
| WBU30001        | Cyl. 1  | Center              | 180                | 0,050  | 0,045  | Rotronic  |             |
| WBU30002        | Cyl. 1  | Center              | 0                  | 0,400  | 0,215  | Rotronic  |             |
| WBU30003        | Cyl. 1  | Center              | 180                | 0,100  | 0,245  | Rotronic  | Horizontal  |
| WBU30004        | Cyl. 1  | A                   | 350                | 0,785  | 0,335  | Vaisala   |             |
| WBU30005        | Cyl. 1  | A                   | 350                | 0,685  | 0,335  | Vaisala   |             |
| WBU30006        | Cyl. 1  | A                   | 350                | 0,585  | 0,335  | Vaisala   |             |
| WBU30007        | Cyl. 1  | B                   | 80                 | 0,585  | 0,335  | Vaisala   |             |
| WBU30008        | Cyl. 1  | B                   | 80                 | 0,685  | 0,245  | Rotronic  |             |
| WBU30009        | Cyl. 1  | B                   | 80                 | 0,785  | 0,245  | Rotronic  |             |
| WBU30010        | Cyl. 1  | C                   | 170                | 0,585  | 0,245  | Rotronic  |             |
| WBU30011        | Cyl. 1  | C                   | 170                | 0,685  | 0,245  | Rotronic  |             |
| WBU30012        | Cyl. 1  | C                   | 170                | 0,785  | 0,245  | Rotronic  |             |
| WBU30013        | Ring 5  | A                   | 350                | 0,585  | 2,861  | Vaisala   |             |
| WBU30014        | Ring 5  | A                   | 350                | 0,685  | 2,861  | Vaisala   |             |
| WBU30015        | Ring 5  | A                   | 350                | 0,785  | 2,861  | Vaisala   |             |
| WBU30016        | Ring 5  | B                   | 80                 | 0,535  | 2,771  | Rotronic  | In the slot |
| WBU30017        | Ring 5  | B                   | 80                 | 0,685  | 2,771  | Rotronic  |             |
| WBU30018        | Ring 5  | B                   | 80                 | 0,785  | 2,771  | Rotronic  |             |
| WBU30019        | Ring 5  | C                   | 180                | 0,535  | 2,861  | Vaisala   | In the slot |
| WBU30020        | Ring 5  | C                   | 180                | 0,685  | 2,861  | Vaisala   |             |
| WBU30021        | Ring 5  | C                   | 180                | 0,785  | 2,771  | Rotronic  |             |
| WBU30022        | Ring 10 | Center              | 180                | 0,050  | 5,416  | Vaisala   |             |
| WBU30023        | Ring 10 | A                   | 352                | 0,262  | 5,396  | Vaisala   |             |
| WBU30024        | Ring 10 | A                   | 350                | 0,585  | 5,396  | Vaisala   |             |
| WBU30025        | Ring 10 | A                   | 350                | 0,785  | 5,396  | Vaisala   |             |
| WBU30026        | Ring 10 | A                   | 350                | 0,685  | 5,396  | Vaisala   |             |
| WBU30027        | Ring 10 | B                   | 80                 | 0,585  | 5,306  | Rotronic  |             |
| WBU30028        | Ring 10 | B                   | 80                 | 0,685  | 5,306  | Rotronic  |             |
| WBU30029        | Ring 10 | B                   | 80                 | 0,785  | 5,306  | Rotronic  |             |
| WBU30030        | Ring 10 | C                   | 170                | 0,585  | 5,396  | Vaisala   |             |
| WBU30031        | Ring 10 | C                   | 170                | 0,785  | 5,306  | Rotronic  |             |
| WBU30032        | Cyl. 3  | Center              | 180                | 0,050  | 6,314  | Vaisala   |             |
| WBU30033        | Cyl. 3  | A                   | 350                | 0,585  | 6,314  | Vaisala   |             |
| WBU30034        | Cyl. 3  | B                   | 90                 | 0,585  | 6,314  | Vaisala   |             |
| WBU30035        | Cyl. 3  | C                   | 180                | 0,585  | 6,314  | Rotronic  |             |
| WBU30036        | Cyl. 4  | Center              | 180                | 0,050  | 6,910  | Vaisala   |             |
| WBU30037        | Cyl. 4  | Center              | 270                | 0,050  | 6,750  | Vaisala   |             |



#### **4.4 Instruments on the canister surface in holes 1-4**

The canisters are instrumented with optical fiber cables on the copper surface.

Figure 4-2 shows how two optical fiber cables are placed on the canister surface. Both ends of a cable are used for measurements. This means that the two cables are used for four measurements.

With this laying the cables will enter and exit the surface at almost the same position. Curvatures are shaped as a quarter circle with a radius of 20 cm. The cables are placed in a milled out channels on the surface. The channels have a width and a depth of just above 2 mm

In addition to the optical cables one thermocouple (TBU 10006) is fixed to the lid of the canister in deposition hole 2 (see Table 4-1).

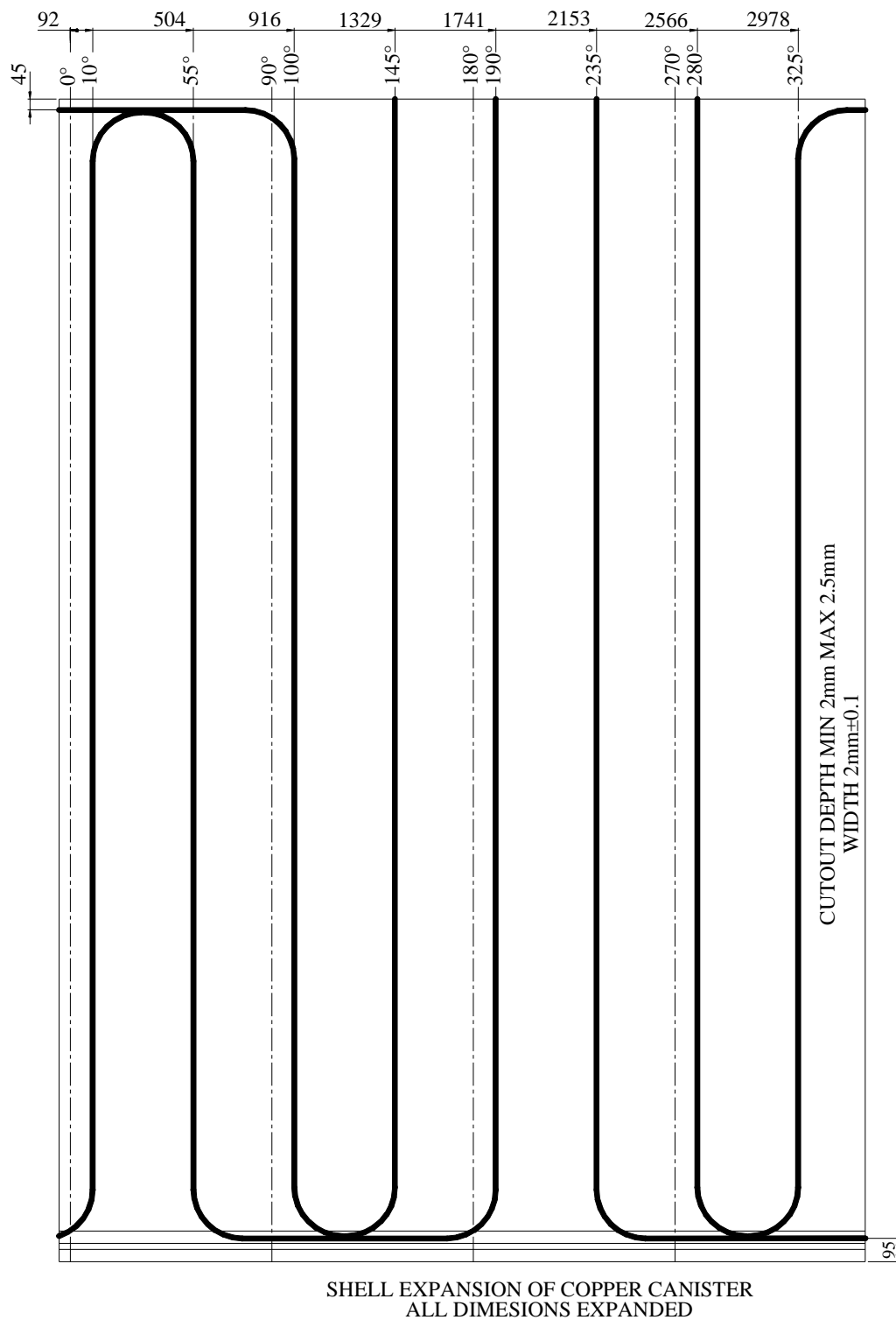

**Figure 4-2.** Laying of the optical fiber cables with protection tube of Inconel 625 (outer diameter 2 mm) for measurement of the canister surface temperature (surface unfolded).

## 4.5 Position of temperature sensors in the rock

The positions of the temperature sensors in the rock are termed in the same way as the sensors in the buffer in the deposition holes. Figure 4-3 shows an overview of the temperature sensors placed in the rock. The sensors are assigned to the closest deposition hole. The positions are described in Table 4-10.

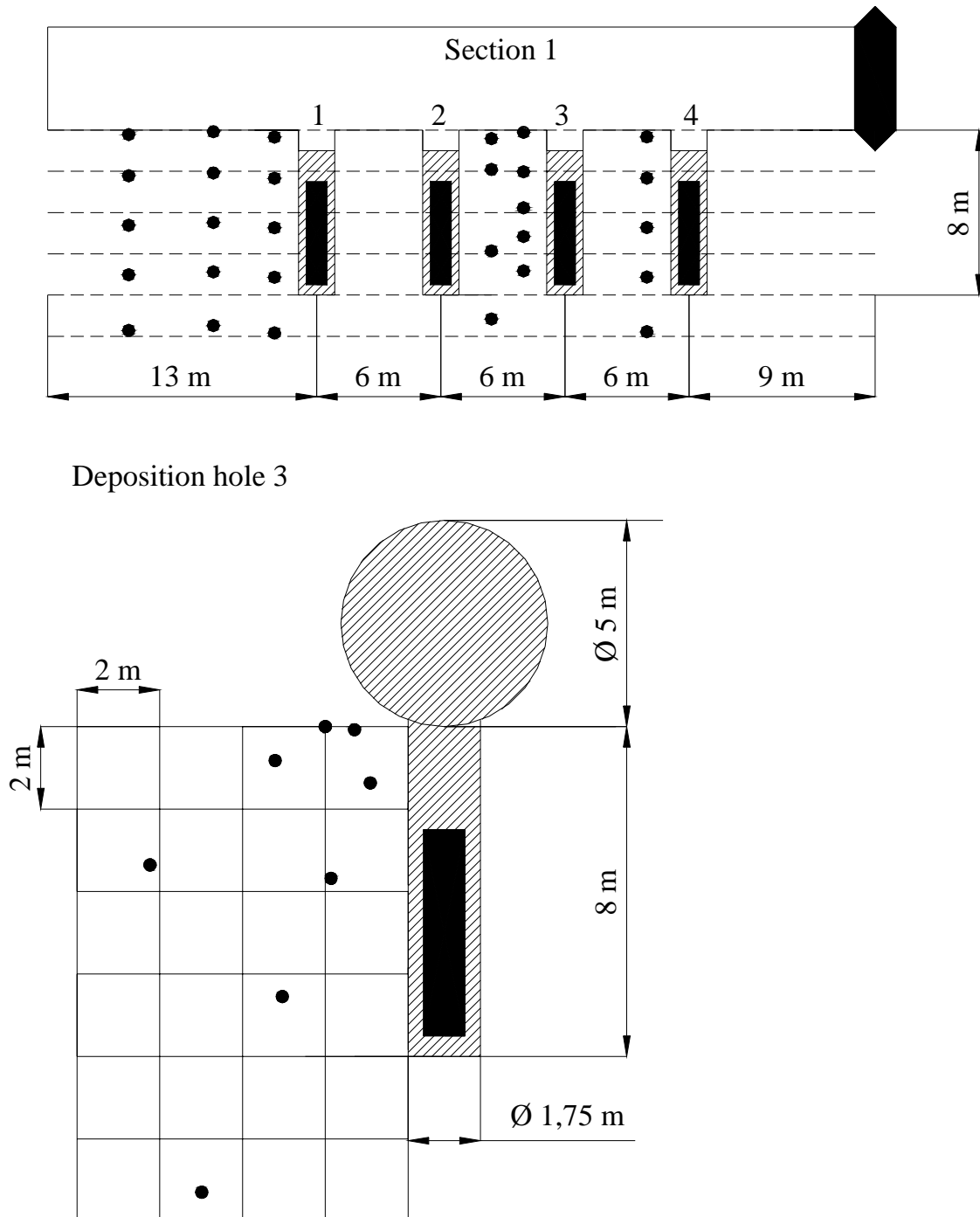

**Figure 4-3.** Overview of the temperature sensors in the rock. Length section (upper) and cross section (towards the end of the tunnel).

**Table 4-10. Numbering and position of temperature sensors in the rock.**

| Instrument position in rock      |          |       |        |           |
|----------------------------------|----------|-------|--------|-----------|
| Type and number                  | $\alpha$ | r     | Z      | Fabricate |
|                                  | degree   | m     | m      |           |
| Measured from DA3587G01(Hole 1)  |          |       |        |           |
| TROA0350                         | 360      | 9,080 | 7,785  | Pentronic |
| TROA0340                         | 360      | 9,080 | 5,785  | Pentronic |
| TROA0330                         | 360      | 9,080 | 3,385  | Pentronic |
| TROA0320                         | 0        | 9,080 | 0,986  | Pentronic |
| TROA0310                         | 0        | 9,081 | -1,714 | Pentronic |
| TROA0650                         | 360      | 4,990 | 7,922  | Pentronic |
| TROA0640                         | 360      | 4,982 | 5,922  | Pentronic |
| TROA0630                         | 360      | 4,972 | 3,522  | Pentronic |
| TROA0620                         | 360      | 4,961 | 1,122  | Pentronic |
| TROA0610                         | 360      | 4,951 | -1,478 | Pentronic |
| TROA1050                         | 359      | 2,014 | 7,663  | Pentronic |
| TROA1040                         | 359      | 2,022 | 5,663  | Pentronic |
| TROA1030                         | 359      | 2,032 | 3,263  | Pentronic |
| TROA1020                         | 359      | 2,042 | 0,863  | Pentronic |
| TROA1010                         | 359      | 2,053 | -1,837 | Pentronic |
| Measured from DA3581G01(Hole 2)  |          |       |        |           |
| TROA1840                         | 179      | 2,403 | 7,584  | Pentronic |
| TROA1830                         | 179      | 2,427 | 6,084  | Pentronic |
| TROA1820                         | 179      | 2,489 | 2,135  | Pentronic |
| TROA1810                         | 179      | 2,541 | -1,165 | Pentronic |
| Measured from DA3575G01(Hole 3)  |          |       |        |           |
| TROA2150                         | 134      | 3,287 | 7,956  | Pentronic |
| TROA2140                         | 1        | 1,993 | 5,977  | Pentronic |
| TROA2130                         | 1        | 1,975 | 4,228  | Pentronic |
| TROA2120                         | 2        | 1,961 | 2,838  | Pentronic |
| TROA2110                         | 3        | 1,944 | 1,168  | Pentronic |
| TROA1850                         | 360      | 2,013 | 7,887  | Pentronic |
| TROA2330                         | 90       | 2,192 | 7,922  | Pentronic |
| TROA2320                         | 90       | 1,786 | 6,630  | Pentronic |
| TROA2310                         | 109      | 7,111 | 4,638  | Pentronic |
| TROA2440                         | 124      | 4,090 | 7,172  | Pentronic |
| TROA2430                         | 90       | 2,735 | 4,317  | Pentronic |
| TROA2420                         | 89       | 3,912 | 1,449  | Pentronic |
| TROA2410                         | 89       | 5,86  | -3,297 | Pentronic |
| Measured from DA3569G01 (Hole 4) |          |       |        |           |
| TROA3050                         | 359      | 2,013 | 7,665  | Pentronic |
| TROA3040                         | 359      | 2,020 | 5,665  | Pentronic |
| TROA3030                         | 358      | 2,030 | 3,265  | Pentronic |
| TROA3020                         | 357      | 2,040 | 0,865  | Pentronic |
| TROA3010                         | 357      | 2,051 | -1,784 | Pentronic |

## 4.6 Strategy for describing the position of each device in the backfill in section 1

The principles of terming the instruments are described in the quick guide inserted as a folded A3 page at the end of the report.

Every instrument is named with a unique name consisting of 1 letter describing the type of measurement, 2 letters describing where the measurement takes place (buffer, backfill, rock or canister) and 5 figures specifying the instrument according to separate lists (see Tables 4-11 to 4-14). Every instrument position is then described with three coordinates according to Figure 2-2. The  $x$ -coordinate is the horizontal distance from the center of the tunnel and the  $z$ -coordinate is the vertical distance from the center of the tunnel. The  $y$ -coordinate is the same as in the tunnel coordinate system, i.e.  $y=3599$  corresponds to the end of the tunnel.

The backfill is mainly instrumented in vertical sections straight above and between the deposition holes (Figures 4-4 and 4-5).

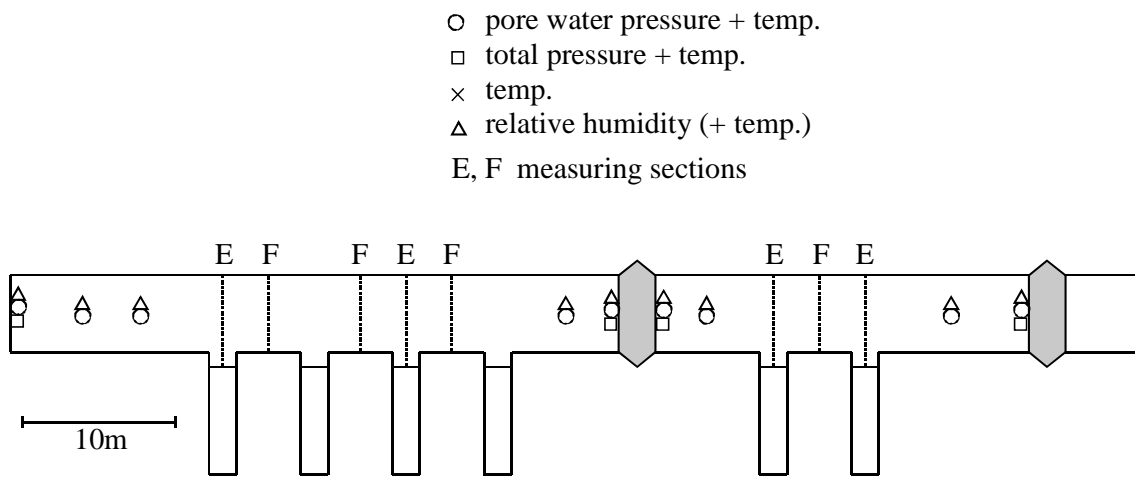

**Figure 4-4.** Schematic view over the instrumentation of the backfill.

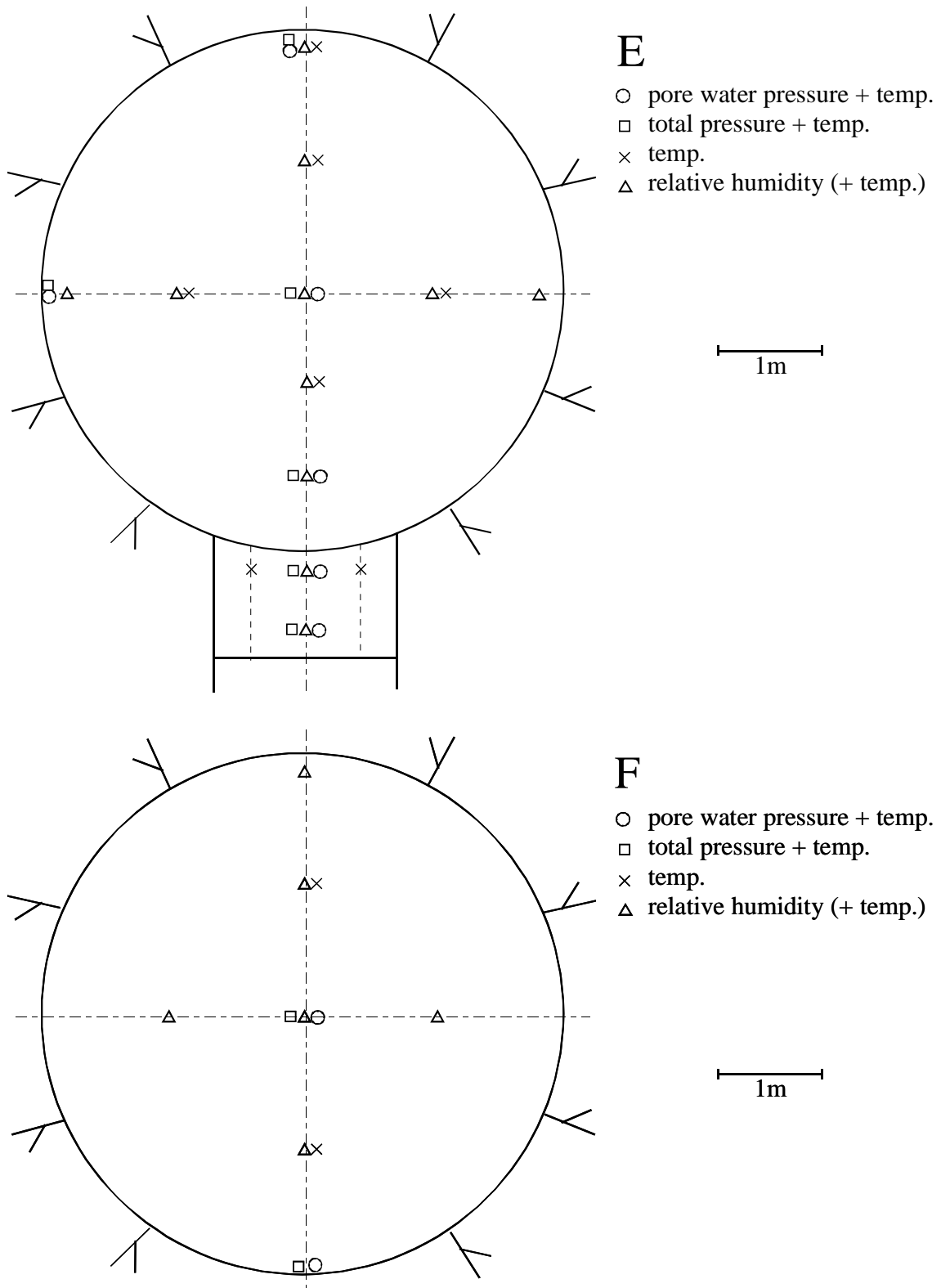

*Figure 4-5. Schematic view over the sensors positions in the different sections.*

## 4.7 Position of each instrument in the backfill

The positions of each instrument are described in Tables 4-11 to 4-14.

**Table 4-11. Numbering and position of instruments for measuring temperature (T) in the backfill.**

| Type and number | Instrument position         |      |      | Fabricate | Remark    |   |
|-----------------|-----------------------------|------|------|-----------|-----------|---|
|                 | Section                     | x    | z    |           |           | y |
|                 |                             | m    | m    |           |           | m |
| TBA10001        | E, over dep.hole 1          | -1,3 | -0,1 | 3 587     | Pentronic |   |
| TBA10002        | E, over dep.hole 1          | 0,1  | 1,3  | 3 587     | Pentronic |   |
| TBA10003        | E, over dep.hole 1          | 0,0  | -0,8 | 3 587     | Pentronic |   |
| TBA10004        | E, over dep.hole 1          | -0,5 | -2,6 | 3 587     | Pentronic |   |
| TBA10005        | E, over dep.hole 1          | 0,5  | -2,6 | 3 587     | Pentronic |   |
| TBA10006        | E, over dep.hole 1          | -0,1 | 2,3  | 3 587     | Pentronic |   |
| TBA10007        | E, over dep.hole 1          | 1,3  | -0,1 | 3 587     | Pentronic |   |
| TBA10008        | F, between dep.hole 1 and 2 | 0,0  | 1,3  | 3 584     | Pentronic |   |
| TBA10009        | F, between dep.hole 1 and 2 | -0,1 | -1,3 | 3 584     | Pentronic |   |
| TBA10010        | F, between dep.hole 2 and 3 | 0,0  | 1,2  | 3 578     | Pentronic |   |
| TBA10011        | F, between dep.hole 2 and 3 | 0,0  | -1,2 | 3 578     | Pentronic |   |
| TBA10012        | E, over dep.hole 3          | -0,1 | 2,3  | 3 575     | Pentronic |   |
| TBA10013        | E, over dep.hole 3          | 0,0  | 1,3  | 3 575     | Pentronic |   |
| TBA10014        | E, over dep.hole 3          | 0,0  | -0,9 | 3 575     | Pentronic |   |
| TBA10015        | E, over dep.hole 3          | -0,5 | -2,6 | 3 575     | Pentronic |   |
| TBA10016        | E, over dep.hole 3          | 0,5  | -2,6 | 3 575     | Pentronic |   |
| TBA10017        | E, over dep.hole 3          | -1,3 | 0,0  | 3 575     | Pentronic |   |
| TBA10018        | E, over dep.hole 3          | 1,3  | 0,0  | 3 575     | Pentronic |   |
| TBA10019        | F, between dep.hole 3 and 4 | 0,0  | 1,2  | 3 572     | Pentronic |   |
| TBA10020        | F, between dep.hole 3 and 4 | 0,0  | -1,3 | 3 572     | Pentronic |   |

**Table 4-12. Numbering and position of instruments for measuring total pressure (P) in the backfill.**

| Type and number | Instrument position         |      |      | Fabricate | Remark |
|-----------------|-----------------------------|------|------|-----------|--------|
|                 | Section                     | x    | z    |           |        |
|                 |                             | m    | m    | m         |        |
| PBA10001        | Inner part                  | 0,2  | 0,1  | 3589      | Kulite |
| PBA10002        | E, over dep.hole 1          | 0,0  | 0,0  | 3587      | Geokon |
| PBA10003        | E, over dep.hole 1          | 0,0  | -1,8 | 3587      | Geokon |
| PBA10004        | E, over dep.hole 1          | 0,0  | -2,6 | 3587      | Geokon |
| PBA10005        | E, over dep.hole 1          | 0,0  | -3,1 | 3587      | Kulite |
| PBA10006        | E, over dep.hole 1          | -2,3 | 0,1  | 3587      | Kulite |
| PBA10007        | E, over dep.hole 1          | 0,2  | 2,3  | 3587      | Kulite |
| PBA10008        | F, between dep.hole 1 and 2 | 0,0  | 0,0  | 3584      | Geokon |
| PBA10009        | F, between dep.hole 1 and 2 | -0,1 | -1,8 | 3584      | Geokon |
| PBA10010        | F, between dep.hole 2 and 3 | 0,0  | -0,2 | 3578      | Kulite |
| PBA10011        | F, between dep.hole 2 and 3 | 0,0  | -2,3 | 3578      | Kulite |
| PBA10013        | E, over dep.hole 3          | 0,0  | -1,8 | 3575      | Kulite |
| PBA10015        | E, over dep.hole 3          | 0,0  | -3,1 | 3575      | Geokon |
| PBA10016        | E, over dep.hole 3          | -2,3 | 0,0  | 3575      | Geokon |
| PBA10017        | E, over dep.hole 3          | 0,0  | 0,0  | 3575      | Geokon |
| PBA10018        | F, between dep.hole 3 and 4 | 0,0  | 0,0  | 3572      | Geokon |
| PBA10019        | F, between dep.hole 3 and 4 | 0,0  | -2,3 | 3572      | Geokon |
| PBA10020        | In front of plug            | 0,0  | 0,0  | 3561      | Kulite |



**Table 4-13. Numbering and position of instruments for measuring pore water pressure (U) in the backfill.**

| Type and number | Instrument position         |      |      | Fabricate | Remark |   |
|-----------------|-----------------------------|------|------|-----------|--------|---|
|                 | Section                     | x    | z    |           |        | y |
|                 |                             | m    | m    |           |        | m |
| UBA10001        | Inner part                  | -0,2 | -0,1 | 3589      | Kulite |   |
| UBA10002        | Inner part                  | 0,0  | 0,0  | 3592      | Geokon |   |
| UBA10003        | Inner part                  | -0,2 | -0,1 | 3590      | Geokon |   |
| UBA10004        | E, over dep.hole 1          | 0,0  | -0,1 | 3587      | Geokon |   |
| UBA10005        | E, over dep.hole 1          | -0,2 | -1,8 | 3587      | Kulite |   |
| UBA10006        | E, over dep.hole 1          | 0,1  | -2,6 | 3587      | Kulite |   |
| UBA10007        | E, over dep.hole 1          | 0,4  | -3,2 | 3587      | Kulite |   |
| UBA10008        | E, over dep.hole 1          | -2,3 | 0,0  | 3587      | Geokon |   |
| UBA10009        | E, over dep.hole 1          | 0,0  | 2,3  | 3587      | Geokon |   |
| UBA10010        | F, between dep.hole 1 and 2 | 0,0  | 0,0  | 3584      | Kulite |   |
| UBA10011        | F, between dep.hole 1 and 2 | 0,1  | -1,8 | 3584      | Kulite |   |
| UBA10012        | F, between dep.hole 2 and 3 | 0,0  | -0,2 | 3578      | Kulite |   |
| UBA10013        | F, between dep.hole 2 and 3 | 0,0  | -2,3 | 3578      | Kulite |   |
| UBA10014        | E, over dep.hole 3          | 0,0  | 0,0  | 3575      | Kulite |   |
| UBA10015        | E, over dep.hole 3          | 0,0  | -1,8 | 3575      | Geokon |   |
| UBA10016        | E, over dep.hole 3          | 0,3  | -2,6 | 3575      | Geokon |   |
| UBA10017        | E, over dep.hole 3          | -0,1 | -3,1 | 3575      | Geokon |   |
| UBA10018        | E, over dep.hole 3          | -2,3 | 0,0  | 3575      | Geokon |   |
| UBA10019        | E, over dep.hole 3          | 0,0  | 0,0  | 3575      | Geokon |   |
| UBA10020        | F, between dep.hole 3 and 4 | 0,0  | 0,0  | 3572      | Kulite |   |
| UBA10021        | F, between dep.hole 3 and 4 | 0,0  | -2,3 | 3572      | Kulite |   |
| UBA10022        | In front of plug            | 0,0  | 0,0  | 3565      | Kulite |   |
| UBA10023        | In front of plug            | 0,1  | 0,0  | 3562      | Kulite |   |

**Table 4-14. Numbering and position of instruments for measuring relative humidity (W) in the backfill.**

| Type and number | Instrument position         |      |      | Fabricate | Remark |
|-----------------|-----------------------------|------|------|-----------|--------|
|                 | Section                     | x    | z    |           |        |
|                 |                             | m    | m    | m         |        |
| WBA10001        | Inner part                  | 0,0  | 0,0  | 3589      | Wescor |
| WBA10002        | Inner part                  | 0,0  | 0,0  | 3592      | Wescor |
| WBA10003        | Inner part                  | 0,1  | -0,1 | 3590      | Wescor |
| WBA10004        | E, over dep.hole 1          | 0,3  | 2,3  | 3587      | Wescor |
| WBA10005        | E, over dep.hole 1          | 0,0  | 1,3  | 3587      | Wescor |
| WBA10006        | E, over dep.hole 1          | 0,0  | 0,1  | 3587      | Wescor |
| WBA10007        | E, over dep.hole 1          | 0,1  | -0,8 | 3587      | Wescor |
| WBA10008        | E, over dep.hole 1          | 0,0  | -1,7 | 3587      | Wescor |
| WBA10009        | E, over dep.hole 1          | -0,1 | -2,6 | 3587      | Wescor |
| WBA10010        | E, over dep.hole 1          | -0,5 | -3,1 | 3587      | Wescor |
| WBA10011        | E, over dep.hole 1          | -2,3 | -0,1 | 3587      | Wescor |
| WBA10012        | E, over dep.hole 1          | -1,3 | 0,0  | 3587      | Wescor |
| WBA10013        | E, over dep.hole 1          | 1,3  | 0,0  | 3587      | Wescor |
| WBA10014        | E, over dep.hole 1          | 2,3  | 0,0  | 3587      | Wescor |
| WBA10015        | F, between dep.hole 1 and 2 | 0,0  | 1,3  | 3584      | Wescor |
| WBA10016        | F, between dep.hole 1 and 2 | 0,0  | 2,3  | 3584      | Wescor |
| WBA10017        | F, between dep.hole 1 and 2 | 0,0  | 0,0  | 3584      | Wescor |
| WBA10018        | F, between dep.hole 1 and 2 | 0,0  | -1,3 | 3584      | Wescor |
| WBA10019        | F, between dep.hole 1 and 2 | -1,3 | 0,0  | 3584      | Wescor |
| WBA10020        | F, between dep.hole 1 and 2 | 1,3  | 0,0  | 3584      | Wescor |
| WBA10021        | F, between dep.hole 2 and 3 | 0,0  | 2,3  | 3578      | Wescor |
| WBA10022        | F, between dep.hole 2 and 3 | 0,0  | 1,2  | 3578      | Wescor |
| WBA10023        | F, between dep.hole 2 and 3 | 0,0  | -0,2 | 3578      | Wescor |
| WBA10024        | F, between dep.hole 2 and 3 | 0,0  | -1,2 | 3578      | Wescor |
| WBA10025        | F, between dep.hole 2 and 3 | -1,3 | 0,0  | 3578      | Wescor |
| WBA10026        | F, between dep.hole 2 and 3 | 1,3  | 0,0  | 3578      | Wescor |
| WBA10027        | E, over dep.hole 3          | 0,0  | 2,5  | 3575      | Wescor |
| WBA10028        | E, over dep.hole 3          | 0,0  | 1,3  | 3575      | Wescor |
| WBA10029        | E, over dep.hole 3          | 0,0  | 0,0  | 3575      | Wescor |
| WBA10030        | E, over dep.hole 3          | 0,0  | -0,9 | 3575      | Wescor |
| WBA10031        | E, over dep.hole 3          | 0,0  | -1,6 | 3575      | Wescor |
| WBA10032        | E, over dep.hole 3          | -0,3 | -2,6 | 3575      | Wescor |
| WBA10033        | E, over dep.hole 3          | 0,1  | -3,1 | 3575      | Wescor |
| WBA10034        | E, over dep.hole 3          | -2,3 | 0,0  | 3575      | Wescor |
| WBA10035        | E, over dep.hole 3          | -1,3 | 0,0  | 3575      | Wescor |
| WBA10036        | E, over dep.hole 3          | 1,3  | 0,0  | 3575      | Wescor |
| WBA10037        | E, over dep.hole 3          | 2,3  | 0,0  | 3575      | Wescor |
| WBA10038        | F, between dep.hole 3 and 4 | 0,0  | 2,3  | 3572      | Wescor |
| WBA10039        | F, between dep.hole 3 and 4 | 0,0  | 1,2  | 3572      | Wescor |
| WBA10040        | F, between dep.hole 3 and 4 | 0,0  | 0,0  | 3572      | Wescor |
| WBA10041        | F, between dep.hole 3 and 4 | 0,0  | -1,3 | 3572      | Wescor |
| WBA10042        | F, between dep.hole 3 and 4 | -1,3 | 0,0  | 3572      | Wescor |
| WBA10043        | F, between dep.hole 3 and 4 | 1,3  | 0,0  | 3572      | Wescor |
| WBA10044        | In front of plug            | 0,0  | 0,0  | 3565      | Wescor |
| WBA10045        | In front of plug            | -0,1 | 0,0  | 3562      | Wescor |

## 5 Results and comments for Section 1

### 5.1 General

In this chapter short comments on general trends in the measurements are given. Sensors that are not delivering reliable data or no data at all are noted and comments on the data collection in general are given.

The heating of the canister in hole1 started with an applied constant power of 1800 W at 010917. This date is also marked as start date. The backfilling started 010903 and was finished 011120 and the plug was cast at 011214. In order to simulate the radioactive decay, the power was decreased 20 W one year after start of the first heater. At the beginning of September 2004 the power was decreased with about 30 W to 1710 W in deposition holes 1-4. Table 5-1 shows some important dates for section 1. At the beginning of November 2004 the drainage of the inner part of Section 1 and the drainage trough the outer plug were closed. At the beginning of December 2004 damages were observed on one canister in Section 1 (No 1) and one in Section 2 (No 6) probably due to high water pressure in the buffer and backfill. It was then decided to switch off the power to all canisters. This was done on December 2. The drainage of the tunnel was opened on December 6 and investigations on the damaged canisters were initialized. The power to all the canisters, except for canister 2, was on December 15 switched on. The damages on canister 2 were so severe that it was impossible to apply any power in this canister. The drainage of the tunnel was kept open.

**Table 5-1. Key dates for section 1.**

| Activity                                    | Date       |
|---|------------|
| Start backfilling                           | 3/9 2001   |
| Start heating canister 1                    | 17/9 2001  |
| Start heating canister 2                    | 24/9 2001  |
| Start heating canister 3                    | 11/10 2001 |
| Start heating canister 4                    | 22/10 2001 |
| Finish backfilling                          | 20/11 2001 |
| Plug casting                                | 14/12 2001 |
| Decreased power (-20 W)                     | 17/9 2002  |
| Decreased power (-40 W)                     | 5/9 2003   |
| Decreased power (-30 W)                     | 8/9 2004   |
| The drainage of tunnel was closed           | 1/10 2004  |
| The power to all canisters was switched off | 2/12 2004  |
| The drainage of the tunnel was opened       | 6/12 2004  |
| The power to the canisters was switched on  | 15/12 2004 |
| Decreased power (-30 W)                     | 2/12 2005  |
| A packer installed in the rock was broken   | 18/5 2006  |
| Decreased power (-30 W)                     | 21/12 2006 |

In December 2005 and 2006 the power to the canisters was reduced with about 30 W. The applied power after the latest reduction is about 1650 W.

Beside the above reported power reductions a change in power was made June 23 2003 due to additional calculations of the power from measurement of the energy. The power of the canisters was adjusted to 1800 W. The most significant change was made for canister 2 (See section 5.4.1 and Appendix 3 page 138).

About 225 out of 363 sensors (excluding water pressure sensors in the rock and the displacement sensors for the canister) are out of order, the majority being RH-sensors that fail at water saturation and thermocouples in deposition hole 3.

The measured processes were slow up to about 20 days after the drainage of the tunnel was closed. Very small changes of the measured parameters occurred up to that date. After that the readings from some of the total and pore pressure sensors placed in the buffer reacted strongly (quick increase in pressure). Also the total and pore pressure sensors placed in the backfill recorded high pressures caused by the closing of the drainage. After the reopening of the drainage of the tunnel, both the pore pressures and the total pressures were stabilized on almost the same level as before the closing of the drainage. At around day 1670 both the total pressure sensors and the pore pressure sensors are measuring an increase in pressure. This is caused by a failure in one packer placed in the rock at the inner part of the tunnel causing an increase in out flow of water from the inner section from about 1,5 l/min to more than 9 l/min.

So far hole 1 has been strongly wetted and a very slowly wetting is observed in hole 3. A slow but obvious wetting of the backfill is noted until about 20 days after the closing of the drainage. After that a strong increase of the wetting rate was monitored by several psychrometers. The measurement of the temperature on the canister surface with the optical system has stopped functioning.

## **5.2 Deposition hole 1**

### **5.2.1 Total pressure**

#### **Geokon (App. 1\pages 89-91)**

The measured pressure range is from 0 to 8.5 MPa. The highest pressure is indicated from the peripheral sensors in the bottom block (C1). Four sensors in block R5 and block R10 yielded a high increase in total pressure when the drainage of the tunnel was closed. Most of the sensors yielded a drop in pressure when the heaters where switched off and the drainage of the tunnel was opened again and an increase in pressure when the heaters where switched on again.

Fifteen sensors are out of order.

#### **Kulite (App. 1\page 92)**

The highest pressure 7 MPa was measured with one sensor placed in the peripheral of block R5 (PBU 10012) just before the drainage was closed. Three of the installed sensors indicated a rapid increase in pressure when the drainage of the tunnel was closed followed by a drop in pressure when the power was switched off and the drainage was reopened. After the power was switched on the pressure increased to the same level as before the closing of the drainage.

Two sensors were not installed and five of the installed sensors are out of order.

## **5.2.2 Relative humidity**

### **Vaisala (App. 1\pages 93-96)**

Since temperature is also measured with all relative humidity sensors, the diagrams include those measured temperatures. The temperature measurements start at about 16 degrees while the RH measurements start at about 70 %RH.

The relative humidity has not changed very much during the last 6 months, except for the sensors placed above the canister (in Cylinder 3 and 4) which are indicating a slowly wetting. The sensors have not reached 100 RH. The temperature measurements were effected when the power to the heaters was switched off but reached the same levels as before when the power was switched on again. A slow decrease in temperature is measured by all of the still working sensors

Fifteen sensors are out of order, most of them due to water saturation.

### **Rotronic (App. 1\pages 97-101)**

All Rotronic sensors placed between the canister and the rock show RH higher than 90%.

Two of the sensors placed in the central part of block C1 indicated a drying of the bentonite (decreasing in RH from about 75%) up to the time when they stopped working (after about 1000 days).

All of the installed sensors have stopped giving reliable values on the RH in the buffer, most of them due to water saturation. Many of the temperature sensors are still working.

## **5.2.3 Pore water pressure**

### **Geokon (App. 1\page 102)**

The highest pressures 500-1450 kPa are measured near the canister surface in block R5 (UBU10005), in the periphery of block R5 (UBU10010) and in the center of block C1. One sensor in block C4 is also recording an increasing pressure (UBU10014) while the rest of the sensors are measuring very low pressures.

Two sensors are out of order.

### **Kulite (App. 1\page 103)**

Rather high water pressures have been measured by three sensors located in block R5 (1200 – 3500 kPa). One sensor placed in the outer slot started to react about 50 days after the start of the measurement. A sesor placed in the inner slot between the canister and the bentonite blocks (UBU10007) started to react around day 350 indicating that water has reached the inner slot. The pore pressure measured with two of the sensors reacted strongly during the period when the drainage of the tunnel was closed and during the period when the power to the canister was switched off. The sensors measured an increase of the pressure with about 100 kPa after the middle of May 2007. This change in pressure is probably cause by the preparation work done for a new tunnel near by the Prototype tunnel.

Two sensors are out of order.

#### **5.2.4 Temperature in the buffer (App. 1\pages 104-110)**

The measured temperature after the power to the canister was switched on again ranges from 28.0 °C (in the periphery of the upper bentonite cylinder C4) to 70.0 °C in block R5 close to the canister. The highest temperature gradient measured in the buffer is 0.57 °C /cm (block R5).

Twenty-six sensors are out of order.

The temperature in the buffer is also measured with the Geokon sensors (from day 1350). The maximum temperature recorded with these sensors at the end of this measuring period (PBU10002 placed in the center of block C1 close to the canister). is about 61 °C

#### **5.2.5 Canister power in dep. hole 1 (App. 1\page 114)**

The power of the canister in hole 1 was kept constant during one year at 1800 W since the start 010917. After one year the power was decreased with about 20 W. After another year the power was decreased with about 40 W. The next reduction of power was made at the beginning of September year 2004 (about 30 W). The power of the canister in hole 1 was about 1710 W after this reduction. During the period between December 6 and December 15 2004 the power to the canister was switched off. After that period the power was adjusted to about 1710 W again. At the beginning of December 2005 the power was decreased with 30 W to about 1680 W. The latest reduction of the power with about 30 W was done at the end of year 2006.

#### **5.2.6 Temperature on the canister surface (App. 1\pages 115-116)**

The first diagram shows the maximum temperature, measured with the optical cables placed on the surface of the canister, plotted as function of time. The maximum measured temperature on the canister surface is about 75 °C. With no damages on the optical cables this plot should have four curves. Only one curve with relevant values is presented here up to December 24 which indicates that the optical cables are damaged. The second diagram shows the distribution of the temperature along the optical cables at December 1 2004. The length of the cables on the canister surface is about 20 m. The variation of a few degrees is caused by the difference in temperature in the center and ends of the canister. At December 15 2004 the optical system for measuring the temperature on this canister stopped functioning.

### **5.3 Deposition hole 3**

#### **5.3.1 Total pressure**

##### **Geokon (App. 2\pages 119-121)**

The total pressure measured in this deposition hole is significantly lower than those measured in deposition hole 1. Many of the sensors placed in block C1 and block R10 yielded an increase in total pressure when the drainage of the tunnel was closed The

maximum pressure registered so far is 4 MPa (PBU30023). This value was obtained when the drainage was closed. The sensor is placed in block R10. Four out of 16 sensors have measured a pressure higher than 500 kPa.

Ten sensors are out of order.

### **Kulite (App. 2\pages 122-123)**

The highest pressure, 1.8 MPa, is indicated from the peripheral placed sensors in block R10. The sudden change in pressure that occurred after about 180 days was probably caused by early data logger problems.

Ten sensors are out of order

## **5.3.2 Relative humidity**

### **Vaisala (App. 2\pages 124-127)**

A significant drying of the bentonite close to the top of the canister was observed by the two sensors WBU30022 and WBU30023. After the closing of the drainage both sensors indicated a significant increasing in relative humidity. An increased wetting of the bentonite can be observed by sensors place in block R10 between the canister and the rock. One sensor placed in block R5 showed an increase in relative humidity from about 70% to 82% after the closing of the drainage. Two sensors (WBU30019 and WBU30020) placed in block R5 are measuring a decrease in relative humidity (indicating a drying of the buffer) after the power was switched on again

Sixteen sensors are out of order.

### **Rotronic (App. 2\pages 128-132)**

All Rotronic sensors in hole 3 have failed or increased the measured RH to 100%. The reason for this is unclear. Since there are no other signs of strong wetting, malfunction are more probable than strong wetting. One sensor (WBU30016) placed close to the canister in block R5 was indicating a drying of the bentonite until it failed.

Sixteen sensors are at present out of order.

## **5.3.3 Pore water pressure**

### **Geokon (App. 2\page 133)**

All sensors yield very low pressure except for one sensor below the heater that yields a sudden increase to 220 kPa after 1 year.

### **Kulite (App. 2\page 134)**

UBU30004 yields a pressure of 440 kPa and this sensor is placed near the rock surface at the bottom of the deposition hole. The rest of the sensors yield very low pressures.

#### **5.3.4 Temperature in the buffer (App. 2\pages 135-141 and 144)**

The measured temperature ranges from 38 °C (in the periphery of the upper bentonite cylinder C4) to a temperature of 83.2 °C in the center close to the canister. These measurements are from the period just before the power to the canisters were switched off. The highest temperature gradient is 0.59 °C/cm (block R5). There have appeared some problems with some data scan units, which explains the noise in some curves.

30 sensors are out of order.

The temperature in the buffer is also measured with the Geokon sensors (from day 1350). The maximum temperature recorded at the end of this measuring period with these sensors is about 78 °C (PBU30002 placed in the center of block C1 close to the canister and UBU30009 placed in block R5 in the inner slot).

#### **5.3.5 Canister power (App. 2\page 145)**

The power of the canister in hole 3 was kept constant at 1800 W from the start 011011 until 020917, when the power was decreased with about 20 W. The power has been stepwise decreased according to Table 5-1. During the period between December 6 and December 15 the power of all canisters was switched off. After that period the power was adjusted to about 1710 W. At the beginning of December 2005 the power was decreased with 30 W to about 1680 W. The latest reduction of the power with about 30 W was done at the end of year 2006.

#### **5.3.6 Temperature on the canister surface (App. 2\pages 146-147)**

The first diagram shows the maximum temperature plotted as a function of time. The maximum measured temperature on the canister surface was about 100 °C just before the power to the canisters was switched off. The temperature recovered, but only to about 93 °C after the power was switched on again and after that a slightly decrease in temperature was measured until the sensor stopped functioning at the end of August 2005. The second diagram shows the distribution of the temperature along the cables. See also chapter 5.2.6.

### **5.4 Deposition hole 2**

#### **5.4.1 Canister power (App. 3\page 152)**

The power of the canister in hole 2 was kept constant at 1800 W from the start 010924 until 020917, when the power was decreased with about 20 W. After two years (September 2003) the power was decreased with about 40 W to 1740 W. The interruption in the curve between days 409 and 456 is caused by data collection problems. At the beginning of September 2004 the power was decreased with about 40 W to 1710 W. Since permanent damages on the heaters in the canister were observed on December 1 2004 the power to this canister has been switched off and not been restarted.



## **5.4.2 Temperature on the canister surface (App. 3\pages 153-155)**

See chapter 5.2.6. The maximum measured temperature on the canister surface was just before the power was switched off about 96 °C. The reason for the unexpected increase in temperature after 450 days is the difficulties with the measurement of the power (see chapter 5.2.5). The actual power at that time was probably higher than 1800 W. After the power was switched off the temperature on the canister surface was stabilized on about 30 °C. The sensor stopped giving reliable data at the beginning of June 2005.

## **5.5 Deposition hole 4**

### **5.5.1 Canister power (App. 3\page 157)**

The power of the canister in hole was kept constant at 1800 W from the start 011011 until 020917, when the power was decreased with about 20 W. Some initial problems have been overcome. The power has been stepwise decreased according to Table 5-1. During the period between December 6 and December 15 the power of all canisters was switched off. After that period the power was adjusted to about 1710 W. At the beginning of December 2005 the power was decreased with 30 W to about 1680 W. The latest reduction of the power with about 30 W was done at the end of year 2006.

### **5.5.2 Temperature on the canister surface (App. 3\pages 158-159)**

The maximum measured temperature on the canister surface after the power was switched on again was 88 °C. The sensor stopped giving reliable data at the beginning of April 2005.

## **5.6 Backfill in Section1**

### **5.6.1 Total pressure in the backfill**

#### **Geokon (App. 4\pages 163-164)**

All these sensors yielded high increase in total pressure in connection with closing of the tunnel drainage. The maximum measured pressure was about 2.5 MPa. After the opening of the drainage the total pressure was stabilized on the same level as before the closing of the drainage (maximum pressure about 0.2 MPa). At around the 20<sup>th</sup> of April 2006, a packer placed in a borehole in Section I of the tunnel started to leak resulting in an increase of water drained out from the inner section from about 1.5 l/min to about 9 l/min. The damaged packer caused also an increase in the measured total pressure of about 300 kPa (around day 1660). At the beginning of April 2007 some of the sensors are indicating an increase in the measured pressure. The change in the measured pressures is probably related to the work with the excavation of a new tunnel near by the Prototype-tunnel which was initialized at that time. The measured pressure is continuing to vary due to the work with the new tunnel and the maximum measured pressure at the end of this measuring period is about 700 kPa.

One sensor is out of order.

### **Kulite (App.4 \pages 165-166)**

These measurements yielded rather small increase in total pressure until the drainage of the tunnel was closed. The maximum pressure recorded with PBA10013 was about 500 kPa. The sensor stopped functioning during a period of about 100 day after the rapid increase in pressure when the tunnel drainage was closed. Sensor PBA10013 is placed 1.7 m above the bentonite surface in hole 3.

All sensors are out of order.

### **5.6.2 Suction in the backfill (App. 4\pages 167-173)**

The suction in the backfill is measured with Wescor psychrometers. The steady but slow wetting (decrease in suction) observed in about 50% of the sensors continues. 7 sensors close to the roof and walls of the tunnel and one sensor just above the buffer in hole 1 indicate fast wetting that has gone close to water saturation (less than 1000 kPa suction). Also the sensor placed just inside the plug has reached a suction value that indicates saturation. In connection with the closing of the drainage, a very rapid decrease in suction was recorded by the installed psychrometers. Six of these sensors placed in the central part of the tunnel section yielded an increase in suction, after the reopening of the drainage, to the same level as before the closing. Seven of the sensors measured a decrease in suction after the packer was damaged. Three of the still working sensors (WBA10005, WBA10006 and WBA10007) placed above deposition hole 1 have measured a decreasing suction when the work with the new tunnel started.

Many of these sensors have stopped giving reliable values due to high water saturation of the backfill.

### **5.6.3 Pore water pressure in the backfill**

#### **Geokon (App. 4\pages 174-175)**

All these sensors yielded high increase in pore pressure when the drainage of the tunnel was closed. Many of the sensors recorded pressures up to 2.5 MPa. After the opening of the drainage the pore pressure was stabilized at low pressures (below 0.1 MPa). Also these sensors reacted when the packer was broken by measuring an increase in pore pressure of about 200 kPa. At the beginning of April 2007 some of the sensors are indicating an increase in the measured pressure. The change in the measure pressures is probably related to the work with the excavation of a new tunnel near by the Prototype-tunnel which was initialized at that time. At the end of this measuring period is the maximum pressure recorded with the sensors about 600 kPa.

#### **Kulite (App. 4\pages 176-177)**

These sensors are also recorded very high water pressure after the closing of the drainage. The still functioning sensors measured an increase in pore pressure of about 200 kPa at the time when the packer installed in the rock was broken. The sensors reacted also when the excavation of the nearby tunnel was initialized and the maximum measured pressure at the end of this measuring period is about 900 kPa. Eight sensors are out of order.

#### **5.6.4 Temperature in the backfill (App. 4\pages 178-182)**

The temperature in the backfill ranges from 17 to 35 degrees. The highest temperature is measured above the buffer in hole 3 just before the heaters were turned off at the end of 2004. These sensors reacted also when the packer was broken (a decrease in temperature).

### **5.7 Temperature in the rock**

#### **5.7.1 Near hole 1 (App. 1\pages 111-113)**

The maximum temperature measured in the rock is 38.6 °C. This temperature was measured with the thermocouple TROA1030 located 2.038 m from the center of the canister in deposition hole 1. The temperature in the rock close to the deposition hole decreased when the power to the canisters was switched off but increased again when the power was switched on to a temperature about 1 °C lower than before the power was switched off.

#### **5.7.2 Near hole 2 (App. 3\page 151)**

The maximum temperature in the rock (46.8 °C) was measured by TROA1820 located 2.490 m from the center of the canister in deposition hole 2 just before the power to the canisters was switched off. Since no power is applied to this canister anymore the temperature in the rock around the deposition hole is continuing to decrease.

#### **5.7.3 Near hole 3 (App. 2\pages 142-143)**

The maximum temperature in the rock (48.8 °C) was measured by TROA2120 located 1.967 m from the center of the canister in deposition hole 3 just before the power to the canisters was switched off. Although the power was switched on again the temperature around the deposition hole is continuing to drop. This is most obvious for the sensors installed in the direction towards deposition hole 2.

#### **5.7.4 Near hole 4 (App. 3\page 156)**

The maximum temperature in the rock (46.5 degrees) is measured by TROA3030 located 2.034 m from the center of the canister in deposition hole 4. Also for this deposition hole there was a drop in the temperature in the rock when the power was switched off. After the power was switched on again the temperature in the rock increased to almost the same level as before the power was switched off. Over the last 2 years the measured temperatures have been constant.

### **5.8 Analyze of data from Section 1**

#### **5.8.1 Deposition hole 1**

Before the drainage of the tunnel was closed and the power of the canister was switched off the saturation of the buffer at mid height of the canister in block R5 was considered (indicated both by the relative humidity sensors and total pressure sensors) to be high

even close to the canister (PBU10015). Also installed pore pressure sensors placed in block R5 (e.g. UBU 10007) are measuring high pressures close to the canister which also is indicating that the bentonite is saturated. This was not changed when the drainage was opened and power of the canister was switched on again. The degree of saturation in the solid blocks both under (Block C1) and above the canister (Blocks C2-C4) is much lower. However the degree of saturation interpreted from measurements of relative humidity, swelling pressure and pore pressure is increasing with time. This trend is continuing with the same rate after the drainage was opened and the power was switched on.

In Figure 5-1 the temperature in the buffer is plotted as function of the radius from the center of the deposition hole. The measurements are made with different type of sensors in block R5 (at mid height of the canister). A straight line is fitted to the measured values. The temperature gradient is determined from the fitted line in the figure. This gradient together with the temperature on the canister surface and the temperature in the buffer close to the outer radius of the ring shaped block ( $r = 785 \text{ mm}$ ) are plotted as function of time in Figure 5-3. The shaded part of the plot represents the time when the power to the canister was switched off at the beginning of December 2004. The plot shows that the temperature after this is somewhat lower than before, probably due to the fact that no power is applied to canister 2 after December 2 2004. However the temperature gradient over the buffer is similar before and after the switch on/off the power of the canisters. The determination of the gradient was made up to the beginning of December 2005. After that the number of still working sensors are too few, to be able to determine the temperature gradient.

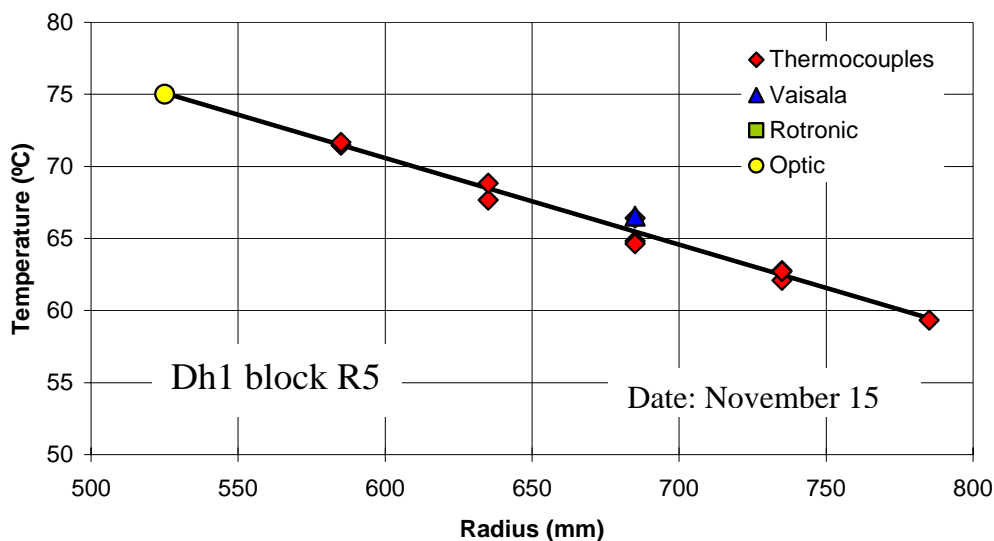

**Figure 5-1.** The temperature in block R5 in Dh 1 as function of radius from the center of the deposition hole on November 15, 2004.

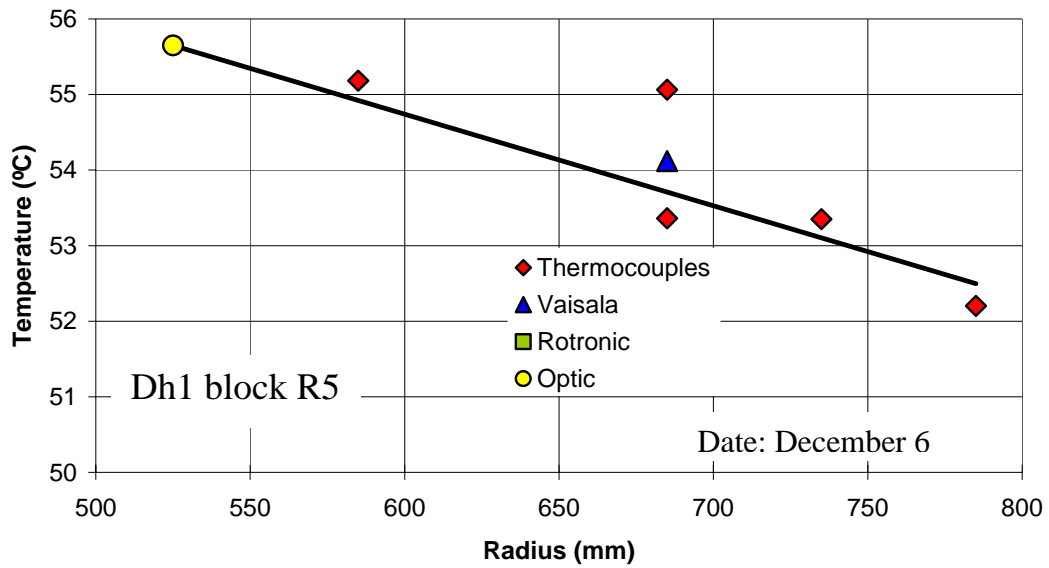

**Figure 5-2.** The temperature in block R5 in Dh 1 as function of radius from the center of the deposition hole on December 6, 2004.

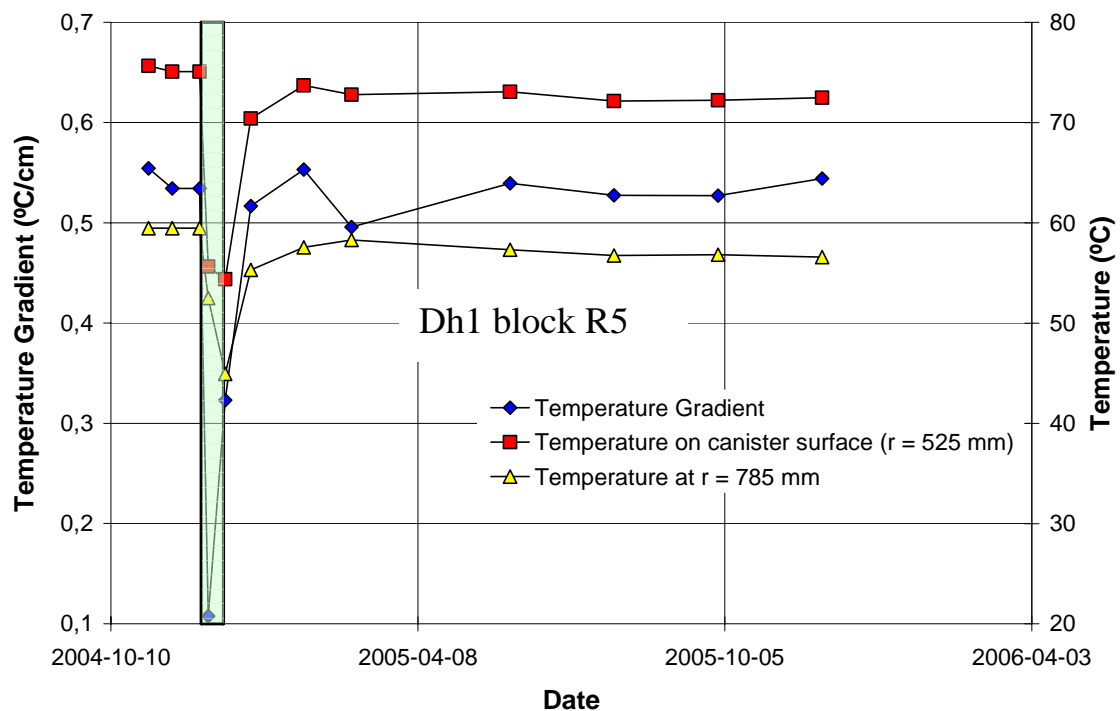

**Figure 5-3.** The temperature and temperature gradient plotted as function the date in deposition hole 1 block R5.

### 5.8.2 Deposition hole 3

The saturation of the buffer, as an average, indicated by both RH-transducers and total pressure transducers was before the closing of the drainage much lower compared to the buffer in deposition hole 1, although some total pressure transducers placed above and under the canister indicated rather high total pressures. When the drainage was closed those total pressure transducers which before had indicated high total pressure reacted with a rapid increase in pressure while the rest of the transducers did not react at all. When the drainage was opened again and the power to the canisters was switched off there was a decrease in the pressure. For most of the transducers the pressure went down to the same level as before the closing of the drainage. One RH sensor placed in block R5 at a radius of 785 mm reacted with a significant increase in RH (from 70% to 82%) when the drainage was closed. The RH was maintained on the higher level even after the opening of the drainage. Also some transducers placed in the buffer but close the canister top reacted with an increase in RH of about 5%. These transducers had before the closing of the drainage indicated a drying of the buffer. The rest of the RH transducers reacted very little at the closing/opening of the drainage. The buffer is today far from saturated (indicated both by RH-sensors total pressure sensors and pore pressure sensors).

In Figure 5-4 the temperature in deposition hole 3 is plotted as function of the radial distance from the center of the deposition hole. Compared the corresponding plot for deposition hole 1 this plot shows a significant drop in temperature between the surface of the canister and the buffer (inner diameter of the ring). This indicates that the initial slot (of about 10 mm) between the canister and the buffer was still open.

The temperature gradient over the inner slot together with the temperature on the canister and the temperature on the inner radius of the ring shaped block are plotted as function of time in Figure 5-5. The shaded part of the plot represents the time when the power to canisters was switched off. Immediately after the power was switched off the temperature gradient increased which indicate that the slot was isolating the canister resulting in a much faster drop in temperature of the buffer than the canister surface. When the power was switched on again the temperature gradient over the slot reached the same level as before the closing of the drainage indicating an open slot between the canister and the buffer. The figure also shows that the gradient is decreasing with time which might be an indication that the gap is getting smaller. The sensors for measuring the temperature on the canister surface stopped functioning of August 2005. The temperature gradient over the inner slot could not be calculated after that date.

The temperature gradient over the buffer is plotted in Figure 5-6 together with the temperature on the inner surface of the block and the temperature at the radius of  $r = 785$  mm. After the power was switched on again also this gradient stabilized on the same level as before the power was switched off.

A conclusion of the analyses is that even though the pressure in the backfill and in the surrounding rock was high (more than 2 MPa) when the drainage was closed, water did not enter the inner slot between the buffer and the canister. The fact that no water pressure acted directly on the canister surface can also explain the large vertical displacement of the canister measured when the drainage was closed (see Figure 5-7). If the increased pore pressure (2.5 MPa) would act directly on the canister surface the deformation should be much smaller than what was measured. The measured deformation was probably caused by large deformations of the solid bentonite block below the canister.

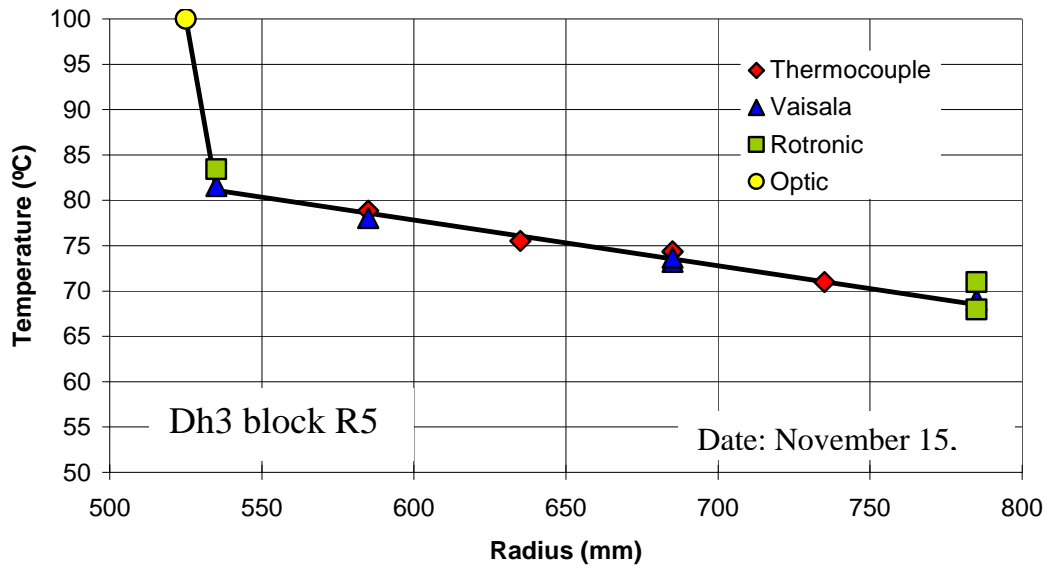

*Figure 5-4. The temperature in block R5 in Dh 3 as function of radius from the center of the deposition hole on November 15, 2004.*

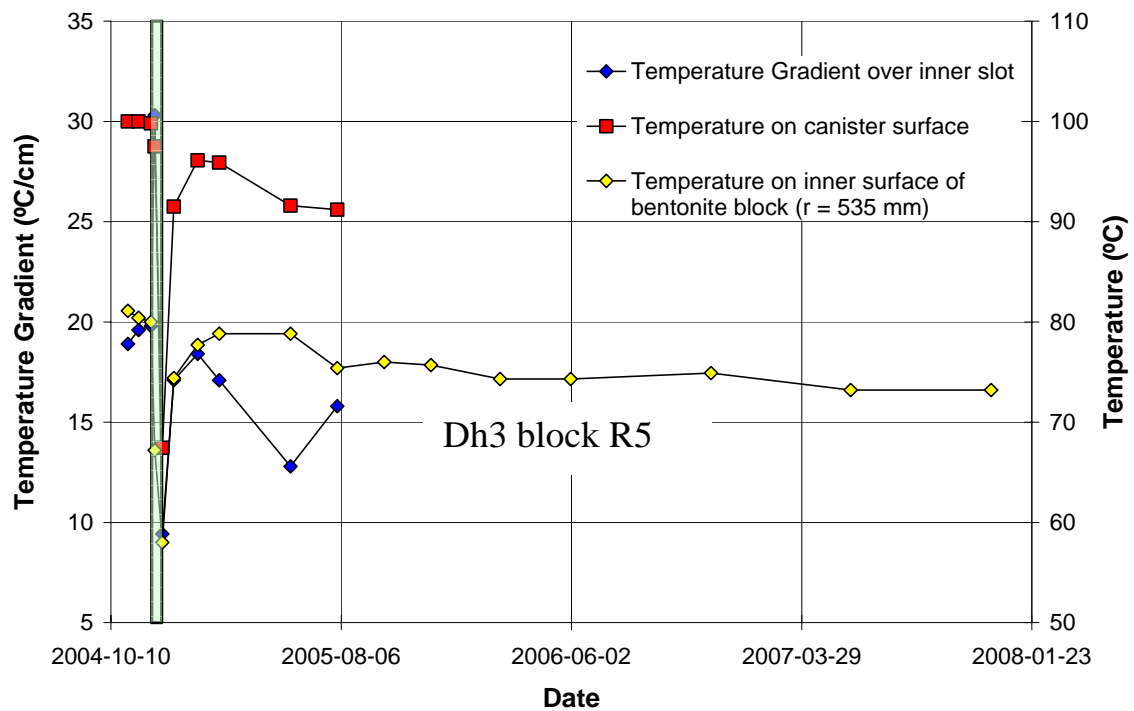

*Figure 5-5. The temperature and temperature gradient over the inner slot plotted as function the date in deposition hole 3 block R5.*

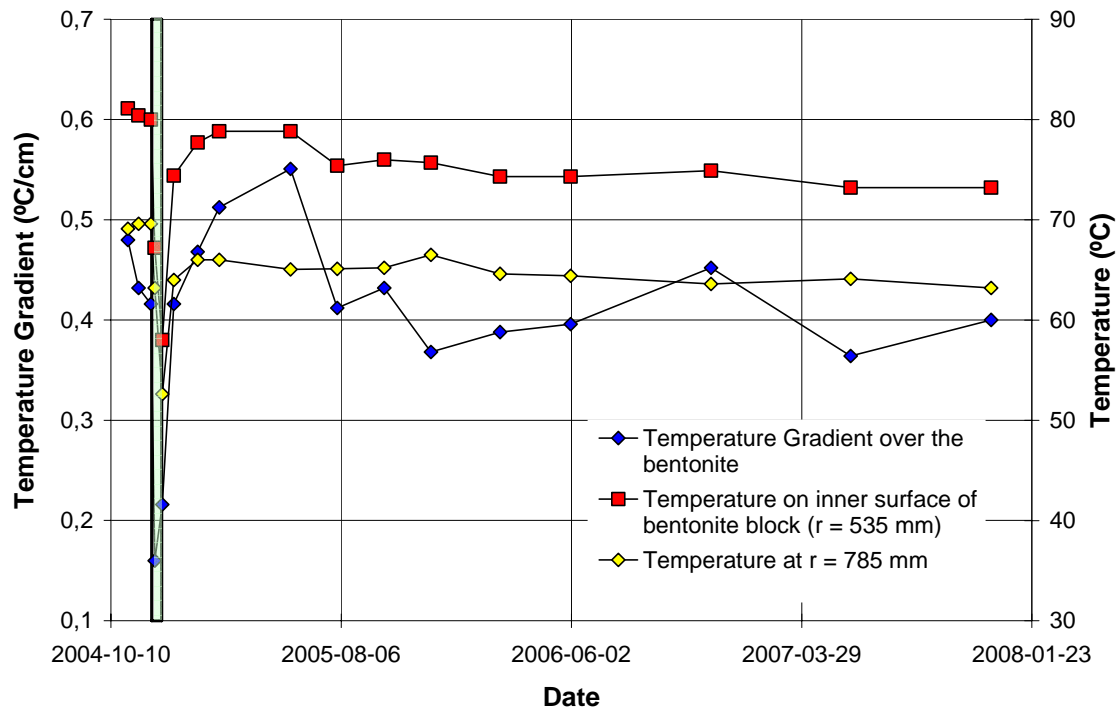

*Figure 5-6. The temperature and temperature gradient over the buffer plotted as function the date in deposition hole 3 block R5.*

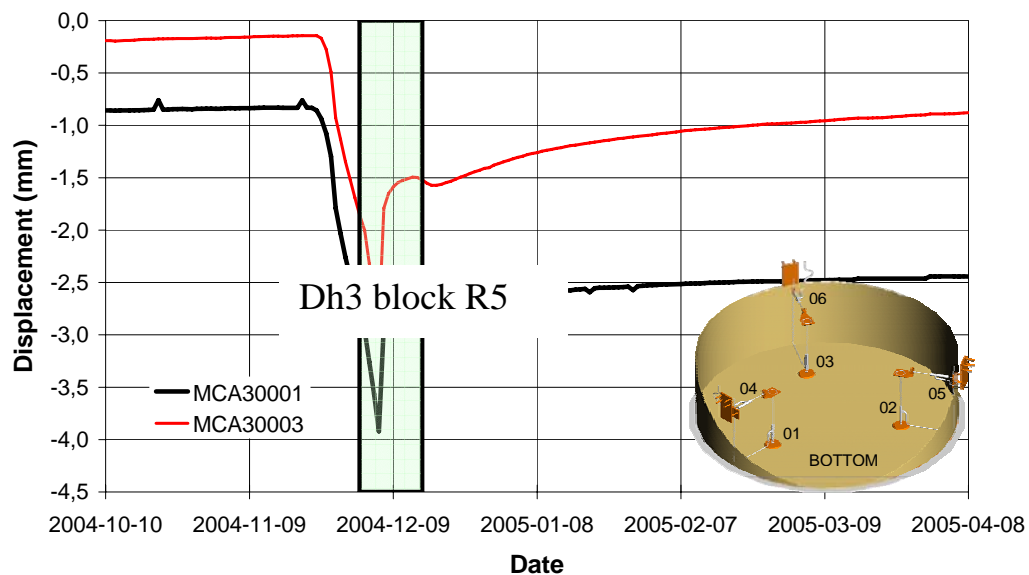

*Figure 5-7. Vertical displacement of the canister in Dh 3. Negative sign on the displacement means that the canister is moving downwards.*



### 5.8.3 Backfill

The pore pressure in the backfill increased fast from a low level when the drainage of the tunnel was closed. This affected the rate in which the backfill was saturated measured both with soil psychrometers and with resistivity measurements made by GRS. After the drainage was reopened the pore pressure stabilized on the same level as before it was closed. The saturation rate (measured with both psychrometers and resistivity measurements) decreased to the same rate as before the closing of the drainage.

When a packer placed in a borehole in Section I was broken (at the middle of April 2006) the pressure in the backfill (both total pressure and pore pressure) increased with about 300 kPa. The increase in pressure affected also the measured suction values (measured with soil psychrometers). Eight of the sensors measured a decrease in suction of about 500 kPa due to the broken packer.

An increase of the total pressure and the pore pressure can also be observed around day 2040 (corresponding to the date 2007-04-19). The increase in pressure is probably related to the work with the excavation of a new tunnel nearby the Prototype-tunnel which was initialized at that time.

The outflow from the inner section of the Prototype tunnel as function of time is shown in Figure 5-8. The figure is showing that the outflow from Section I increased from about 1,8 l/min to about 9 l/min when the installed packer was broken. The large scatter in the outflow from the beginning of summer 2007 to the end of this measuring period is probably caused by the work with the new tunnel placed close to the Prototype Repository.

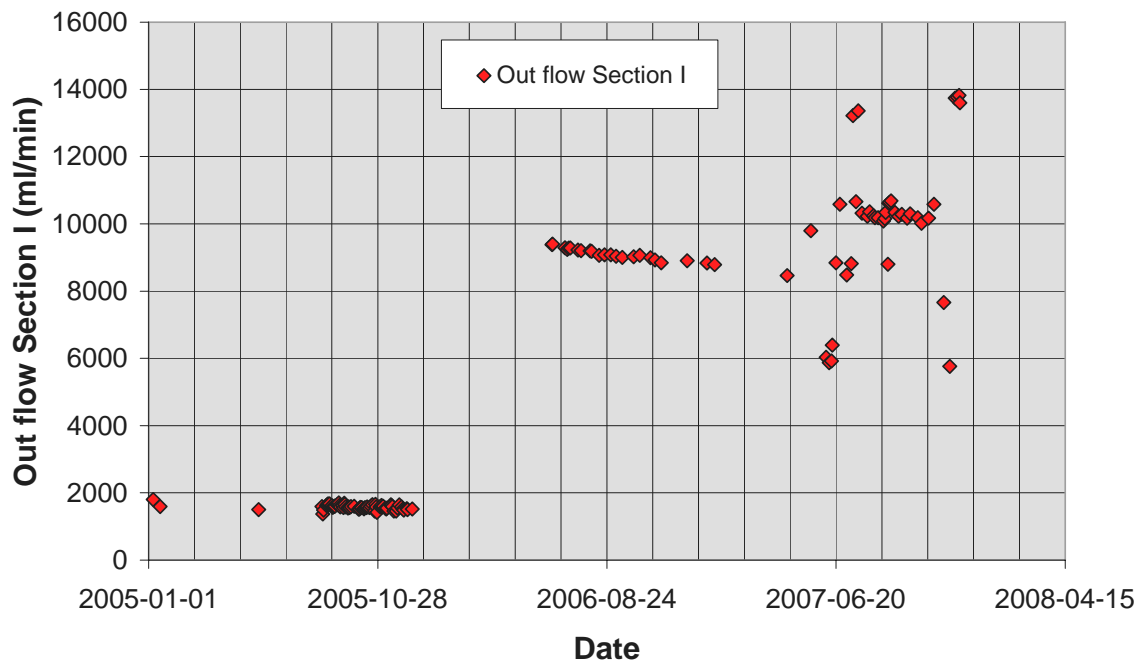

*Figure 5-8. The measured outflow from the inner section of the tunnel for Prototype Repository.*



## **6 Location of instruments in Section 2**

### **6.1 Strategy for describing the position of each device in the bentonite and rock in and around the deposition holes**

The deposition holes in Section 2 are termed DA3551G01 and DA3545G01, hole number 5 and 6 respectively according to Figure 1-1.

Deposition hole 5 has been instrumented in the same way as the two inner deposition holes, 1 and 3 i.e. measurements have been done in four vertical sections A, B, C and D according to Figure 4-1. (See chapter 4-1)

Deposition hole 6 has, however, been instrumented according to another strategy. The instruments have been placed in eight directions, where four directions are represented in each instrumented block, see Figure 6-1.

Direction A and C are placed in the tunnels axial direction with A headed against the end of the tunnel i.e. almost to the West, see Figure 2-1.

Every instrument placed in the buffer is named with a unique name consisting of 1 letter describing the type of measurement, 1 letter describing where the measurement takes place (buffer, rock), 1 figure denoting the deposition hole (5-6) and 2 figures specifying the instrument according to separate lists (see Table 6-1 to 6-11). Every instrument position is then described with three coordinates according to Figure 2-1.

The bentonite blocks are called cylinders and rings. The cylinders are numbered C1-C4 and the rings R1-R10 respectively, see Figure 4-1.

Thermocouples in the rock are placed on 3 levels in each deposition hole (bottom, 3 m and 6 m level). Thermocouples are placed in the bottom of the deposition holes in a vertical hole at the center of the deposition hole. On level 3 m and 6 m the thermocouples are placed in two vertical directions perpendicular to each other.

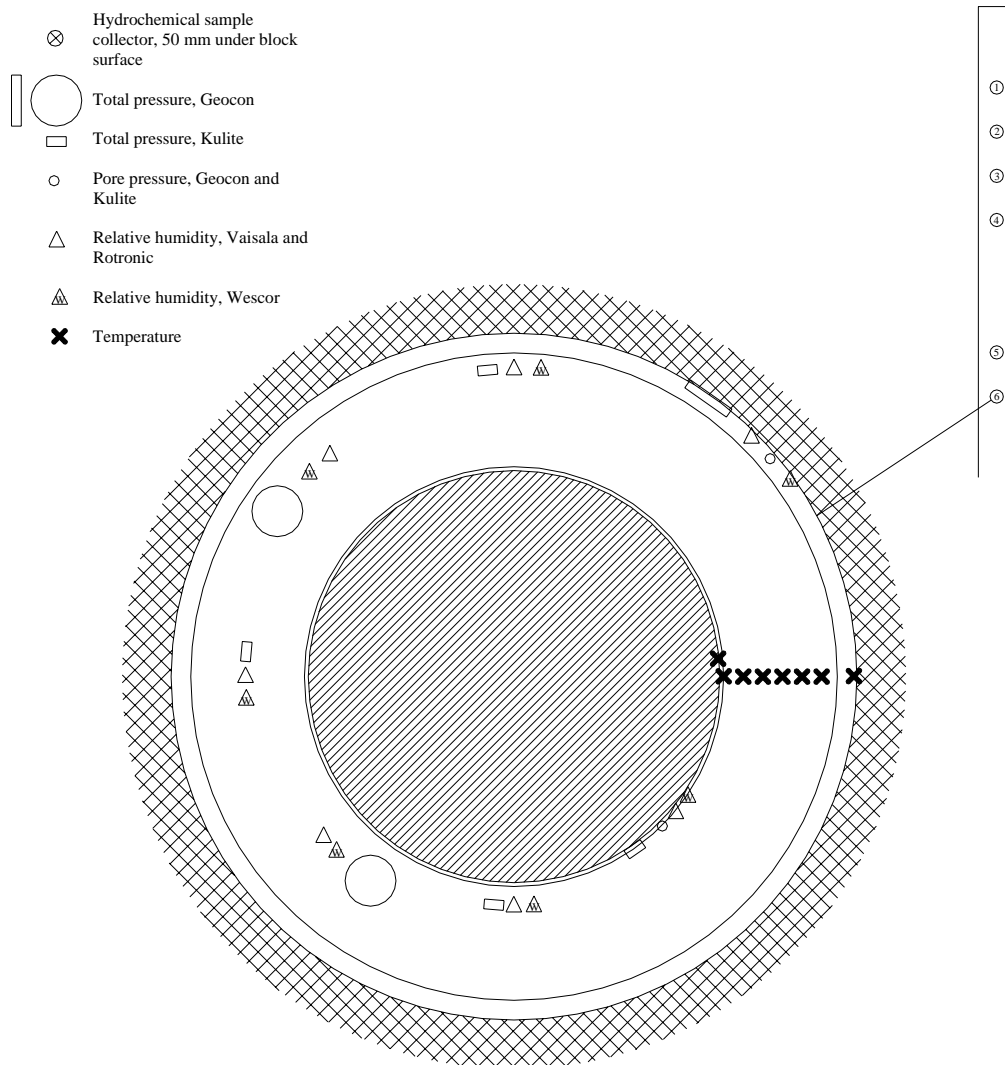

**Figure 6-1.** Schematic view over the instruments positions in deposition hole 6. The instruments are placed in eight vertical sections, where four sections are represented in each instrumented block.

## 6.2 Position of each instrument in the bentonite in hole 5 (DA3551G01)

The instruments are located according to the same system as those in hole 1 and hole 3.

The positions of each instrument are described in Tables 6-1 to 6-4. These tables have been updated since the last data report (Sensors data report No 7).

The positions of 10 Wescor psychrometer sensors were determined after inflow measurement on the wall of the deposition hole. The position of these sensors are described in Table 6-5

**Table 6-1. Numbering and position of instruments for measuring temperature (T) in the buffer in hole 5.**

| Typ and number | Block   | Instrument position in block |                    |        |        | Fabricate | Remark      |
|----------------|---------|------------------------------|--------------------|--------|--------|-----------|-------------|
|                |         | Direction                    | $\alpha$<br>degree | r<br>m | Z<br>m |           |             |
| TB501          | Cyl. 1  | Center                       | 270                | 0,050  | 0,080  | Pentronic |             |
| TB502          | Cyl. 1  | Center                       | 270                | 0,060  | 0,250  | Pentronic |             |
| TB503          | Cyl. 1  | Center                       | 270                | 0,070  | 0,450  | Pentronic |             |
| TB504          | Cyl. 1  | A                            | 355                | 0,525  | 0,450  | Pentronic | On canister |
| TB505          | Cyl. 1  | A                            | 355                | 0,685  | 0,450  | Pentronic |             |
| TB506          | Cyl. 1  | B                            | 85                 | 0,685  | 0,450  | Pentronic |             |
| TB507          | Cyl. 1  | C                            | 175                | 0,685  | 0,450  | Pentronic |             |
| TB508          | Cyl. 1  | D                            | 270                | 0,585  | 0,450  | Pentronic |             |
| TB509          | Cyl. 1  | D                            | 270                | 0,685  | 0,450  | Pentronic |             |
| TB510          | Cyl. 1  | D                            | 270                | 0,785  | 0,450  | Pentronic |             |
| TB511          | Ring 5  | A                            | 0                  | 0,525  | 2,950  | Pentronic | On canister |
| TB512          | Ring 5  | A                            | 0                  | 0,685  | 2,986  | Pentronic |             |
| TB513          | Ring 5  | B                            | 85                 | 0,585  | 2,986  | Pentronic |             |
| TB514          | Ring 5  | B                            | 85                 | 0,685  | 2,986  | Pentronic |             |
| TB515          | Ring 5  | B                            | 85                 | 0,785  | 2,986  | Pentronic |             |
| TB516          | Ring 5  | C                            | 175                | 0,585  | 2,986  | Pentronic |             |
| TB517          | Ring 5  | C                            | 175                | 0,685  | 2,986  | Pentronic |             |
| TB518          | Ring 5  | C                            | 175                | 0,735  | 2,986  | Pentronic |             |
| TB519          | Ring 5  | D                            | 270                | 0,585  | 2,986  | Pentronic |             |
| TB520          | Ring 5  | D                            | 270                | 0,635  | 2,986  | Pentronic |             |
| TB521          | Ring 5  | D                            | 270                | 0,685  | 2,986  | Pentronic |             |
| TB522          | Ring 5  | D                            | 270                | 0,735  | 2,986  | Pentronic |             |
| TB523          | Ring 5  | D                            | 270                | 0,785  | 2,986  | Pentronic |             |
| TB524          | Ring 10 | A                            | 0                  | 0,525  | 5,150  | Pentronic | On canister |
| TB525          | Ring 10 | A                            | 0                  | 0,685  | 5,543  | Pentronic |             |
| TB526          | Ring 10 | D                            | 270                | 0,585  | 5,543  | Pentronic |             |
| TB527          | Ring 10 | D                            | 270                | 0,685  | 5,543  | Pentronic |             |
| TB528          | Ring 10 | D                            | 270                | 0,785  | 5,543  | Pentronic |             |
| TB529          | Cyl. 3  | A                            | 0                  | 0,785  | 6,353  | Pentronic |             |
| TB530          | Cyl. 3  | B                            | 95                 | 0,585  | 6,353  | Pentronic |             |
| TB531          | Cyl. 3  | C                            | 185                | 0,585  | 6,353  | Pentronic |             |
| TB532          | Cyl. 4  | A                            | 0                  | 0,785  | 7,060  | Pentronic |             |

**Table 6-2. Numbering and position of instruments for measuring total pressure (P) in the buffer in hole 5.**

| Typ and number | Block   | Instrument position in block |                    |        |        | Fabricate | Remark      |
|----------------|---------|------------------------------|--------------------|--------|--------|-----------|-------------|
|                |         | Direction                    | $\alpha$<br>degree | r<br>m | Z<br>m |           |             |
| PB501          | Cyl. 1  | Center                       | 0                  | 0,000  | 0,000  | Geokon    | Bottom      |
| PB502          | Cyl. 1  | Center                       | 0                  | 0,100  | 0,500  | Geokon    |             |
| PB503          | Cyl. 1  | A                            | 5                  | 0,585  | 0,340  | Kulite    | Vertical    |
| PB504          | Cyl. 1  | A                            | 5                  | 0,685  | 0,340  | Kulite    | Vertical    |
| PB505          | Cyl. 1  | A                            | 5                  | 0,785  | 0,340  | Kulite    | Vertical    |
| PB506          | Cyl. 1  | B                            | 95                 | 0,635  | 0,500  | Geokon    |             |
| PB507          | Cyl. 1  | B                            | 105                | 0,735  | 0,500  | Geokon    |             |
| PB508          | Cyl. 1  | C                            | 185                | 0,635  | 0,500  | Geokon    |             |
| PB509          | Cyl. 1  | C                            | 195                | 0,735  | 0,500  | Geokon    |             |
| PB510          | Ring 5  | A                            | 10                 | 0,535  | 2,876  | Kulite    | In the slot |
| PB511          | Ring 5  | A                            | 10                 | 0,685  | 3,036  | Geokon    |             |
| PB512          | Ring 5  | A                            | 5                  | 0,825  | 2,876  | Kulite    | In the slot |
| PB513          | Ring 5  | B                            | 95                 | 0,635  | 3,036  | Geokon    |             |
| PB514          | Ring 5  | B                            | 105                | 0,785  | 3,036  | Geokon    |             |
| PB515          | Ring 5  | C                            | 190                | 0,635  | 3,036  | Geokon    |             |
| PB516          | Ring 5  | C                            | 190                | 0,825  | 2,876  | Kulite    | In the slot |
| PB517          | Ring 10 | Center                       | 0                  | 0,050  | 5,593  | Geokon    |             |
| PB518          | Ring 10 | A                            | 10                 | 0,585  | 5,433  | Kulite    | Vertical    |
| PB519          | Ring 10 | A                            | 10                 | 0,685  | 5,433  | Kulite    | Vertical    |
| PB520          | Ring 10 | A                            | 10                 | 0,785  | 5,433  | Kulite    | Vertical    |
| PB521          | Ring 10 | B                            | 95                 | 0,635  | 5,593  | Geokon    |             |
| PB522          | Ring 10 | B                            | 105                | 0,735  | 5,593  | Geokon    |             |
| PB523          | Ring 10 | C                            | 180                | 0,635  | 5,593  | Geokon    |             |
| PB524          | Ring 10 | C                            | 190                | 0,735  | 5,593  | Geokon    |             |
| PB525          | Cyl. 3  | Center                       | 0                  | 0,100  | 6,603  | Geokon    |             |
| PB526          | Cyl. 3  | A                            | 5                  | 0,585  | 6,603  | Geokon    |             |
| PB527          | Cyl. 4  | Center                       | 0                  | 0,100  | 7,110  | Geokon    |             |

**Table 6-3. Numbering and position of instruments for measuring pore water pressure (U) in the buffer in hole 5.**

| Typ and number | Block   | Instrument position in block |                    |        |        | Fabricate | Remark        |
|----------------|---------|------------------------------|--------------------|--------|--------|-----------|---------------|
|                |         | Direction                    | $\alpha$<br>degree | r<br>m | Z<br>m |           |               |
| UB501          | Cyl. 1  | Center                       | 90                 | 0,050  | 0,250  | Kulite    |               |
| UB502          | Cyl. 1  | Center                       | 90                 | 0,100  | 0,050  | Geokon    |               |
| UB503          | Cyl. 1  | A                            | 355                | 0,585  | 0,250  | Geokon    |               |
| UB504          | Cyl. 1  | A                            | 355                | 0,785  | 0,340  | Kulite    |               |
| UB505          | Ring 5  | A                            | 355                | 0,585  | 2,786  | Geokon    |               |
| UB506          | Ring 5  | A                            | 355                | 0,785  | 2,876  | Kulite    |               |
| UB507          | Ring 5  | B                            | 85                 | 0,535  | 2,876  | Kulite    | In the slot   |
| UB508          | Ring 5  | B                            |                    |        |        |           | Not installed |
| UB509          | Ring 5  | C                            | 175                | 0,535  | 2,786  | Geokon    | In the slot   |
| UB510          | Ring 5  | C                            | 175                | 0,825  | 2,786  | Geokon    | In the slot   |
| UB511          | Ring 10 | A                            | 355                | 0,585  | 5,433  | Kulite    |               |
| UB512          | Ring 10 | A                            | 355                | 0,785  | 5,433  | Kulite    |               |
| UB513          | Cyl. 3  | Center                       |                    |        |        |           | Not installed |
| UB514          | Cyl. 4  | Center                       | 90                 | 0,100  | 6,860  | Geokon    |               |

**Table 6-4. Numbering and position of instruments for measuring water content (W) in the buffer in hole 5.**

| Mark  | Block   | Instrument position in block |          |       | Fabricate | Remark   |             |
|-------|---------|------------------------------|----------|-------|-----------|----------|-------------|
|       |         | Direction                    | $\alpha$ | r     |           |          | Z           |
|       |         |                              | degree   | m     | m         |          |             |
| WB501 | Cyl. 1  | Center                       | 180      | 0,050 | 0,250     | Rotronic |             |
| WB502 | Cyl. 1  | Center                       | 180      | 0,100 | 0,050     | Rotronic |             |
| WB503 | Cyl. 1  | Center                       | 0        | 0,400 | 0,250     | Rotronic |             |
| WB504 | Cyl. 1  | A                            | 350      | 0,585 | 0,340     | Vaisala  |             |
| WB505 | Cyl. 1  | A                            | 350      | 0,685 | 0,340     | Vaisala  |             |
| WB506 | Cyl. 1  | A                            | 350      | 0,785 | 0,340     | Vaisala  |             |
| WB507 | Cyl. 1  | B                            | 80       | 0,585 | 0,340     | Vaisala  |             |
| WB508 | Cyl. 1  | B                            | 80       | 0,685 | 0,250     | Rotronic |             |
| WB509 | Cyl. 1  | B                            | 80       | 0,785 | 0,250     | Rotronic |             |
| WB510 | Cyl. 1  | C                            | 170      | 0,585 | 0,250     | Rotronic |             |
| WB511 | Cyl. 1  | C                            | 170      | 0,685 | 0,250     | Rotronic |             |
| WB512 | Cyl. 1  | C                            | 170      | 0,785 | 0,250     | Rotronic |             |
| WB513 | Ring 5  | A                            | 350      | 0,585 | 2,876     | Vaisala  |             |
| WB514 | Ring 5  | A                            | 350      | 0,685 | 2,876     | Vaisala  |             |
| WB515 | Ring 5  | A                            | 350      | 0,785 | 2,876     | Vaisala  |             |
| WB516 | Ring 5  | B                            | 80       | 0,535 | 2,786     | Rotronic | In the slot |
| WB517 | Ring 5  | B                            | 80       | 0,685 | 2,786     | Rotronic |             |
| WB518 | Ring 5  | B                            | 80       | 0,785 | 2,786     | Rotronic |             |
| WB519 | Ring 5  | C                            | 180      | 0,535 | 2,876     | Vaisala  | In the slot |
| WB520 | Ring 5  | C                            | 180      | 0,685 | 2,876     | Vaisala  |             |
| WB521 | Ring 5  | C                            | 180      | 0,785 | 2,786     | Rotronic |             |
| WB522 | Ring 10 | Center                       | 180      | 0,050 | 5,433     | Vaisala  |             |
| WB523 | Ring 10 | A                            | 0        | 0,262 | 5,433     | Vaisala  |             |
| WB524 | Ring 10 | A                            | 350      | 0,585 | 5,433     | Vaisala  |             |
| WB525 | Ring 10 | A                            | 350      | 0,685 | 5,433     | Vaisala  |             |
| WB526 | Ring 10 | A                            | 350      | 0,785 | 5,433     | Vaisala  |             |
| WB527 | Ring 10 | B                            | 80       | 0,585 | 5,343     | Rotronic |             |
| WB528 | Ring 10 | B                            | 80       | 0,685 | 5,343     | Rotronic |             |
| WB529 | Ring 10 | B                            | 80       | 0,785 | 5,343     | Rotronic |             |
| WB530 | Ring 10 | C                            | 170      | 0,585 | 5,433     | Vaisala  |             |
| WB531 | Ring 10 | C                            | 170      | 0,785 | 5,343     | Rotronic |             |
| WB532 | Cyl. 3  | Center                       | 270      | 0,100 | 6,353     | Vaisala  |             |
| WB533 | Cyl. 3  | A                            | 350      | 0,585 | 6,353     | Vaisala  |             |
| WB534 | Cyl. 3  | B                            | 90       | 0,585 | 6,353     | Vaisala  |             |
| WB535 | Cyl. 3  | C                            | 180      | 0,585 | 6,353     | Rotronic |             |
| WB536 | Cyl. 4  | Center                       | 180      | 0,100 | 6,790     | Vaisala  |             |
| WB537 | Cyl. 4  | Center                       | 270      | 0,100 | 6,950     | Vaisala  |             |



**Table 6-5. Numbering and position of instruments for measuring water content (W) in the buffer in hole 5. The positions were determined after inflow measurements.**

| Mark  | Block  | Instrument position in block |          |       | Z     | Fabricate | Remark |
|-------|--------|------------------------------|----------|-------|-------|-----------|--------|
|       |        | Direction                    | $\alpha$ | r     |       |           |        |
|       |        |                              | degree   | m     | m     |           |        |
| WB538 | Ring 3 | C-D                          | 225      | 0,775 | 1,624 | Wescor    |        |
| WB539 | Ring 3 | C-D                          | 235      | 0,68  | 1,624 | Wescor    |        |
| WB540 | Ring 3 | C-D                          | 245      | 0,585 | 1,624 | Wescor    |        |
| WB541 | Ring 3 | C-D                          | 255      | 0,68  | 1,624 | Wescor    |        |
| WB542 | Ring 3 | C-D                          | 265      | 0,775 | 1,624 | Wescor    |        |
| WB543 | Ring 8 | C-D                          | 225      | 0,775 | 4,173 | Wescor    |        |
| WB544 | Ring 8 | C-D                          | 235      | 0,68  | 4,173 | Wescor    |        |
| WB545 | Ring 8 | C-D                          | 245      | 0,585 | 4,173 | Wescor    |        |
| WB546 | Ring 8 | C-D                          | 255      | 0,68  | 4,173 | Wescor    |        |
| WB547 | Ring 8 | C-D                          | 265      | 0,775 | 4,173 | Wescor    |        |

### **6.3 Position of each instrument in the bentonite in hole 6 (DA3545G01)**

The instruments are located in one main level in the blocks, 250 mm, from the upper surface. The upper blocks, C2, C3 and C4 are instrumented in the same way as those in deposition hole 5. The positions of each instrument are described in Tables 6-6 to 6-9. These tables have been updated since the last data report (Sensors data report No 7).

The position of 10 Wescor psychrometers and 5 Vaisala relative humidity sensors were determined after inflow measurement. The positions of these transducers are described in Table 6-10.

**Table 6-6. Numbering and position of instruments for measuring temperature (T) in the buffer in hole 6.**

| Typ and number | Block  | Instrument position in block |                    |        |        | Fabricate | Remark      |
|----------------|--------|------------------------------|--------------------|--------|--------|-----------|-------------|
|                |        | Direction                    | $\alpha$<br>degree | r<br>m | Z<br>m |           |             |
| TB601          | Cyl. 1 | Center                       | 45                 | 0,050  | 0,385  | Pentronic |             |
| TB602          | Cyl. 1 | Center                       | 315                | 0,050  | 0,260  | Pentronic |             |
| TB603          | Cyl. 1 | Center                       | 0                  | 0,050  | 0,135  | Pentronic |             |
| TB604          | Ring 1 | D                            | 270                | 0,535  | 0,770  | Pentronic |             |
| TB605          | Ring 1 | D                            | 270                | 0,585  | 0,770  | Pentronic |             |
| TB606          | Ring 1 | D                            | 270                | 0,635  | 0,770  | Pentronic |             |
| TB607          | Ring 1 | D                            | 270                | 0,685  | 0,770  | Pentronic |             |
| TB608          | Ring 1 | D                            | 270                | 0,735  | 0,770  | Pentronic |             |
| TB609          | Ring 1 | D                            | 270                | 0,785  | 0,770  | Pentronic |             |
| TB610          | Ring 1 | D                            | 270                | 0,825  | 0,753  | Pentronic | On rock     |
| TB611          | Ring 1 | D                            | 0                  | 0,525  | 0,753  | Pentronic | On canister |
| TB612          | Ring 5 | D                            | 270                | 0,535  | 2,795  | Pentronic |             |
| TB613          | Ring 5 | D                            | 270                | 0,585  | 2,795  | Pentronic |             |
| TB614          | Ring 5 | D                            | 270                | 0,635  | 2,795  | Pentronic |             |
| TB615          | Ring 5 | D                            | 270                | 0,685  | 2,795  | Pentronic |             |
| TB616          | Ring 5 | D                            | 270                | 0,735  | 2,795  | Pentronic |             |
| TB617          | Ring 5 | D                            | 270                | 0,785  | 2,795  | Pentronic |             |
| TB618          | Ring 5 | D                            | 270                | 0,825  | 2,753  | Pentronic | On rock     |
| TB619          | Ring 5 | D                            | 0                  | 0,525  | 2,753  | Pentronic | On canister |
| TB620          | Ring 8 | D                            | 270                | 0,535  | 4,324  | Pentronic |             |
| TB621          | Ring 8 | D                            | 270                | 0,585  | 4,324  | Pentronic |             |
| TB622          | Ring 8 | D                            | 270                | 0,635  | 4,324  | Pentronic |             |
| TB623          | Ring 8 | D                            | 270                | 0,685  | 4,324  | Pentronic |             |
| TB624          | Ring 8 | D                            | 270                | 0,735  | 4,324  | Pentronic |             |
| TB625          | Ring 8 | D                            | 270                | 0,785  | 4,324  | Pentronic |             |
| TB626          | Ring 8 | D                            | 270                | 0,825  | 4,253  | Pentronic | On rock     |
| TB627          | Ring 8 | D                            | 0                  | 0,525  | 4,253  | Pentronic | On canister |
| TB628          | Cyl. 3 | A                            | 0                  | 0,785  | 6,366  | Pentronic |             |
| TB629          | Cyl. 3 | B                            | 95                 | 0,585  | 6,366  | Pentronic |             |
| TB630          | Cyl. 3 | C                            | 185                | 0,585  | 6,366  | Pentronic |             |
| TB631          | Cyl. 4 | Center                       | 225                | 0,100  | 7,071  | Pentronic |             |
| TB632          | Cyl. 4 | A                            | 0                  | 0,785  | 7,071  | Pentronic |             |

**Table 6-7. Numbering and position of instruments for measuring total pressure (P) in the buffer in hole 6.**

| Typ and number | Block  | Instrument position in block |                    |        |        | Fabricate | Remark      |
|----------------|--------|------------------------------|--------------------|--------|--------|-----------|-------------|
|                |        | Direction                    | $\alpha$<br>degree | r<br>m | Z<br>m |           |             |
| PB601          | Cyl. 1 | Center                       | 315                | 0,210  | 0,510  | Geokon    |             |
| PB602          | Cyl. 1 | B                            | 80                 | 0,685  | 0,260  | Kulite    | Vertical    |
| PB603          | Ring 1 | A                            | 10                 | 0,785  | 0,770  | Kulite    | Vertical    |
| PB604          | Ring 1 | B                            | 80                 | 0,685  | 0,770  | Kulite    | Vertical    |
| PB605          | Ring 1 | C                            | 170                | 0,585  | 0,770  | Kulite    | Vertical    |
| PB606          | Ring 2 | AB                           | 55                 | 0,735  | 1,534  | Geokon    |             |
| PB607          | Ring 2 | BC                           | 145                | 0,635  | 1,534  | Geokon    |             |
| PB608          | Ring 2 | CD                           | 215                | 0,535  | 1,284  | Kulite    | In the slot |
| PB609          | Ring 2 | DA                           | 325                | 0,875  | 1,253  | Geokon    | At rock     |
| PB610          | Ring 5 | A                            | 10                 | 0,785  | 2,795  | Kulite    | Vertical    |
| PB611          | Ring 5 | B                            | 80                 | 0,685  | 2,795  | Kulite    | Vertical    |
| PB612          | Ring 5 | C                            | 170                | 0,585  | 2,795  | Kulite    | Vertical    |
| PB613          | Ring 6 | AB                           | 55                 | 0,785  | 3,550  | Geokon    |             |
| PB614          | Ring 6 | BC                           | 145                | 0,635  | 3,550  | Geokon    |             |
| PB615          | Ring 6 | CD                           | 215                | 0,535  | 3,300  | Kulite    | In the slot |
| PB616          | Ring 6 | DA                           | 325                | 0,875  | 3,253  | Geokon    | At rock     |
| PB617          | Ring 8 | A                            | 10                 | 0,785  | 4,324  | Kulite    | Vertical    |
| PB618          | Ring 8 | B                            | 80                 | 0,685  | 4,324  | Kulite    | Vertical    |
| PB619          | Ring 8 | C                            | 170                | 0,585  | 4,324  | Kulite    | Vertical    |
| PB620          | Ring 9 | AB                           | 55                 | 0,735  | 5,084  | Geokon    |             |
| PB621          | Ring 9 | BC                           | 145                | 0,635  | 5,084  | Geokon    |             |
| PB622          | Ring 9 | CD                           | 215                | 0,535  | 4,834  | Kulite    | In the slot |
| PB623          | Ring 9 | DA                           | 325                | 0,875  | 4,753  | Geokon    | At rock     |
| PB624          | Cyl. 4 | Center                       | 135                | 0,585  | 7,121  | Kulite    |             |
| PB625          | Cyl. 3 | Center                       | 0                  | 0,100  | 6,616  | Geokon    |             |
| PB626          | Cyl. 3 | A                            | 5                  | 0,585  | 6,616  | Geokon    |             |
| PB627          | Cyl. 4 | Center                       | 0                  | 0,100  | 7,121  | Geokon    |             |

**Table 6-8. Numbering and position of instruments for measuring pore water pressure (U) in the buffer in hole 6.**

| Typ and number | Block  | Instrument position in block |          |       |       | Fabricate | Remark      |
|----------------|--------|------------------------------|----------|-------|-------|-----------|-------------|
|                |        | Direction                    | $\alpha$ | r     | Z     |           |             |
|                |        |                              | degree   | m     | m     |           |             |
| UB601          | Cyl. 1 | Center                       | 280      | 0,210 | 0,260 | Kulite    |             |
| UB602          | Cyl. 1 | B                            | 95       | 0,685 | 0,260 | Geokon    |             |
| UB603          | Ring 2 | CD                           | 225      | 0,535 | 1,284 | Geokon    | In the slot |
| UB604          | Ring 2 | DA                           | 310      | 0,875 | 1,253 | Kulite    | At the rock |
| UB605          | Ring 5 | C                            | 190      | 0,585 | 2,795 | Geokon    |             |
| UB606          | Ring 5 | A                            | 350      | 0,785 | 2,795 | Kulite    |             |
| UB607          | Ring 6 | AB                           | 35       | 0,735 | 3,300 | Kulite    |             |
| UB608          | Ring 6 | BC                           | 125      | 0,635 | 3,300 | Kulite    |             |
| UB609          | Ring 6 | CD                           | 225      | 0,535 | 3,300 | Geokon    | In the slot |
| UB610          | Ring 6 | DA                           | 310      | 0,875 | 3,253 | Geokon    | At the rock |
| UB611          | Ring 9 | CD                           | 225      | 0,535 | 4,834 | Geokon    | In the slot |
| UB612          | Ring 9 | DA                           | 310      | 0,875 | 4,753 | Kulite    | At the rock |
| UB613          | Cyl. 3 | Center                       | 135      | 0,100 | 6,366 | Kulite    |             |
| UB614          | Cyl. 4 | Center                       | 90       | 0,100 | 6,961 | Kulite    |             |

**Table 6-9. Numbering and position of instruments for measuring water content (W) in the buffer in hole 6.**

| Typ and number | Block   | Instrument position in block |                    |        |        | Fabricate | Remark      |
|----------------|---------|------------------------------|--------------------|--------|--------|-----------|-------------|
|                |         | Direction                    | $\alpha$<br>degree | r<br>m | Z<br>m |           |             |
| WB601          | Cyl. 1  | Center                       | 135                | 0,050  | 0,260  | Rotronic  |             |
| WB602          | Cyl. 1  | Center                       | 225                | 0,050  | 0,260  | Wescor    |             |
| WB603          | Cyl. 1  | Center                       | 260                | 0,210  | 0,260  | Wescor    |             |
| WB604          | Cyl. 1  | Center                       | 270                | 0,210  | 0,260  | Rotronic  |             |
| WB605          | Cyl. 1  | B                            | 90                 | 0,685  | 0,260  | Wescor    |             |
| WB606          | Cyl. 1  | B                            | 100                | 0,685  | 0,260  | Rotronic  |             |
| WB607          | Ring 1  | B                            | 90                 | 0,685  | 0,770  | Vaisala   |             |
| WB608          | Ring 1  | B                            | 95                 | 0,685  | 0,770  | Wescor    |             |
| WB609          | Ring 1  | C                            | 180                | 0,585  | 0,770  | Vaisala   |             |
| WB610          | Ring 1  | C                            | 185                | 0,585  | 0,770  | Wescor    |             |
| WB611          | Ring 1  | A                            | 355                | 0,785  | 0,770  | Wescor    |             |
| WB612          | Ring 1  | A                            | 360                | 0,785  | 0,770  | Vaisala   |             |
| WB613          | Ring 2  | AB                           | 40                 | 0,735  | 1,284  | Rotronic  |             |
| WB614          | Ring 2  | AB                           | 45                 | 0,735  | 1,284  | Wescor    |             |
| WB615          | Ring 2  | BC                           | 130                | 0,635  | 1,284  | Rotronic  |             |
| WB616          | Ring 2  | BC                           | 135                | 0,635  | 1,284  | Wescor    |             |
| WB617          | Ring 2  | CD                           | 230                | 0,535  | 1,284  | Rotronic  | In the slot |
| WB618          | Ring 2  | CD                           | 235                | 0,535  | 1,284  | Wescor    | In the slot |
| WB619          | Ring 2  | DA                           | 305                | 0,875  | 1,253  | Wescor    | At rock     |
| WB620          | Ring 2  | DA                           | 315                | 0,875  | 1,253  | Rotronic  | At rock     |
| WB621          | Ring 5  | B                            | 90                 | 0,685  | 2,795  | Rotronic  |             |
| WB622          | Ring 5  | B                            | 95                 | 0,685  | 2,795  | Wescor    |             |
| WB623          | Ring 5  | C                            | 180                | 0,585  | 2,795  | Rotronic  |             |
| WB624          | Ring 5  | C                            | 185                | 0,585  | 2,795  | Wescor    |             |
| WB625          | Ring 5  | A                            | 355                | 0,785  | 2,795  | Wescor    |             |
| WB626          | Ring 5  | A                            | 360                | 0,785  | 2,795  | Rotronic  |             |
| WB627          | Ring 6  | AB                           | 40                 | 0,735  | 3,300  | Vaisala   |             |
| WB628          | Ring 6  | AB                           | 45                 | 0,735  | 3,300  | Wescor    |             |
| WB629          | Ring 6  | BC                           | 130                | 0,635  | 3,300  | Vaisala   |             |
| WB630          | Ring 6  | BC                           | 135                | 0,635  | 3,300  | Wescor    |             |
| WB631          | Ring 6  | CD                           | 230                | 0,535  | 3,300  | Vaisala   | In the slot |
| WB632          | Ring 6  | CD                           | 235                | 0,535  | 3,300  | Wescor    | In the slot |
| WB633          | Ring 6  | DA                           | 305                | 0,875  | 3,253  | Wescor    | At rock     |
| WB634          | Ring 6  | DA                           | 315                | 0,875  | 3,253  | Vaisala   | At rock     |
| WB635          | Ring 8  | B                            | 90                 | 0,685  | 4,324  | Rotronic  |             |
| WB636          | Ring 8  | B                            | 95                 | 0,685  | 4,324  | Wescor    |             |
| WB637          | Ring 8  | C                            | 180                | 0,585  | 4,324  | Rotronic  |             |
| WB638          | Ring 8  | C                            | 185                | 0,585  | 4,324  | Wescor    |             |
| WB639          | Ring 8  | A                            | 355                | 0,785  | 4,324  | Wescor    |             |
| WB640          | Ring 8  | A                            | 360                | 0,785  | 4,324  | Rotronic  |             |
| WB641          | Ring 9  | AB                           | 40                 | 0,735  | 4,834  | Rotronic  |             |
| WB642          | Ring 9  | AB                           | 45                 | 0,735  | 4,834  | Wescor    |             |
| WB643          | Ring 9  | BC                           | 130                | 0,635  | 4,834  | Vaisala   |             |
| WB644          | Ring 9  | BC                           | 135                | 0,635  | 4,834  | Wescor    |             |
| WB645          | Ring 9  | CD                           | 230                | 0,535  | 4,834  | Vaisala   | In the slot |
| WB646          | Ring 9  | CD                           | 235                | 0,535  | 4,834  | Wescor    | In the slot |
| WB647          | Ring 9  | DA                           | 305                | 0,875  | 4,753  | Wescor    | At rock     |
| WB648          | Ring 9  | DA                           | 315                | 0,875  | 4,753  | Vaisala   | At rock     |
| WB649          | Ring 10 | Center                       | 90                 | 0,050  | 5,439  | Vaisala   |             |
| WB650          | Ring 10 | Center                       | 270                | 0,210  | 5,439  | Vaisala   |             |
| WB651          | Cyl. 3  | Center                       | 225                | 0,100  | 6,366  | Rotronic  |             |
| WB652          | Cyl. 3  | B                            | 90                 | 0,585  | 6,366  | Vaisala   |             |
| WB653          | Cyl. 3  | C                            | 180                | 0,585  | 6,366  | Rotronic  |             |
| WB654          | Cyl. 3  | A                            | 350                | 0,585  | 6,366  | Vaisala   |             |
| WB655          | Cyl. 4  | Center                       | 180                | 0,100  | 6,801  | Rotronic  |             |
| WB656          | Cyl. 4  | Center                       | 270                | 0,100  | 6,961  | Vaisala   |             |

**Table 6-10. Numbering and position of instruments for measuring water content (W) in the buffer in hole 6. The positions were determined after inflow measurements.**

| Typ and number | Block  | Instrument position in block |                    |        |        |           | Remark |
|----------------|--------|------------------------------|--------------------|--------|--------|-----------|--------|
|                |        | Direction                    | $\alpha$<br>degree | r<br>m | Z<br>m | Fabricate |        |
| WB657          | Ring 6 | C                            | 190                | 0,625  | 3,300  | Wescor    |        |
| WB658          | Ring 6 | C                            | 190                | 0,725  | 3,300  | Wescor    |        |
| WB659          | Rock   | C                            | 190                | 0,900  | 3,100  | Wescor    |        |
| WB660          | Rock   | C                            | 190                | 0,925  | 3,250  | Wescor    |        |
| WB661          | Rock   | C                            | 190                | 0,975  | 3,400  | Wescor    |        |
| WB662          | Ring 8 | D                            | 280                | 0,625  | 4,324  | Wescor    |        |
| WB663          | Ring 8 | D                            | 280                | 0,725  | 4,324  | Wescor    |        |
| WB664          | Rock   | D                            | 280                | 0,900  | 4,100  | Wescor    |        |
| WB665          | Rock   | D                            | 280                | 0,925  | 4,250  | Wescor    |        |
| WB666          | Rock   | D                            | 280                | 0,975  | 4,400  | Wescor    |        |
| WB667          | Cyl.1  | D                            | 280                | 0,685  | 0,260  | Vaisala   |        |
| WB668          | Ring 6 | C                            | 200                | 0,625  | 3,300  | Vaisala   |        |
| WB669          | Ring 6 | C                            | 200                | 0,725  | 3,300  | Vaisala   |        |
| WB670          | Ring 8 | D                            | 290                | 0,625  | 4,324  | Vaisala   |        |
| WB671          | Ring 8 | D                            | 290                | 0,725  | 4,324  | Vaisala   |        |

## 6.4 Instruments on the canister surface in holes 5-6

A system for measuring the temperature with optical cables on the surface of the canisters is used in the same way as for the canisters in Section 1. The system is described in chapter 4.4.

In addition to the optical cables three thermocouples (TB504, TB511 and TB524) in deposition hole 5 and three thermocouples (TB611, TB619 and TB627) in deposition hole 6 are fixed to the surface of the canister (see Table 6-1 and 6-6).

## 6.5 Position of temperature sensors in the rock

Thermocouples are placed on 3 levels in each deposition hole (bottom, 3 m and 6 m level). On level 3 m and 6 m the thermocouples are placed in two directions perpendicular to each other.

The positions are described in Table 6-11.

Table 6-11. Numbering and position of temperature sensors in the rock.

| Type and number                        |                               | $\alpha$ | r     | Z      | Remark |
|--|-------------------------------|----------|-------|--------|--------|
|  | Distance from rock surface(m) | degree   | m     | m      |        |
| <b>Measured from DA3551G01(Hole 5)</b> |                               |          |       |        |        |
| TR5011                                 | 1,000                         | 0°       | 0,000 | -1,000 | Bottom |
| TR5012                                 | 0,500                         | 0°       | 0,000 | -0,500 | Bottom |
| TR5013                                 | 0,200                         | 0°       | 0,000 | -0,200 | Bottom |
| TR5014                                 | 0,000                         | 0°       | 0,000 | 0,000  | Bottom |
| TR5021                                 | 2,200                         | 180°     | 3,075 | 6,000  | East   |
| TR5022                                 | 1,100                         | 180°     | 1,975 | 6,000  | East   |
| TR5023                                 | 0,600                         | 180°     | 1,475 | 6,000  | East   |
| TR5024                                 | 0,200                         | 180°     | 1,075 | 6,000  | East   |
| TR5025                                 | 0,000                         | 180°     | 0,875 | 6,000  | East   |
| TR5031                                 | 2,200                         | 90°      | 3,075 | 6,000  | South  |
| TR5032                                 | 1,100                         | 90°      | 1,975 | 6,000  | South  |
| TR5033                                 | 0,600                         | 90°      | 1,475 | 6,000  | South  |
| TR5034                                 | 0,200                         | 90°      | 1,075 | 6,000  | South  |
| TR5035                                 | 0,000                         | 90°      | 0,875 | 6,000  | South  |
| TR5041                                 | 2,200                         | 180°     | 3,075 | 3,000  | East   |
| TR5042                                 | 1,100                         | 180°     | 1,975 | 3,000  | East   |
| TR5043                                 | 0,600                         | 180°     | 1,475 | 3,000  | East   |
| TR5044                                 | 0,200                         | 180°     | 1,075 | 3,000  | East   |
| TR5045                                 | 0,000                         | 180°     | 0,875 | 3,000  | East   |
| TR5051                                 | 2,200                         | 90°      | 3,075 | 3,000  | South  |
| TR5052                                 | 1,100                         | 90°      | 1,975 | 3,000  | South  |
| TR5053                                 | 0,600                         | 90°      | 1,475 | 3,000  | South  |
| TR5054                                 | 0,200                         | 90°      | 1,075 | 3,000  | South  |
| TR5055                                 | 0,000                         | 90°      | 0,875 | 3,000  | South  |
| <b>Measured from DA3545G01(Hole 6)</b> |                               |          |       |        |        |
| TR6011                                 | 1,000                         | 0        | 0,000 | -1,000 | Bottom |
| TR6012                                 | 0,500                         | 0        | 0,000 | -0,500 | Bottom |
| TR6013                                 | 0,200                         | 0        | 0,000 | -0,200 | Bottom |
| TR6014                                 | 0,000                         | 0        | 0,000 | 0,000  | Bottom |
| TR6021                                 | 2,200                         | 90°      | 3,075 | 6,000  | South  |
| TR6022                                 | 1,100                         | 90°      | 1,975 | 6,000  | South  |
| TR6023                                 | 0,600                         | 90°      | 1,475 | 6,000  | South  |
| TR6024                                 | 0,200                         | 90°      | 1,075 | 6,000  | South  |
| TR6025                                 | 0,000                         | 90°      | 0,875 | 6,000  | South  |
| TR6031                                 | 2,200                         | 360°     | 3,075 | 6,000  | West   |
| TR6032                                 | 1,100                         | 360°     | 1,975 | 6,000  | West   |
| TR6033                                 | 0,600                         | 360°     | 1,475 | 6,000  | West   |
| TR6034                                 | 0,200                         | 360°     | 1,075 | 6,000  | West   |
| TR6035                                 | 0,000                         | 360°     | 0,875 | 6,000  | West   |
| TR6041                                 | 2,200                         | 90°      | 3,075 | 3,000  | South  |
| TR6042                                 | 1,100                         | 90°      | 1,975 | 3,000  | South  |
| TR6043                                 | 0,600                         | 90°      | 1,475 | 3,000  | South  |
| TR6044                                 | 0,200                         | 90°      | 1,075 | 3,000  | South  |
| TR6045                                 | 0,000                         | 90°      | 0,875 | 3,000  | South  |
| TR6051                                 | 2,200                         | 360°     | 3,075 | 3,000  | West   |
| TR6052                                 | 1,100                         | 360°     | 1,975 | 3,000  | West   |
| TR6053                                 | 0,600                         | 360°     | 1,475 | 3,000  | West   |
| TR6054                                 | 0,200                         | 360°     | 1,075 | 3,000  | West   |
| TR6055                                 | 0,000                         | 360°     | 0,875 | 3,000  | West   |

## 6.6 Strategy for describing the position of each device in the backfill in section 2

The strategy for instrumentation of the backfill in Section 2 is the same as in Section 1 and is described in chapter 4.6.

## 6.7 Position of each instrument in the backfill in Section 2

The positions of each instrument are described in Tables 6-12 to 6-15.

**Table 6-12. Numbering and position of instruments for measuring temperature (T) in the backfill in section 2.**

| Type and number | Instrument position         |       |       | Fabricate | Remark    |
|-----------------|-----------------------------|-------|-------|-----------|-----------|
|                 | Section                     | x     | z     |           |           |
|                 |                             | m     | m     | m         |           |
| TFA01           | E, over dep.hole 5          | 0,0   | 2,3   | 3551,0    | Pentronic |
| TFA02           | E, over dep.hole 5          | 0,0   | 1,25  | 3551,0    | Pentronic |
| TFA03           | E, over dep.hole 5          | 0,0   | -0,8  | 3551,0    | Pentronic |
| TFA04           | E, over dep.hole 5          | -0,5  | -2,6  | 3551,0    | Pentronic |
| TFA05           | E, over dep.hole 5          | 0,5   | -2,6  | 3551,0    | Pentronic |
| TFA06           | E, over dep.hole 5          | -1,25 | 0,0   | 3551,0    | Pentronic |
| TFA07           | E, over dep.hole 5          | 1,25  | 0,0   | 3551,0    | Pentronic |
| TFA08           | F, between dep.hole 5 and 6 | 0,0   | 1,0   | 3548,0    | Pentronic |
| TFA09           | F, between dep.hole 5 and 6 | 0,0   | -1,25 | 3548,0    | Pentronic |
| TFA10           | E, over dep.hole 6          | 0,0   | 2,3   | 3545,0    | Pentronic |
| TFA11           | E, over dep.hole 6          | 0,0   | 1,25  | 3545,0    | Pentronic |
| TFA12           | E, over dep.hole 6          | 0,0   | -0,8  | 3545,0    | Pentronic |
| TFA13           | E, over dep.hole 6          | -0,5  | -2,6  | 3545,0    | Pentronic |
| TFA14           | E, over dep.hole 6          | 0,5   | -2,6  | 3545,0    | Pentronic |
| TFA15           | E, over dep.hole 6          | -1,25 | 0,0   | 3545,0    | Pentronic |
| TFA16           | E, over dep.hole 6          | 1,25  | 0,0   | 3545,0    | Pentronic |



**Table 6-13. Numbering and position of instruments for measuring total pressure (P) in the backfill in section 2.**

| Type and number | Instrument position         |      |       | Fabricate | Remark |
|-----------------|-----------------------------|------|-------|-----------|--------|
|                 | Section                     | x    | z     |           |        |
|                 |                             | m    | m     | m         |        |
| PFA01           | Inner part                  | 0,0  | 0,0   | 3555,8    | Kulite |
| PFA02           | E, over dep.hole 5          | 0,0  | 0,0   | 3551,0    | Geokon |
| PFA03           | E, over dep.hole 5          | 0,0  | -1,75 | 3551,0    | Geokon |
| PFA04           | E, over dep.hole 5          | 0,0  | -2,6  | 3551,0    | Geokon |
| PFA05           | E, over dep.hole 5          | 0,0  | -3,15 | 3551,0    | Kulite |
| PFA06           | E, over dep.hole 5          | -2,3 | 0,0   | 3551,0    | Kulite |
| PFA07           | E, over dep.hole 5          | 0,0  | 2,3   | 3551,0    | Kulite |
| PFA08           | F, between dep.hole 5 and 6 | 0,0  | 0,0   | 3548,0    | Geokon |
| PFA09           | F, between dep.hole 5 and 6 | 0,0  | -2    | 3548,0    | Geokon |
| PFA10           | E, over dep.hole 6          | 0,0  | 0,0   | 3545,0    | Kulite |
| PFA11           | E, over dep.hole 6          | 0,0  | -1,75 | 3545,0    | Kulite |
| PFA12           | E, over dep.hole 6          | 0,0  | -2,6  | 3545,0    | Kulite |
| PFA13           | E, over dep.hole 6          | 0,0  | -3,15 | 3545,0    | Geokon |
| PFA14           | E, over dep.hole 6          | -2,3 | 0,0   | 3545,0    | Geokon |
| PFA15           | E, over dep.hole 6          | 0,0  | 2,3   | 3545,0    | Geokon |
| PFA16           | In front of plug            | 0,0  | 0,0   | 3539,0    | Kulite |

**Table 6-14. Numbering and position of instruments for measuring pore water pressure (U) in the backfill in section 2.**

| Type and number | Instrument position         |      |       | Fabricate | Remark |
|-----------------|-----------------------------|------|-------|-----------|--------|
|                 | Section                     | x    | z     |           |        |
|                 |                             | m    | m     | m         |        |
| UFA01           | Inner part                  | 0,0  | 0,0   | 3555,8    | Kulite |
| UFA02           | Inner part                  | 0,0  | 0,0   | 3554,1    | Geokon |
| UFA03           | E, over dep.hole 5          | 0,0  | 0,0   | 3551,0    | Geokon |
| UFA04           | E, over dep.hole 5          | 0,0  | -1,75 | 3551,0    | Kulite |
| UFA05           | E, over dep.hole 5          | 0,0  | -2,6  | 3551,1    | Kulite |
| UFA06           | E, over dep.hole 5          | 0,0  | -3,15 | 3551,0    | Kulite |
| UFA07           | E, over dep.hole 5          | 0,0  | -1,75 | 3551,0    | Geokon |
| UFA08           | E, over dep.hole 5          | 0,0  | 2,3   | 3551,0    | Geokon |
| UFA09           | F, between dep.hole 5 and 6 | 0,0  | 0,0   | 3548,0    | Geokon |
| UFA10           | F, between dep.hole 5 and 6 | 0,0  | -2,0  | 3548,0    | Geokon |
| UFA11           | E, over dep.hole 6          | 0,0  | 0,0   | 3545,0    | Geokon |
| UFA12           | E, over dep.hole 6          | 0,0  | -1,75 | 3545,0    | Geokon |
| UFA13           | E, over dep.hole 6          | 0,0  | -2,6  | 3545,0    | Geokon |
| UFA14           | E, over dep.hole 6          | 0,0  | -3,15 | 3545,0    | Geokon |
| UFA15           | E, over dep.hole 6          | -2,3 | 0,0   | 3545,0    | Geokon |
| UFA16           | E, over dep.hole 6          | 0,0  | 2,3   | 3545,0    | Geokon |
| UFA17           | In front of plug            | -2,3 | 0,0   | 3551,0    | Geokon |
| UFA18           | In front of plug            | 0,0  | 0,0   | 3539,0    | Geokon |

**Table 6-15. Numbering and position of instruments for measuring relative humidity (W) in the backfill in section 2.**

| Type and number | Instrument position         |       |       | Fabricate | Remark |           |
|-----------------|-----------------------------|-------|-------|-----------|--------|-----------|
|                 | Section                     | x     | z     |           |        | y         |
|                 |                             | m     | m     | m         |        |           |
| WFA01           | Inner part                  | 0,0   | 0,0   | 3555,8    | Wescor |           |
| WFA02           | Inner part                  | 0,0   | 0,0   | 3554,1    | Wescor |           |
| WFA03           | E, over dep.hole 5          | 0,0   | 2,3   | 3551,0    | Wescor |           |
| WFA04           | E, over dep.hole 5          | 0,0   | 1,25  | 3551,0    | Wescor |           |
| WFA05           | E, over dep.hole 5          | 0,0   | 0,0   | 3551,0    | Wescor |           |
| WFA06           | E, over dep.hole 5          | 0,0   | -0,8  | 3551,0    | Wescor |           |
| WFA07           | E, over dep.hole 5          | 2,3   | 0,0   | 3545,0    | Wescor |           |
| WFA08           | E, over dep.hole 5          | 0,0   | -2,6  | 3550,9    | Wescor |           |
| WFA09           | E, over dep.hole 5          | 0,0   | -3,15 | 3551,0    | Wescor |           |
| WFA10           | E, over dep.hole 5          | -2,3  | 0,0   | 3551,0    | Wescor |           |
| WFA11           | E, over dep.hole 5          | -1,25 | 0,0   | 3551,0    | Wescor |           |
| WFA12           | E, over dep.hole 5          | 1,25  | 0,0   | 3551,0    | Wescor |           |
| WFA13           | E, over dep.hole 5          | 2,3   | 0,0   | 3551,0    | Wescor |           |
| WFA14           | F, between dep.hole 5 and 6 |       |       |           | Wescor | Not clear |
| WFA15           | F, between dep.hole 5 and 6 | 0,0   | 1,0   | 3548,0    | Wescor |           |
| WFA16           | F, between dep.hole 5 and 6 | 0,0   | 0,0   | 3548,0    | Wescor |           |
| WFA17           | F, between dep.hole 5 and 6 | 0,0   | -0,55 | 3548,0    | Wescor |           |
| WFA18           | F, between dep.hole 5 and 6 | -1,25 | 0,0   | 3548,0    | Wescor |           |
| WFA19           | F, between dep.hole 5 and 6 | 1,25  | 0,0   | 3548,0    | Wescor |           |
| WFA20           | E, over dep.hole 6          | 0,0   | 2,3   | 3545,0    | Wescor |           |
| WFA21           | E, over dep.hole 6          | 0,0   | 1,25  | 3545,0    | Wescor |           |
| WFA22           | E, over dep.hole 6          | 0,0   | 0,0   | 3545,0    | Wescor |           |
| WFA23           | E, over dep.hole 6          | 0,0   | -0,8  | 3545,0    | Wescor |           |
| WFA24           | E, over dep.hole 6          | 0,0   | -1,75 | 3545,0    | Wescor |           |
| WFA25           | E, over dep.hole 6          | 0,0   | -2,6  | 3545,0    | Wescor |           |
| WFA26           | E, over dep.hole 6          | 0,0   | -3,15 | 3545,0    | Wescor |           |
| WFA27           | E, over dep.hole 6          | -2,3  | 0,0   | 3545,0    | Wescor |           |
| WFA28           | E, over dep.hole 6          | -1,25 | 0,0   | 3545,0    | Wescor |           |
| WFA29           | E, over dep.hole 6          | 1,25  | 0,0   | 3545,0    | Wescor |           |
| WFA30           | E, over dep.hole 6          | 0,0   | 2,3   | 3548,0    | Wescor |           |
| WFA31           | In front of plug            | 0,0   | 0,0   | 3540,0    | Wescor |           |
| WFA32           | In front of plug            | 0,0   | 0,0   | 3539,0    | Wescor |           |



## 7 Results and comments for Section 2

### 7.1 General

In this chapter short comments on general trends in the measurements are given. Sensors that are not delivering reliable data or no data at all are noted and comments on the data collection in general are given.

The heating of the canister in hole 5 started with an applied constant power of 1800 W at 030508. This date is also marked as start date. The backfilling started 030429 and was finished 030625 and the plug was cast at 030911. Table 7-1 shows some important dates for section 2. Since the start of the test the power to the two canisters has been reduced with 30 W at three occasions and is thus now running with a power of about 1710 W.

**Table 7-1. Key dates for section 2.**

| Activity                                    | Date       |
|---|------------|
| Start backfilling                           | 29/4 2003  |
| Start heating canister 5                    | 8/5 2003   |
| Start heating canister 6                    | 23/5 2003  |
| Finished backfilling                        | 25/6 2003  |
| Plug casting                                | 11/9 2003  |
| Decreased power (-30 W)                     | 8/9 2004   |
| The power to all canisters was switched off | 2/12 2004  |
| The drainage of the tunnel was opened       | 6/12 2004  |
| The power to the canisters was switched on  | 15/12 2004 |
| The power to canister 6 was switched off    | 6/9 2005   |
| The power to canister 6 was switched on     | 2/11 2005  |
| Decreased power (-30 W)                     | 2/12 2005  |
| Decreased power (-30 W)                     | 21/12 2006 |
| The power to canister 6 was switched off    | 17/10 2007 |
| The power to canister 6 was switched on     | 22/10 2007 |

97 out of 394 sensors (excluding water pressure sensors in the rock, geo-electric measurements, stress and strain in the rock and displacement of canister) are out of order.

The measured processes in the buffer and the backfill were slow up to about 20 days after the drainage of the tunnel was closed. Very small changes of the measured parameters have occurred up to that date. After that the readings from some of the total and pore pressure sensors placed in the buffer have reacted strongly (quick increase in pressure). Also the total and pore pressure sensors placed in the backfill have recorded high pressures caused by the closing of the drainage. After the opening of the drainage of the tunnel, both the pore pressures and the total pressures were stabilized on a higher level than before the closing of the drainage.

The maximum measured temperature on the canister surface in deposition hole 5 is about 84 °C. For the canister in deposition hole 6 the maximum temperature is about 88 °C.

## **7.2 Deposition hole 5**

### **7.2.1 Total pressure**

#### **Geokon (App. 5\pages 185-188)**

The measured pressure range is from 0 to 9 MPa. PB506 placed in block C1 shows a strong increasing of the total pressure since day 200. High pressures are also indicated by sensors in block R5 and R10. PB511 in block R5 showed a very quick increase in pressure from day 520 up to the day when the power was switched off. After that a drop in pressure of 2 MPa was observed and then an increase in pressure to about 9 MPa. The pressure dropped then to about 6 MPa during a period of 200 days. The pressure was then stabilized on that level for about 250 days. After that period is the sensor measuring an increasing pressure with the time up to a maximum pressure of about 7 MPa when the sensor stopped giving reliable values. The two still working sensors in block R5 are measuring pressures of about 6,5 MPa at the end of this measuring period. Two sensors placed in block R10 (PB521 and PB522) showed a drop in total pressure at around day 300 and then they were stabilized on a pressure of about 2 MPa. The two sensors measured an increase in pressure when the drainage was closed. When the power to the canister was switched off the measured pressures decreased quickly with about 1 MPa. After the power was switched on again the measured pressures increased very quickly to the same level as before the power was switched off. The measured pressures are continuing to increase and are at the end of this measuring period about 4 MPa.

Five sensors are out of order.

#### **Kulite (App. 5\page 189)**

The highest pressure 2,5 MPa was measured by a sensor placed close to the canister in block R5 (PB510). This sensor has stopped giving reliable values. Sensor PB520, placed in block R10 closer to the surface of the deposition hole measure a pressure of about 2 MPa at the end of this measuring period. One sensor also placed in block R5 (PB519) measure a total pressure of about 1,5 MPa. The rest of the sensors are measuring low pressures.

Three sensors are out of order.

### **7.2.2 Relative humidity/suction in dep. hole 5**

#### **Vaisala (App. 5\pages 190-193)**

Since temperature is also measured with all relative humidity sensors, the diagrams include those measured temperatures. The temperature measurements start at about 16 degrees while the RH measurements start at about 70 % RH.

The sensors placed in the bottom block C1 show very small changes in RH with time. The measured relative humidity varies between 70-85 %.

One sensor placed in block R5 close to the canister (WB519) indicated a very strong drying of the bentonite until day 170 when it stopped to give reliable values. Sensor WB520 placed in the middle of block R5 indicated also an initial drying of the bentonite. The rest of the sensors in block R5 indicate a slowly wetting of the buffer (increase in RH).

Two sensors in block R10 placed close to the top of the canister (WB522, WB523) indicated a drying of the bentonite up to day 350 and after that a slowly wetting. The rest of the sensors in block R10 indicate initially a wetting of the buffer. The relative humidity at the end of this measuring period varies between 57% close to the canister lid and 85% at the periphery of the bentonite block.

Three sensors placed in block C3 and C4 indicate a slowly wetting of the buffer.

Eleven sensors are out of order.

### **Rotronic (App. 5\pages 194-198)**

Seven of the sensors placed in the bottom block C1 show a slow increase in RH with the time. The measured Relative Humidity in block C1 varies between 72-98 %.

One sensor placed in block R5 close to the canister (WB516) indicated a very strong drying of the bentonite for the first 60 days. The sensor indicated then a wetting for the next 60 days and after that another period of drying until day 230. After that the sensor is measuring an increase in Relative Humidity indicating a wetting of the buffer until it stopped to function.

All the sensors in block R10 have stopped giving reliable values.

One sensor placed in block C3 indicates a slowly wetting of the bentonite and is at the end of this measuring period recording a Relative Humidity of about 100 %.

Eight sensors are out of order.

### **Wescor Psychrometers (App.5\page 199)**

The Wescor sensors can measure suction between 6000 and 200 kPa.

Five of totally ten sensors are beginning to measure a decrease in suction of the buffer. These sensors (WB538, WB539, WB540, WB541 and WB542) are placed in block R3. The sensors are indicating a high degree of saturation of the buffer in block R3.

## **7.2.3 Pore water pressure**

### **Geokon (App. 5\page 200)**

All sensors yield very low pressures.

### **Kulite (App. 5\page 201)**

Sensors UB508 was out of order from start and it is not plotted in this report.

All the installed sensors yield very low pressure.

Three sensors are out of order.

#### **7.2.4 Temperature in the buffer (App. 5\pages 202-213)**

Three thermocouples (TB504, TB511 and TB524) are placed on the surface of the canister. TB504 placed close to the bottom of the canister shows a temperature of about 67 °C, TB511 placed at the middle of canister about 74 °C and TB524 placed close to the top of the canister shows a temperature of about 67 °C.

High temperatures are measured with thermocouples placed in the center of block C1 and just below the canister (TB503, 66 °C) and in block R5 (TB513, 72 °C). The temperature gradient over block R5 (between the radius 585 mm and 785 mm) is at the end of this measuring period about 0.65 °C/cm.

The temperature in the buffer is also measured with the Geokon sensors. The maximum temperature recorded with these sensors is about 68 °C at the end of this measuring period (PBU502 placed at the center of block C1 close to the canister bottom).

The temperature in the buffer is also measured with the Wescor sensors. The maximum temperature recorded at the end of this measuring period with these sensors is about 70 °C.

#### **7.2.5 Canister power (App. 5\page 217)**

The power of the canister in hole 5 has been kept constant at 1800 W from the start 2003-05-08 until the beginning of September 2004 when the power was decreased to about 1770 W. During the period between December 6 (day 575) and December 15 (day 588) the power to the canister was switched off. After that period the power was adjusted to about 1770 W again. At the beginning of December 2005 the power was decreased with 30 W to about 1740 W. The latest reduction of the power with about 30 W to a power of about 1710 W was done in December 2006.

Due to problems with the data collection system, data is missing for the first 45 days of the heating.

#### **7.2.6 Temperature on the canister surface (App. 5\pages 218-220)**

The first diagram shows the maximum temperature, measured with the optical cables placed on the surface of the canister, plotted as function of time. The present maximum measured temperature on the canister surface is about 77 °C. The second diagram shows the distribution of the temperature along the optical cables at the end of this measuring period. With no damages on the optical cables this plot should have four curves. Only one curve with relevant values is presented here which indicates that the optical cables are damaged. The length of the cables on the canister surface is about 20 m. The variation of a few degrees is caused by the difference in temperature at the center and ends of the canister. The curves may thus be further corrected after completed calibration. Compared to the measurements of the canister temperature with conventional thermocouples (see chapter 7.2.4) the optical cables yield a higher maximum temperature.



## **7.3 Deposition hole 6**

### **7.3.1 Total pressure**

#### **Geokon and Kulite (App. 6\pages 223-226)**

The results from two types of sensors are presented in the same plot.

The measured pressure range is from 0 to 11.7 MPa. Two sensors, PB624 and PB627 placed in the top block (C4) showed an increase in pressure with about 1.5 MPa when the drainage of the tunnel was closed. The sensors placed in block C4 are measuring a pressure between 1.2 – 2,2 MPa at the end of this measuring period. Three sensors placed in Block R1 and R2, PB603, PB606 and PB607 measured a pressure between 10-11,5 MPa at the end of this measuring period. Three sensors placed in Block R5 and R6 are measuring a pressure of about 7,5 MPa at the end of this measuring period. Three of the sensors placed in Block R8 and R9 (PB620, PB621 and PB623) showed a strong increase in pressure after the power was switched on again at the end of year 2004. All the sensors reacted also with a rapid decrease in pressure when the power to canister 6 was switched off for the second time. After the drop in pressure most of the sensors started to measure an increase in pressure even though the power was not switched on. Also the third time (day 1623 date 2006-10-17) when the power to canister 6 was switched off for period of 5 days affected the measured pressure in the buffer. The measured total pressure in Block R8 and R9 varies between 2 and 6 MPa at the end of this measuring period.

Nine sensors (eight Kulite and one Geokon) are out of order.

### **7.3.2 Relative humidity/Suction**

#### **Vaisala and Rotronic (App. 6\pages 227-233)**

The results from two types of sensors are presented in the same plot.

The sensors placed in the bottom block C1 show small changes in RH with the time. At the end of this measuring period two sensors are measuring a relative humidity of about 97%.

Two sensors placed in block R1 and R2 indicated a very quick increase in RH to 100% when the drainage was closed. All of the installed sensors in block R1 and R2 have stopped giving reliable values.

All sensors placed in block R5 and R6 stopped giving reliable values of the RH after the drainage was closed.

One sensor placed close to the canister in block R9 (WB645) indicates a drying of the buffer. The rest of the sensors in block R8 and R9 indicate a slowly wetting of the buffer up to the time when the drainage was closed. At that point a quick increase in RH was measured by several sensors and most of them stopped give reliable values after that period.

Two sensors (WB649, WB650) placed in block R10 and at the top of the canister indicated an initial wetting of the bentonite and then a continuing drying. The two sensors stopped functioning around day 600 (when the drainage of the tunnel was closed).

The sensors placed in block C3 and C4 show very small changes in RH with the time.

Sensors WB606, WB634 and WB648 were out of order at the start of the heating phase and are not plotted in this report.

32 of the initial 37 installed sensors are out of order.

### **Wescor Psychrometers (App. 6\page 234-238)**

Three of totally nine sensors installed in the rock wall are measuring suction in the rock at the end of this measuring period. Twelve of totally 26 sensors installed in the buffer are giving reliable values at the end of this measuring period.

### **7.3.3 Pore water pressure**

#### **Geokon and Kulite (App. 6\pages 239-241)**

All sensors except two yield very low pressures (below 0.2 MPa) One sensor placed at the level of block R6 at the rock surface is measuring a pressure of 0,8 MPa and one sensor placed in block R2 toward the inner slot between the buffer and the canister is measuring a pressure of 1,7 MPa at the end of this measuring period. Notable is that the two sensors reacted very strongly when the power to the canister was switched off in October 2006.

Three sensors (Kulite) are out of order.

#### **7.3.4 Temperature in the buffer (App. 6\pages 242-254)**

Three thermocouples (TB611, TB619 and TB627) are placed on the surface of the canister. TB611 placed closed to the bottom of the canister showed a temperature at the end of this measuring period of about 64 °C while TB619 placed at the middle of canister showed a temperature of 71 °C. TB627 placed close to the top of the canister was measuring a temperature of about 68 °C.

The maximum temperature in the buffer recorded at the end of this measuring period is 71 °C. It was measured in block R5, close to the canister (TB612). The temperature plot for this sensor indicates that the thermocouple is in contact with the canister. When this sensor is excluded the maximum temperature gradient over block R5 is about 0.46 °C/cm.

Eleven thermocouples are out of order.

The temperature in the buffer is also measured by the installed Geokon sensors. The maximum temperature recorded with these sensors at the end of this measuring period is about 70 °C (UB609 placed in block R6 close to the canister). Four sensors are out of order.

Also the installed Wescor sensors are measuring the temperature in the buffer. The maximum temperature recorded with these sensors is about 71 °C at the end of this measuring period. The sensor is placed in block R6 close to the canister surface.

All the sensors which are measuring the temperature in the buffer reacted as expected when the power to the canister was switched off.

### **7.3.5 Canister power (App. 6\page 258)**

The power of the canister in hole 6 was kept constant at 1800 W from the start 2003-05-08 to the beginning of September 2004 when the power was decreased to about 1770 W. During the period between December 6 (day 575) and December 15 (day 588) the power to the canister was switched off. After that period the power was adjusted to about 1770 W. During a period of about 2 months (from August 2) the power was switched off and after that the power was adjusted to 1770 W again. At the beginning of December 2005 the power was decreased with 30 W to about 1740 W. The latest reduction of the power to about 1710 W was done in December 2006. During a period of about 5 days in October 2007 the power to the canister was switched off. After that period the power was adjusted to 1710 W again.

Due to problems with the data collection system, data is missing for the first 30 days of the heating.

### **7.3.6 Temperature on the canister surface (App. 6\pages 259-261)**

The first diagram shows the maximum temperature plotted as a function of time. The optical system stopped giving reliable values at around day 1300. The average maximum measured temperature on the canister surface just before the sensor stopped functioning was about 76 °C. The second diagram shows the distribution of the temperature along the optical cables just before the optical system stopped functioning. The maximum temperature has decreased with about 9 °C after the switch off/switch on of the power at the end of year 2004. After the second period when the power was switched off and switched on again the temperature increased to the same level as before the power was switched off. The length of the cables on the canister surface is about 20 m. The variation of a few degrees is caused by the difference in temperature at the center and ends of the canister.

## **7.4 Backfill in Section 2**

### **7.4.1 Total pressure**

#### **Geokon (App. 7\page 265)**

All the total pressure sensors measured an increased pressure, of about 1 MPa, after the drainage of the tunnel was closed. The highest total pressures before the closing of the drainage, 0,4 MPa, was measured by the sensor PFA13. This sensor is placed just above the bentonite surface in the deposition hole 6. The rest of the total pressure sensors measured very low pressures before the closing of the drainage. However, all installed sensors indicated a decrease in pressure when the drainage was opened again. The maximum measured pressure just after the opening of the drainage was about 0.4 MPa. All the sensors recorded a slow increase in pressure although the drainage was kept open. Just before the power to canister 6 was switched off again at the beginning of September 2005 the maximum recorded pressure was about 1 MPa. All the sensors indicated a decrease in pressure when the power to canister 6 was switched off. When the power was switched on the pressure started to slowly increase again and the maximum pressure recorded at around day 1450 was about 1.2 MPa. After that all the sensors were measuring an increase in pressure of about 0.3 MPa. This increase in

pressure is caused by the initial hydraulic tests made for the construction of a new tunnel close to the Prototype-tunnel. The work with the tunnel continues and affects the pressure in the backfill with both increasing and decreasing in pressure.

### **Kulite (App.7 \page 266)**

These sensors measured also an increase in total pressure of about 1 MPa due to the closing of the drainage. The highest pressure before the closing of the drainage was measured by the sensor PFA12, about 0.4 MPa. This sensor is placed just above the bentonite surface in deposition hole 6. The rest of the total pressure sensors measured very small pressures before the closing of the drainage. After the reopening of the drainage, all the sensors recorded a drop in total pressure. The measured pressure started to slowly increase although the drainage was kept open. When the power to canister 6 was switched off again at the beginning of September 2005 the maximum recorded pressure decreased to 0.6 MPa and after that the pressure started to slowly increase again and the maximum pressure recorded at around day 1450 was about 1.2 MPa. Also these sensors were measuring an increase in pressure of about 0.3 MPa when tests made for the new tunnel closed to the Prototype-tunnel started.

### **7.4.2 Suction (App. 7 \pages 267-273)**

The suction in the backfill is measured with Wescor psychrometers. Most of the psychrometers yield suction values between 2500 and 3500 kPa at the start of the test, which correspond to the initial suction at a water ratio in the backfill of 12%. Some sensors have clearly being wetted to almost fully saturation (suction below 1500 kPa) very short after the start of the test. These sensors (WFA12, WFA20, and WFA27) are placed close the rock surface. A decrease in suction and thus a wetting of the backfill was indicated by the rest of the sensors until the closing of drainage of the tunnel. All of the still working sensors were after this event showing a quicker decrease in suction. None of the installed sensors are giving reliable values at the end of this measuring period.

The position of WFA14 is not clear and the sensor is not plotted in this report.

### **7.4.3 Pore water pressure**

#### **Geokon (App. 7\pages 274-276)**

All the sensors, except one (UFA11), showed an increase in pore pressure, about 1.5 MPa, after the closing of the tunnel drainage. The sensors recorded very low pressures before this event. After the drainage was reopening all sensors placed close to the tunnel surface indicated a slow increase in pore pressure. Just before the power to canister 6 was switched off again at the beginning of September 2005 the average recorded pressure was 0.5 MPa. The pressure dropped then with about 0.2 MPa with a subsequent slowly increase in pressure. The average pressure for these sensors was about 0.5 MPa around day 1450. Also these sensors were measuring an increase in pressure of about 0.3 MPa when the tests made for the new tunnel closed to the Prototype-tunnel started. Duet to problems with the logger at the beginning of this measuring period date is missing for a period of 2 months.

## **Kulite (App. 7\page 277)**

Three of the sensors showed an increase in pore pressure, about 1.5 MPa, after the closing of the tunnel drainage. The sensors recorded very low pressures before this event. After the drainage was reopened again, the two still working sensors measured maximum values of about 0.55 MPa. When the power to canister 6 was switched off again the pressures dropped with about 0.2 MPa. The still working sensor measured a pressure of about 0.5 MPa around day 1450. The measured pressure increased then with about 0.3 MPa caused by the work with the new tunnel.

Three sensors are out of order.

### **7.4.4 Temperature (App. 7\pages 278-280)**

The temperature in the backfill ranges from 20 to 33 °C. The highest temperatures is as expected measured just above the buffer in hole 5. When the power to canister 6 was switched off at the beginning of September 2005 the temperature in the backfill close to upper surface of the buffer in deposition hole 6 dropped with about 2°C but is now measuring a higher temperature than before the power was switched off.

## **7.5 Temperature in the rock**

### **7.5.1 Near hole 5 (App. 5\pages 214-216)**

The maximum temperature in the rock (56 °C) is measured by TROA5045 located at rock surface near the center of the canister in deposition hole 5.

### **7.5.2 Near hole 6 (App. 6\pages 255-257)**

The maximum temperature in the rock just before the power to canister 6 was switched off (54 °C) was measured by TROA6055. The sensor is located at rock surface near the center of the canister in deposition hole 6. All the sensors placed close to deposition hole 6 measured a drop in temperature when the power was switched off at the beginning of September 2005 but were after the power was switched on again reached the same level. The temperature in the rock has not completely recovered from the latest drop in temperature when the power to the canister was switched off for five days in October 2007.

## **7.6 Analyze of data from Section 2**

### **7.6.1 Deposition hole 5**

The saturation of the buffer in deposition hole 5 indicated by both RH sensors and total pressure sensors is complex. Some total pressure sensors indicate rather high total pressures (higher than 2.5 MPa) while others measure very low pressures. The sensors giving high pressures are placed both in block C1, R5 and R10. There are also some RH-sensors which are measuring relative humidity of ~100%, indicating a high saturation of the buffer. In other parts of the buffer most of the sensors (both RH-sensors and total pressure sensors) indicate a slow wetting of the buffer with time.

Although the sensors reacted rather strongly just before and after the power was switched off and on at the beginning of December 2004, the saturation rate indicated by the sensors is not changed radically over the time. One sensor (PB510), measuring the total pressure in block R5 at the inner slot towards the canister, measured just before it stopped functioning a pressure of about 2600 kPa. This sensor started to react around day 200 which might be an indication of the time when the inner slot was closed.

In Figure 7-1 the temperature for deposition hole 5 is plotted as function of the radial distance from the center of the deposition hole at mid height of the canister. Compared the corresponding plots for deposition hole 3 these plots do not show a drop in temperature between the surface of the canister and the buffer (inner diameter of the ring) although the temperature gradient is higher close to the canister surface. The temperature on the canister surface is also much lower compared to the canister in deposition hole 3. These measurements indicate that the initial slot between the buffer and the canister of about 10 mm is not present anymore, but the closing of the slot is not associated with the high pressures generated in the buffer and backfill at the closing of the tunnel drainage.

The temperature gradient over the inner part of the buffer together with the temperature on the canister and the temperature at the radius of 600 mm in the ring shaped block R5 are plotted as function of time in Figure 7-2. The shaded part of the plot is representing the time when the power to the canisters was switched off. The plot shows that both the temperature and the temperature gradient were affected very little by the switch off/on of the power. The plot is indicating that there is slow decrease in the temperature gradient after the power was switched on again.

The temperature gradient over the outer part of the buffer is plotted in Figure 7-3. After the power was switched on again this gradient is also stabilized on about the same level as before the power was switched off.

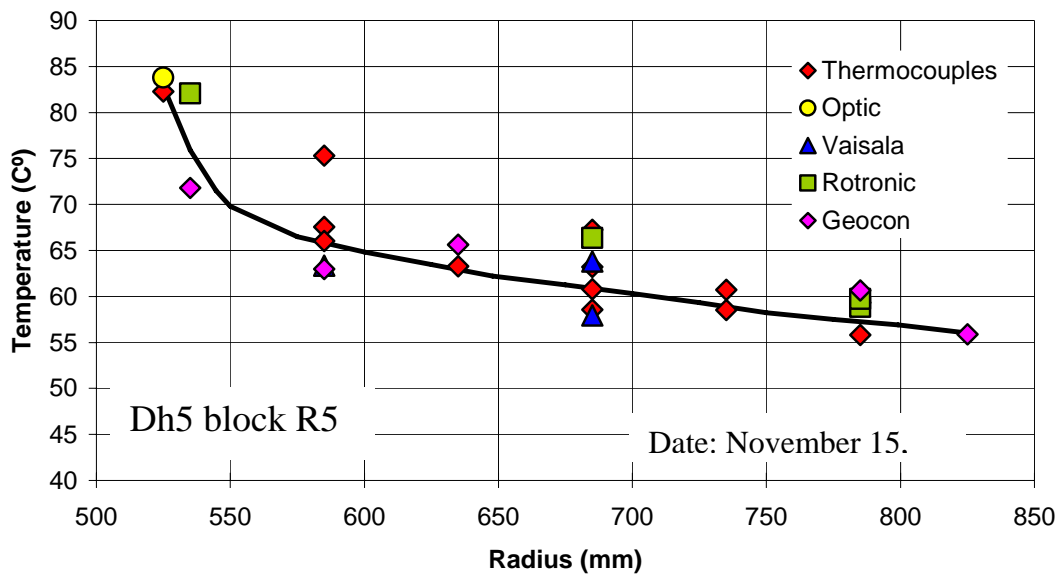

**Figure 7-1.** The temperature in block R5 in Dh 5 as function of radius from the center of the deposition hole on November 15, 2004.

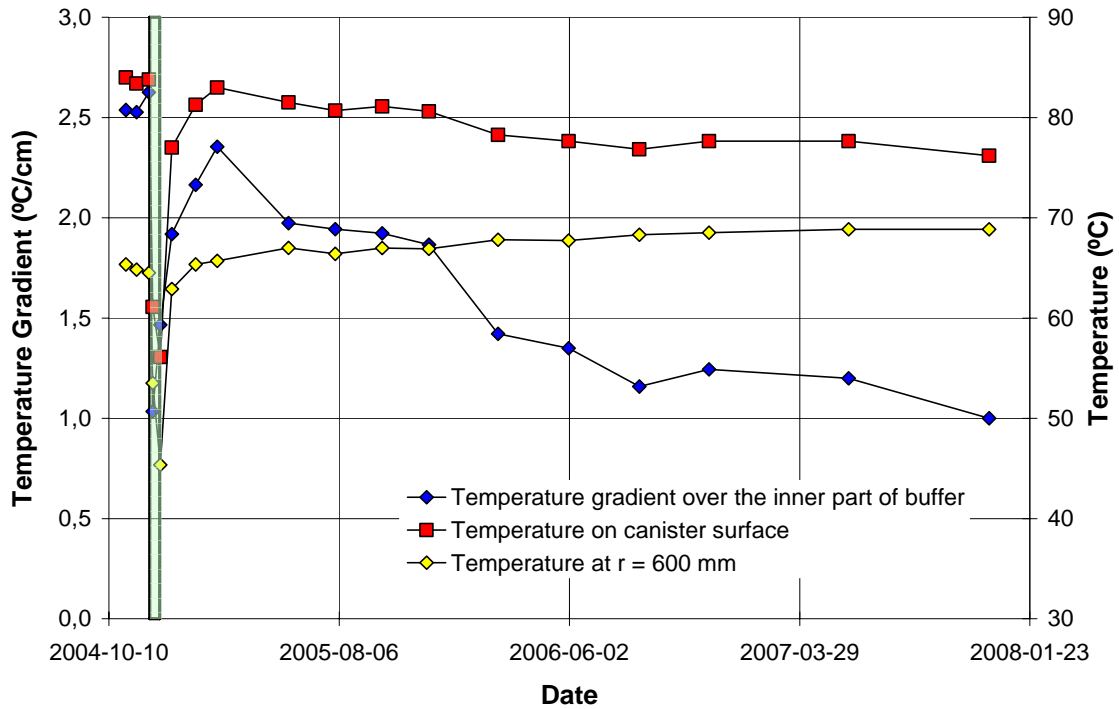

Figure 7-2. The temperature and temperature gradient over the inner part of the buffer plotted as function the date in deposition hole 5 block R5.

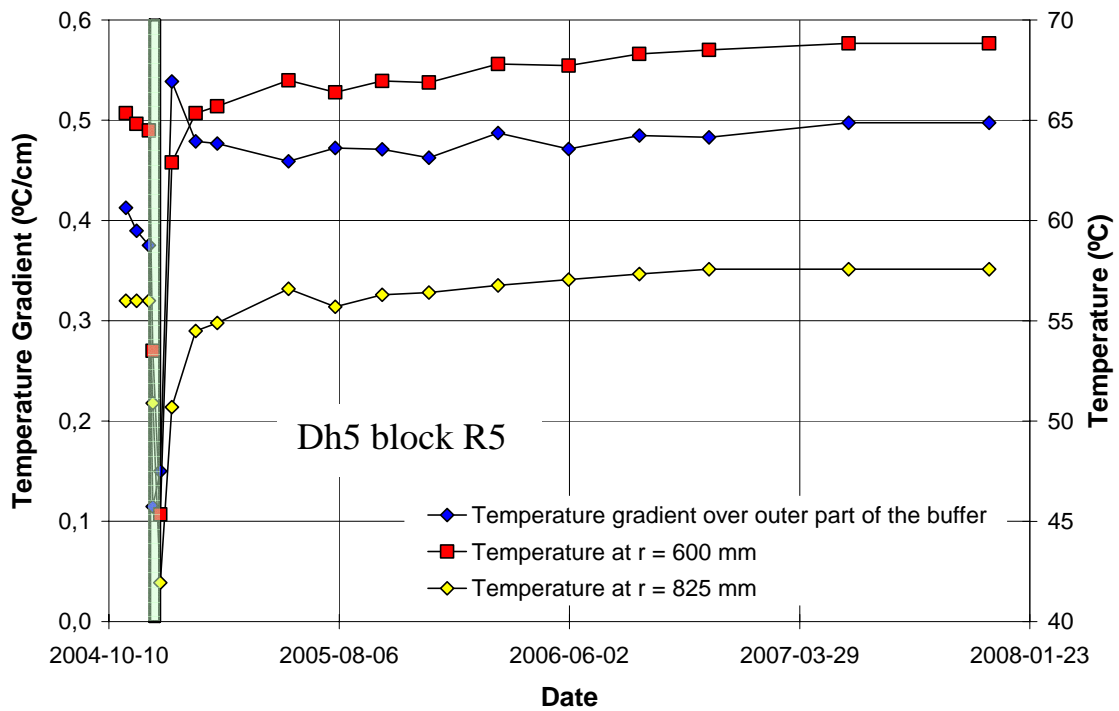

Figure 7-3. The temperature and temperature gradient over the outer part of the buffer plotted as function the date in deposition hole 5 block R5.

### 7.6.2 Deposition hole 6

The saturation of the buffer in deposition hole 6 was affected by the quick increase in pressure when the drainage of the tunnel was closed, indicated by both RH sensors and total pressure sensors. The total pressure was also affected when the power was switched off again at the beginning of September 2005. The drop in total pressure was very large and rapid and the pressure started to increase before the power to the canister was switched on again. When the power was switched on pressure increased very fast to the same level as before the power was switched off. The third time when the power to the canister was switched off in October 2007 caused also a drop in the measured total pressure and then a quick increase in pressure when it was switched on again. This course of events is indicating that the change in total pressure is an affect of the changes in water volume in the bentonite caused by variation in temperature.

The temperature in the buffer for deposition hole 6 is plotted as function of the radial distance from the center of the deposition hole at mid height of the canister in Figure 7-4 at November 15, 2004 which was before the high pore pressure in the tunnel was observed. Compared to the corresponding plots for deposition hole 5 these plots indicate a drop in temperature between the surface of the canister and the buffer (inner diameter of the ring). The temperature on the canister surface measured with the optical system is also rather high compared to measurements made on canister 1. The measurements indicate that the initial slot between the buffer and the canister of about 10 mm was still open when the drainage was closed. The temperature measurements some time after the drainage was opened again shows that the temperature on the surface of the canister dropped with about 10 °C, see Figure 7-5.

The temperature gradient over the inner slot is shown in Figure 7-6 as function of time. The shaded parts of the plot represents the time when the power to the canister was switched off. The plot shows that both the temperatures and the temperature gradient were affected very much by the closing/opening of the drainage. This is indicating, at the closing of the tunnel drainage that the inner slot vanished when water entered it. The temperatures and the gradient were also affected when the power to the canister was switched off for the second time. Both the temperatures and the gradient have reached the same levels as before the power was switched off the second time.

The closing of the gap is also affecting the temperature development in different part of the buffer since the relation between the heat leaving the end parts of the canister and the heat leaving the cylindrical part of the canister was changed when the gap was closed. Directly after the installation, the buffer was in good contact with the ends of the canister while the slot was isolating the rest of canister surface from the buffer. When the gap was closed, more of the generated heat was leaving the cylindrical part of the canister resulting in a higher temperature in the buffer at the central part of the deposition hole and a lower temperature in the buffer at the ends of the canister.

The temperature gradient over the outer part of the buffer is plotted in Figure 7-7. This gradient was also affected when the power was switched off. After the power was switched on again this gradient was stabilized on the same level as before the power was switched off.



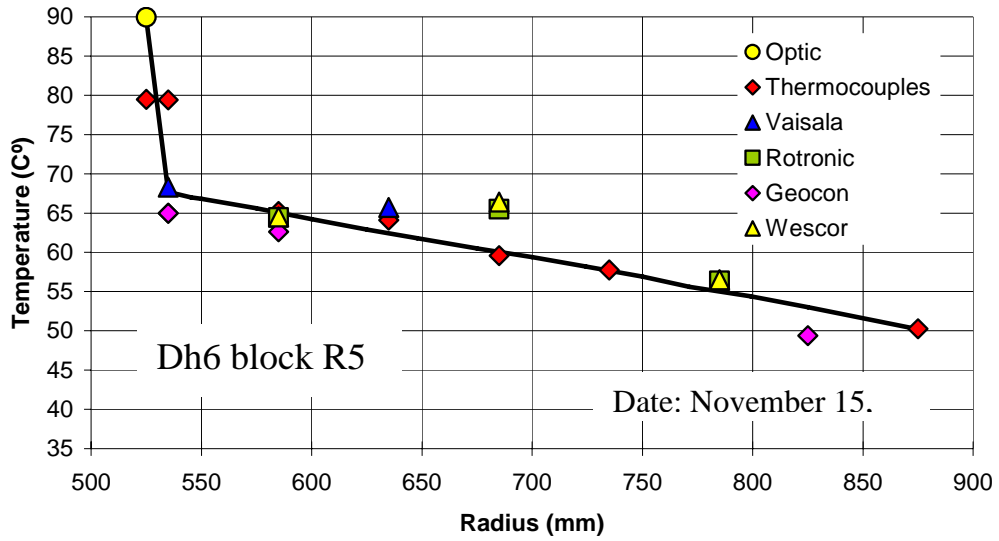

**Figure 7-4.** The temperature in block R5 in Dh 6 as function of radius from the center of the deposition hole on November 15, 2004.

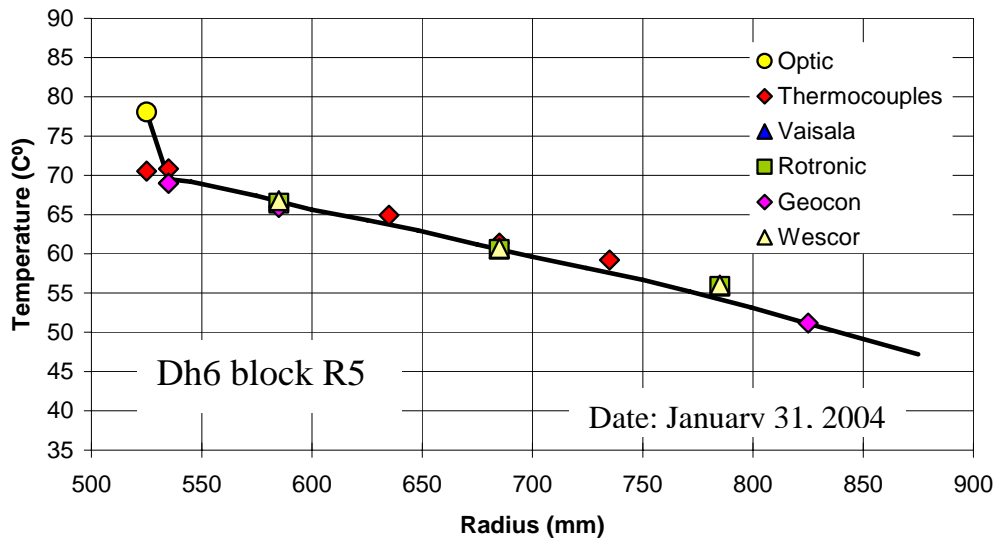

**Figure 7-5.** The temperature in block R5 in Dh 6 as function of radius from the center of the deposition hole on January 31, 2005.

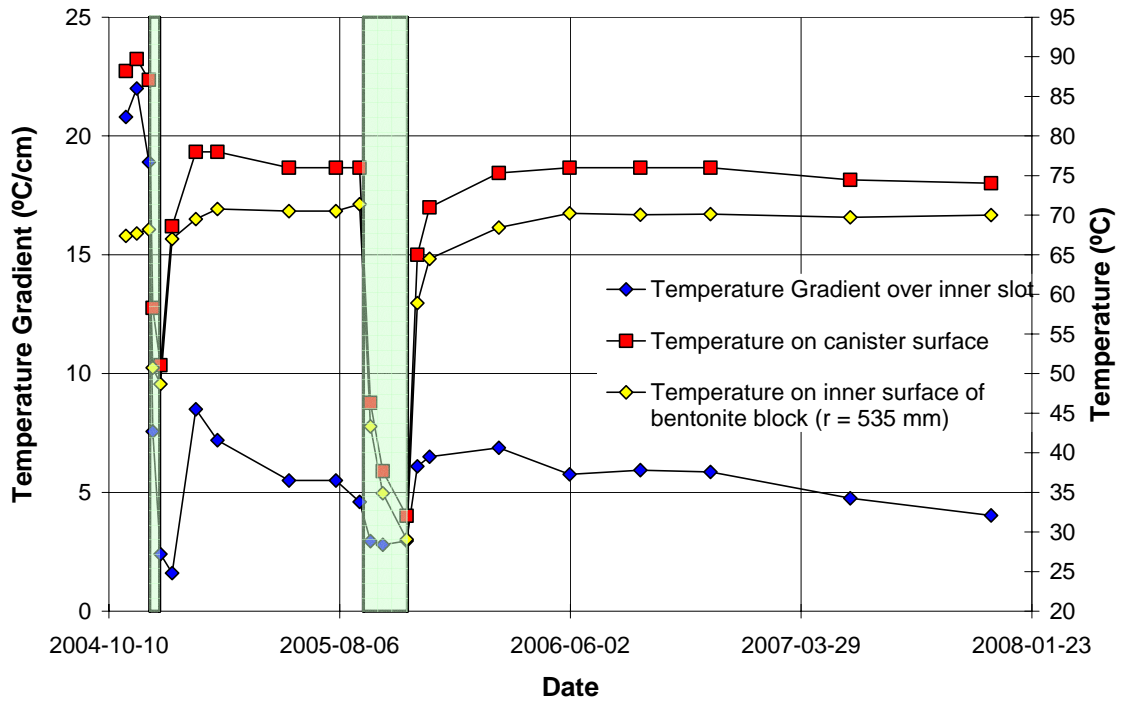

Figure 7-6. The temperature and temperature gradient over the inner slot plotted as function the date in deposition hole 6 block R5.

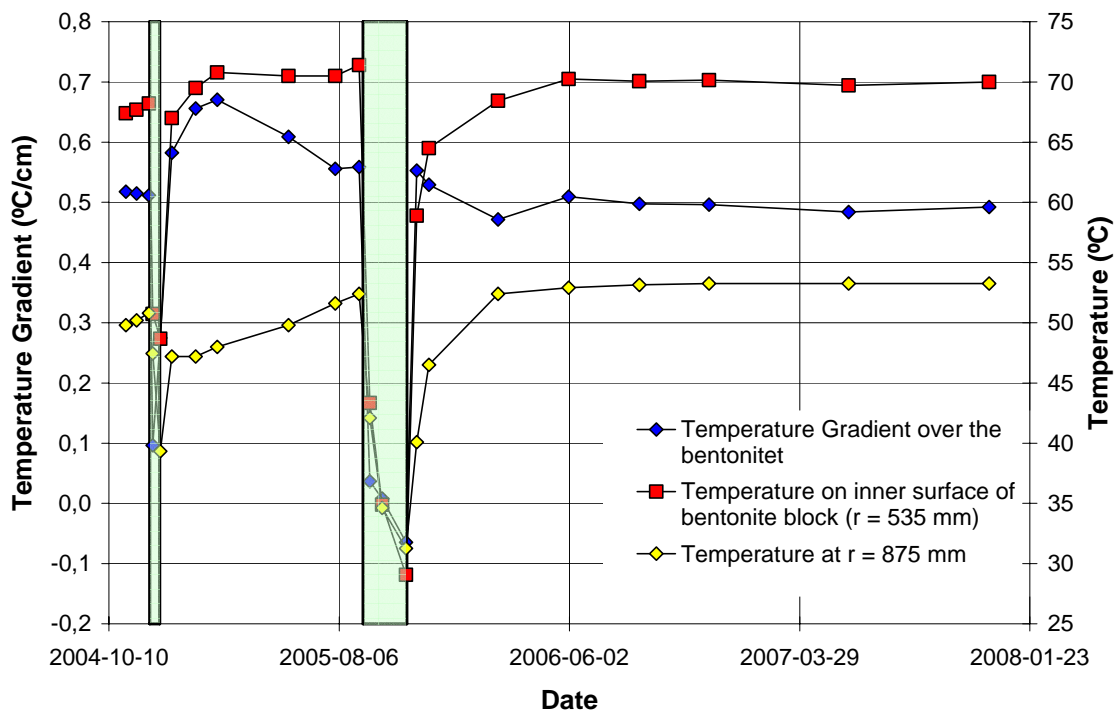

Figure 7-7. The temperature and temperature gradient over the buffer plotted as function the date in deposition hole 6 block R5.

### 7.6.3 Backfill

The pore pressure, measured both with total and pore pressure transducers placed in the backfill, increased fast from a low level when the drainage of the tunnel was closed. This affected the rate in which the backfill was saturated measured both with soil psychrometers and with resistivity measurements in the backfill. After the drainage was opened again the pore pressure stabilized on a higher level than before the drainage was closed. Both the total pressure and the water pressure are continuing to increase although the drainage is kept open. The outflow from the drainage of the outer section is plotted in Figure 7-8. At the middle of April 2007 (around day 2040) are most of the pore pressure and total pressure sensors indicating a rather rapid increase in pressure of about 300 kPa. This increase in pressure is considered to be caused by the tests and investigations made for a new tunnel close to the Prototype tunnel. Most of the installed soil psychrometers measure very low suction values after the closing/opening of the drainage witch indicates that the backfill is close to fully saturated.

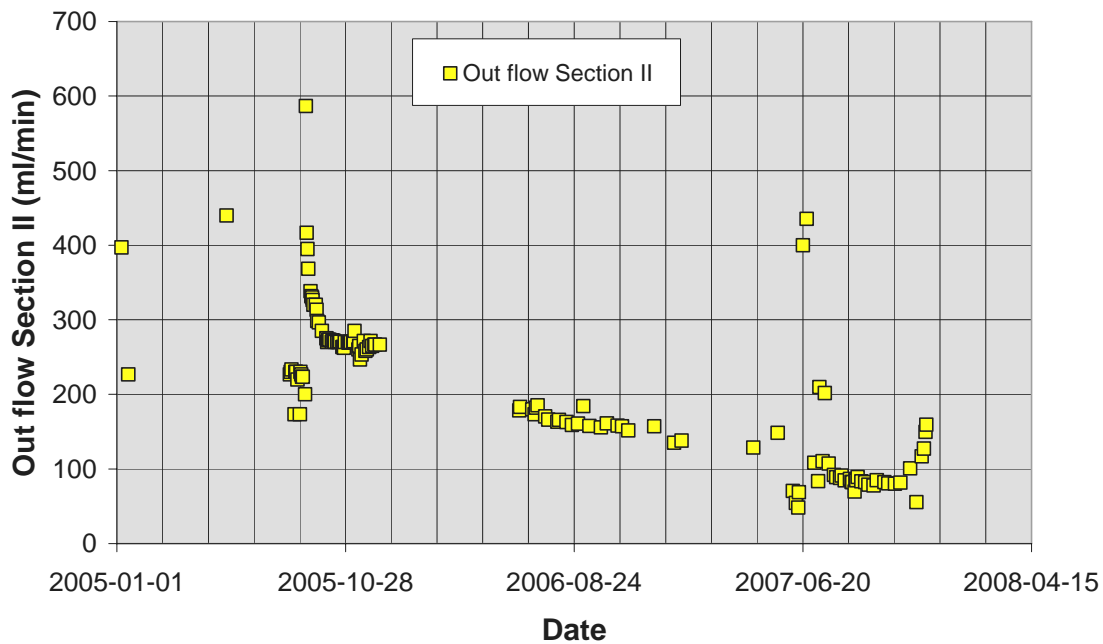

Figure 7-8. The measured outflow from the outer section of the Prototype tunnel.

## References

/1-1/ **Börgesson L, Sanden T.** Report on instrument positions and preparation of bentonite blocks for instruments and cables in section 1, February 2001. SKB IPR-01-20

/2-1/ **Börgesson L, Sanden T.** Instrumentation of buffer and backfill in Section 2, January 2003. SKB IPR-03-21



# Appendix 1

Dep. hole 1



Prototype\Hole 1\Cyl.1 (010917-071201)  
Total pressure - Geokon

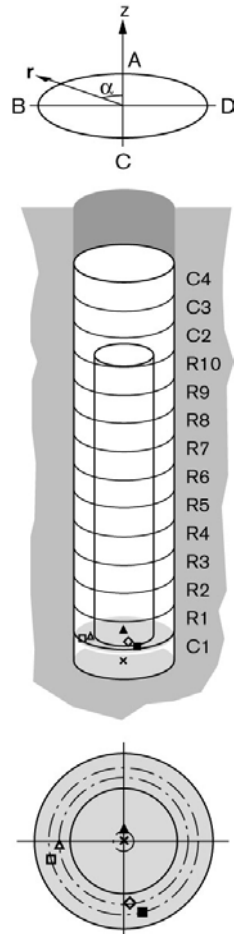
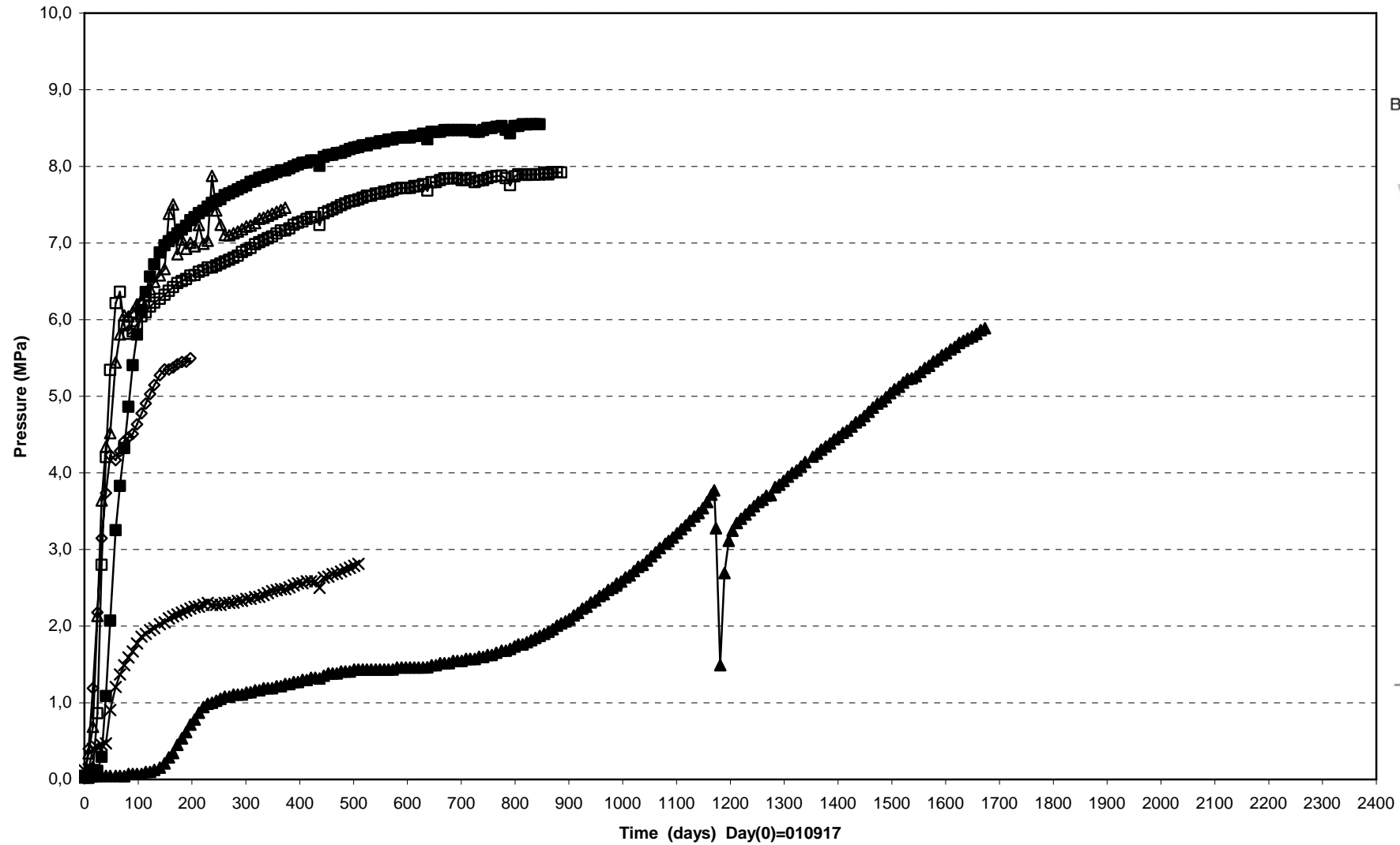

-x- PBU10001(0\0°\0)      -▲- PBU10002(0.504\0°\0.100)      -◇- PBU10008(0.504\185°\0.635)  
 -△- PBU10006(0.504\95°\0.635)      -□- PBU10007(0.504\105°\0.735)      -■- PBU10009(0.504\195°\0.735)

Prototype\Hole 1\Ring5 (010917-071201)  
 Total pressure - Geokon

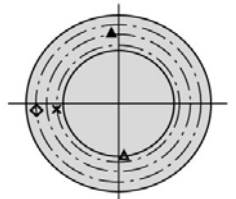
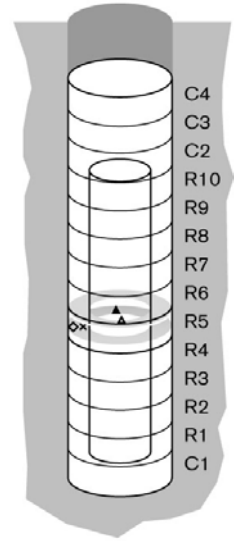
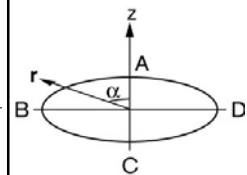

—x— PBU10013(2.780\95°\0.585)  
 —▲— PBU10011(2.780\5°\0.685)  
 —◇— PBU10014(2.780\95°\0.785)  
 —△— PBU10015(3.030\185°\0.535)



Prototype\Hole 1\ Ring10 and Cyl.3 (010917-071201)  
Total pressure - Geokon

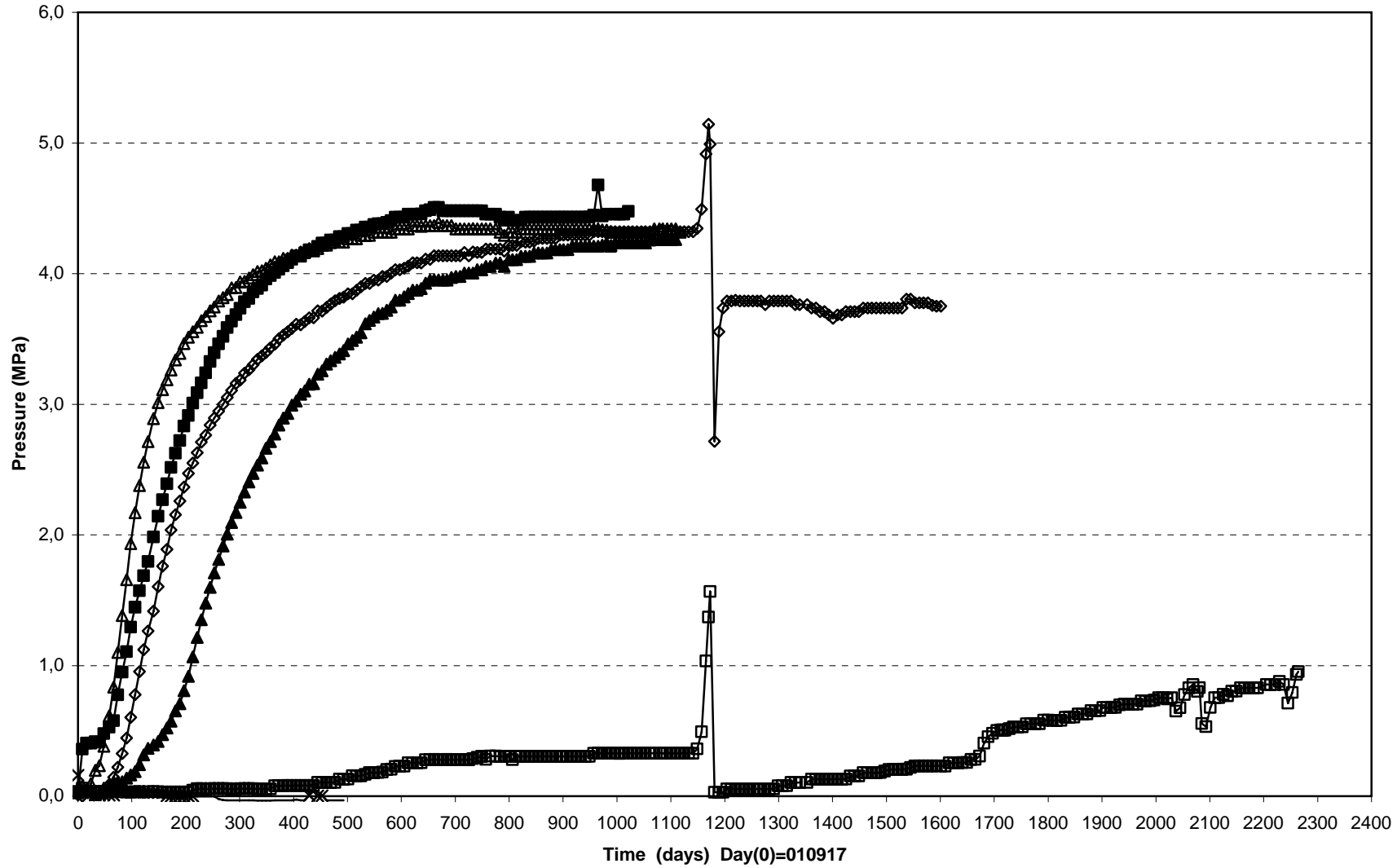

- x— PBU10017(5.558\0°\0.050)    —▲— PBU10021(5.558\90°\0.635)    —◇— PBU10022(5.558\100°\0.735)
- △— PBU10023(5.558\190°\0.735)    —□— PBU10026(6.567\5°\0.585)    —■— PBU10024(5.558\180°\0.635)

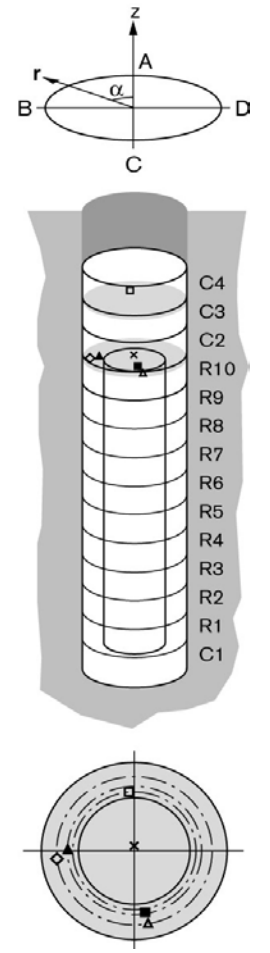

Prototype\ Hole 1 (010917-071201)  
Total pressure - Kulite

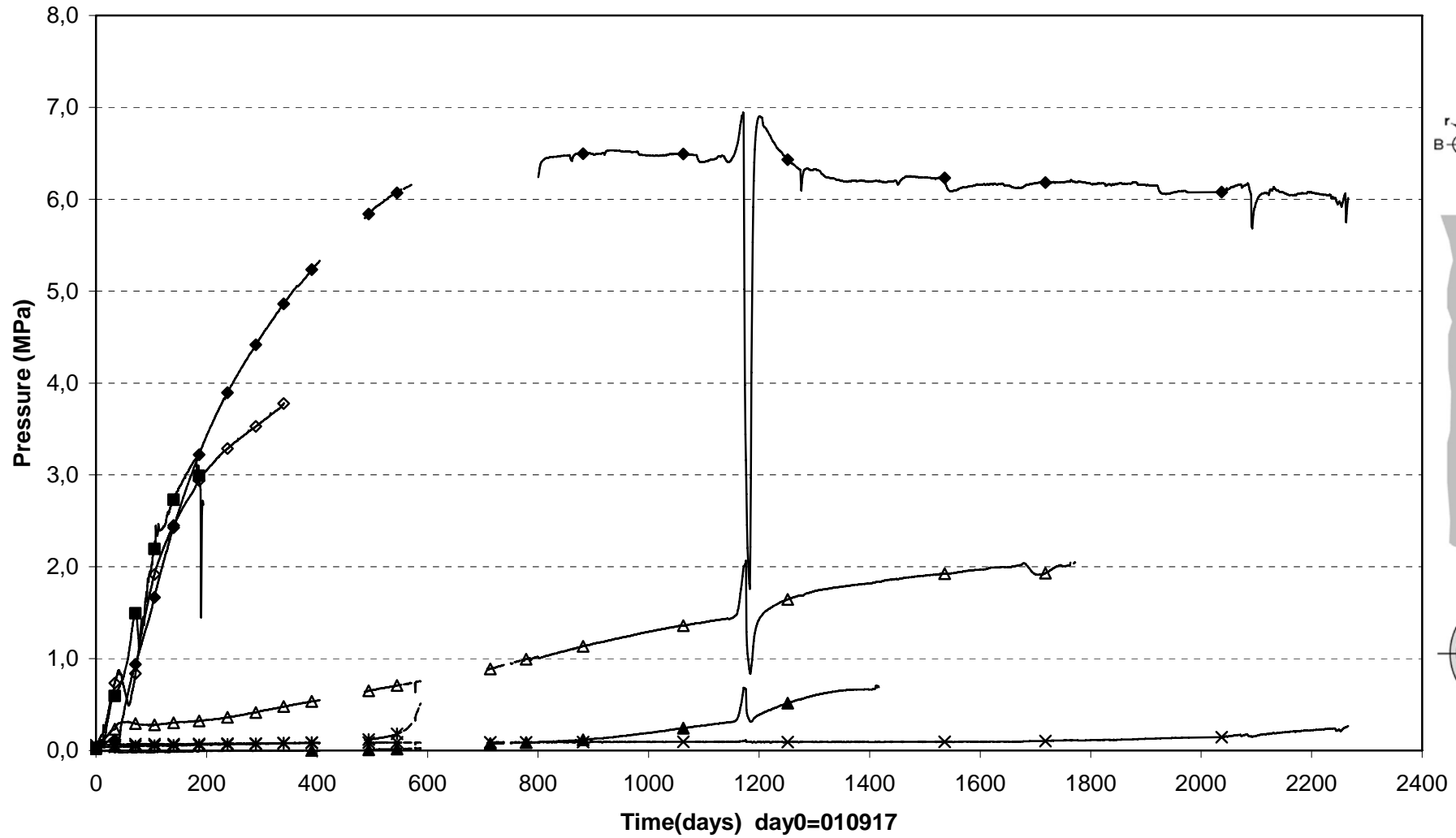

■ PBU10004(0.504\5°\0.685)    ◇ PBU10005(0.504\5°\0.785)    ◆ PBU10012(3.030\5°\0.785)    ▲ PBU10019(5.558\5°\0.685)  
 △ PBU10020(5.558\5°\0.785)    × PBU10025(6.317\0°\0.050)    \* PBU10027(7.076\0°\0.050)

Prototype\Hole 1\Cyl.1 (010917-071201)  
Relative humidity - Vaisala

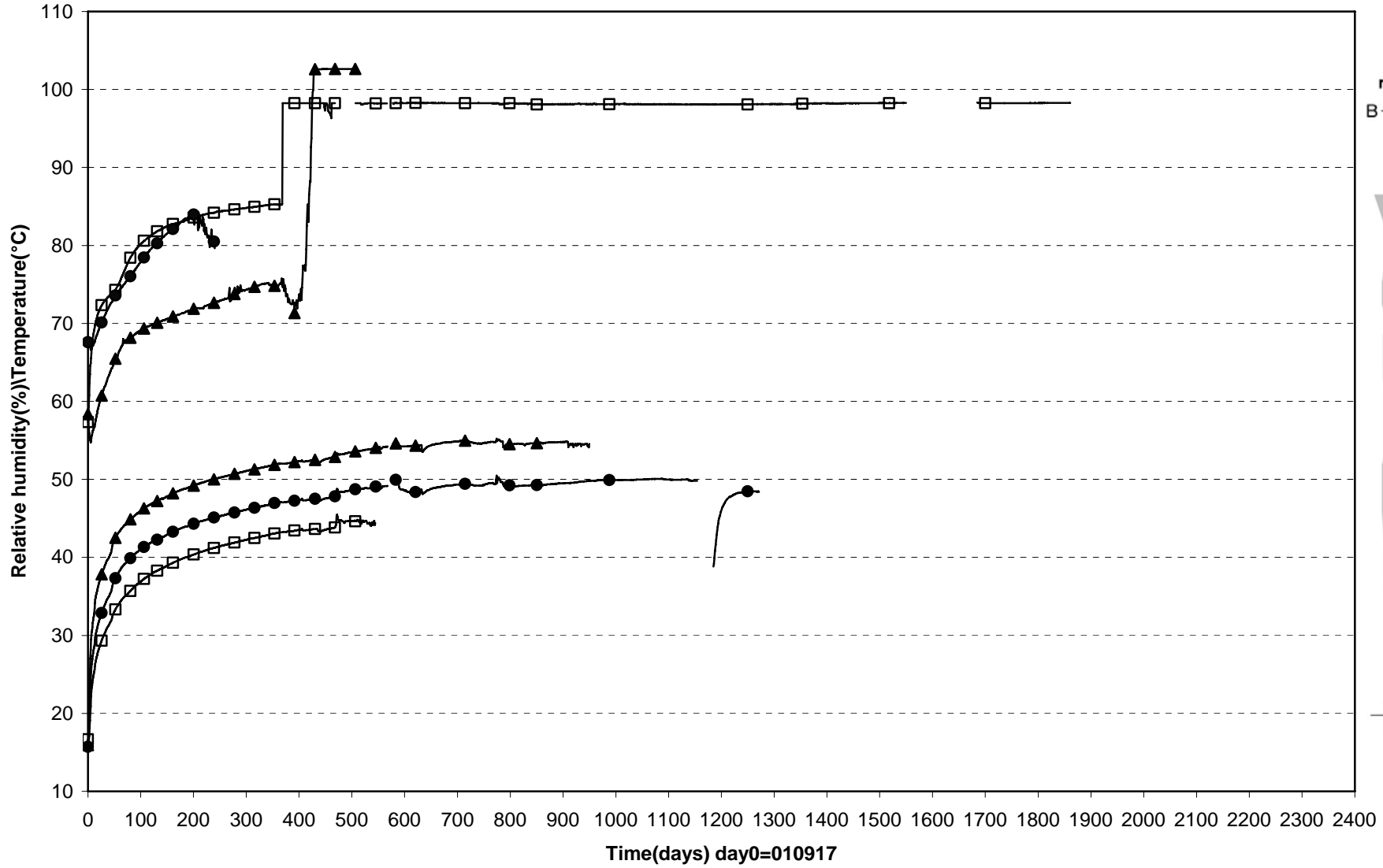

□ WBU10004(0.344\350°\0.785)    ● WBU10005(0.344\350°\0.685)    ▲ WBU10006(0.344\350°\0.585)

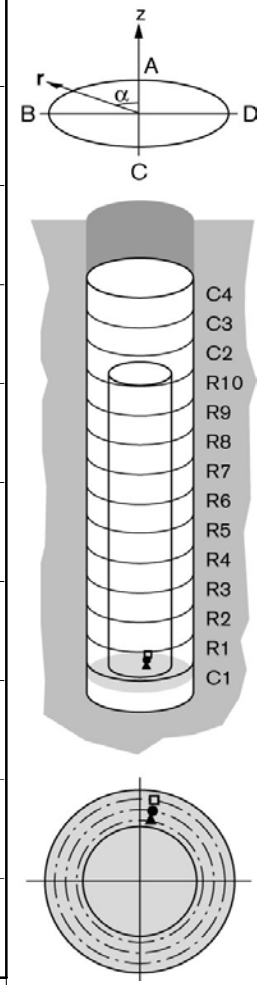

Prototype\Hole 1\Ring.5 (010917-071201)  
Relative humidity - Vaisala

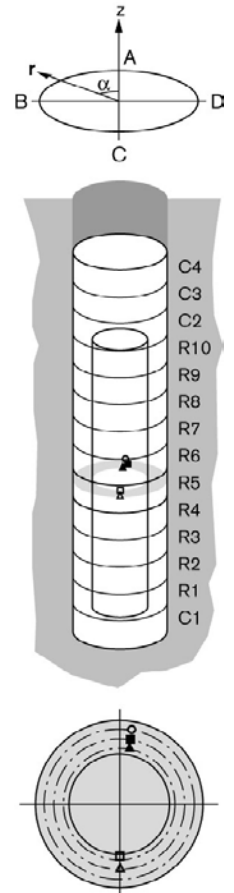
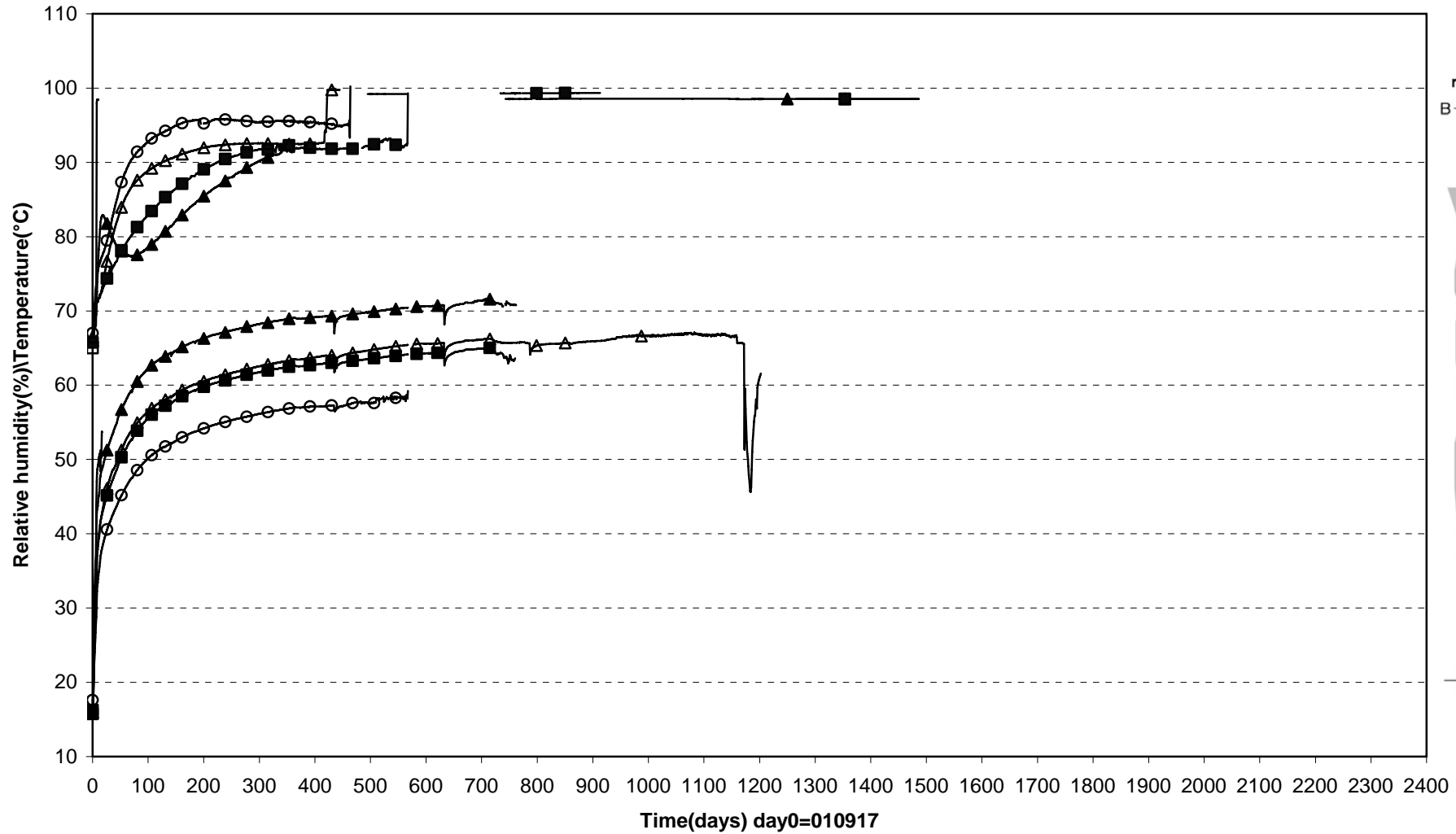

|  |                              |                              |
|--|------------------------------|------------------------------|
| ▲ WBU10013(2.870\350°\0.585)             | ■ WBU10014(2.870\350°\0.685) | ○ WBU10015(2.870\350°\0.785) |
| □ WBU10019(2.870\180°\0.535\In the slot) | △ WBU10020(2.870\180°\0.685) |                              |

Prototype\Hole 1\Ring10 (010917-071201)  
Relative humidity - Vaisala

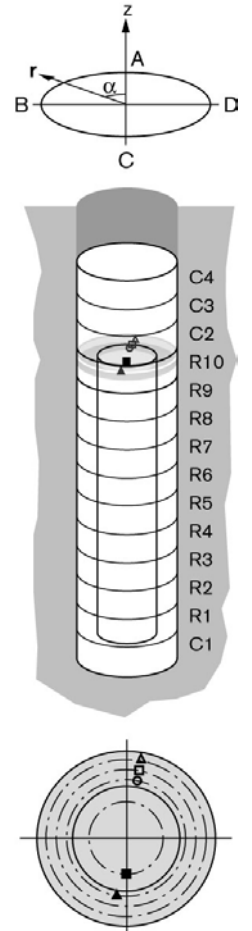
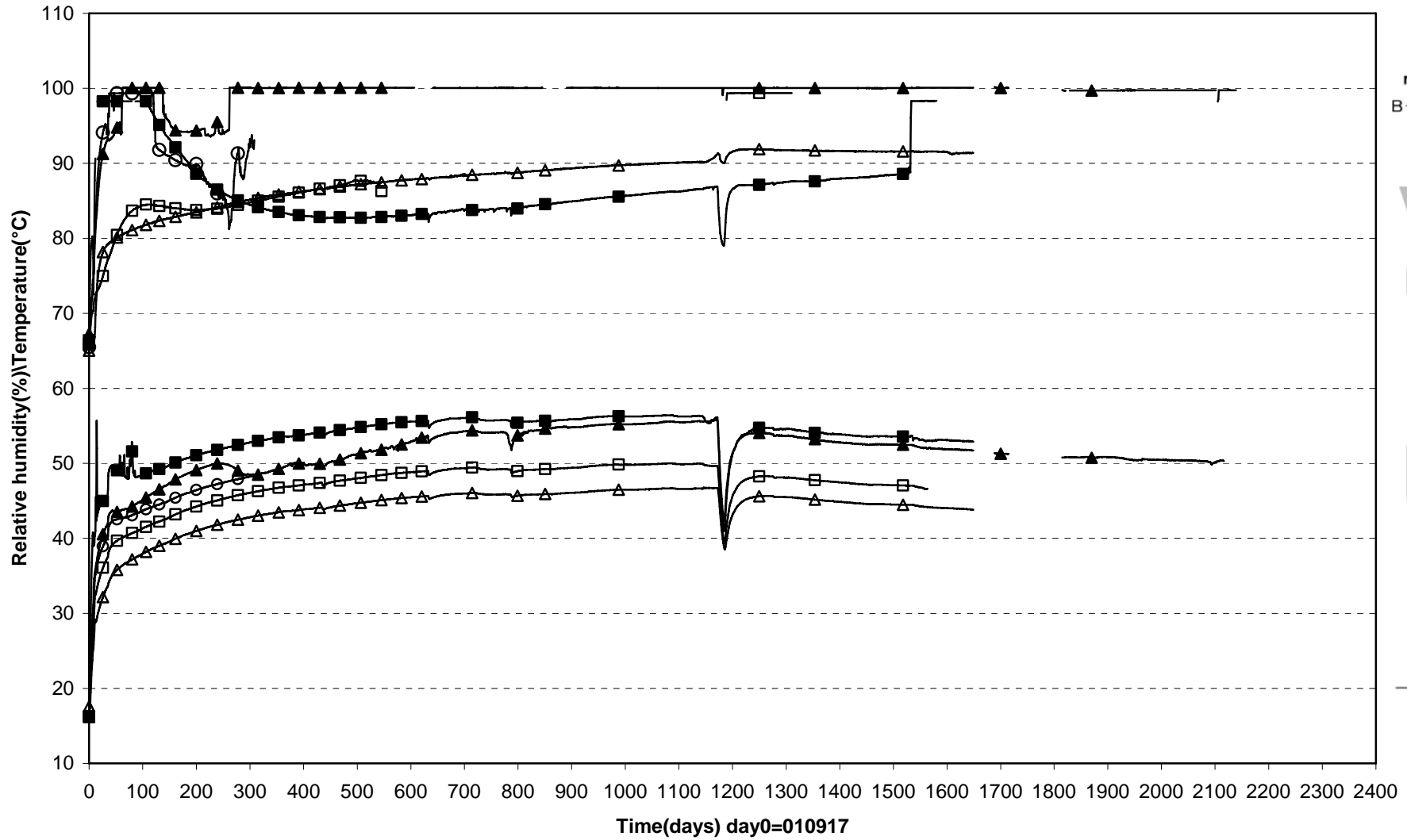

■ WBU10023(5.428\180°\0.362) ○ WBU10024(5.398\350°\0.585) □ WBU10025(5.398\350°\0.685) △ WBU10026(5.398\350°\0.785) ▲ WBU10030(5.398\170°\0.585)

Prototype\Hole 1\Cyl.3 and Cyl.4 (010917-0701201)  
Relative humidity - Vaisala

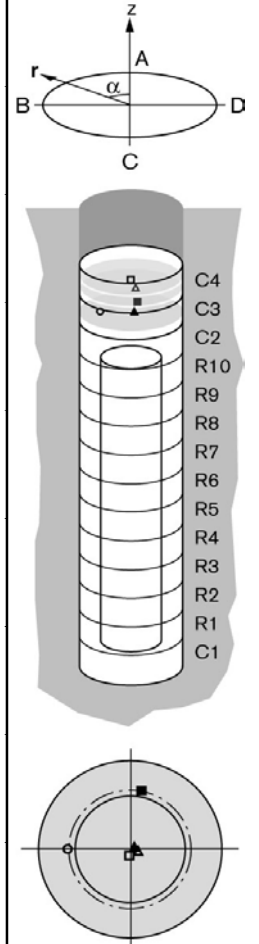
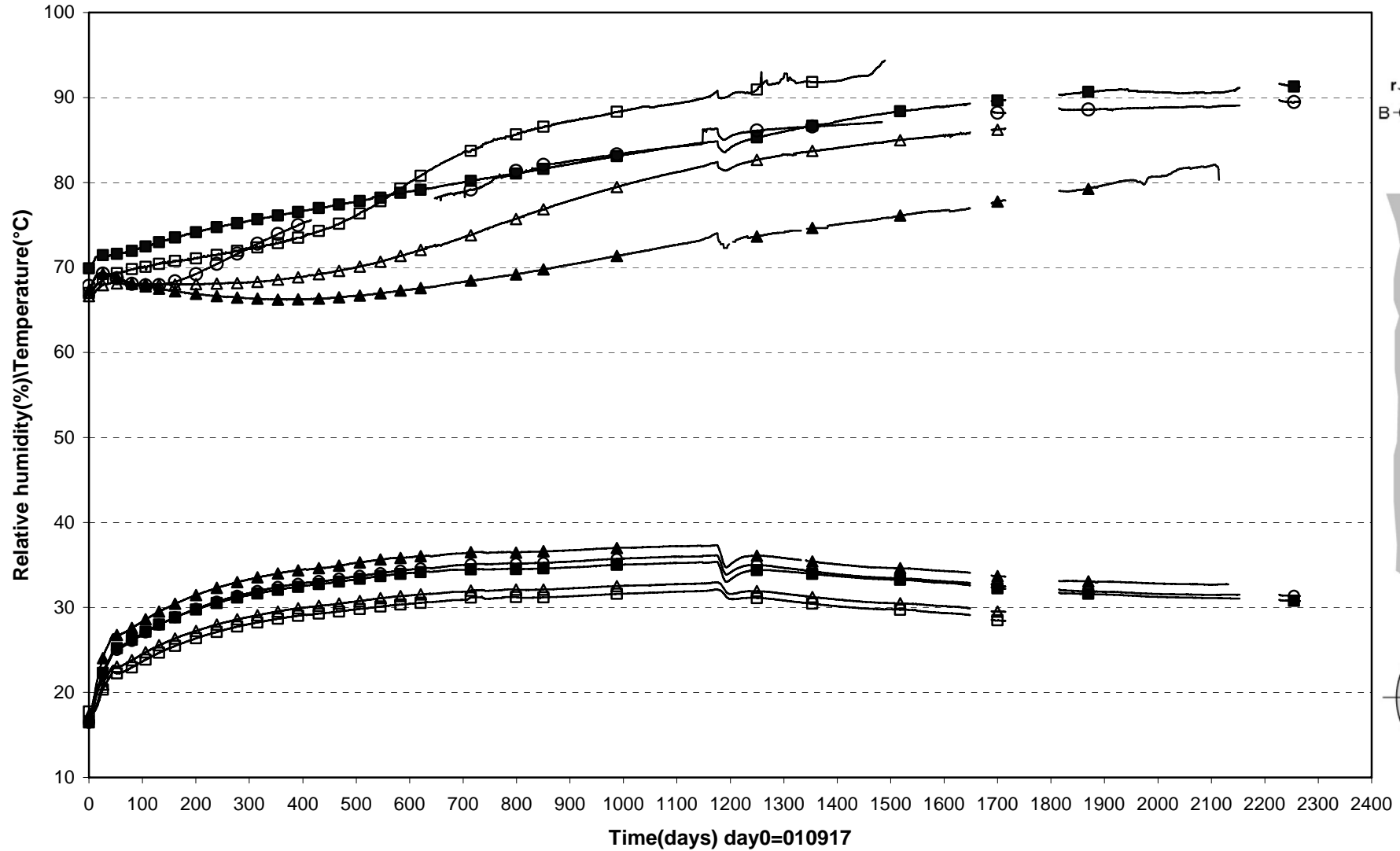

▲ WBU10032(6.317\270°\0.050) ■ WBU10033(6.317\350°\0.585) ○ WBU10034(6.317\90°\0.585) □ WBU10036(6.916\180°\0.050) △ WBU10037(6.756\270°\0.050)

Prototyp\Hole 1\Cyl.1 (010917-071201)  
Relative humidity - Rotronic

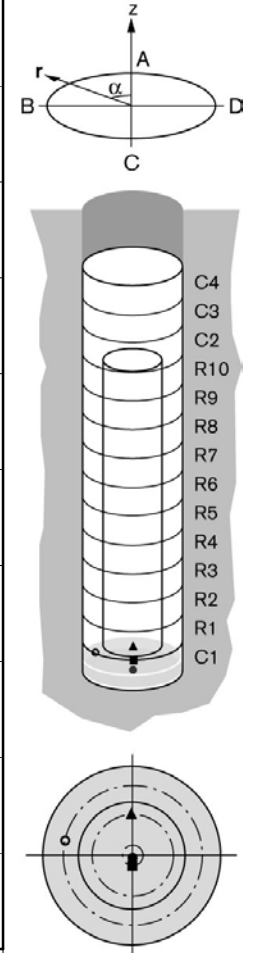
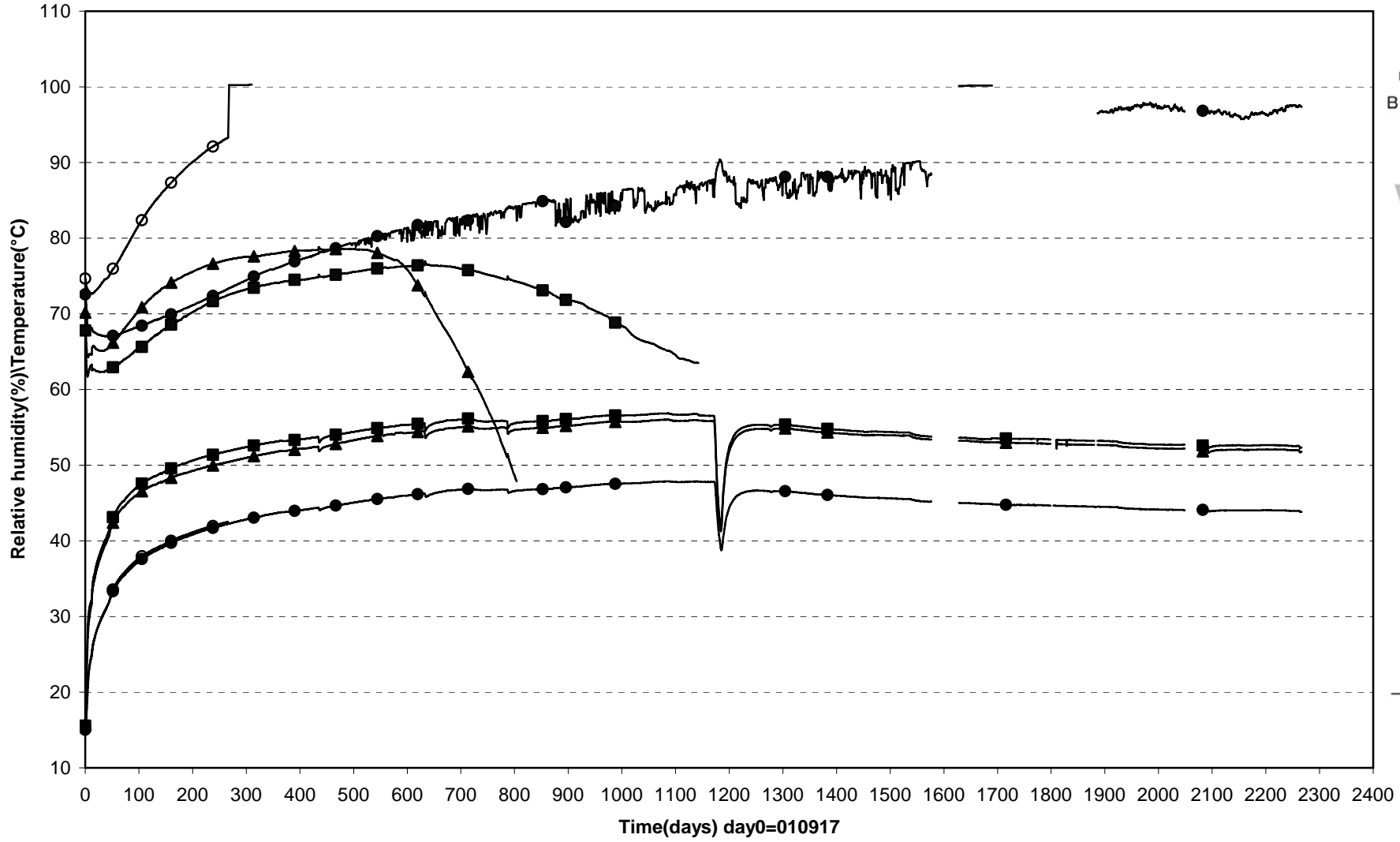

● WBU10001 (0.054\180°\0.050) ▲ WBU10002 (0.254\0°\0.400) ■ WBU10003 (0.254\180°\0.100) ○ WBU10008(0.254\80°\0.685)

Prototyp\Hole 1\Cyl.1 (010917-071201)  
Relative humidity - Rotronic

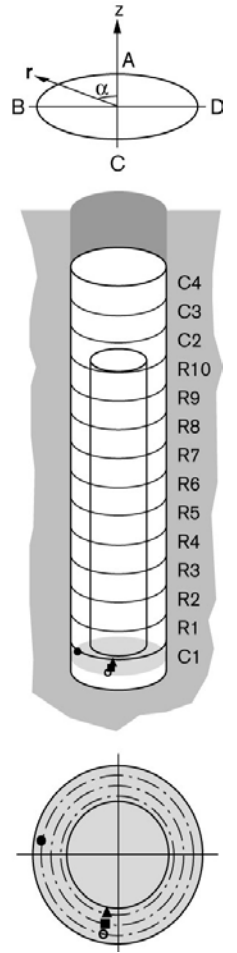
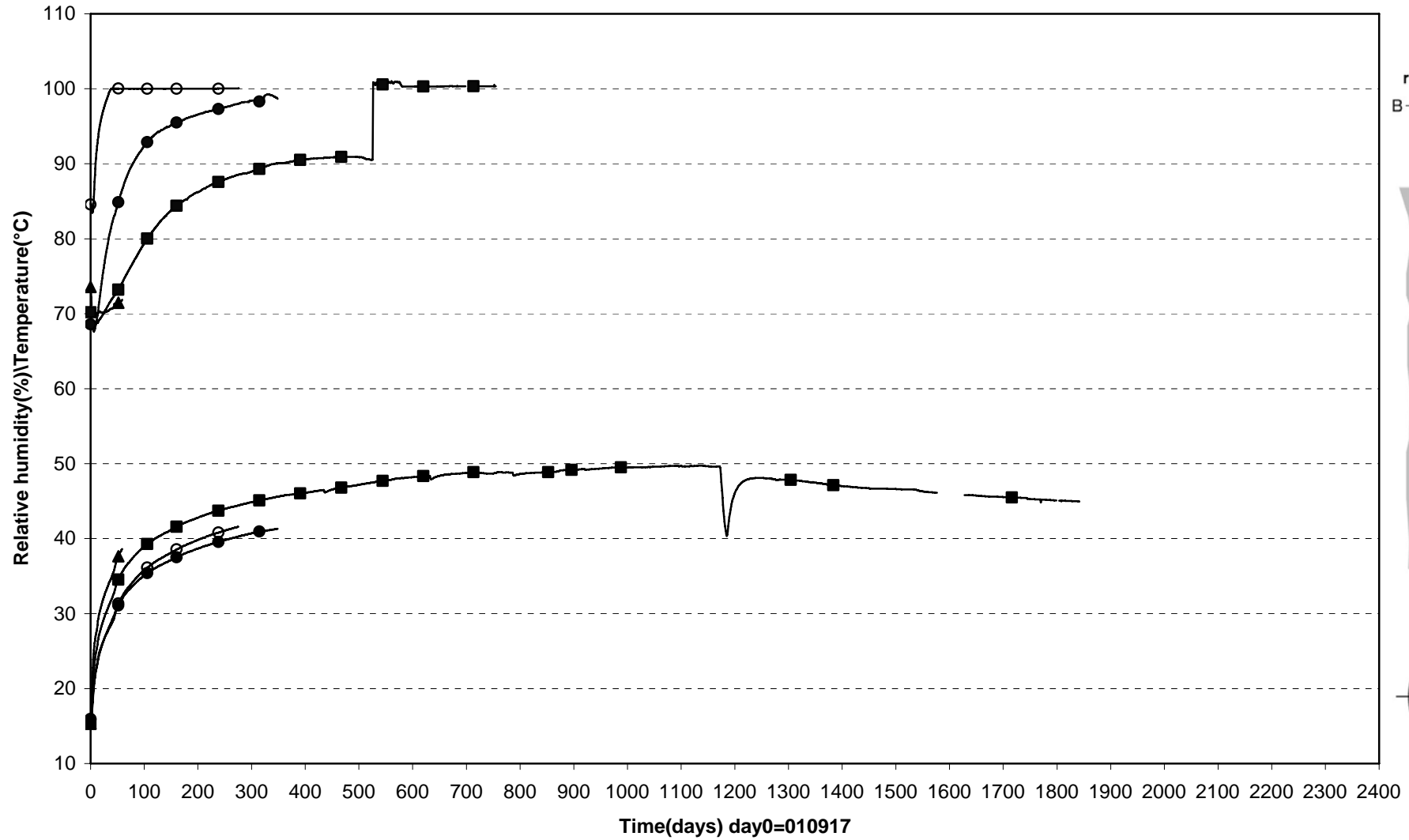



Prototyp\Hole 1\Ring.5 (010917-071201)  
 Relative humidity - Rotronic

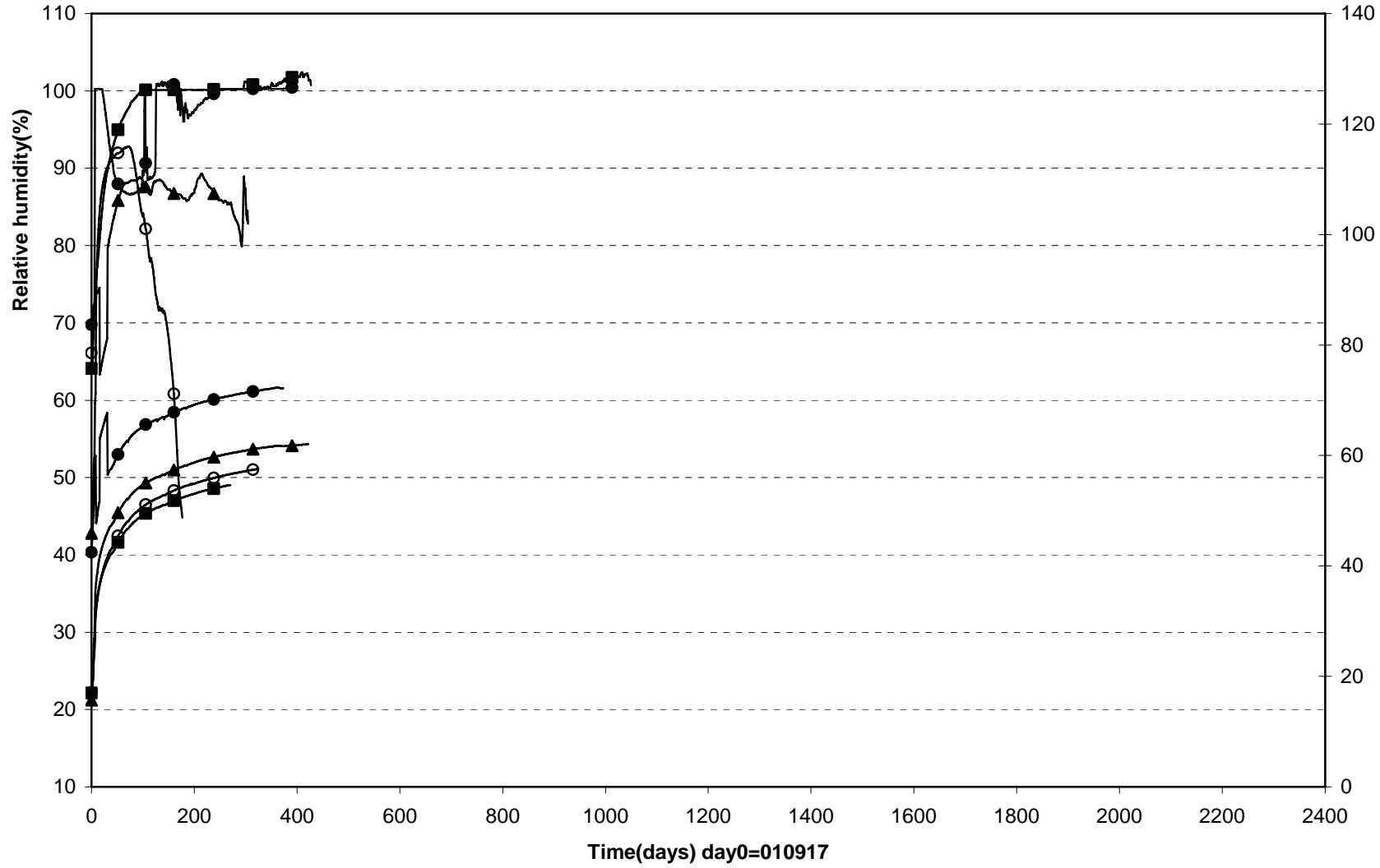

● WBU10016(2.780\80°\0.535) ▲ WBU10017(2.780\80°\0.685) ■ WBU10018(2.780\80°\0.785) ○ WBU10021(2.780\180°\0.785)

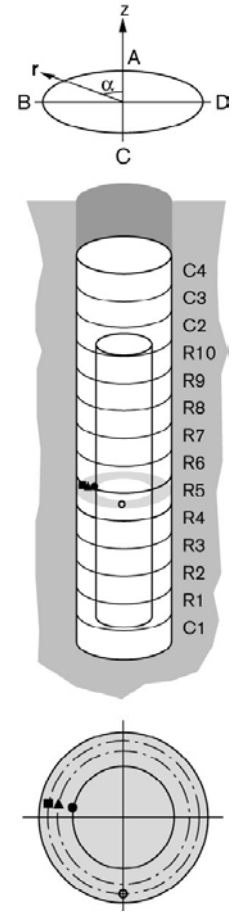

Prototyp\Hole 1\Ring10 (010917-071201)  
 Relative humidity - Rotronic

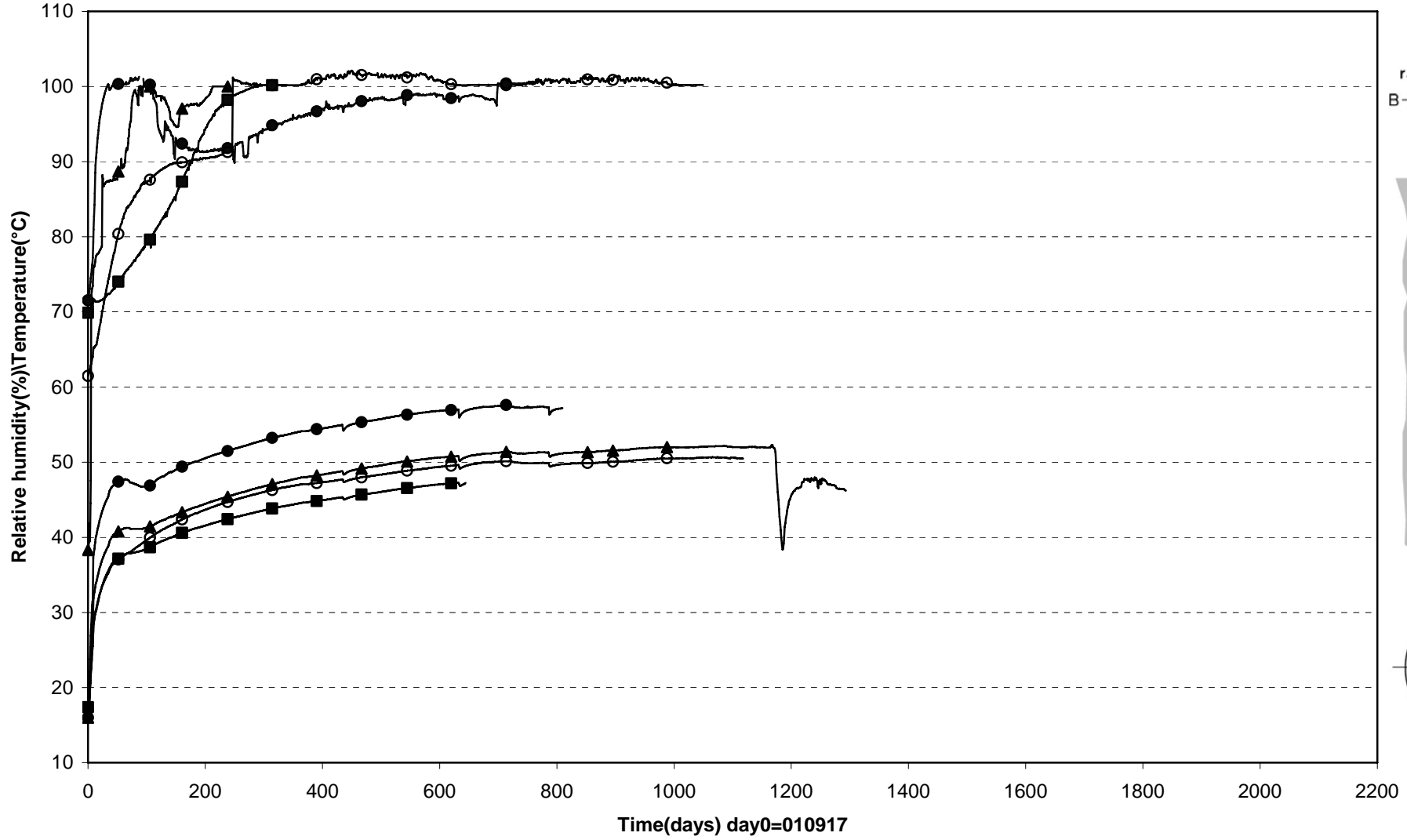

● WBU10027(5.308\80°\0.585) ▲ WBU10028(5.308\80°\0.685) ■ WBU10029(5.308\80°\0.785) ○ WBU10031(5.308\170°\0.785)

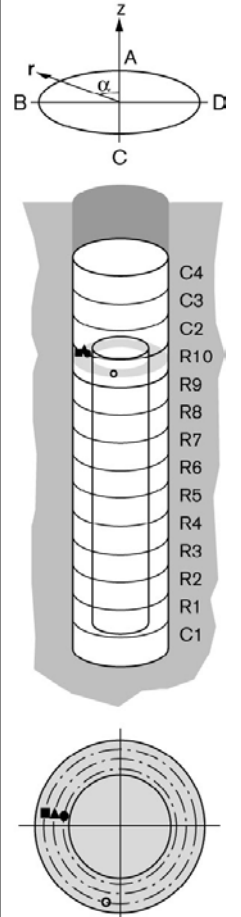

Prototyp\Hole 1\Cyl.3 (010917-071201)  
 Relative humidity - Rotronic

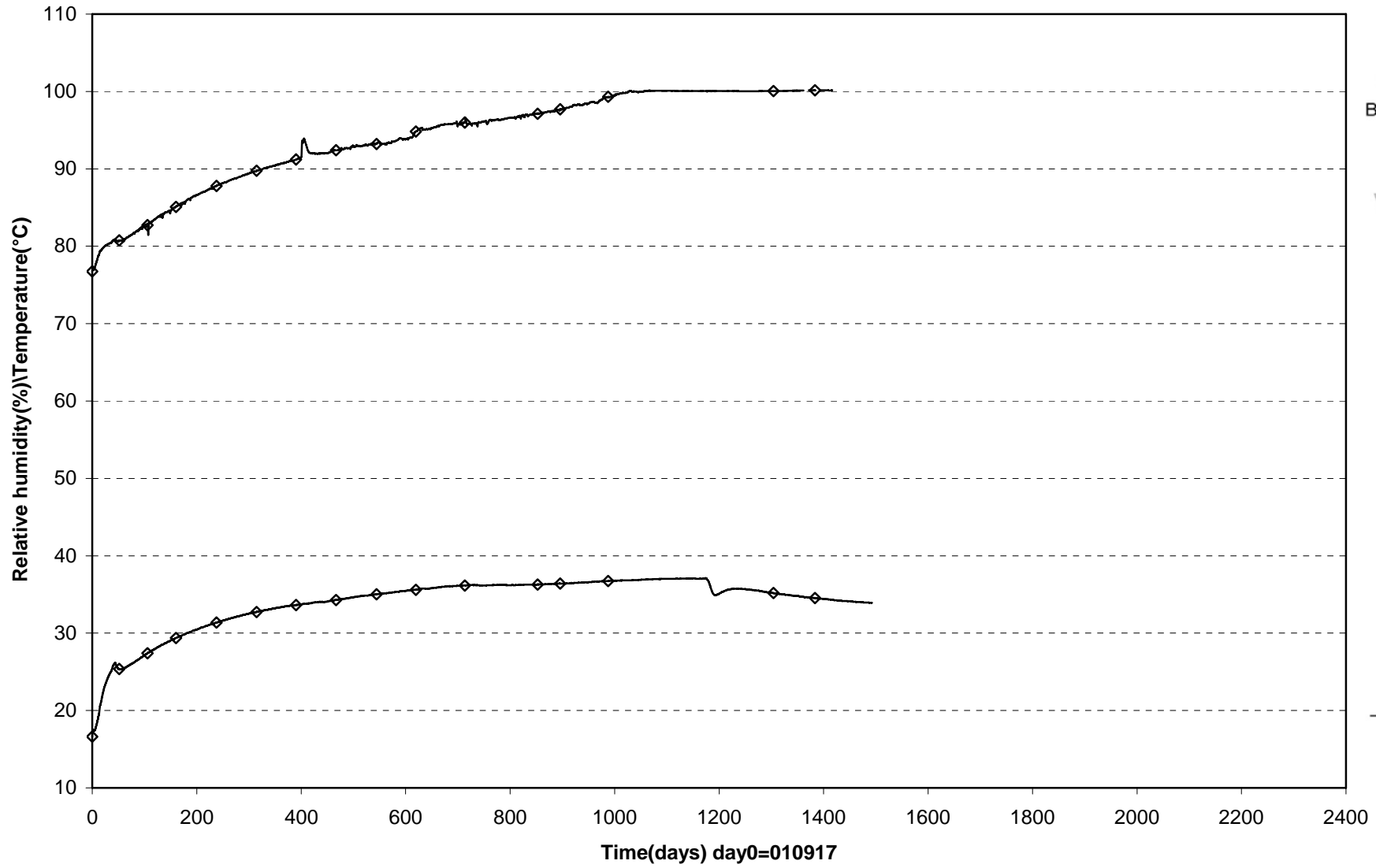

◇ WBU10035(6.317\180°\0.585)

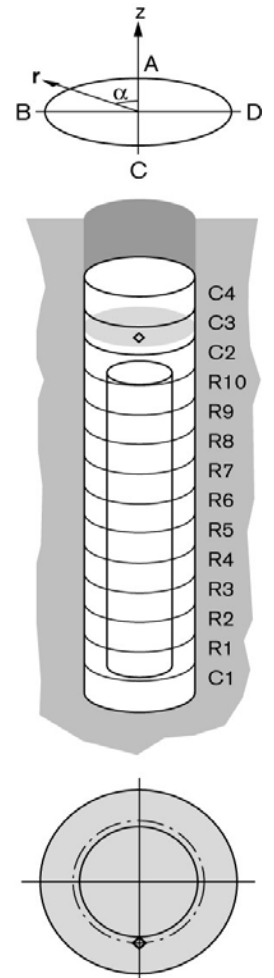

Prototype\Hole 1 (010917-071201)  
Pore pressure - Geokon

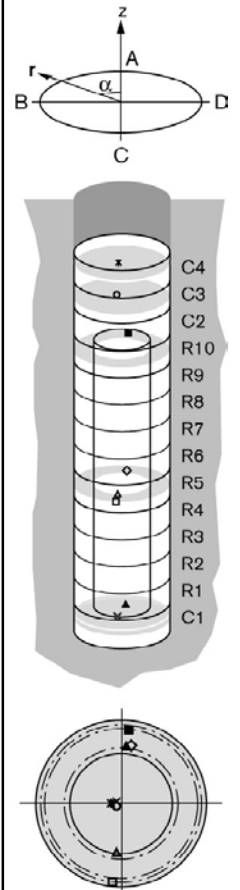
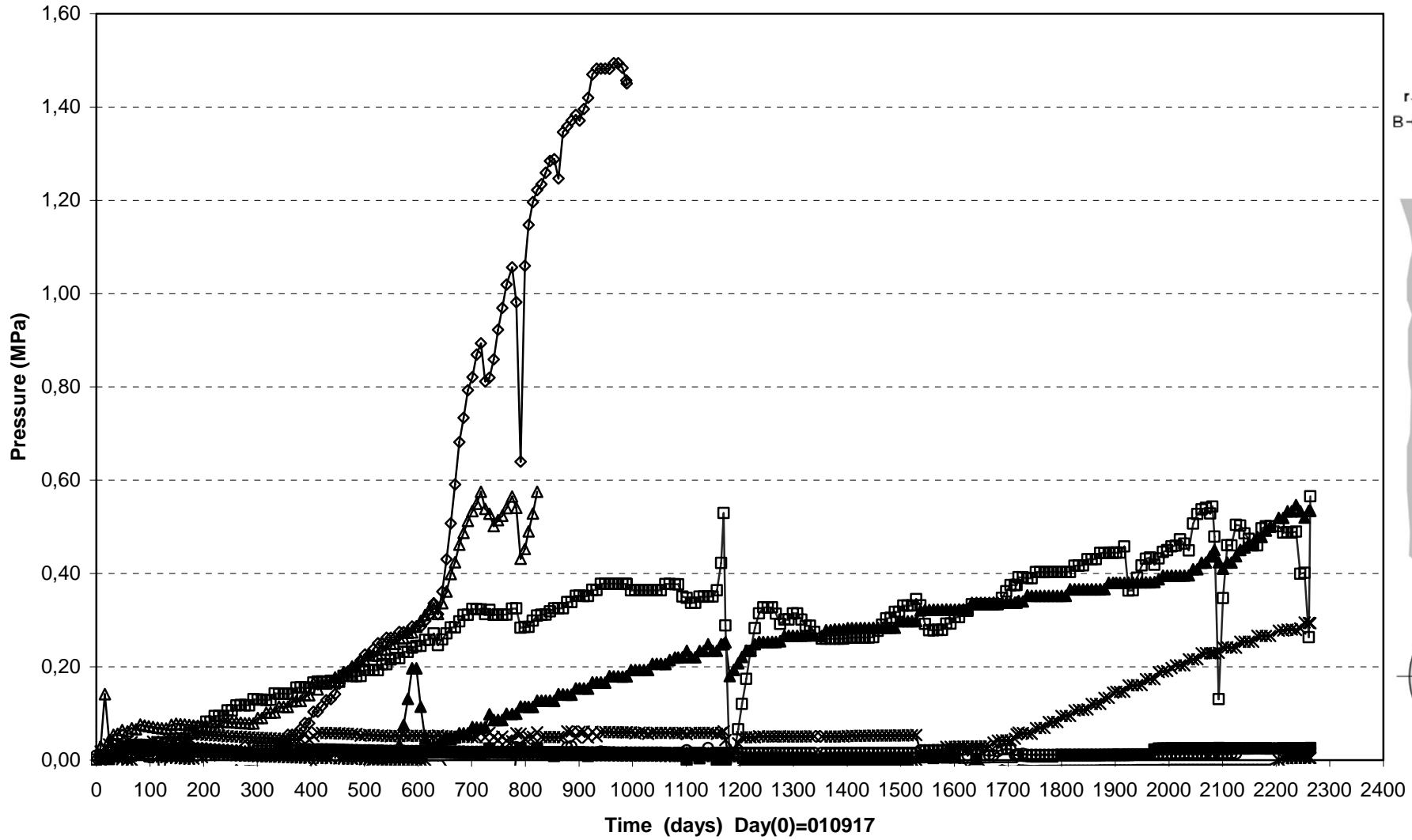

|                                |                                |                                |                                |
|--------------------------------|--------------------------------|--------------------------------|--------------------------------|
| —x— UBU10002(0.254\90°\0.100)  | —▲— UBU10003(0.344\355°\0.585) | —◇— UBU10005(2.780\355°\0.585) | —△— UBU10009(2.780\175°\0.535) |
| —□— UBU10010(2.780\175°\0.825) | —■— UBU10012(5.308\355°\0.785) | —○— UBU10013(6.317\90°\0.050)  | —*— UBU10014(6.916\90°\0.050)  |

Prototype\ Hole 1 (010917-071201)  
Pore pressure - Kulite

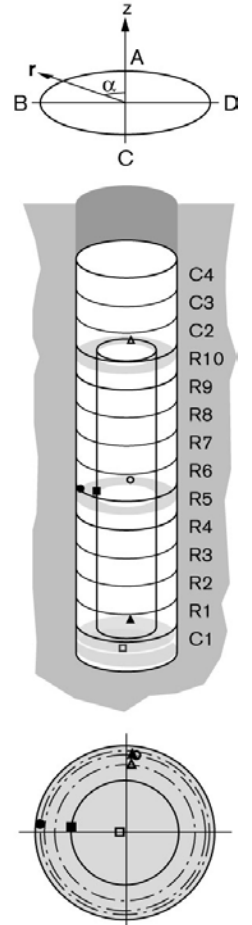
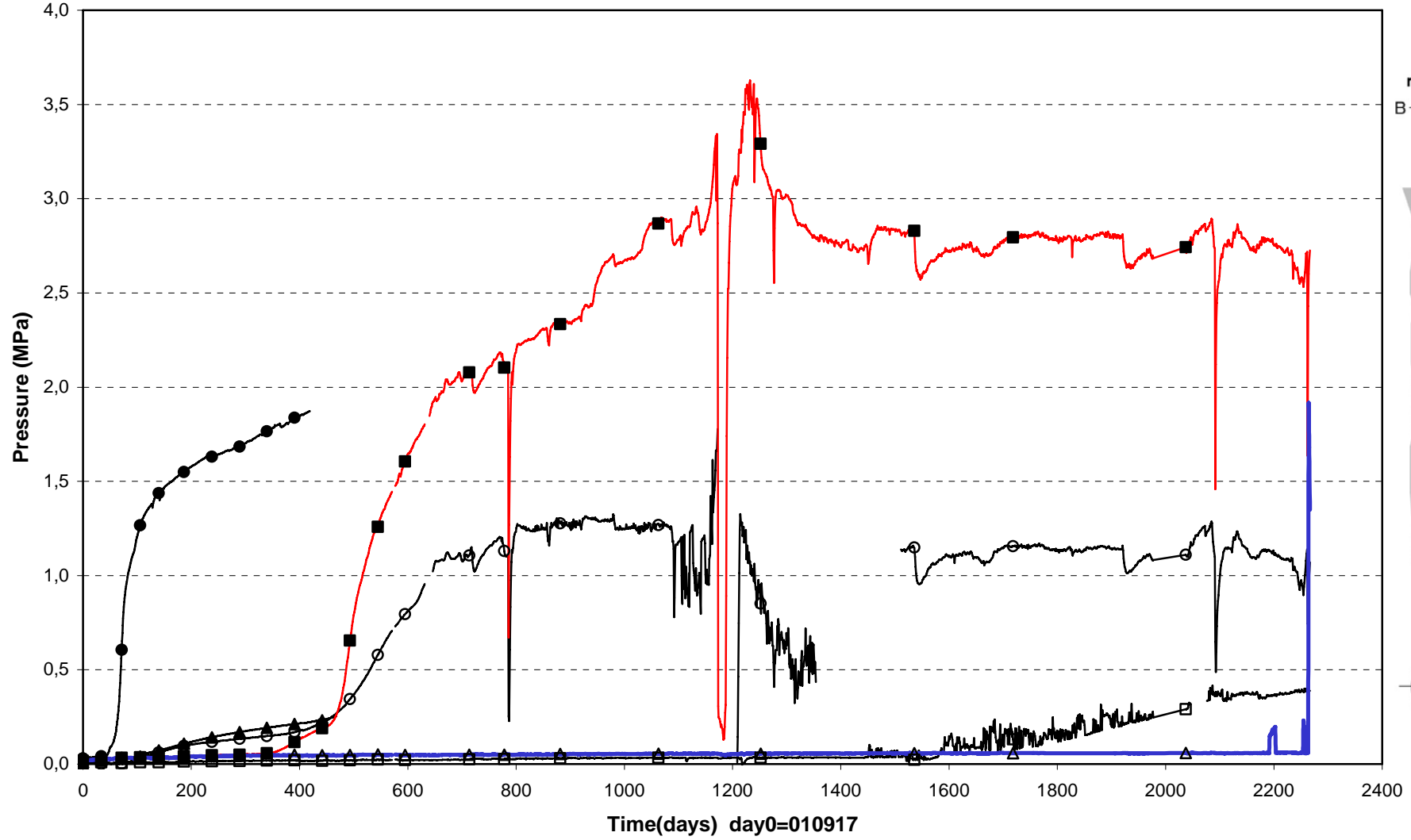

- |   |   |                              |
|---|---|------------------------------|
| □ UBU10001(0.054\90°\0.050)             | ▲ UBU10004(0.344\355°\0.785)            | ○ UBU10006(2.870\355°\0.785) |
| ■ UBU10007(2.870\85°\0.535\In the slot) | ● UBU10008(2.870\85°\0.825\In the slot) | △ UBU10011(5.398\355°\0.585) |

Prototype\Hole 1\Cyl.1 (010917-071201)  
 Temperature - Pentronic

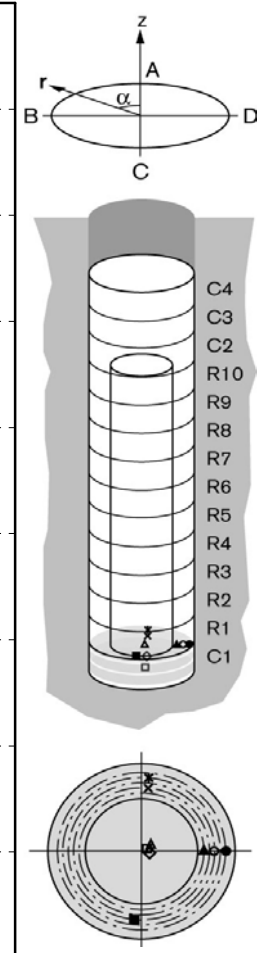
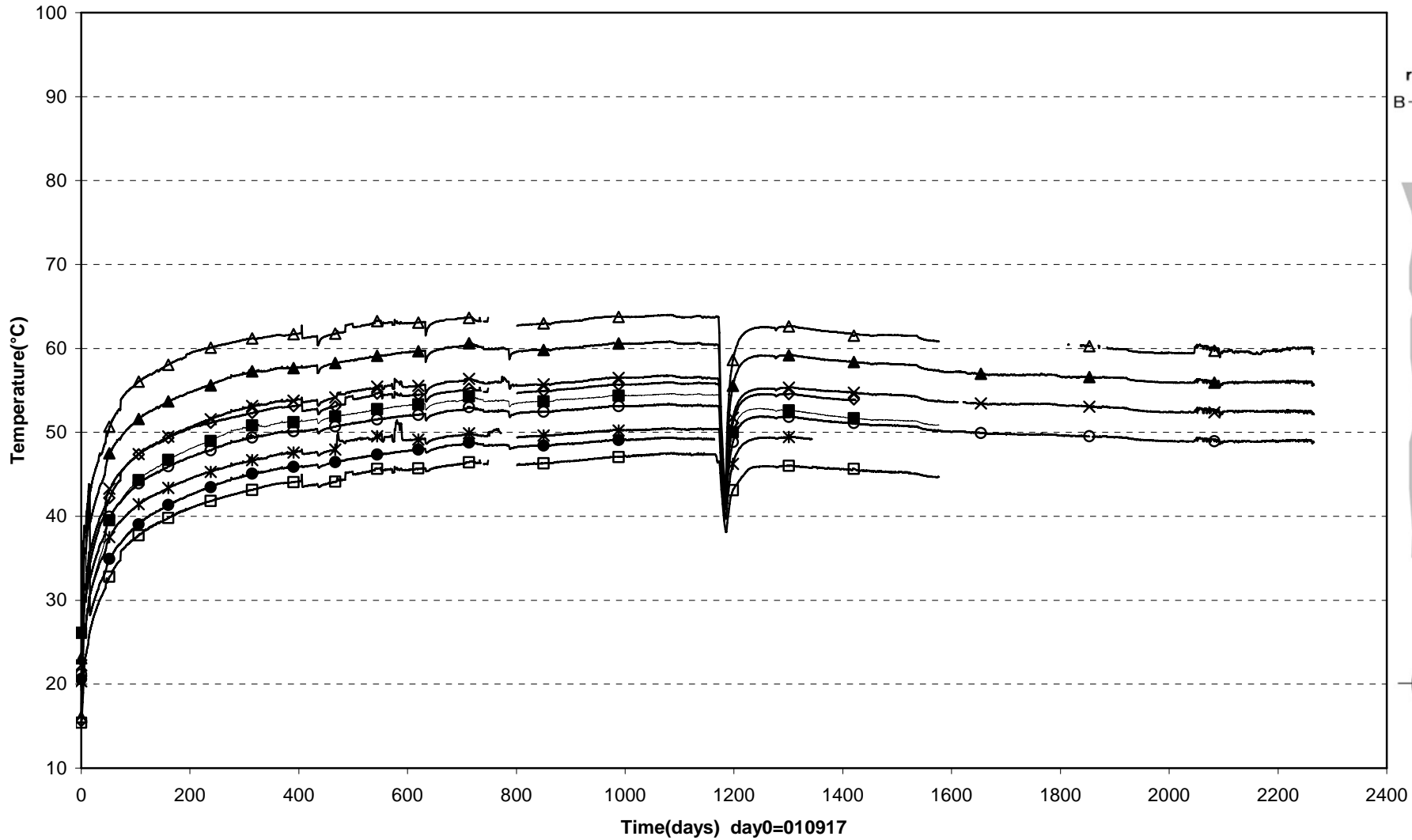

- TBU10001(0.054\270°\50)    ◇ TBU10002(0.254\270°\0.050)    ▲ TBU10003(0.454\270°\0.050)    × TBU10004(0.454\355°\0.635)    ✱ TBU10005(0.454\355°\0.735)
- TBU10007(0.454\175°\0.685)    ▲ TBU10008(0.454\270°\0.585)    ○ TBU10009(0.454\270°\0.685)    ● TBU10010(0.454\270°\0.785)

Prototype\Hole 1 \Ring5 (010917-071201)  
 Temperature - Pentronic

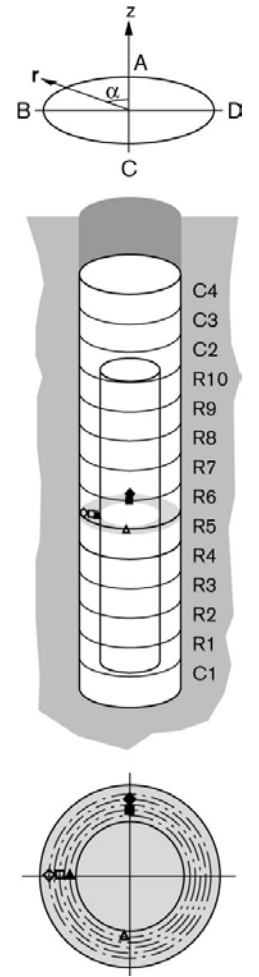
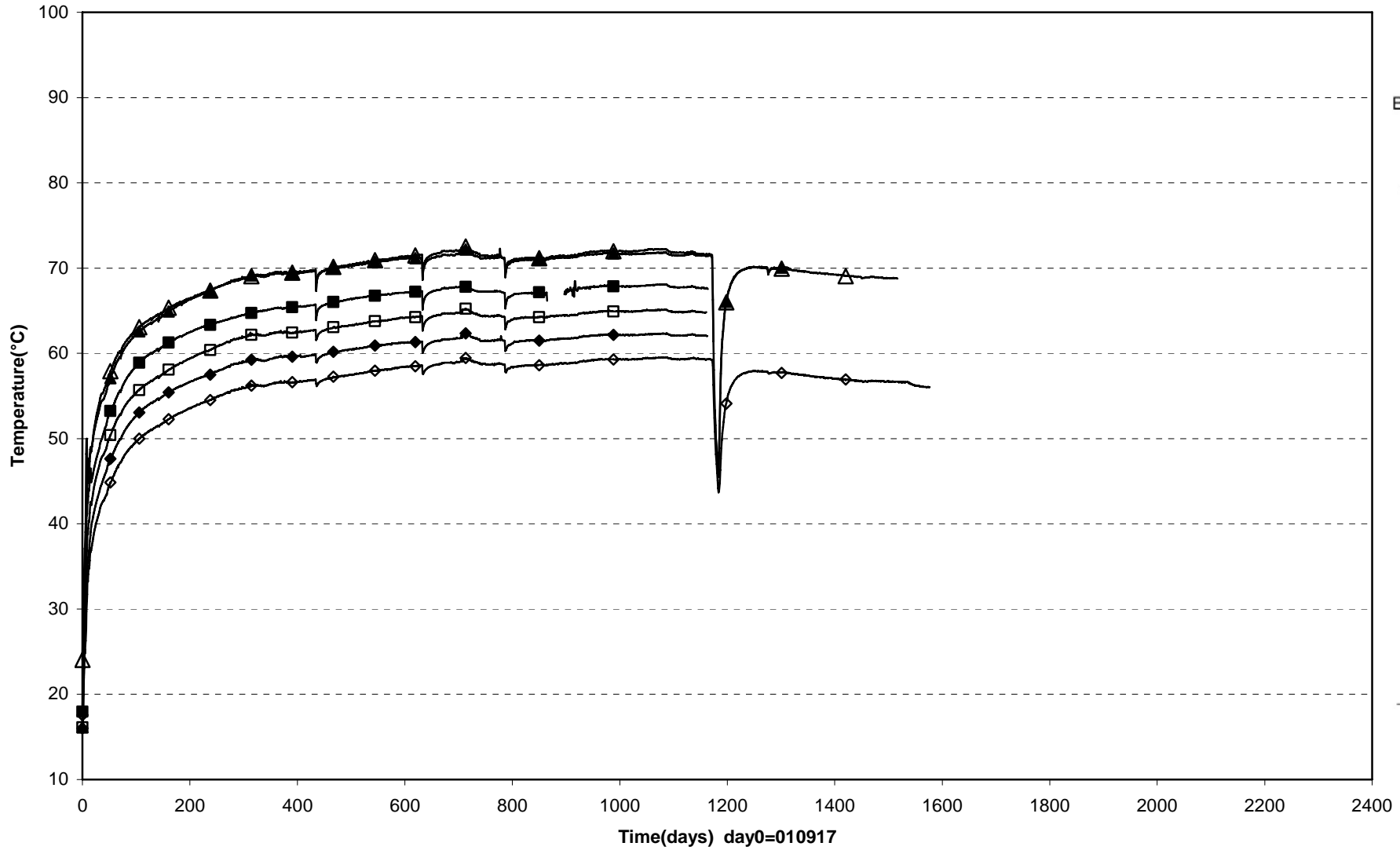

|                             |                             |                              |
|-----------------------------|-----------------------------|------------------------------|
| ■ TBU10011(2.980\0°\0.635)  | ◆ TBU10012(2.980\0°\0.735)  | ▲ TBU10013(2.980\90°\0.585)  |
| □ TBU10014(2.980\90°\0.685) | ◇ TBU10015(2.980\90°\0.785) | △ TBU10016(2.980\175°\0.585) |

Prototype\Hole 1 \Ring5 (010917-071201)  
 Temperature - Pentronic

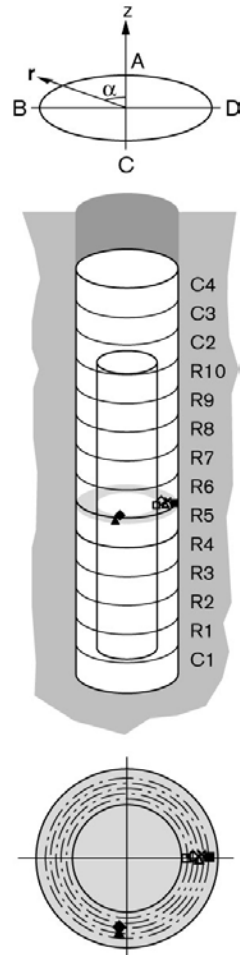
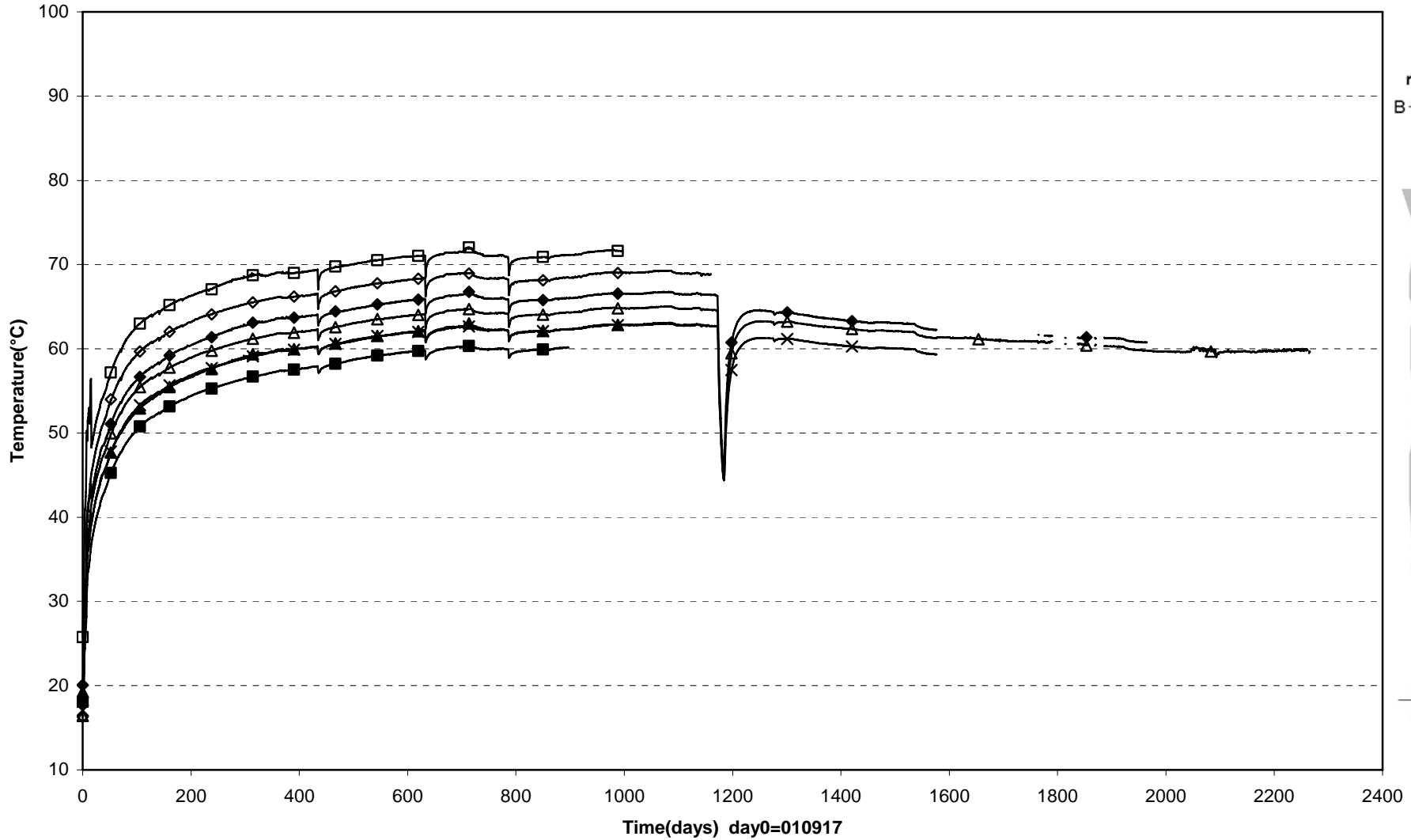

◆ TBU10017(2.980\175°\0.685) ▲ TBU10018(2.980\175°\0.735) □ TBU10019(2.980\270°\0.585) ◇ TBU10020(2.980\270°\0.635)  
 △ TBU10021(2.980\270°\0.685) × TBU10022(2.980\270°\0.735) ■ TBU10023(2.980\270°\0.785)



Prototype\Hole 1 \Ring10 (010917-071201)  
 Temperature - Pentronic

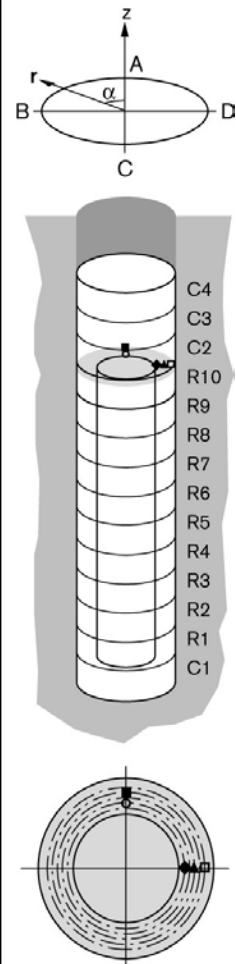
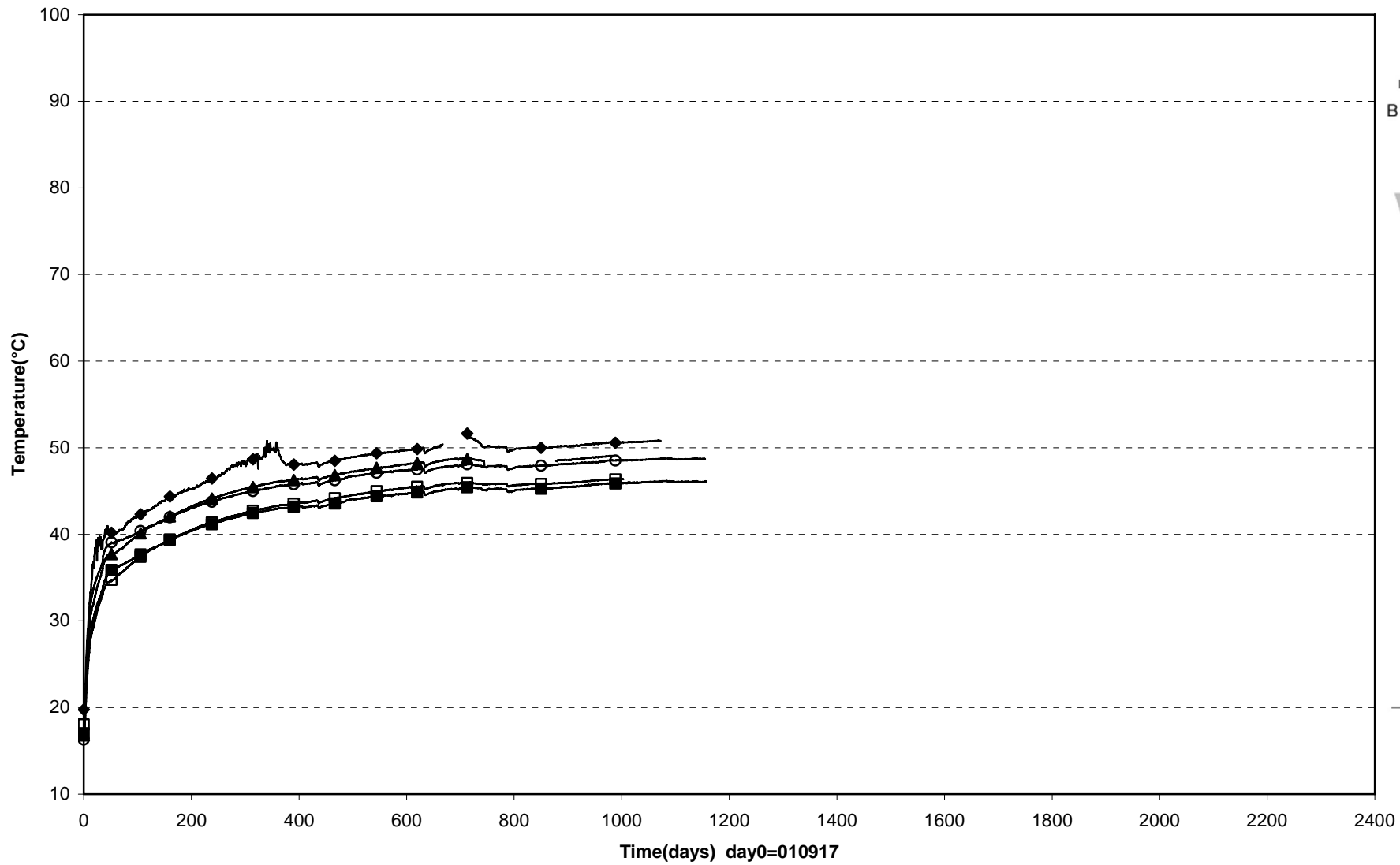

Prototype\Hole 1 \Cyl.3 and Cyl.4 (010917-071201)  
 Temperature - Pentronic

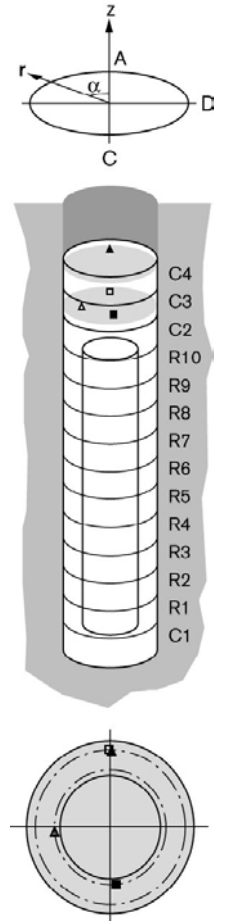
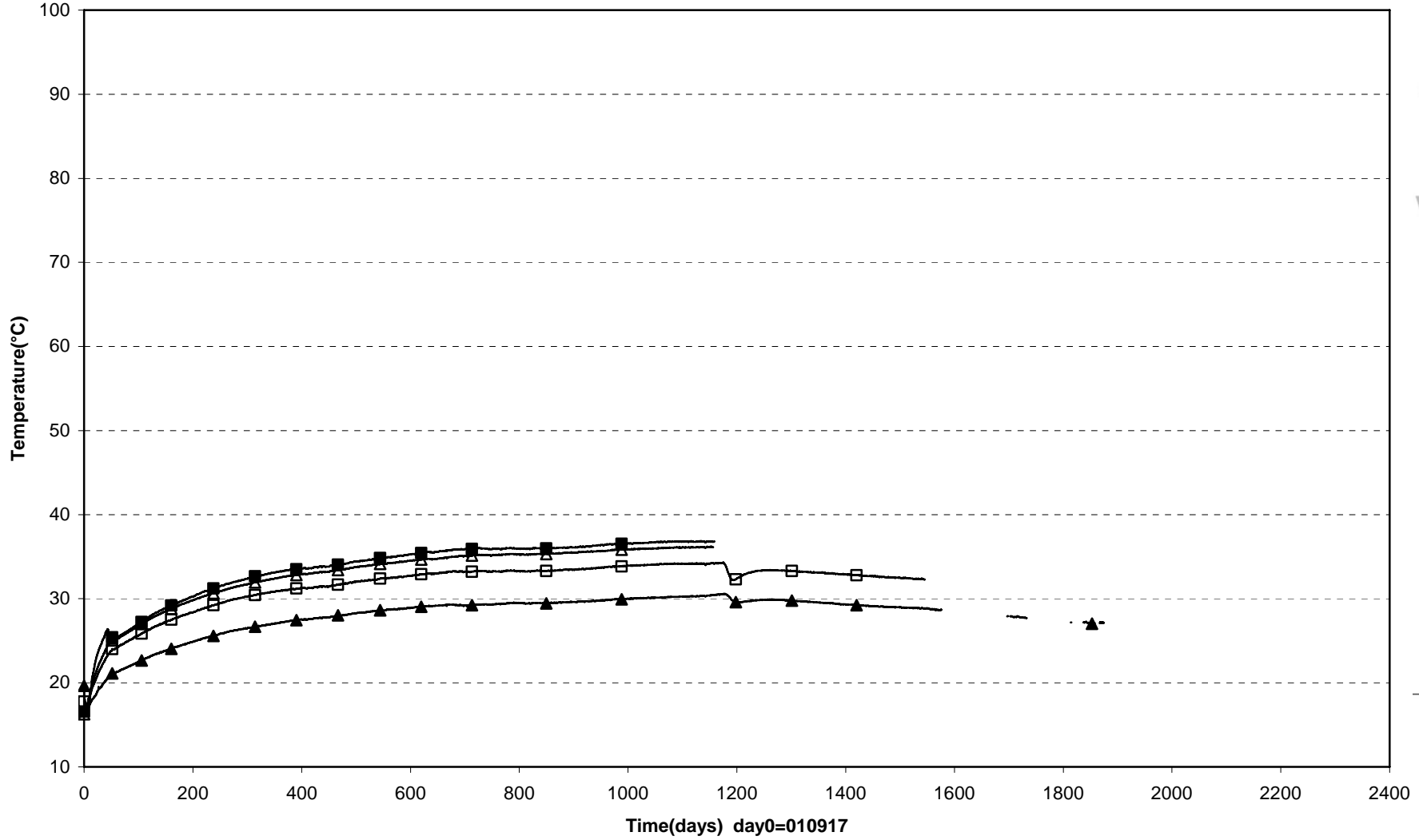

□ TBU10029(6.317\0°\0.785)    △ TBU10030(6.317\95°\0.585)    ■ TBU10031(6.317\185°\0.585)    ▲ TBU10032(7.026\0°\0.785)

Prototype\Hole 1\Cyl.1 (010917-071201)  
 Temperature - Geokon

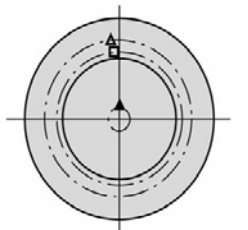
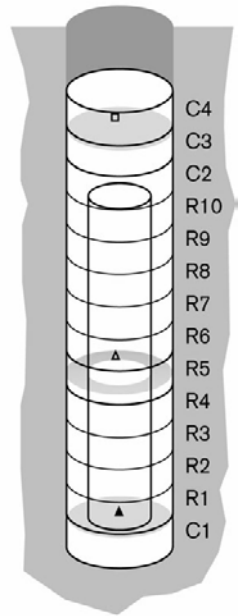
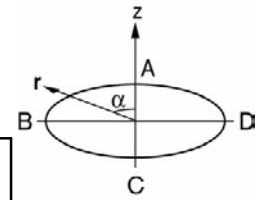
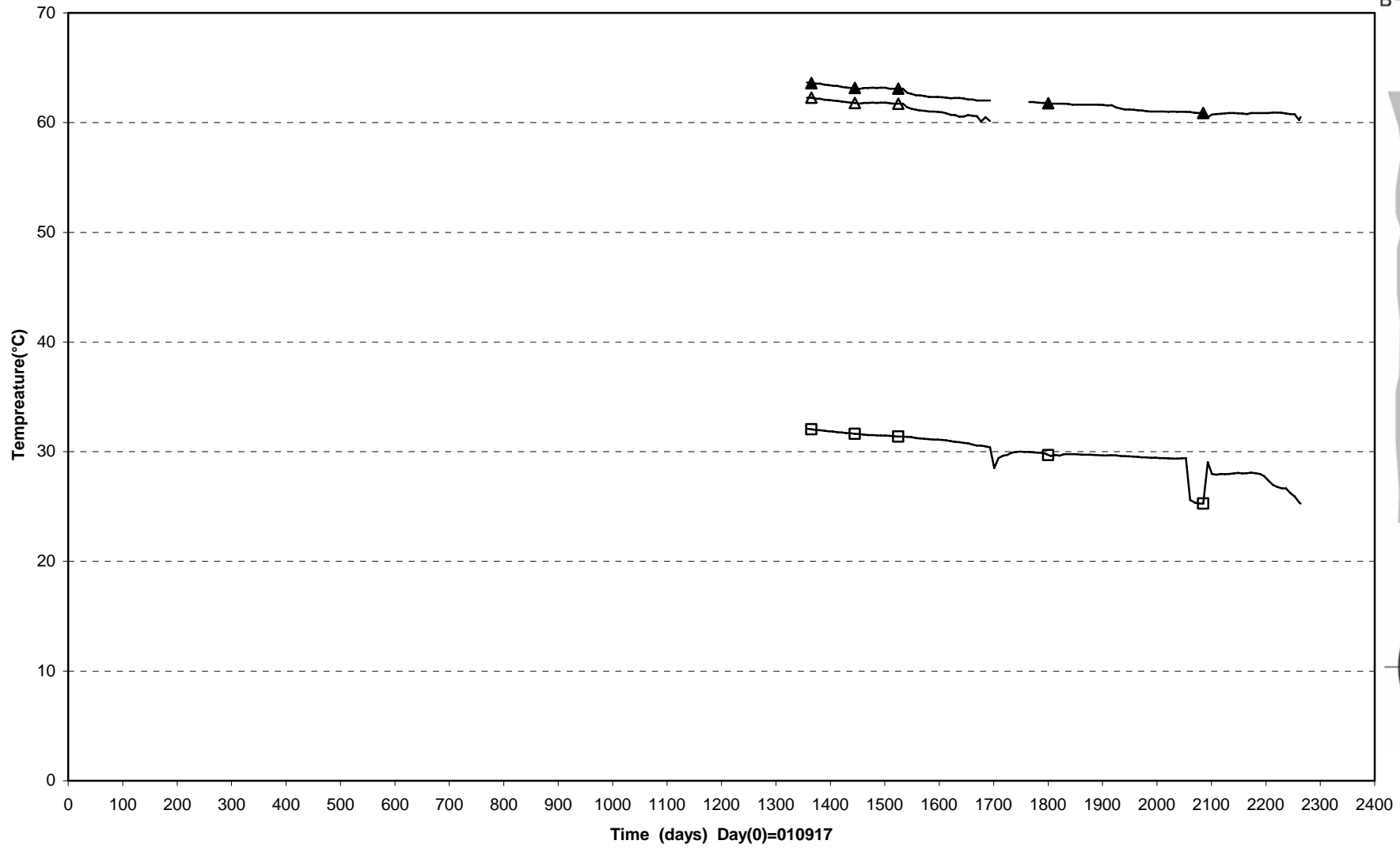

▲ PBU10002(0.504\0°\0.100) △ PBU10011(2.780\5°\0.685) □ PBU10026(6.567\5°\0.585)

Prototype\Hole 1 (010917-071201)  
 Temperature - Geokon

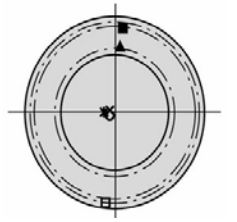
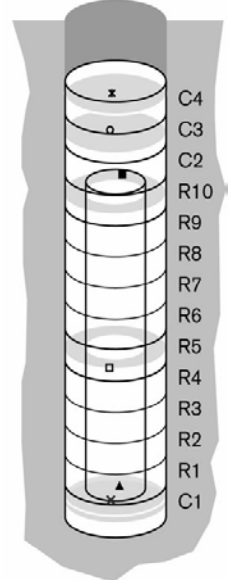
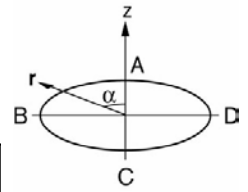
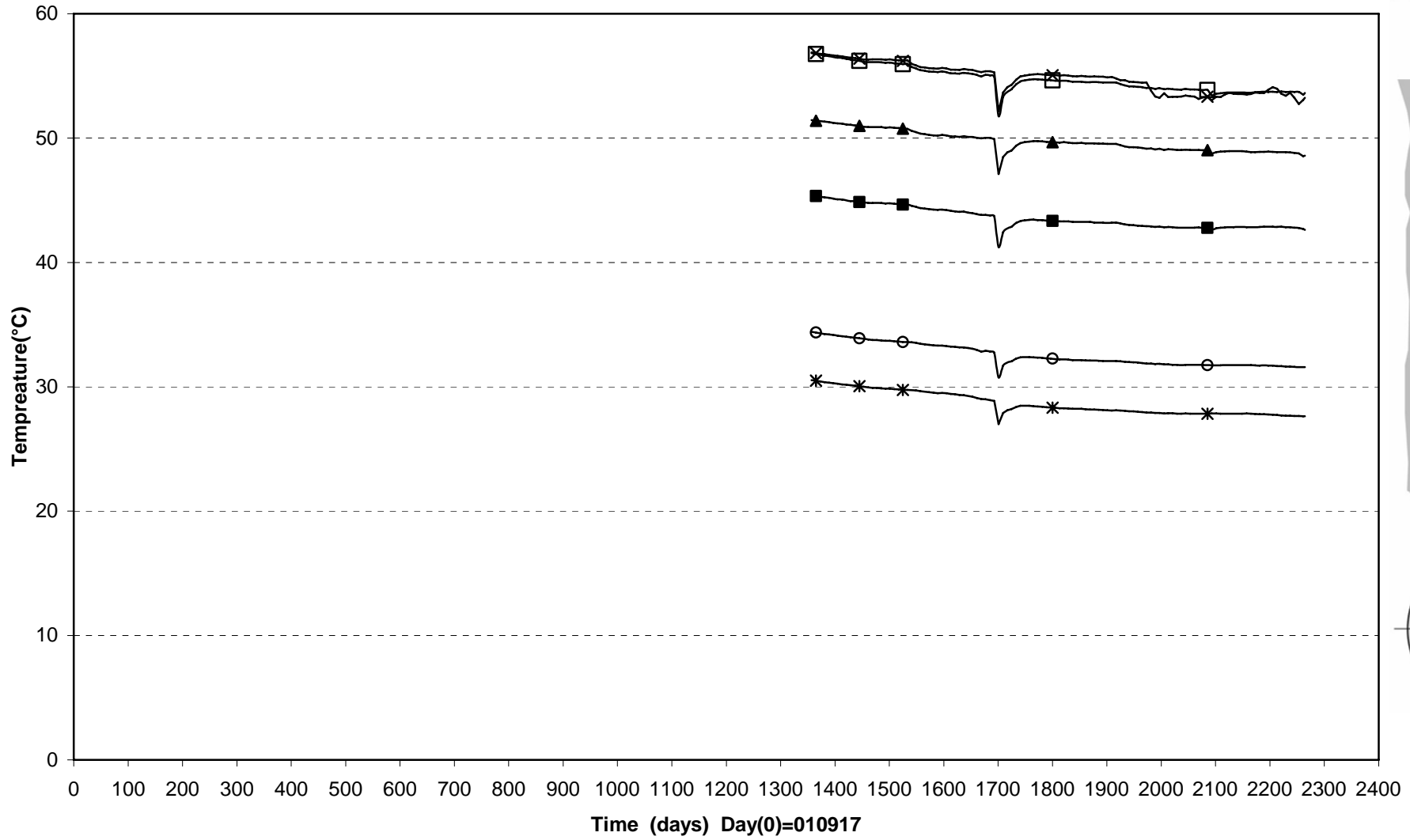

× UBU10002(0.254\90°\0.100)    ▲ UBU10003(0.344\355°\0.585)    □ UBU10010(2.780\175°\0.825)    ■ UBU10012(5.308\355°\0.785)  
 ○ UBU10013(6.317\90°\0.050)    ✱ UBU10014(6.916\90°\0.050)

Prototype\Rock\Hole 1 (010917-071201)  
 Temperature - Pentronic

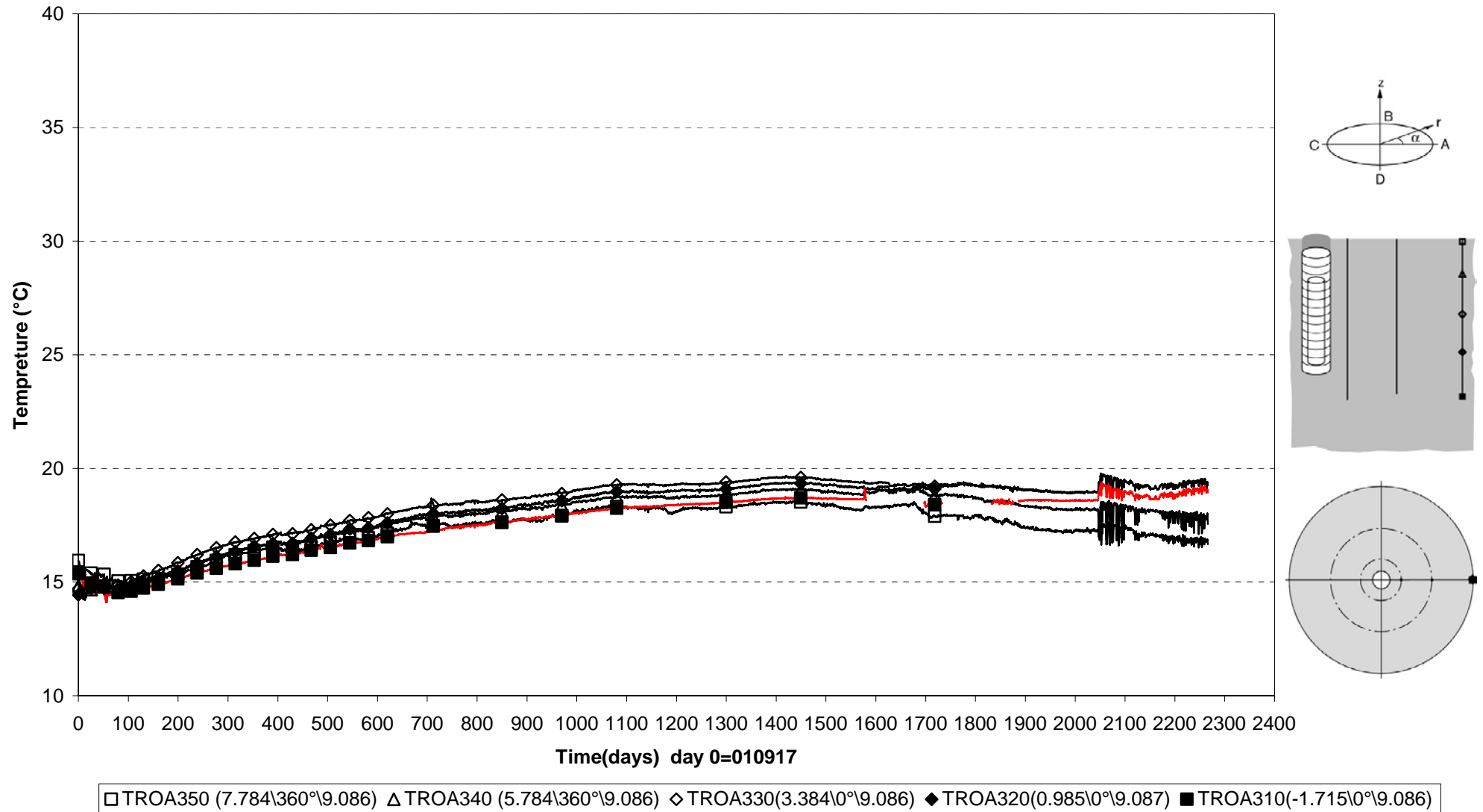

Prototype\Rock\Hole 1 (010917-071201)  
 Temperature - Pentronic

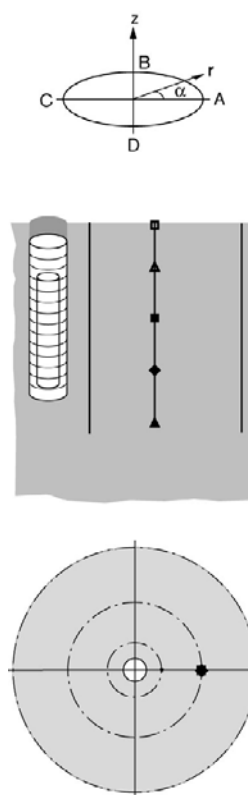
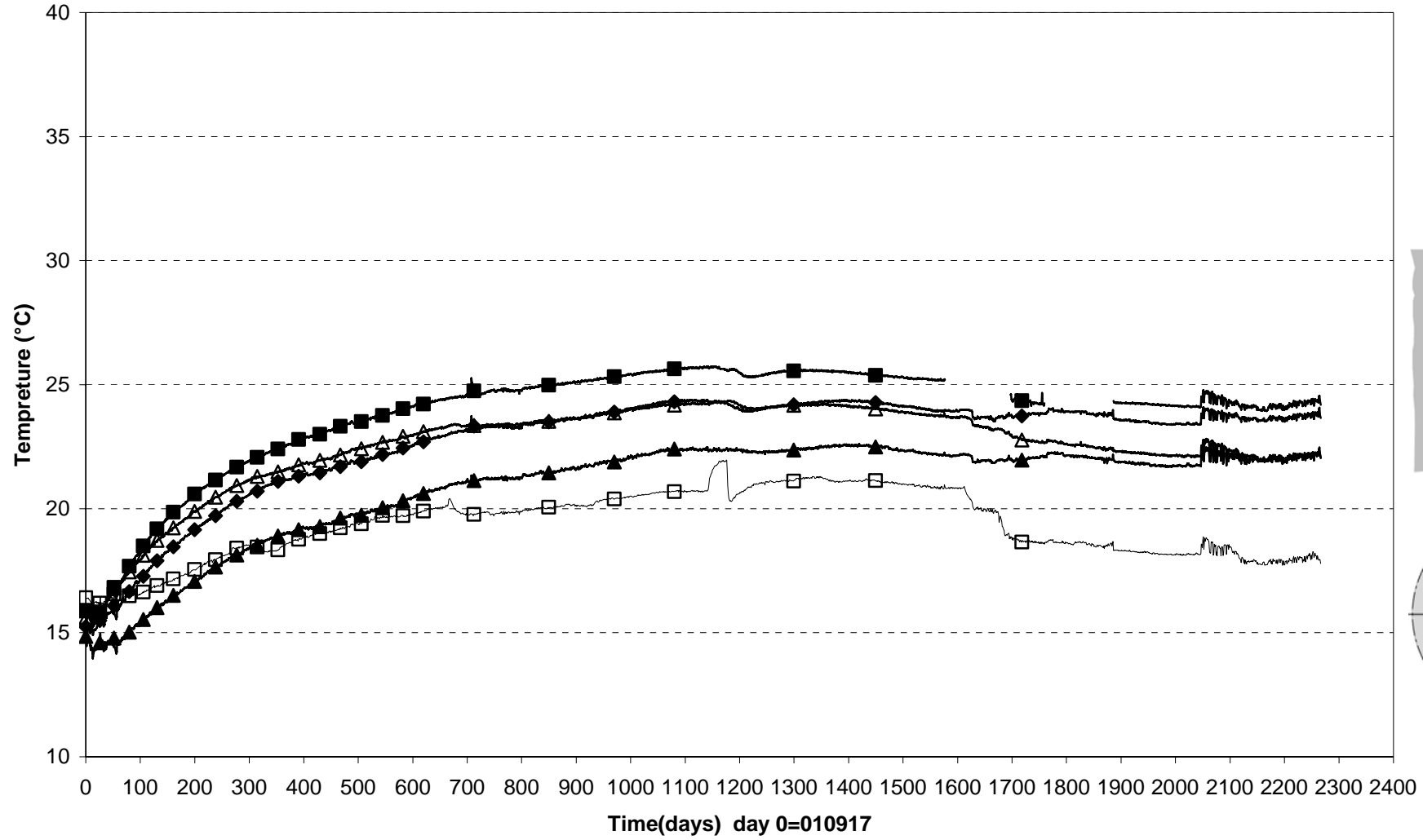

□ TROA650(7.921\360°\4.966)    Δ TROA640(5.921\360°\4.988)    ■ TROA630(3.521\360°\4.978)    ◆ TROA620(1.121\360°\4.968)    ▲ TROA610(-1.479\360°\4.956)

Prototype\Rock\Hole 1 (010917-071201)  
Temperature - Pentronic

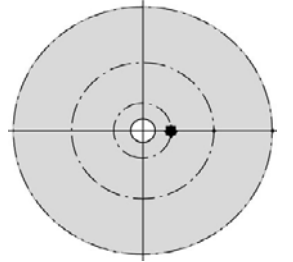
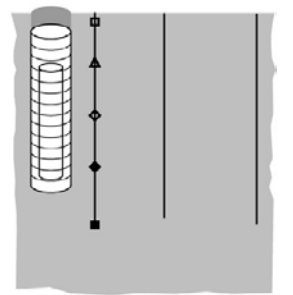
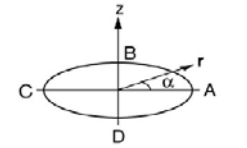
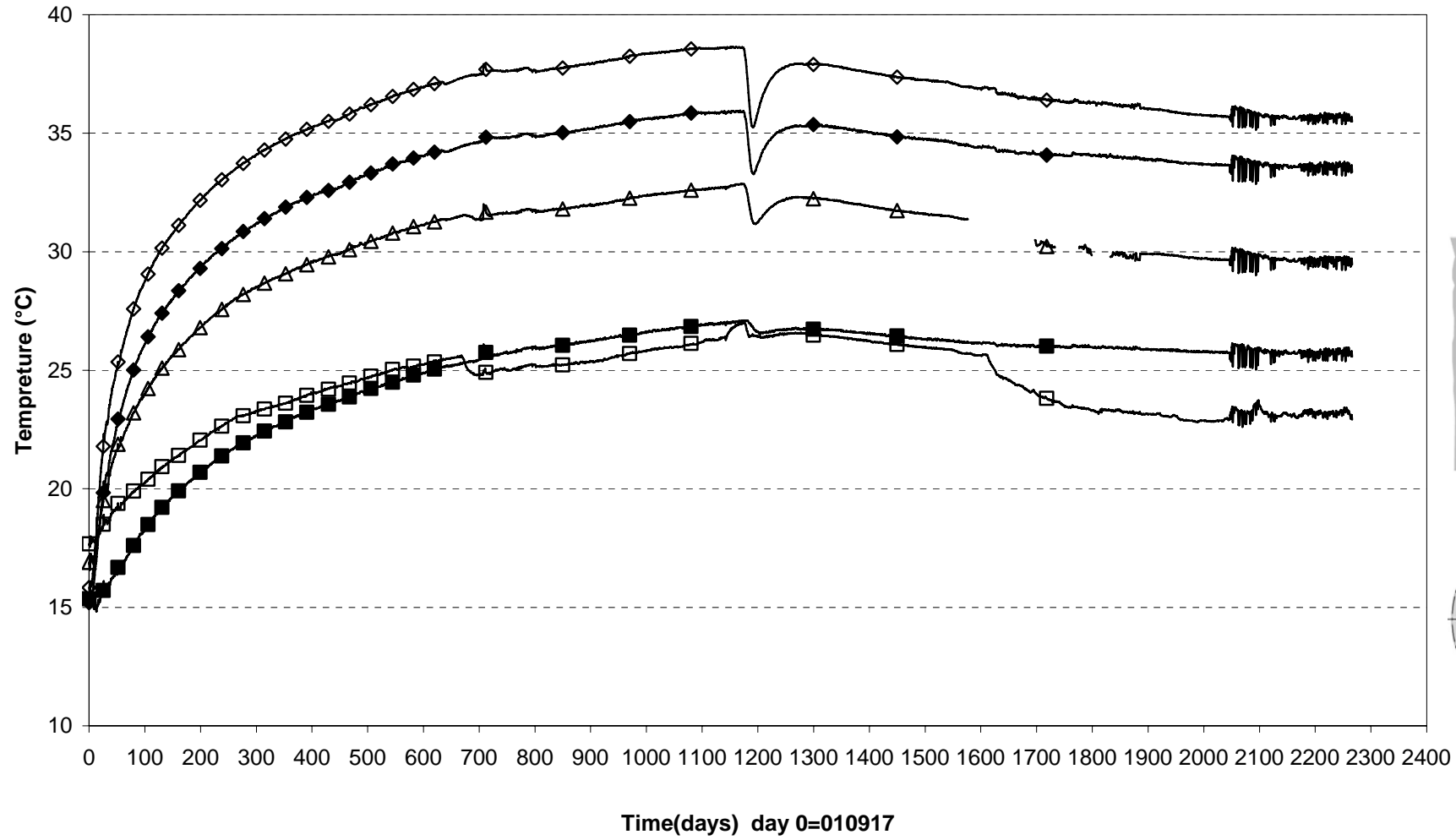

□ TROA1050(7.662\359°\2.020)    △ TROA1040(5.662\359°\2.028)    ◇ TROA1030(3.262\359°\2.038)    ◆ TROA1020(0.862\359°\2.048)    ■ TROA1010(-1.838\359°\2.059)

Prototype\ Hole 1 (010917-071201)  
Canister power

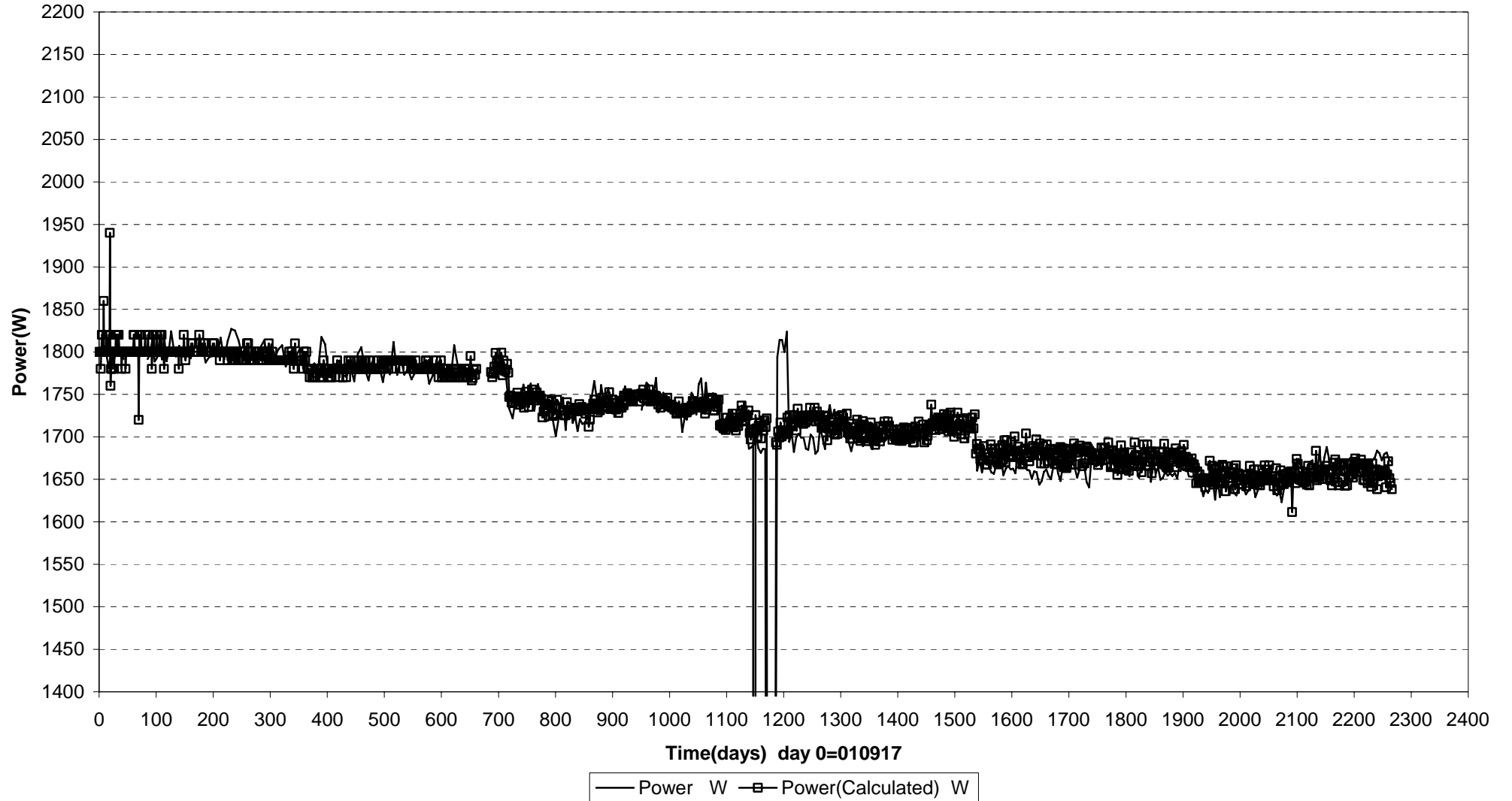



Prototype\ Hole 1 \Canister (010917-070601)  
 Max. temperature on the canister surface - Optical fiber cables

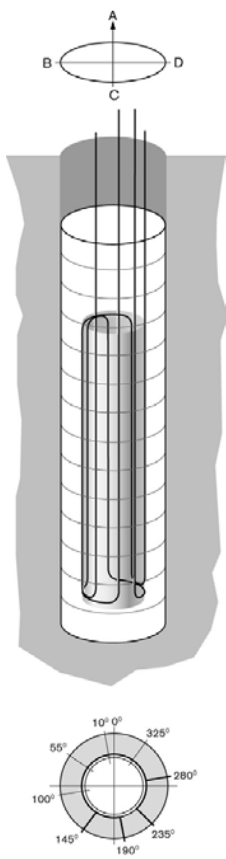
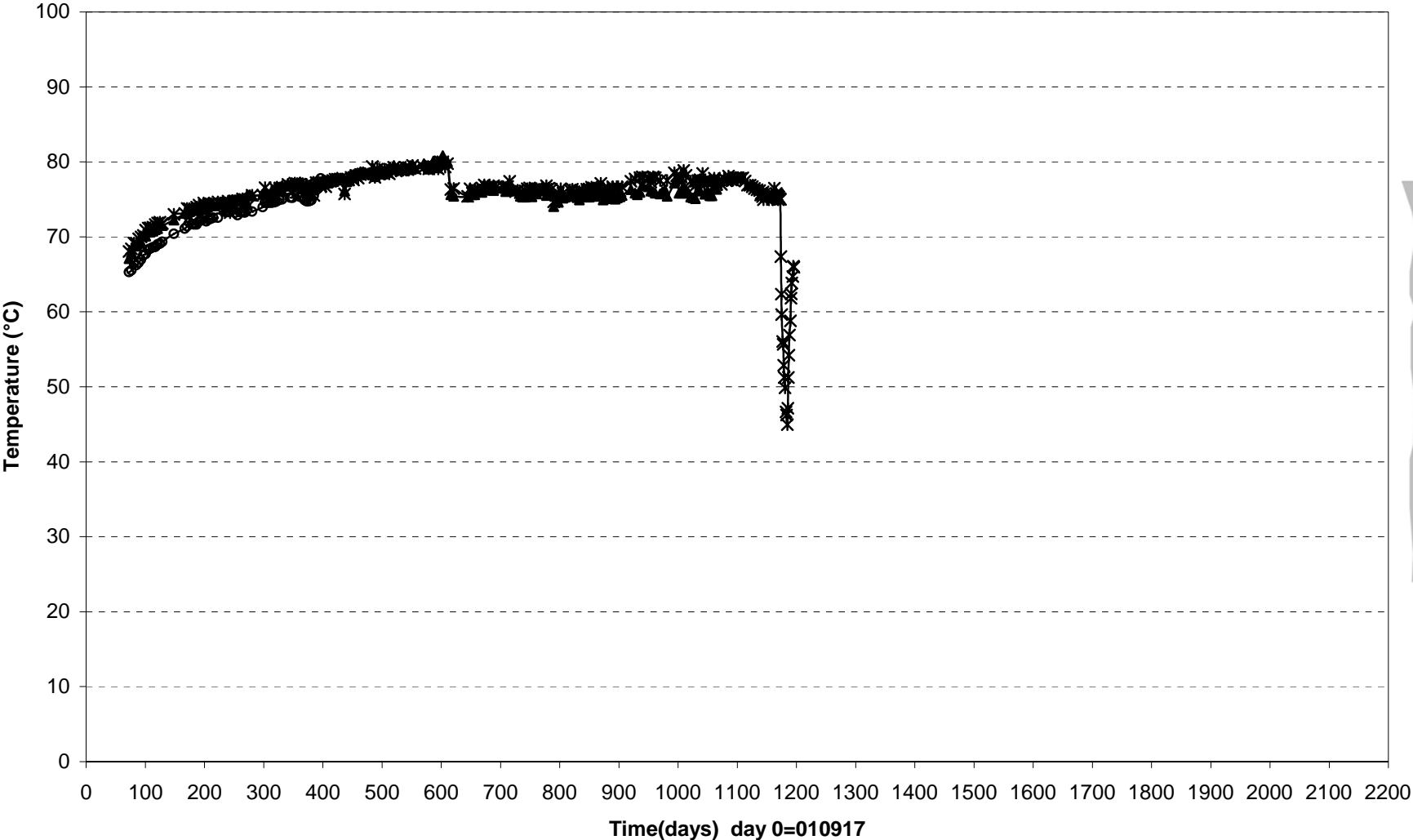

Prototype\ Hole 1 \ Canister (041201)  
Temperature profile on the canister surface - Optical fiber cables

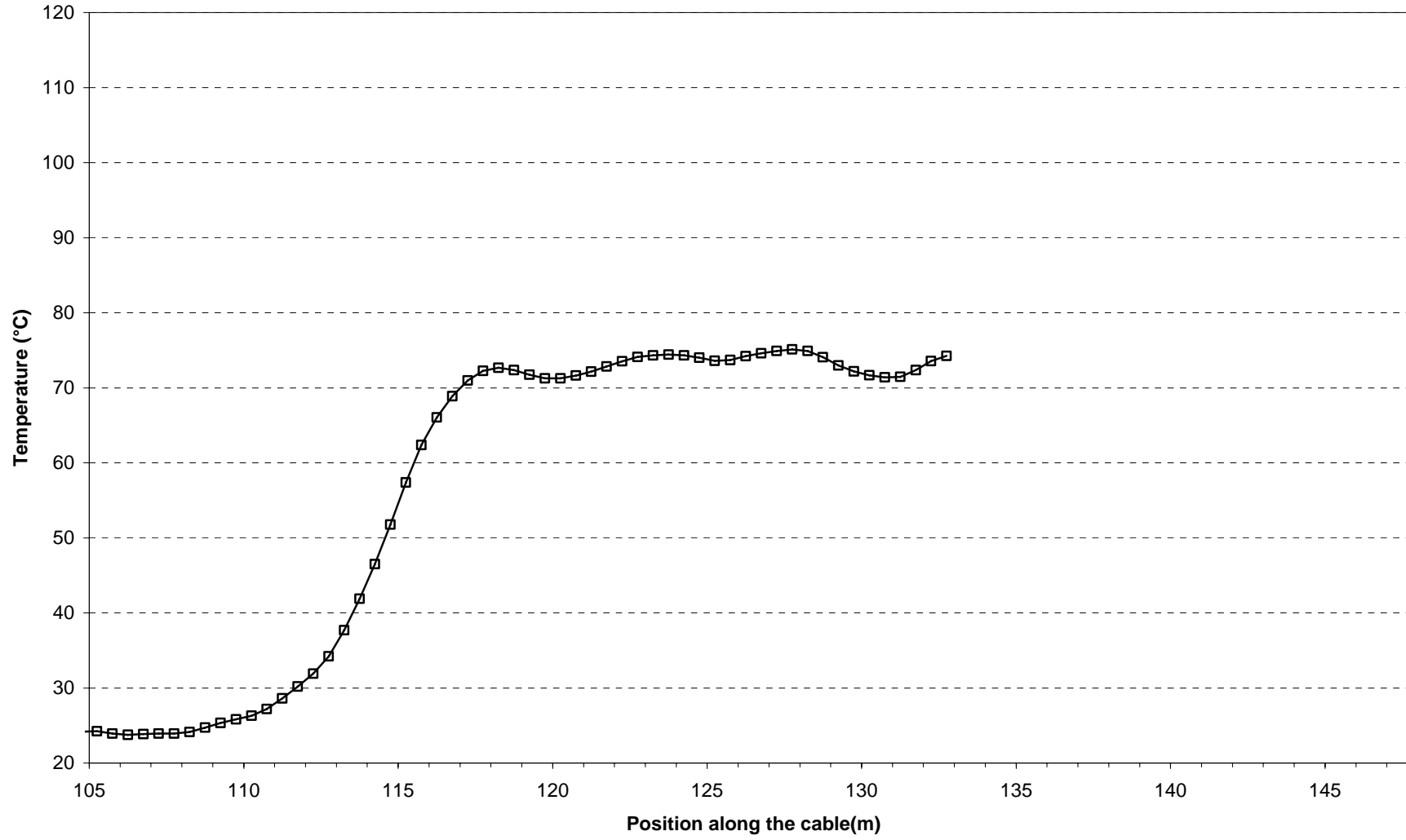

—□— Cable 1, inlet °C

## **Appendix 2**

**Dep. hole 3**



Prototype\Hole 3\Cyl.1 (010917-071201)  
 Total pressure - Geokon

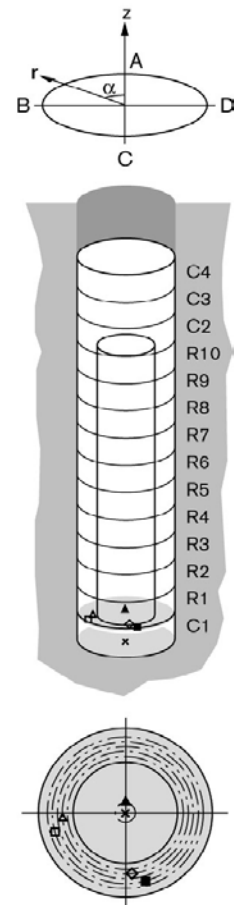
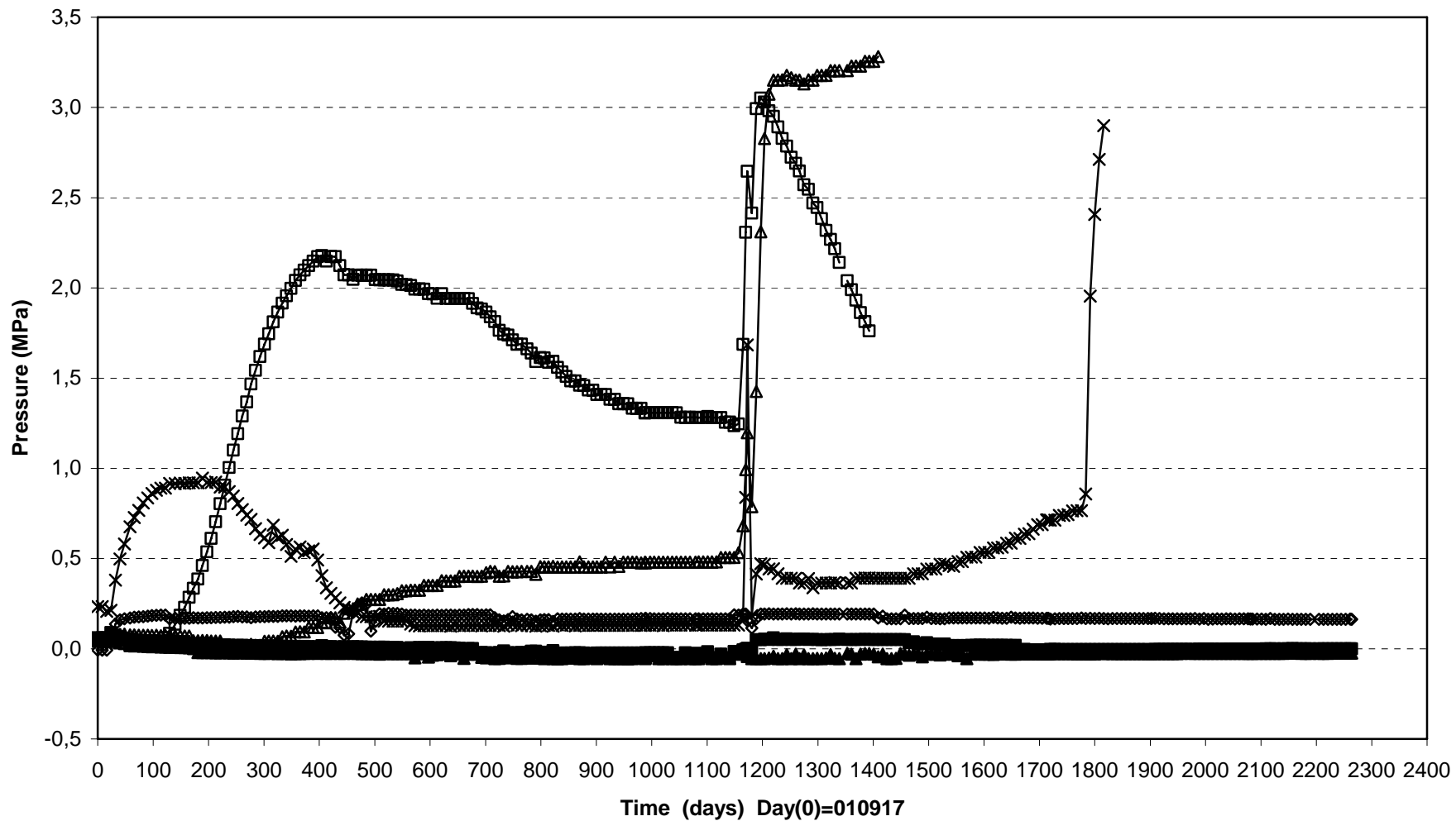

|                               |                                |                                |
|-------------------------------|--------------------------------|--------------------------------|
| —x— PBU30001(0\0°\0)          | —▲— PBU30002(0.495\0°\0.100)   | —◇— PBU30008(0.495\185°\0.635) |
| —△— PBU30006(0.495\95°\0.635) | —□— PBU30007(0.495\105°\0.735) | —■— PBU30009(0.495\195°\0.735) |

Prototype\Hole 3 \Ring5 (010917-071201)  
 Total pressure - Geokon

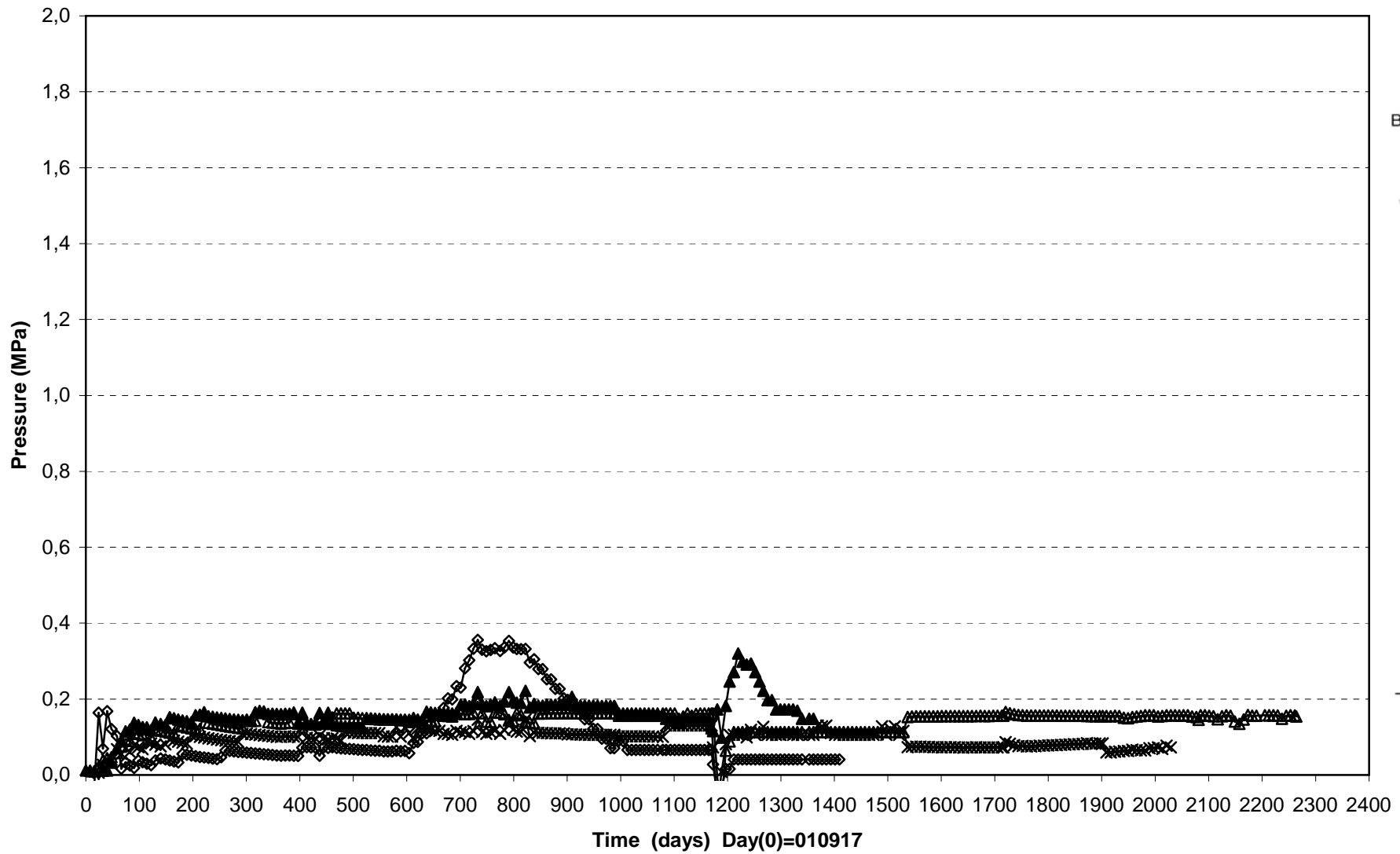

—x— PBU30013(2.771\95°\0.585) —▲— PBU30011(2.771\5°\0.685) —◇— PBU30014(2.771\95°\0.785) —▲— PBU30015(3.021\185°\0.535)

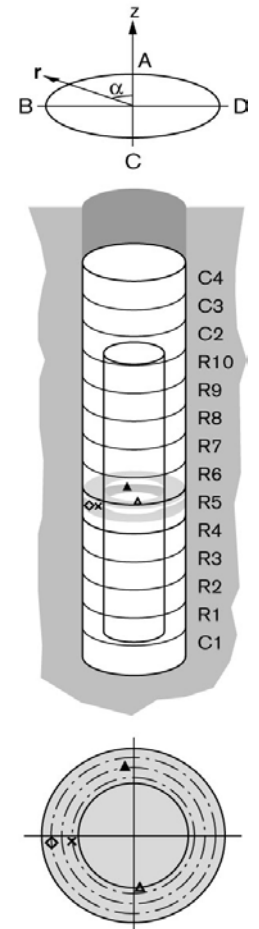

Prototype\Hole 3\Ring10 and Cyl.3 (010917-071201)  
 Total pressure - Geokon

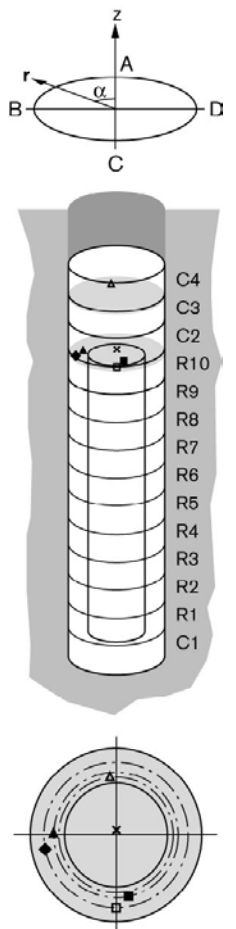
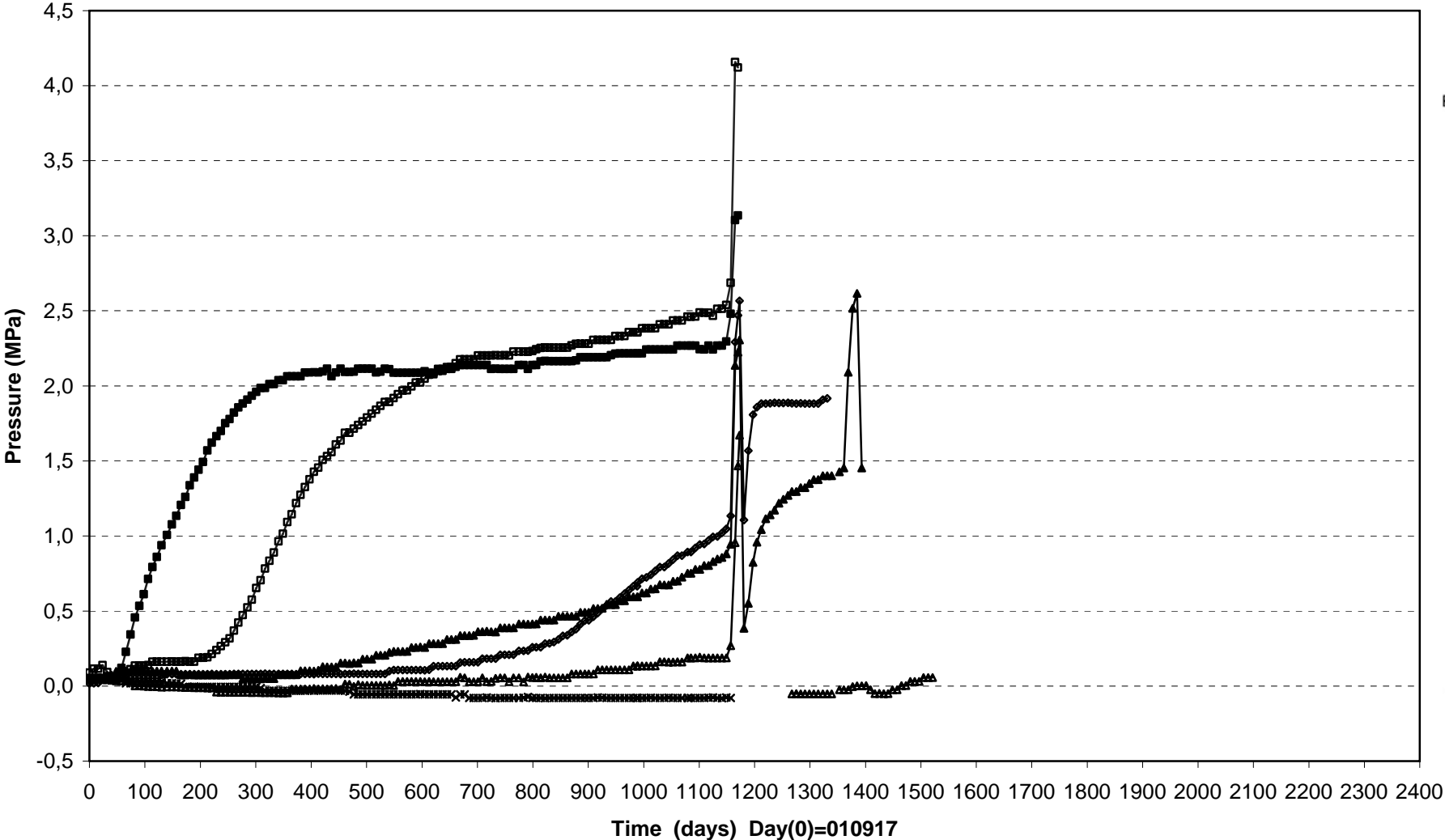

- x— PBU30017(5.556\0°\0.050)      —▲— PBU30021(5.556\90°\0.635)      —◆— PBU30022(5.556\100°\0.735)
- △— PBU30026(6.654\5°\0.585)      —□— PBU30023(5.556\190°\0.735)      —■— PBU30024(5.556\190°\0.635)

Prototype\Hole 3 \Cyl.1 and Ring5 (010917-071201)  
Total pressure - Kulite

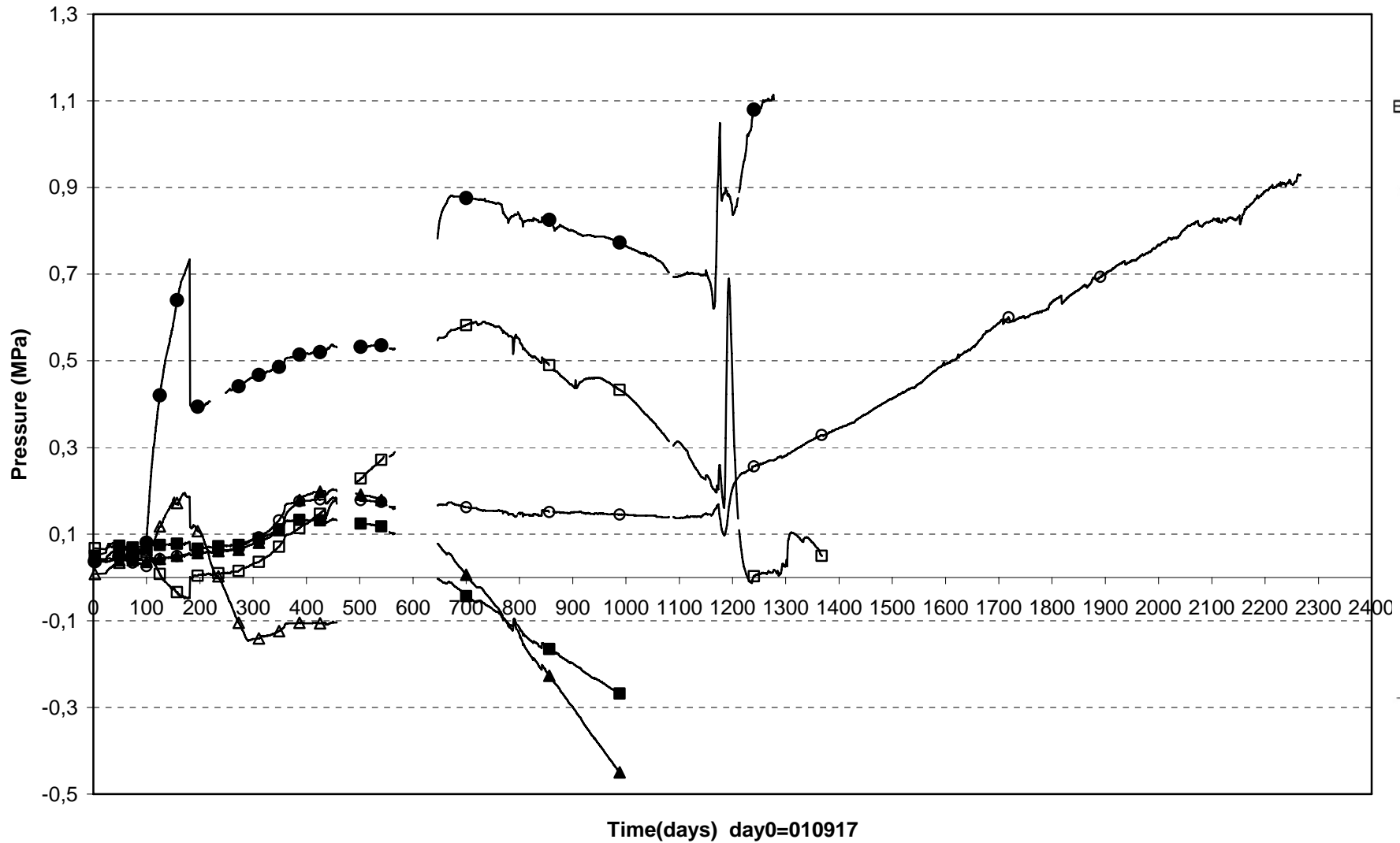

- |                            |                              |                            |                            |
|----------------------------|------------------------------|----------------------------|----------------------------|
| □ PBU30003(Cyl.1\5°\0.585) | ▲ PBU30004(Cyl.1\5°\0.685)   | ○ PBU30005(Cyl.1\5°\0.785) | △ PBU30010(Ring5\5°\0.585) |
| ● PBU30012(Ring5\5°\0.825) | ■ PBU30016(Ring5\185°\0.825) |                            |                            |



Prototype\Hole 3\Ring10 and Cyl.3-4 (010917-071201)  
 Total pressure - Kulite

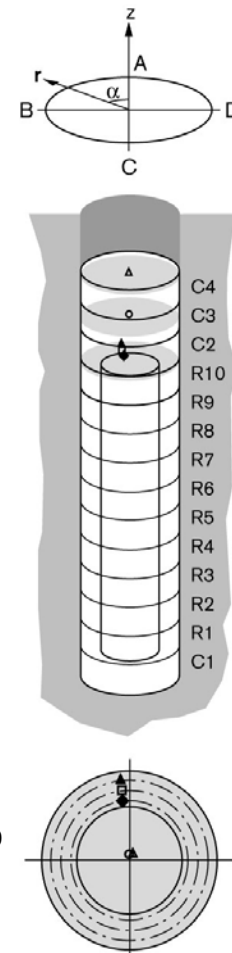
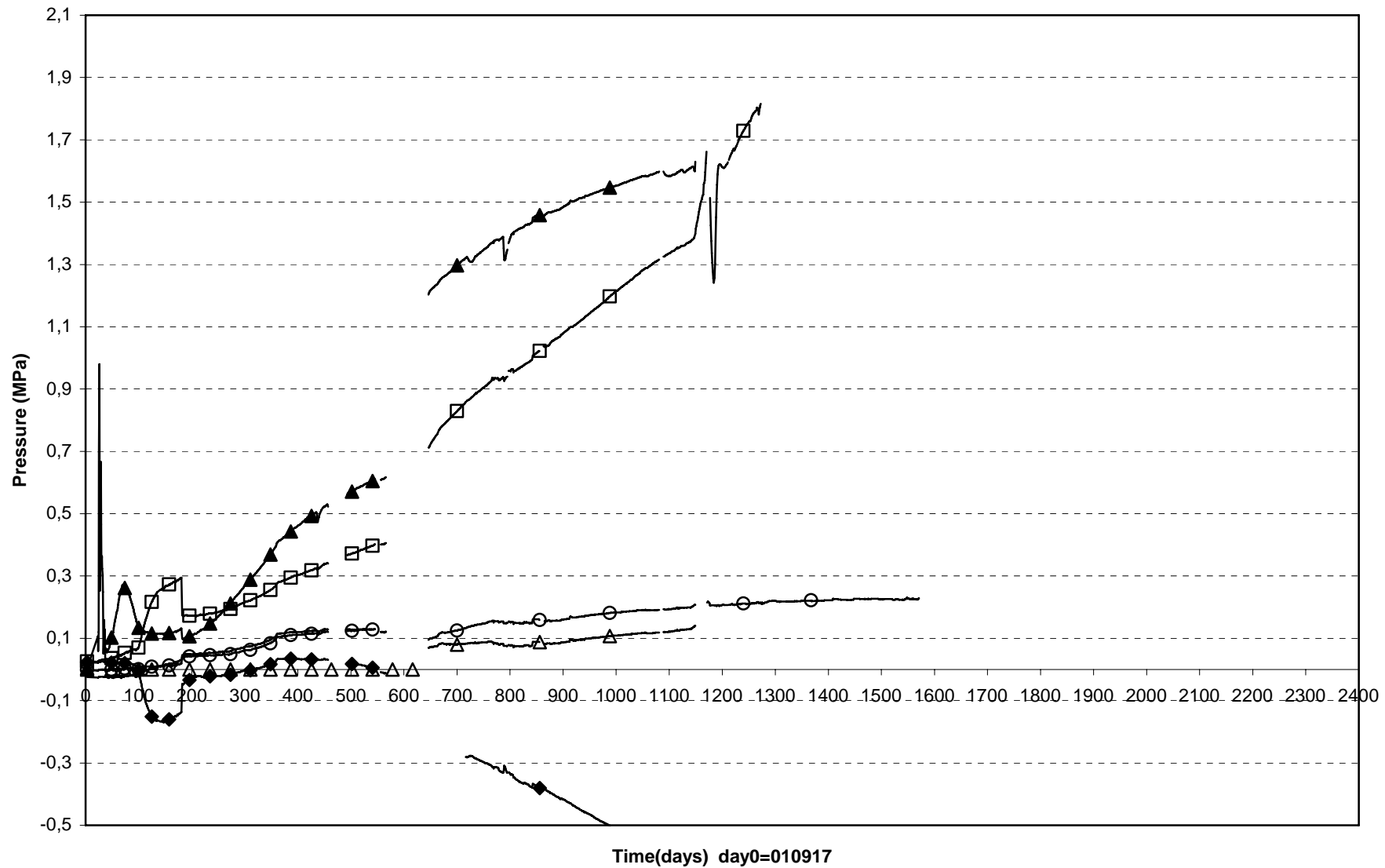

◆ PBU30018(Ring10\5°\0.585) □ PBU30019(Ring10\5°\0.685) ▲ PBU30020(Ring10\5°\0.785) ○ PBU30025(Cyl.3\0°\0.050) △ PBU30027(Cyl.4\0°\0.050)

Prototype\Hole 3\Cyl.1 (010917-071201)  
Relative humidity - Vaisala

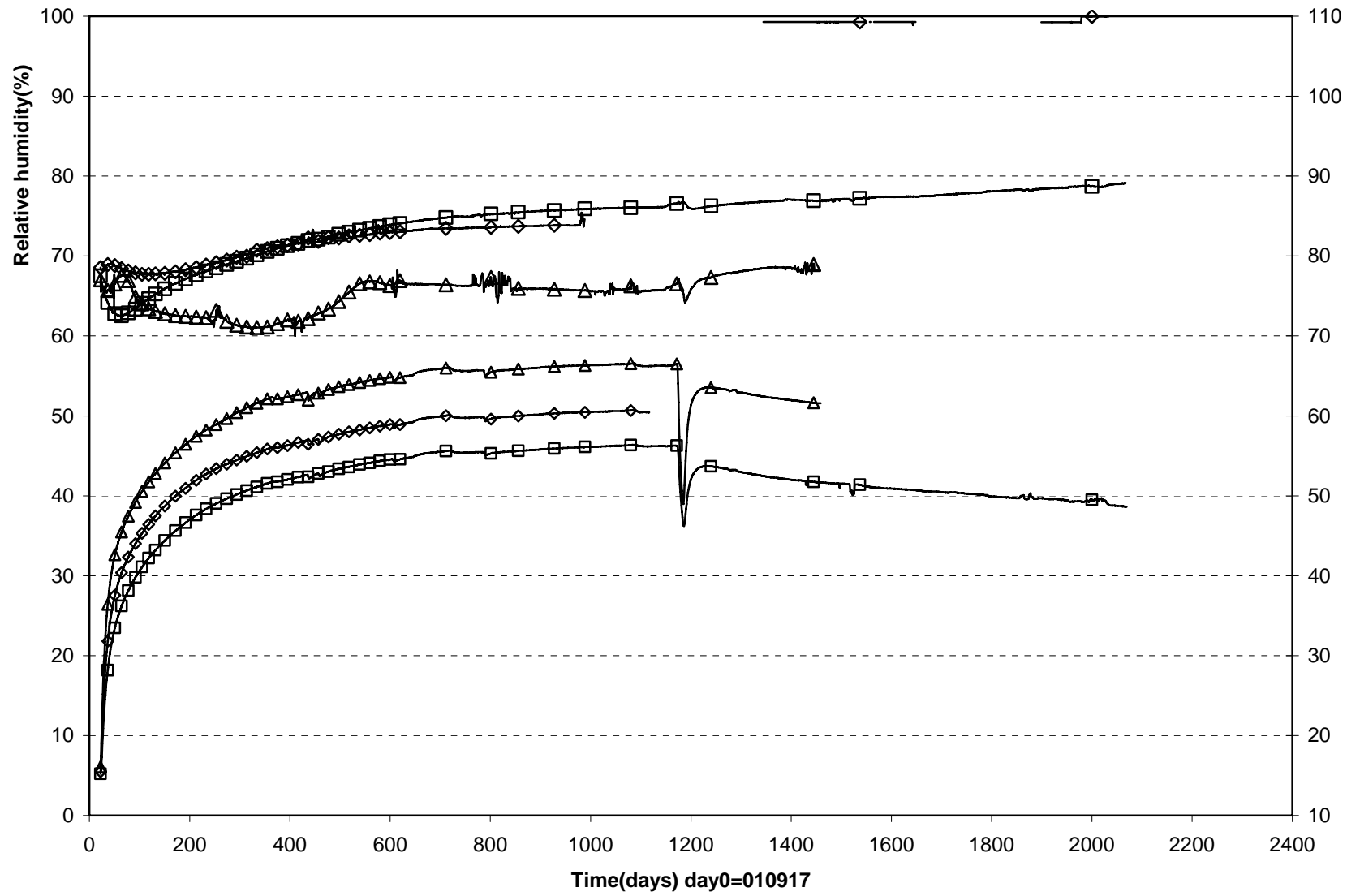

□ WBU30004(0.335\350°\0.785)    ◇ WBU30005(0.335\350°\0.685)    △ WBU30006(0.335\350°\0.585)

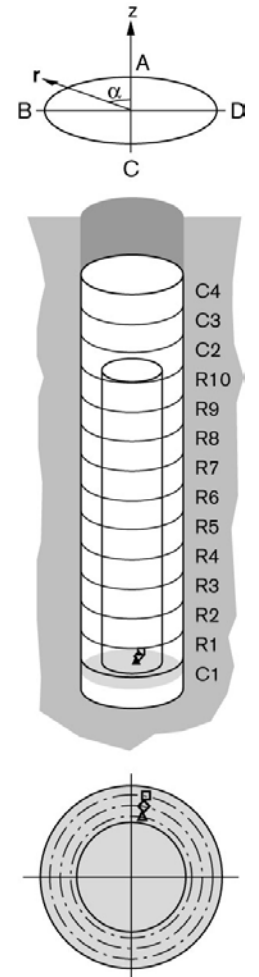

Prototype\Hole 3\Ring 5 (010917-071201)  
Relative humidity - Vaisala

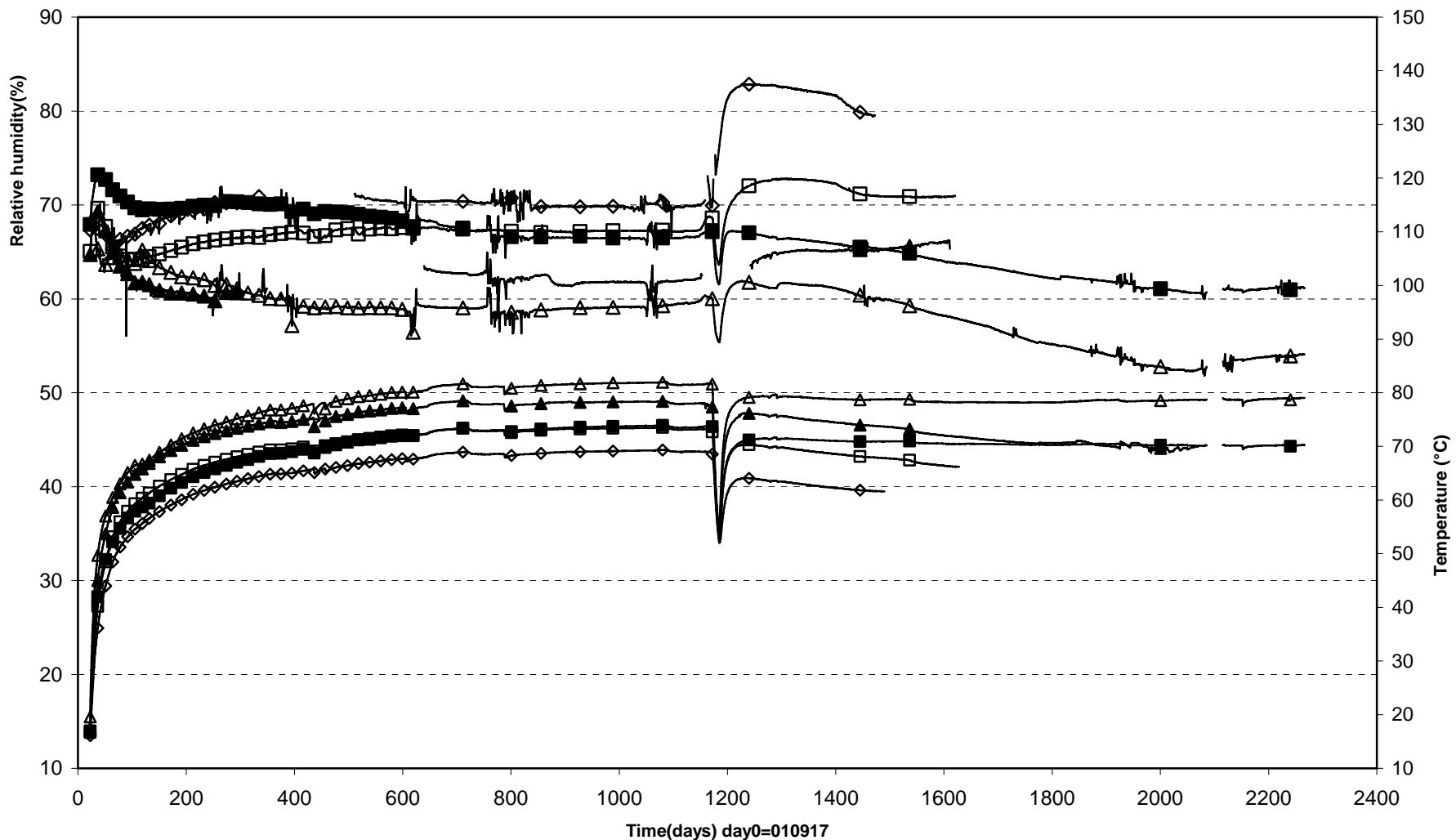

- |  |                              |                              |
|--|------------------------------|------------------------------|
| ▲ WBU30013(2.840\350°\0.585)             | □ WBU30014(2.840\350°\0.685) | ◇ WBU30015(2.840\350°\0.785) |
| △ WBU30019(2.840\180°\0.535\In the slot) | ■ WBU30020(2.840\180°\0.685) |                              |

Prototype\Hole 3\Ring 10 (010917-071201)  
Relative humidity - Vaisala

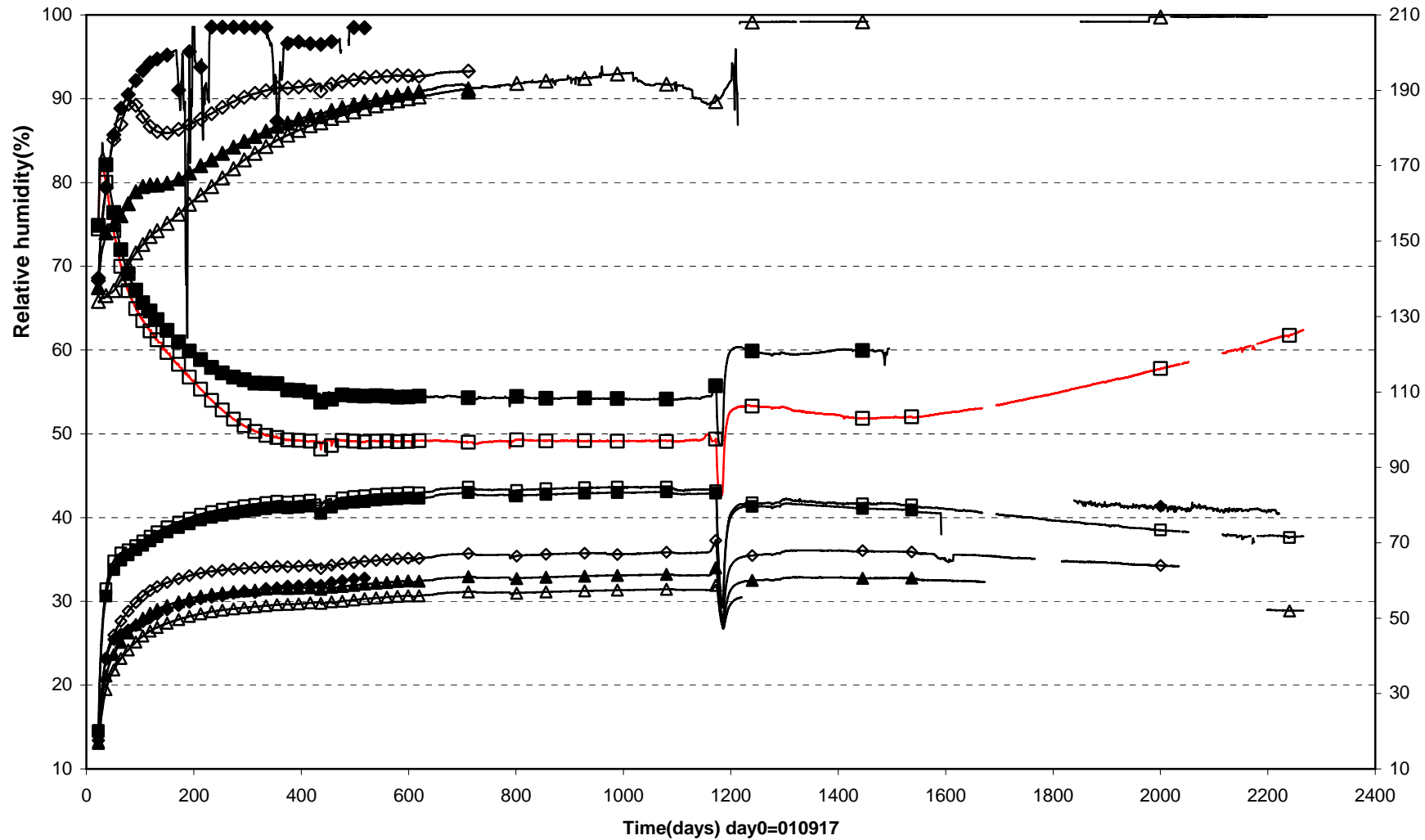

□ WBU30022(5.416\180°\0.050)    ■ WBU30023(5.396\352°\0.262)    ◇ WBU30024(5.396\350°\0.585)    △ WBU30025(5.396\350°\0.785))  
 ▲ WBU30026(5.396\350°\0.685)    ◆ WBU30030(5.396\170°\0.585)

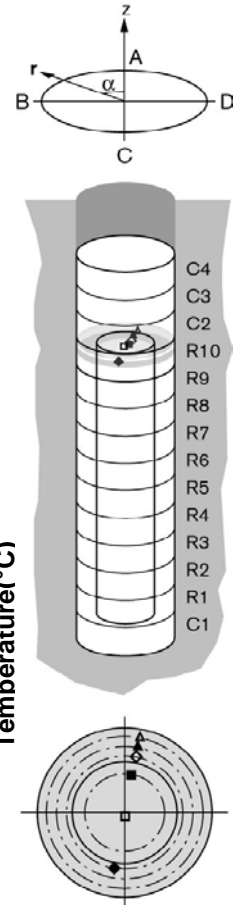

Prototype\Hole 3\Cyl.3 and Cyl.4 (010917-071201)  
Relative humidity - Vaisala

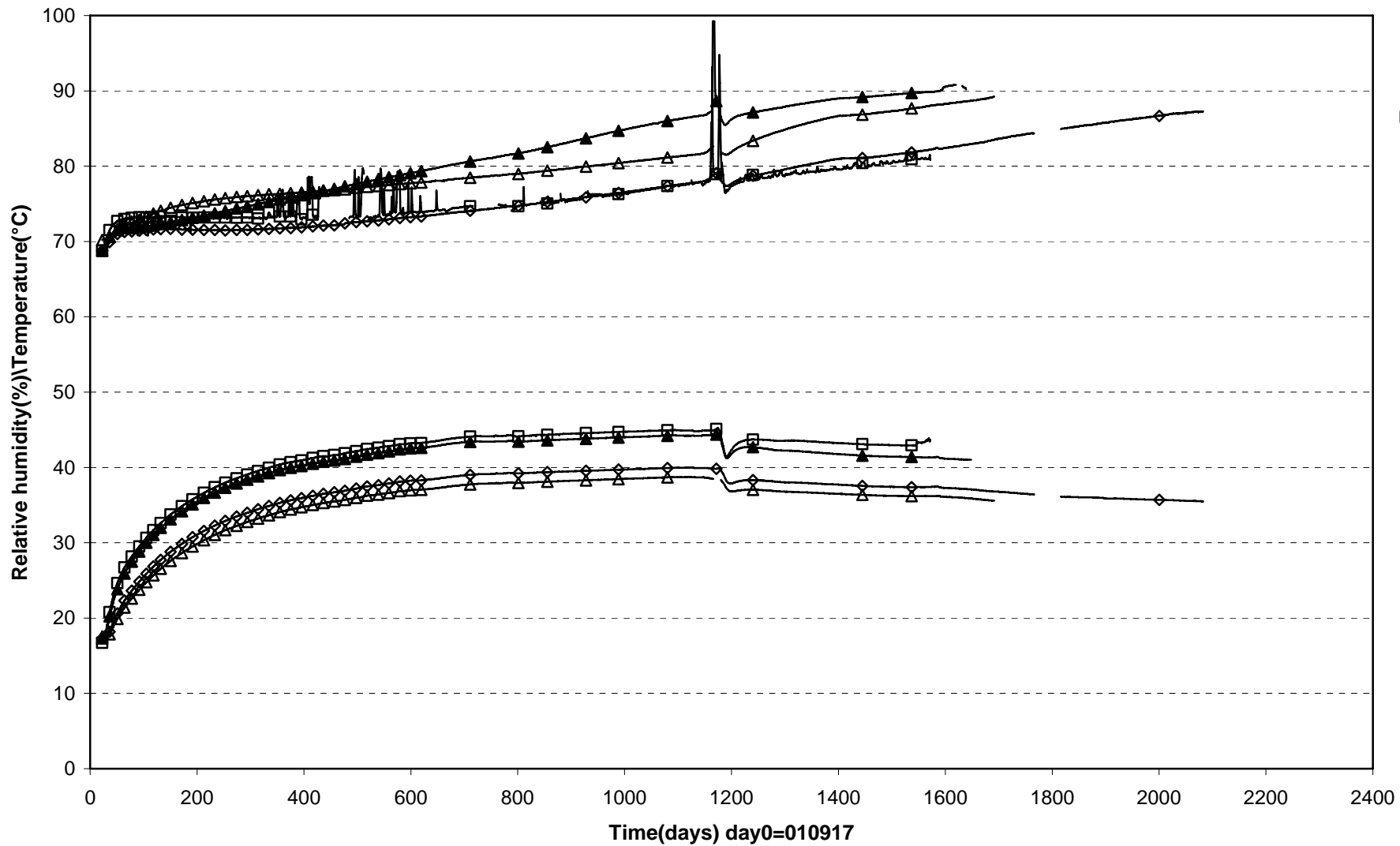

□ WBU30032(6.314\180°\0.050) ▲ WBU30033(6.314\350°\0.585) △ WBU30036(6.680\180°\0.050) ◇ WBU30037(6.840\270°\0.050)

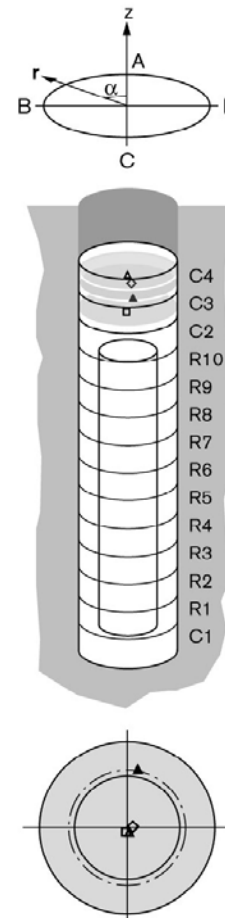

Prototype\Hole 3\Cyl.1 (010917-071201)  
Relative humidity - Rotronic

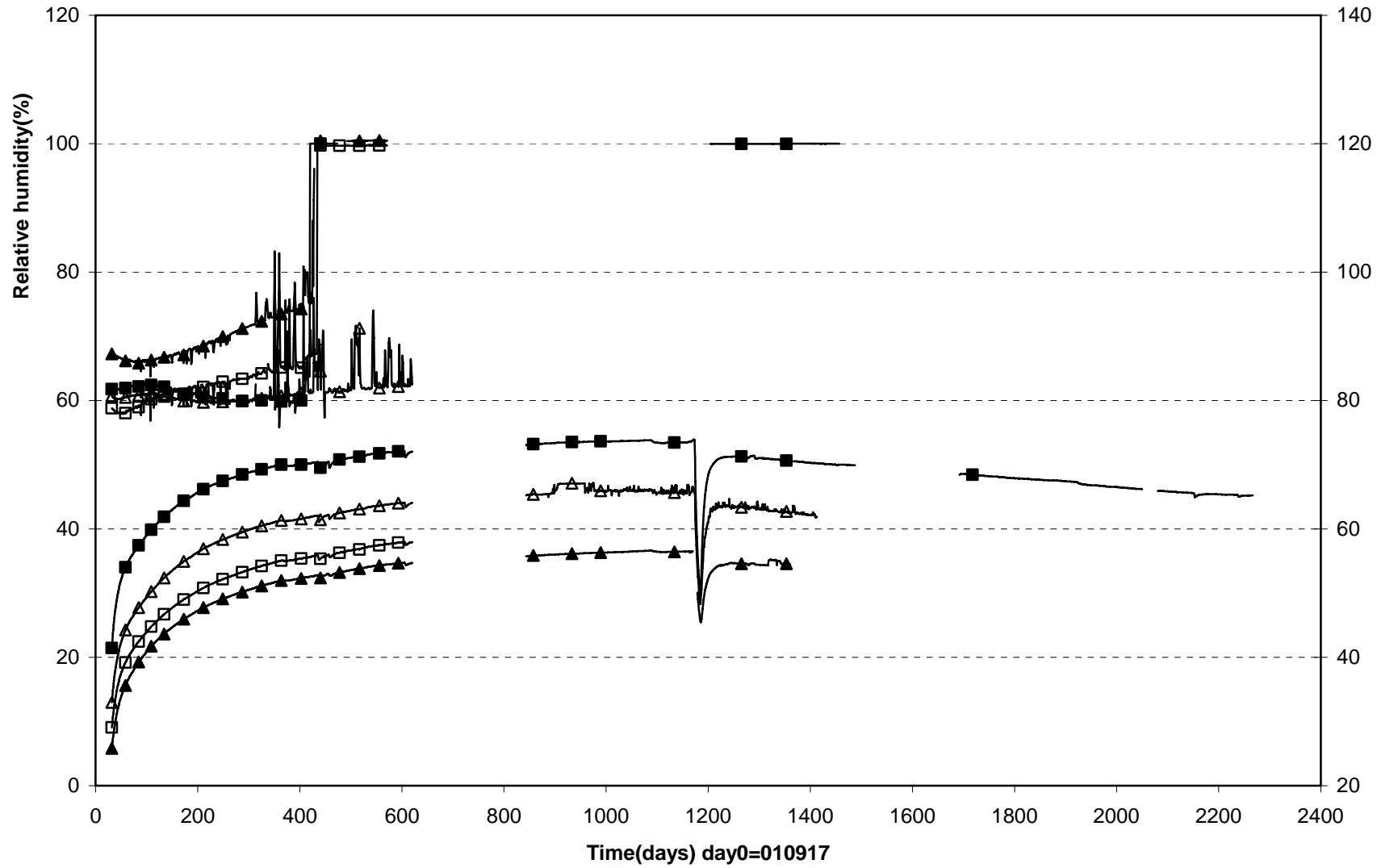

□ WBU30001(0.045\180°\0.050)    △ WBU30002(0.215\0°\0.400)    ■ WBU30003(0.245\180°\0.100)    ▲ WBU30008(0.245\80°\0.685)

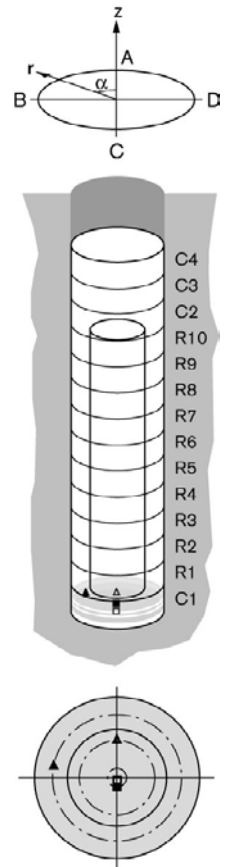

Prototype\Hole 3\Cyl.1 (010917-071201)  
Relative humidity - Rotronic

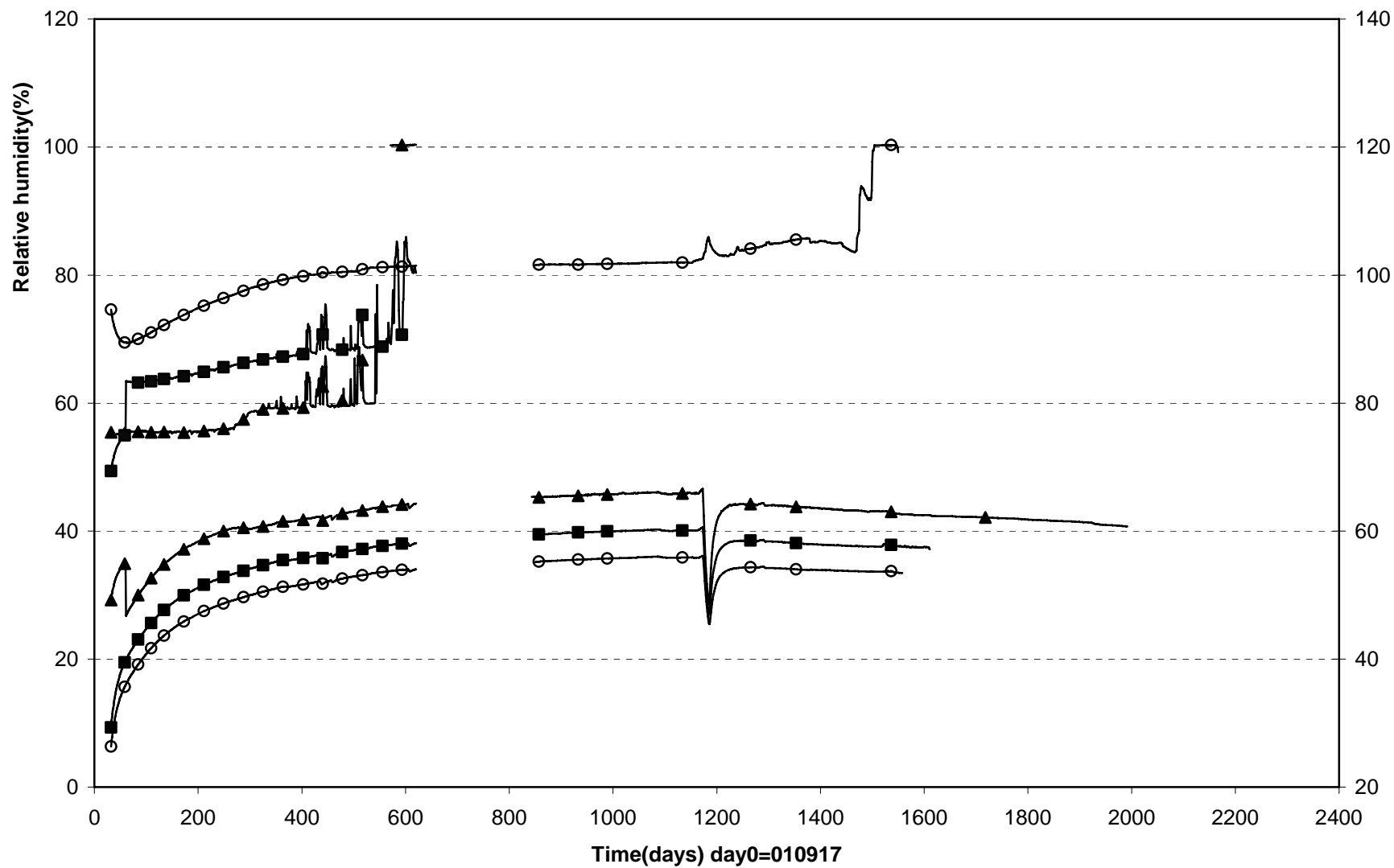

▲ WBU30010(0.245\170°\0.585) ■ WBU30011(0.245\170°\0.685) ○ WBU30012(0.245\170°\0.785)

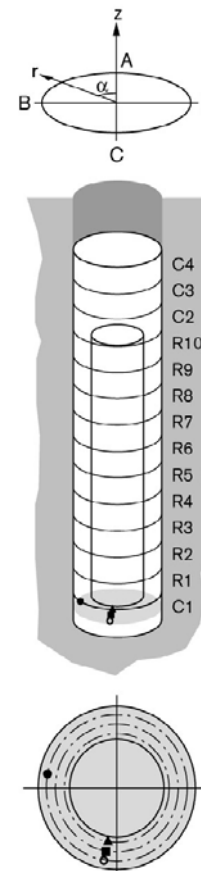

Prototype\Hole 3\Ring 5 (010917-071201)  
Relative humidity - Rotronic

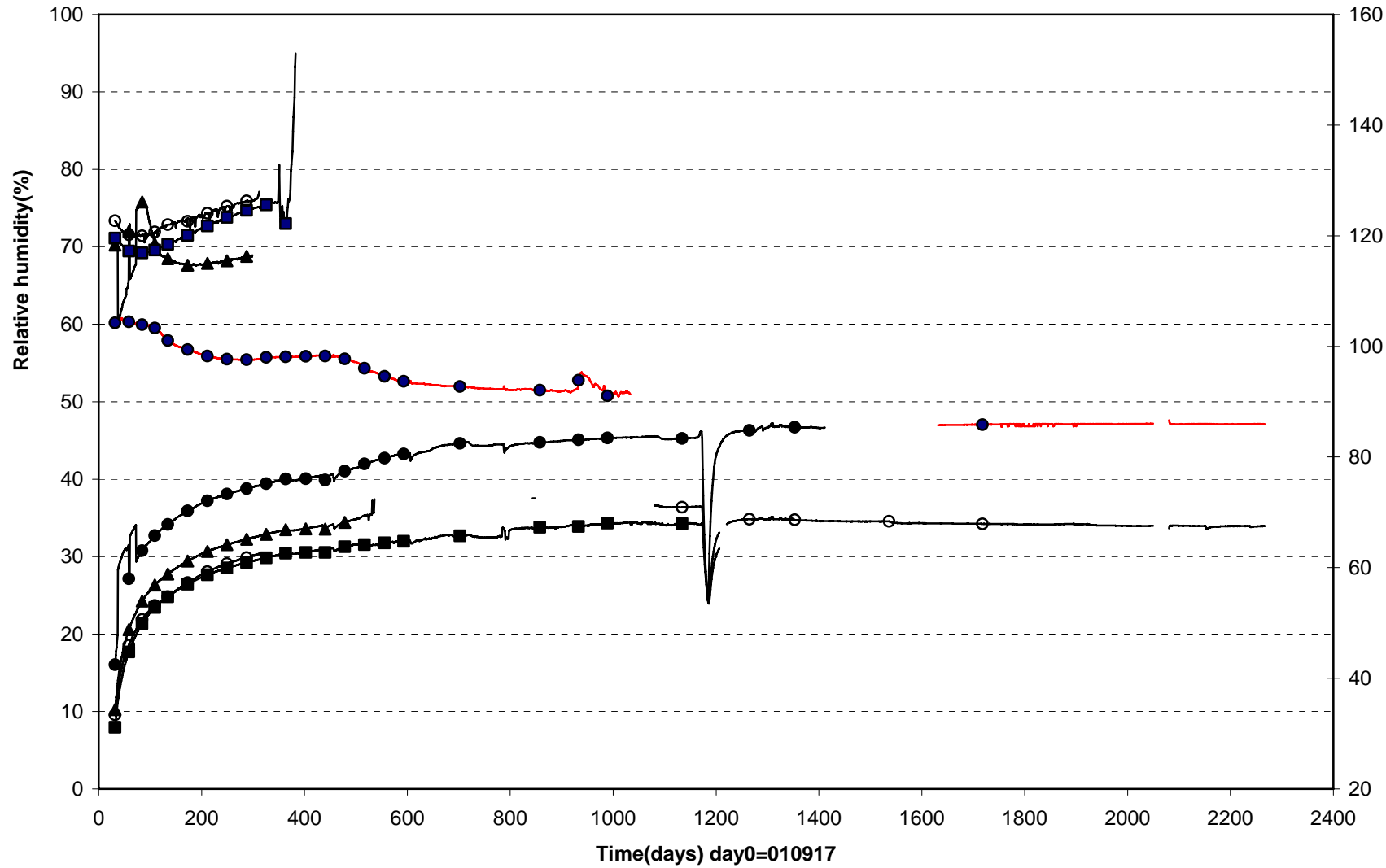

● WBU30016(2.750\80°\0.535) ▲ WBU30017(2.750\80°\0.685) ■ WBU30018(2.750\80°\0.785) ○ WBU30021(2.750\180°\0.785)

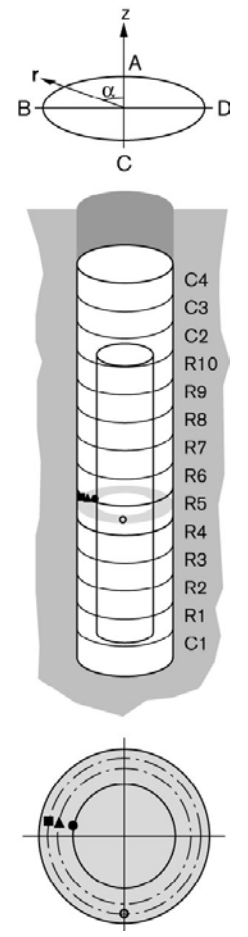



Prototype\Hole 3\Ring 10 (010917-071201)  
Relative humidity - Rotronic

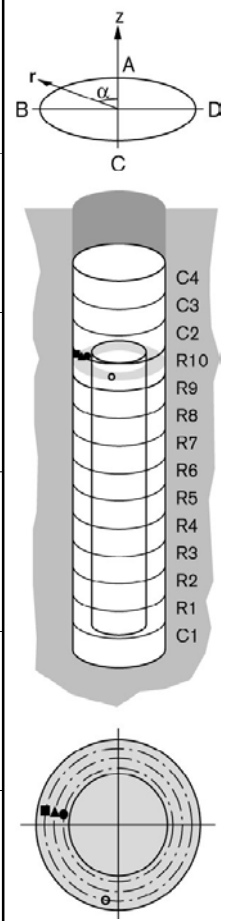
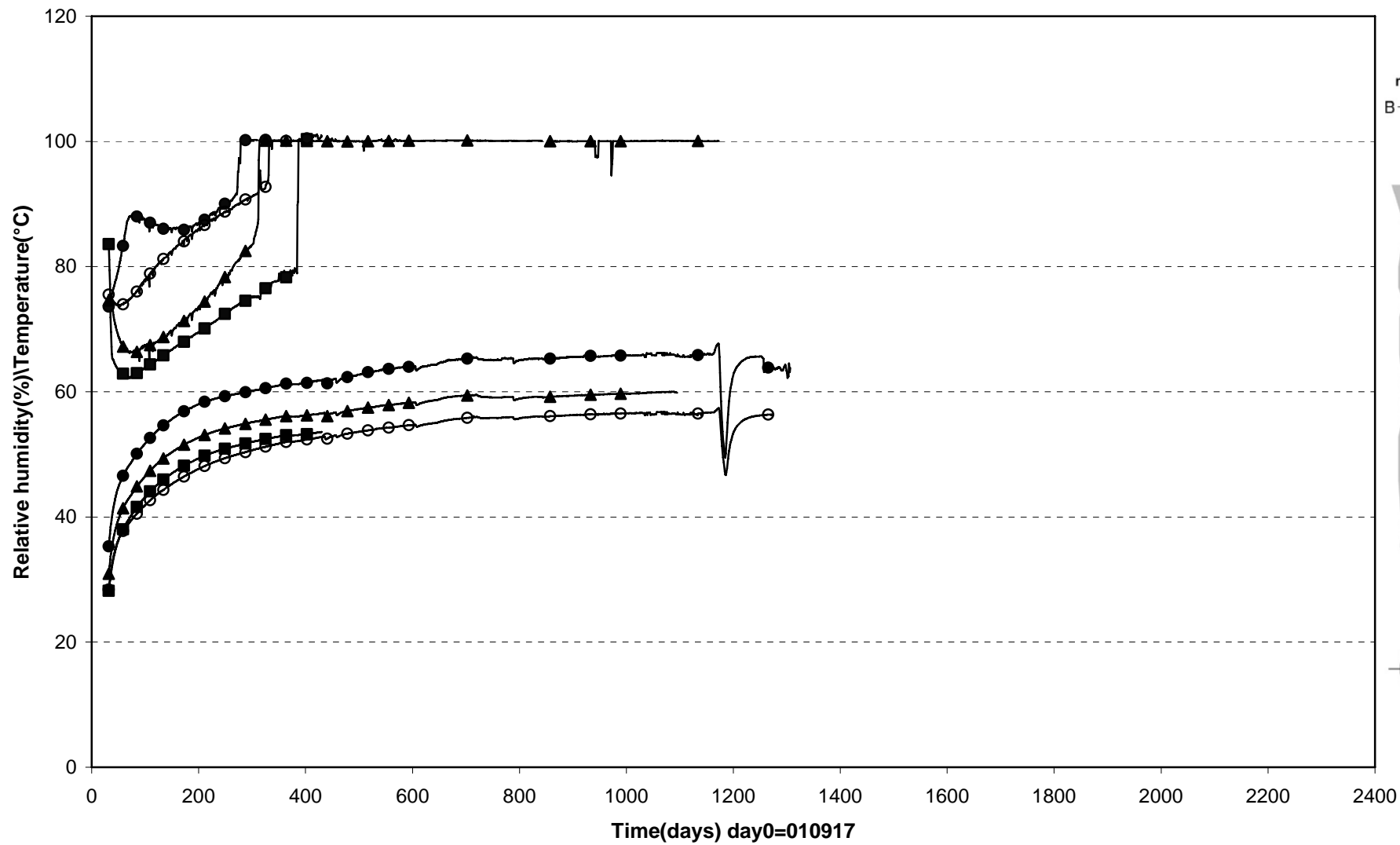

● WBU30027(5.306\80°\0.585) ▲ WBU30028(5.306\80°\0.685) ■ WBU30029(5.306\80°\0.785) ○ WBU30031(5.306\170°\0.785)

Prototype\Hole 3\Cyl.3 (010917-071201)  
 Relative humidity - Rotronic

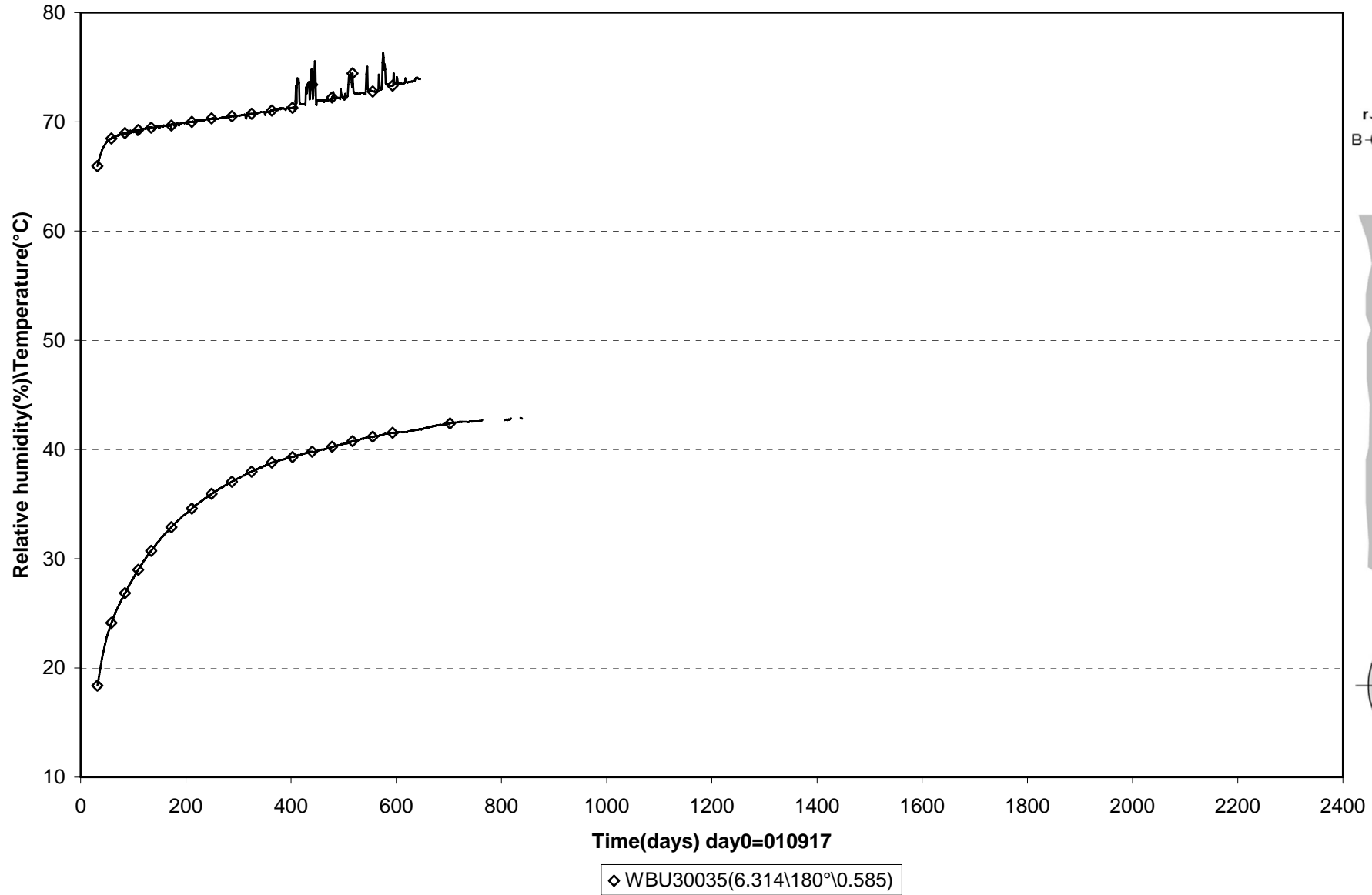

Prototype\Hole 3 (010917-071201)  
Pore pressure - Geokon

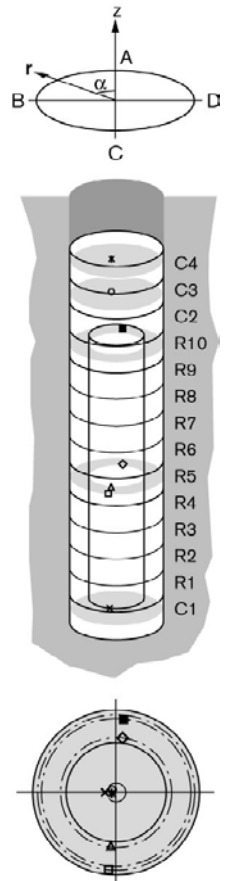
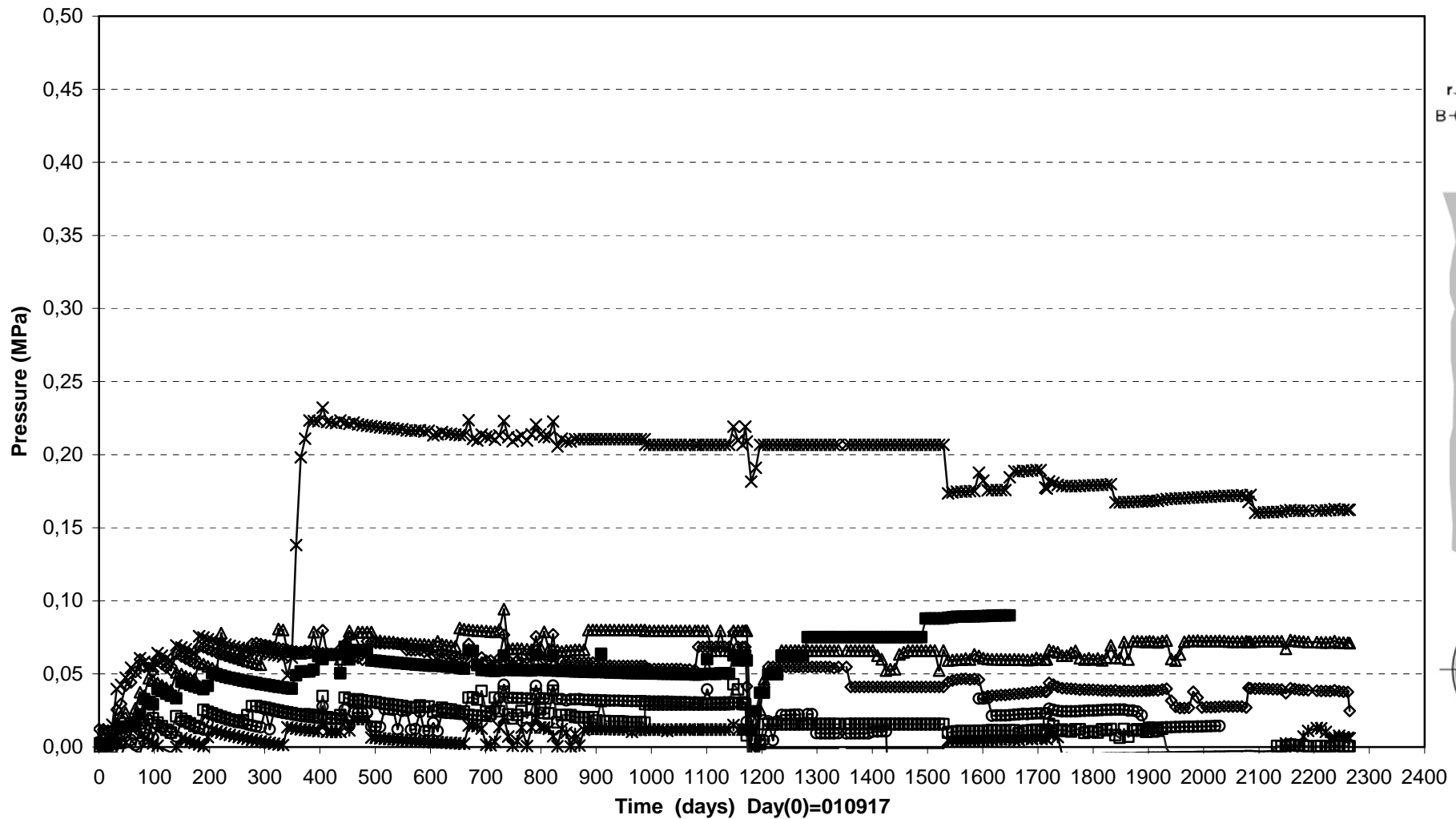

- |  |                                |  |
|--|--------------------------------|--|
| —x— UBU30002(0.245\90°\0.100)              | —◇— UBU30005(2.771\355°\0.585) | —△— UBU30009(2.771\175°\0.535\in the slot) |
| —□— UBU30010(2.771\175°\0.825\in the slot) | —■— UBU30012(5.306\355°\0.785) | —○— UBU30013(6.314\90°\0.050)              |
| —*— UBU30014(6.910\90°\0.050)              |                                |  |

Prototype\Hole 3 (010917-071201)  
Pore pressure - Kulite

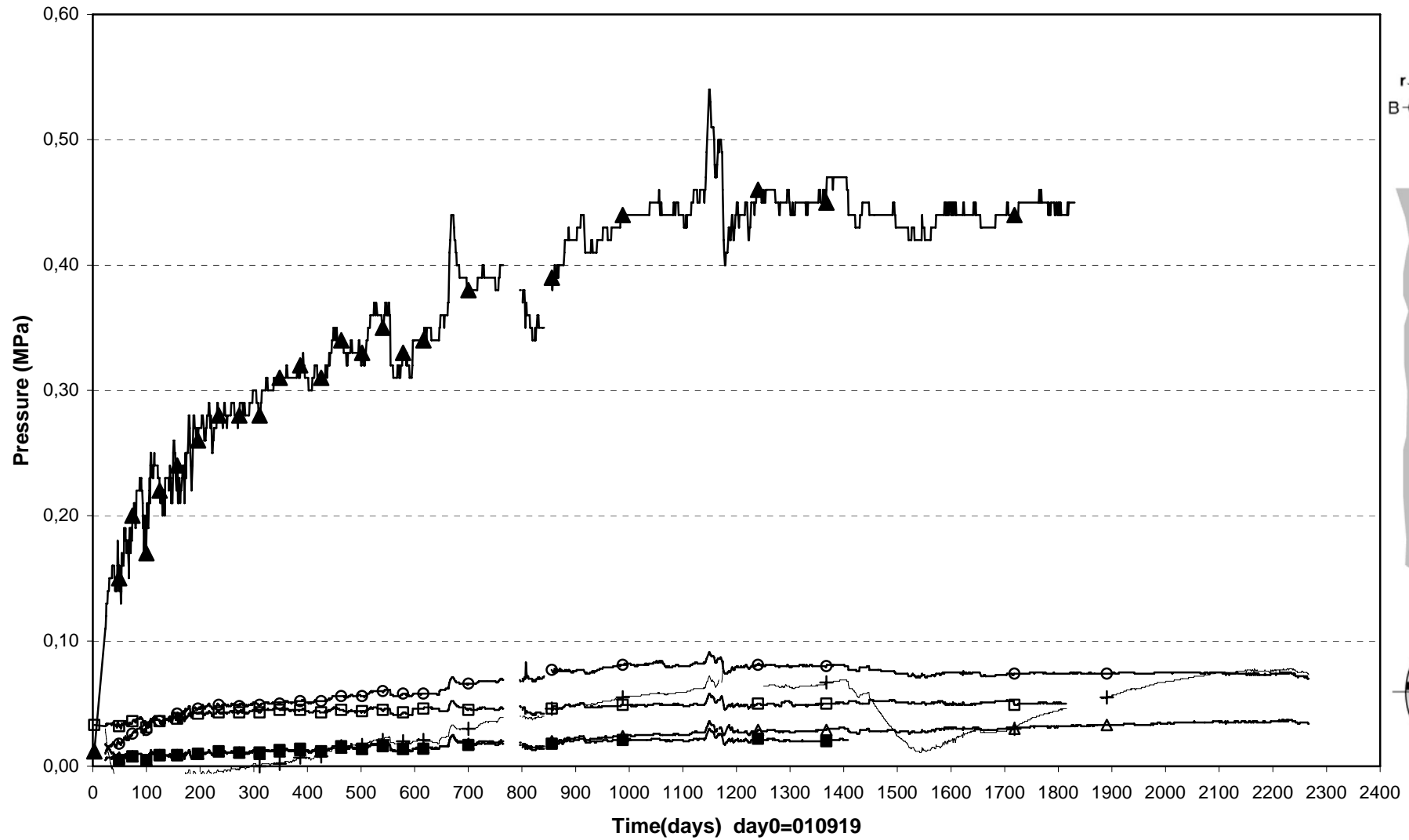

- |  |  |                                |
|--|--|--------------------------------|
| □ UBU30001(Cyl.1\90°\0.050)              | ▲ UBU30004(Cyl.1\355°\0.785)             | ○ UBU30006(Ring5\355°\0.785)   |
| + UBU30007(Ring.5\85°\0.535\In the slot) | ■ UBU30008(Ring.5\85°\0.825\In the slot) | △ UBU300011(Ring10\355°\0.585) |

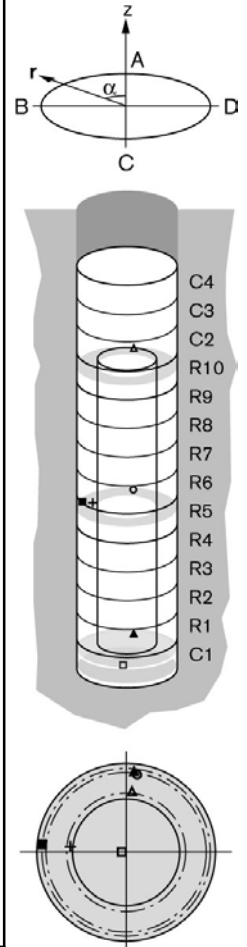

Prototype\Hole 3\Cyl.1 (010917-071201)  
 Temperature - Pentronic

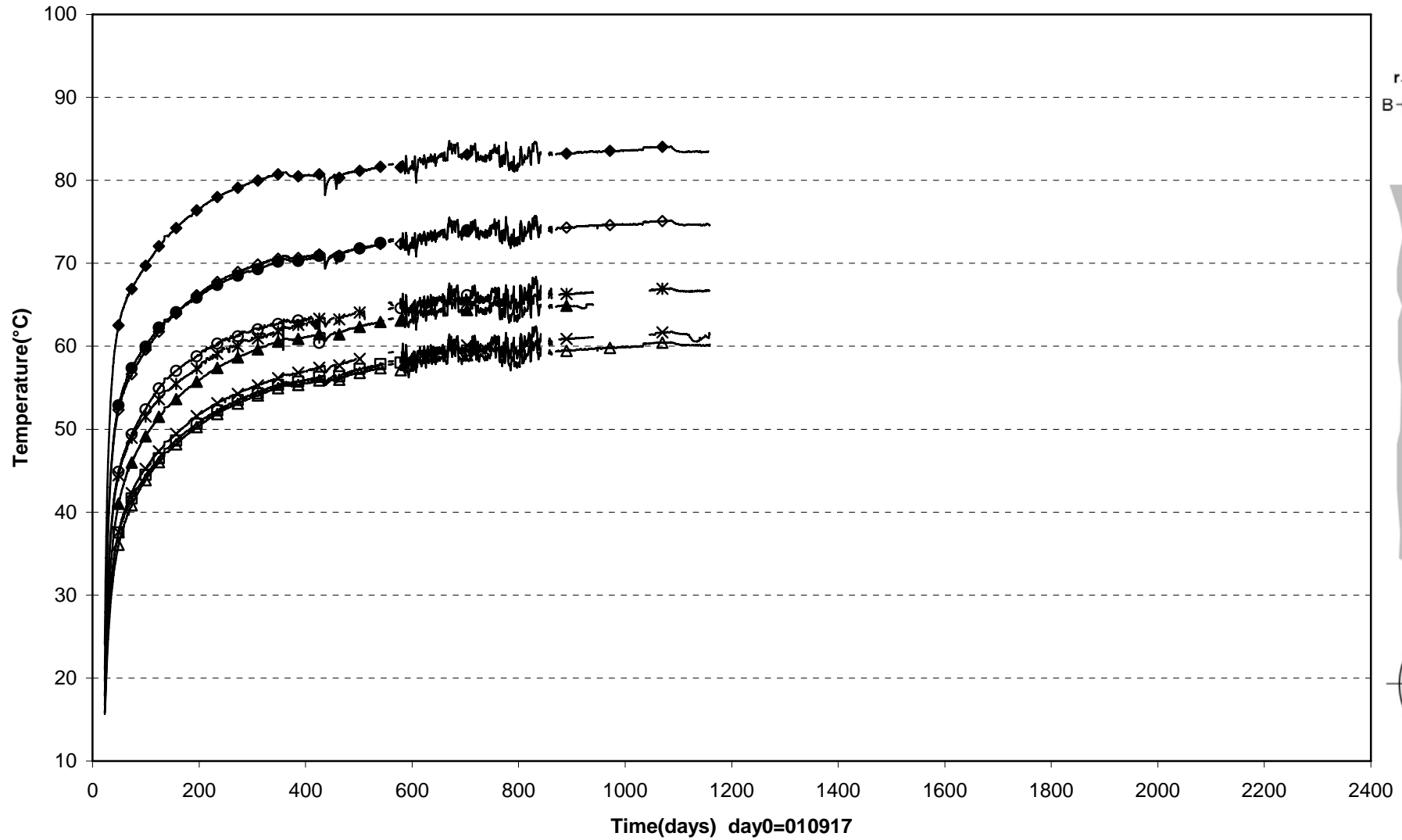

c

Prototype\Hole 3\Ring5 (010917-071201)  
 Temperature - Pentronic

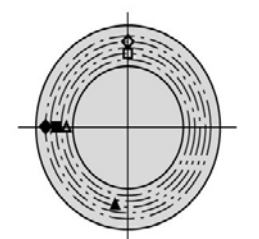
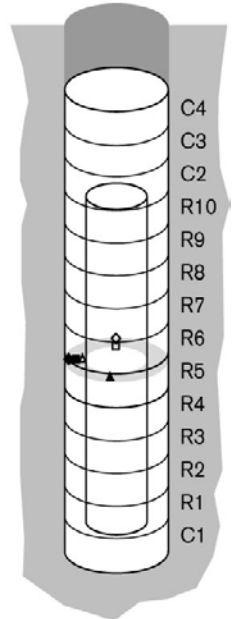
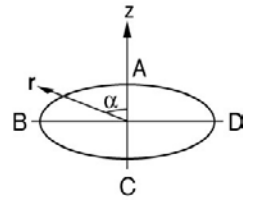
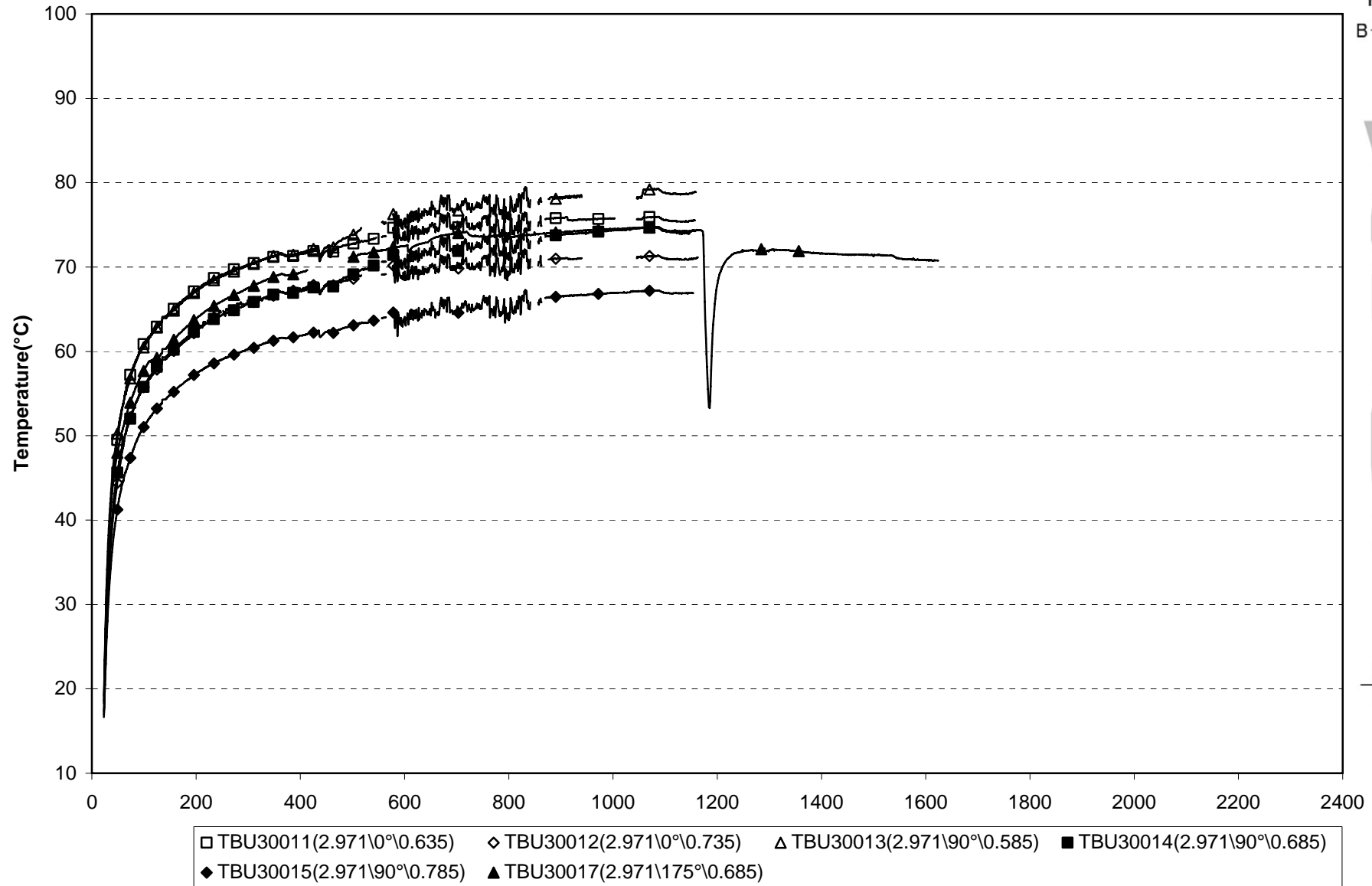

Prototype\Hole 3\Ring5 (010917-071201)  
 Temperature - Pentronic

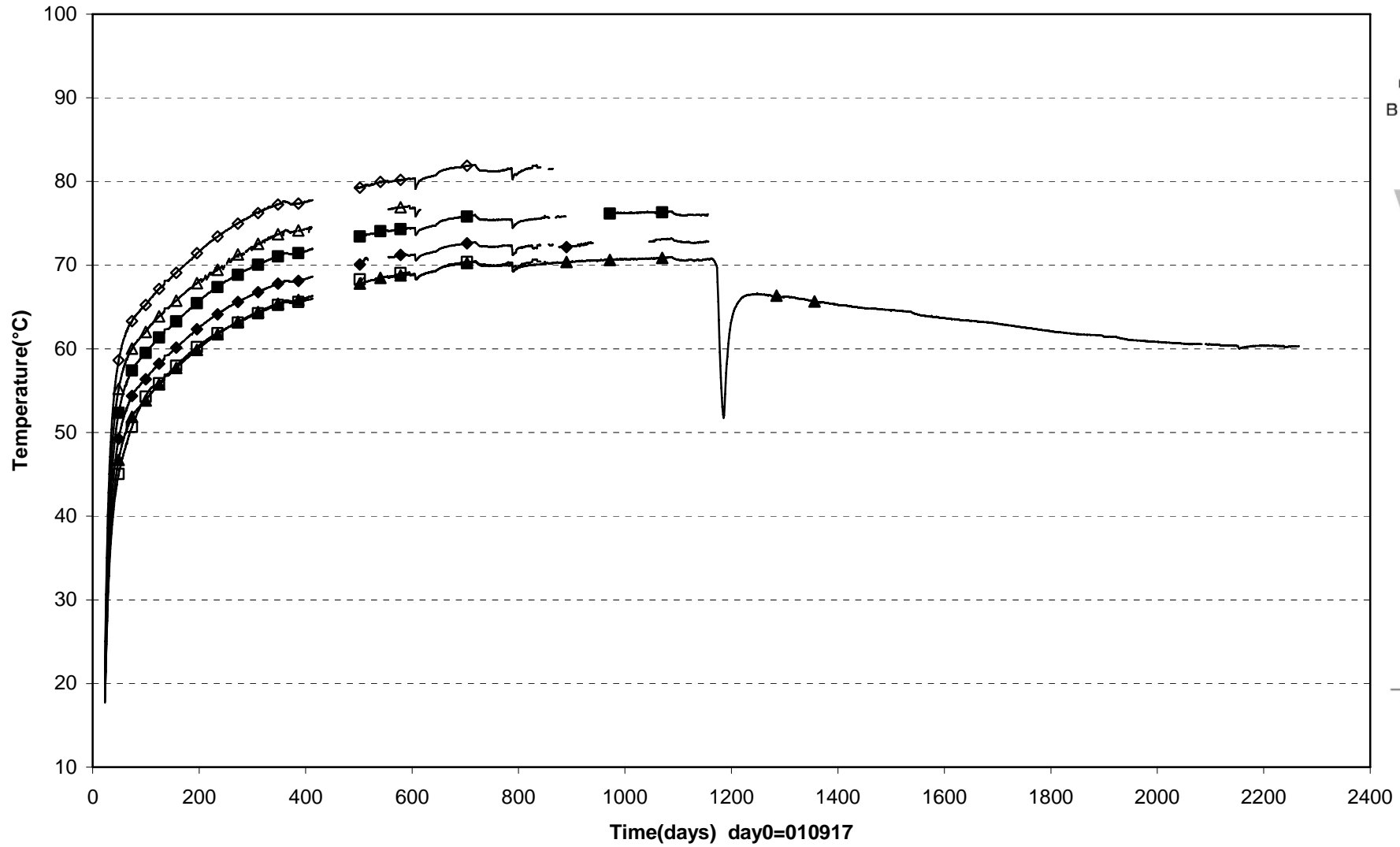

□ TBU30018(2.971\175°\0.735) ◇ TBU30019(2.971\270°\0.585) △ TBU30020(2.971\270°\0.635) ■ TBU30021(2.971\270°\0.685)  
 ◆ TBU30022(2.971\270°\0.735) ▲ TBU30023(2.971\270°\0.785)

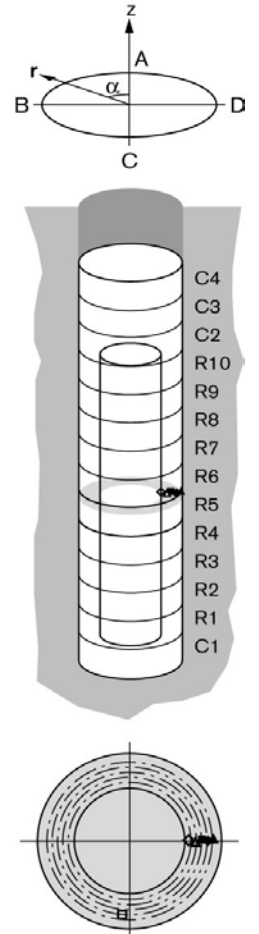

Prototype\Hole 3\Ring10 (010917-071201)  
 Temperature - Pentronic

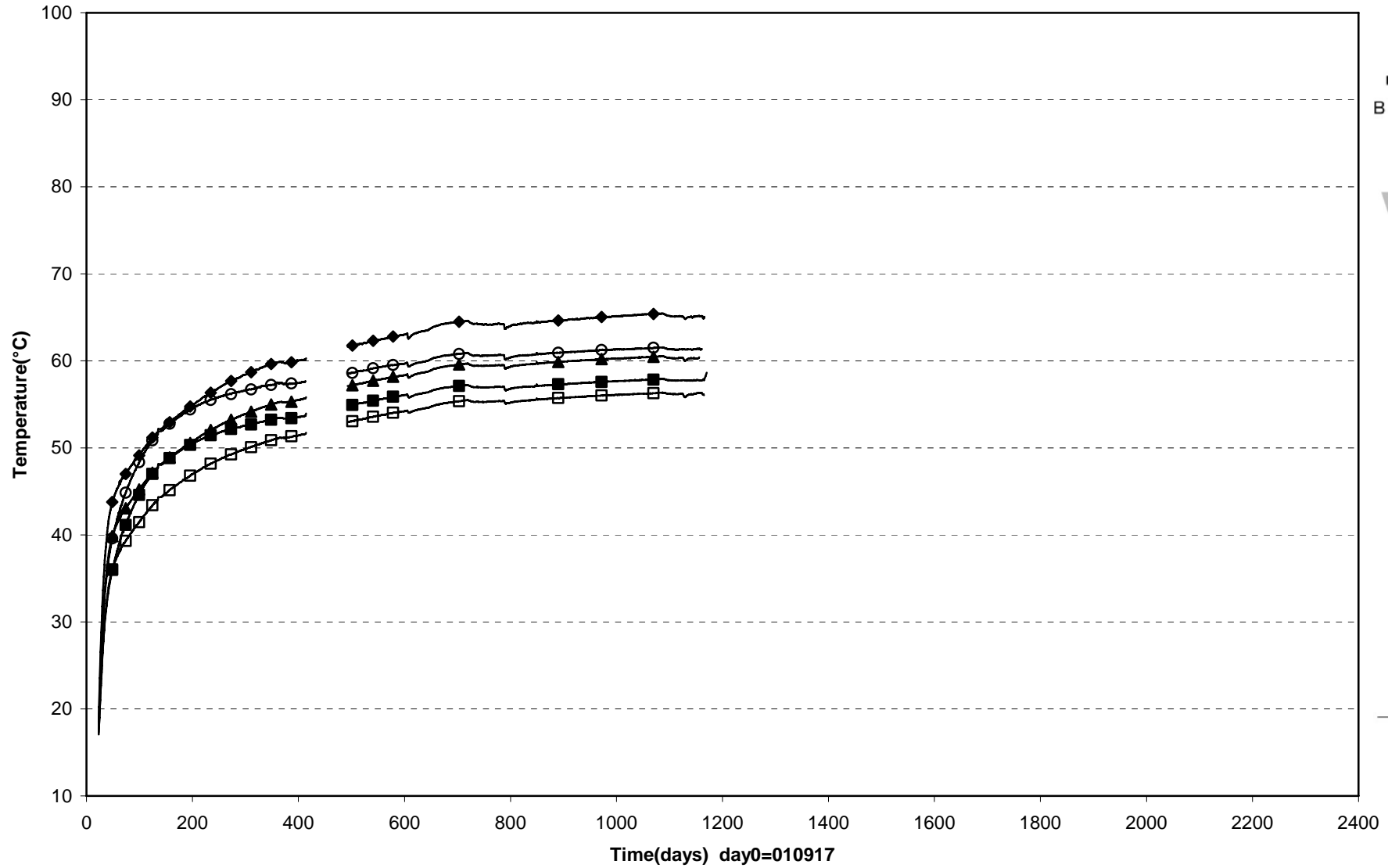



Prototype\Hole 3\Cyl.3 and Cyl.4 (010917-071201)  
 Temperature - Pentronic

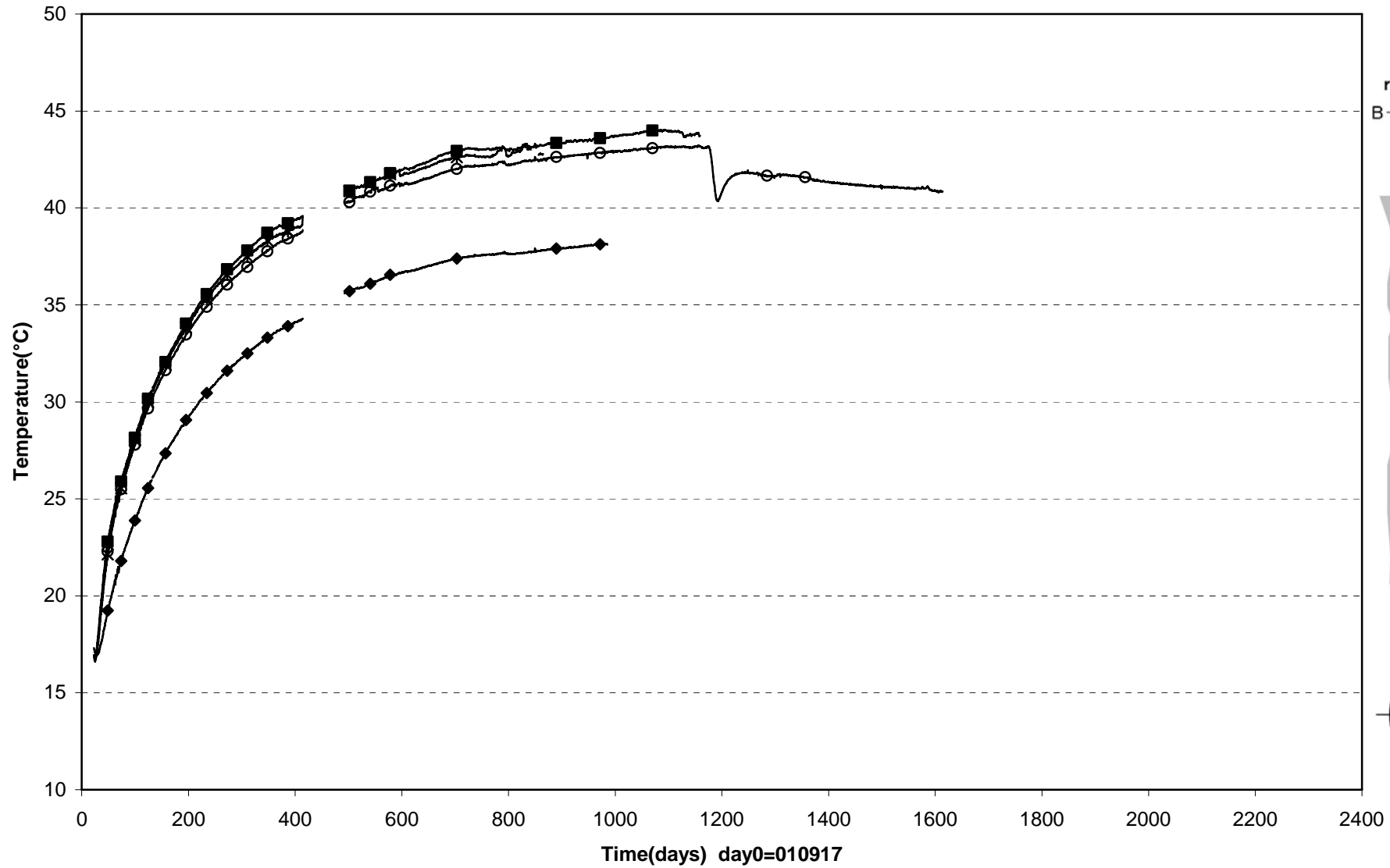

x TBU30029(6.314\0°\0.785)  
 o TBU30030(6.314\95°\0.585)  
 ■ TBU30031(6.314\185°\0.585)  
 ◆ TBU30032(7.015\0°\0.785)

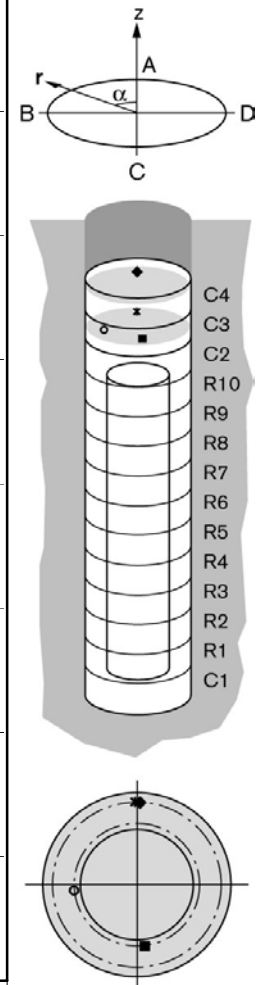

Prototype\Hole 3 (010917-071201)  
 Tempreture - Geokon

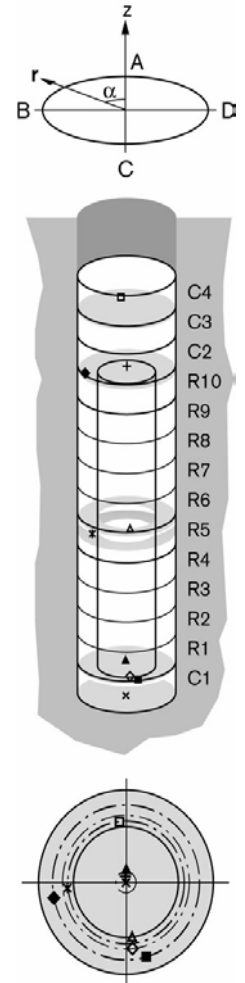
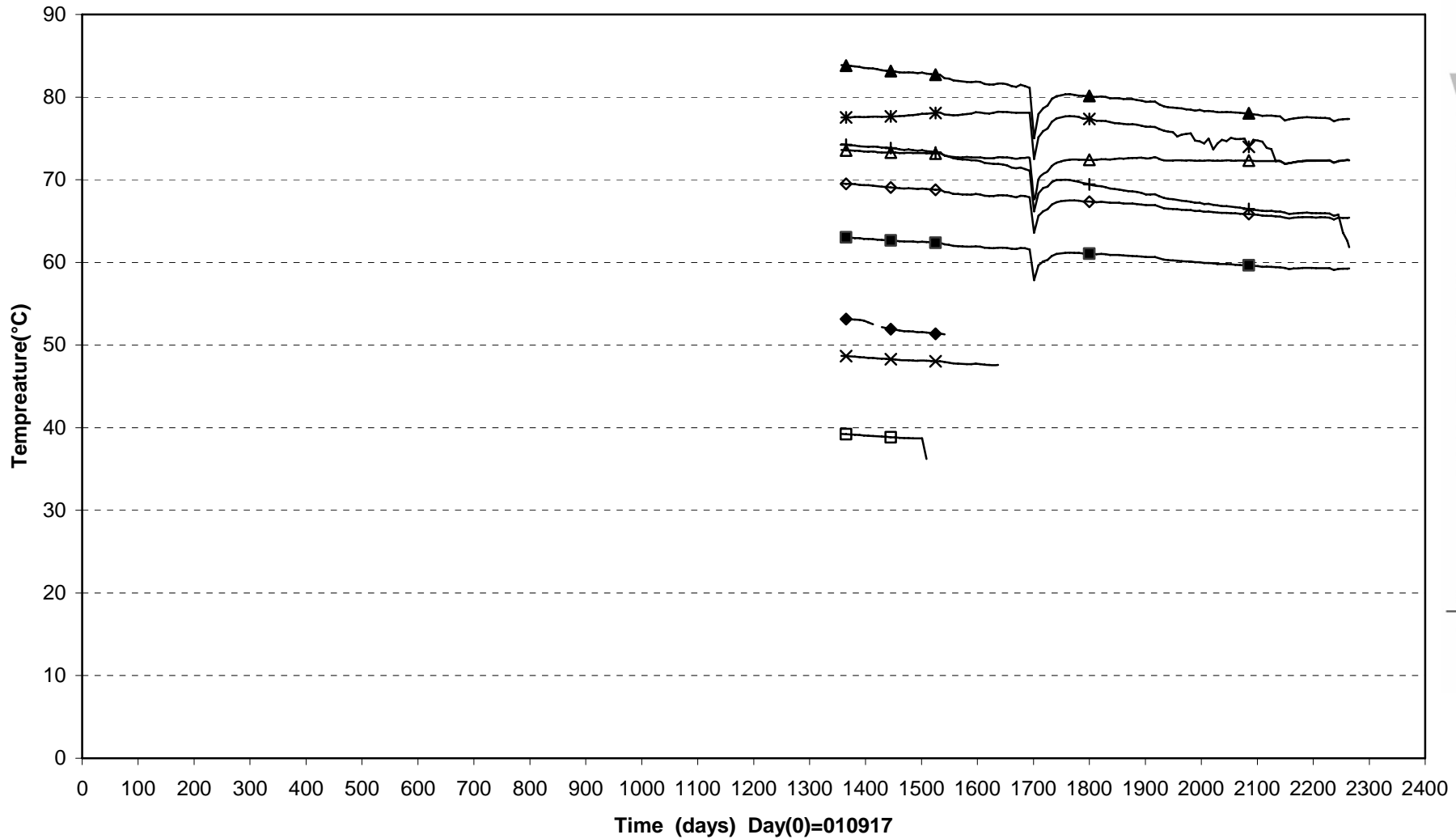

- |                              |                            |                              |                              |                             |
|------------------------------|----------------------------|------------------------------|------------------------------|-----------------------------|
| × PBU30001(0\0°\0)           | ▲ PBU30002(0.495\0°\0.100) | ◇ PBU30008(0.495\185°\0.635) | ■ PBU30009(0.495\195°\0.735) | ✱ PBU30013(2.771\95°\0.585) |
| △ PBU30015(3.021\185°\0.535) | + PBU30017(5.556\0°\0.050) | ◆ PBU30022(5.556\100°\0.735) | □ PBU30026(6.654\5°\0.585)   |                             |

Prototype\Hole 3 (010917-071201)  
 Tempreture - Geokon

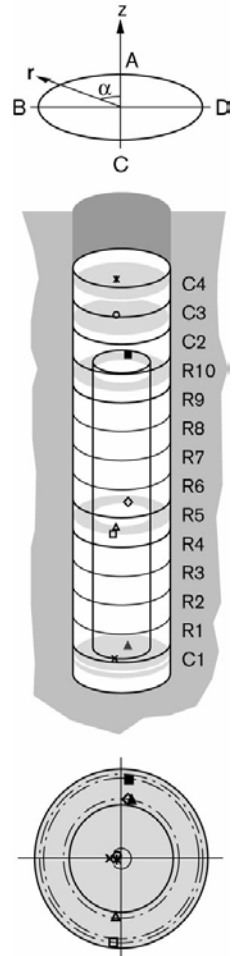
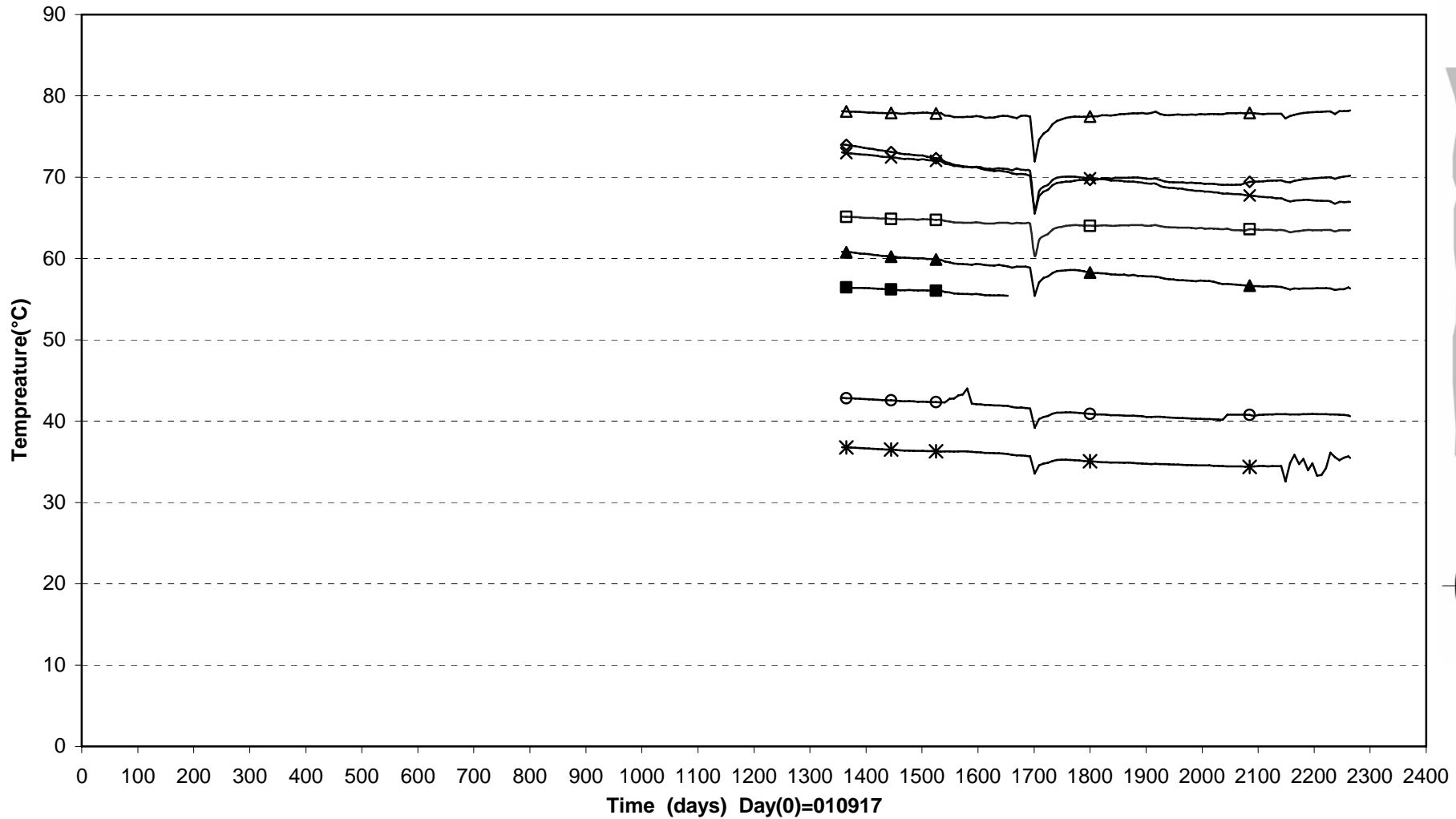

|  |                              |                              |  |
|--|------------------------------|------------------------------|--|
| × UBU30002(0.245\90°\0.100)              | ▲ UBU30003(0.335\355°\0.585) | ◇ UBU30005(2.771\355°\0.585) | △ UBU30009(2.771\175°\0.535\in the slot) |
| □ UBU30010(2.771\175°\0.825\in the slot) | ■ UBU30012(5.306\355°\0.785) | ○ UBU30013(6.314\90°\0.050)  | ✱ UBU30014(6.910\90°\0.050)              |

Prototype\Rock\Hole 3 (010917-071201)  
 Temperature - Pentronic

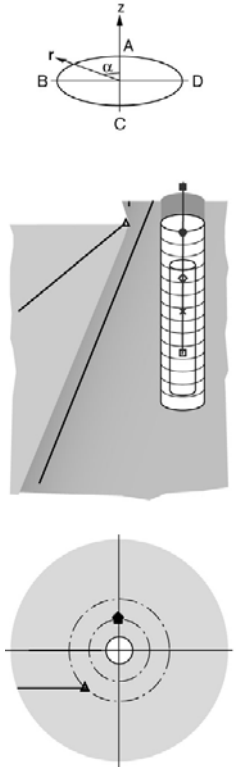
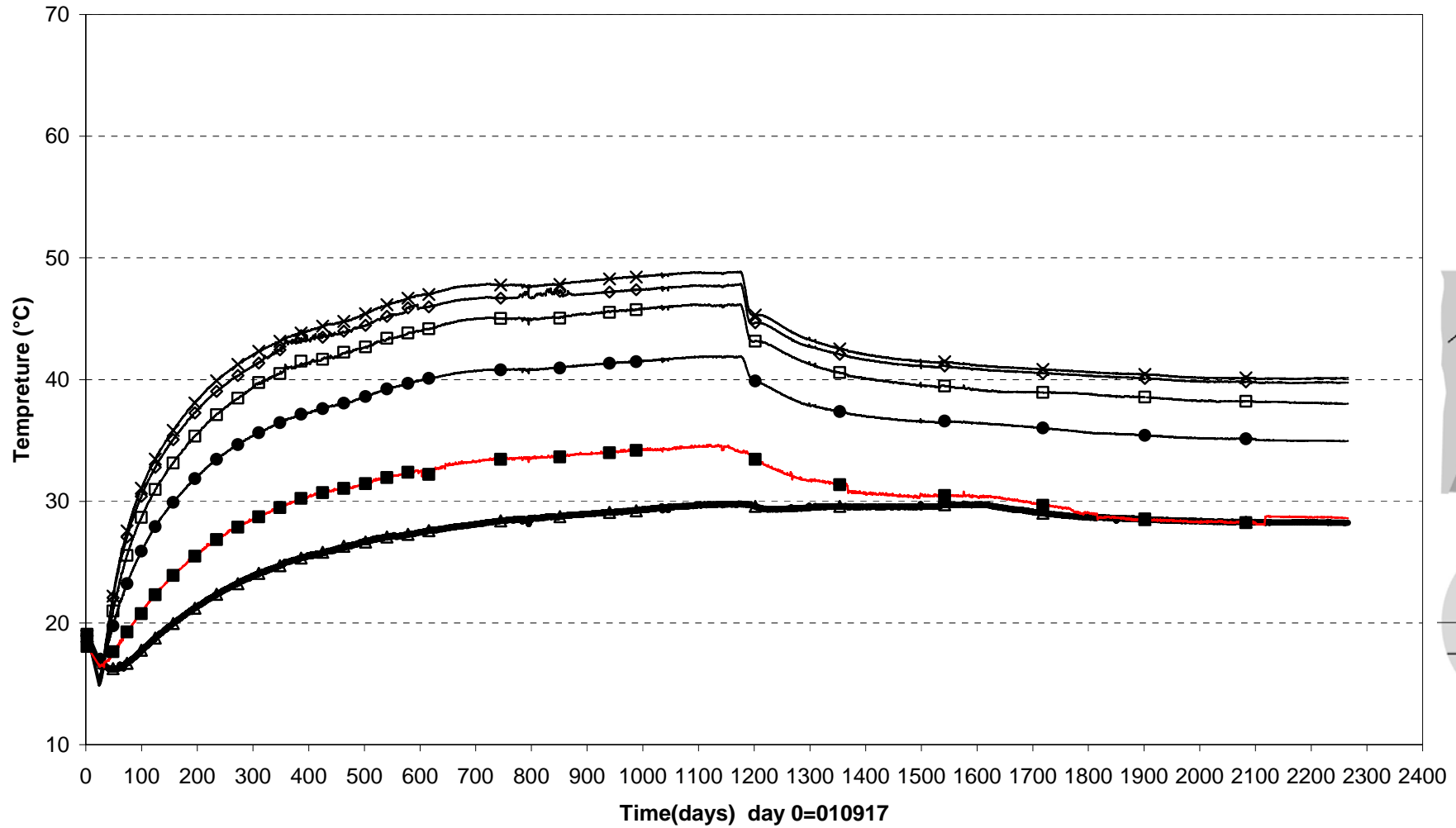

Prototype\Rock\Hole 3 (010917-071201)  
Temperature - Pentronic

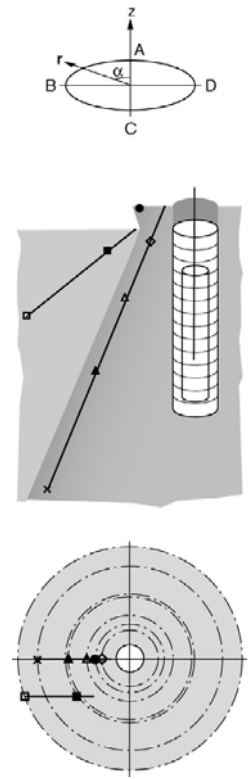
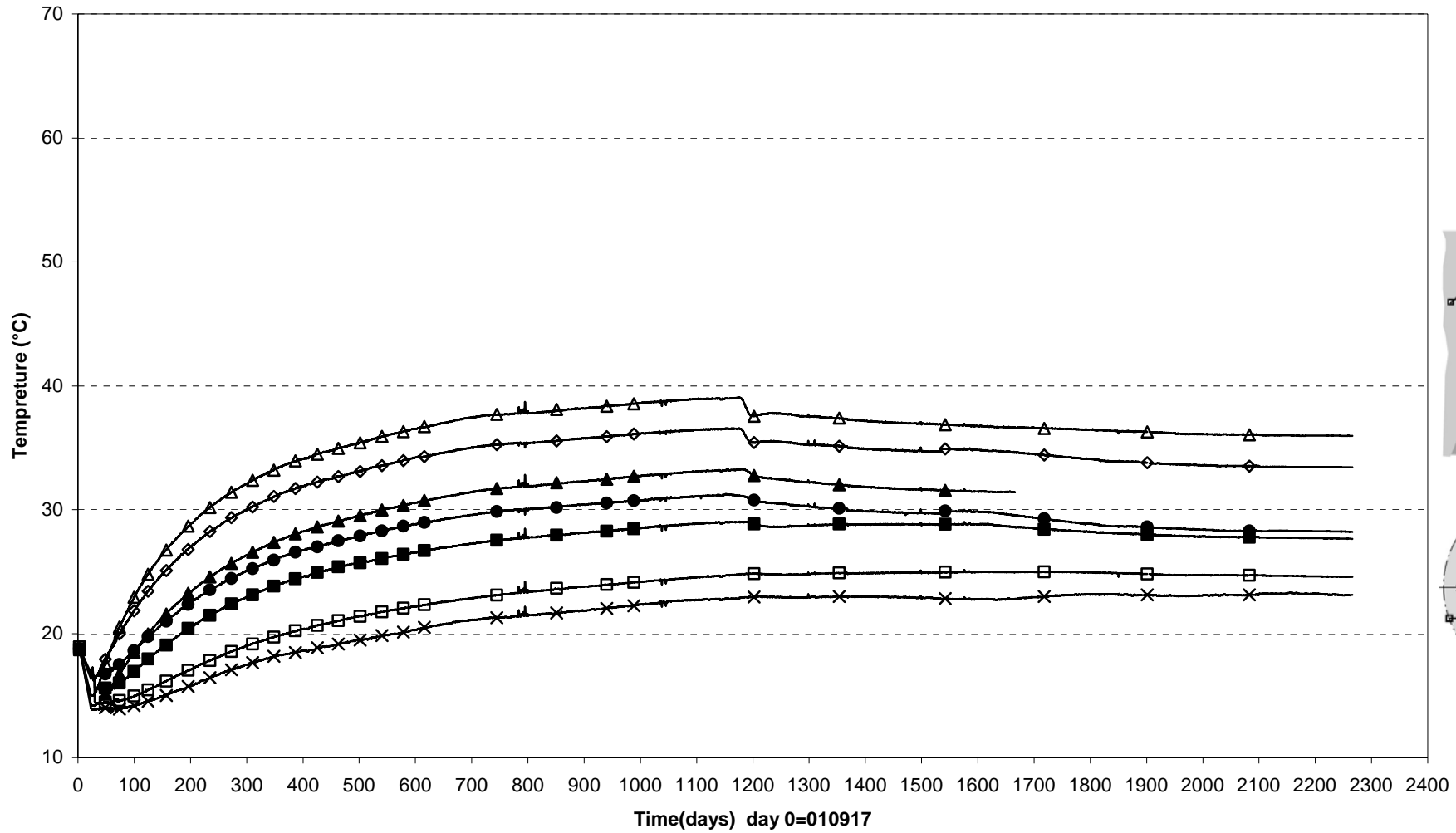

- |                              |                              |                              |                               |
|------------------------------|------------------------------|------------------------------|-------------------------------|
| ● TROA2330(7.924\90°\2.169)  | ◇ TROA2320 (6.632\90°\1.787) | □ TROA2310(4.640\109°\7.111) | ■ TROA2440 (7.174\124°\4.088) |
| △ TROA2430 (4.319\90°\2.737) | ▲ TROA2420(1.451\89°\3.914)  | × TROA2410(-3.295\89°\5.861) |                               |

Prototype\Hole 3\ On canister top (010917-071201)  
Temperature - Pentronic

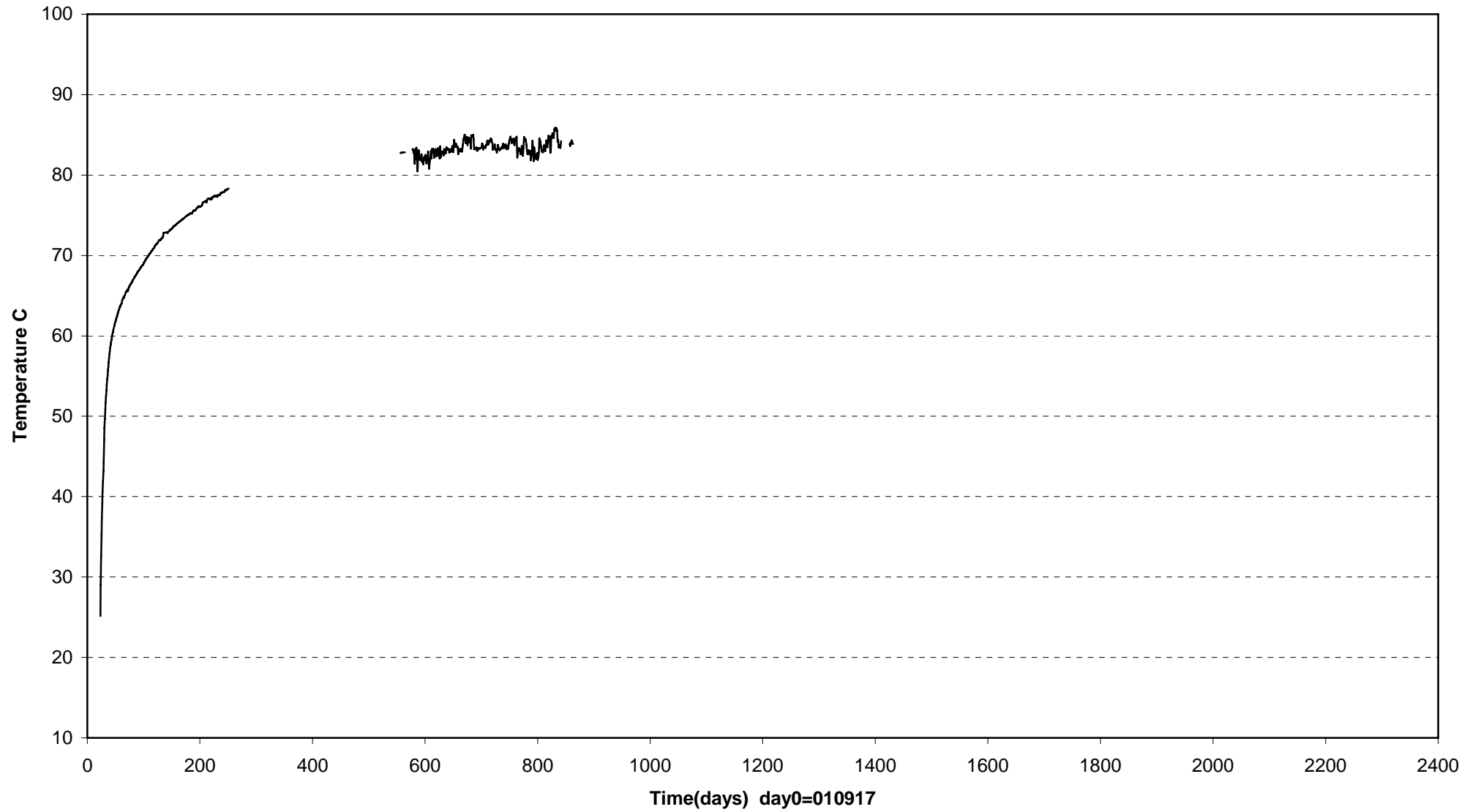

— TBU30016(5394\329°\410)-On canister top )

Prototype\ Hole 3 (010917-071201)  
Canister power

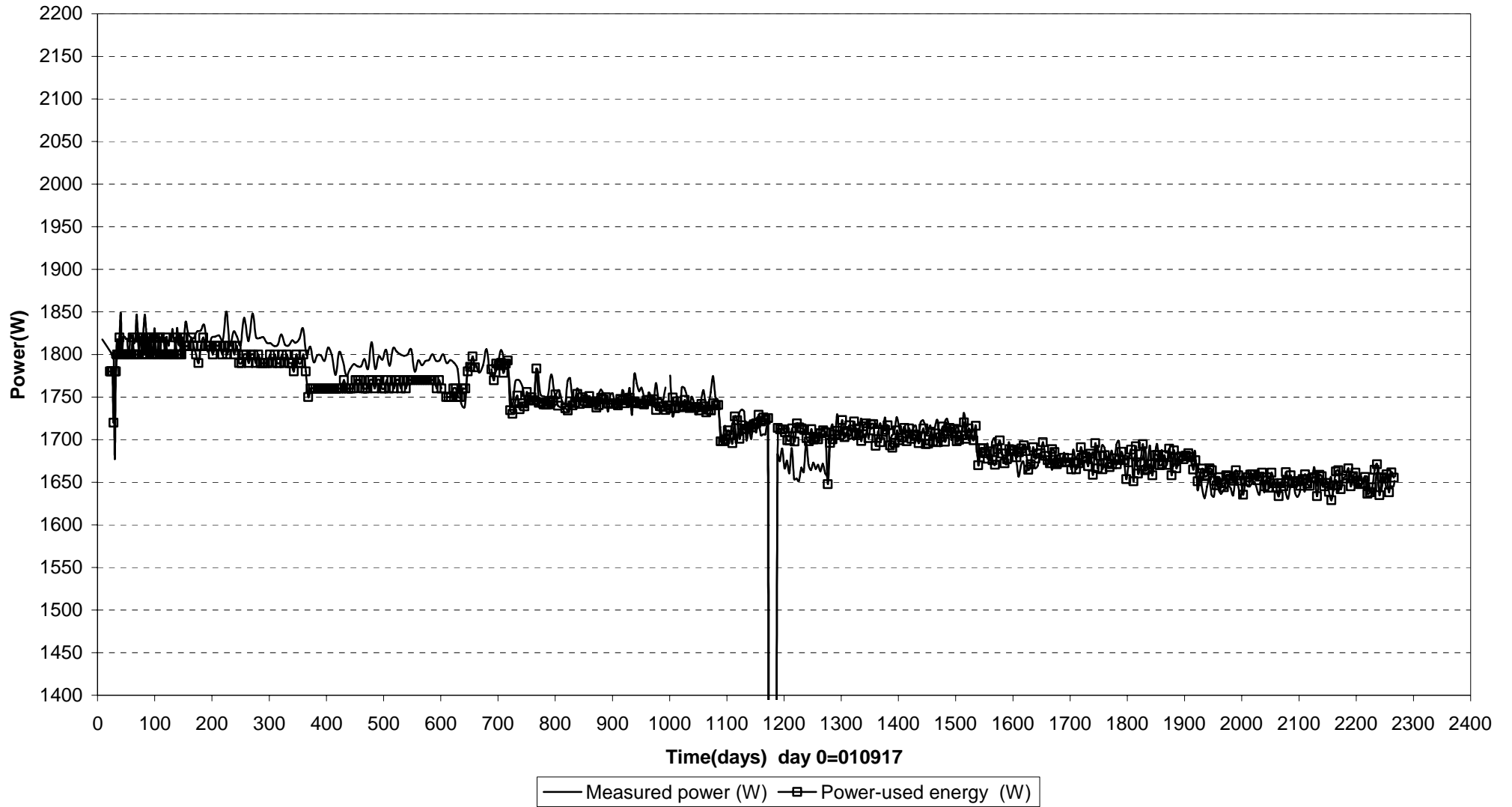

Prototype\ Hole 3 \Canister (010917-070601)  
 Max. temperature on the canister surface - Optical fibre cables

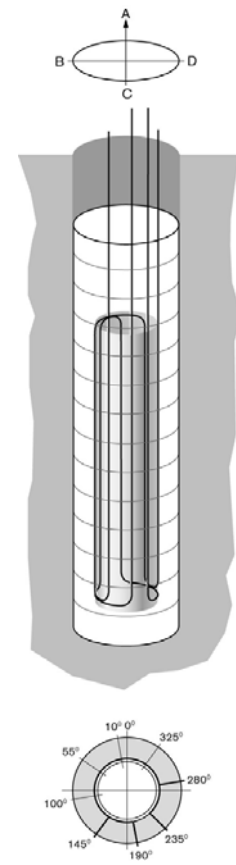
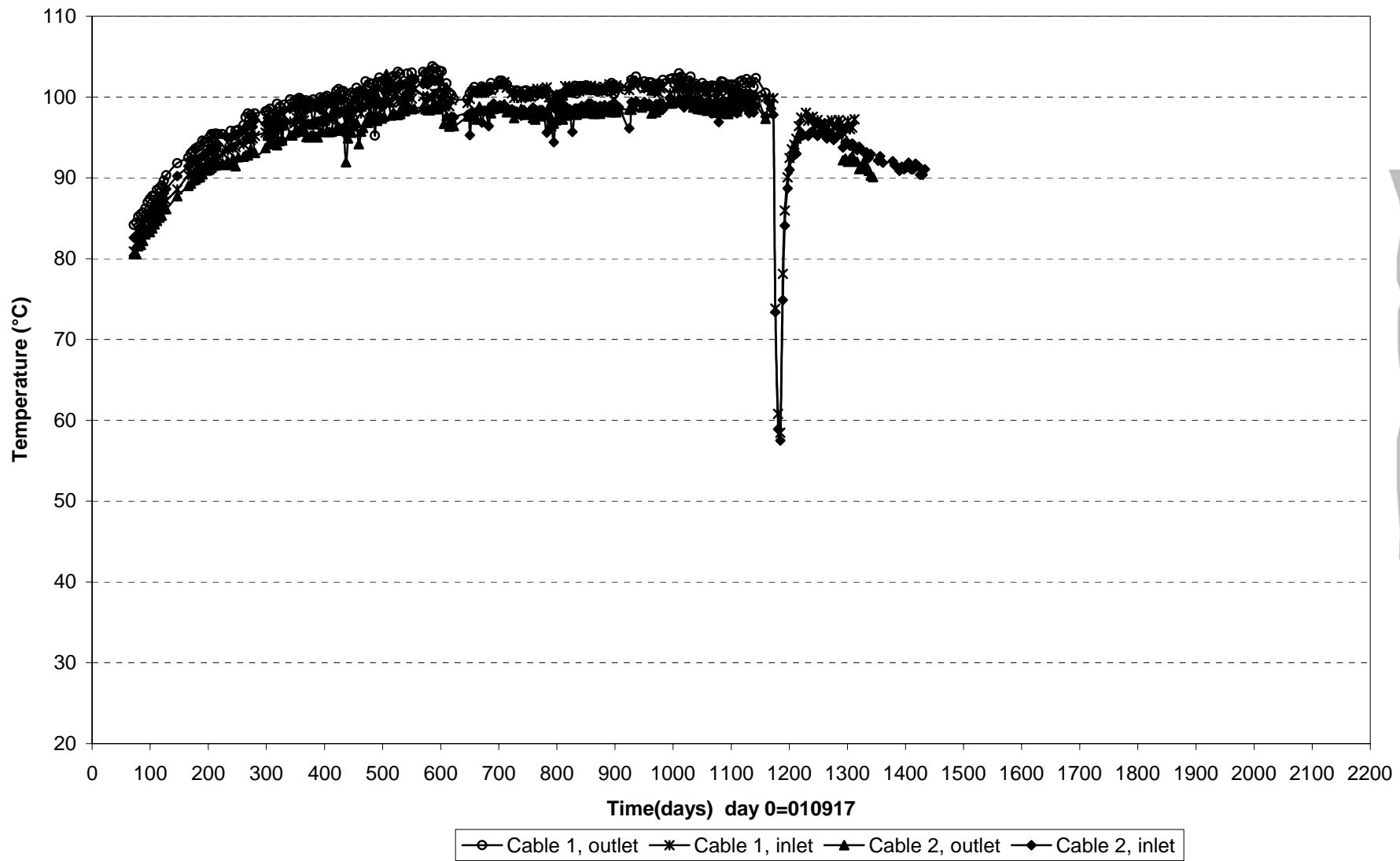



Prototype\ Hole 3 \Canister (050601)  
Temperature profile on the canister surface - Optical fiber cables

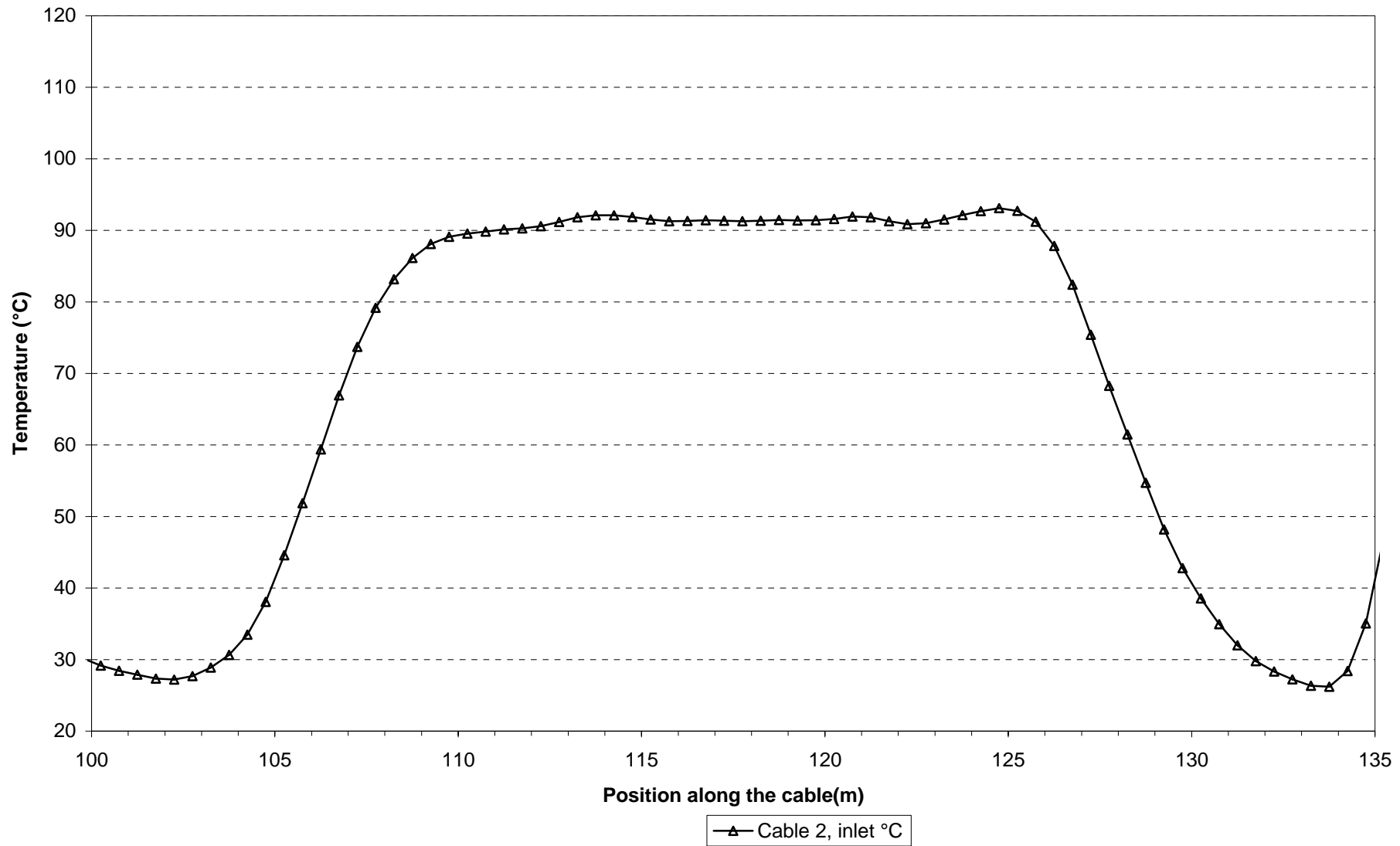



## **Appendix 3**

**Dep. holes 2 and 4**



Prototype\Rock\Hole 2 (010917-071201)  
 Temperature - Pentronic

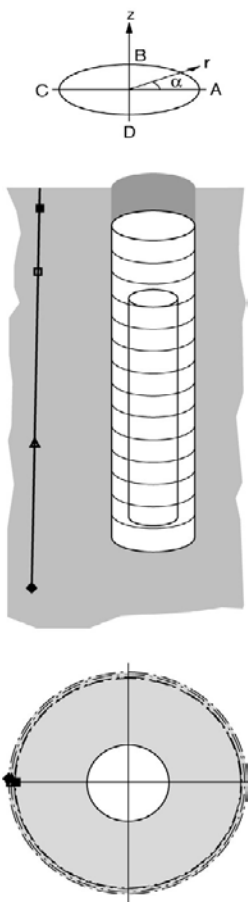
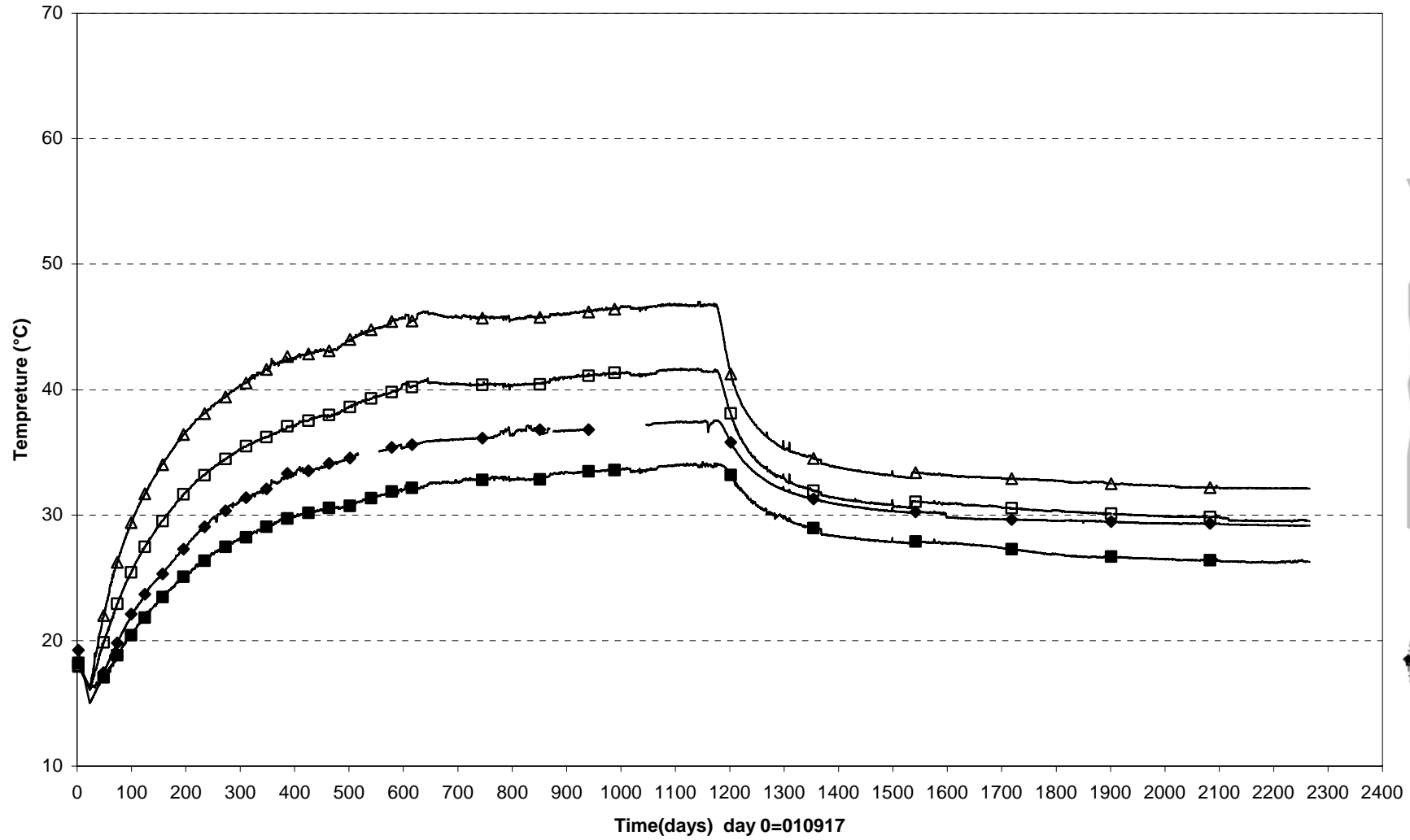

■ TROA1840(7.587\180°\2.404)    □ TROA1830 (6.087\180°\2.427)    △ TROA1820(2.138\179°\2.490)    ◆ TROA1810 (-1.162\179°\2.542)

Prototype\ Hole 2 (010917-071201)  
Canister power

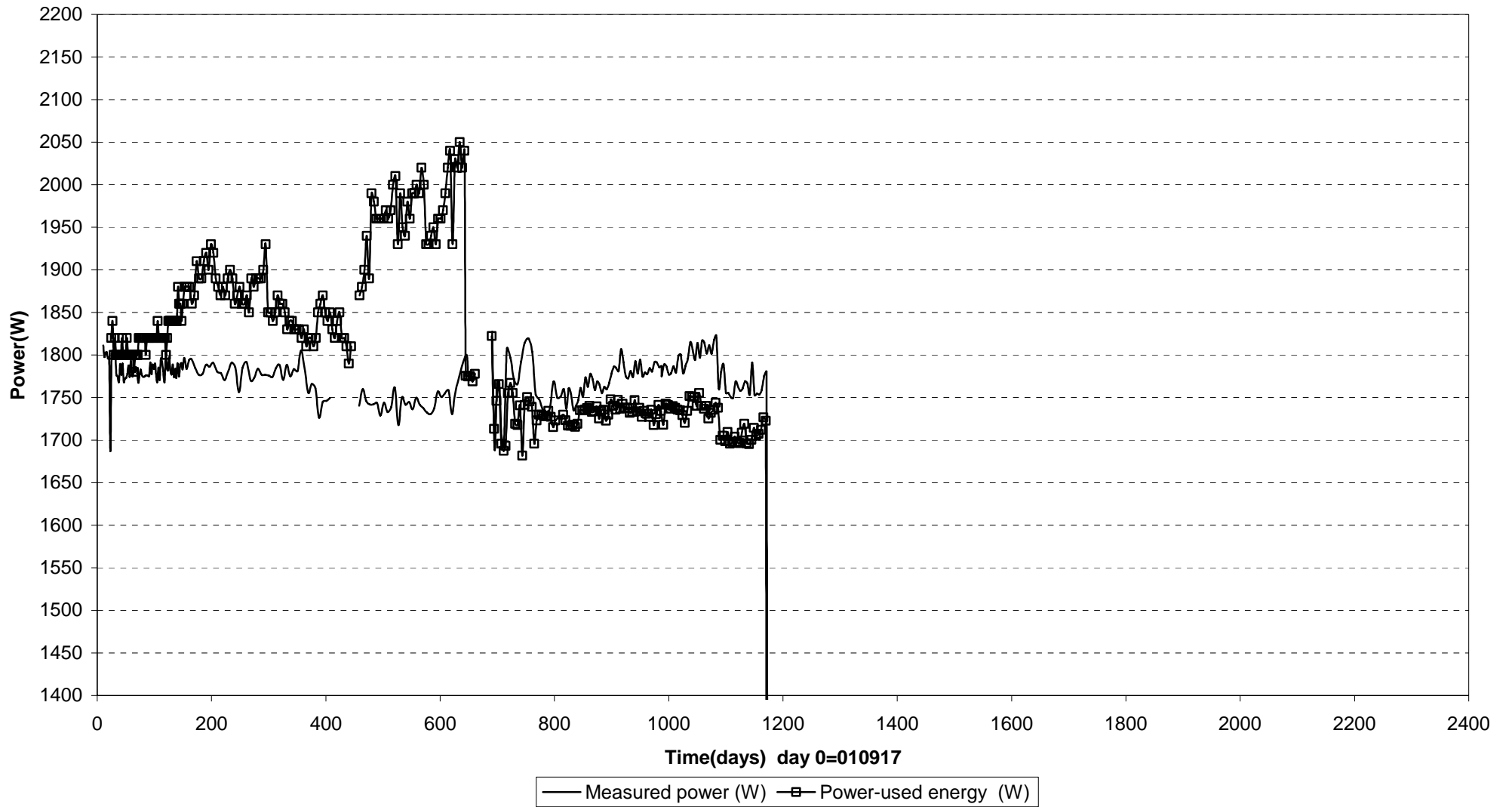

Prototype\ Hole 2 \Canister (010917-070601)  
 Max. temperature on the canister surface - Optical fiber cables

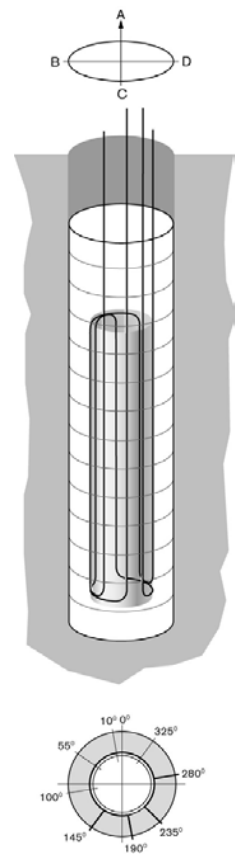
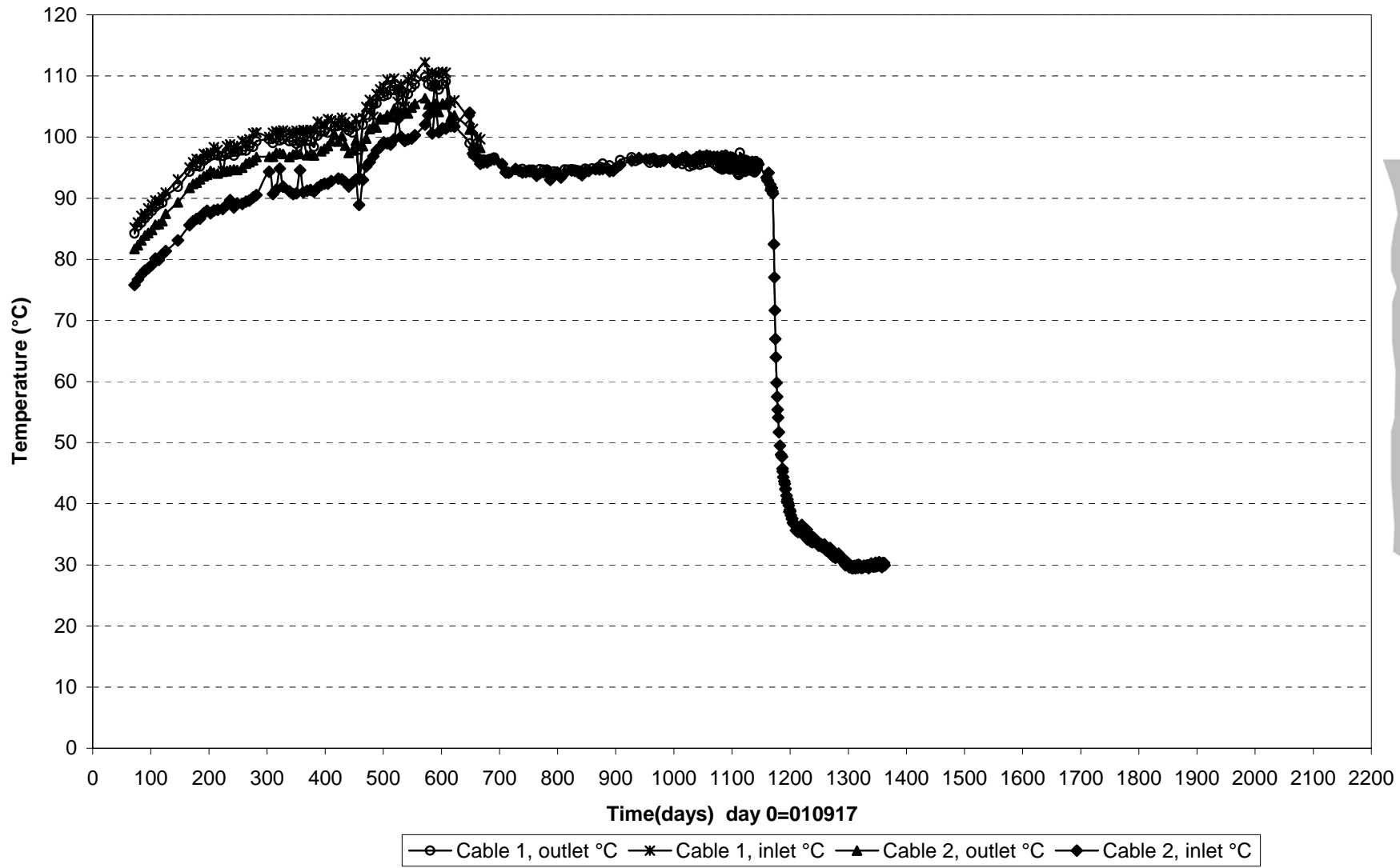

Prototype\ Hole 2 \Canister (050601)  
Temperature profile on the canister surface - Optical fiber cables

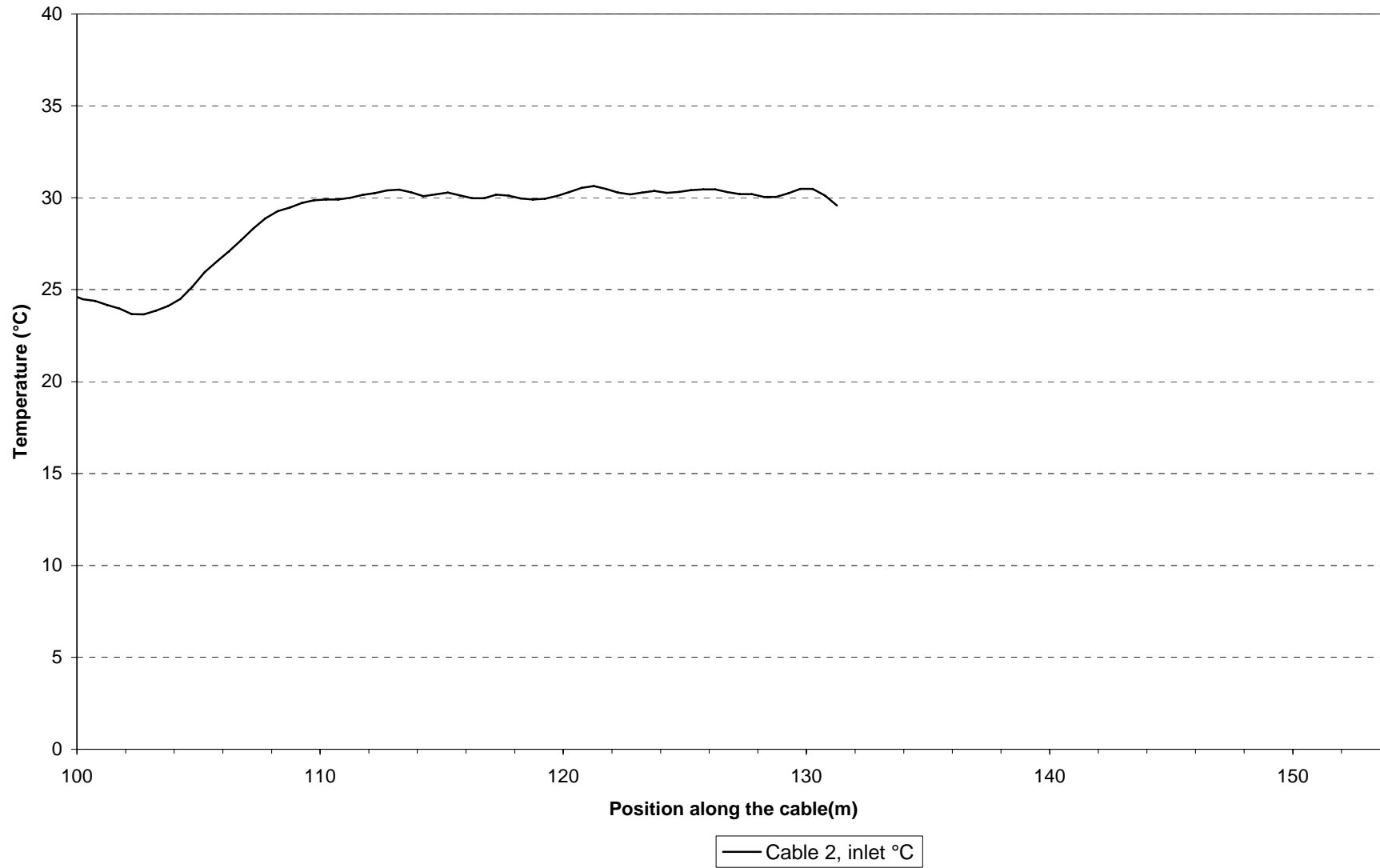



Prototype\Hole 2 \Canister top (010917-071201)

Temperature - Pentronic

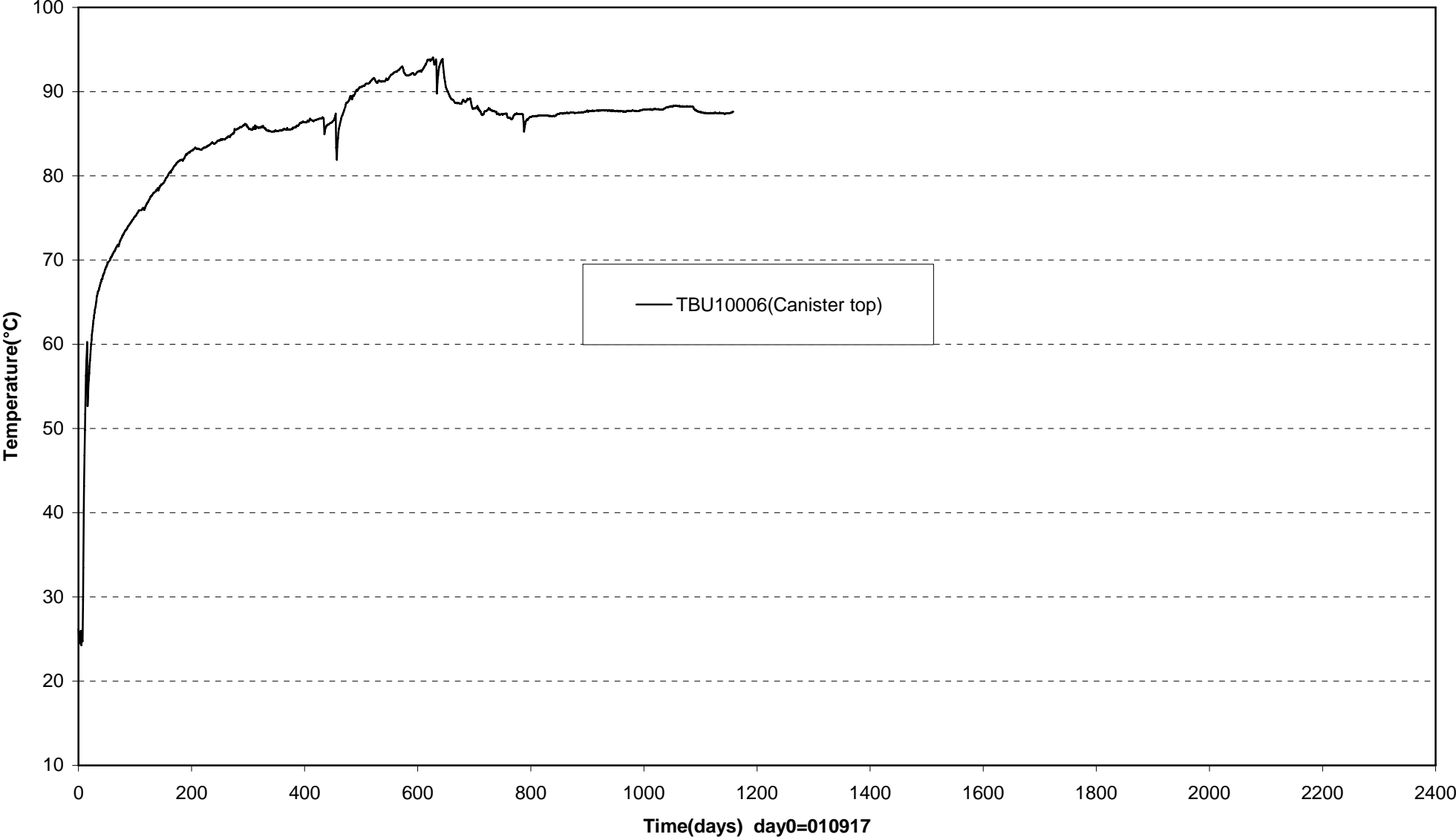

Prototype\Rock\Hole 4 (010917-071201)  
 Temperature - Pentronic

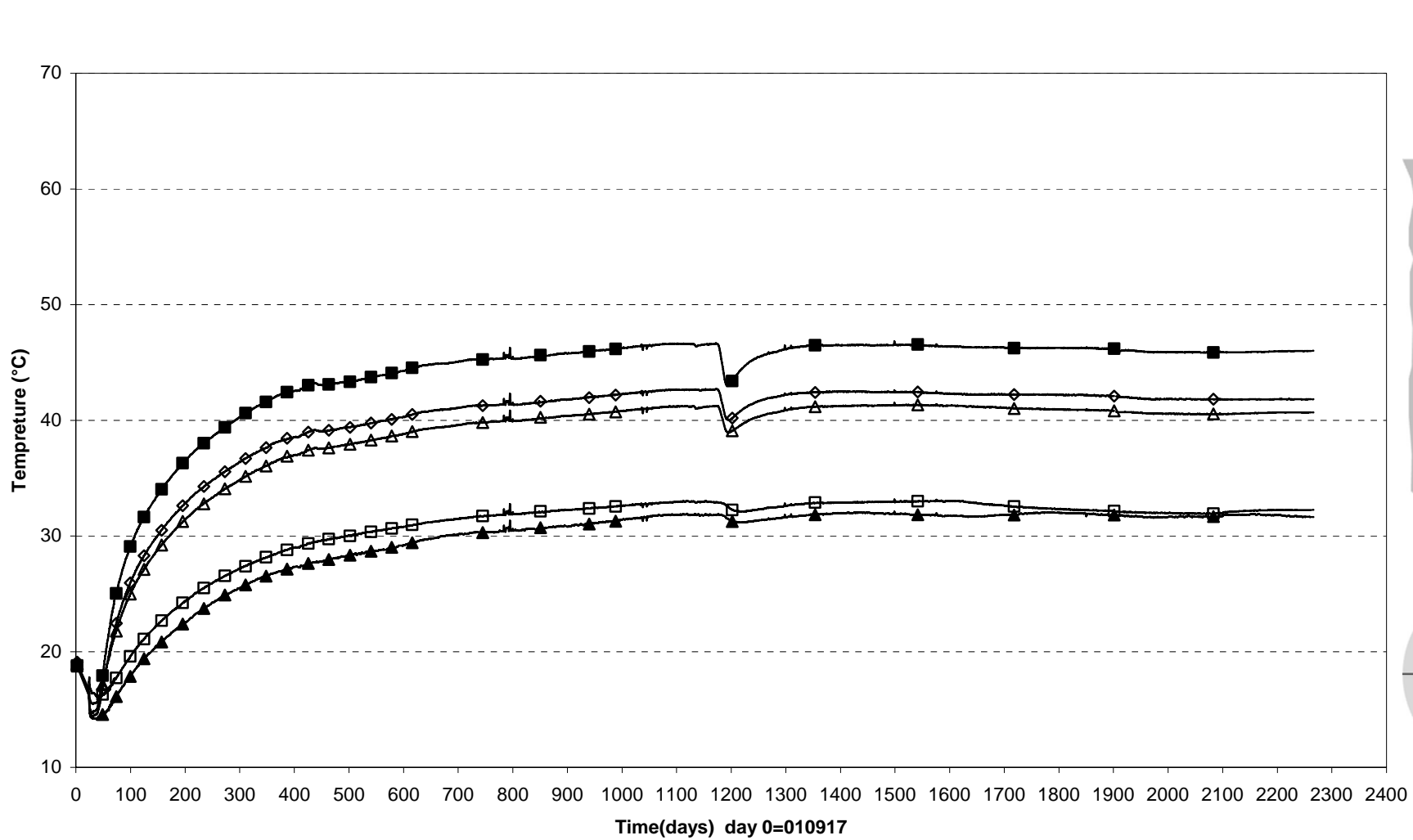

□ TROA3050 (7.671\360°\2.017)    △ TROA3040 (5.671\359°\2.025)    ■ TROA3030(3.271\358°\2.034)  
 ◇ TROA3020(0.871\358°\2.045)    ▲ TROA3010(-1.778\357°\2.056)

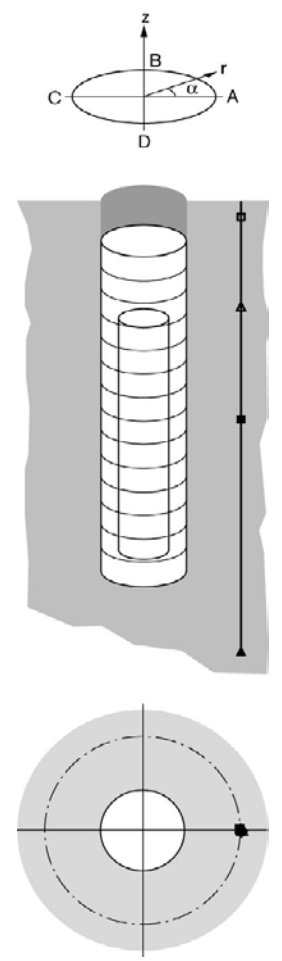

PrototypeHole 4 (010917-071201)  
Canister power

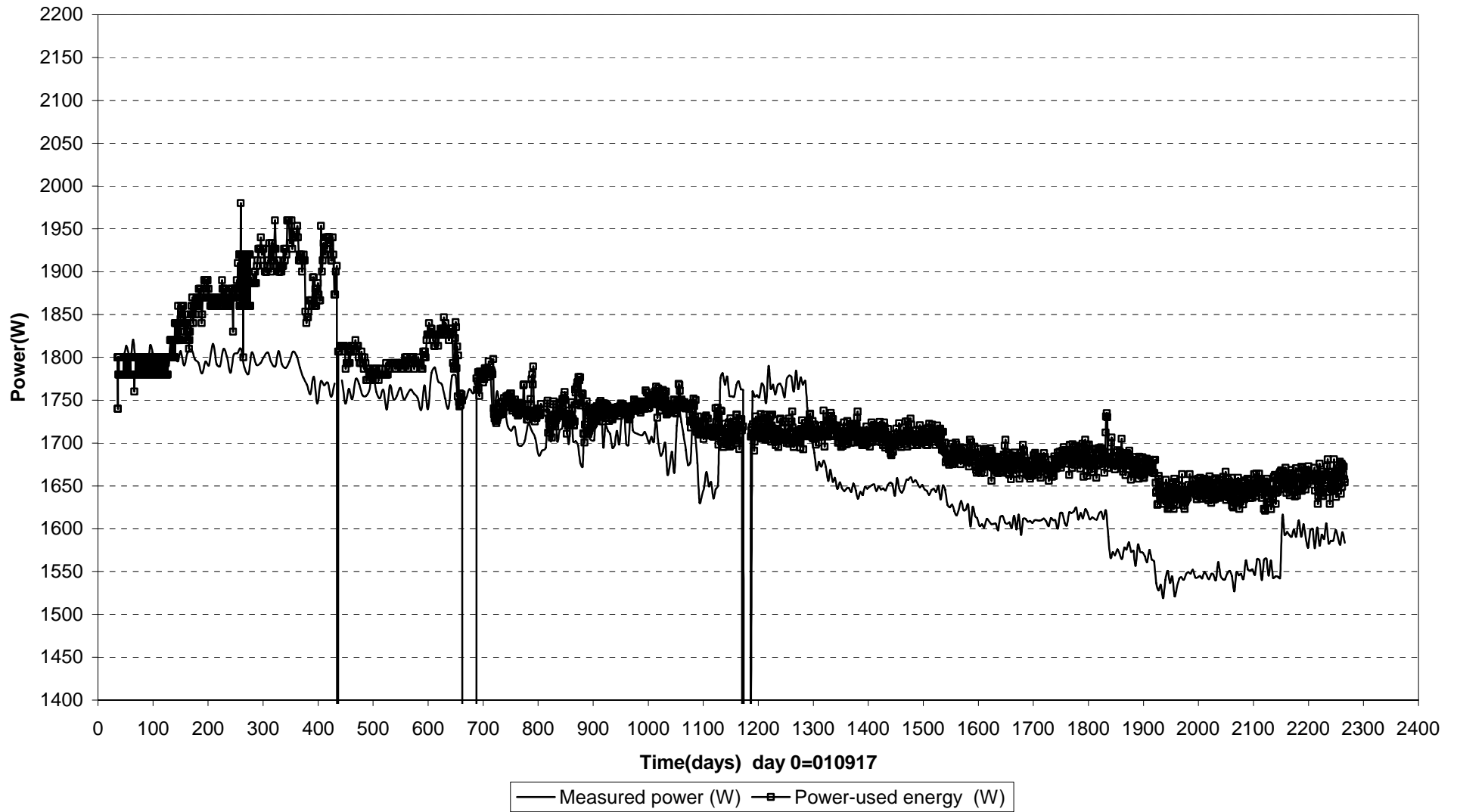

Prototype\ Hole 4 \Canister (010917-070601)  
 Max. temperature on the canister surface - Optical fiber cables

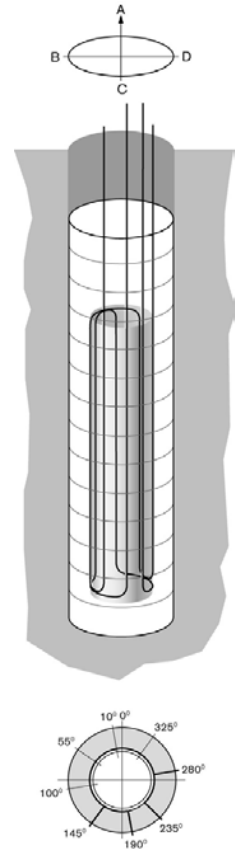
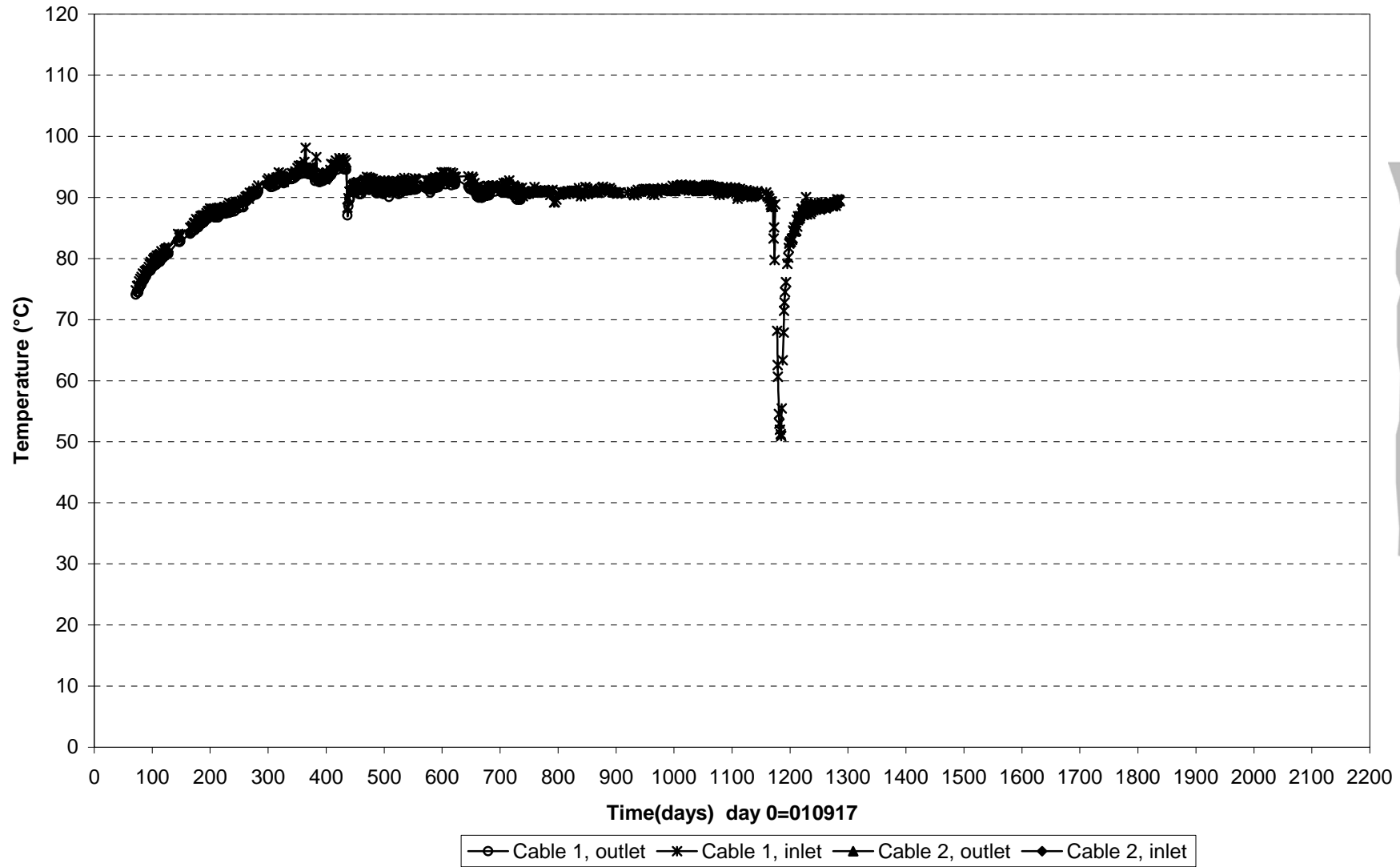

Prototype\ Hole 4\Canister (041130)  
Temperature profile on the canister surface - Optical fiber cables

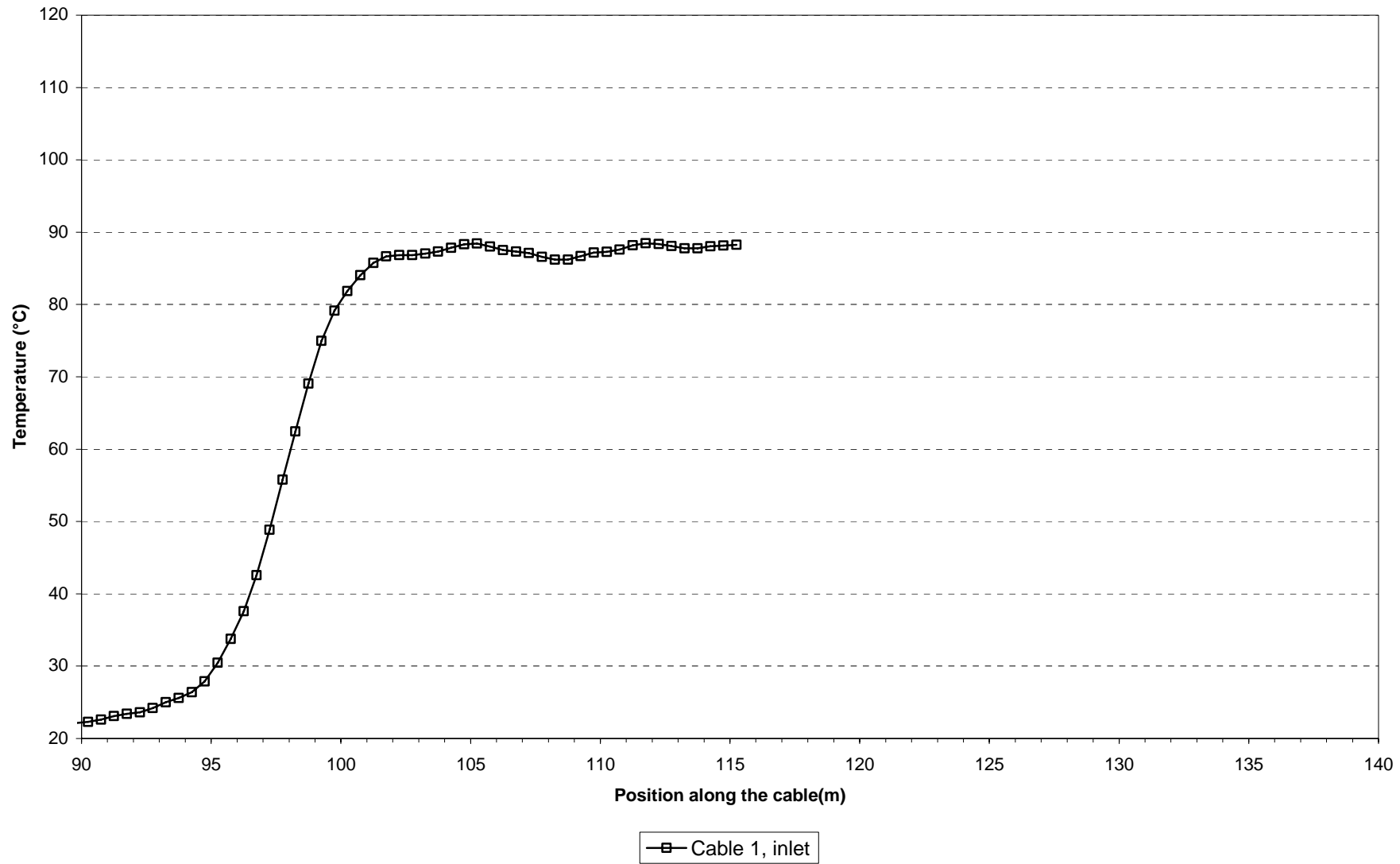



## **Appendix 4**

### **Backfill in section 1**





Prototype\Backfill\Section 1 (010917-071201)  
 Total pressure - Geokon

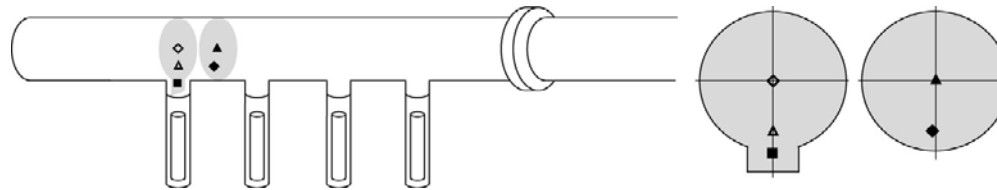
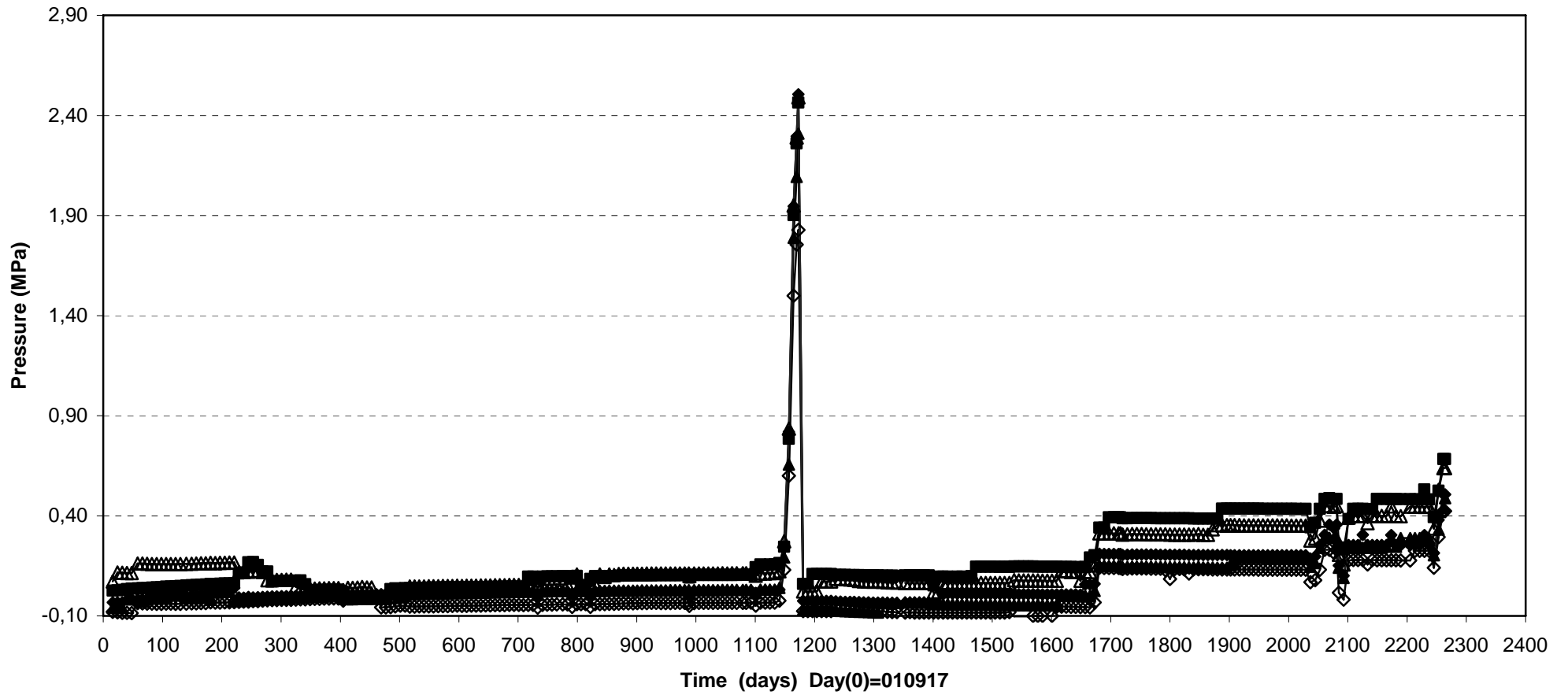

◇ PBA10002(E1\0\0\3587)    ▲ PBA10003(E1\0 \-1,8\3587)    ■ PBA10004(E1\0 \-2,6\3587)    ▲ PBA10008(F1-2\0\0\3584)    ◆ PBA10009(F1-2\0-0.1\-1,8\3584)

Prototype\Backfill\ Section 1 (010917-071201)  
 Total pressure - Geokon

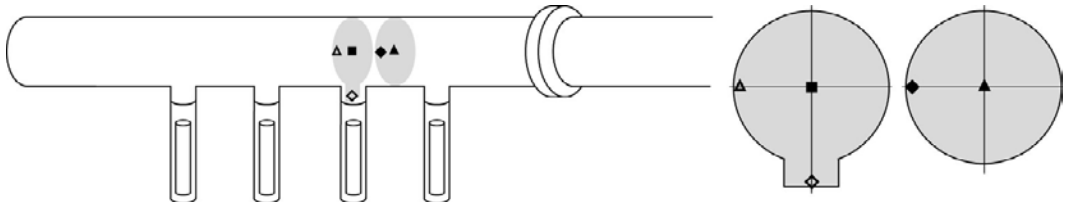
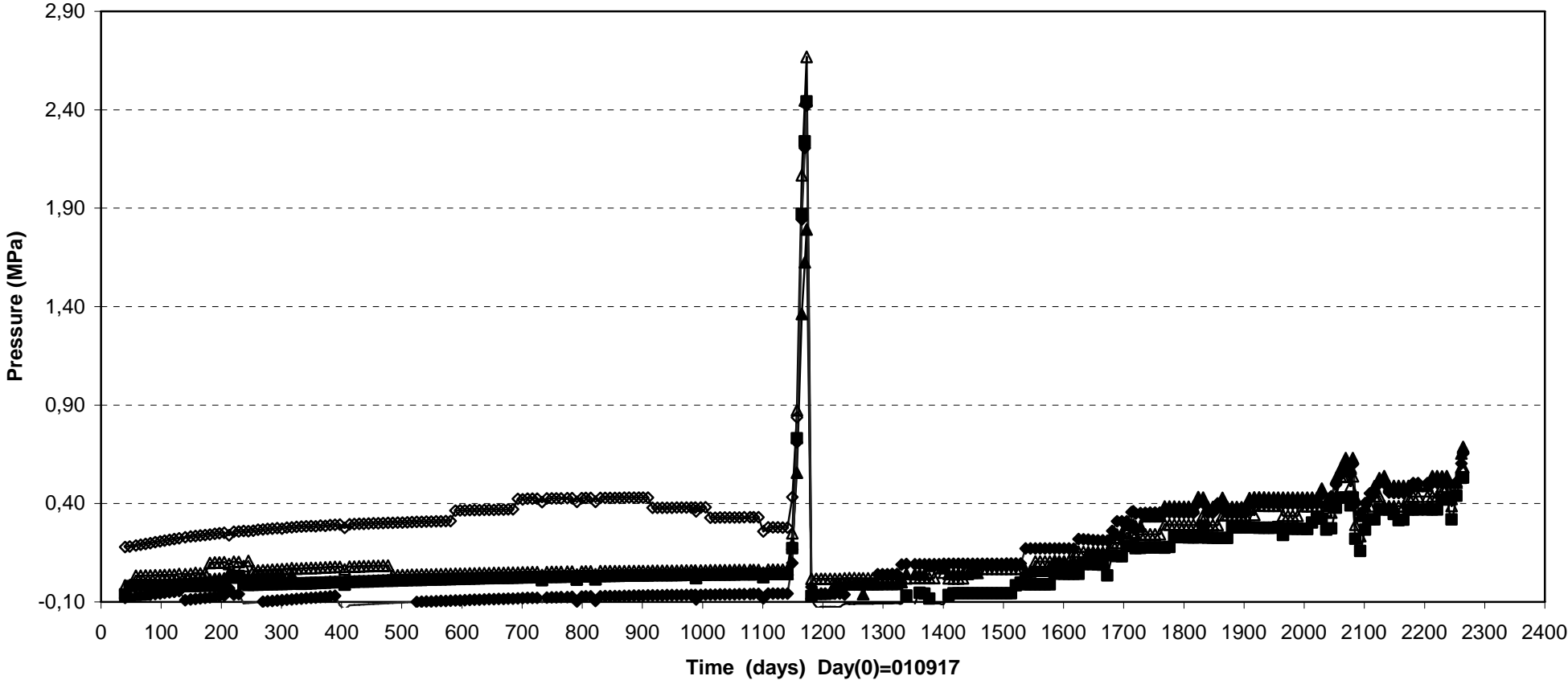

◊ PBA10015(E3\0\3.1\3575)    ▲ PBA10016(E3\2.3\0\3575)    ■ PBA10017(E3\0\0\3574)    ▼ PBA10018(F3-4\0\0\3572)    ◆ PBA10019(F3-4\0\2.3\3572)

Prototype\Backfill\Section 1 (041015-071201)  
 Total pressure - Kulite

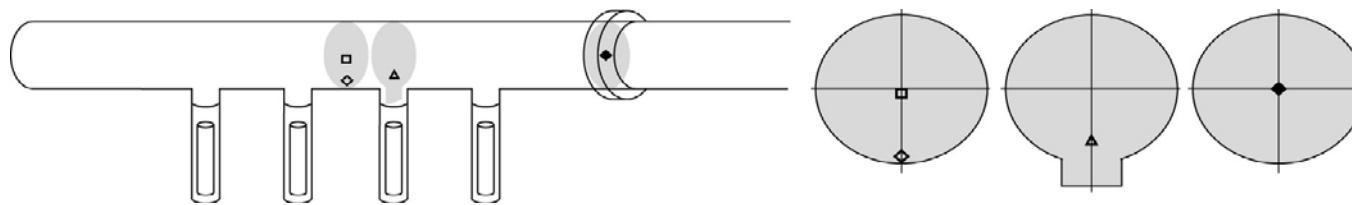
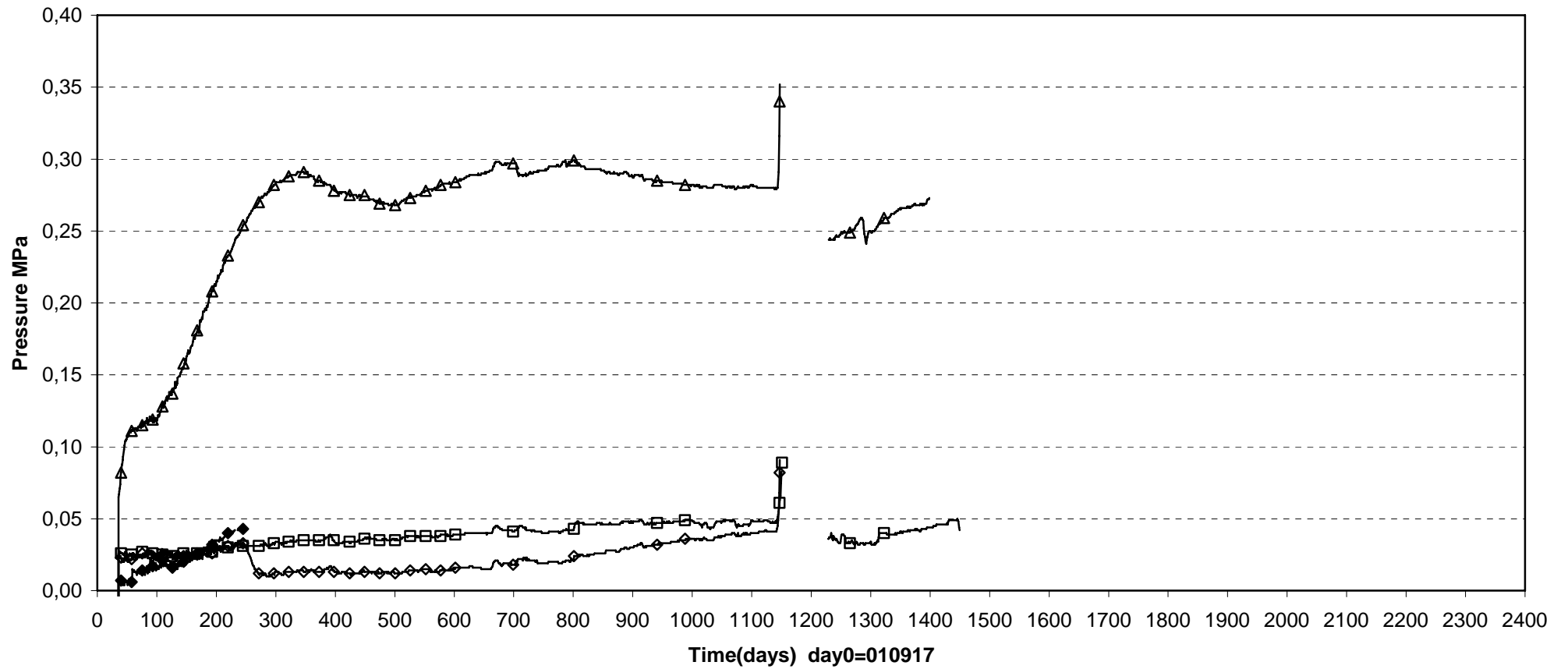

□ PBA10010(F1-2\0\ -0.2\3578)    ◇ PBA10011(F1-2\0\ -2.3\3578)    △ PBA10013(E3\0\ -1.82\3575)    ◆ PBA10020(In front of plug\0\0\3561)

Prototype\Backfill\Section 1 (010917-071201)  
Total pressure - Kulite

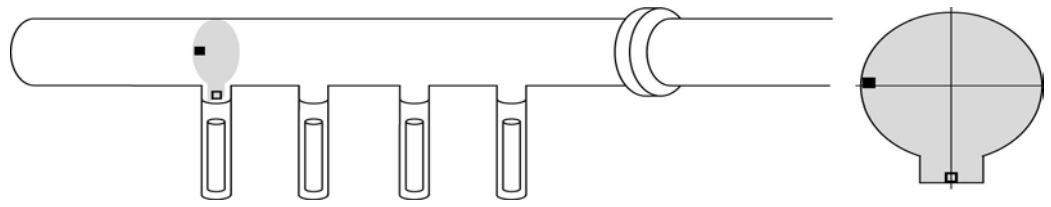
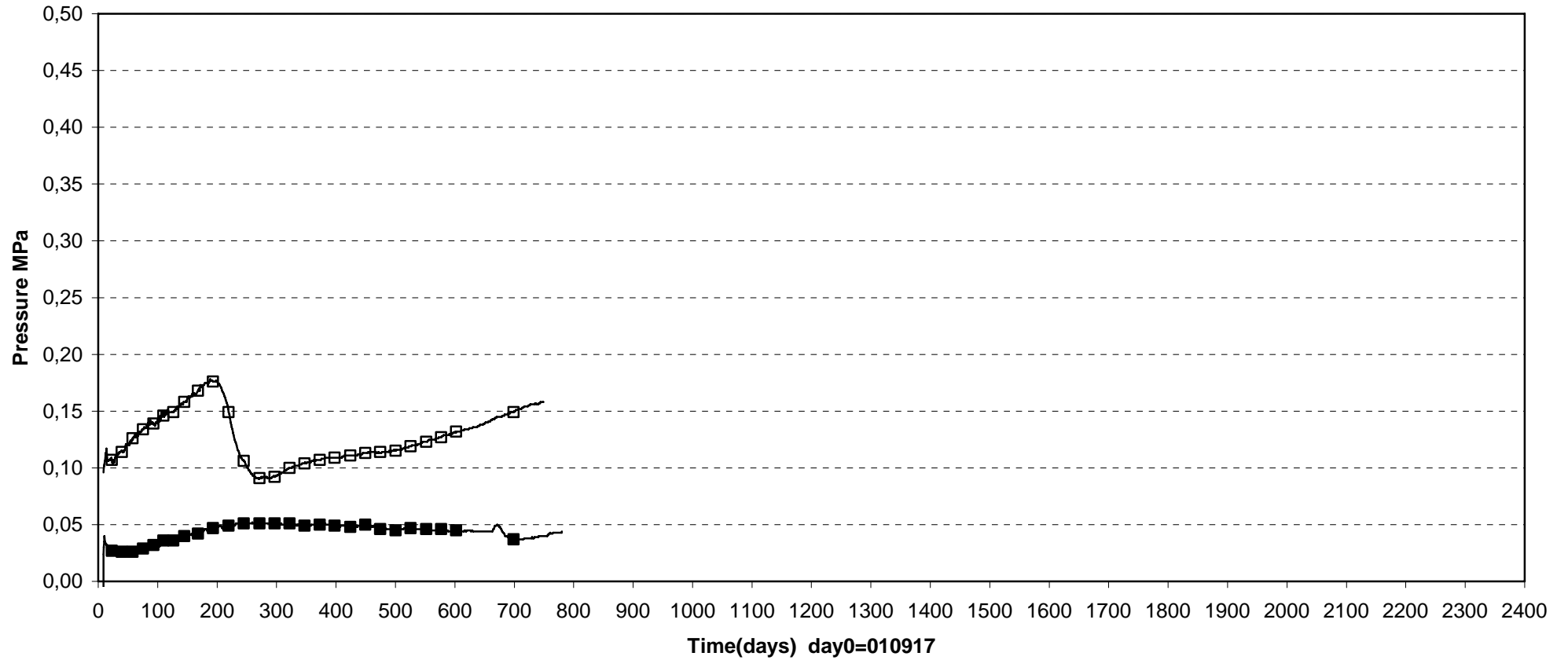

□ PBA10005(E1\0\ -3.1\3587) ■ PBA10006(E1\ -2.3\0.1\3587)

Prototype\Backfill \ Inner part (010917-071201)  
Suction - Wescor

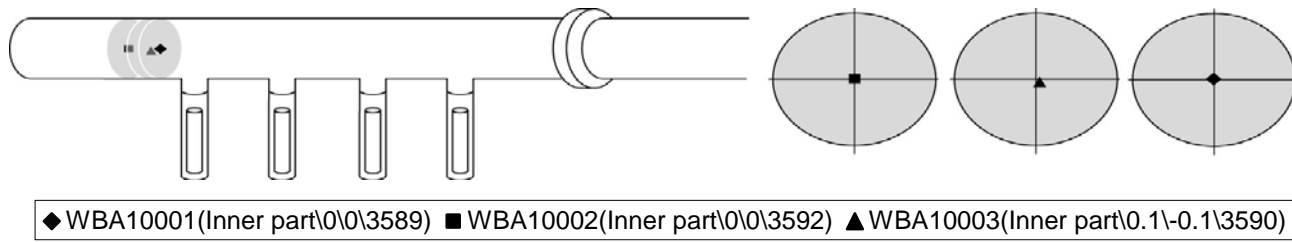
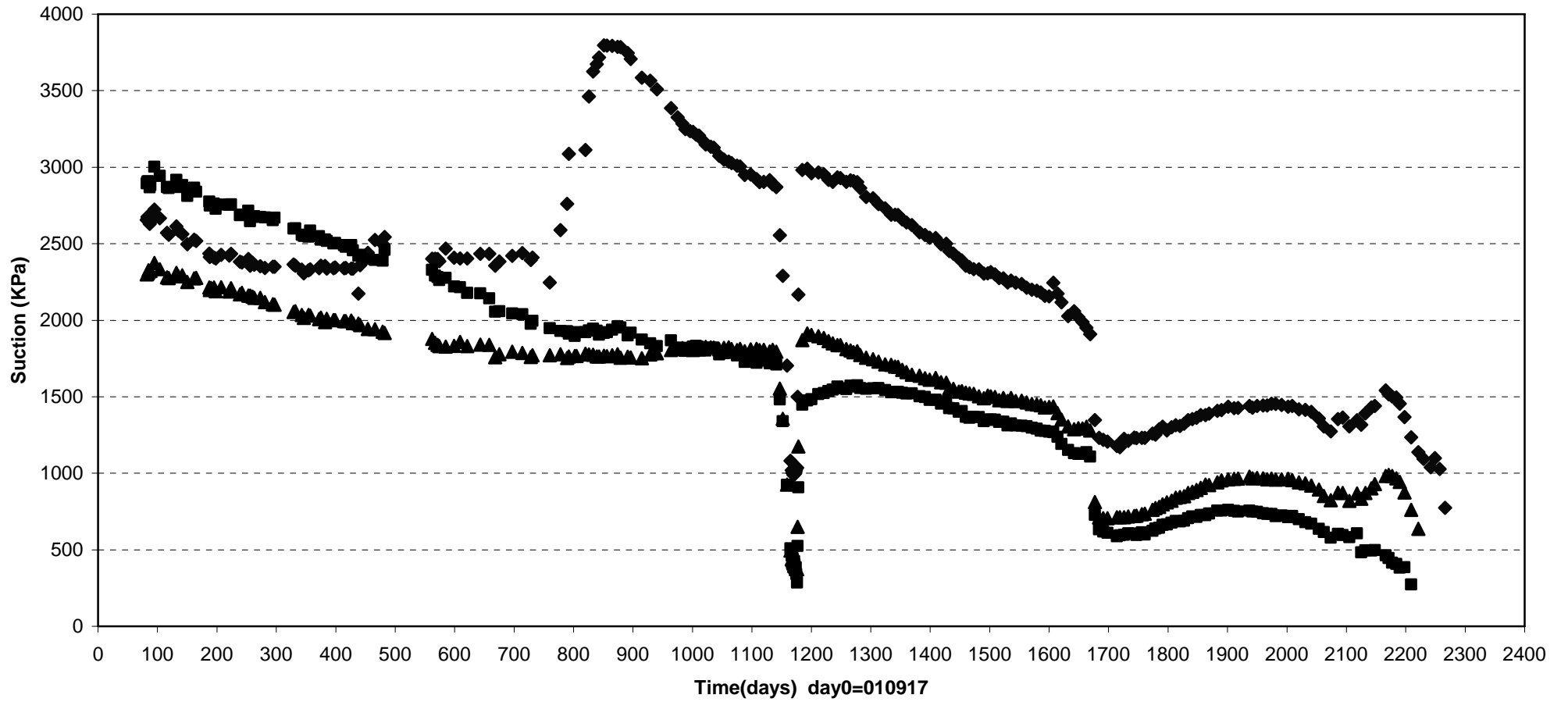

Prototype\Backfill\ Above dep.hole 1 (010917-071201)  
Suction - Wescor

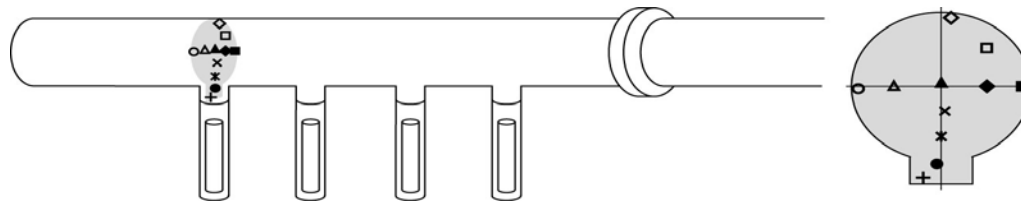
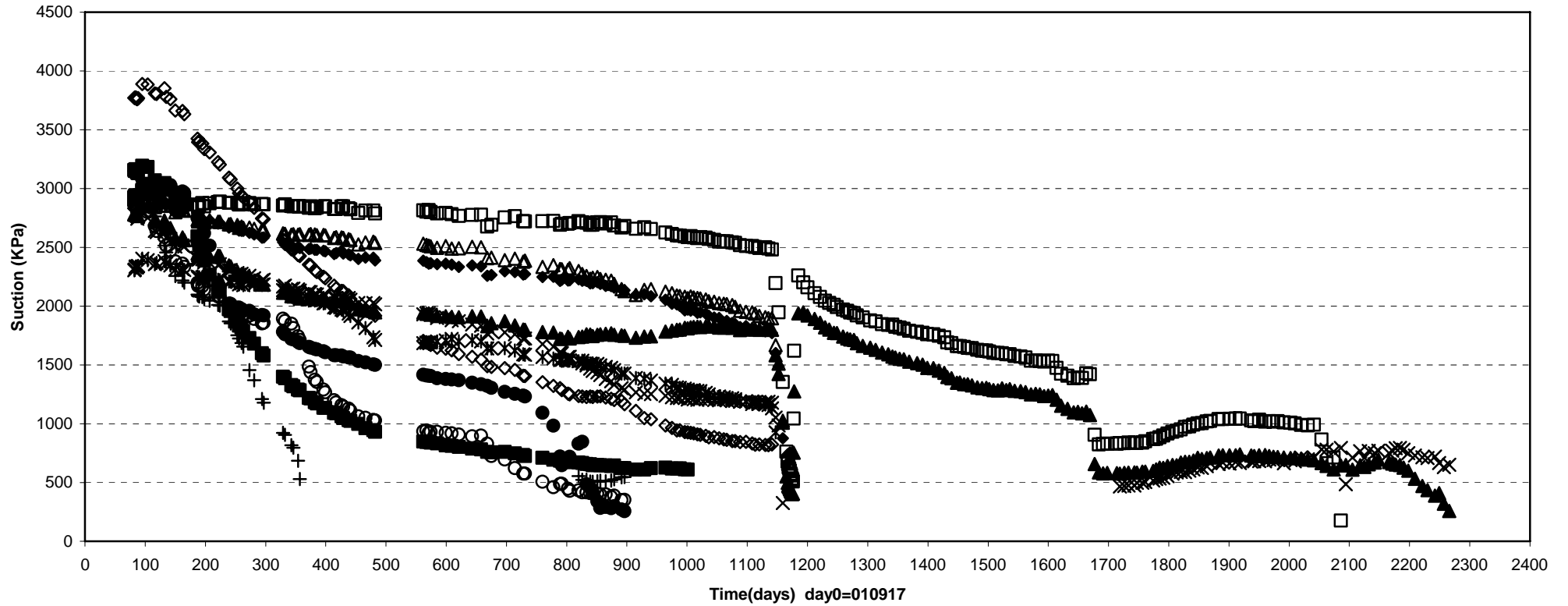

- |                              |                             |                              |                             |
|------------------------------|-----------------------------|------------------------------|-----------------------------|
| ◇ WBA10004(E1\0.25\2.3\3587) | □ WBA10005(E1\0\1.25\3587)  | ▲ WBA10006(E1\0\0.1\3587)    | × WBA10007(E1\0.1\0.8\3587) |
| ✱ WBA10008(E1\0\1.7\3587)    | ● WBA10009(E1\0.1\2.6\3587) | + WBA10010(E1\0.5\3.13\3587) | ○ WBA10011(E1\2.3\0.1\3587) |
| △ WBA10012(E1\1.3\0\3587)    | ◆ WBA10013(E1\1.3\0\3587)   | ■ WBA10014(E1\2.3\0\3587)    |                             |

Prototype\Backfill \ Between dep.hole 1 and hole 2 (010917-071201)  
Suction - Wescor

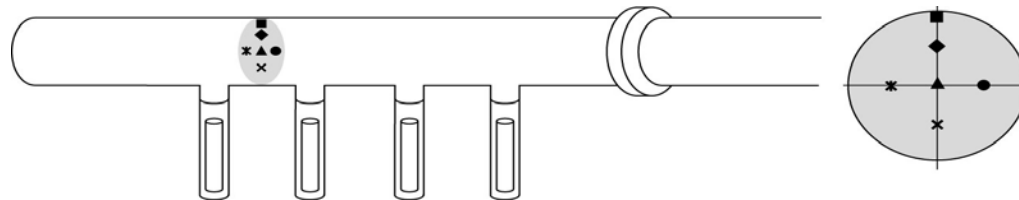
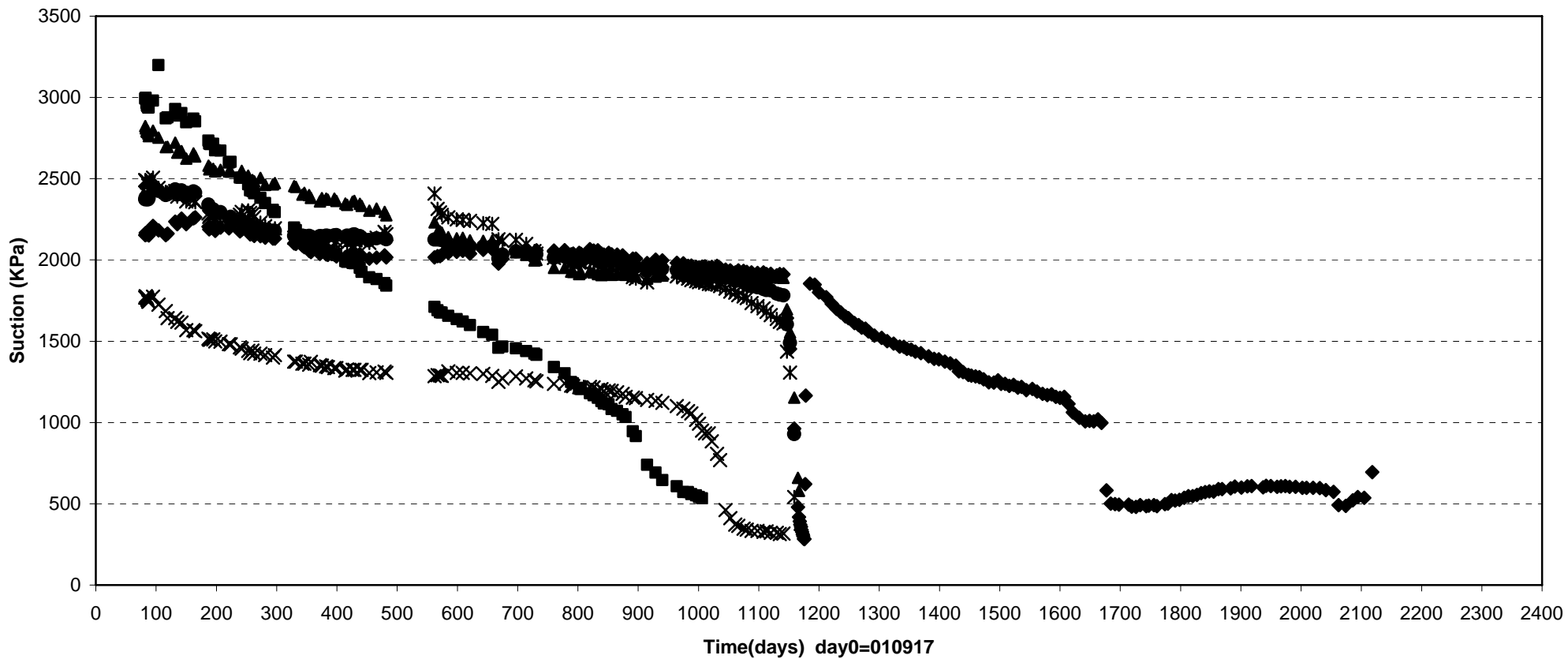

- ◆ WBA10015(F1-2\0\1.3\3584)    ■ WBA10016(F1-2\0\2.3\3584)    ▲ WBA10017(F1-2\0\0\3584)    × WBA10018(F1-2\0\1.3\3584)
- ✱ WBA10019(F1-2\1.3\0\3584)    ● WBA10020(F1-2\1.3\0\3584)

Prototype\Backfill \ Between dep.hole 2 and hole 3 (010917-071201)  
Suction - Wescor

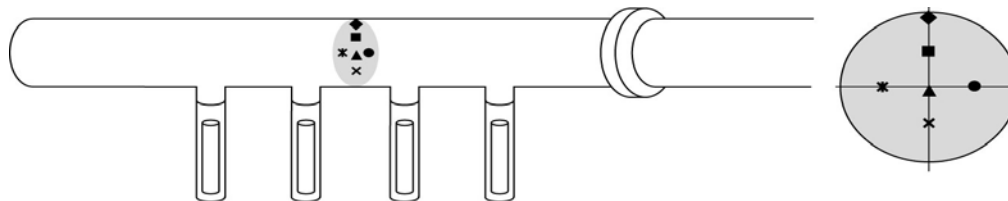
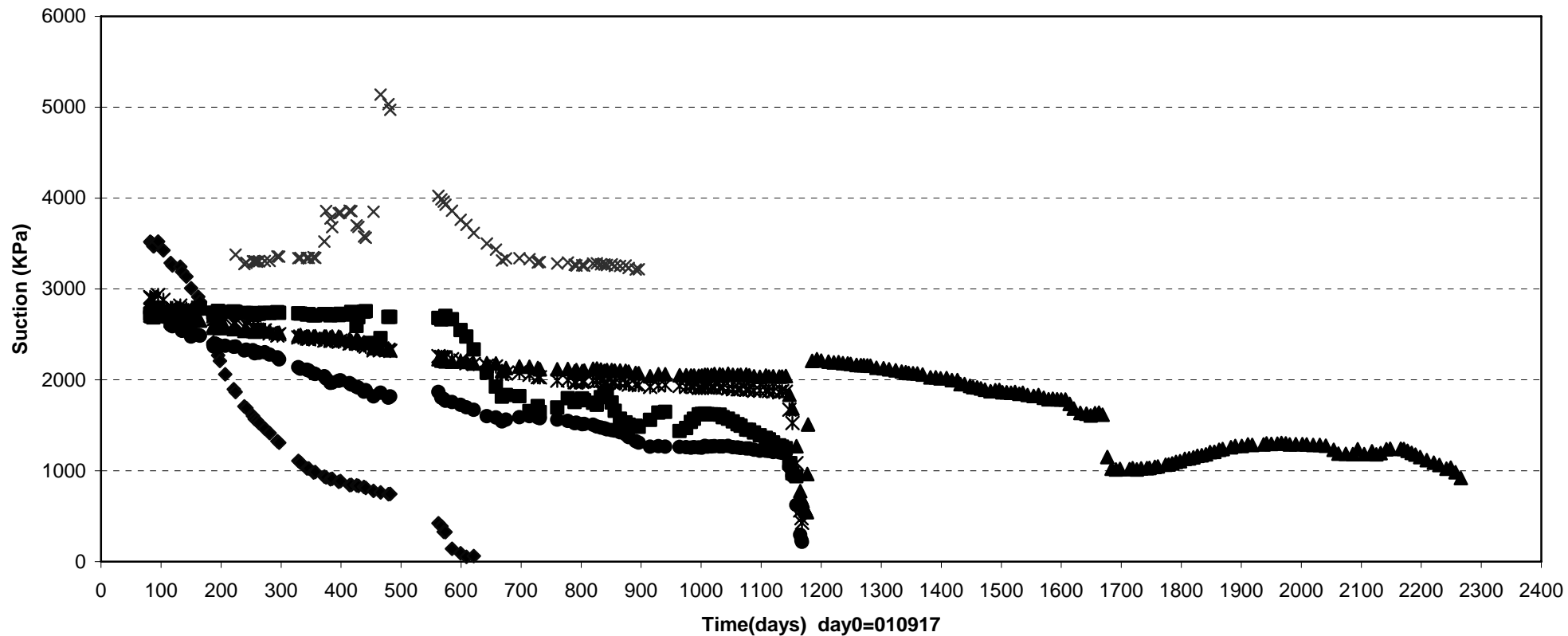

- ◆ WBA10021(F2-3\0\2.3\3578)    ■ WBA10022(F2-3\0\1.2\3578)    ▲ WBA10023(F2-3\0\0.2\3578)    ✖ WBA10025(F2-3\1.3\0\3578)
- WBA10026(F2-3\1.3\0\3578)    × WBA10024(F2-3\0\1.2\3578)



Prototype\Backfill\ Above dep.hole 3 (010917-071201)  
Suction - Wescor

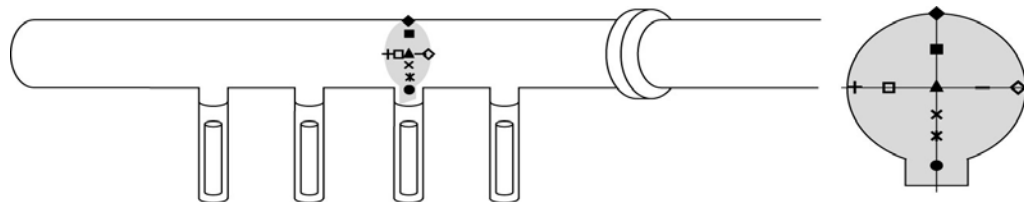
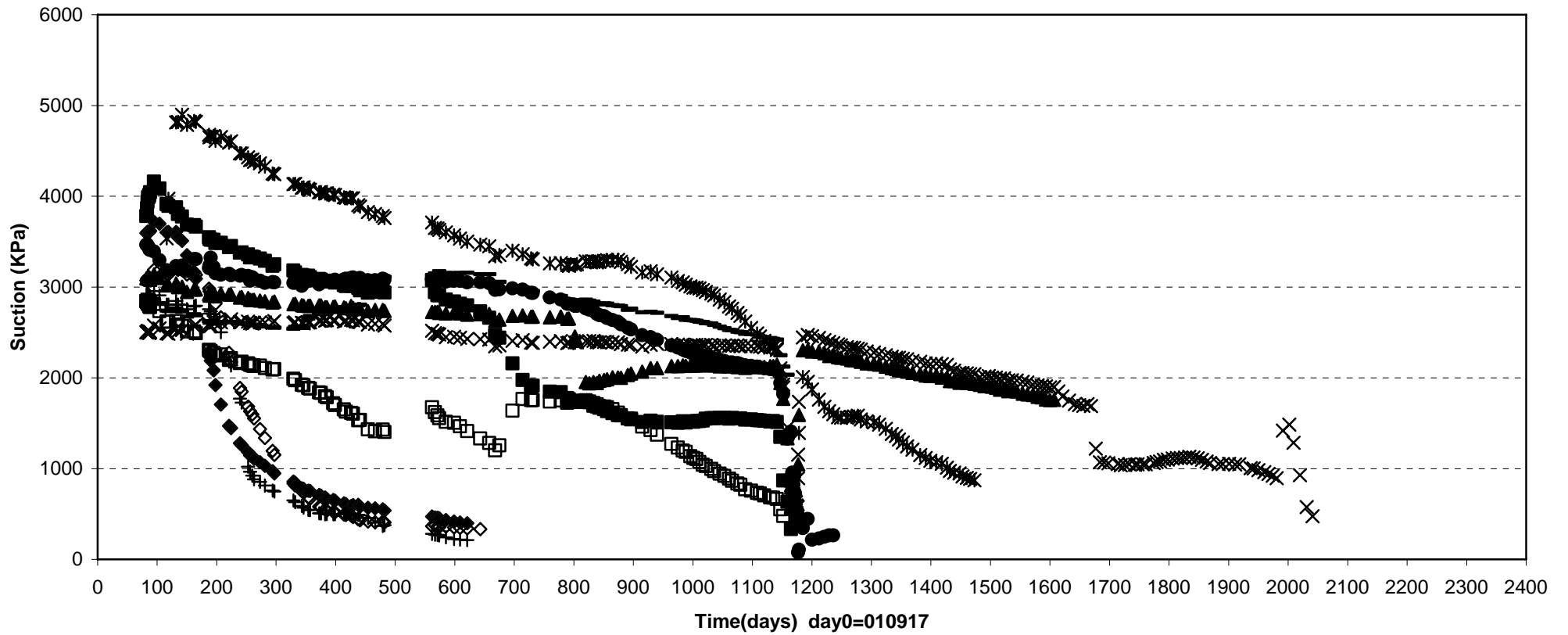

- |                               |                             |                             |                             |                             |
|-------------------------------|-----------------------------|-----------------------------|-----------------------------|-----------------------------|
| ◆ WBA10027(E3\0\2.5\3574)     | ■ WBA10028(E3\0\1.3\3575)   | ▲ WBA10029(E3\0\0\3575)     | × WBA10030(E3\0\0-0.9\3575) | ✱ WBA10031(E3\0\0-1.6\3575) |
| ● WBA10032(E3\0-0.3\2.6\3575) | + WBA10034(E3\0-2.3\0\3575) | □ WBA10035(E3\0-1.3\0\3575) | — WBA10036(E3\1.3\0\3575)   | ◇ WBA10037(E3\2.3\0\3575)   |

Prototype\Backfill \ Between dep.hole 3 and hole 4 (010917-071201)  
 Suction - Wescor

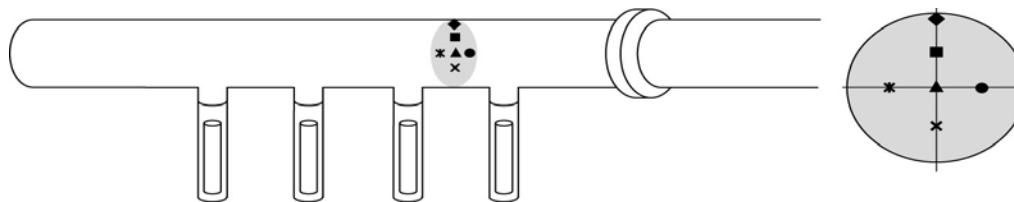
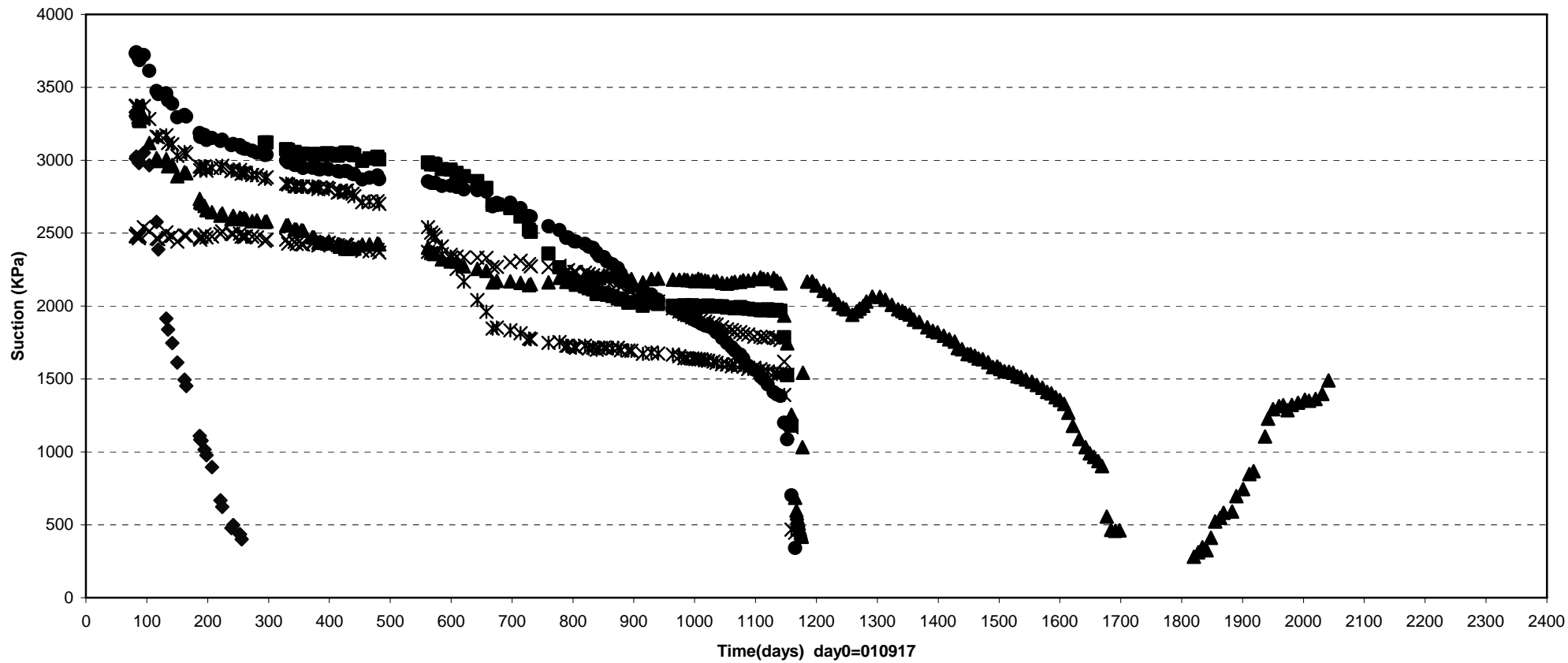

- |                              |                              |                            |                              |
|------------------------------|------------------------------|----------------------------|------------------------------|
| ◆ WBA10038(F3- 4\0\2.3\3572) | ■ WBA10039(F3- 4\0\1.2\3572) | ▲ WBA10040(F3- 4\0\0\3572) | × WBA10041(F3- 4\0\1.3\3572) |
| ✱ WBA10042(F3- 4\1.3\0\3572) | ● WBA10043(F3- 4\1.3\0\3572) |                            |                              |

Prototype\Backfill \ In front of plug (010917-071201)  
 Suction - Wescor

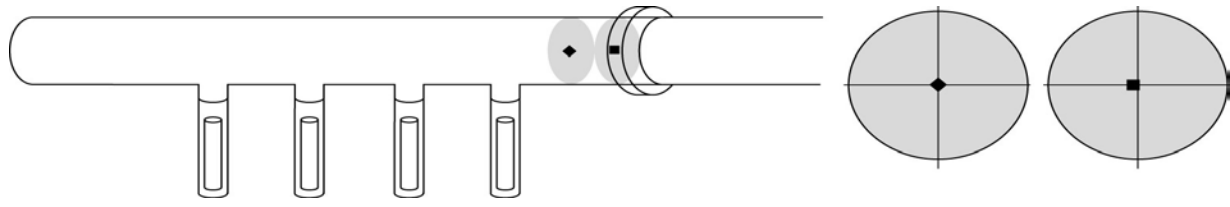
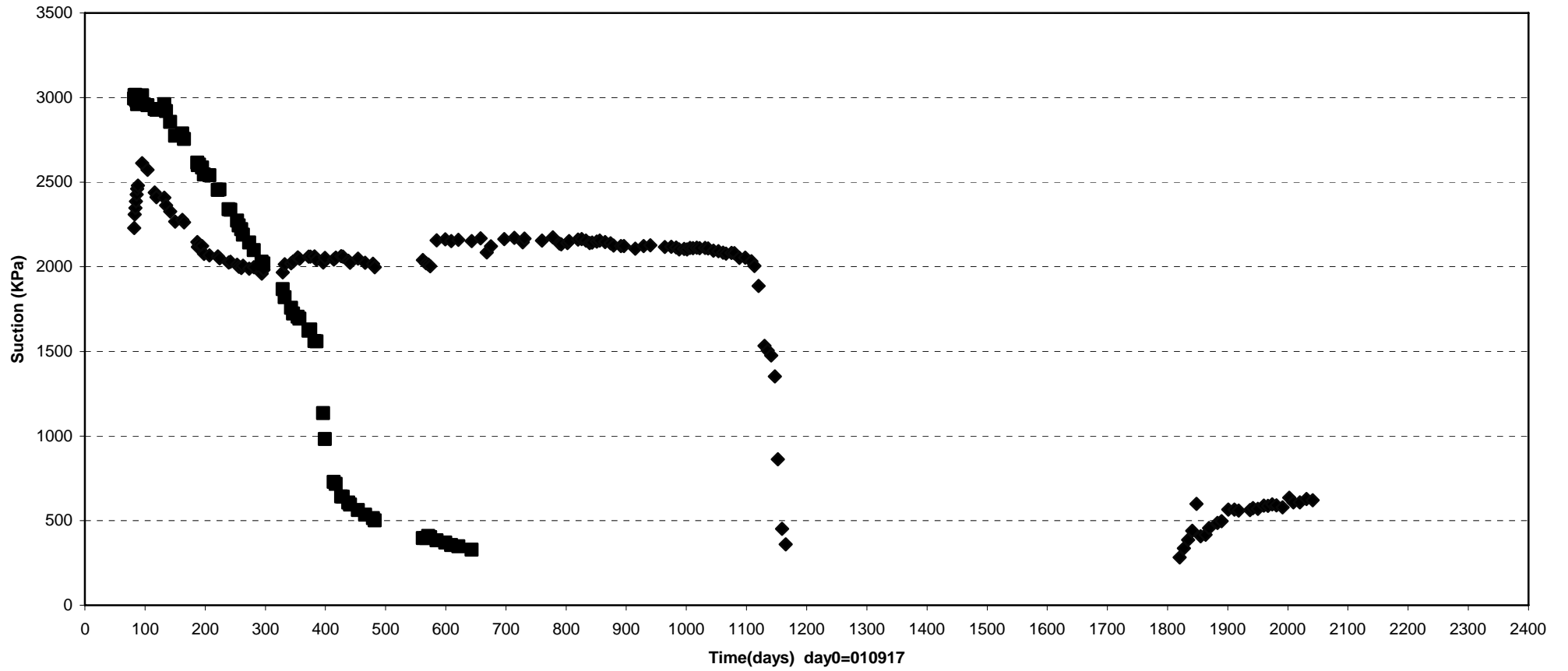

◆ WBA10044(In front of plug\0\0\3565) ■ WBA10045(In front of plug\0.1\0\3562)

Prototype\Backfill\Section 1 (010917-071201)  
Pore pressure - Geokon

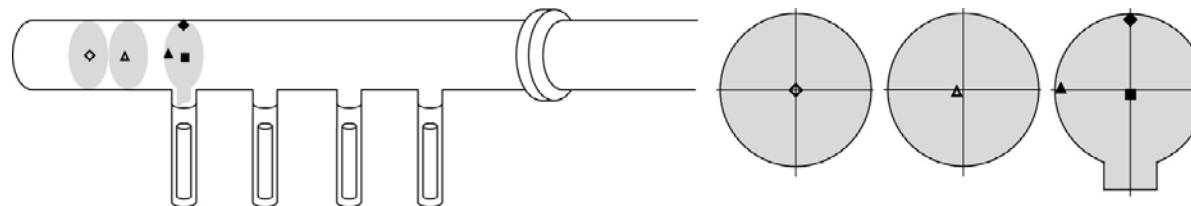
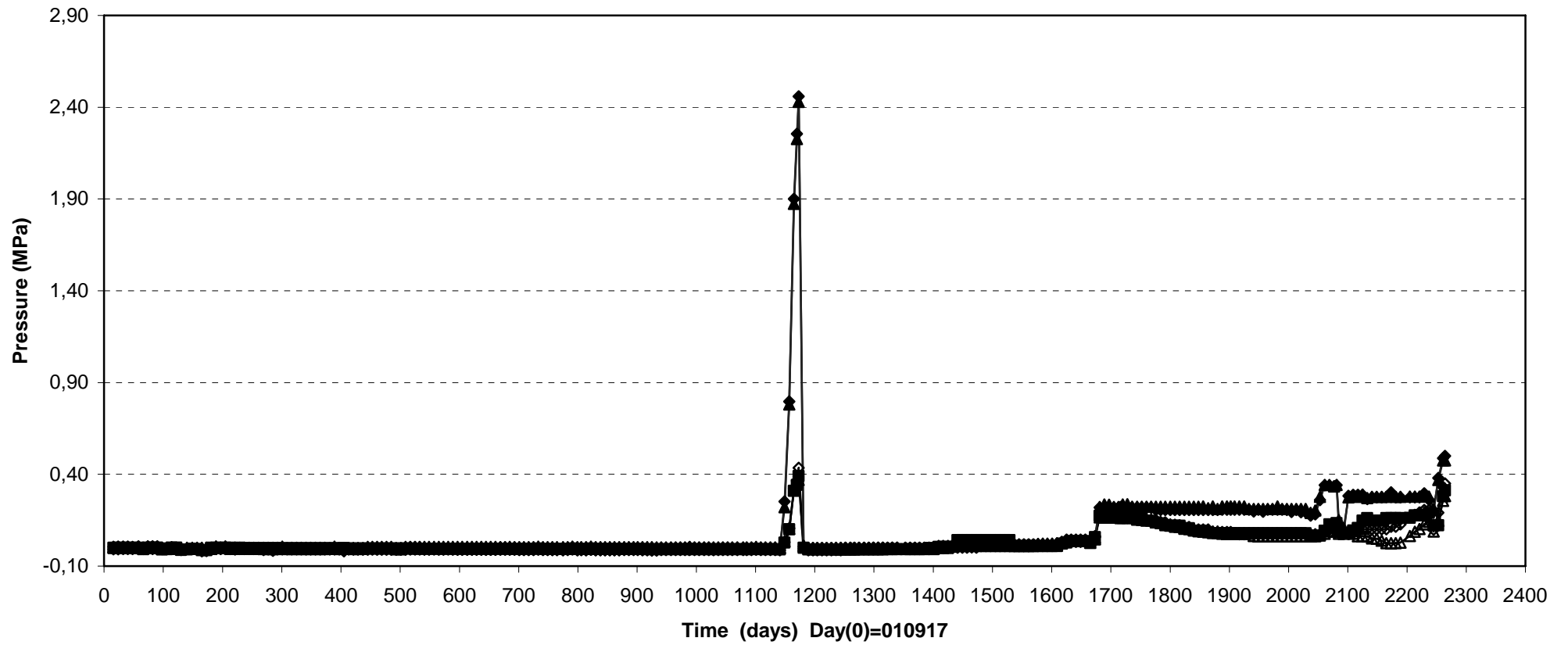

- |                                    |  |                            |
|------------------------------------|--|----------------------------|
| —◇— UBA10002 (Inner part\0\0\3592) | —▲— UBA10003 (Inner part\0.2\0.1\3590) | —■— UBA10004 (E1\0\0\3587) |
| —▲— UBA10008 (E1\2.3\0\3587)       | —◆— UBA10009 (E1\0\2.3\3587)           |                            |

Prototype\Backfill \ Section 1 (010917-071201)  
 Pore pressure - Geokon

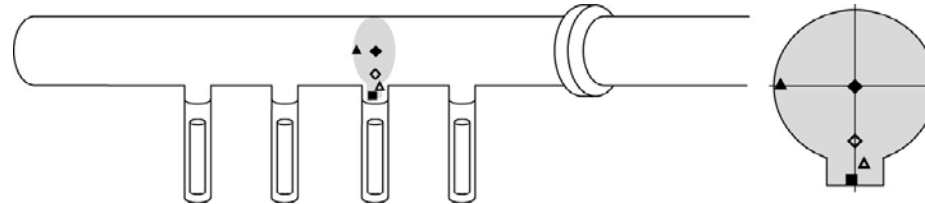
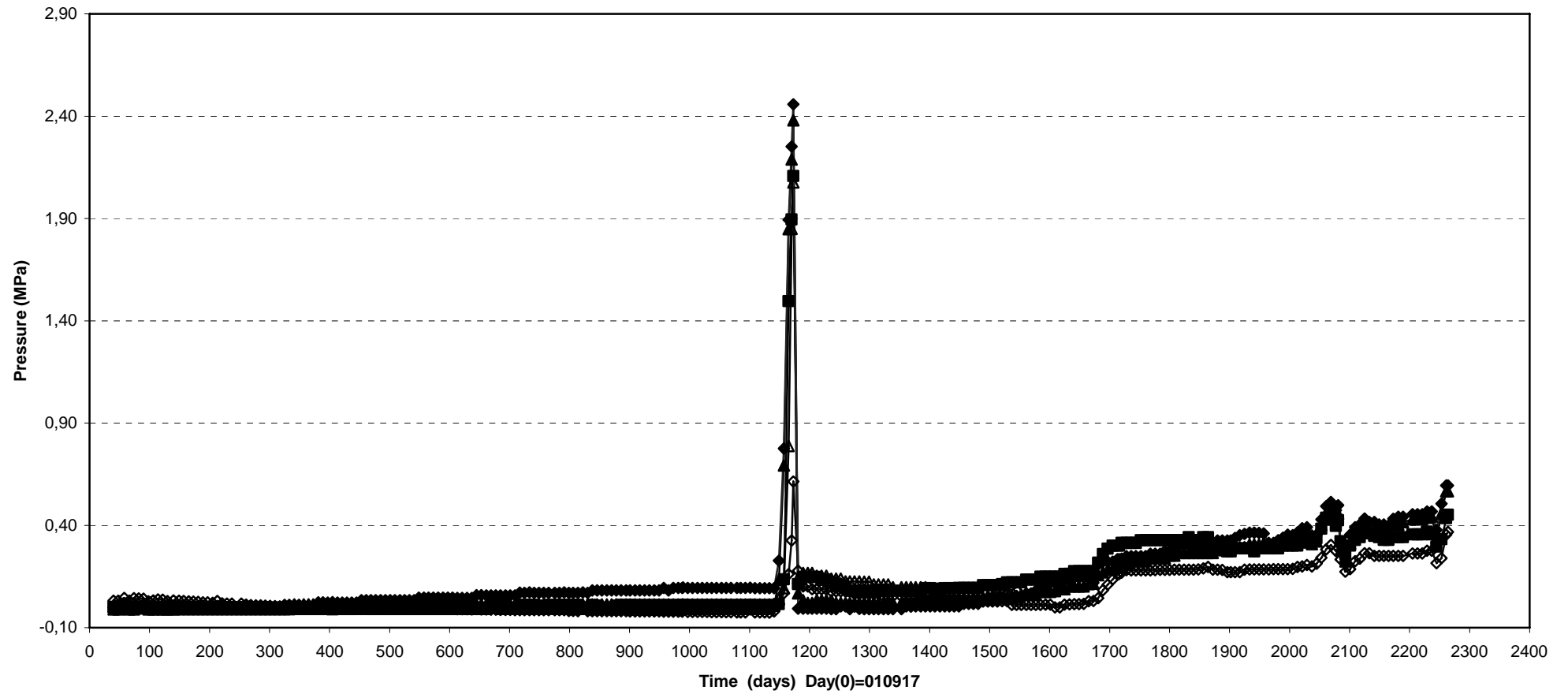

—◇— UBA10015(E3\0\ -1.82\3575) —△— UBA10016(E3\0.25\ -2.6\3575) —■— UBA10017(E3\ -0.1\ -3.1\3575) —▲— UBA10018(E3\ -2.3\0\3575) —◆— UBA10019(E3\0\0\3574)

Prototype\Backfill\ Section 1 (010917-071201)  
Pore pressure - Kulite

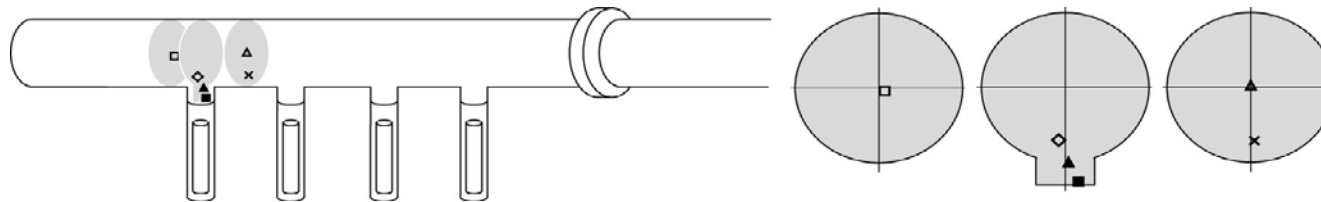
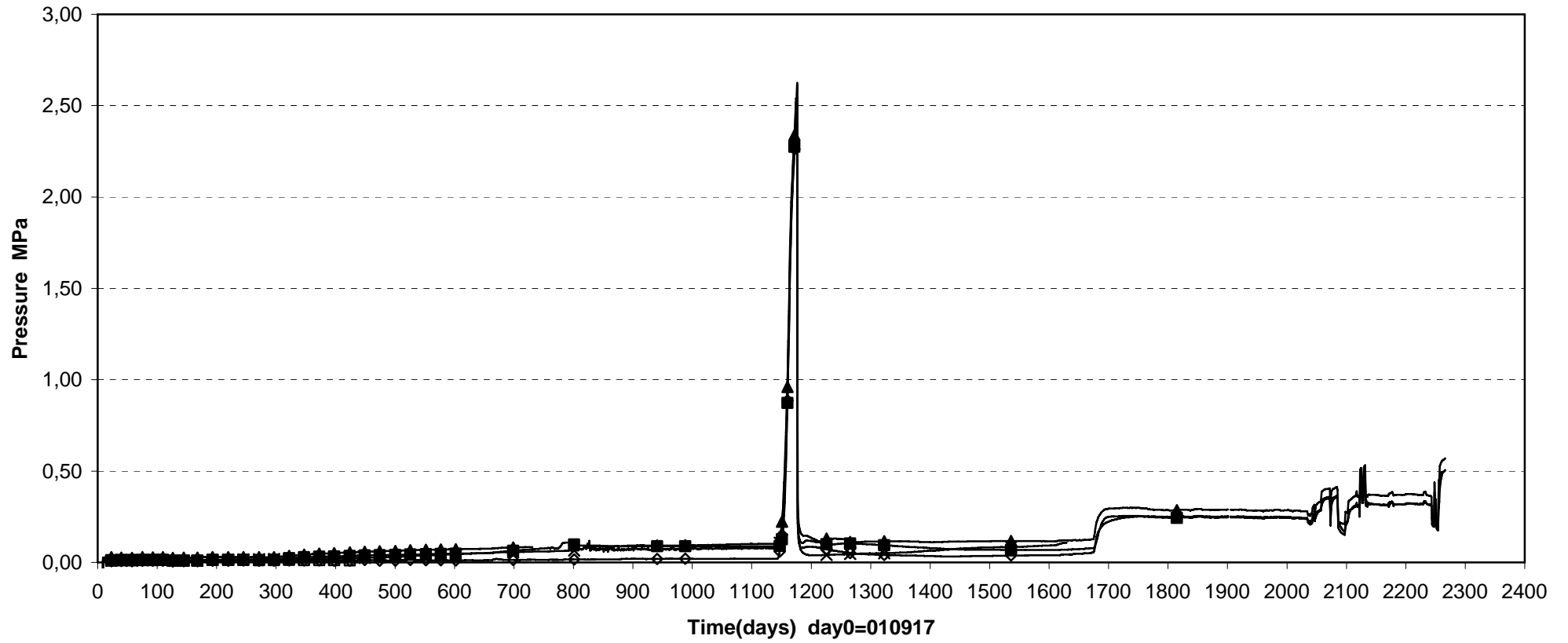

|                                     |                             |                               |
|-------------------------------------|-----------------------------|-------------------------------|
| □ UBA10001(Inner part\0.2\0.1\3589) | ◇ UBA10005(E1\0.2\1.8\3587) | ▲ UBA10006(E1\0.1\2.6\3587)   |
| ■ UBA10007(E1\0.4\3.2\3587)         | △ UBA10010(F1-2\0\0\3584)   | × UBA10011(F1-2\0.1\1.2\3584) |

Prototype\Backfill \Section 1 (041015-071201)  
Pore pressure - Kulite

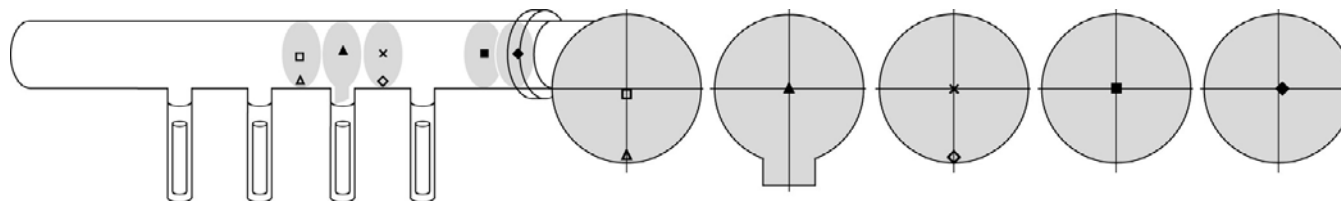
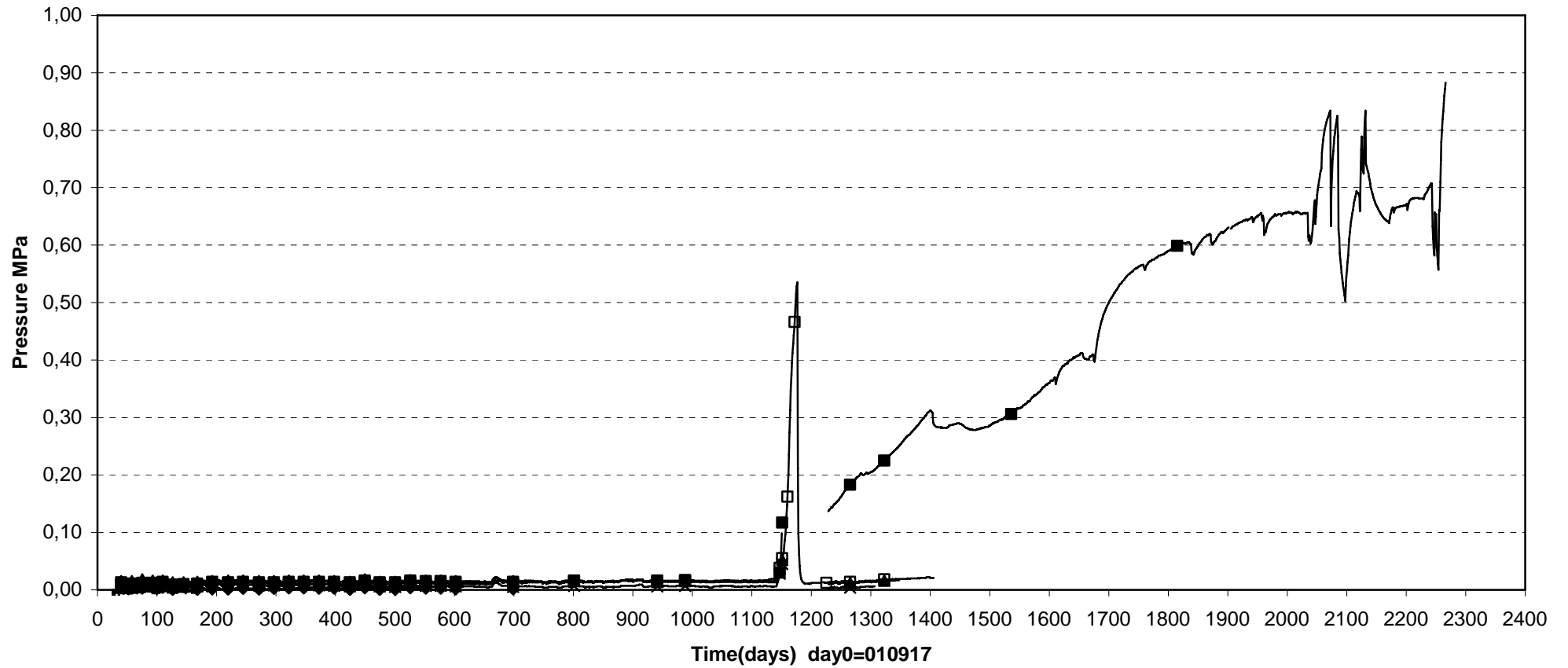

- |                               |                                       |   |                           |
|-------------------------------|---------------------------------------|---|---------------------------|
| □ UBA10012(F2-3\0\0.2\3578)   | △ UBA10013(F2-3\0\0.2.3\3578)         | ▲ UBA10014(E3\0\0\3575)                 | × UBA10020(F3-4\0\0\3572) |
| ◇ UBA10021(F3-4\0\0.2.3\3572) | ■ UBA10022(In front of plug\0\0\3565) | ◆ UBA10023(In front of plug\0.1\0\3561) |                           |

Prototype\ Backfill \ Above dep.hole1 (010917-071201)  
 Temperature - Pentronic

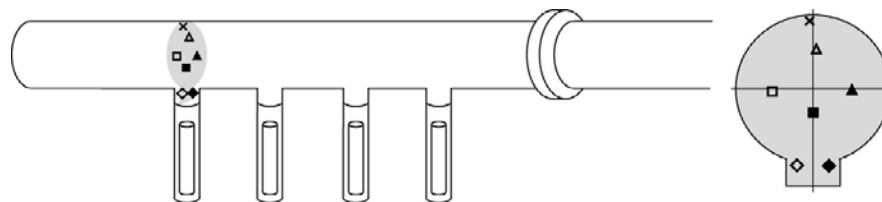
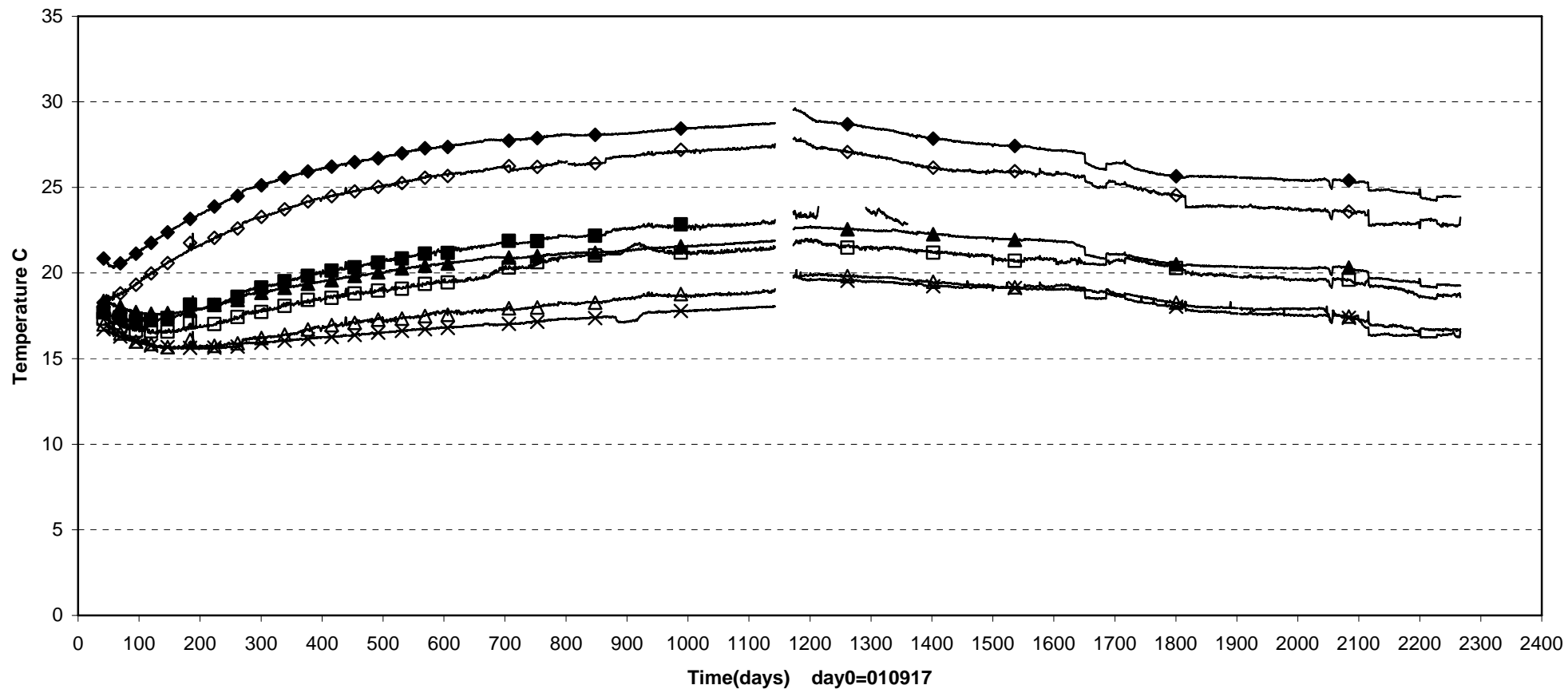

- |                              |                             |                              |                             |
|------------------------------|-----------------------------|------------------------------|-----------------------------|
| □ TBA10001(E1\1.25\0.1\3587) | △ TBA10002(E1\0.1\1.3\3587) | ■ TBA10003(E1\0\0.8\3587)    | ◇ TBA10004(E1\0.5\2.6\3587) |
| ◆ TBA10005(E1\0.5\2.6\3587)  | × TBA10006(E1\0.1\2.3\3587) | ▲ TBA10007(E1\1.25\0.1\3587) |                             |



Prototype\ Backfill \ Between dep.hole 1-2 (010917-071201)  
 Temperature - Pentronic

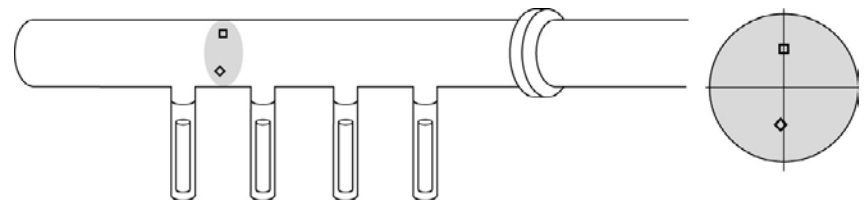
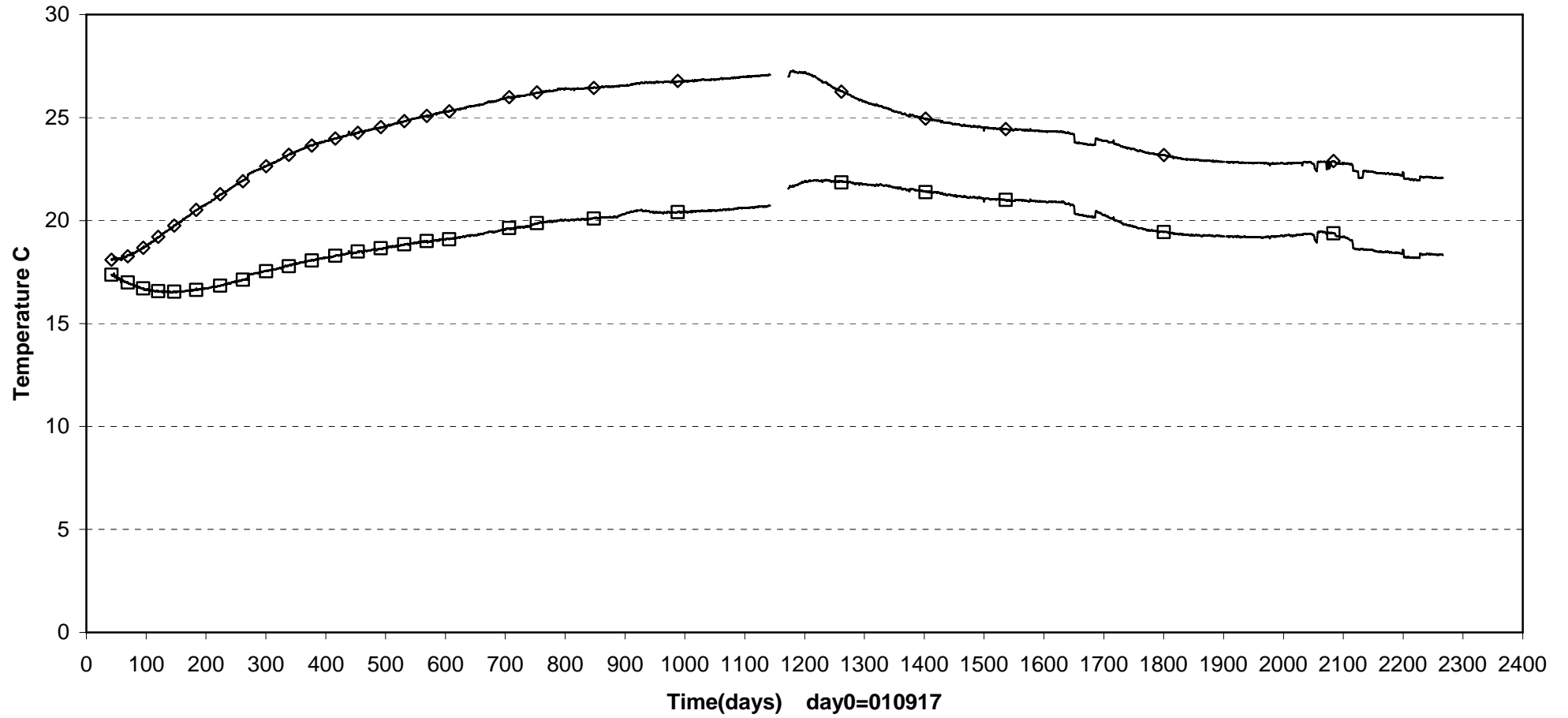

□ TBA10008(F1-2\0\1.25\3584) ◇ TBA10009(F1-2\0-0.1\1.3\3584)

Prototype\ Backfill \ Between dep.hole 2-3 (010917-071201)  
 Temperature -Pentronic

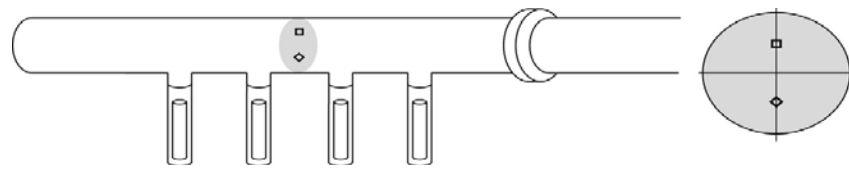
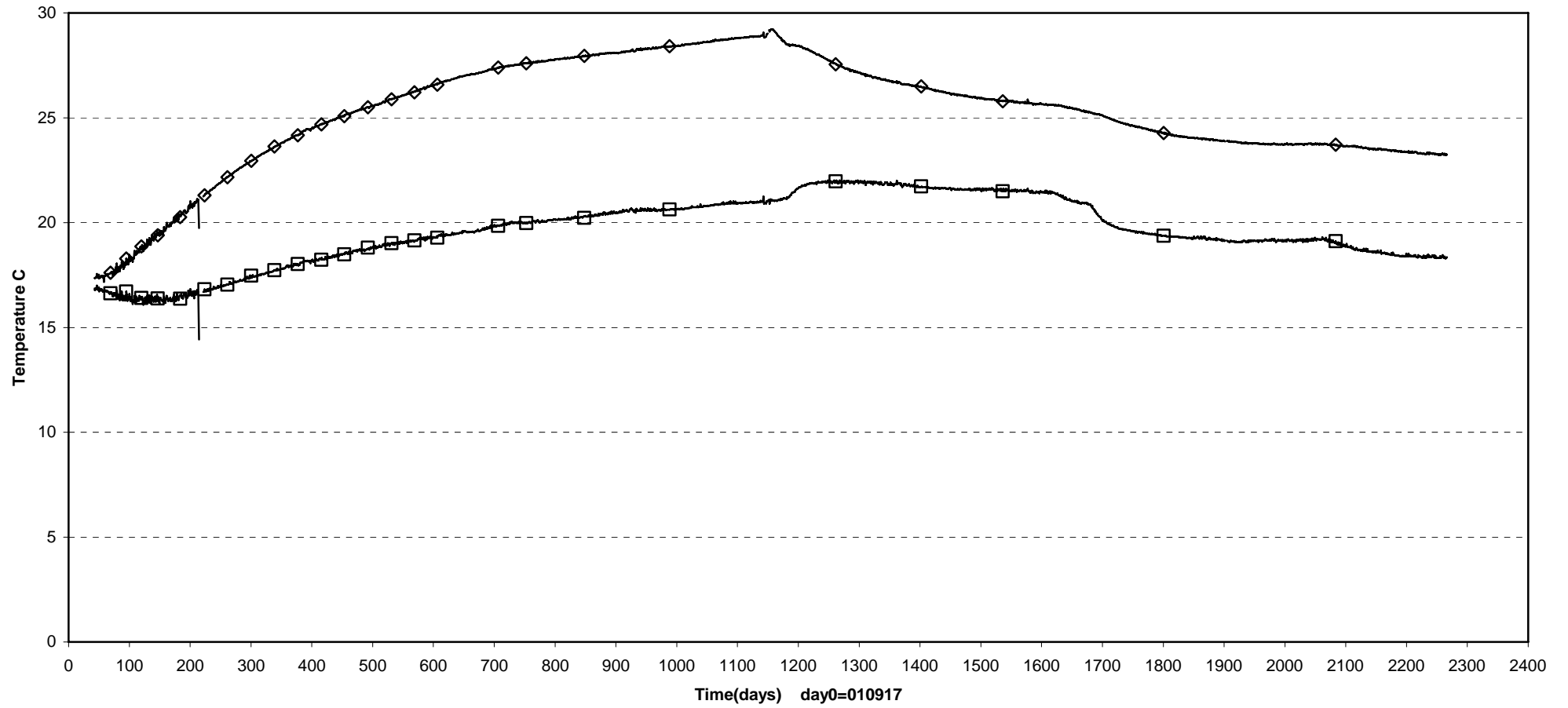

□ TBA10010(F2-3\0\1.15\3578) ◇ TBA10011(F2-3\0\1.24\3578)

Prototype\ Backfill \ Above dep.hole3 (010917-071201)  
 Temperature - Pentronic

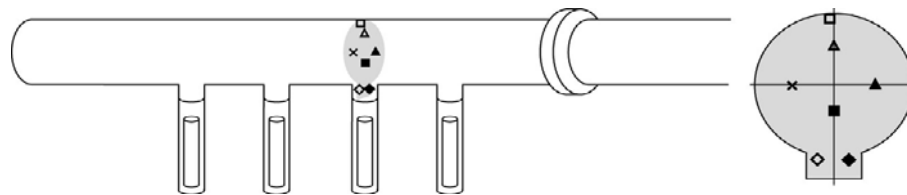
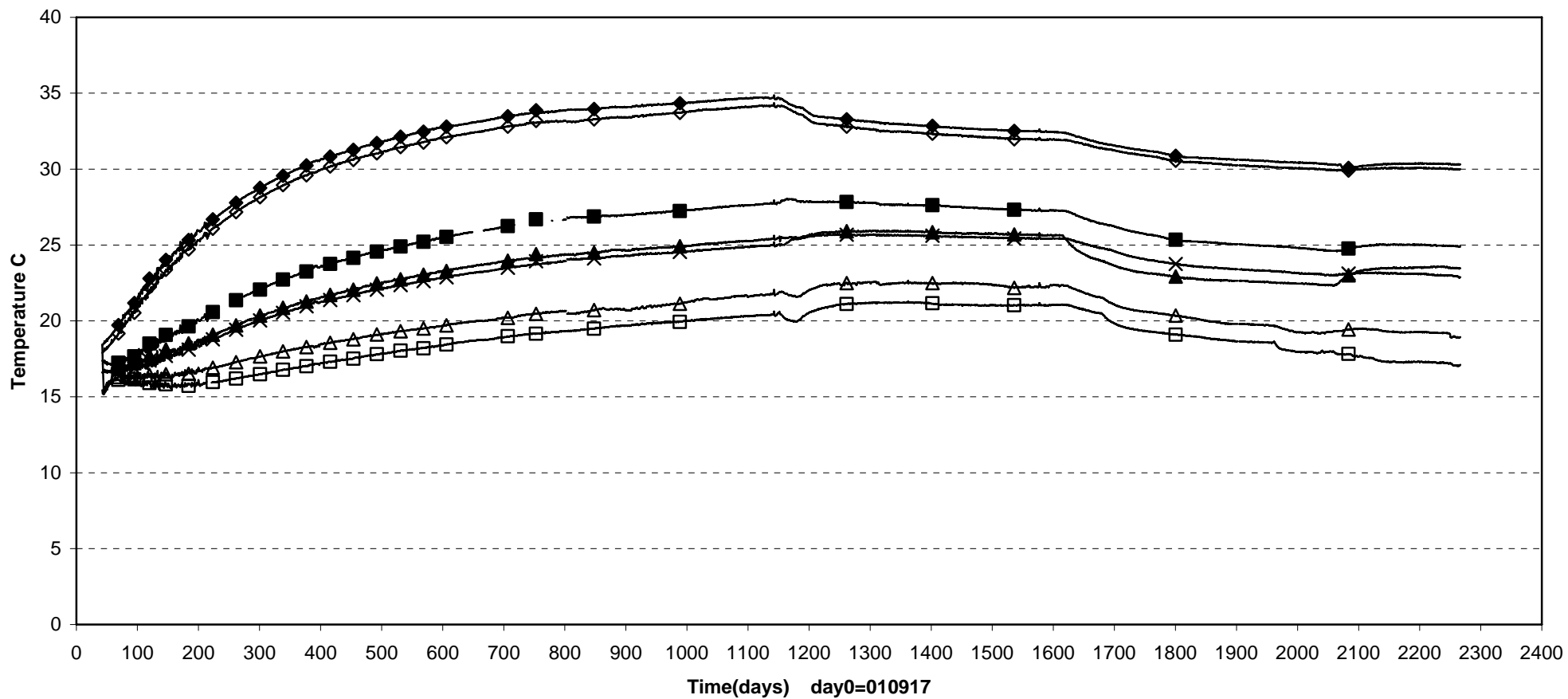

- |                               |                             |                             |                               |
|-------------------------------|-----------------------------|-----------------------------|-------------------------------|
| □ TBA10012(E3\0-0.1\2.3\3575) | △ TBA10013(E3\0\1.3\3575)   | ■ TBA10014(E3\0\0-0.9\3575) | ◇ TBA10015(E3\0-0.5\2.6\3575) |
| ◆ TBA10016(E3\0.5\2.6\3575)   | × TBA10017(E3\0-1.3\0\3575) | ▲ TBA10018(E3\1.3\0\3575)   |                               |

Prototype\ Backfill \ Between dep.hole 3-4 (010917-071201)  
 Temperature - Pentronic

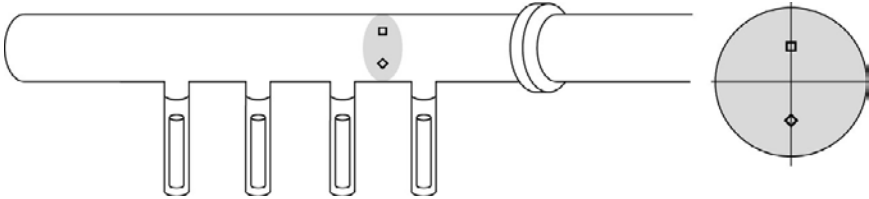
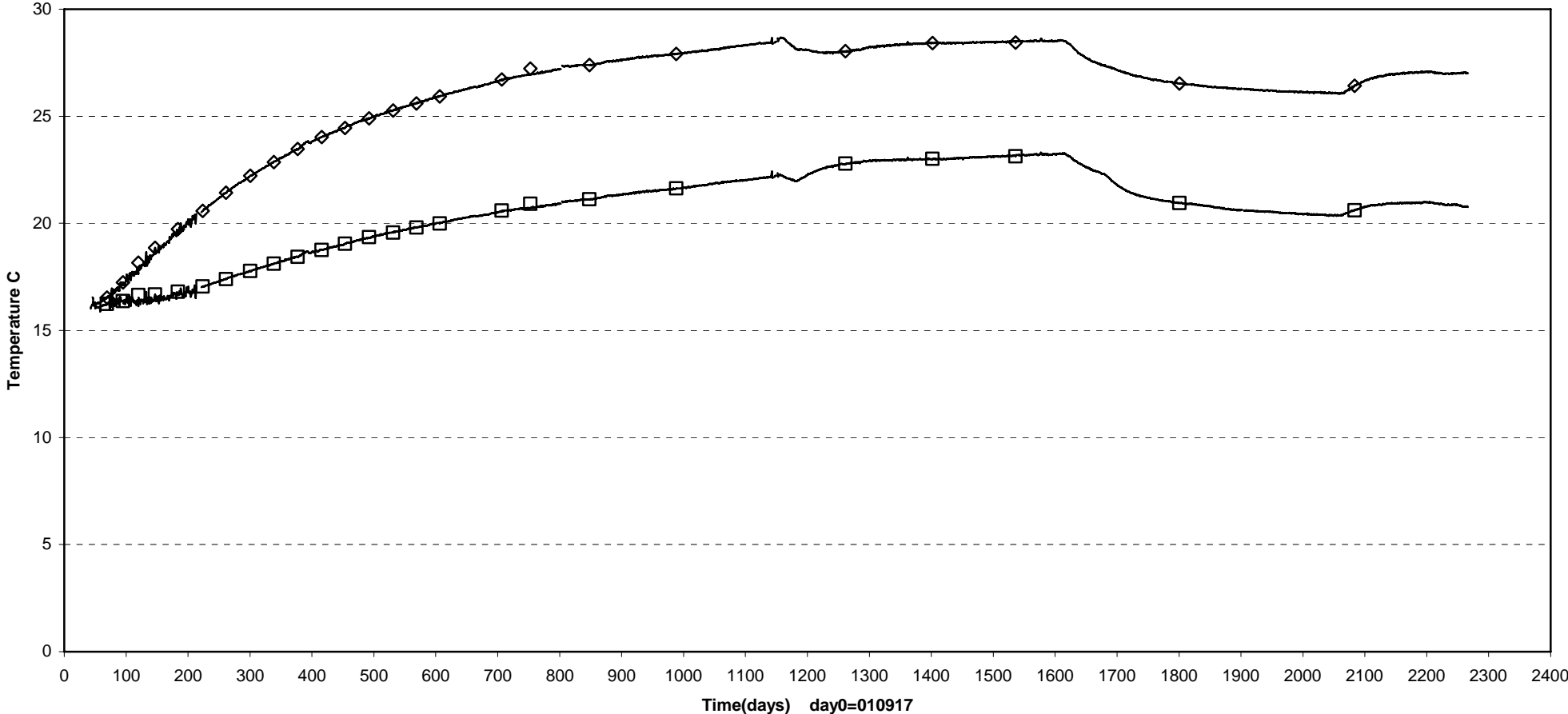

□ TBA10019(F3-4\0\1.2\3572) ◇ TBA10020(F3-4\0\1.3\3572)

## **Appendix 5**

**Dep. hole 5**



Prototype\Hole 5\Cyl.1 (030508-071201)  
Total pressure - Geokon

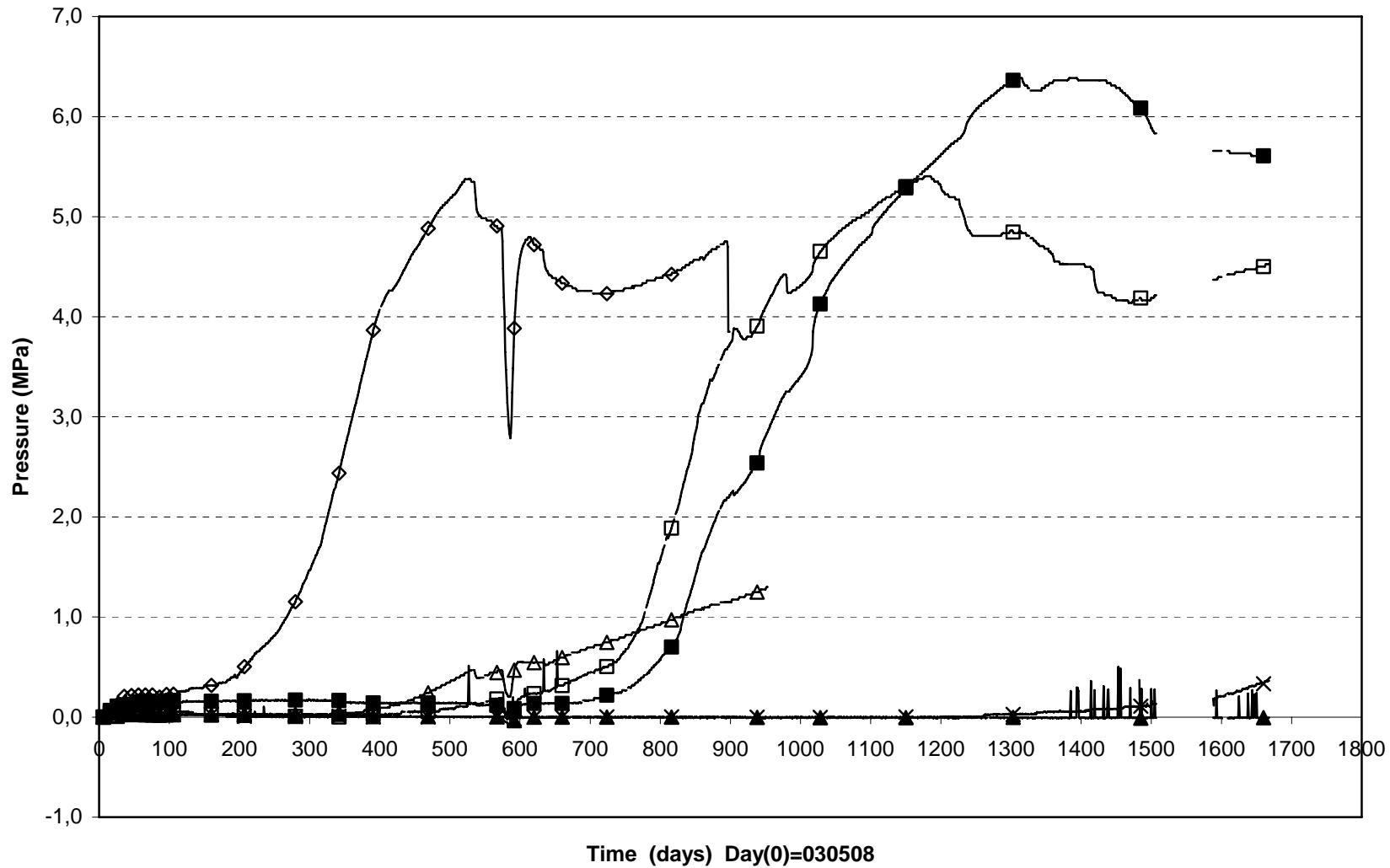

|                           |                           |                           |
|---------------------------|---------------------------|---------------------------|
| × PB501(0\0°\0)           | ▲ PB502(0.500\0°\0.100)   | ◇ PB506(0.500\95°\0.635)  |
| △ PB507(0.500\105°\0.735) | □ PB508(0.500\185°\0.635) | ■ PB509(0.500\195°\0.735) |

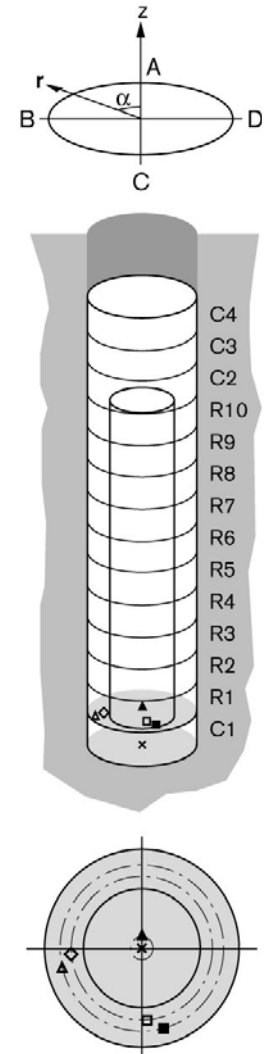

Prototype\Hole 5\Ring5 (030508-071201)  
 Total pressure - Geokon

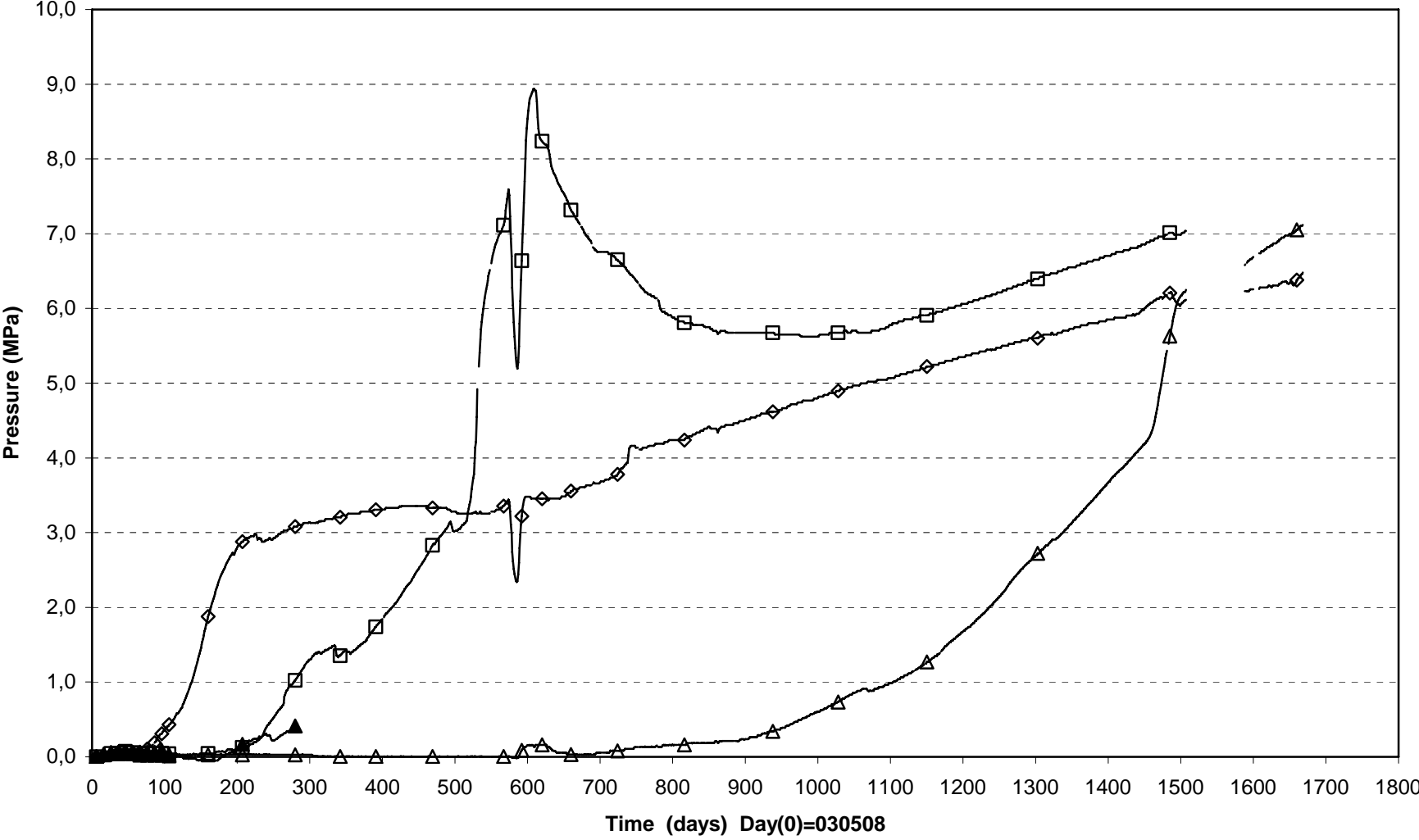

|                          |                           |
|--------------------------|---------------------------|
| □ PB511(3.036\5°\0.685)  | ▲ PB513(3.036\95°\0.635)  |
| ◇ PB514(3.036\95°\0.785) | △ PB515(3.036\185°\0.635) |

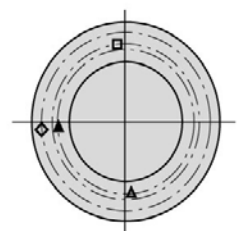
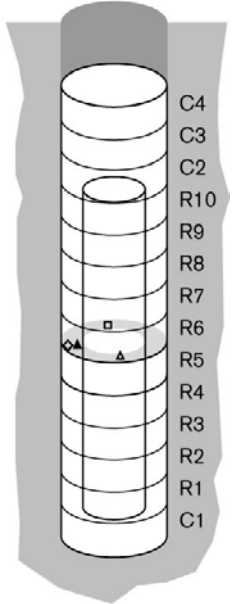
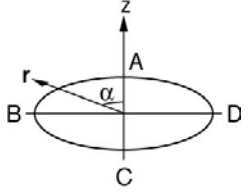



Prototype\Hole 5\Ring10 (030508-071201)  
Total pressure - Geokon

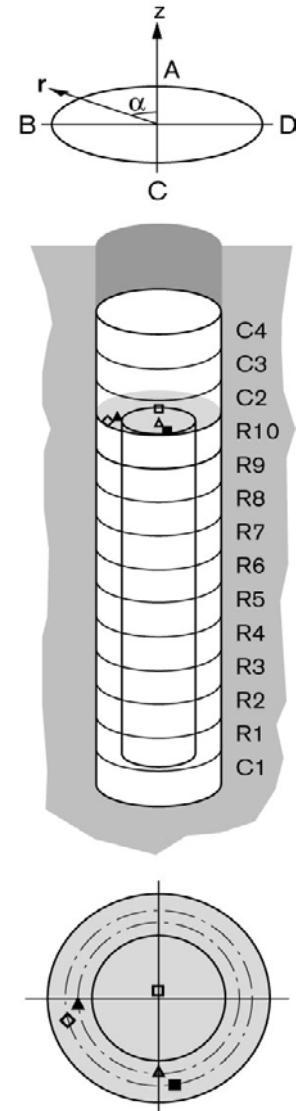
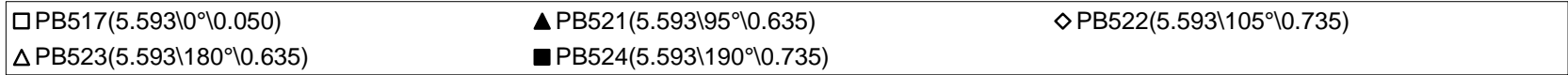
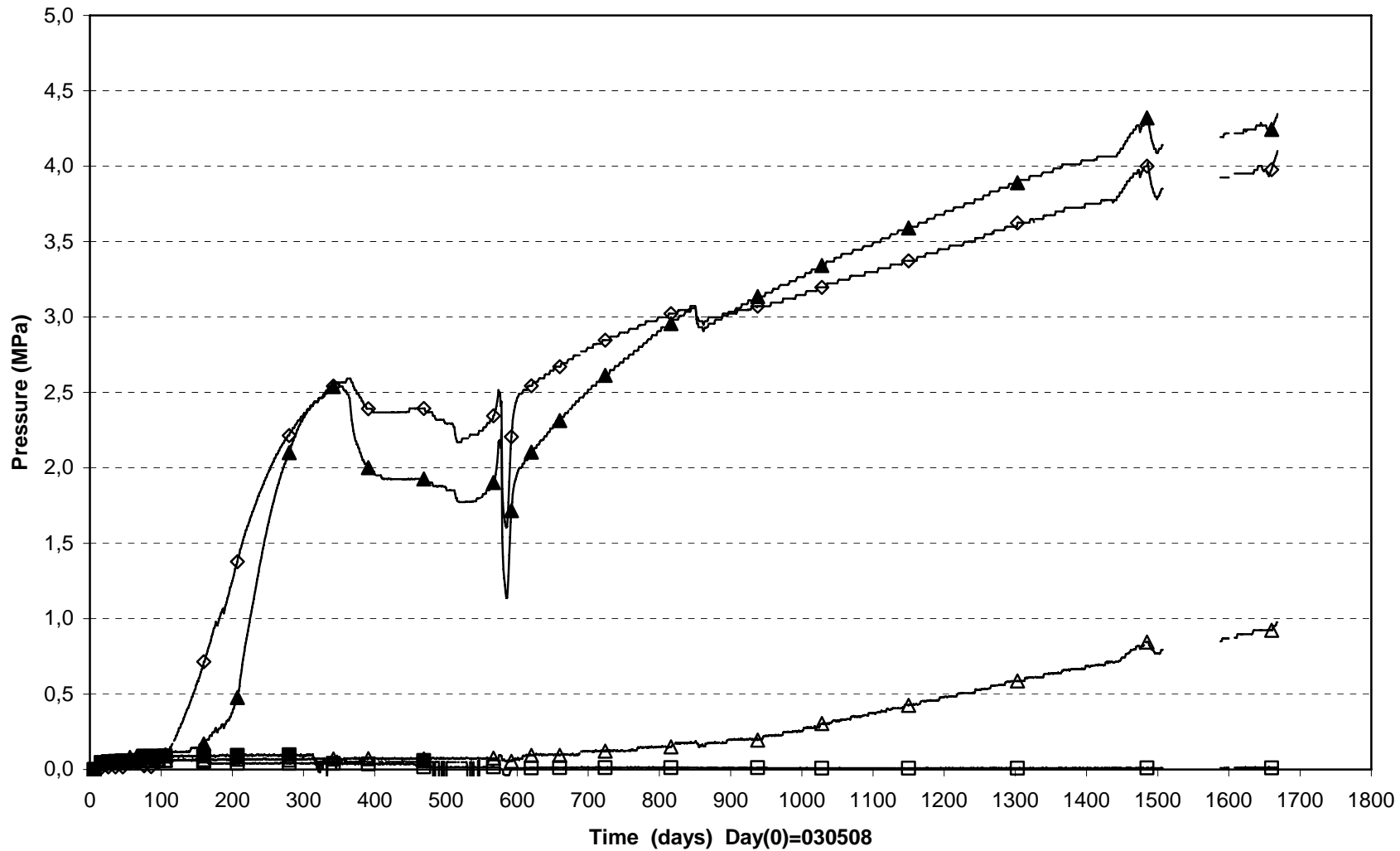

Prototype\Hole 5\Cyl.3 and Cyl.4 (030508-071201)  
 Total pressure - Geokon

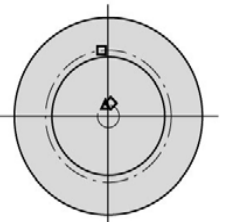
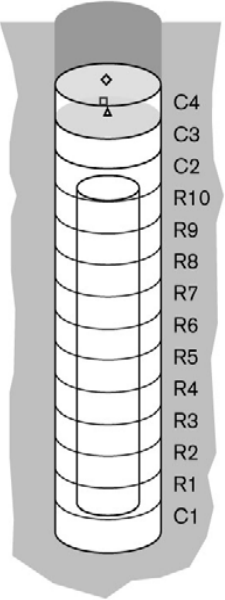
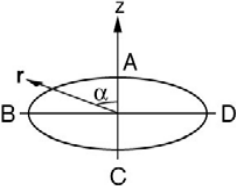
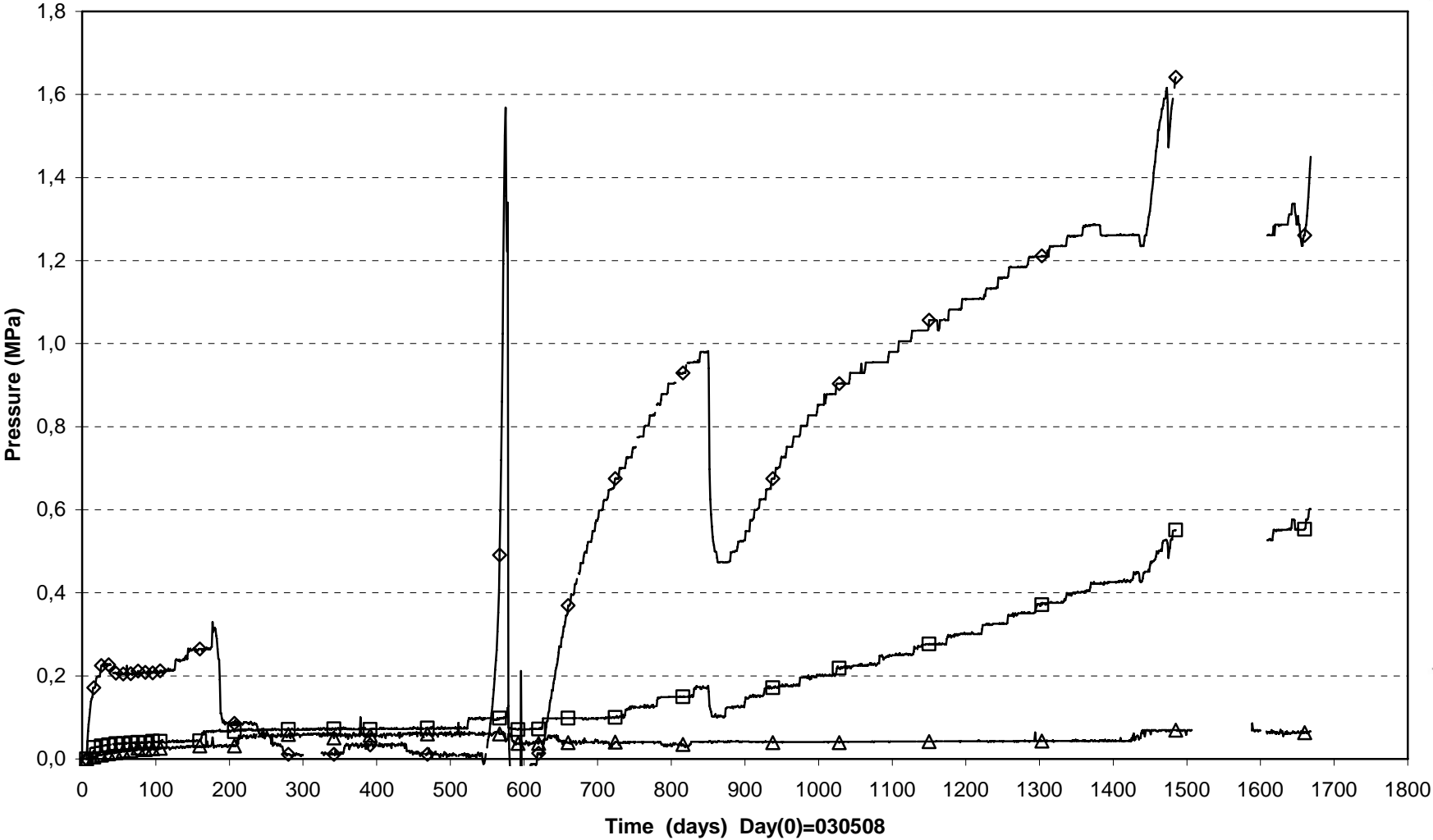

△ PB525(6.603\0°\0.100)
□ PB526(6.603\5°\0.585)
◇ PB527(7.110\0°\0.100)

Prototype\ Hole 5 (030508-071201)  
 Total pressure - Kulite

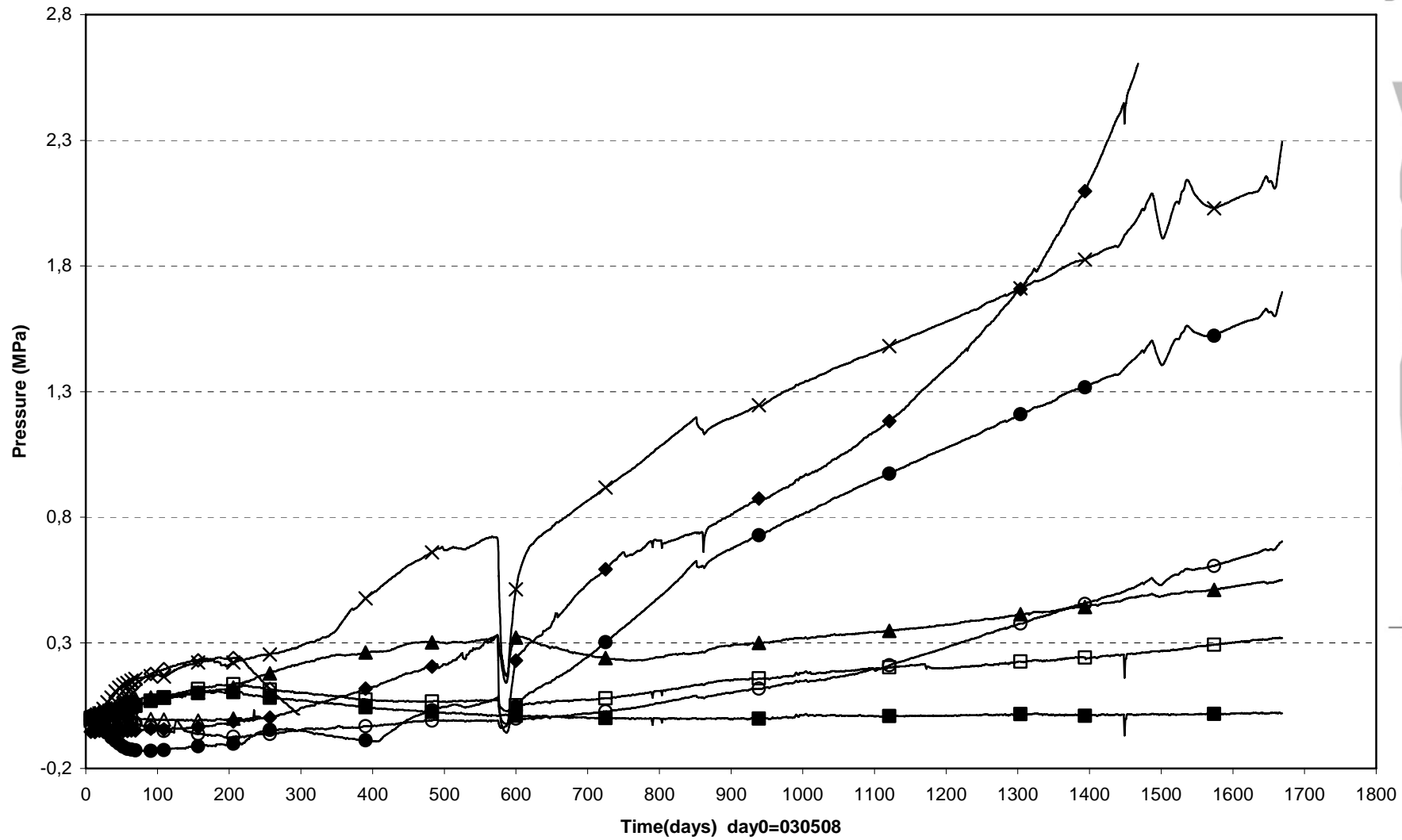

- PB503(0.340 \5° 0.585)    ■ PB504(0.340 \5° 0.685)    ◇ PB505(0.340 \5° 0.785)    ◆ PB510(2.876 \10° 0.535)    △ PB512(2.876 \5° 0.825)
- ▲ PB516(2.876 \190° 0.825)    ○ PB518(5.433 \10° 0.585)    ● PB519(5.433 \10° 0.685)    × PB520(5.433 \10° 0.785)

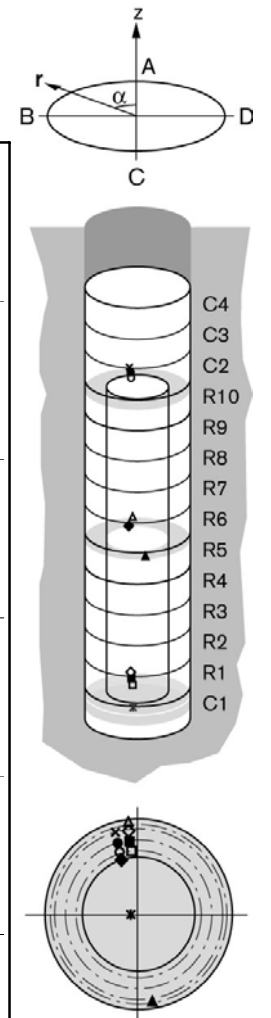

Prototype\Hole 5\Cyl.1 (030508-071201)  
Relative humidity - Vaisala

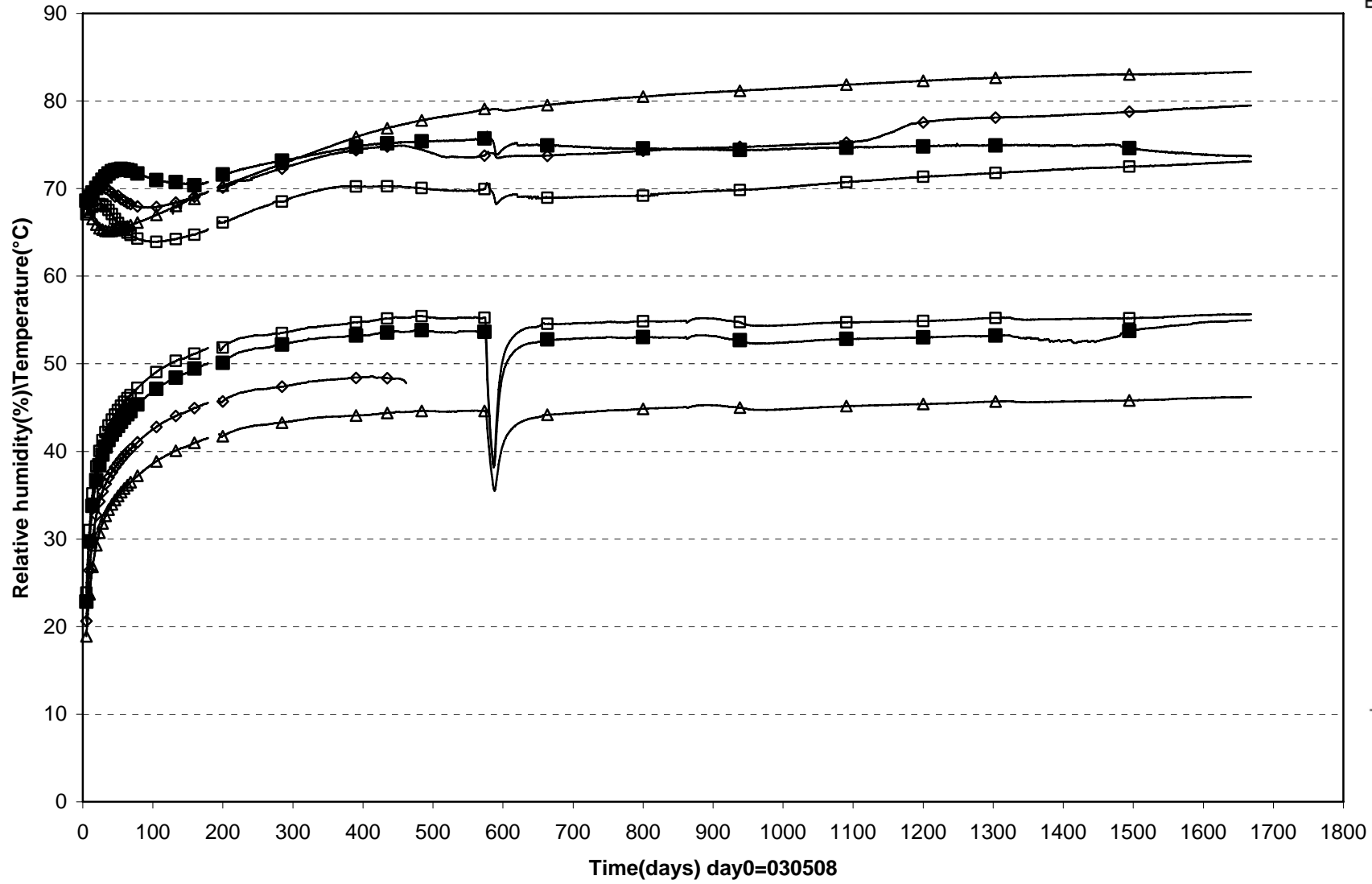

WB504(0.340\350°\0.585)    
  WB505(0.340\350°\0.685)    
  WB506(0.340\350°\0.785)    
  WB507(0.340\80°\0.585)

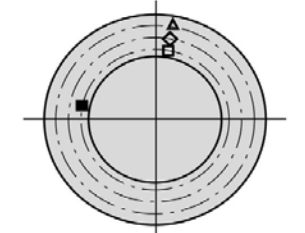
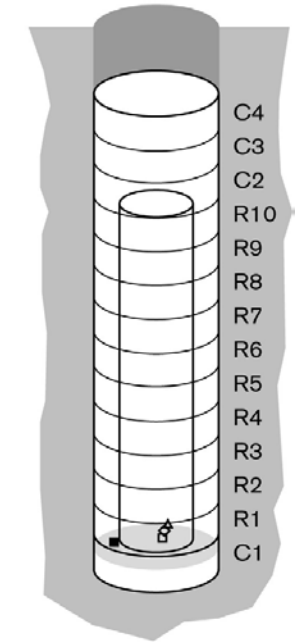
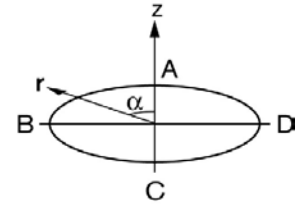

Prototype\Hole 5\Ring 5 (030508-071201)  
Relative humidity - Vaisala

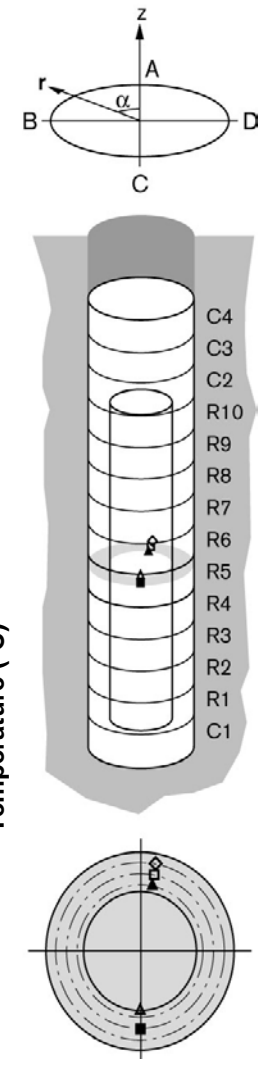
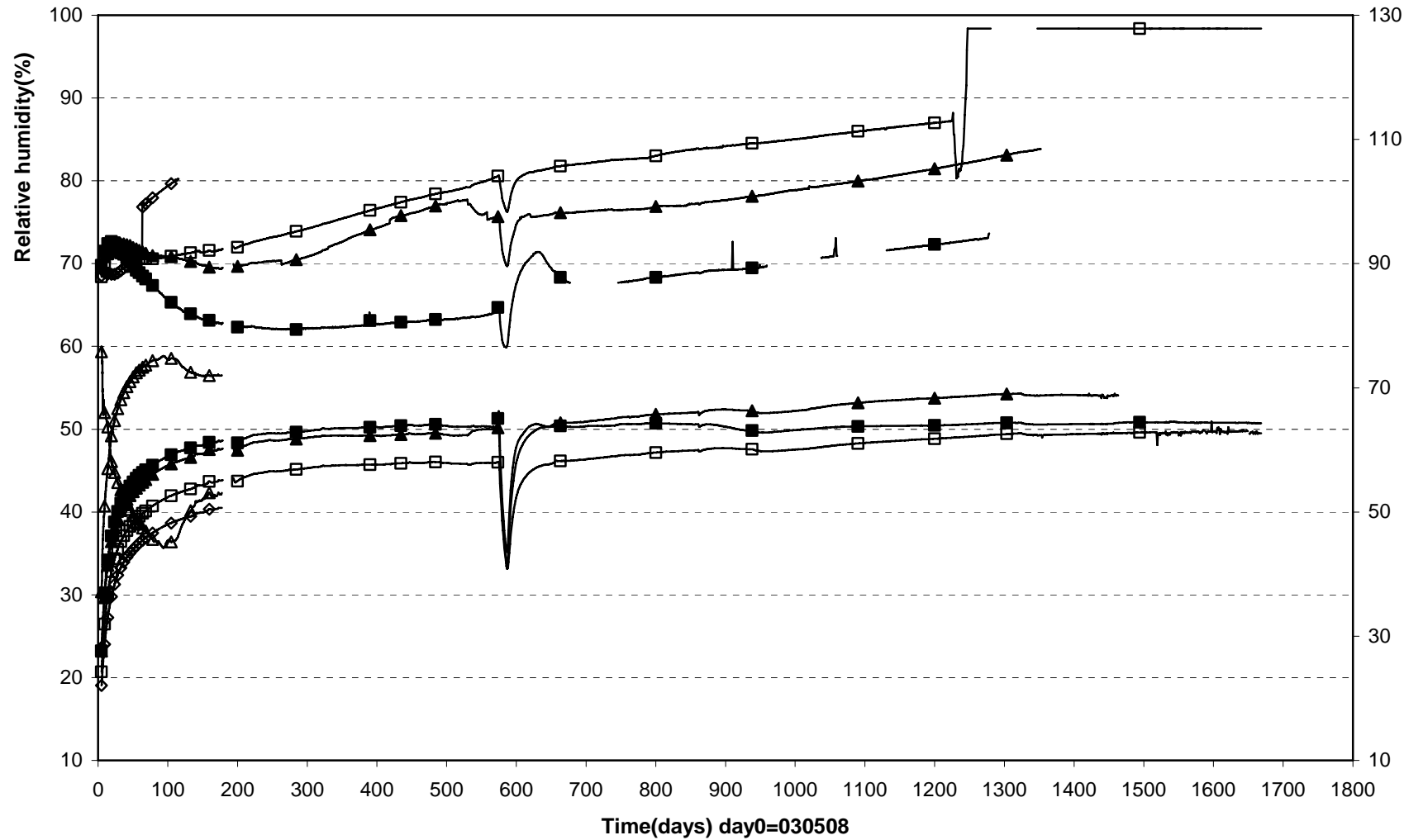

▲ WB513(2.876\350°\0.585)    □ WB514(2.876\350°\0.685)    ◇ WB515(2.876\350°\0.785)    △ WB519(2.876\180°\0.535\In the slot)    ■ WB520(2.876\180°\0.685)

Prototype\Hole 5\Ring 10 (030508-071201)  
Relative humidity - Vaisala

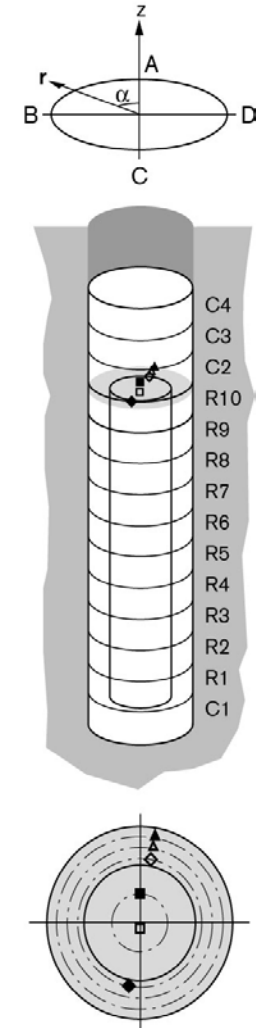
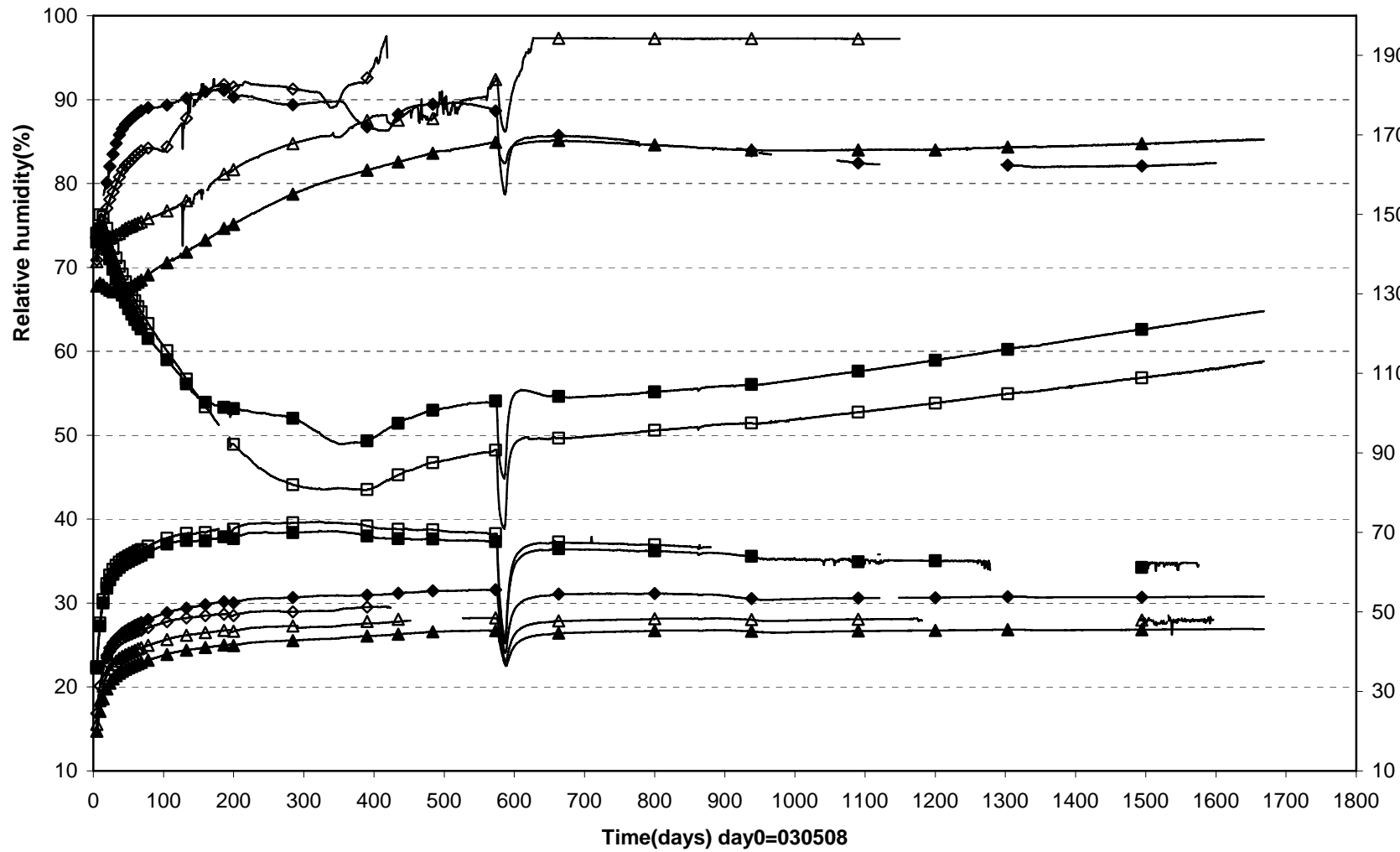

□ WB522(5.433\180°\0.050) ■ WB523(5.433\ 0° \0.262) ◇ WB524(5.433\350°\0.585) △ WB525(5.433\350°\0.685) ▲ WB526(5.433\350°\0.785) ◆ WB530(5.433\170°\0.585)

Prototype\Hole 5\Cyl.3 and Cyl.4 (030508-071201)  
Relative humidity - Vaisala

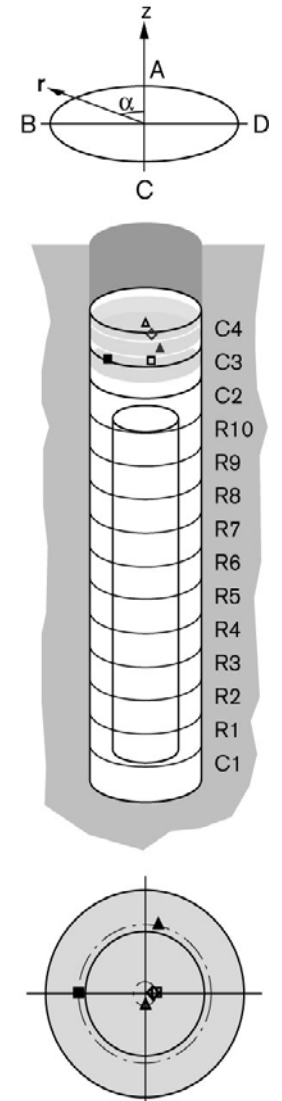
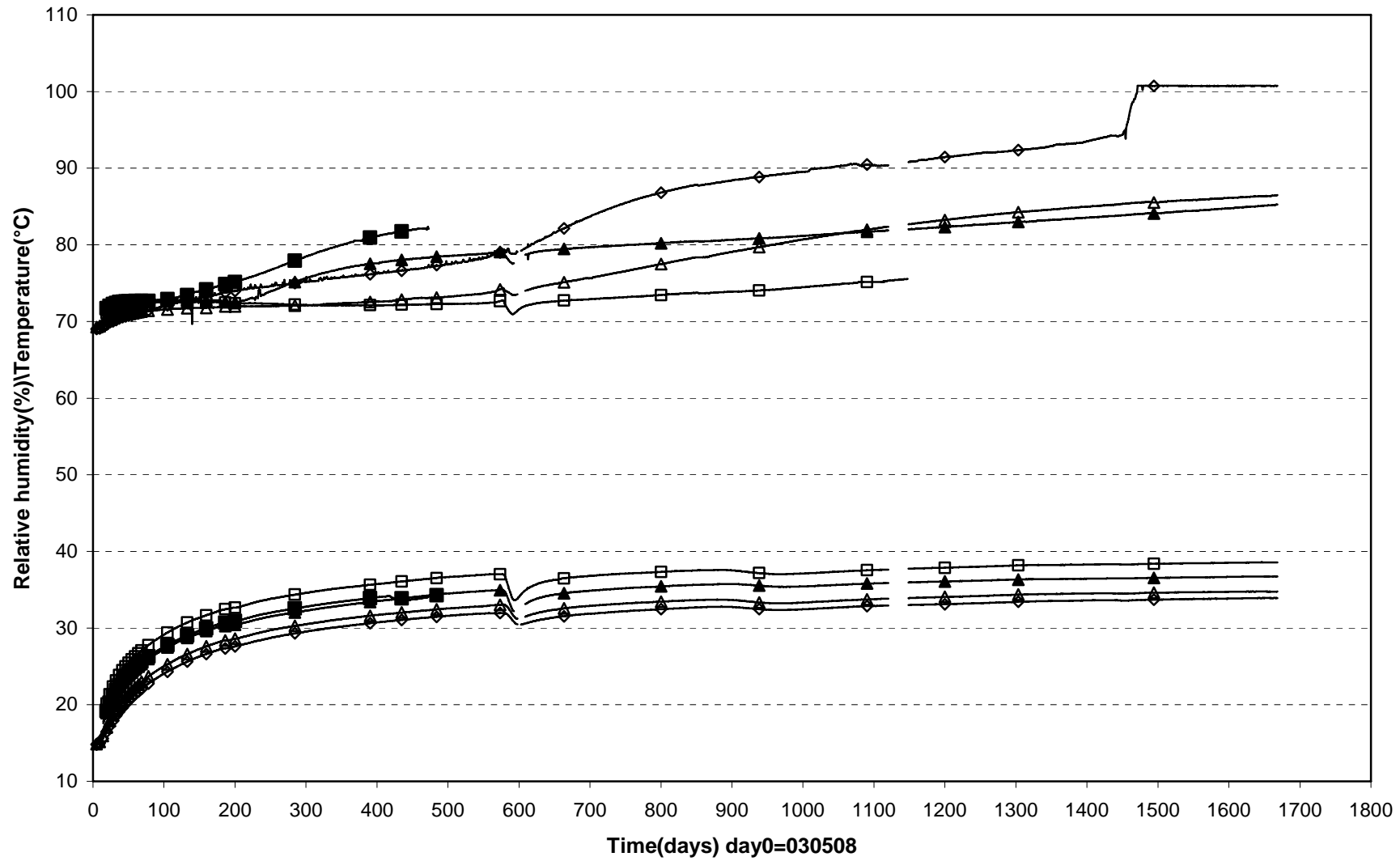

□ WB532(6.353\270°\0.100) ▲ WB533(6.353\350°\0.585) ■ WB534(6.353\90°\0.585) △ WB536(6.790\180°\0.100) ◇ WB537(6.950\270°\0.100)

Prototyp\Hole 5\Cyl.1 (030508-071201)  
Relative humidity - Rotronic

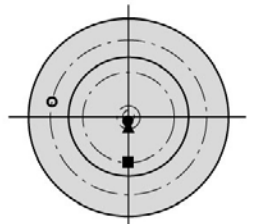
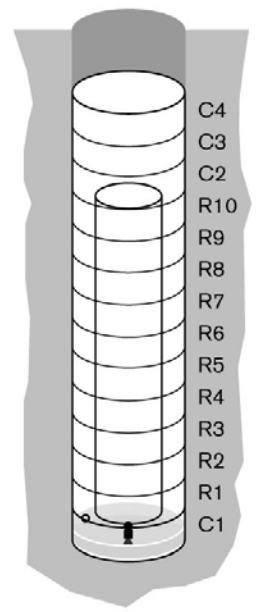
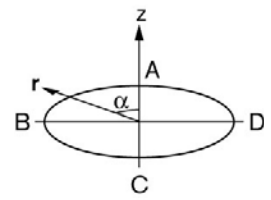
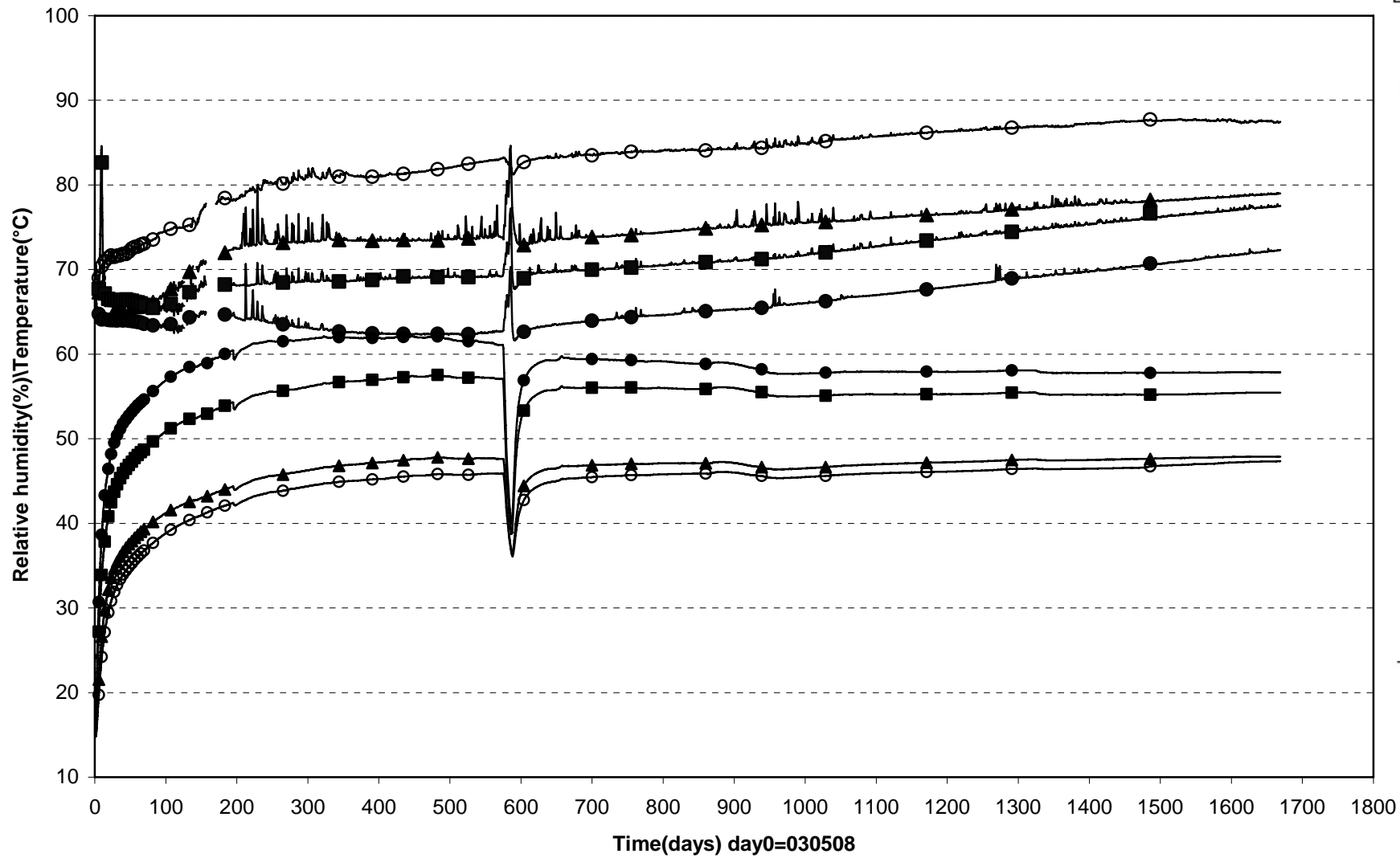

● WB501 (0.250\180°\0.050)    ▲ WB502 (0.05\180°\0.100)    ■ WB503 (0.250\180°\0.400)    ○ WB508(0.250\80°\0.685)



Prototyp\Hole 5\Cyl.1 (030508-071201)  
 Relative humidity - Rotronic

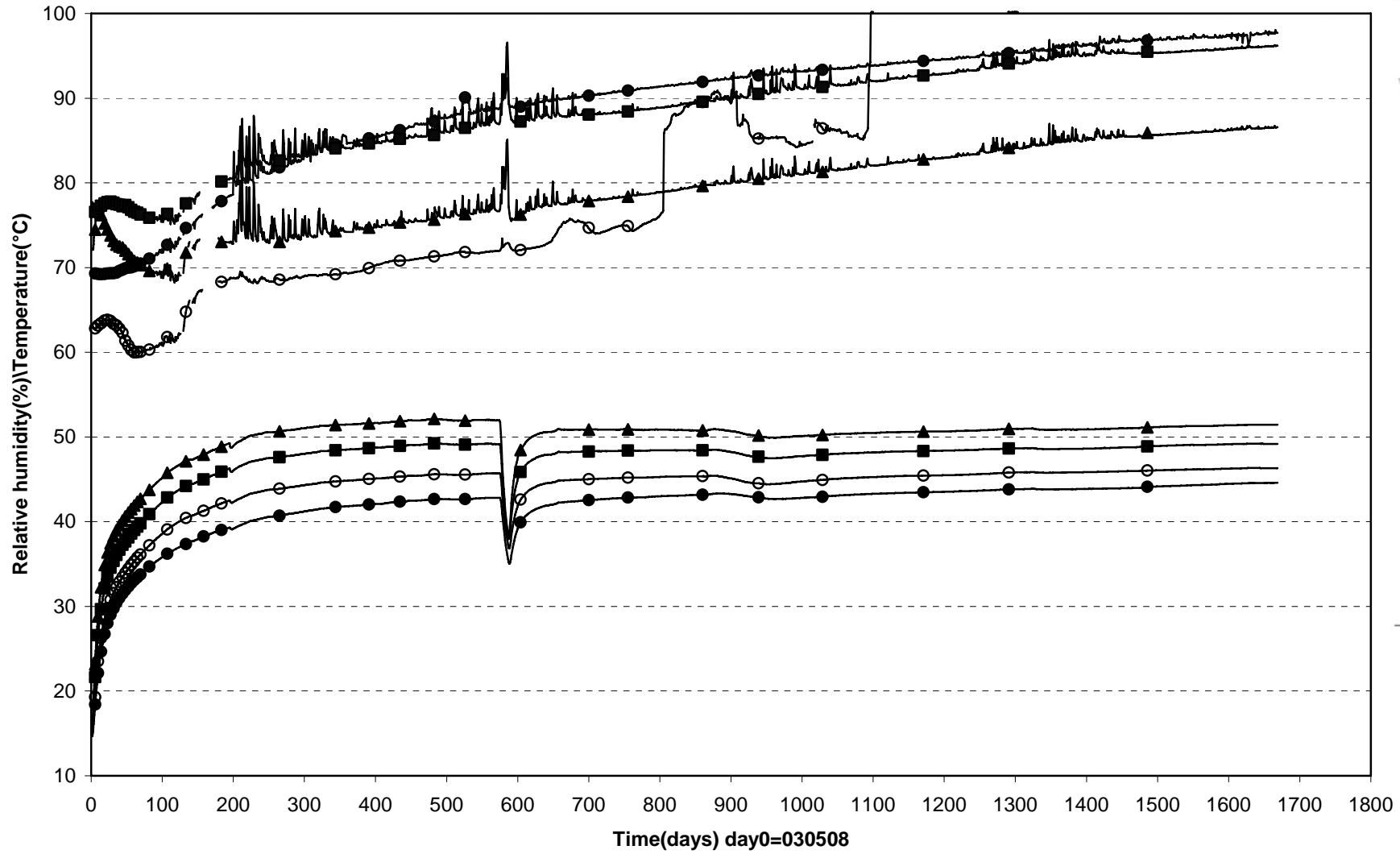

● WB509(0.250\80°\0.785) ▲ WB510(0.250\170°\0.585) ■ WB511(0.250\170°\0.685) ○ WB512(0.250\170°\0.785)

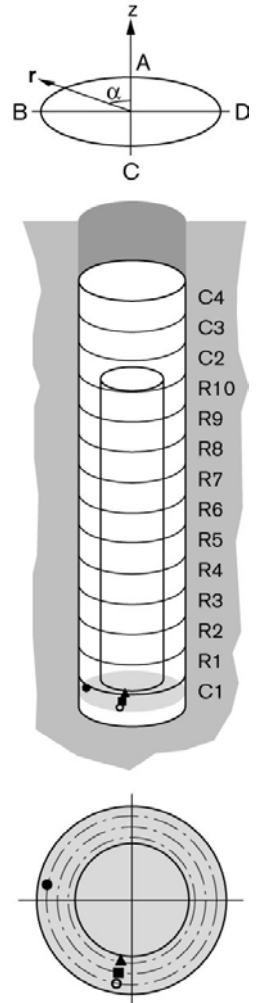

Prototyp\Hole 5\Ring5 (030508-071201)  
 Relative humidity - Rotronic

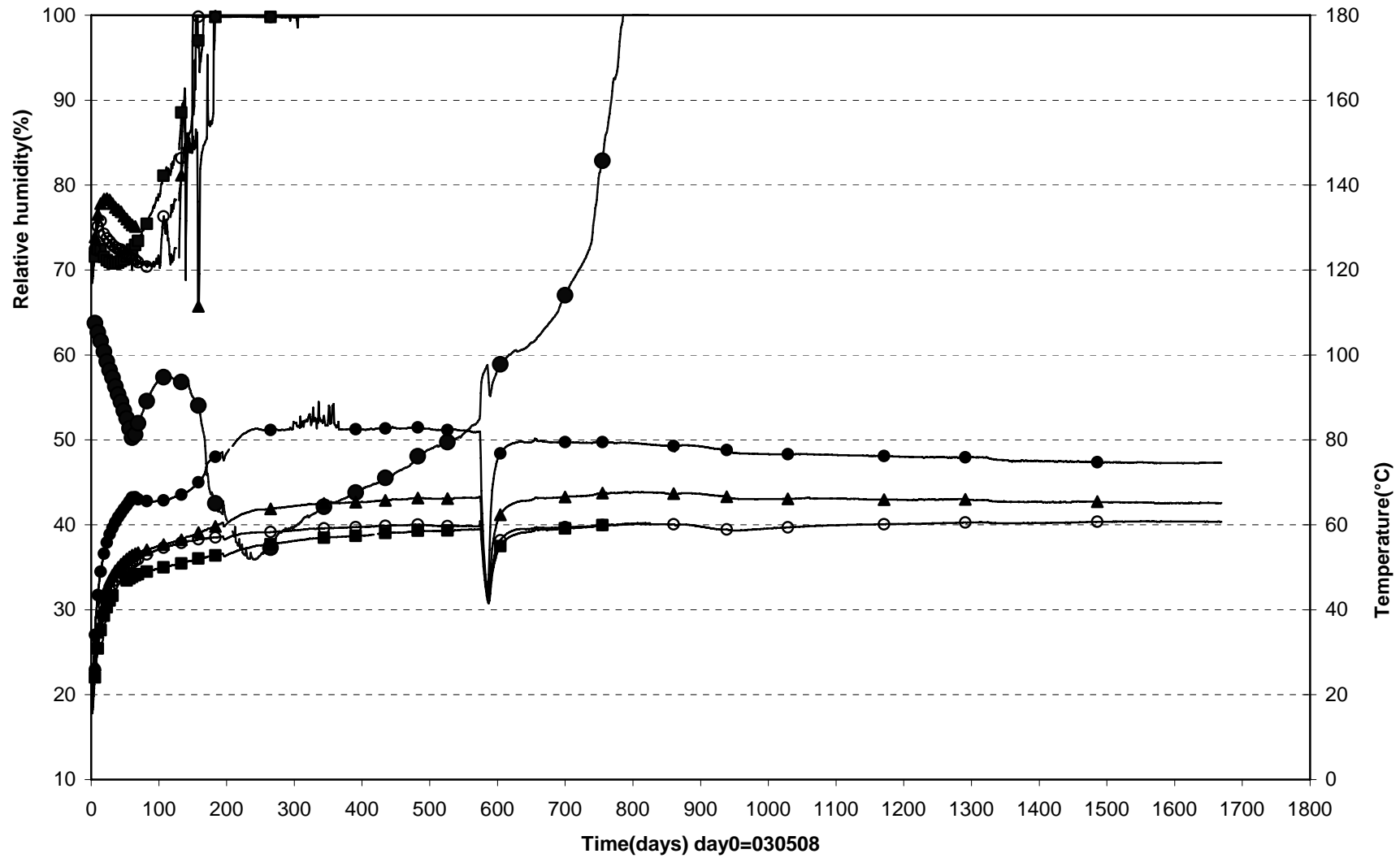

● WB516(2.786\80°\0.535) ▲ WB517(2.786\80°\0.685) ■ WB518(2.786\80°\0.785) ○ WB521(2.786\180°\0.785)

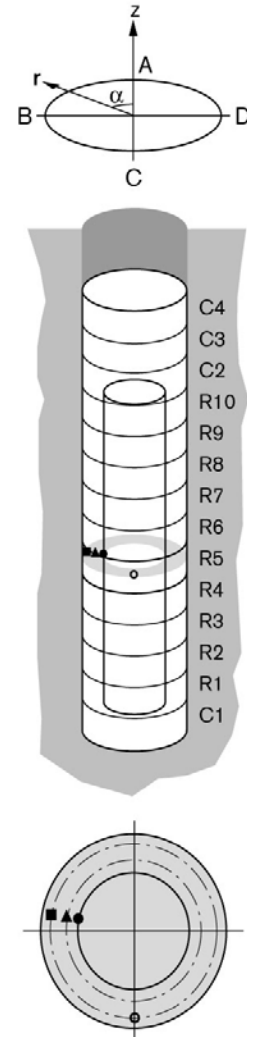

Prototyp\Hole 5\Ring10 (030508-071201)  
Relative humidity - Rotronic

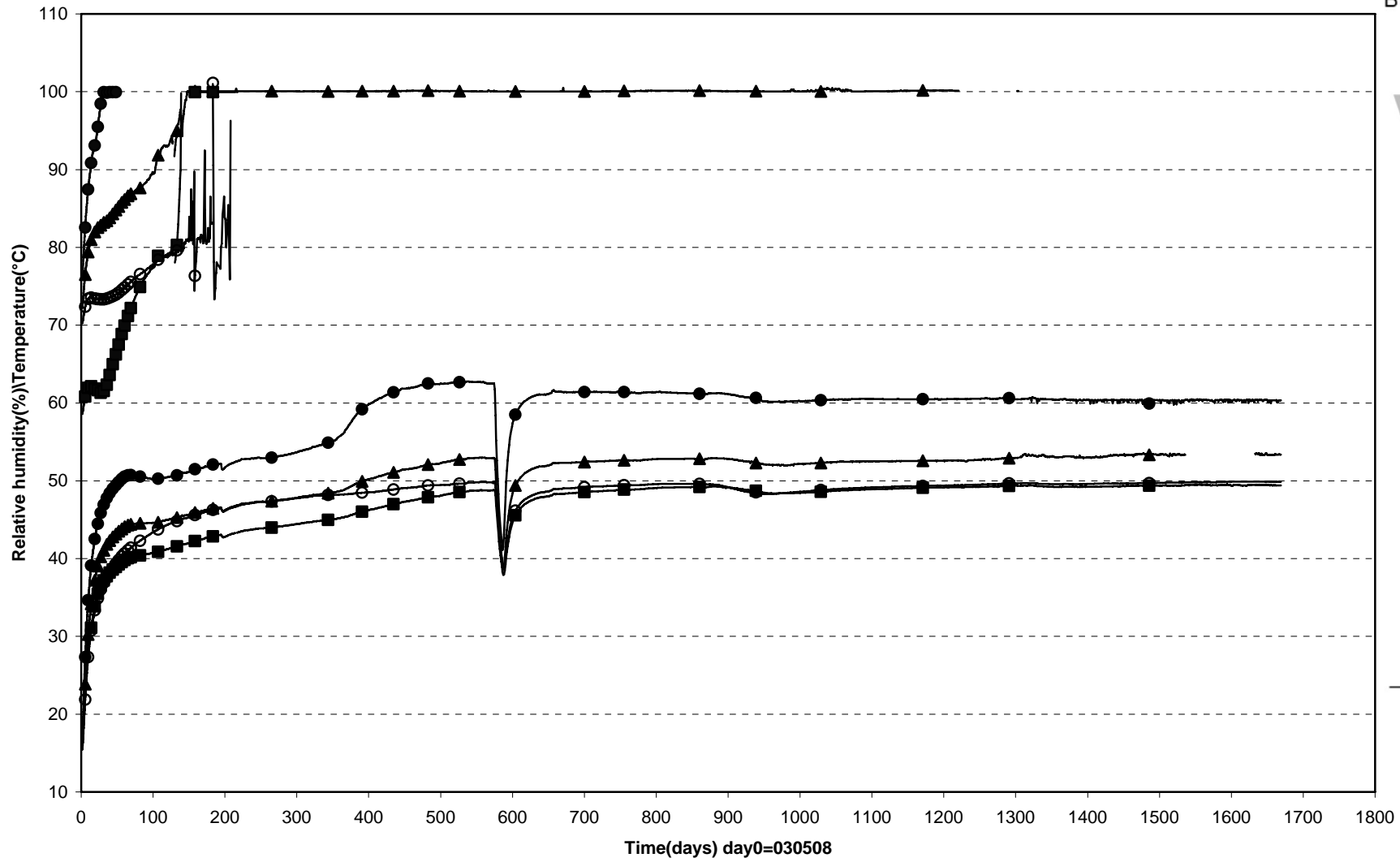

● WB527(5.343\80°\0.585) ▲ WB528(5.343\80°\0.685) ■ WB529(5.343\80°\0.785) ○ WB531(5.343\170°\0.785)

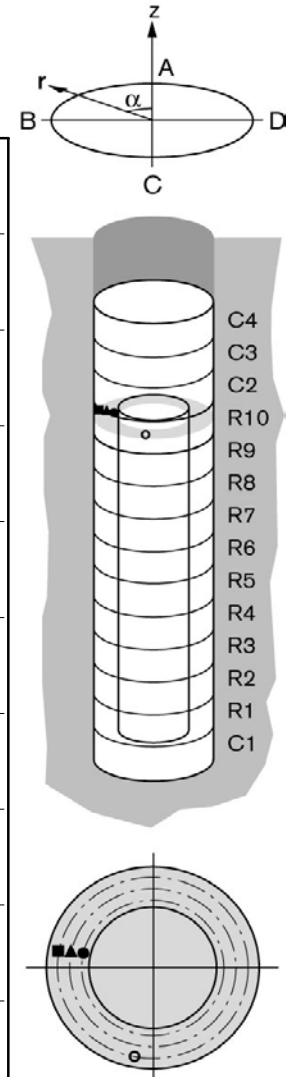

Prototyp\Hole 5\Cyl.3 (030508-071201)  
 Relative humidity - Rotronic

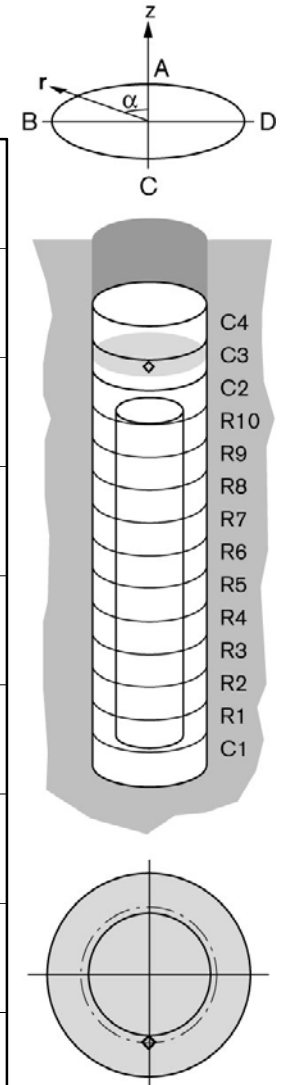
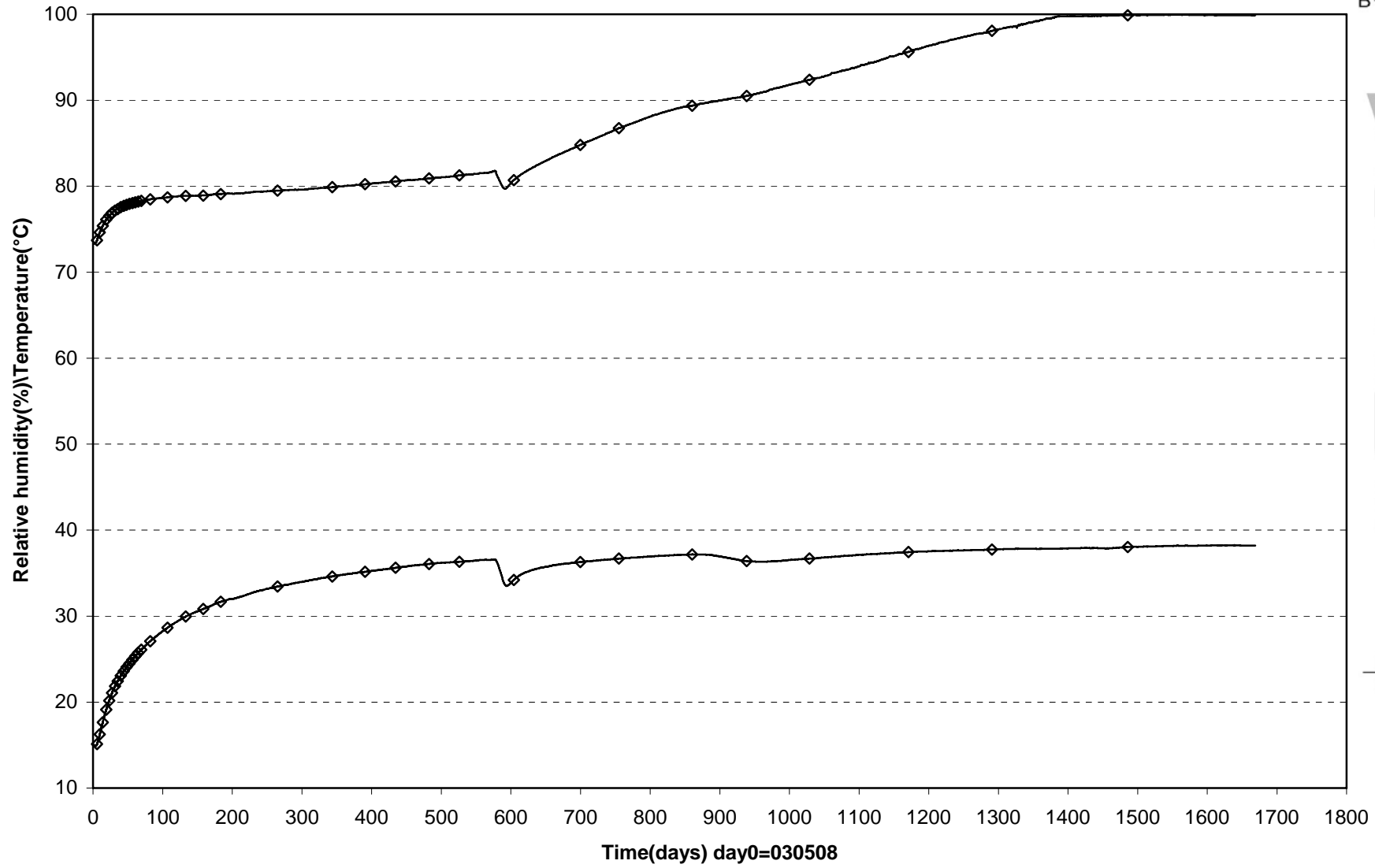

Prototype\ Hole 5 \ Ring 3 (030508-071201)  
Suction - Wescor

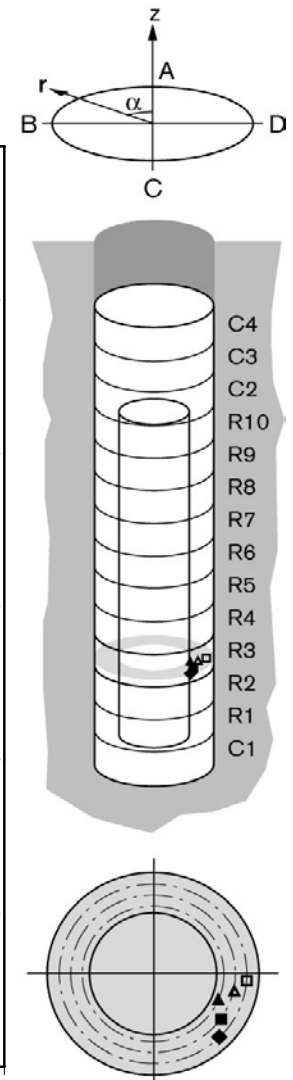
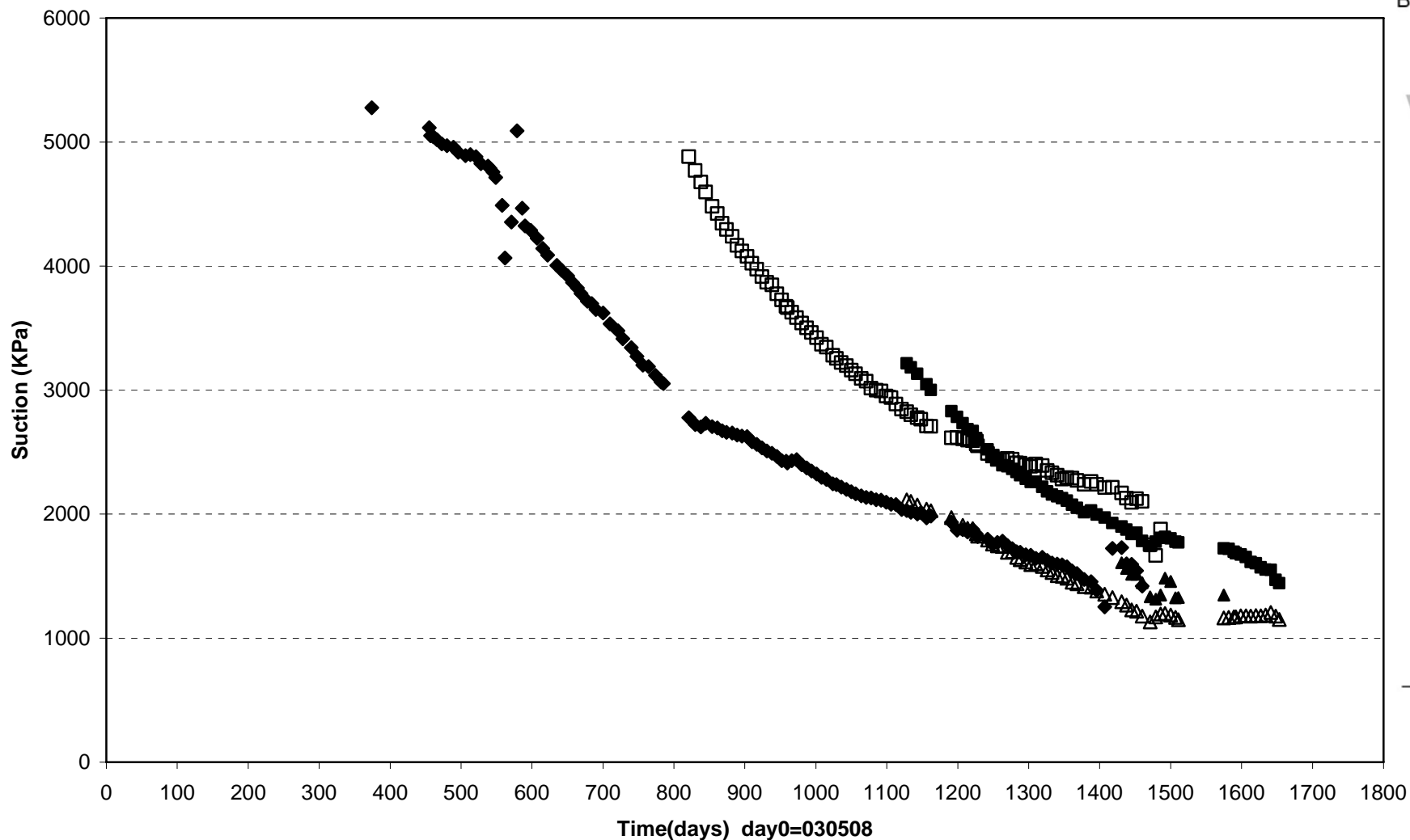

◆ WB538(1.624\225°\0.775) ■ WB539(1.624\235°\0.680) ▲ WB540(1.624\245°\0.585) △ WB541(1.624\255°\0.680) □ WB542(1.624\265°\0.775)

Prototype\Hole5 (030508-071201)  
Pore pressure - Geokon

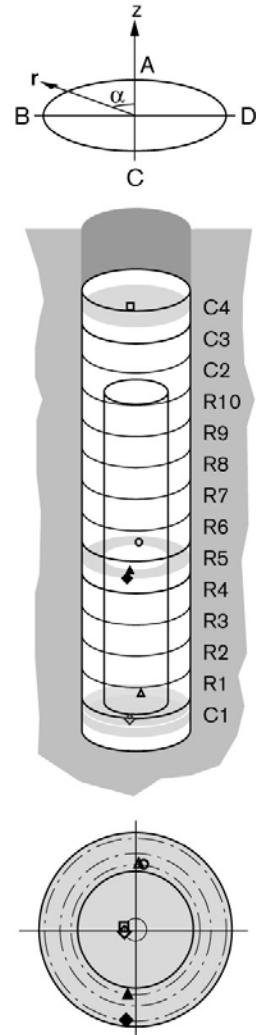
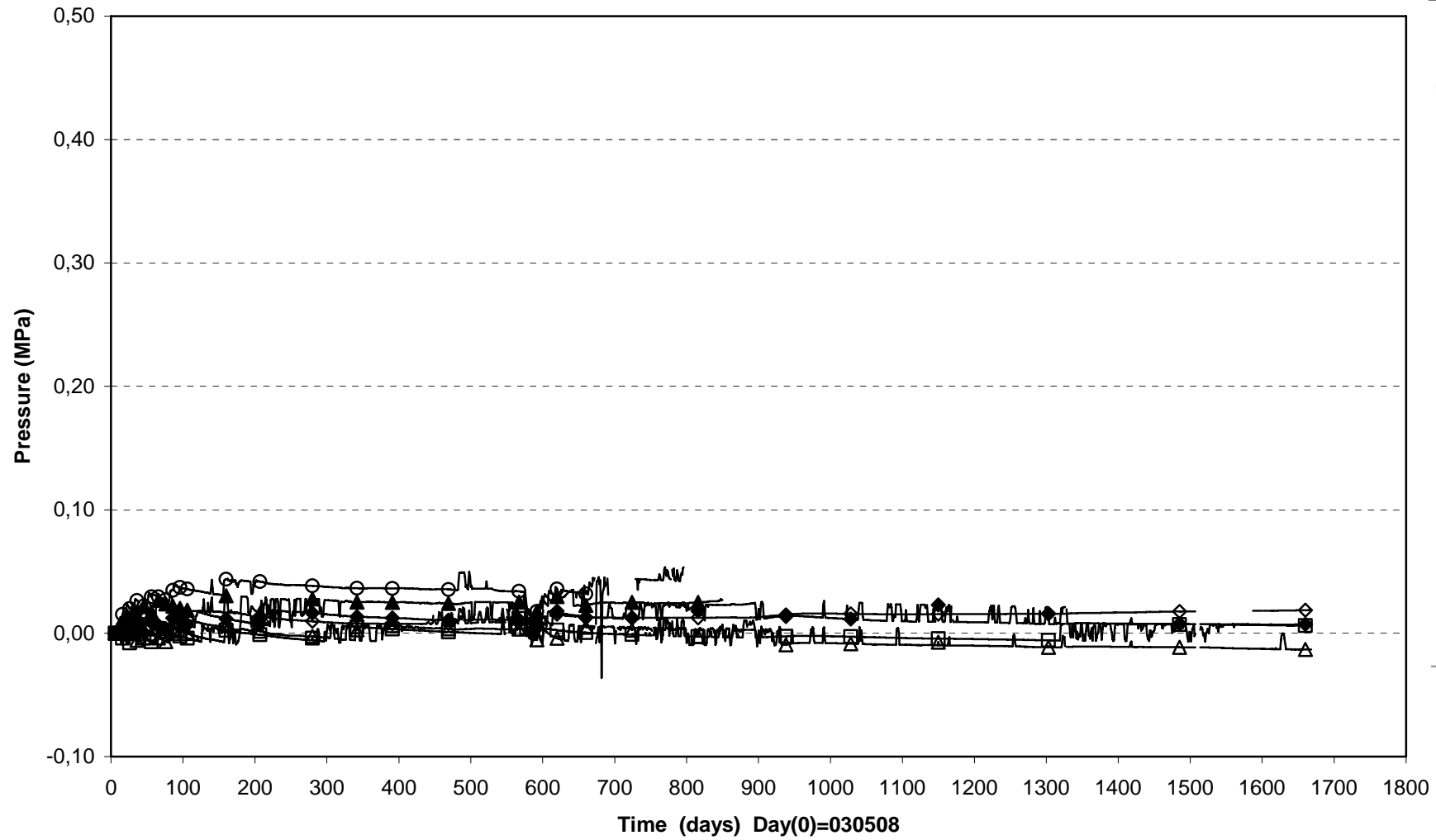

|                           |                           |                           |
|---------------------------|---------------------------|---------------------------|
| ◇ UB502(0.050\90°\0.100)  | △ UB503(0.250\355°\0.585) | ○ UB505(2.786\355°\0.585) |
| ▲ UB509(2.786\175°\0.535) | ◆ UB510(2.786\175°\0.825) | □ UB514(6.860\90°\0.100)  |

Prototype\ Hole 5 (030508-071201)  
Pore pressure - Kulite

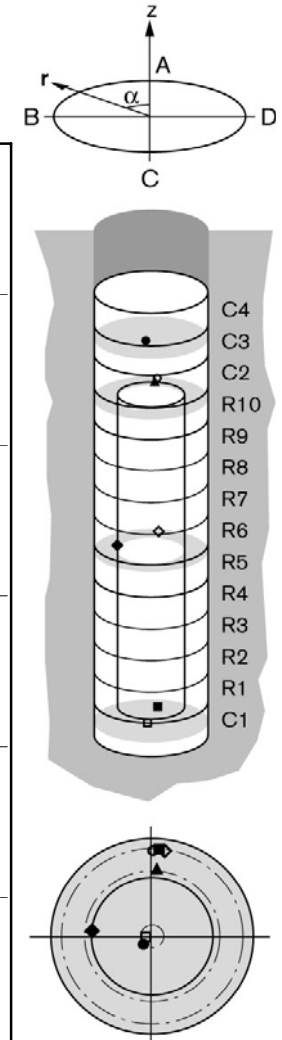
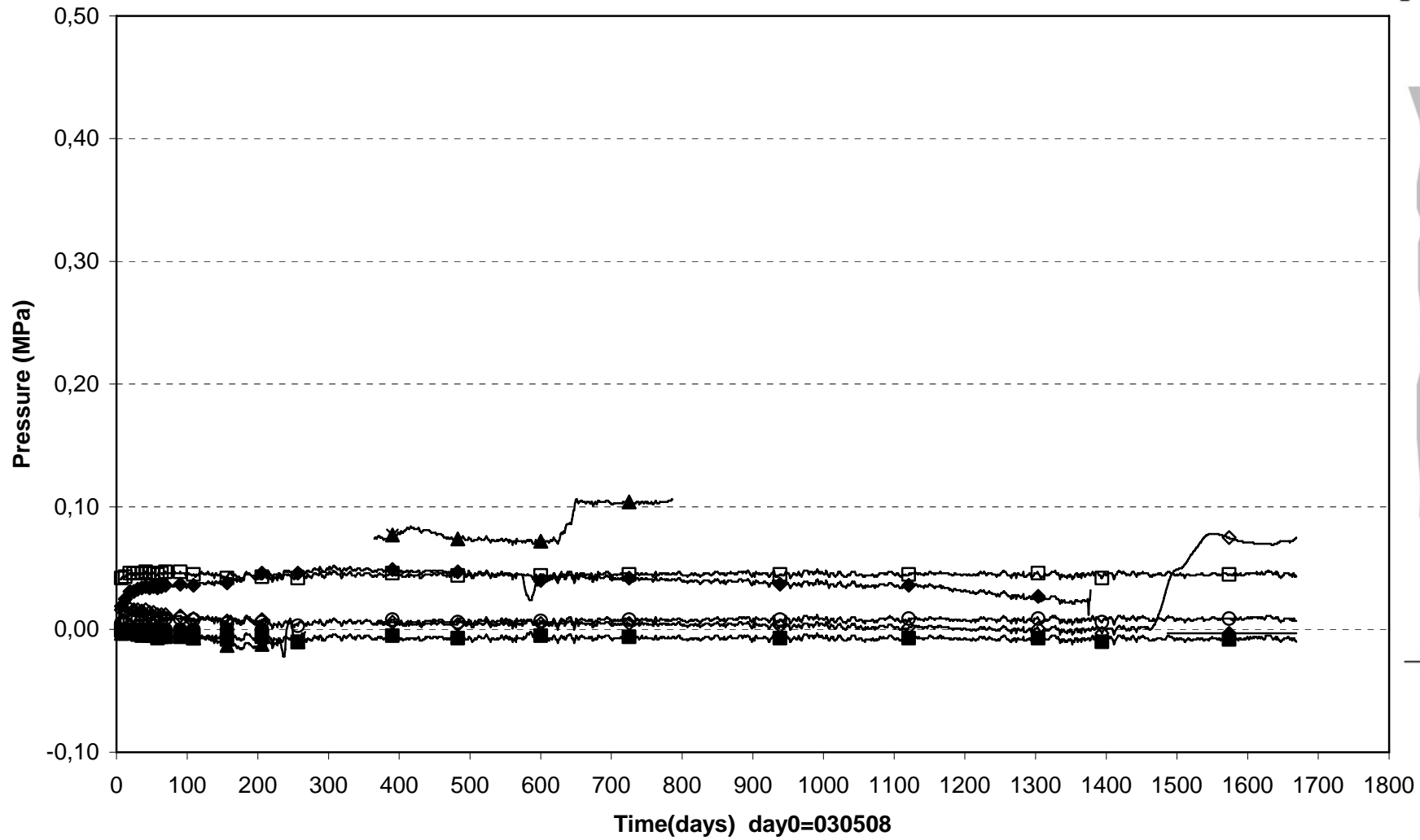

□ UB501(0.250 \90°\ 0.050)    ■ UB504(0.340 \355°\ 0.785)    ◇ UB506(2.876 \355°\ 0.785)    ◆ UB507(2.876 \85°\ 0.535)  
 ▲ UB511(5.433 \355°\ 0.585)    ○ UB512(5.433 \355°\ 0.785)    ● UB513(6.250 \135°\ 0.100)

Prototype\Hole 5\Cyl.1 (030508-071201)  
 Temperature - Pentronic

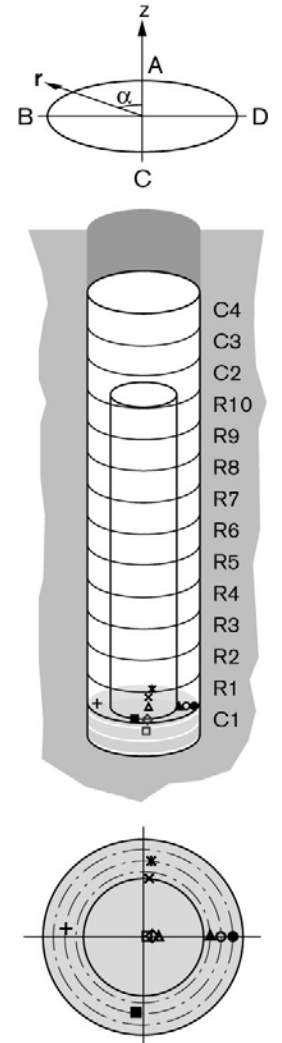
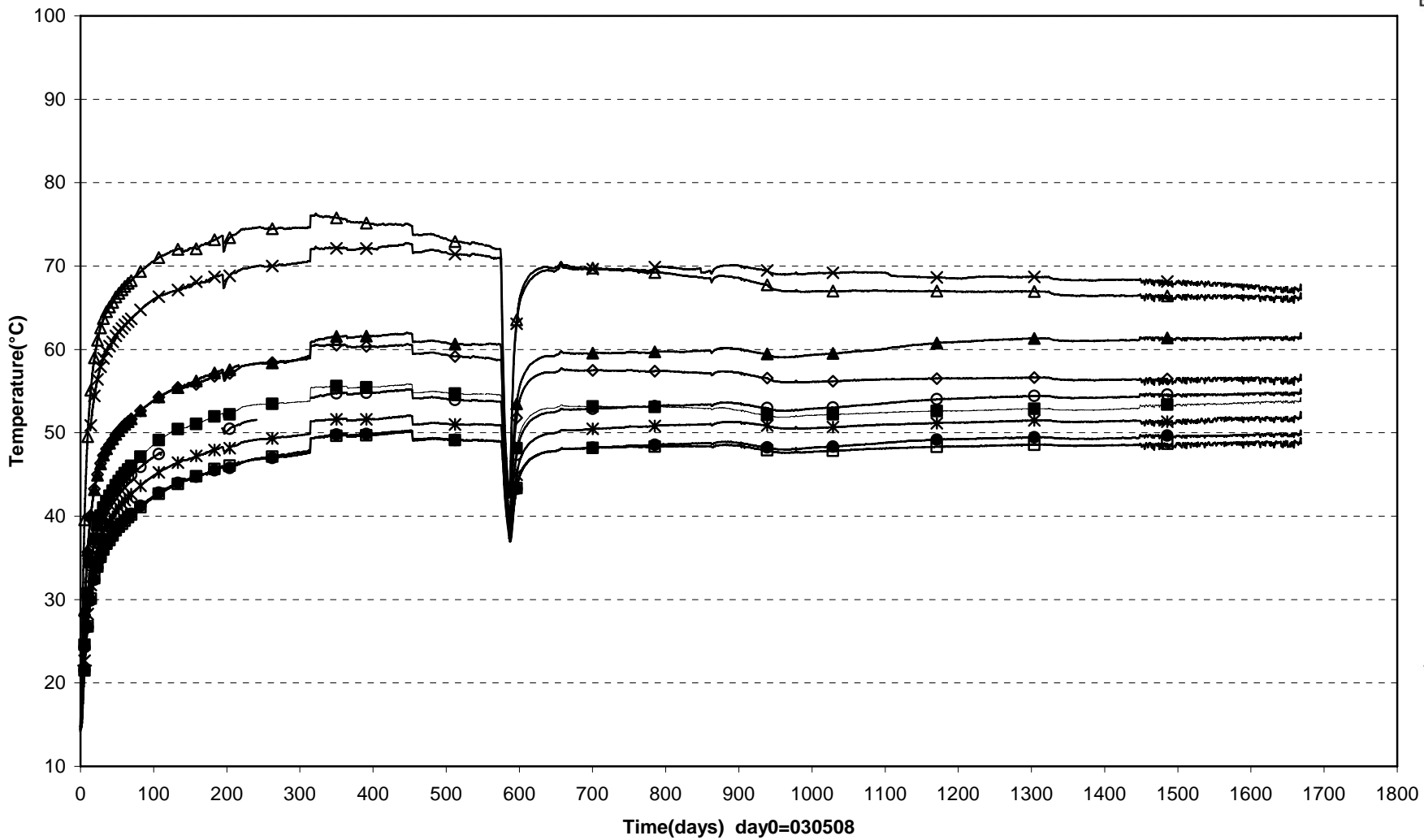

□ TB501(0.080\270°\0.050)   ◇ TB502(0.250\270°\0.060)   △ TB503(0.450\270°\0.070)   × TB504(0.450\355°\0.525)   ✖ TB505(0.450\355°\0.685)  
 + TB506(0.450\85°\0.685)   ■ TB507(0.450\175°\0.685)   ▲ TB508(0.450\270°\0.585)   ○ TB509(0.450\270°\0.685)   ● TB510(0.450\270°\0.785)



Prototype\Hole 5 \Ring5 (030508-071201)  
 Temperature - Pentronic

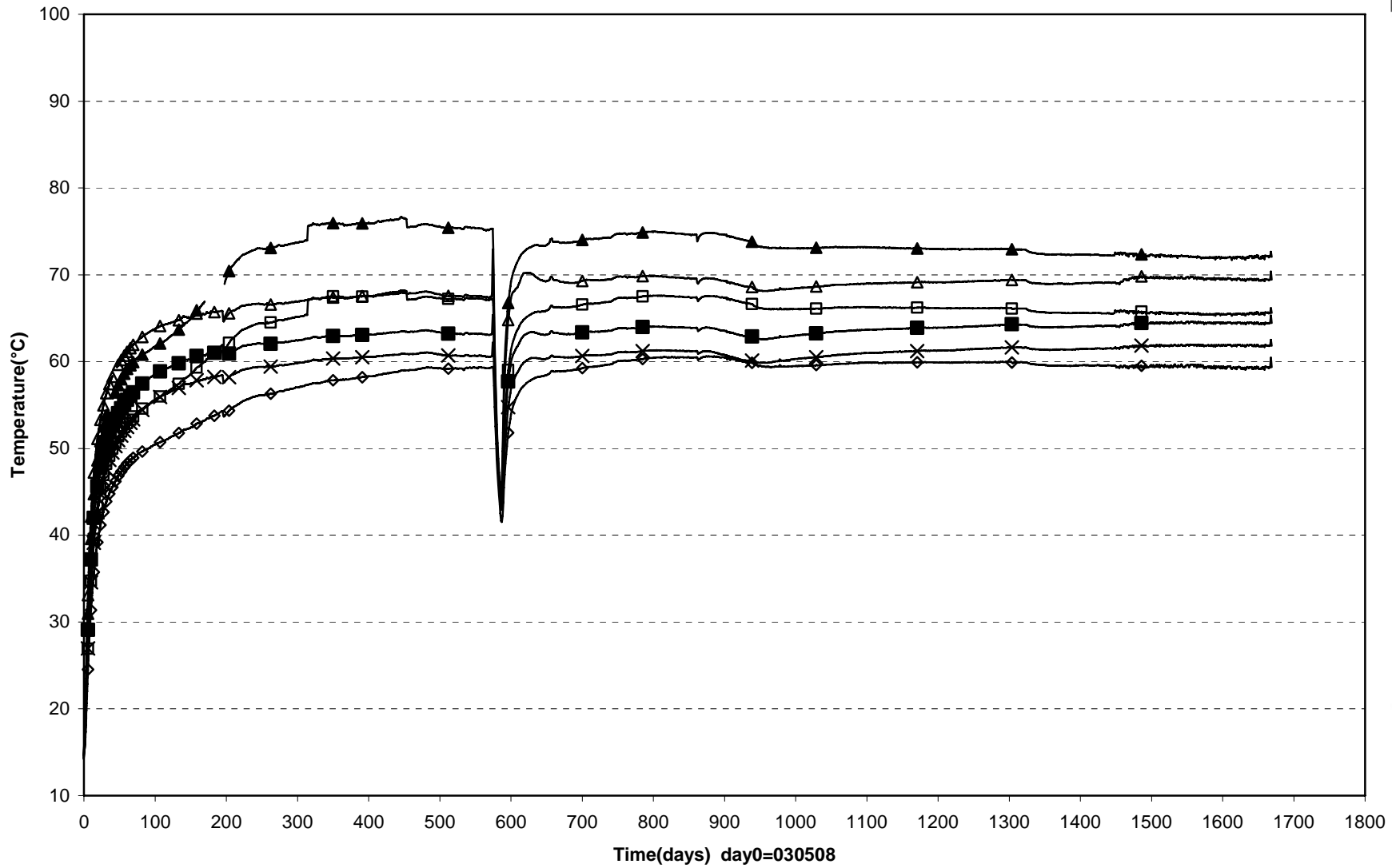

|                           |                           |                           |
|---------------------------|---------------------------|---------------------------|
| ▲ TB513(2.986\85°\0.585)  | □ TB514(2.986\85°\0.685)  | ◇ TB515(2.986\85°\0.785)  |
| △ TB516(2.986\175°\0.585) | ■ TB517(2.986\175°\0.685) | × TB518(2.986\175°\0.735) |

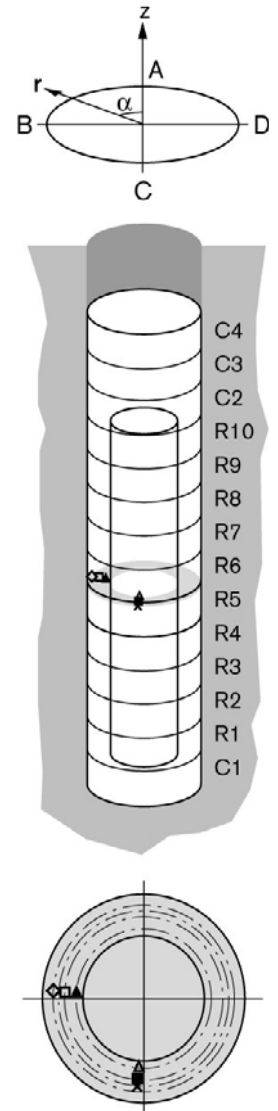

Prototype\Hole 5 \Ring5 (030508-071201)  
 Temperature - Pentronic

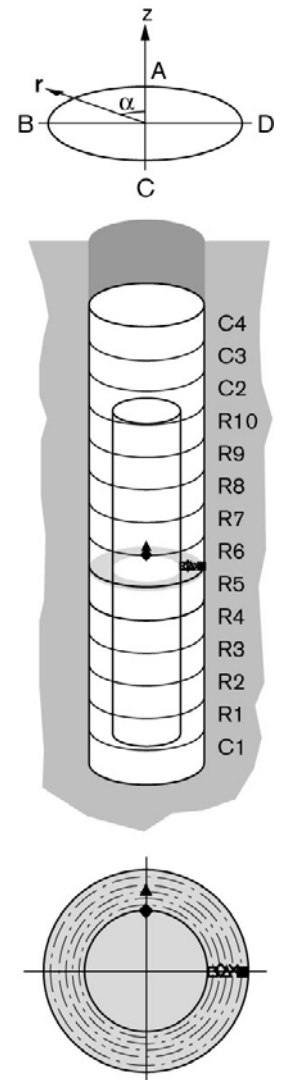
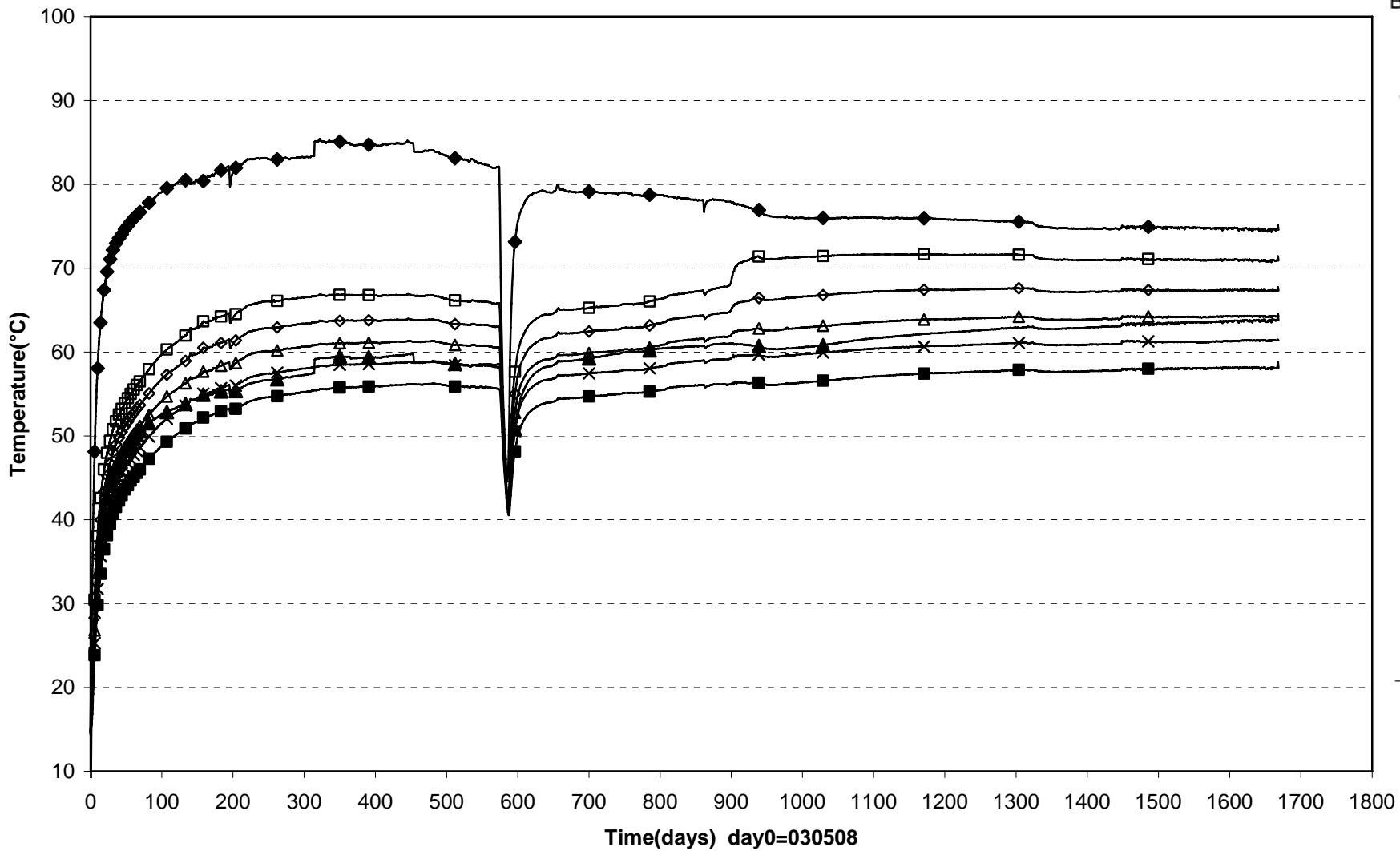

□ TB519(2.986\270°\0.585)    ◇ TB520(2.986\270°\0.635)    △ TB521(2.986\270°\0.685)    × TB522(2.986\270°\0.735)    ■ TB523(2.986\270°\0.785)  
 ◆ TB511(2.950\0°\0.525)    ▲ TB512(2.986\0°\0.685)

Prototype\Hole 5 \Ring10 (030508-071201)  
 Temperature - Pentronic

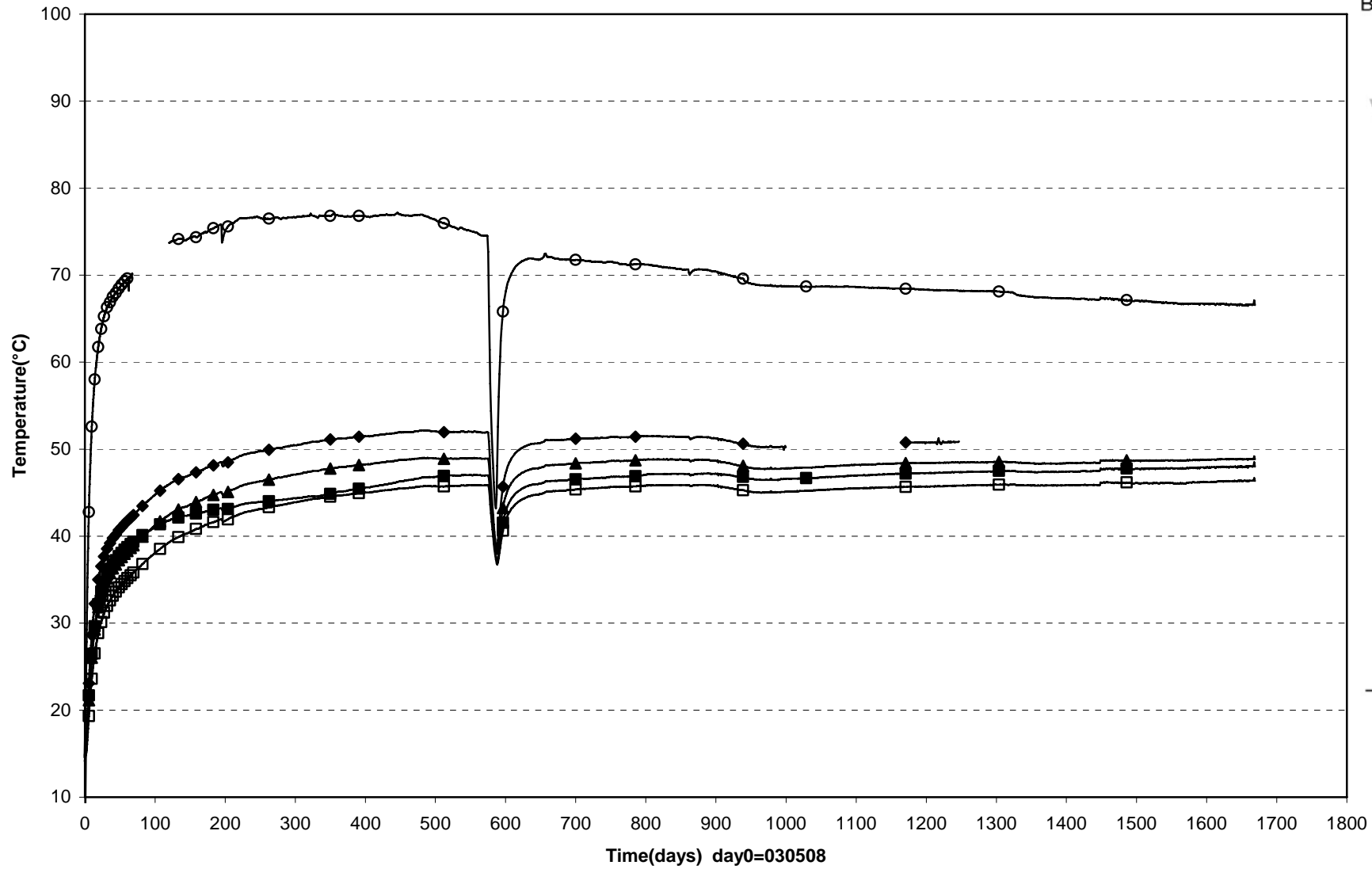

○ TB524(5.150\ 0°\0.525) ■ TB525(5.543\ 0°\0.685) ◆ TB526(5.543\ 270°\0.585) ▲ TB527(5.543\ 270°\0.685) □ TB528(5.543\ 270°\0.785)

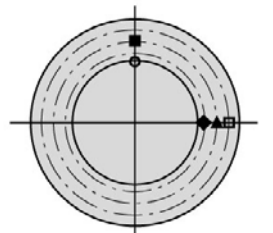
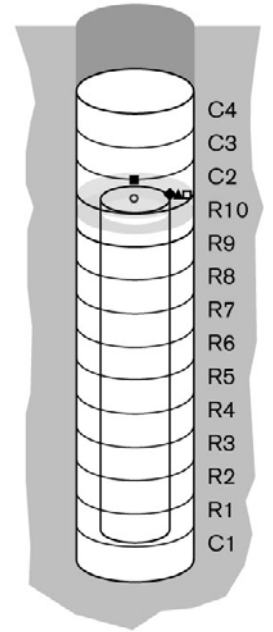
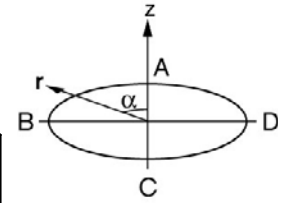

Prototype\Hole 5 \Cyl.3 and Cyl.4 (030508-071201)  
 Temperature - Pentronic

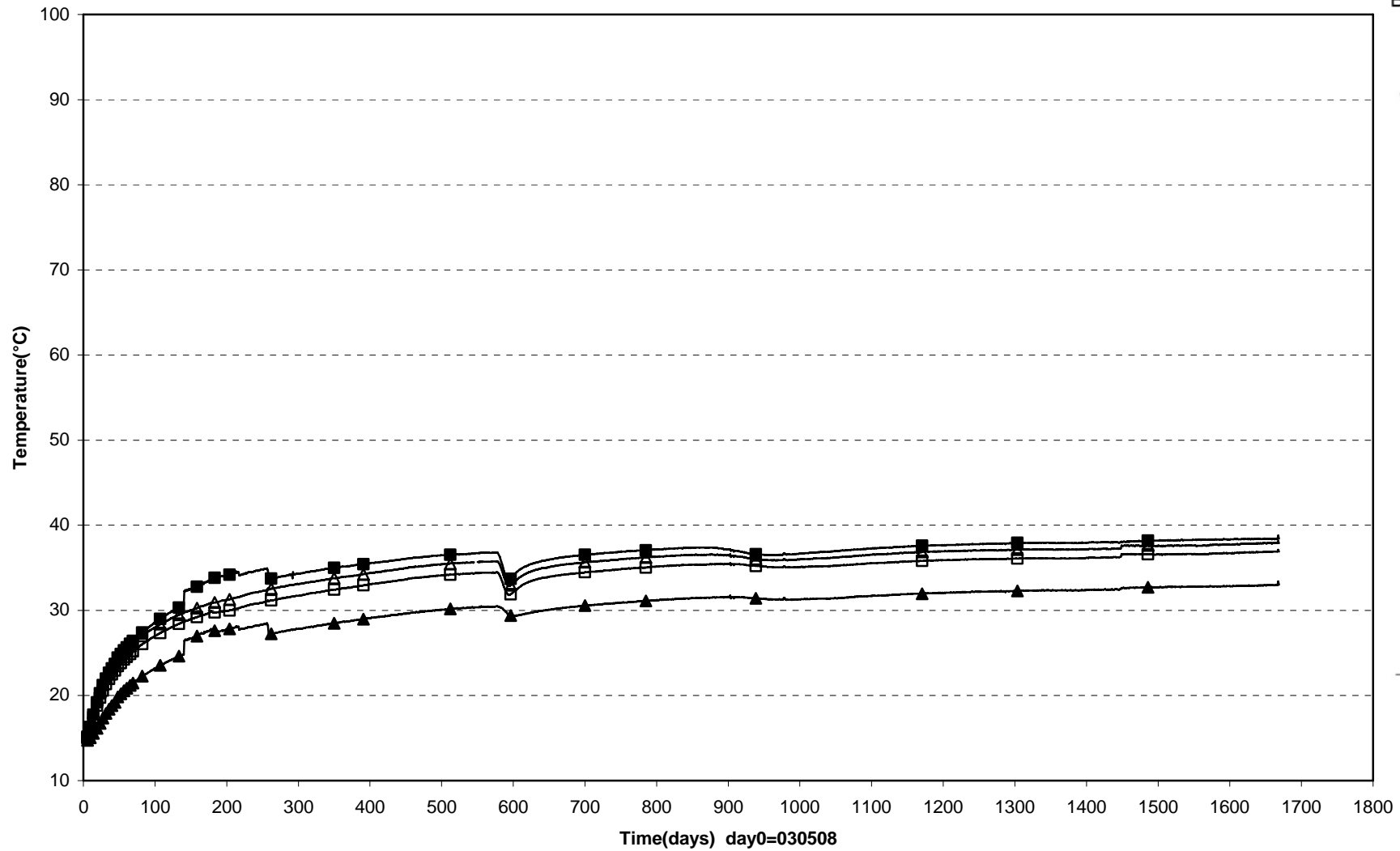

□ TB529(6.353\ 0°\0.785)    △ TB530(6.353\ 95°\0.585)    ■ TB531(6.353\ 185°\0.585)    ▲ TB532(7.060\ 0°\0.785)

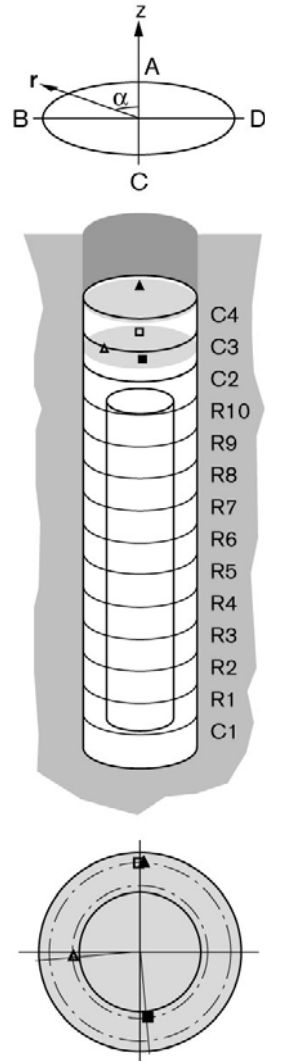

Prototype\Hole 5\Cyl.1 (030508-071201)  
 Temperature - Geokon

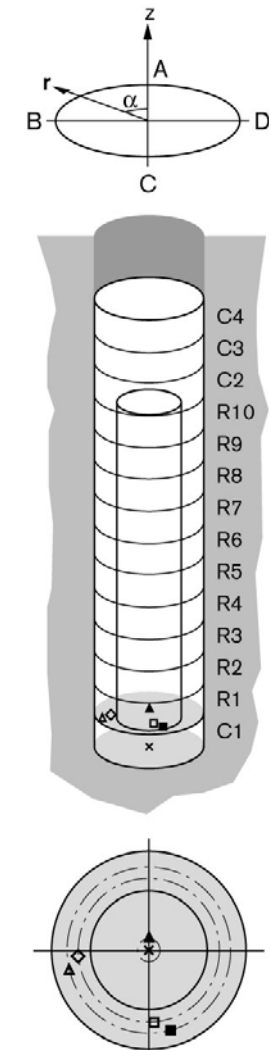
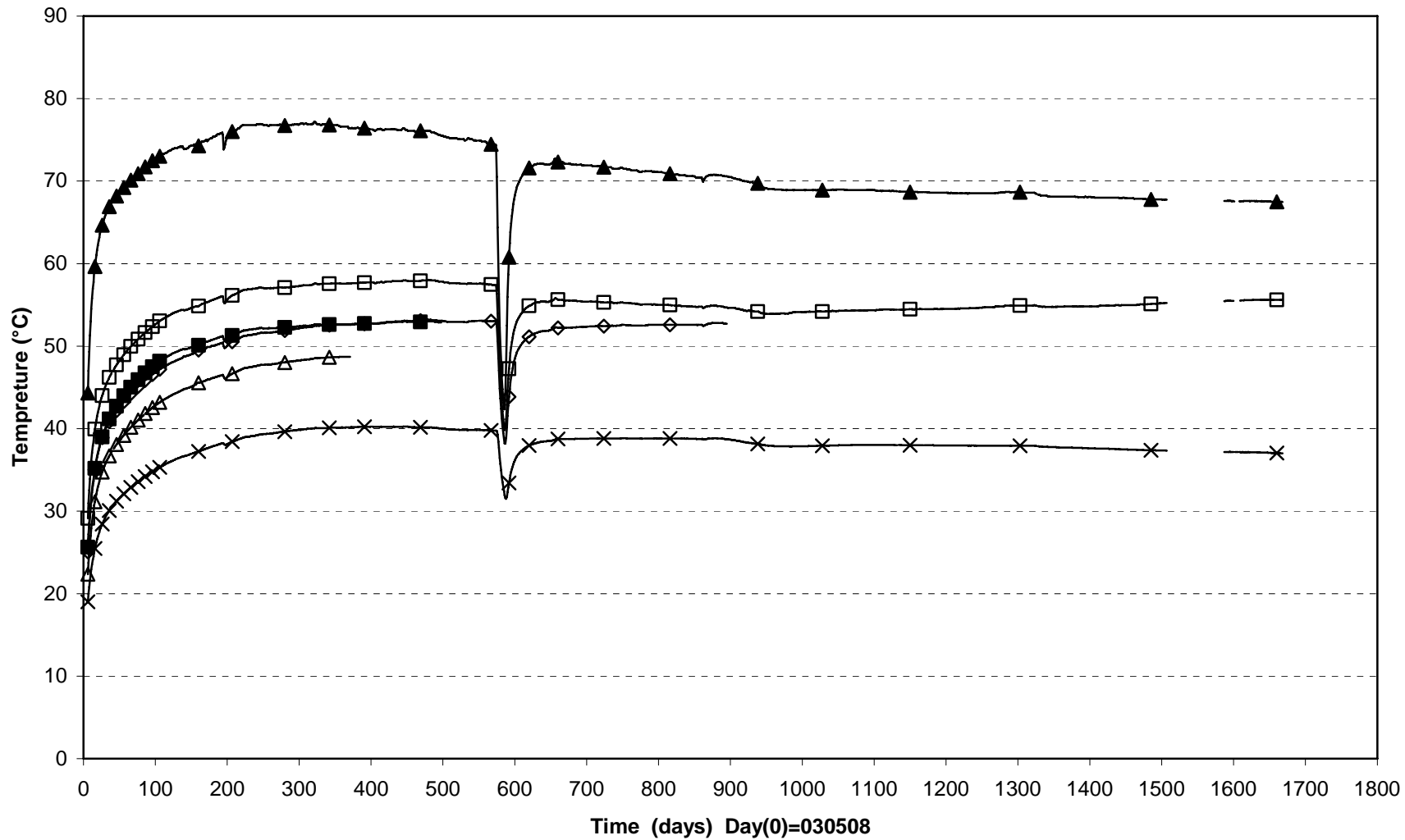

|                            |                            |                            |
|----------------------------|----------------------------|----------------------------|
| × PB501T(0\0°\0)           | ▲ PB502T(0.500\0°\0.100)   | ◇ PB506T(0.500\95°\0.635)  |
| △ PB507T(0.500\105°\0.735) | □ PB508T(0.500\185°\0.635) | ■ PB509T(0.500\195°\0.735) |

Prototype\Hole 5\Ring5 (030508-071201)

Temperature - Geokon

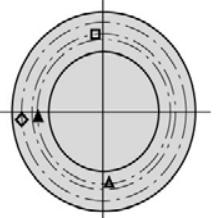
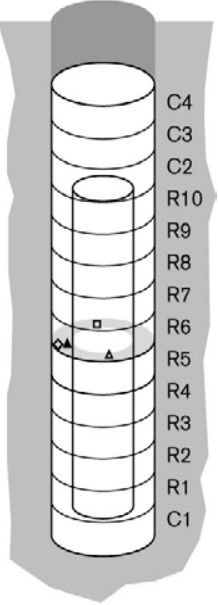
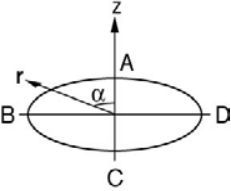
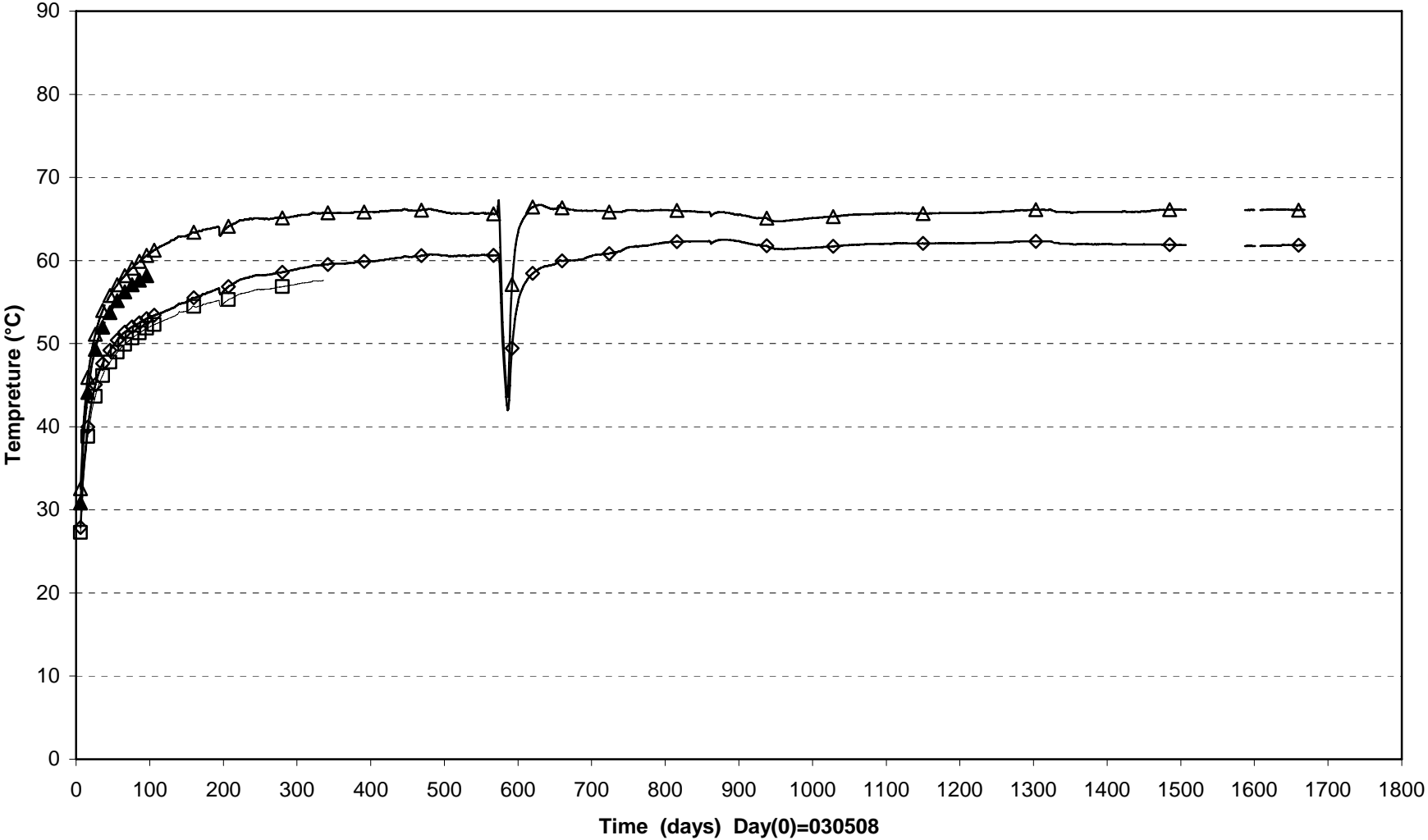

|                           |                            |
|---------------------------|----------------------------|
| □ PB511T(3.036\5°\0.685)  | ▲ PB513T(3.036\95°\0.635)  |
| ◇ PB514T(3.036\95°\0.785) | △ PB515T(3.036\185°\0.635) |

Prototype\Hole 5\Ring10 (030508-071201)  
 Temperature - Geokon

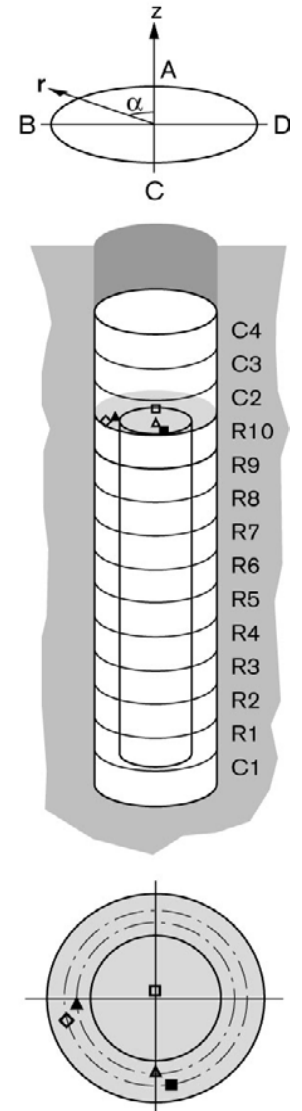
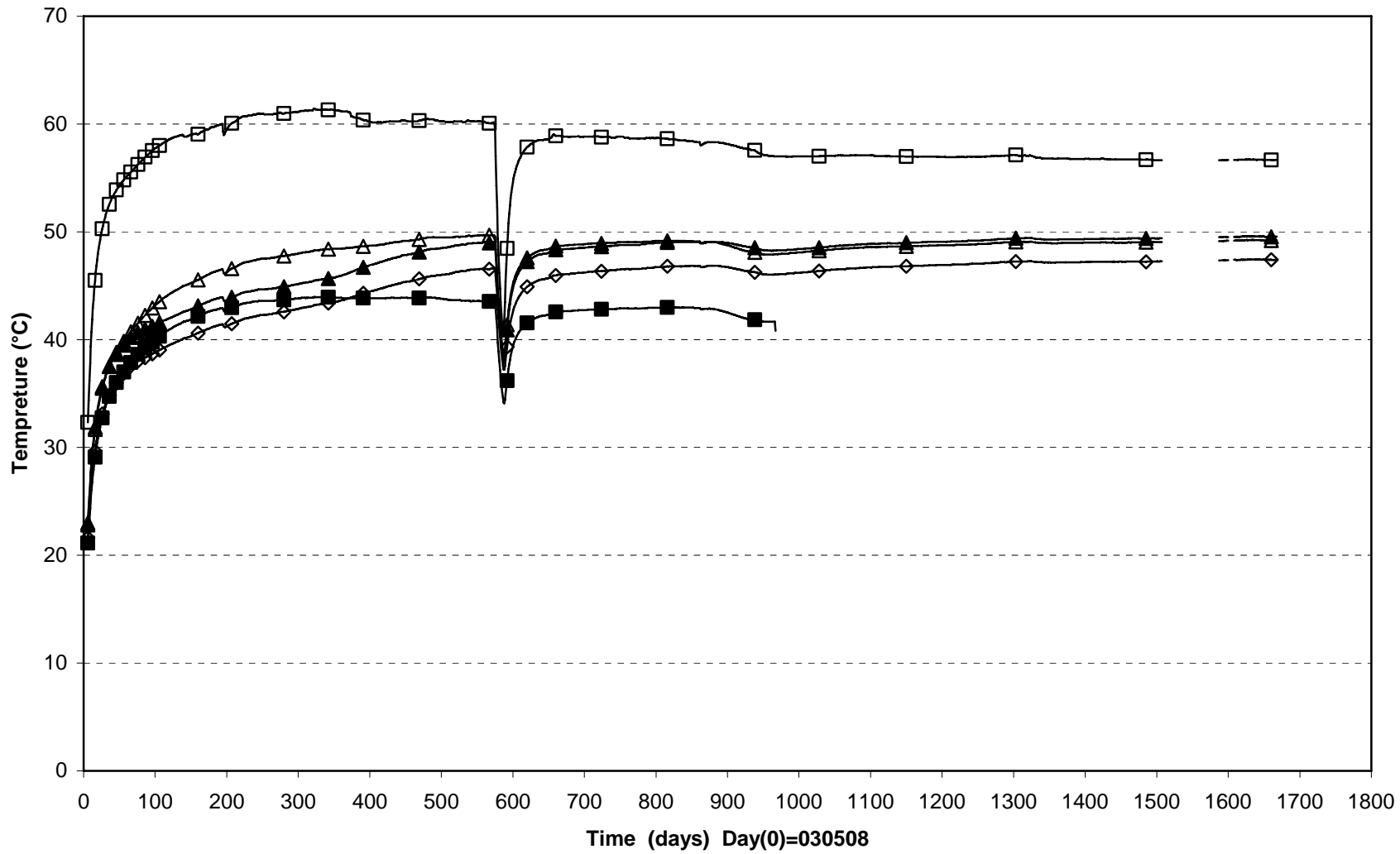

|                            |                            |                            |
|----------------------------|----------------------------|----------------------------|
| □ PB517T(5.593\0°\0.050)   | ▲ PB521T(5.593\95°\0.635)  | ◇ PB522T(5.593\105°\0.735) |
| △ PB523T(5.593\180°\0.635) | ■ PB524T(5.593\190°\0.735) |                            |

Prototype\Hole 5\Cyl.3 and Cyl.4 (030508-071201)  
 Temperature - Geokon

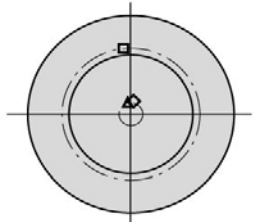
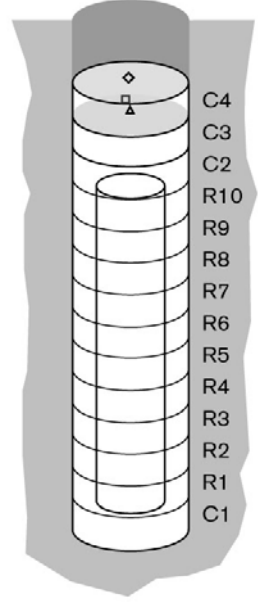
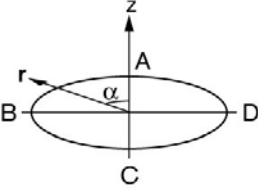
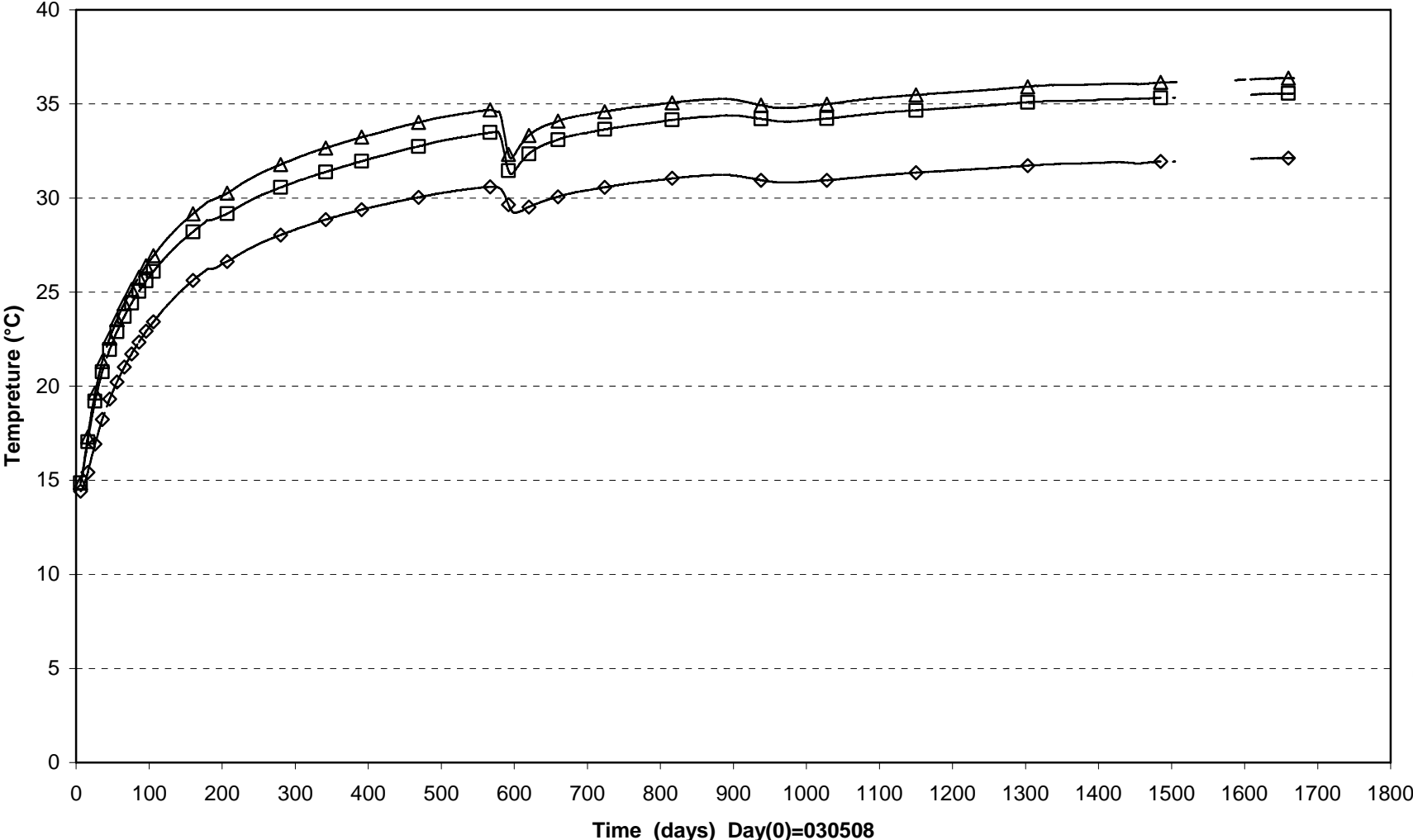

△ PB525T(6.603\0°\0.100)
□ PB526T(6.603\5°\0.585)
◇ PB527T(7.110\0°\0.100)



Prototype\Hole5 (030508-071201)  
 Temperature - Geokon

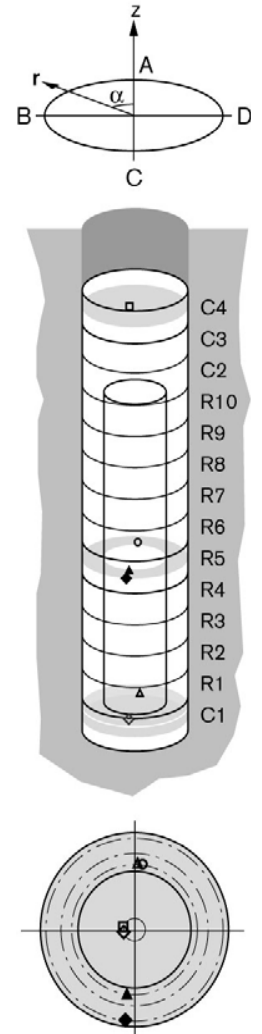
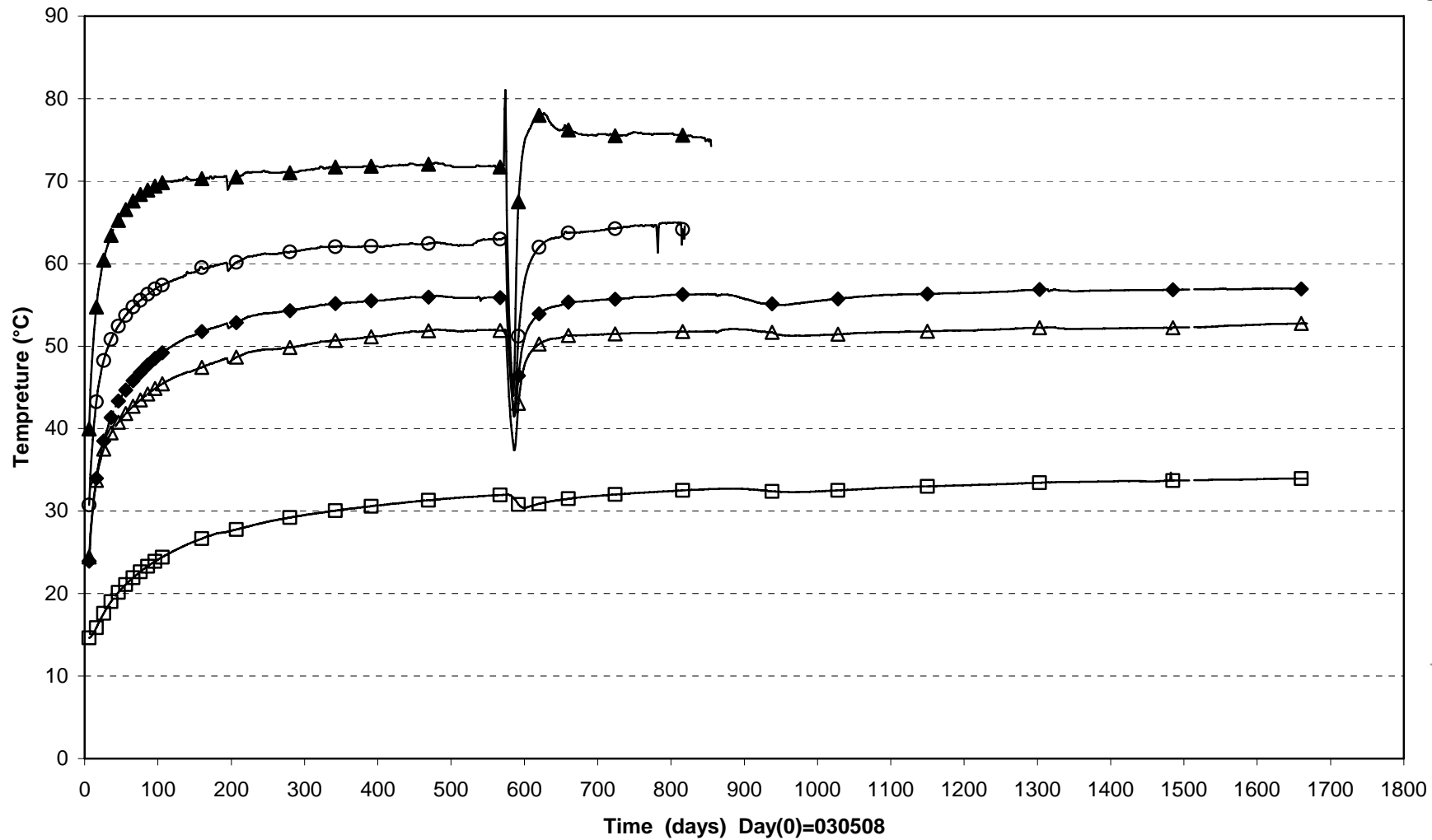

|                            |                            |                            |
|----------------------------|----------------------------|----------------------------|
| ◇ UB502T(0.050\90°\0.100)  | △ UB503T(0.250\355°\0.585) | ○ UB505T(2.786\355°\0.585) |
| ▲ UB509T(2.786\175°\0.535) | ◆ UB510T(2.786\175°\0.825) | □ UB514T(6.860\90°\0.100)  |

Prototype\ Hole 5 \ Ring 3 (030508-071201)  
 Temperature - Wescor

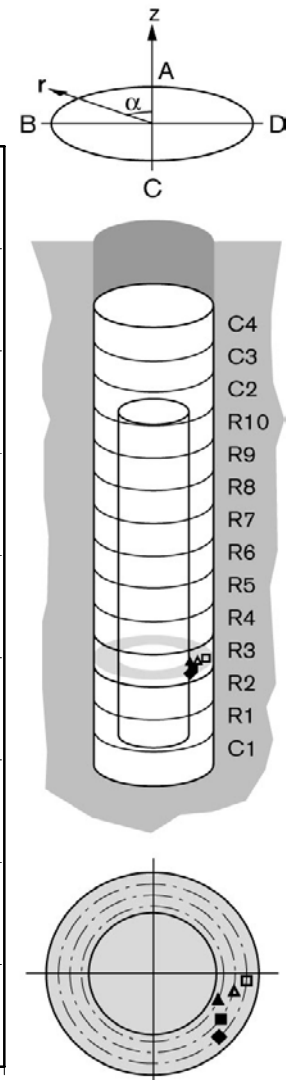
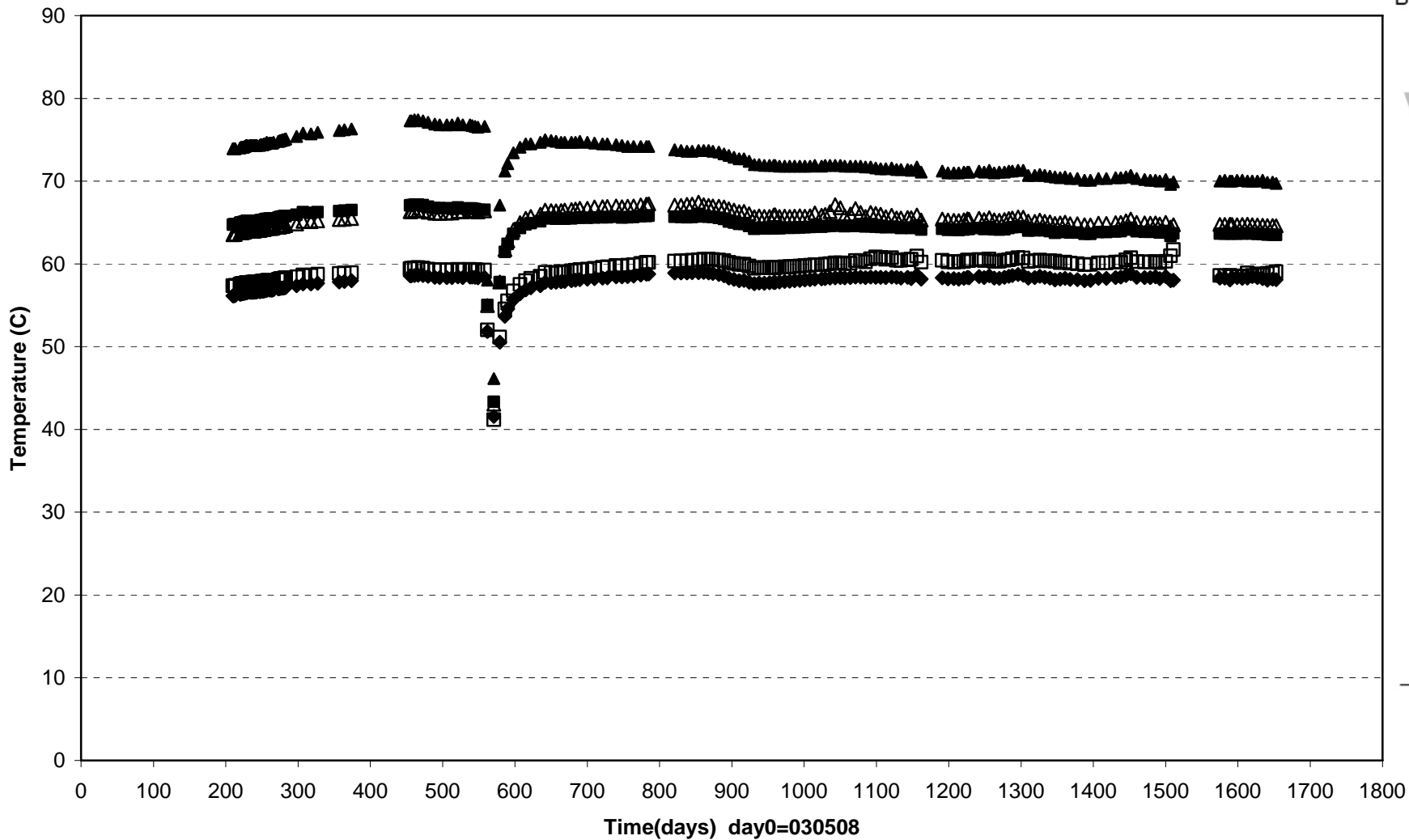

◆ WB538T(1.624\225°\0.775) ■ WB539T(1.624\235°\0.680) ▲ WB540T(1.624\245°\0.585) △ WB541T(1.624\255°\0.680) □ WB542T(1.624\265°\0.775)

Prototype\ Hole 5 \ Ring 8 (030508-071201)  
Suction - Wescor

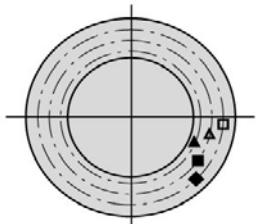
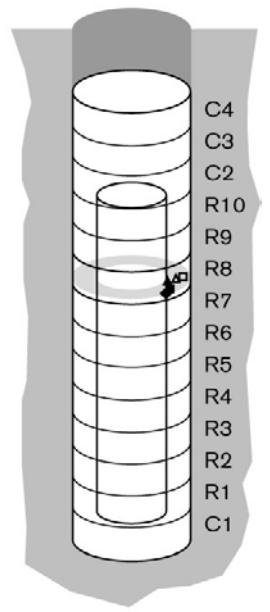
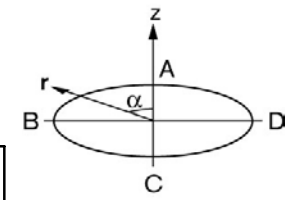
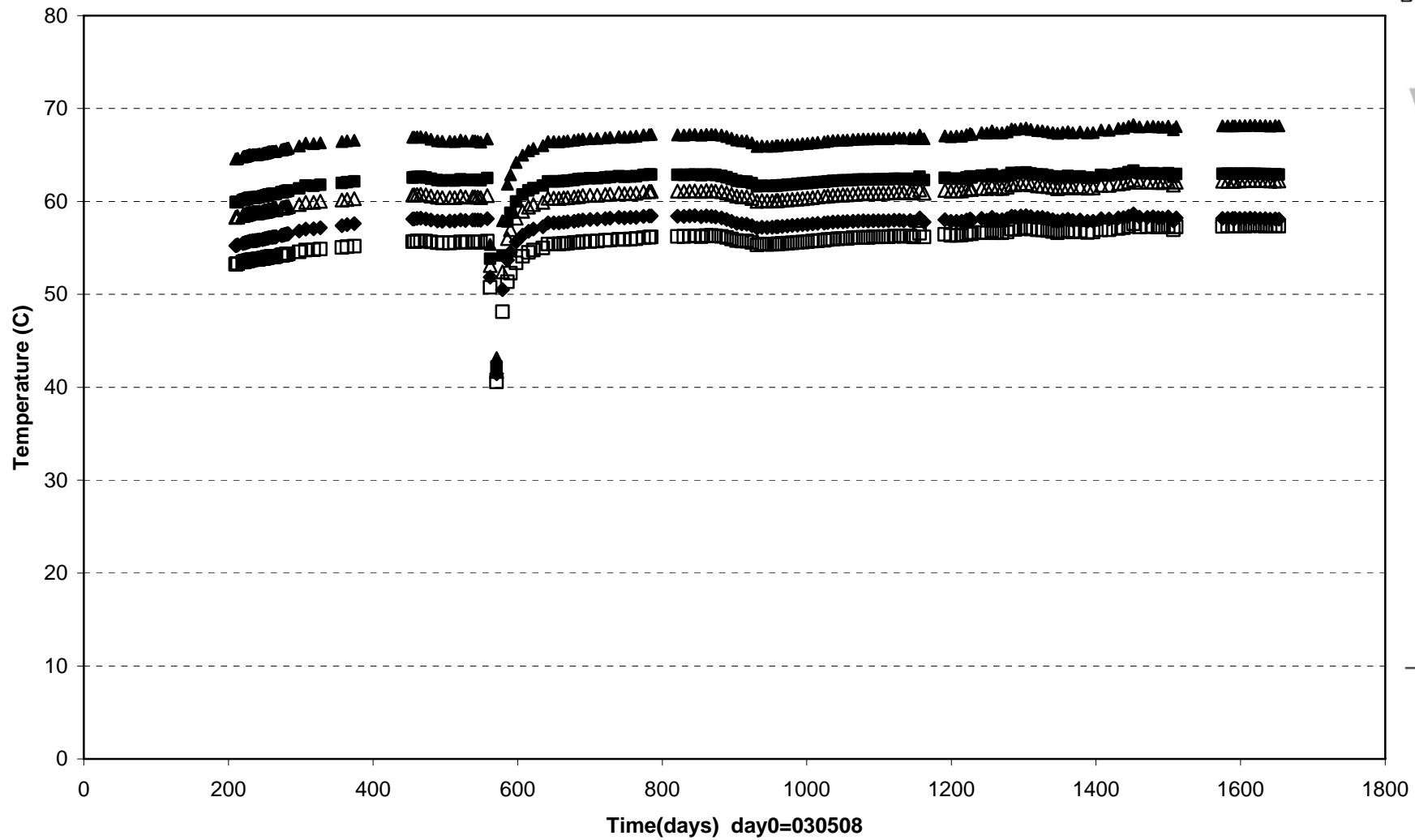

◆ WB543T(4.173\225°\0.775) ■ WB544T(4.173\235°\0.680) ▲ WB545T(4.173\245°\0.585) △ WB546T(4.173\255°\0.680) □ WB547T(4.173\265°\0.775)

Prototype\Rock\Hole 5\ Bottom (030508-071201)  
 Temperature - Pentronic

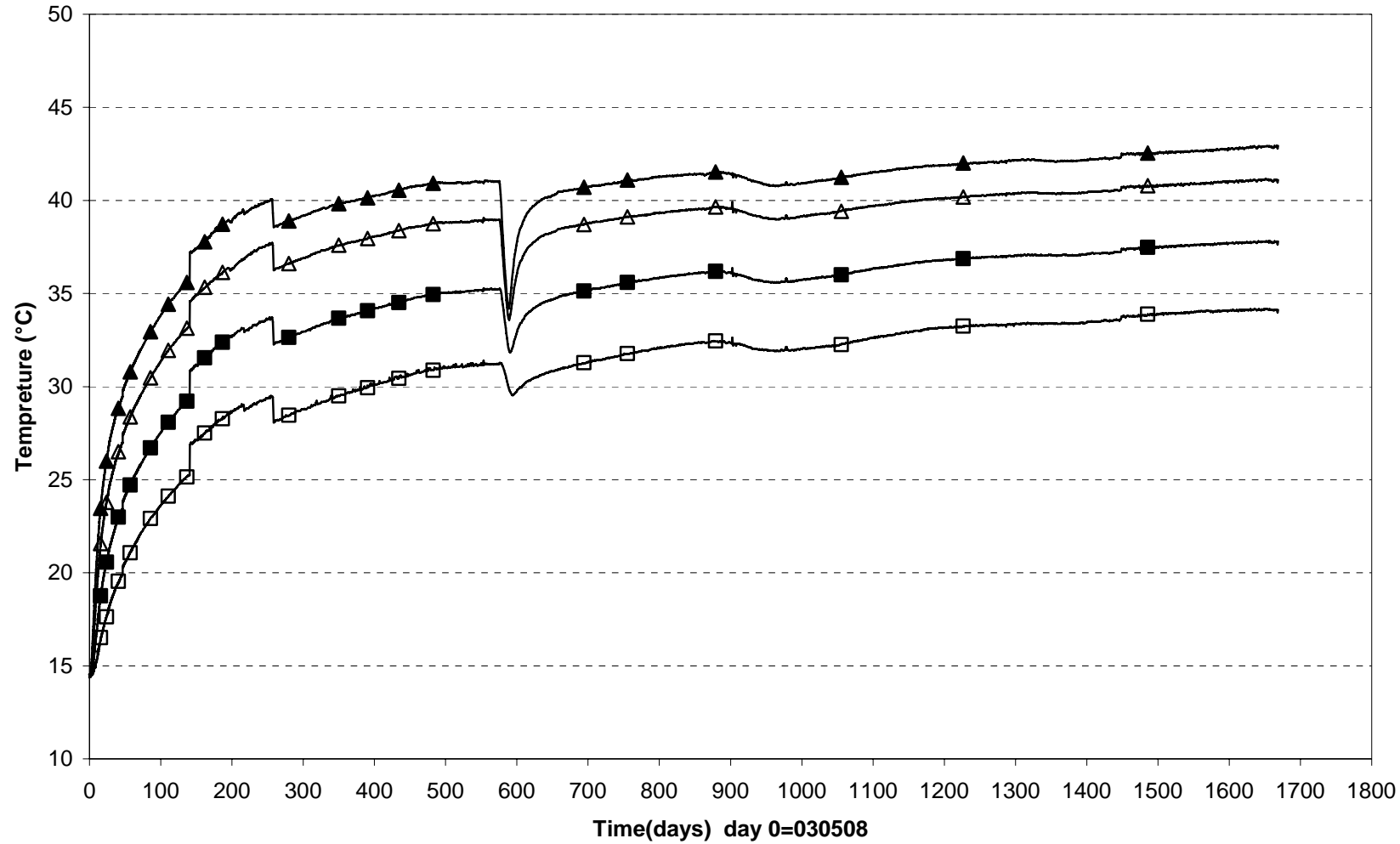

□ TR5011(-1,0\0°\0,0\Bottom) ■ TR5012(-0,5\0°\0,0\Bottom) △ TR5013(-0,2\0°\0,0\Bottom) ▲ TR5014(0,0\0°\0,0\Bottom)

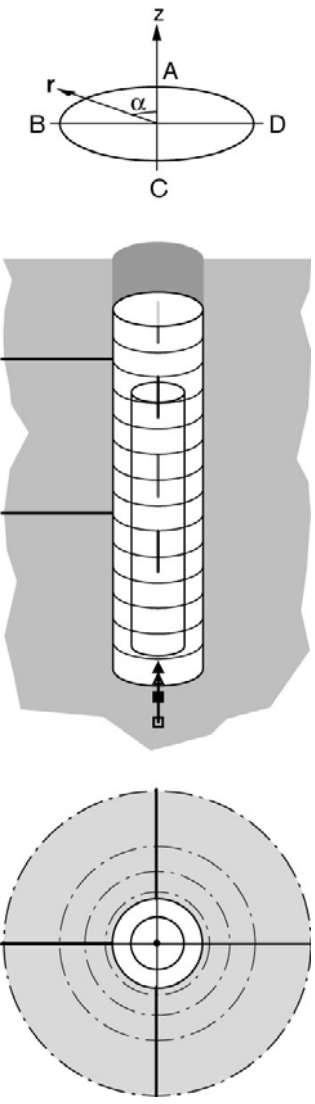

Prototype\Rock\Hole 5 \Level 3,0 m (030508-071201)  
 Temperature - Pentronic

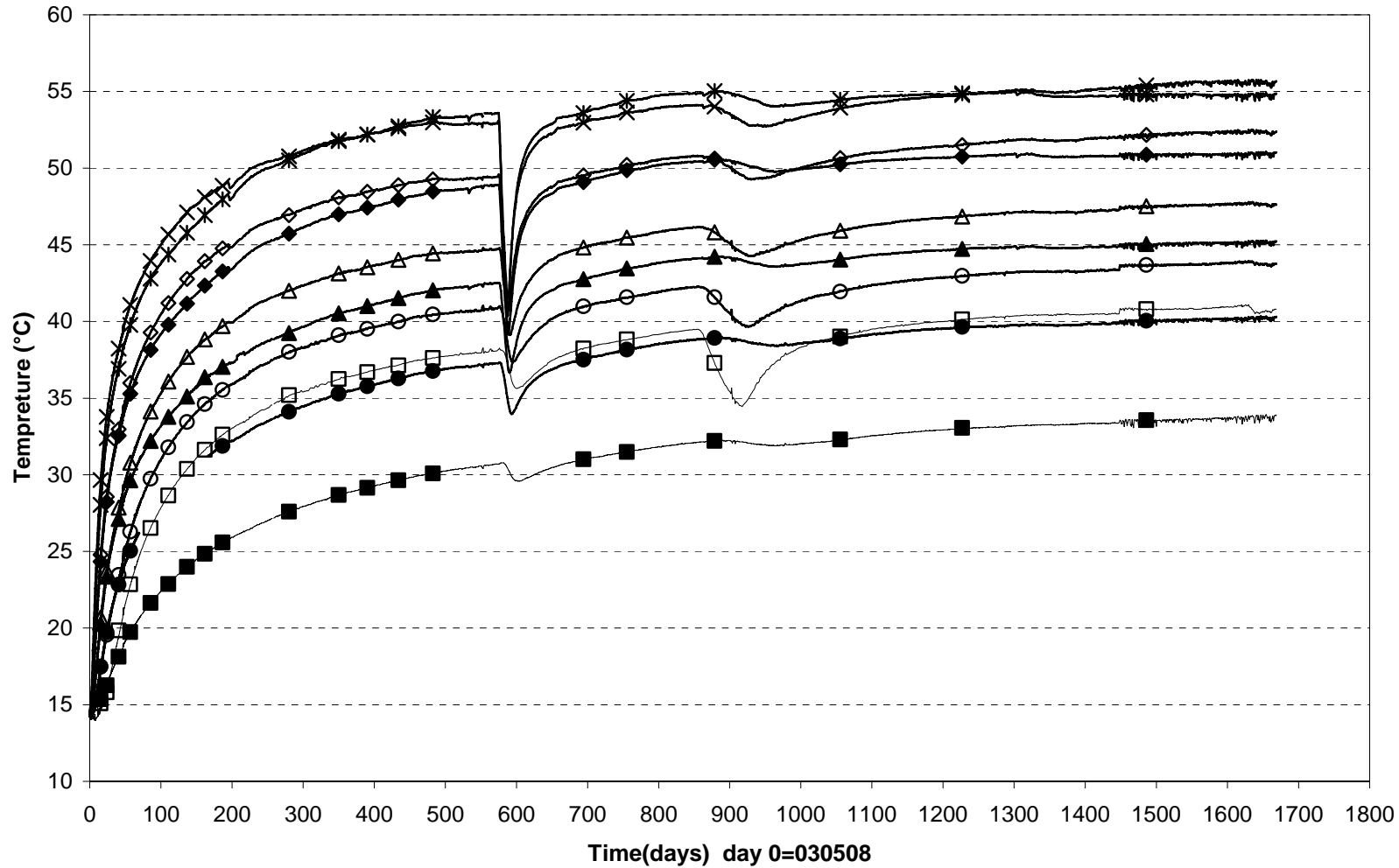

- TR5041 (3,0\170°\3,075)    ○ TR5042 (3,0\170°\1,975)    △ TR5043 (3,0\170°\1,475)    ◇ TR5044 (3,0\170°\1,075)    × TR5045 (3,0\170°\0,875)
- TR5051 (3,0\80°\3,075)    ● TR5052 (3,0\80°\1,975)    ▲ TR5053 (3,0\80°\1,475)    ◆ TR5054 (3,0\80°\1,075)    ✱ TR5055 (3,0\80°\0,875)

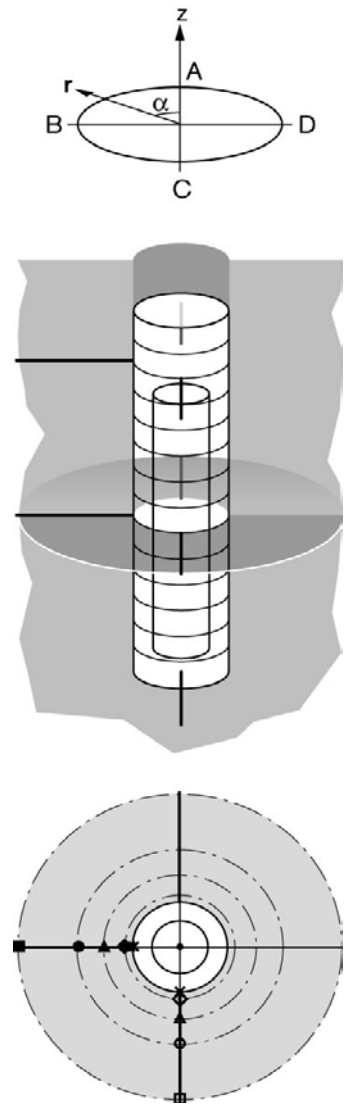

Prototype\Rock\Hole 5 \Level 6,0 m (030508-071201)  
 Temperature - Pentronic

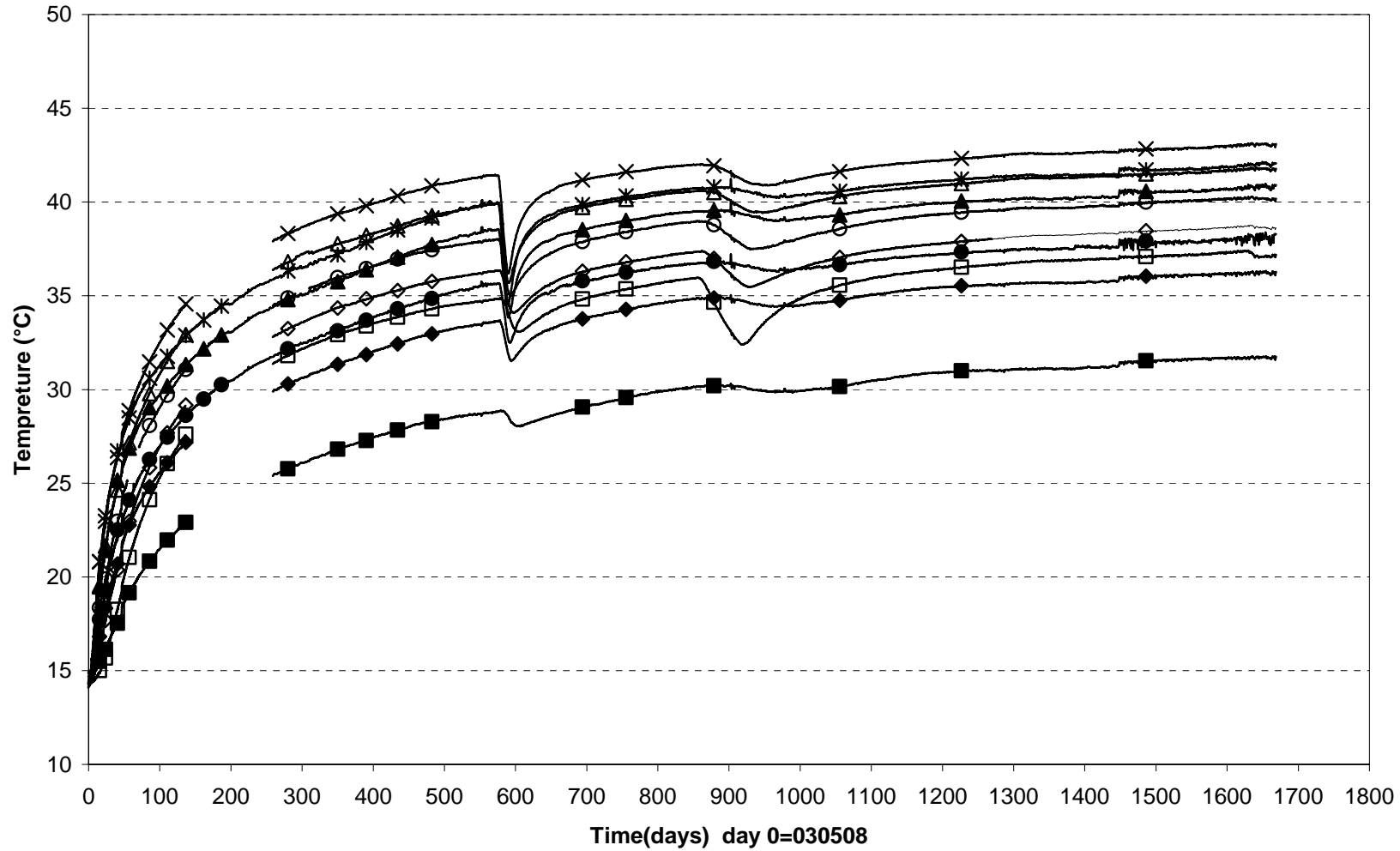

- TR5021 (6,0\171°\3,075)    ◇ TR5022 (6,0\171°\1,975)    ○ TR5023 (6,0\171°\1,475)    △ TR5024 (6,0\171°\1,075)    × TR5025 (6,0\171°\0,875)
- TR5031 (6,0\80°\3,075)    ◆ TR5032 (6,0\80°\1,975)    ● TR5033 (6,0\80°\1,475)    ▲ TR5034 (6,0\80°\1,075)    ✖ TR5035 (6,0\80°\0,875)

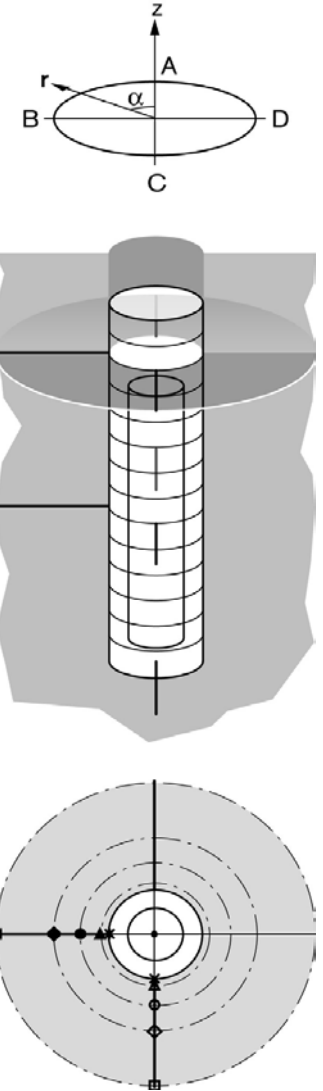

Prototype\Hole 5 (030508-071201)  
Canister power

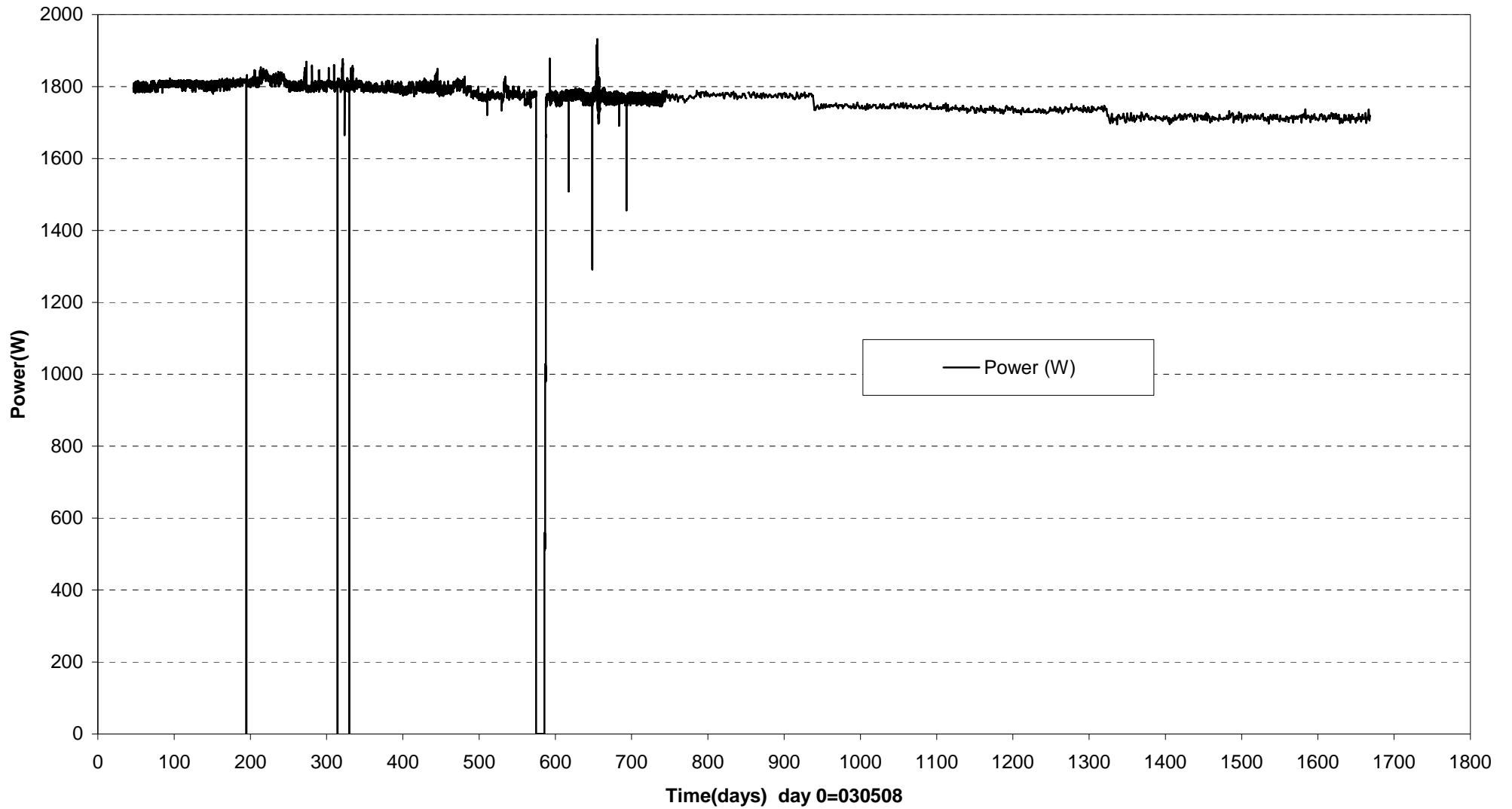

Prototype\ Hole 5 \Canister (030508-070601)  
 Max. temperature on the canister surface - Optical fiber cables

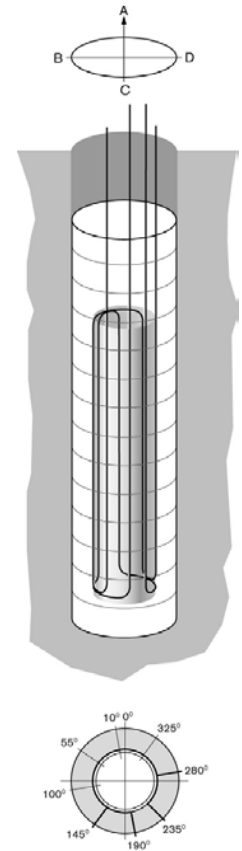
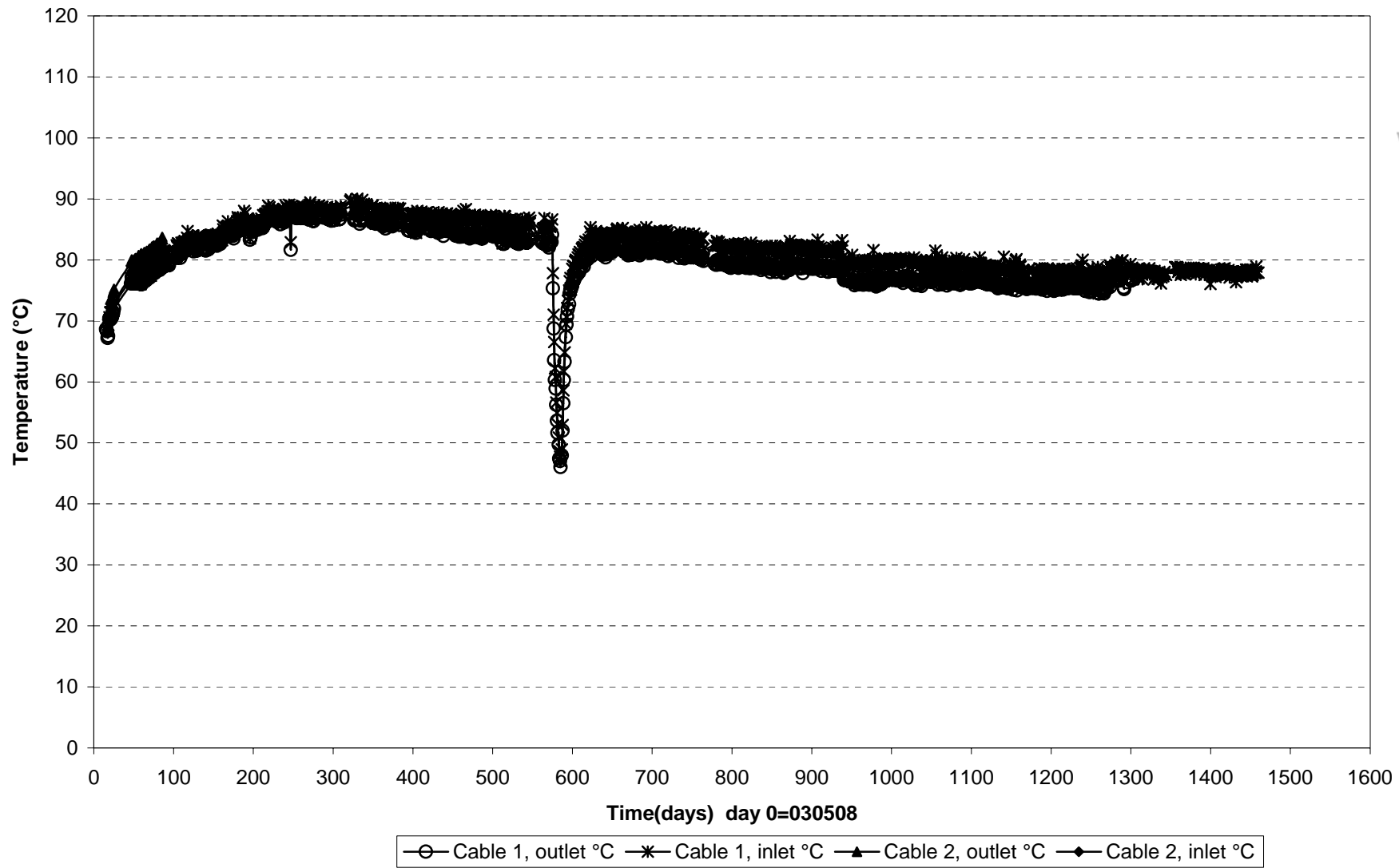



**Temperature profile on the canister surface-No5 (061201)**  
**Optical fiber cables**

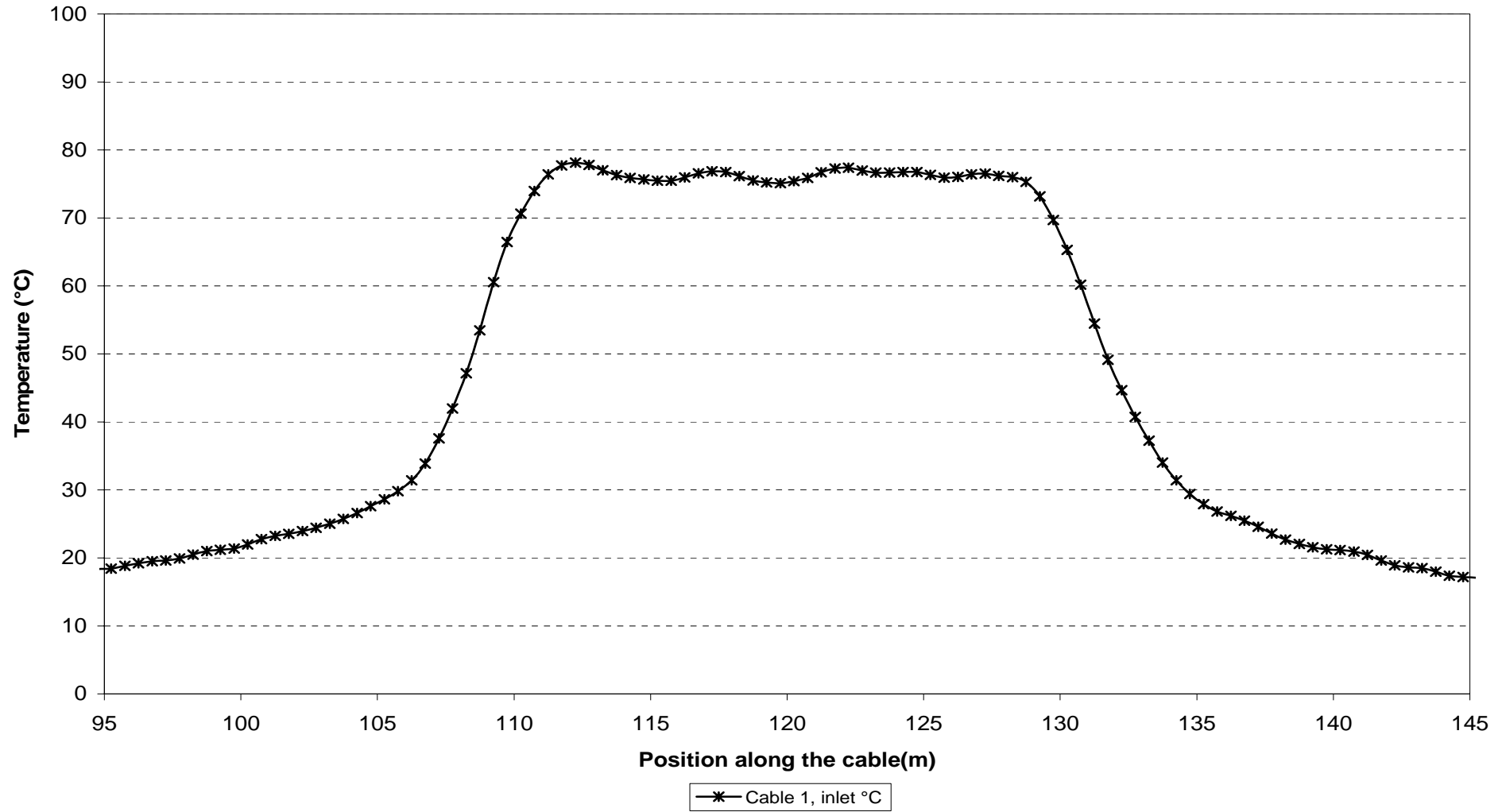

Prototype\Hole 5 \On the canister surface (030508-071201)  
 Temperature - Pentronic

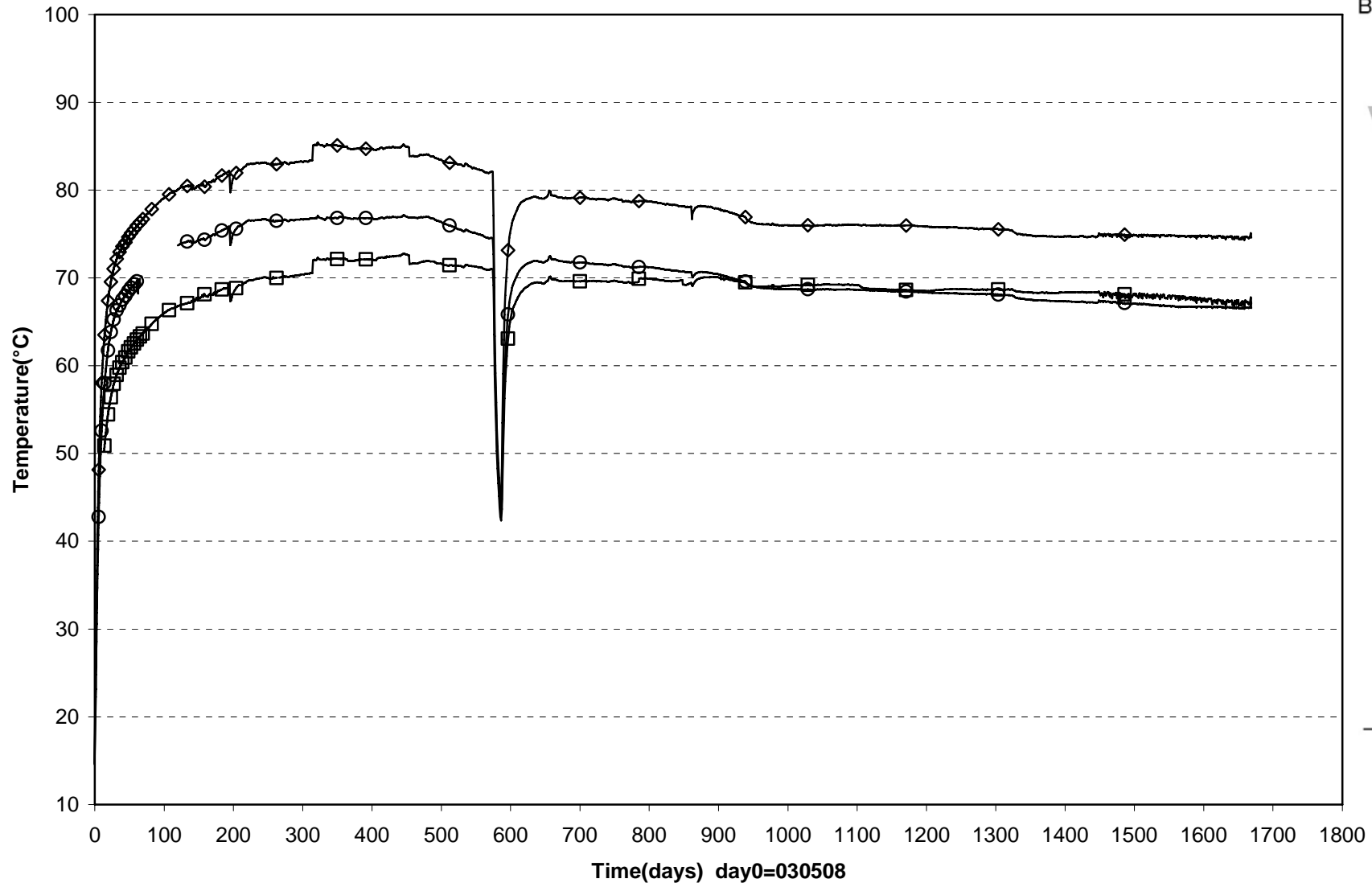

□ TB504(0.450\355°\0.525) ◇ TB511(2.950\0°\0.525) ○ TB524(5.150\ 0°\0.525)

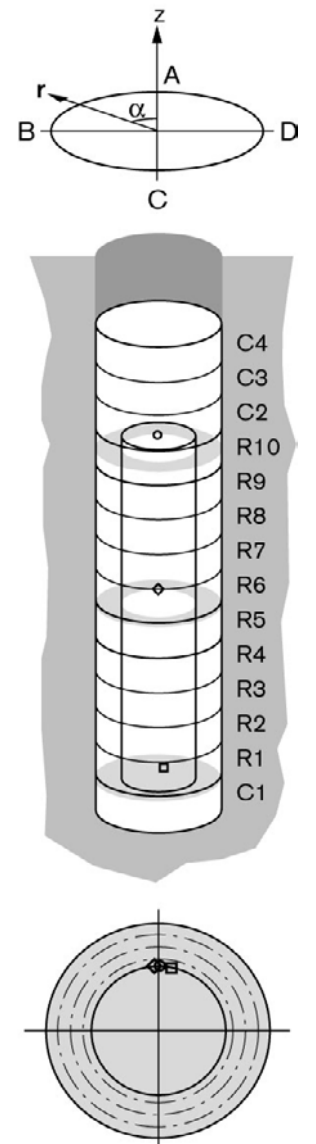

## **Appendix 6**

**Dep. hole 6**



Prototype\Hole 6\Cyl.1 , Cyl.2 and Cyl.3 (030508-071201)  
Total pressure

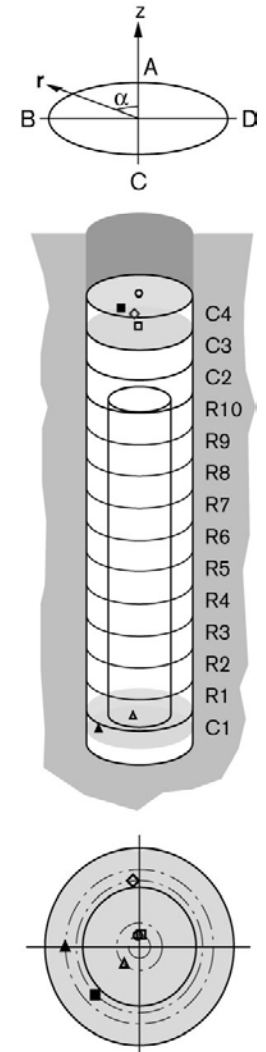
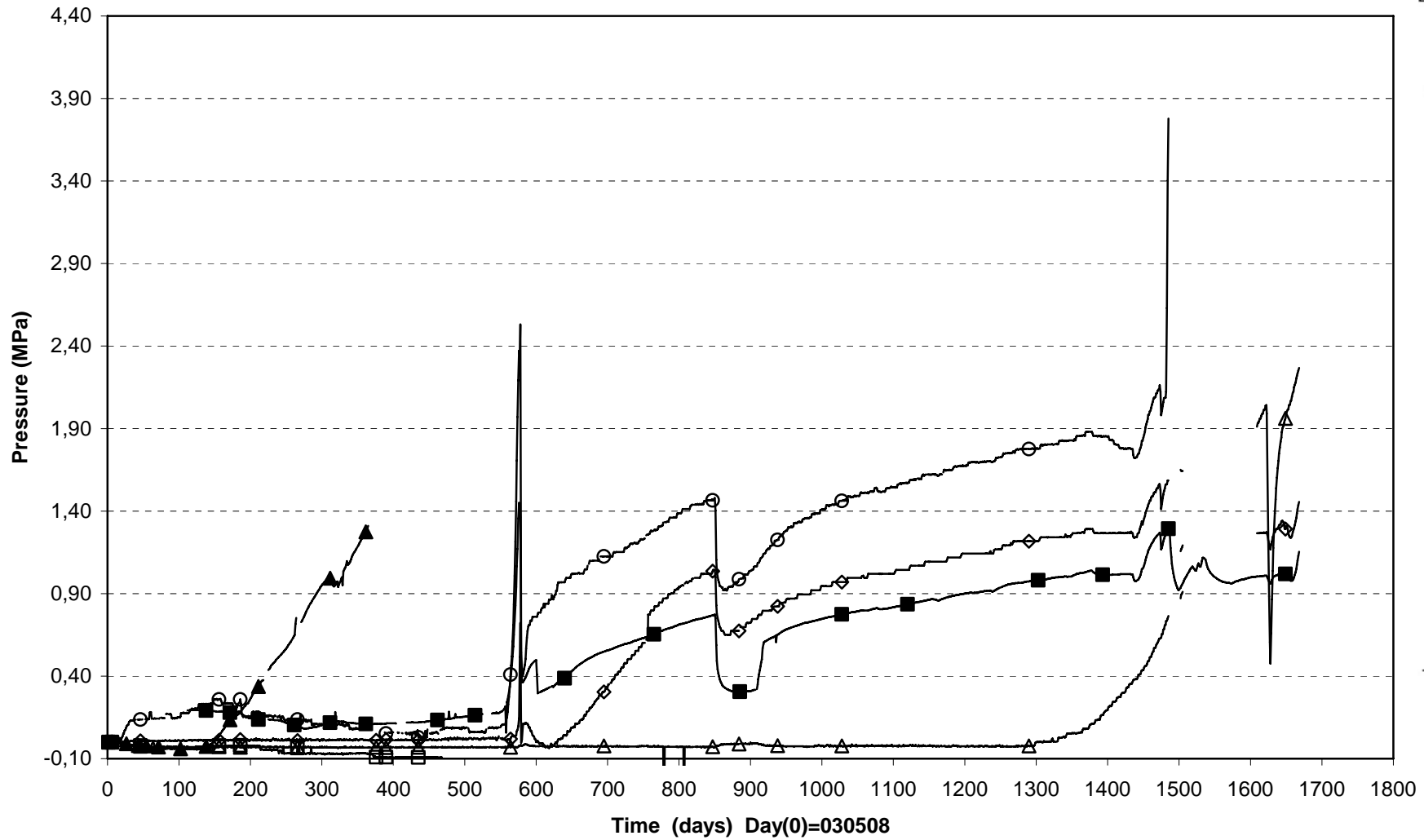

|                                  |   |  |
|----------------------------------|---|--|
| $\Delta$ PB601(0.510\315^\0.210) | $\blacktriangle$ PB602(0.260 \80^\ 0.685) | $\blacksquare$ PB624(7.121 \135^\ 0.585) |
| $\square$ PB625(6.616\0^\0.100)  | $\diamond$ PB626(6.616\5^\0.585)          | $\circ$ PB627(7.121\0^\0.100)            |

PrototypeHole 6\ Ring1 and Ring 2 (030508-071201)  
 Total pressure

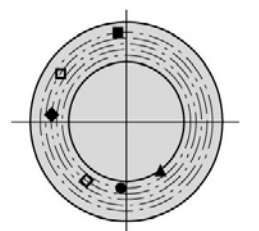
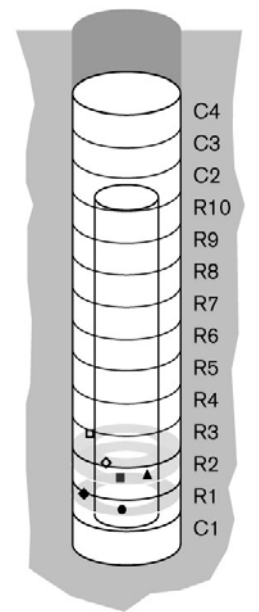
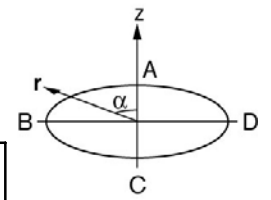
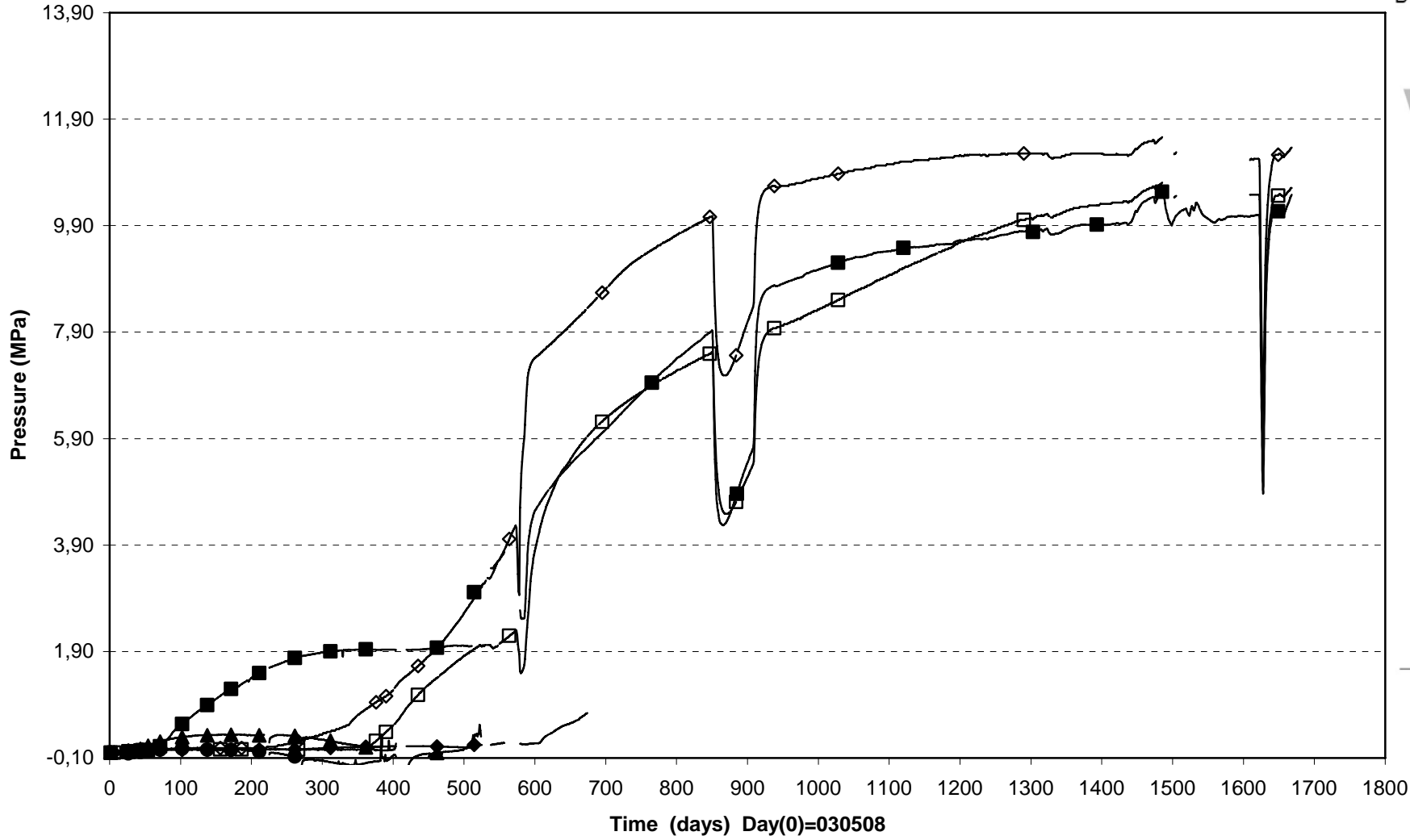

- PB603(0.770 \10° 0.785)
- ◆ PB604(0.770 \80° 0.685)
- PB605(0.770 \170° 0.585)
- PB606(1.534\55° 0.735)
- ◇ PB607(1.534\145° 0.635)
- ▲ PB608(1.284 \215° 0.535)

Prototype\Hole 6\ Ring 5 and Ring 6 (030508-071201)  
Total pressure

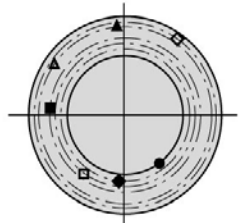
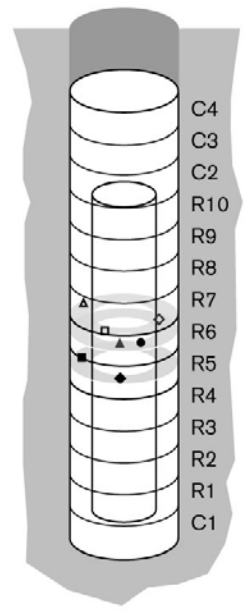
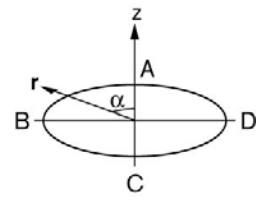
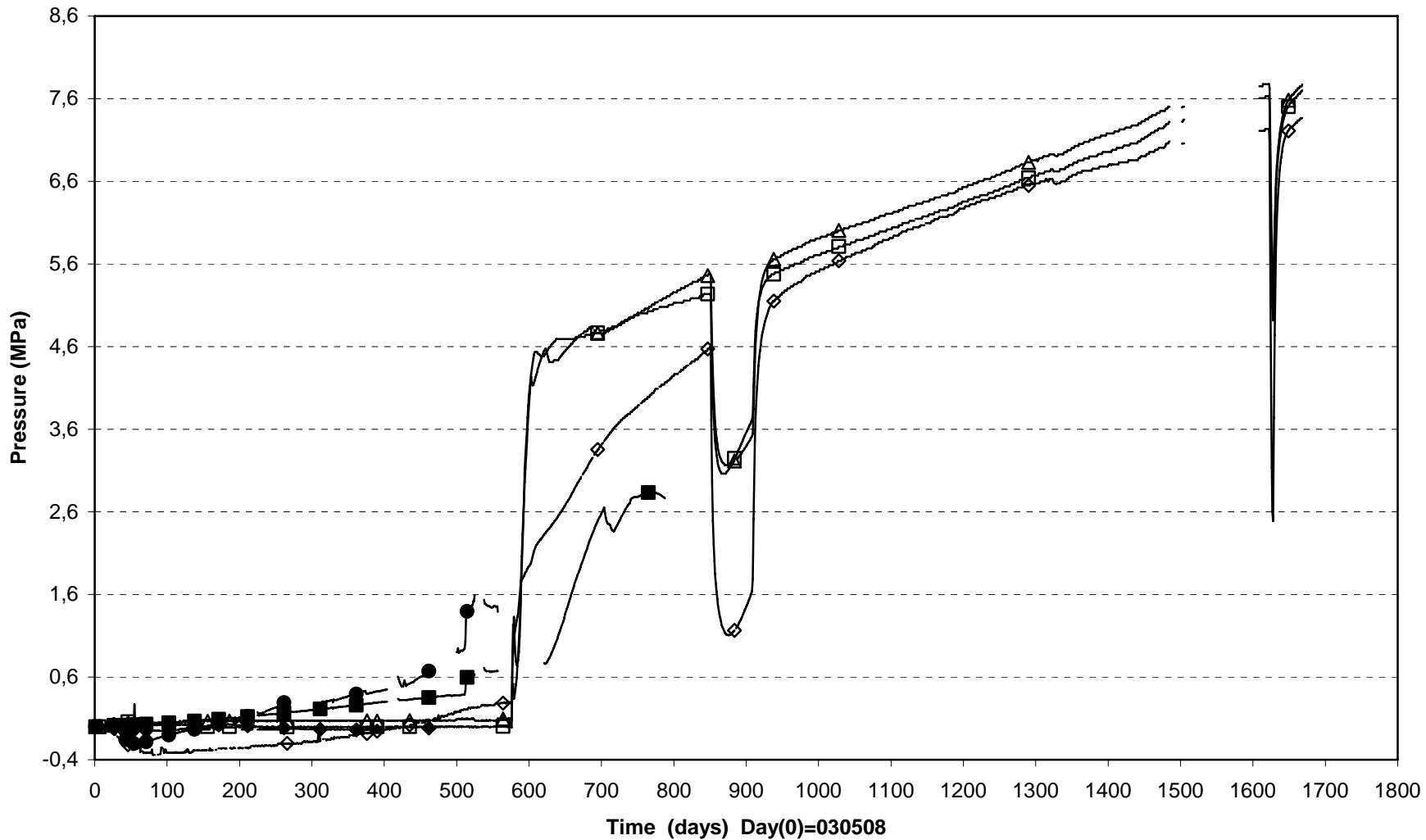

|                            |                            |                             |
|----------------------------|----------------------------|-----------------------------|
| ▲ PB610(2.795 \10°\ 0.785) | ■ PB611(2.795 \80°\ 0.685) | ◆ PB612(2.795 \170°\ 0.585) |
| △ PB613(3.550\55°\0.785)   | □ PB614(3.550\145°\0.635)  | ● PB615(3.300 \215°\ 0.535) |
| ◇ PB616(3.253\325°\0.875)  |                            |                             |

Prototype\Hole 6\ Ring 8 and Ring 9 (030508-071201)  
Total pressure

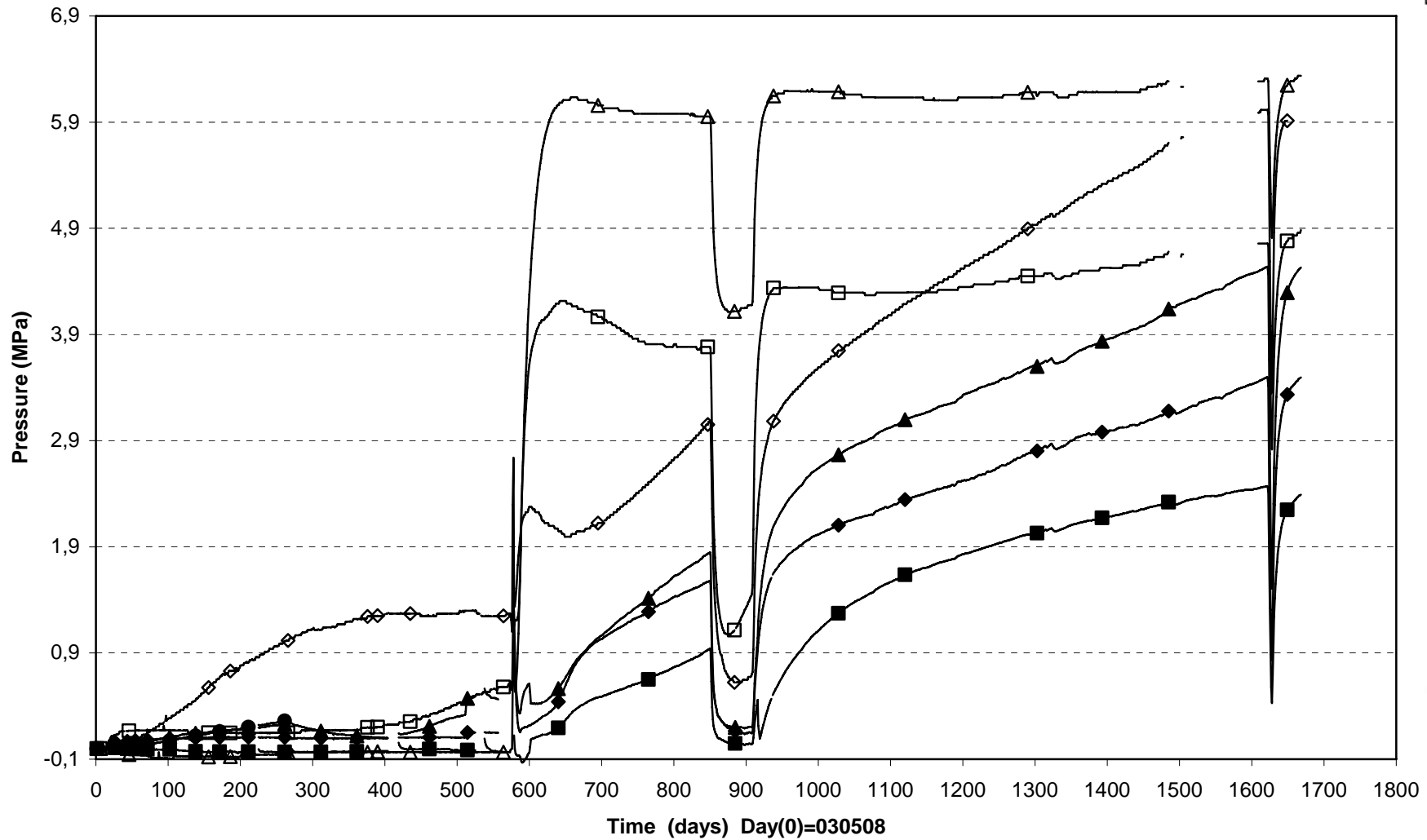

|                            |                            |                             |
|----------------------------|----------------------------|-----------------------------|
| ▲ PB617(4.324 \10°\ 0.785) | ■ PB618(4.324 \80°\ 0.685) | ◆ PB619(4.324 \170°\ 0.585) |
| △ PB620(5.084\55°\0.735)   | □ PB621(5.084\145°\0.635)  | ● PB622(4.834 \215°\ 0.535) |
| ◇ PB623(4.753\325°\0.875)  |                            |                             |

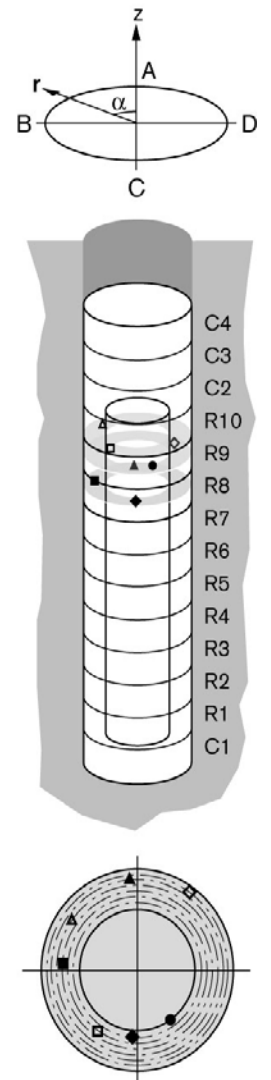



Prototype\Hole 6\Cyl.1 (030508-071201)  
Relative humidity

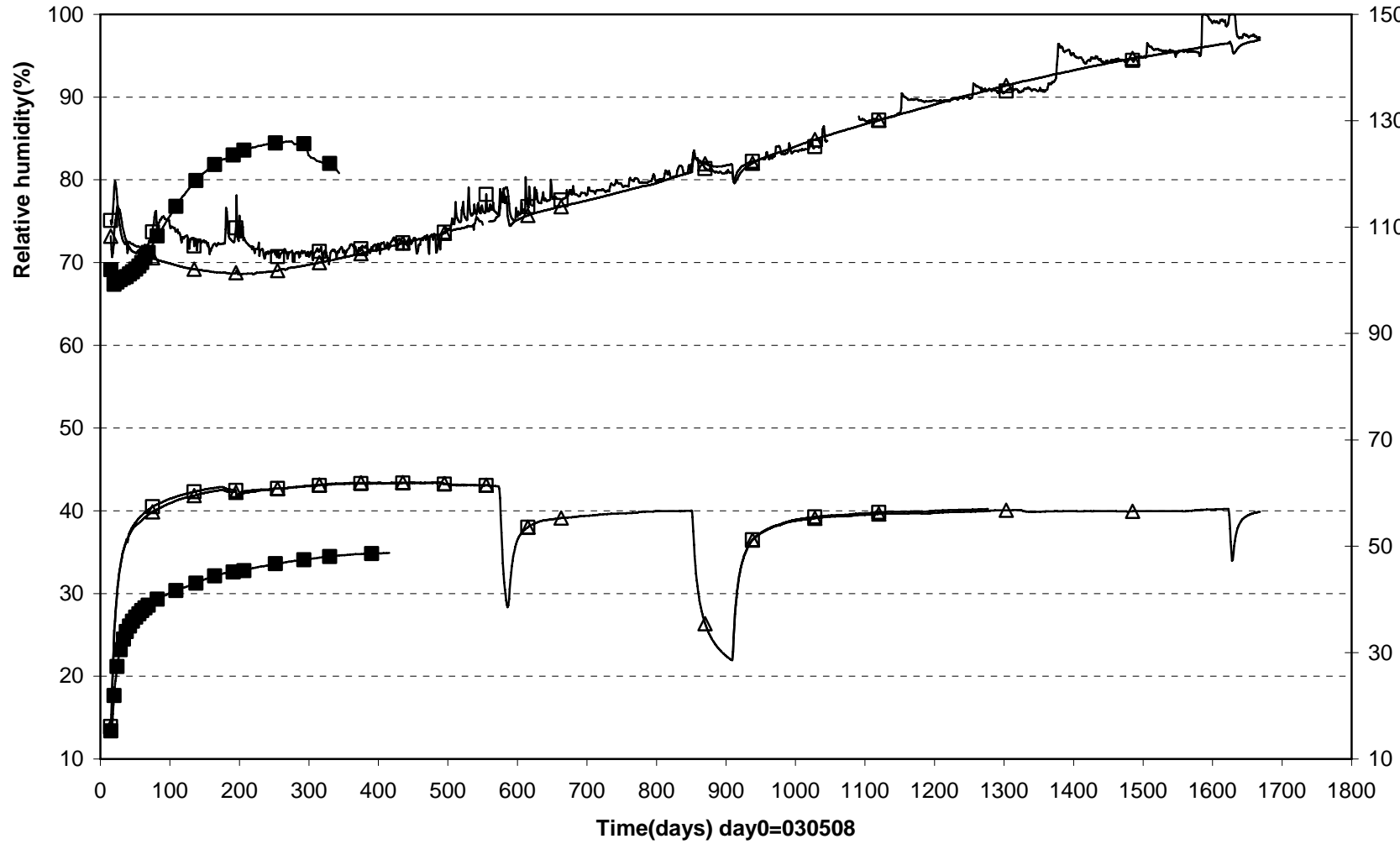

■ WB667(0.260\280°\0.685) □WB601 (0.260\135°\0.050) △WB604 (0.260\270°\0.210)

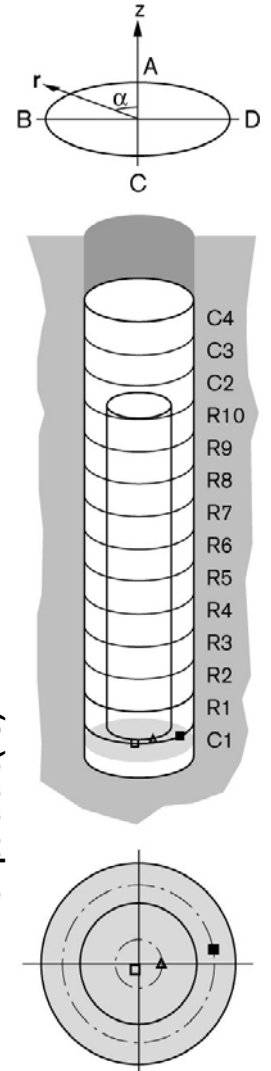

Prototype\Hole 6\ Ring 1 and Ring 2 (030508-071201)  
Relative humidity

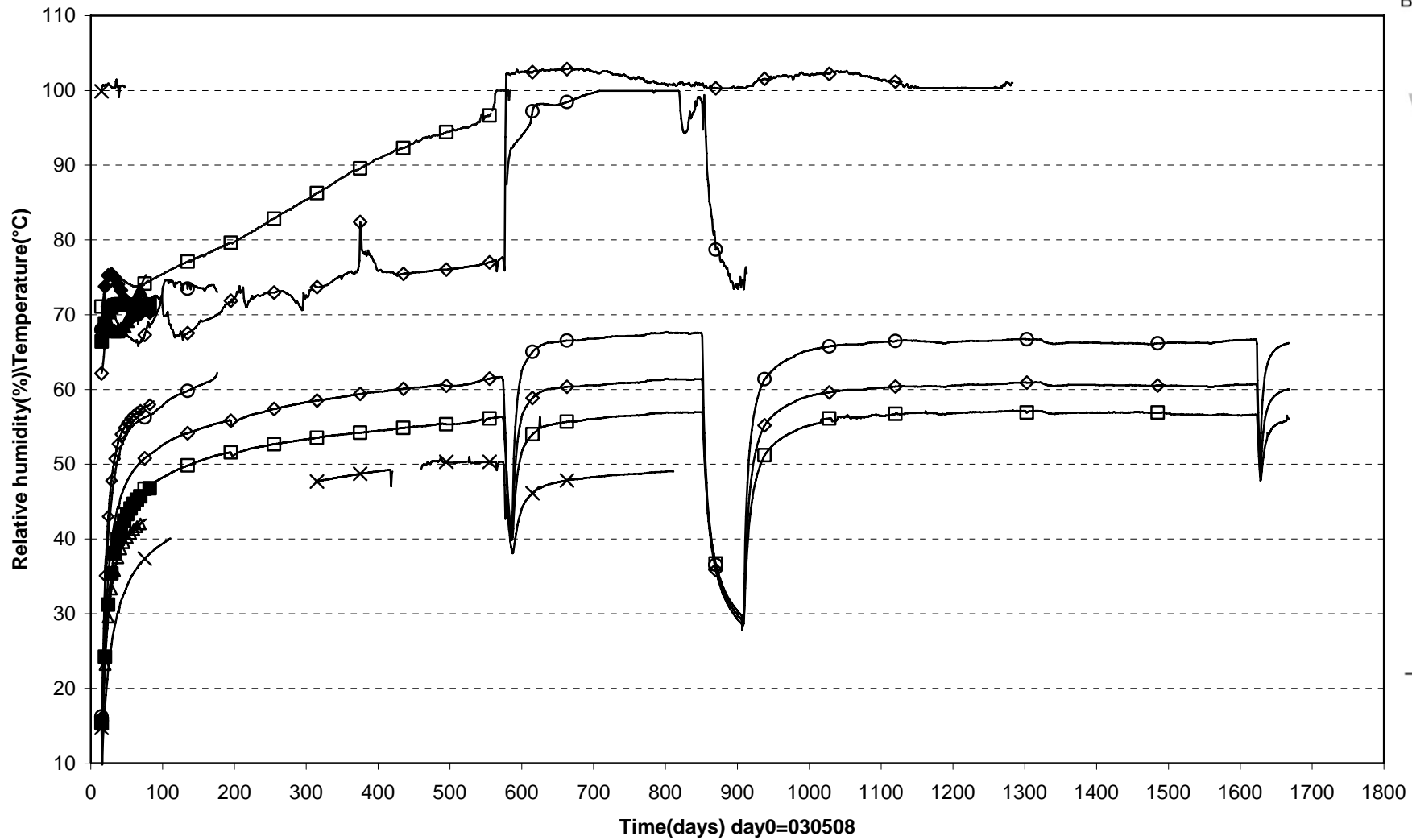

|                           |                           |                           |                          |
|---------------------------|---------------------------|---------------------------|--------------------------|
| ■ WB607(0.770\90°\0.685)  | ◆ WB609(0.770\180°\0.585) | ▲ WB612(0.770\360°\0.785) | □ WB613(1.284\40°\0.735) |
| ◇ WB615(1.284\130°\0.635) | ○ WB617(1.284\230°\0.535) | ×                         | ×                        |

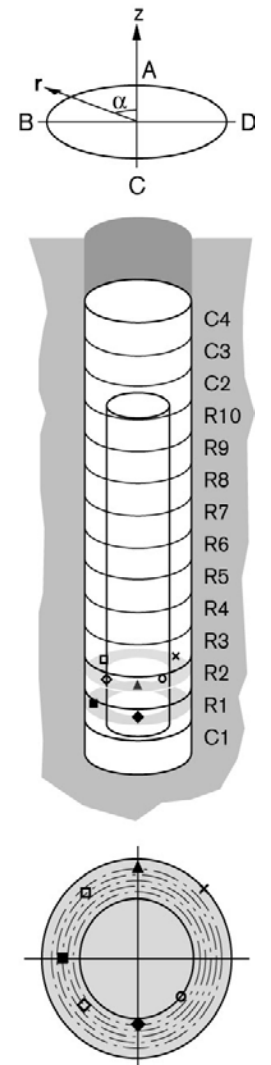

Prototype\Hole 6\Ring 5 and Ring 6 (030508-071201)  
Relative humidity

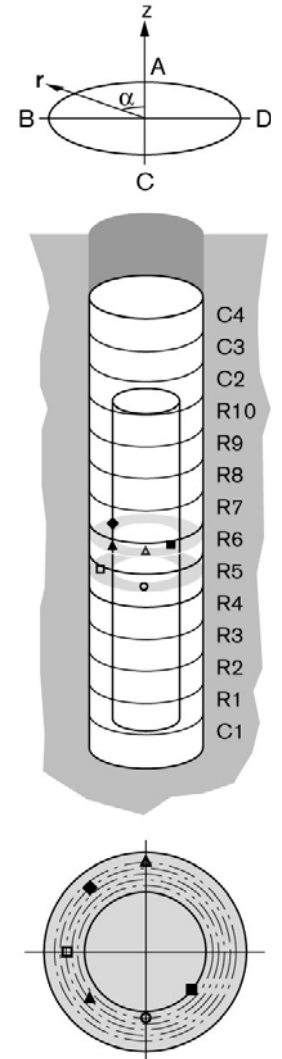
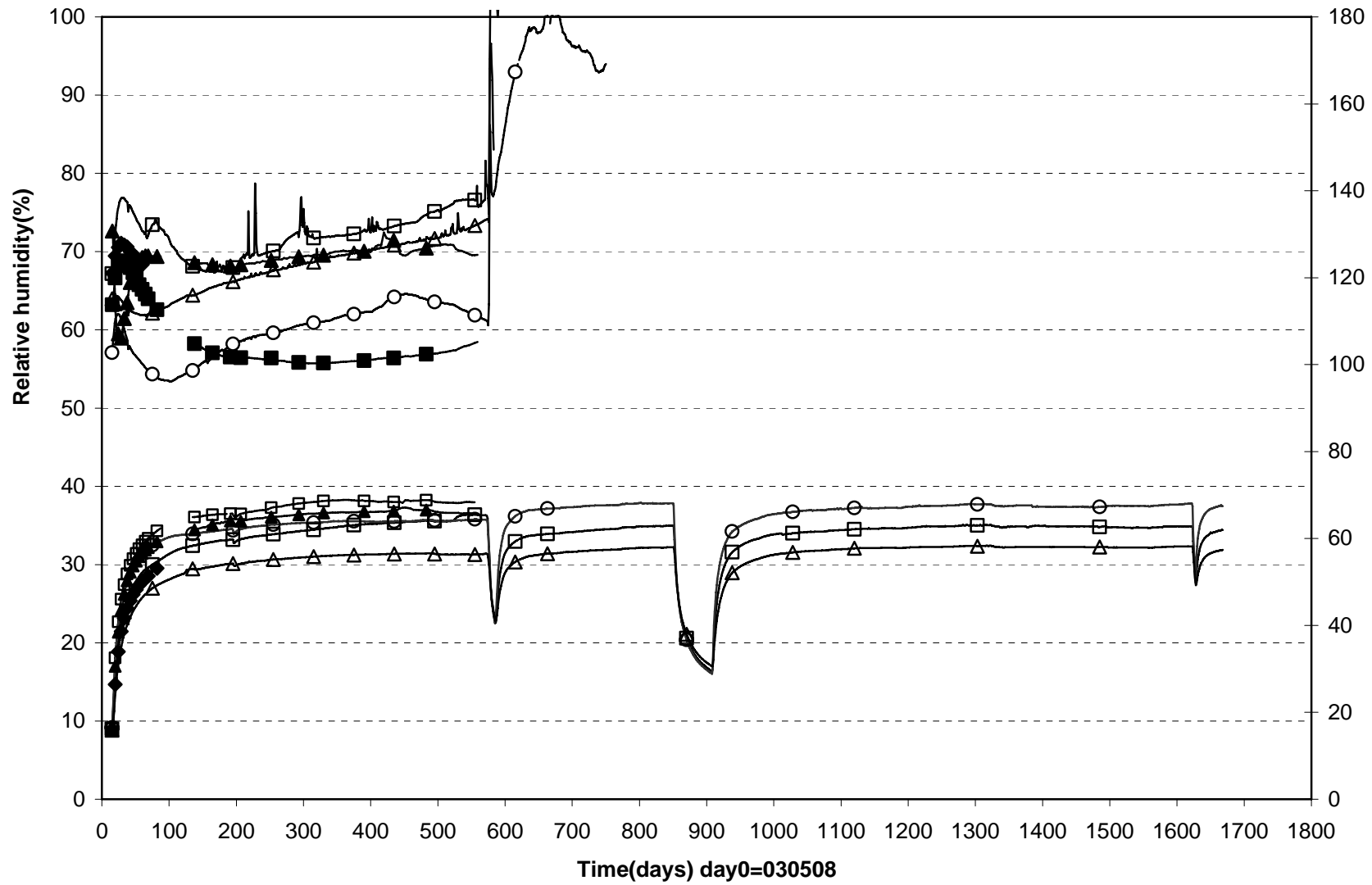

|                           |                           |                          |                          |
|---------------------------|---------------------------|--------------------------|--------------------------|
| ▲ WB629(3.300\130°\0.635) | ■ WB631(3.300\230°\0.535) | ◆ WB627(3.300\40°\0.735) | □ WB621(2.795\90°\0.685) |
| ○ WB623(2.795\180°\0.585) | △ WB626(2.795\360°\0.785) |                          |                          |

Prototype\Hole 6\ Ring 8 and Ring9 (030508-071201)  
Relative humidity

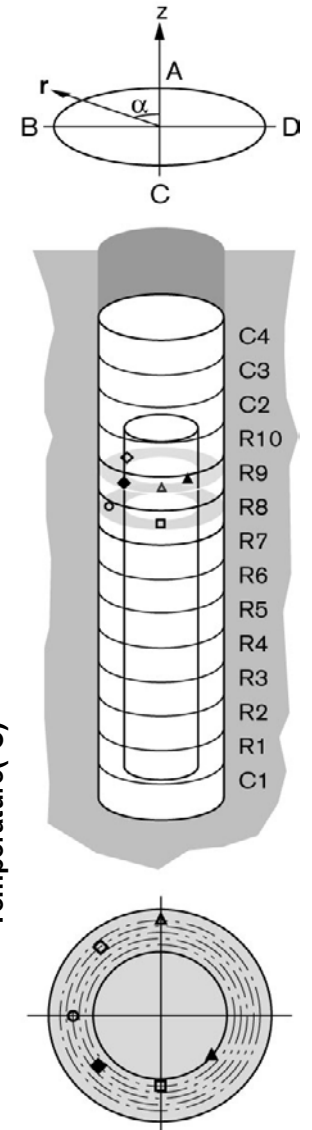
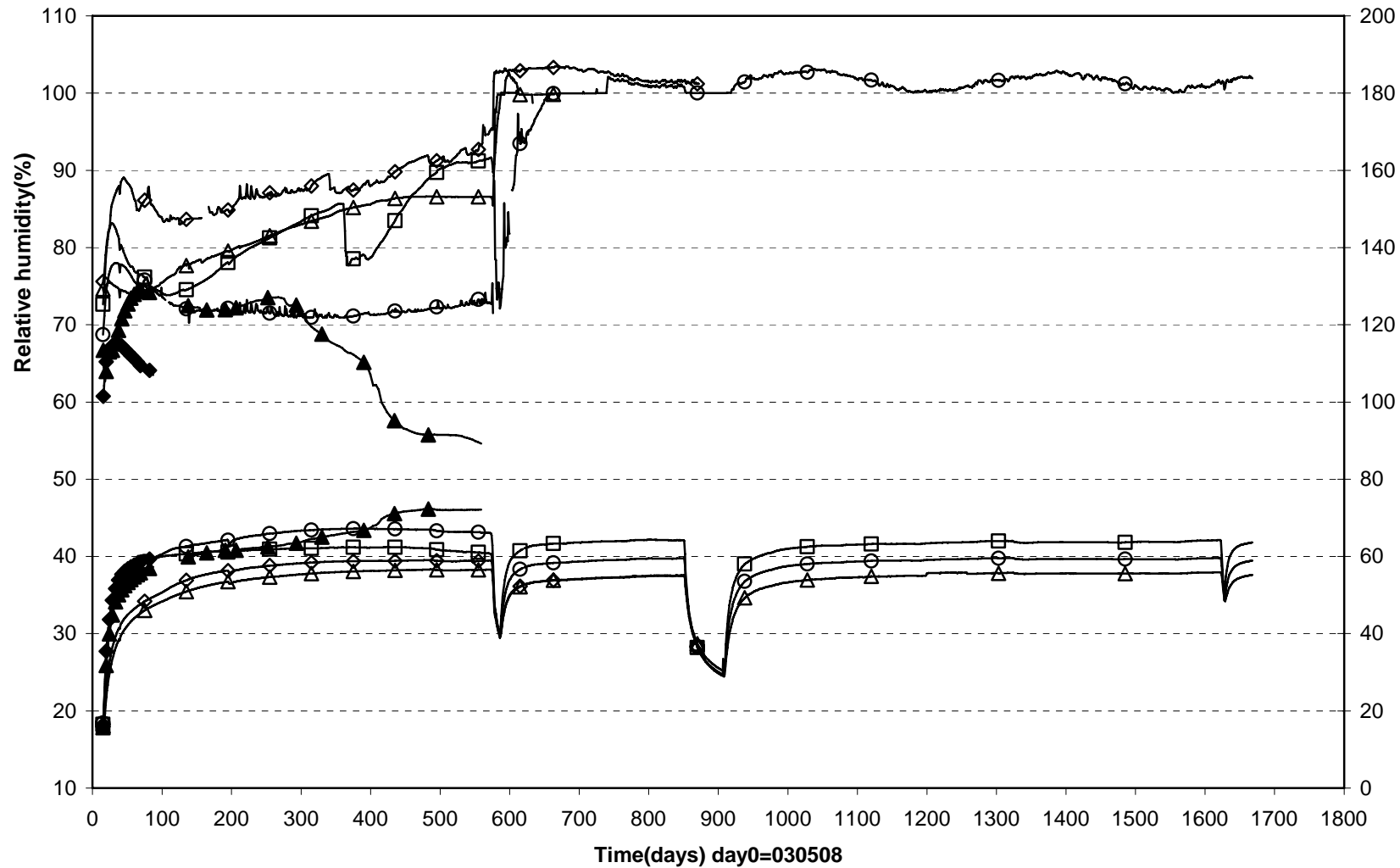

|                           |                           |                          |                           |
|---------------------------|---------------------------|--------------------------|---------------------------|
| ◆ WB643(4.834\130°\0.635) | ▲ WB645(4.834\230°\0.535) | ○ WB635(4.324\90°\0.685) | □ WB637(4.324\180°\0.585) |
| △ WB640(4.324\360°\0.785) | ◇ WB641(4.834\40°\0.735)  |                          |                           |

PrototypeHole 6\ Ring10 (030508-071201)  
Relative humidity

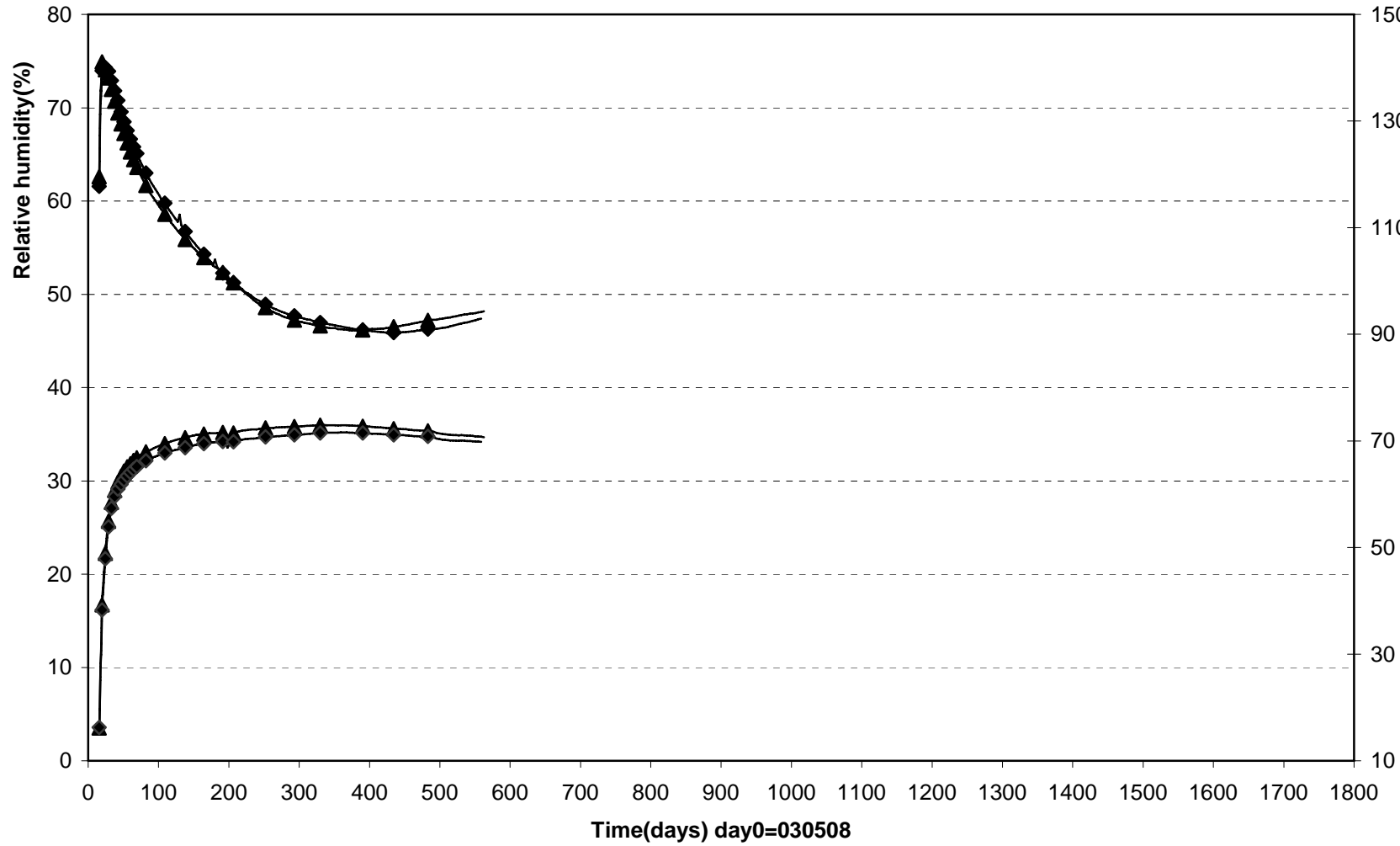

▲ WB649(5.439\90°\0.50) ◆ WB650(5.439\270°\0.210)

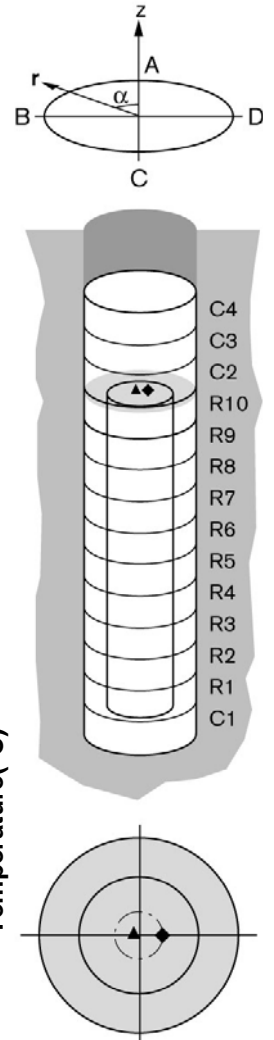

Prototype\Hole 6\Cyl.3 and Cyl.4 (030508-071201)  
Relative humidity

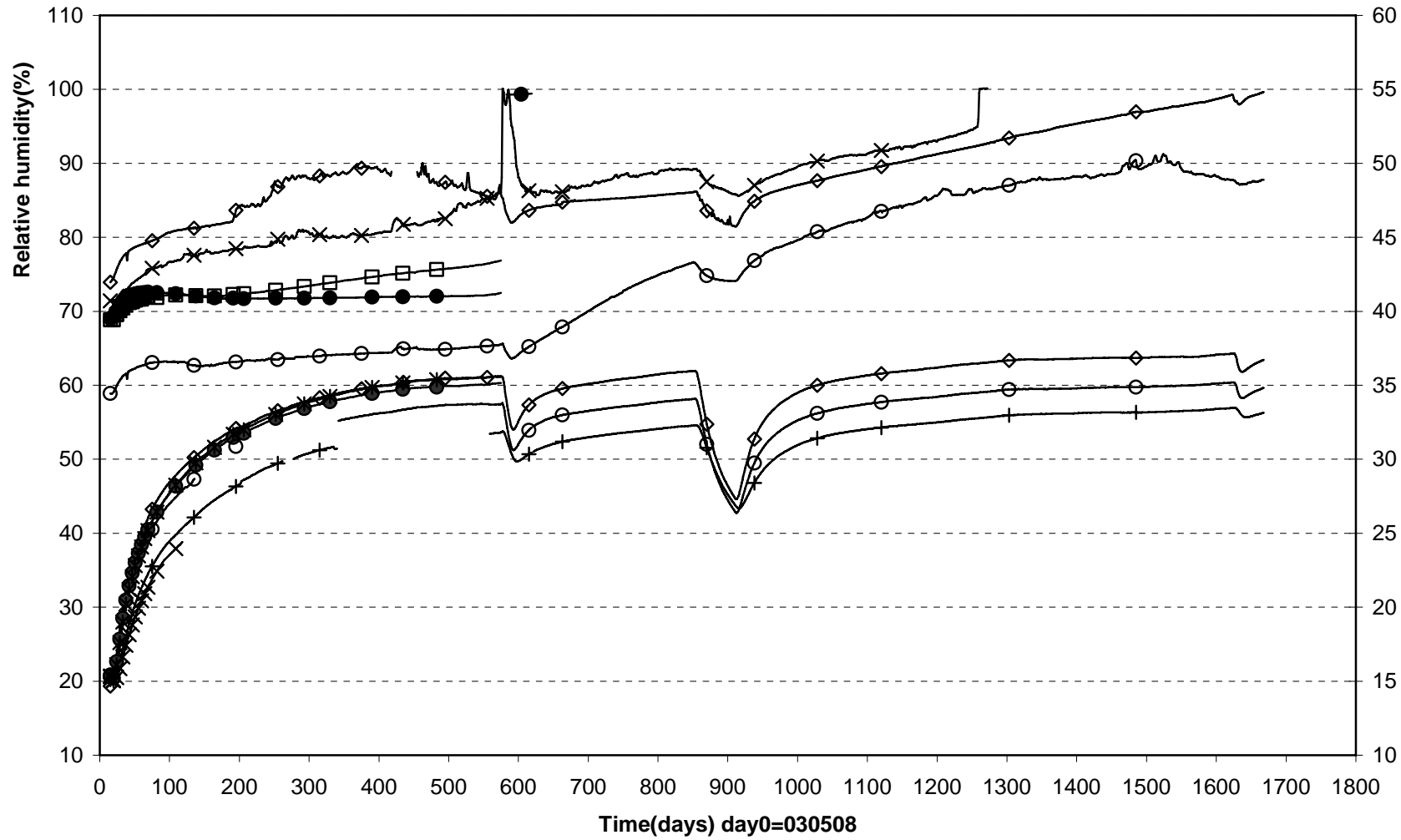

● WB652(6.366\90°\0.585)    □ WB654(6.366\350°\0.585)    △ WB656(6.961\270°\0.100)    ◇ WB651(6.366\225°\0.100)  
 ○ WB653(6.366\180°\0.585)    × WB655(6.801\180°\0.100)

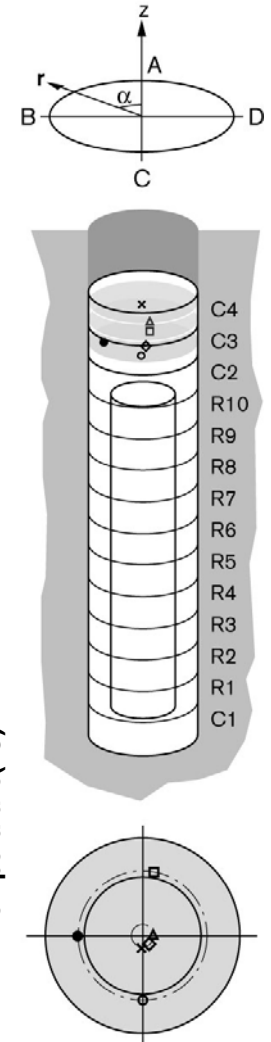

Prototype\Hole 6\Cyl.1 , Ring 6 and Ring8 (030508-071201)  
 Relative humidity

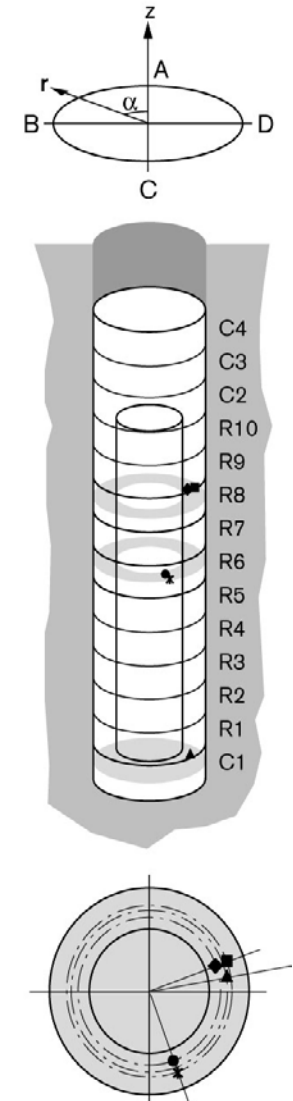
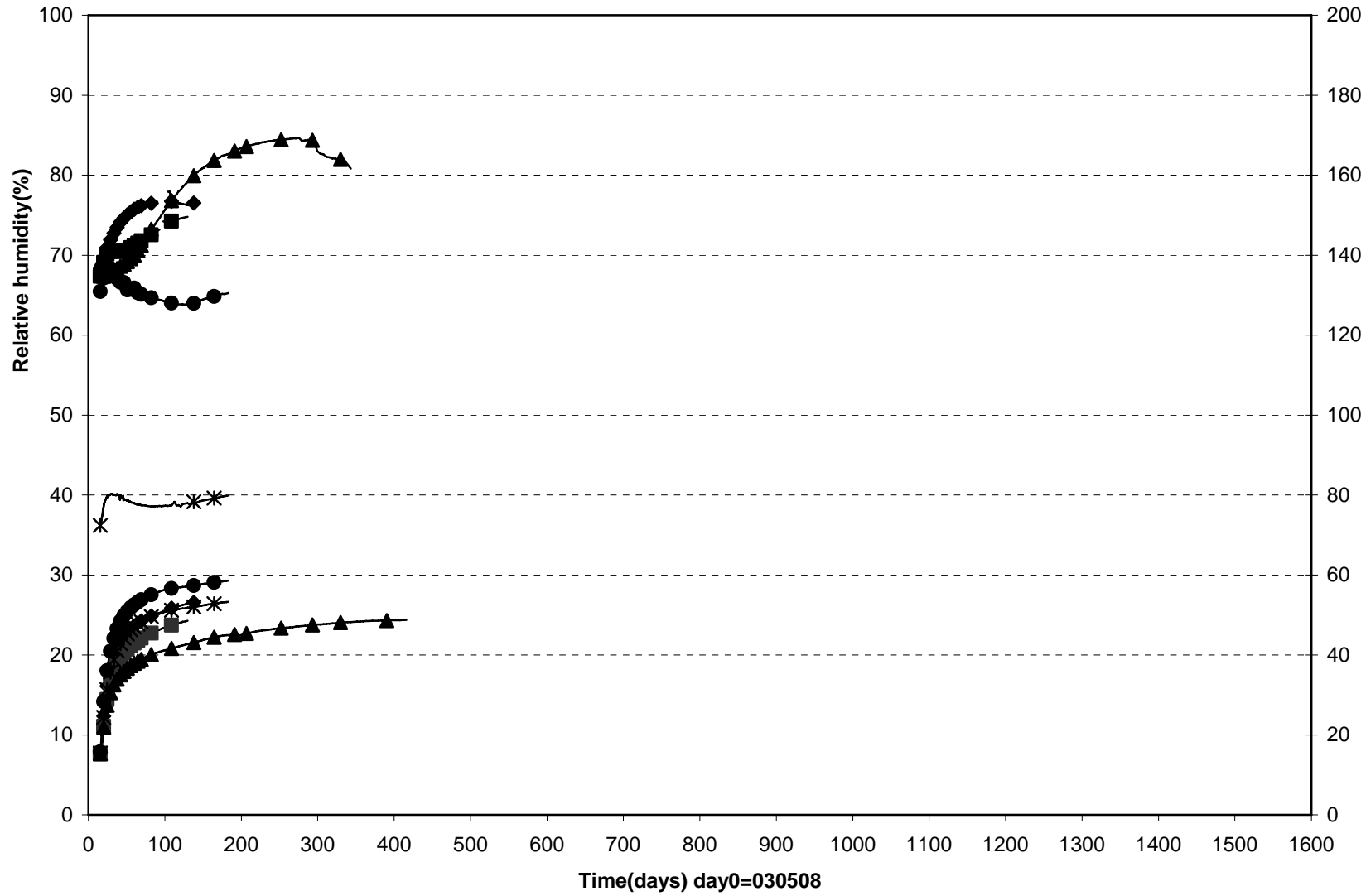

▲ WB667(0.260\280°\0.685) ● WB668(3.300\200°\0.625) ✱ WB669(3.300\200°\0.725) ◆ WB670(4.324\290°\0.625) ■ WB671(4.324\290°\0.725)

Prototype\ Hole 6 \Rock (030508-071201)  
Suction - Wescor

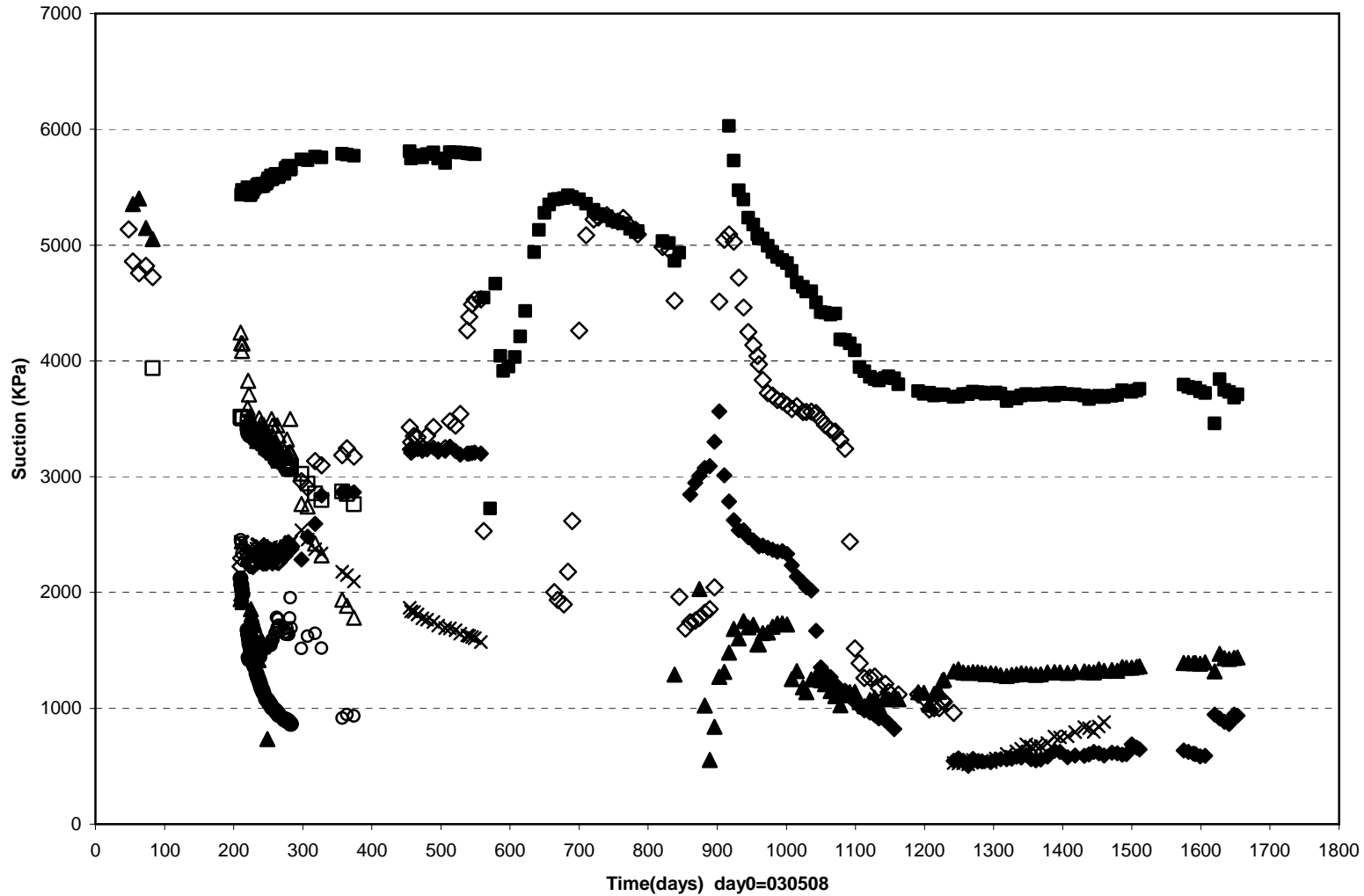

|                                |                                |                                |
|--------------------------------|--------------------------------|--------------------------------|
| ◆ WB659(3.100\190°\0.900\Rock) | ■ WB660(3.250\190°\0.925\Rock) | ▲ WB661(3.400\190°\0.975\Rock) |
| △ WB664(4.100\280°\0.900\Rock) | □ WB665(4.250\280°\0.925\Rock) | ◇ WB666(4.400\280°\0.975\Rock) |
| ○ WB619(1.253\305°\0.875\Rock) | ● WB633(3.253\305°\0.875\Rock) | × WB647(4.753\305°\0.875\Rock) |

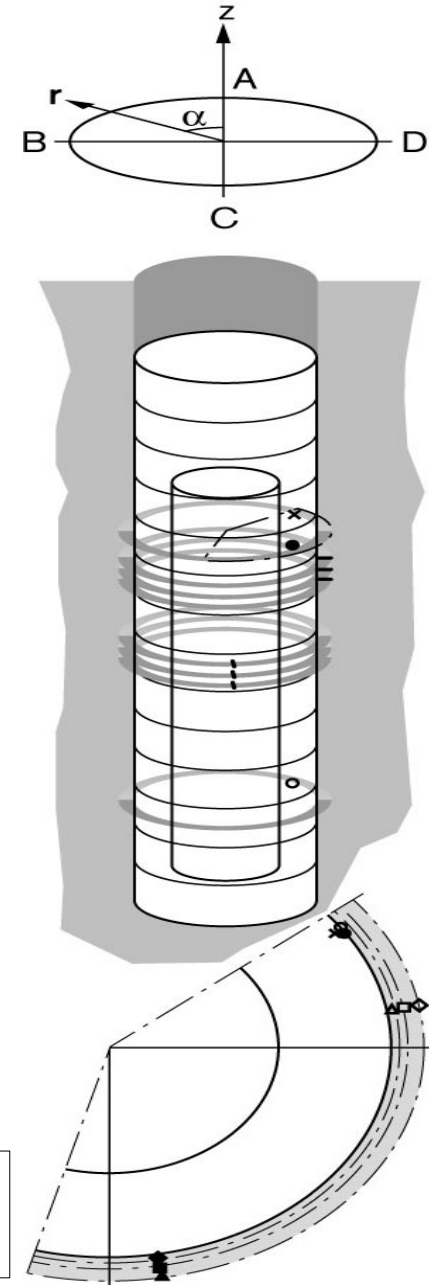



Prototype \ Hole 6 \ Cyl1 (030508-071201)  
Suction - Wescor

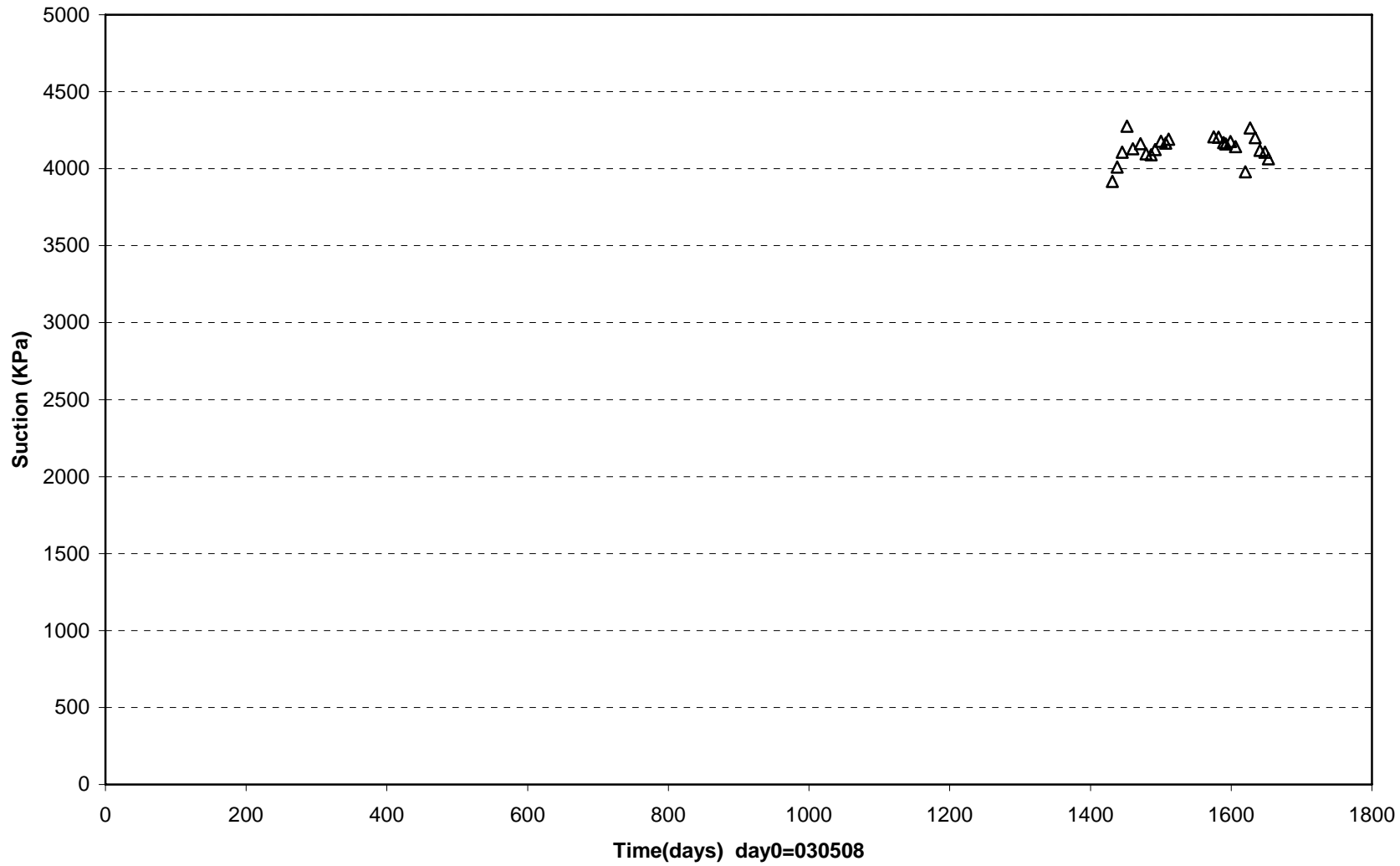

□ WB602(0.260\225°\0.050) ◆ WB603(0.260\260°\0.210) △ WB605(0.260\90°\0.685)

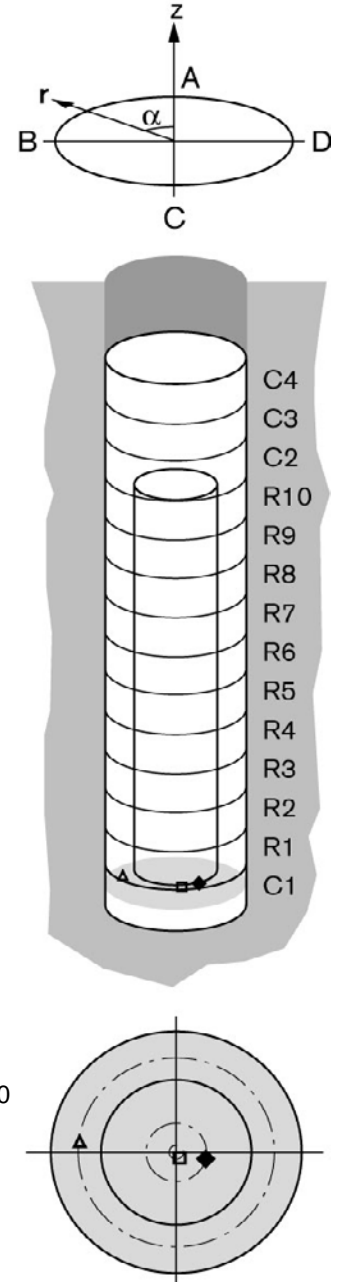

Prototype\ Hole 6 \ Ring 1 and Ring 2 (030508-071201)  
Suction - Wescor

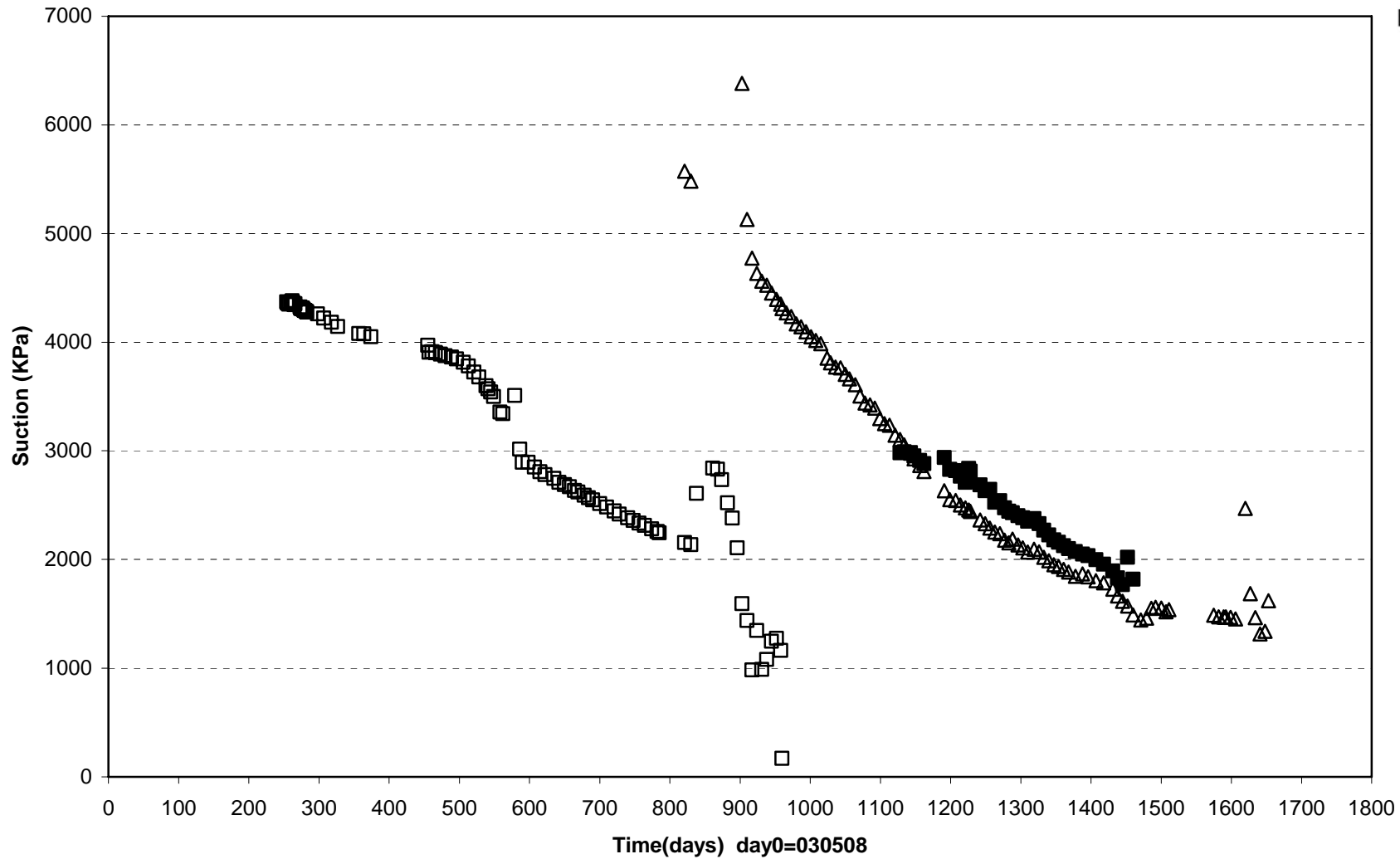

- WB608(0.770\95°\0.685)
- ◆ WB612(0.750\185°\0.585)
- WB611(0.770\355°\0.785)
- △ WB614(1.284\45°\0.735)
- WB616(1.284\135°\0.635)
- ◇ WB618(1.284\235°\0.535)

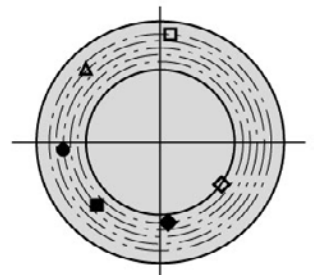
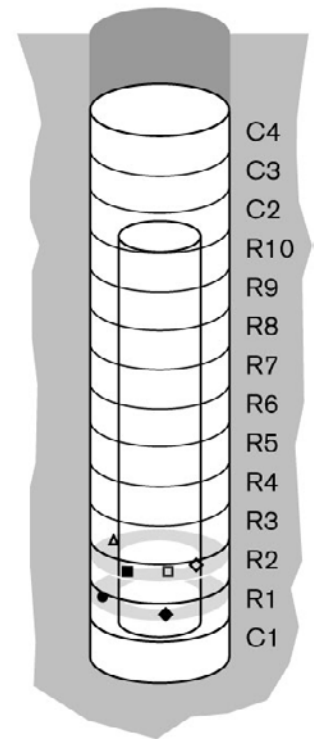
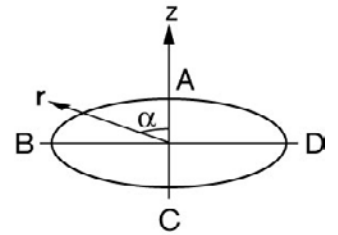

Prototype\ Hole 6 \ Ring 5 and Ring 6 (030508-071201)  
Suction - Wescor

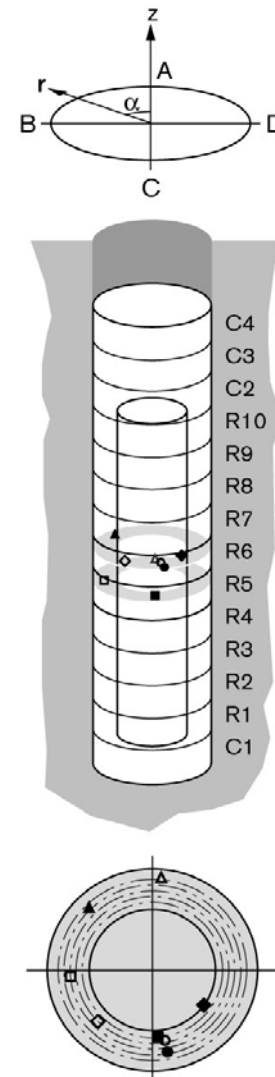
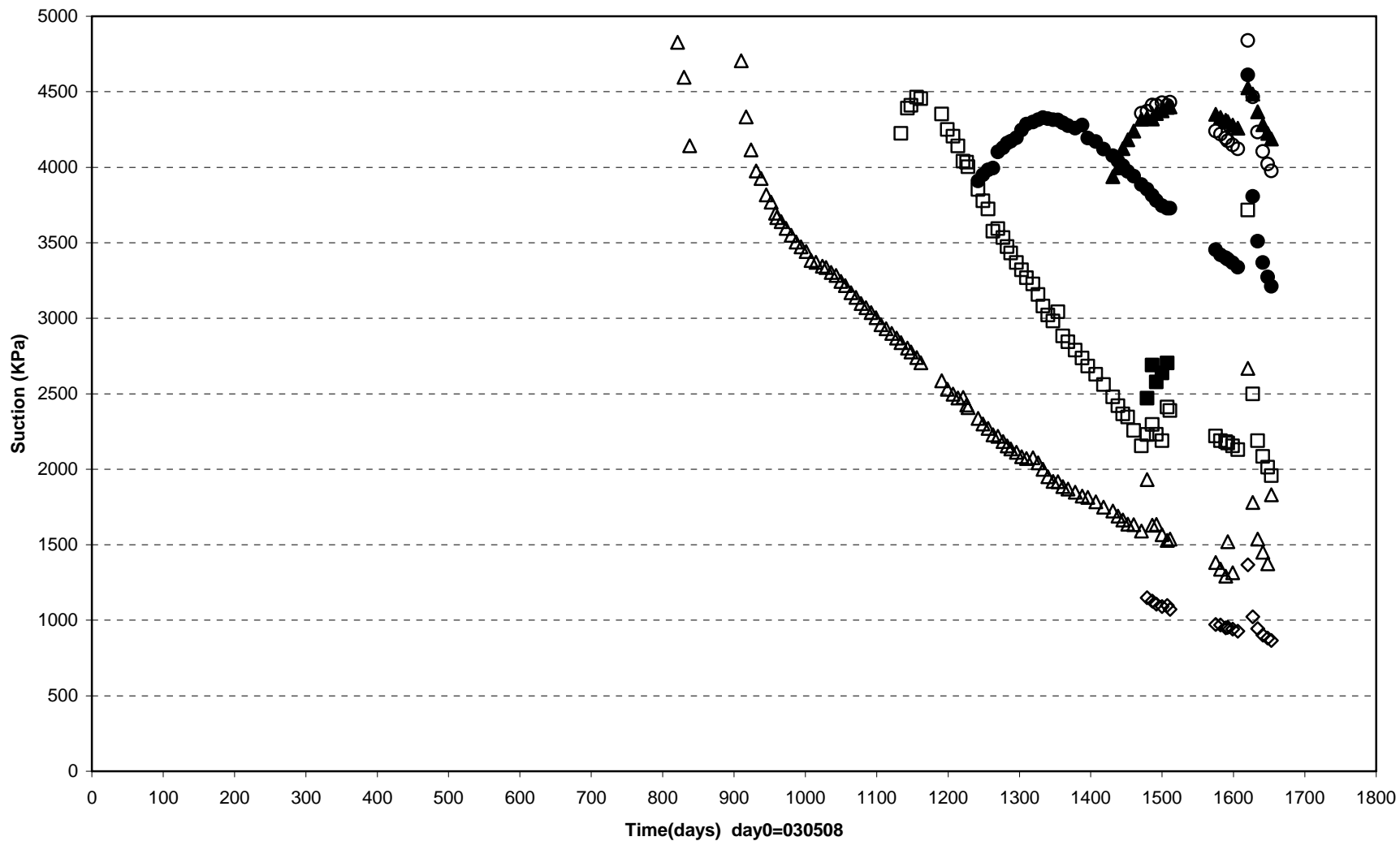

- WB622(2.795\95°\0.685)    ■ WB624(2.795\185°\0.585)    △ WB625(2.795\355°\0.785)    ▲ WB628(3.300\45°\0.735)
- ◇ WB630(3.300\135°\0.635)    ◆ WB632(3.300\235°\0.535)    ○ WB657(3.300\190°\0.625)    ● WB658(3.300\190°\0.725)

Prototype\ Hole 6 \ Ring 6 and Ring 8 (030508-071201)  
Suction - Wescor

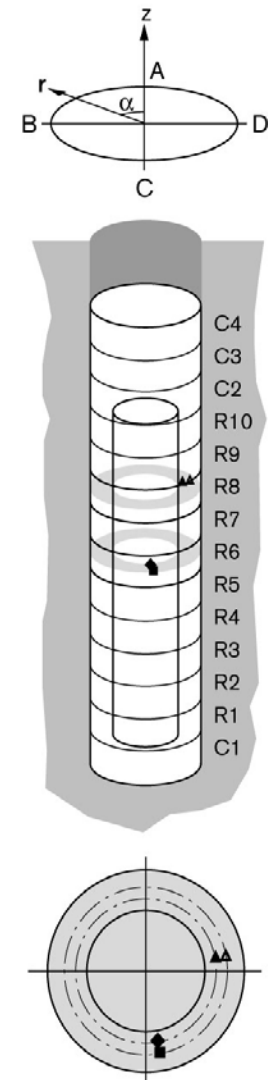
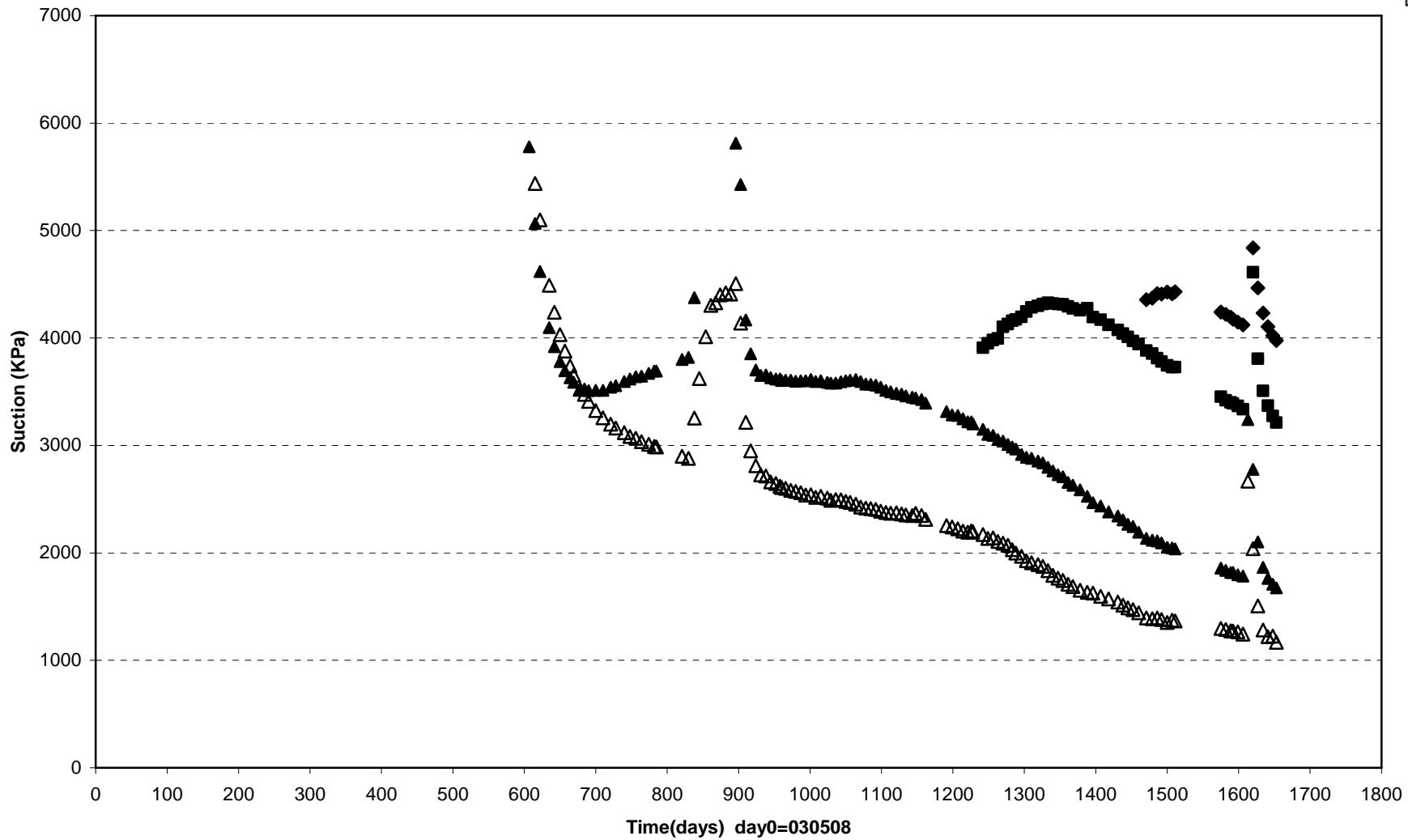

◆ WB657(3.300\190°\0.625) ■ WB658(3.300\190°\0.725) ▲ WB662(4.324\280°\0.625) △ WB663(4.324\280°\0.725)

PrototypeHole6 \Cyl.1 and Ring2 (030508-071201)  
Pore pressure

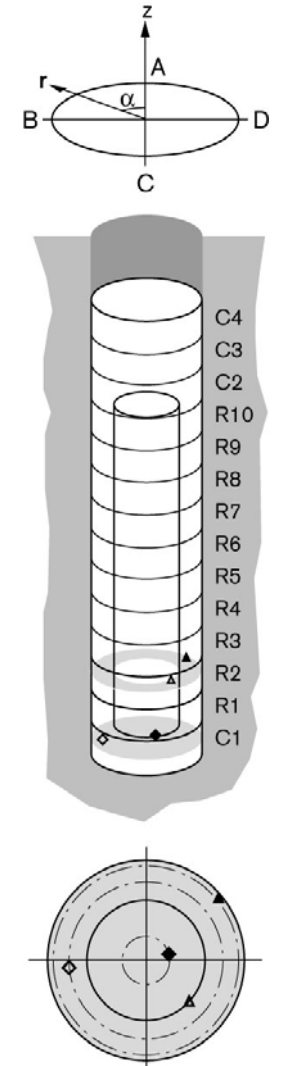
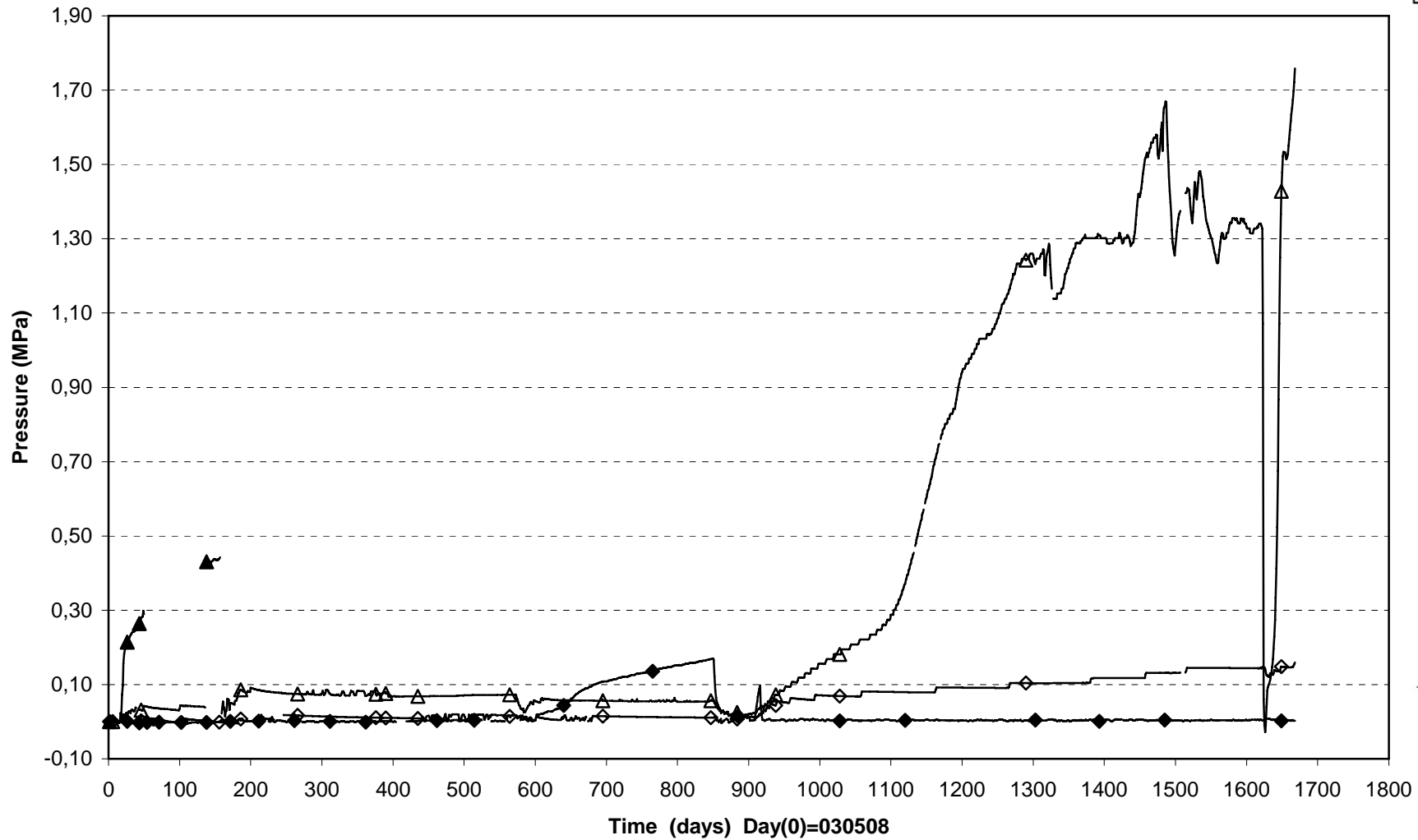

◆ UB601(0.260 \280°\ 0.210) ◇ UB602(0.260\95°\0.685)      △ UB603(1.284\225°\0.535)      ▲ UB604(1.253 \310°\ 0.875)

Prototype\Hole6 \ Ring 5 and Ring 6 (030508-071201)  
Pore pressure

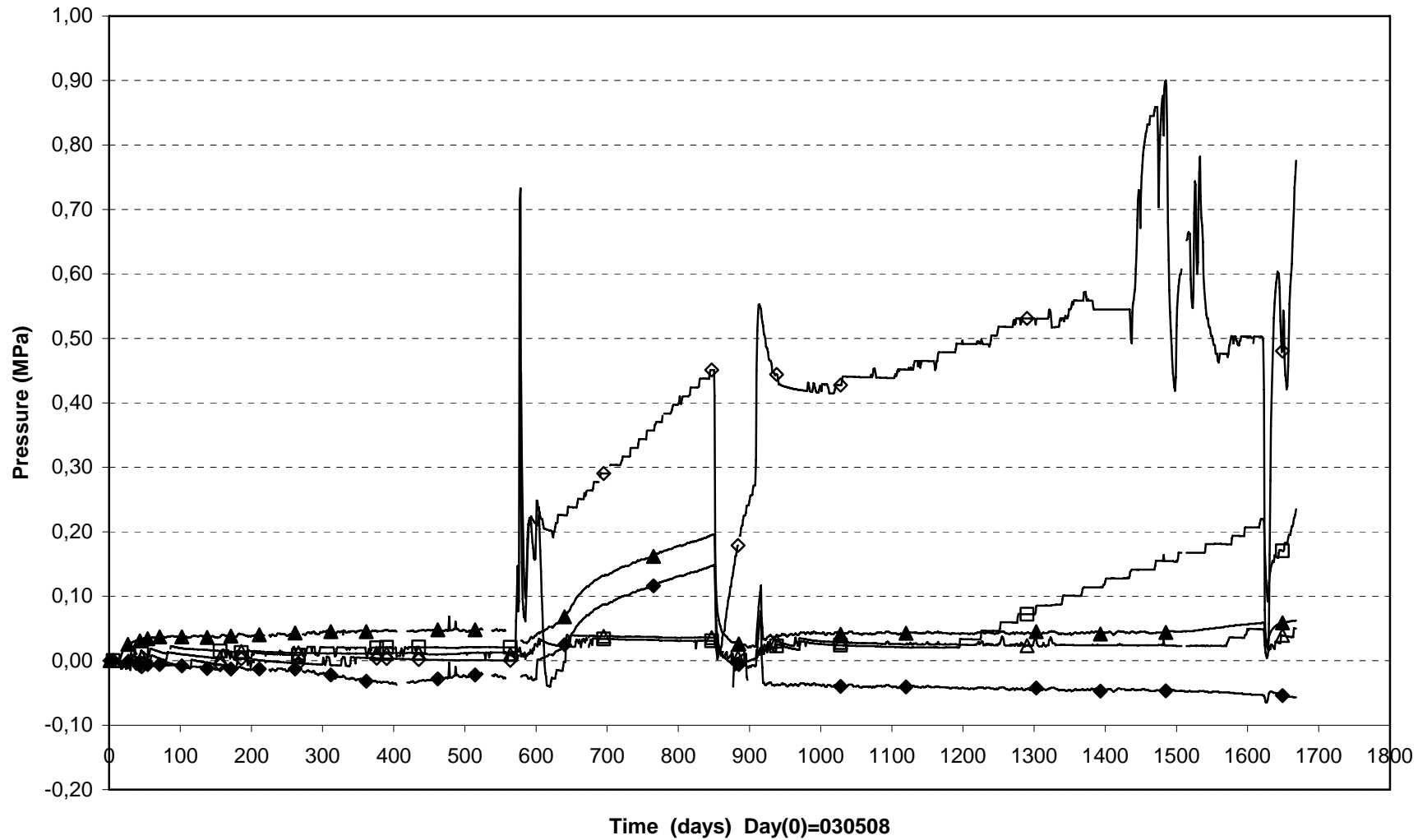

|                            |                            |                           |
|----------------------------|----------------------------|---------------------------|
| □ UB605(2.795\190°\0.585)  | ■ UB606(2.795\350°\ 0.785) | ◆ UB607(3.300\35°\ 0.735) |
| ▲ UB608(3.300\125°\ 0.635) | △ UB609(3.300\225°\0.535)  | ◇ UB610(3.253\310°\0.875) |

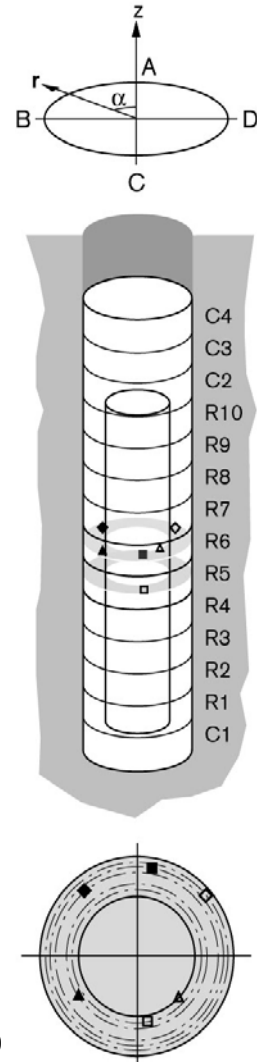

Prototype\Hole6\Ring 9 , Cyl.3 and Cyl.4 (030508-071201)  
 Pore pressure

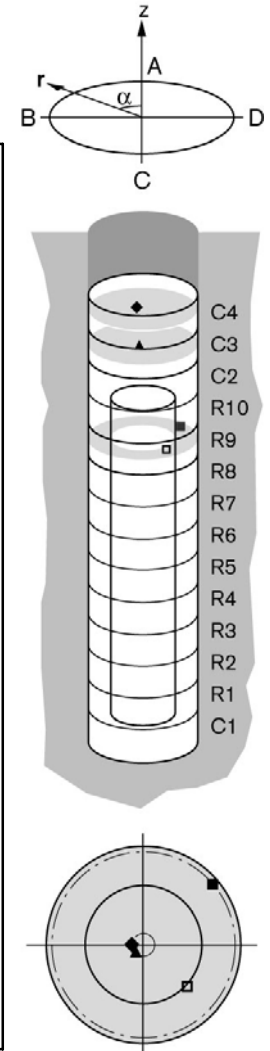
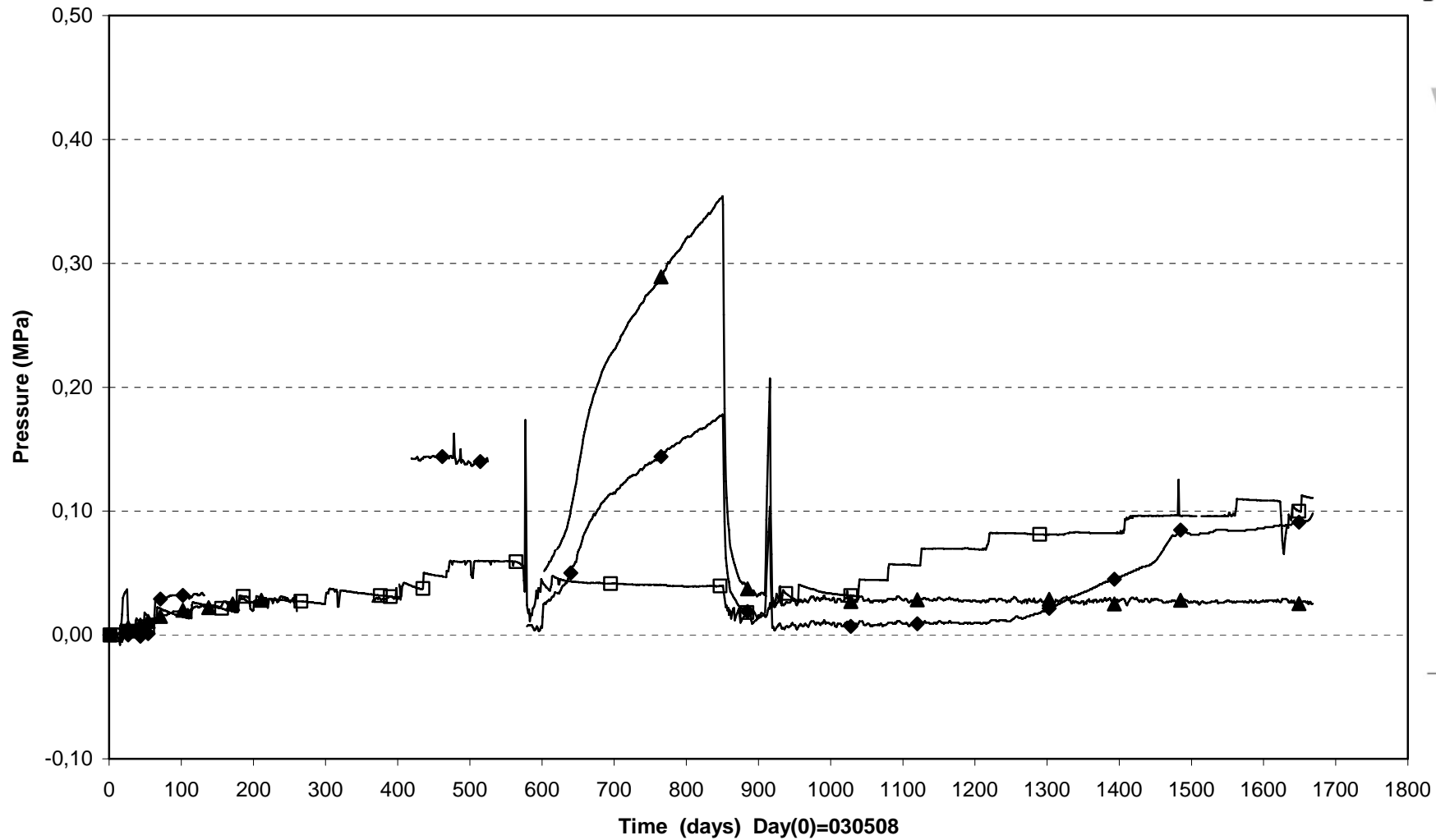

□ UB611(4.834\225°\0.535)      ■ UB612(4.753 \310°\ 0.875)      ▲ UB613(6.366 \135°\ 0.100)      ◆ UB614(6.961 \90°\ 0.100)

Prototype\Hole 6\Cyl.1 and Ring1 (030508-071201)  
 Temperature - Pentronic

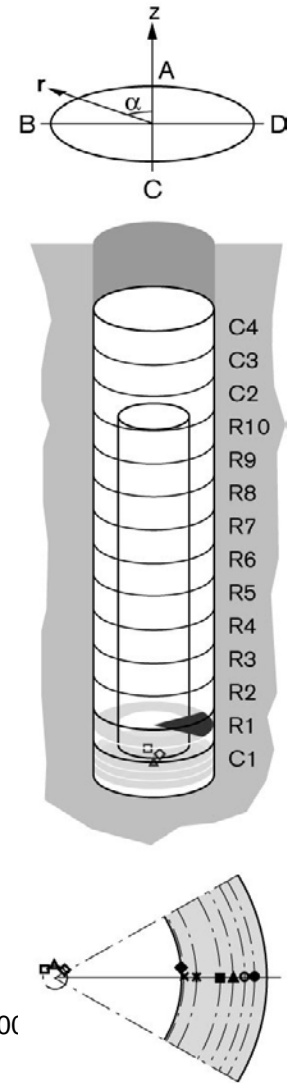
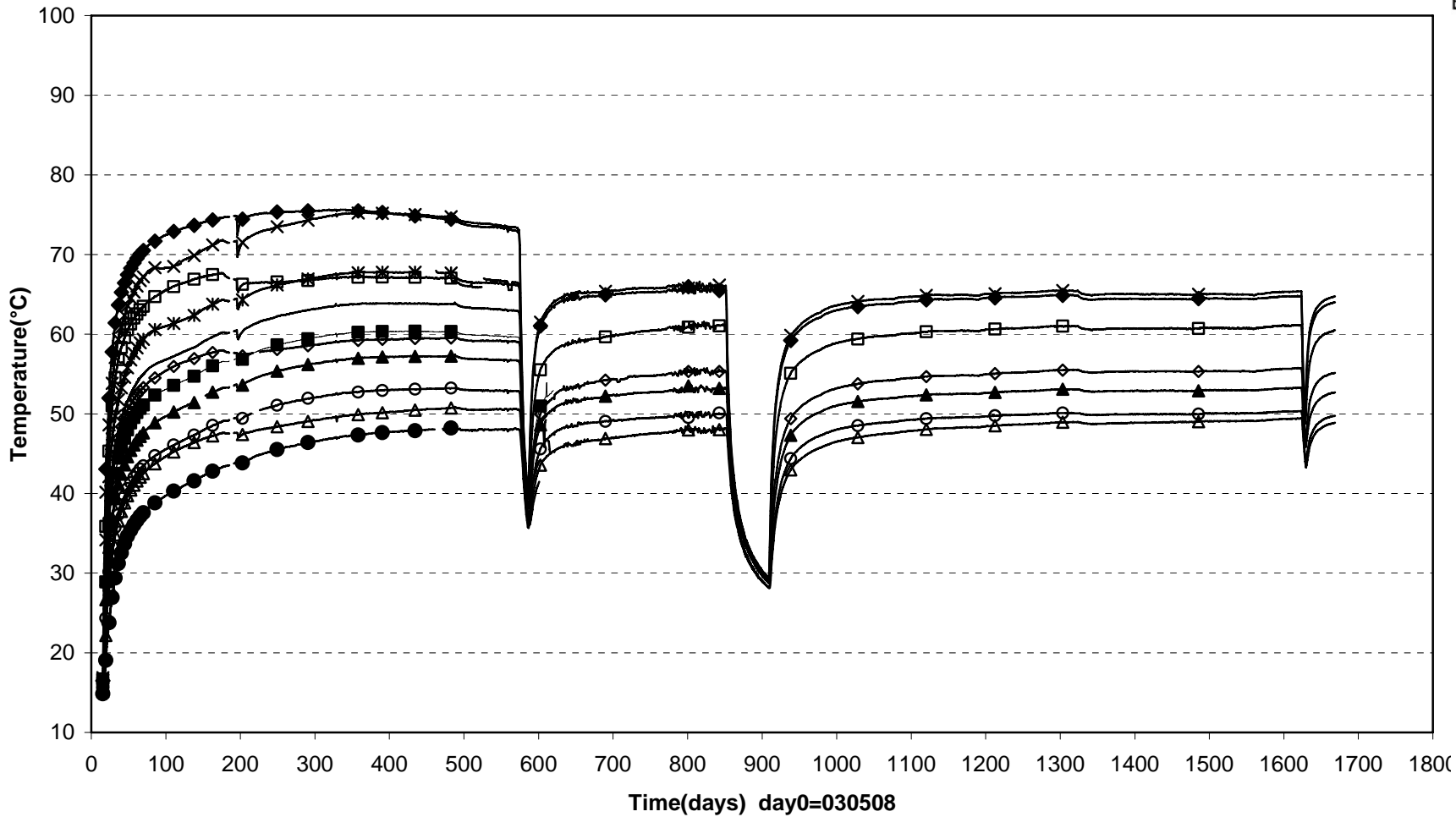

|                           |                           |                           |                           |
|---------------------------|---------------------------|---------------------------|---------------------------|
| □ TB601(0.385\45°\0.050)  | ◇ TB602(0.260\315°\0.050) | △ TB603(0.135\0°\0.050)   | × TB604(0.770\270°\0.535) |
| × TB605(0.770\270°\0.585) | ■ TB607(0.770\270°\0.685) | ▲ TB608(0.770\270°\0.735) | ○ TB609(0.770\270°\0.785) |
| ● TB610(0.753\270°\0.875) | ◆ TB611(0.753\ 0°\0.525)  | — TB606(0.750\270°\0.635) |                           |



Prototype\Hole 6 \Ring5 (030508-071201)  
 Temperature - Pentronic

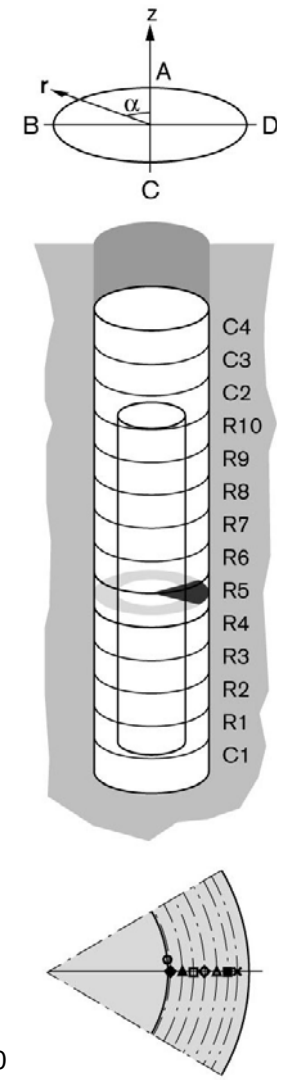
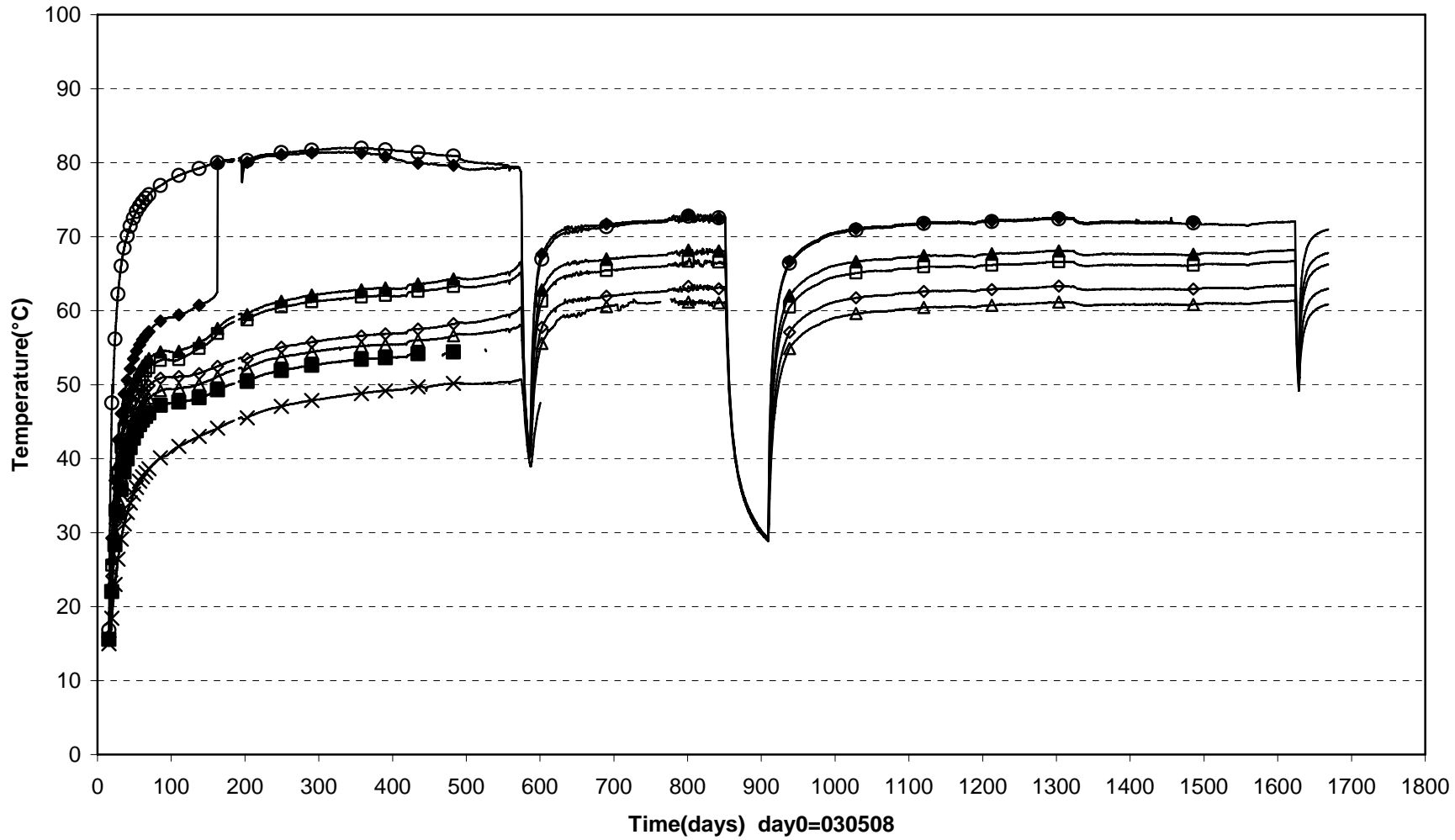

◆ TB612(2.795\270°\0.535) ▲ TB613(2.795\270°\0.585) □ TB614(2.795\270°\0.635) ◇ TB615(2.795\270°\0.685) △ TB616(2.795\270°\0.735)  
 ■ TB617(2.795\270°\0.785) × TB618(2.753\270°\0.875) ○ TB619(2.753\ 0°\0.525)

Prototype\Hole 6 \Ring8 (030508-071201)  
 Temperature - Pentronic

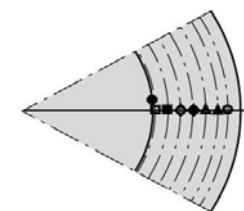
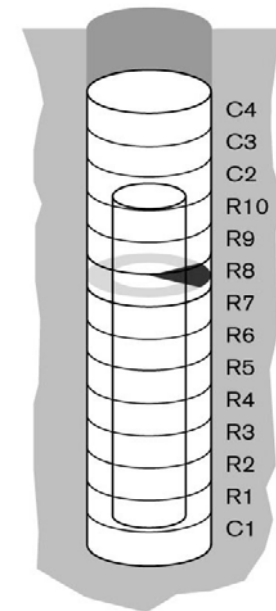
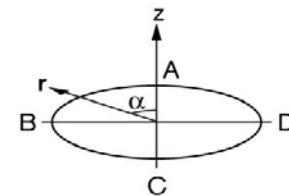
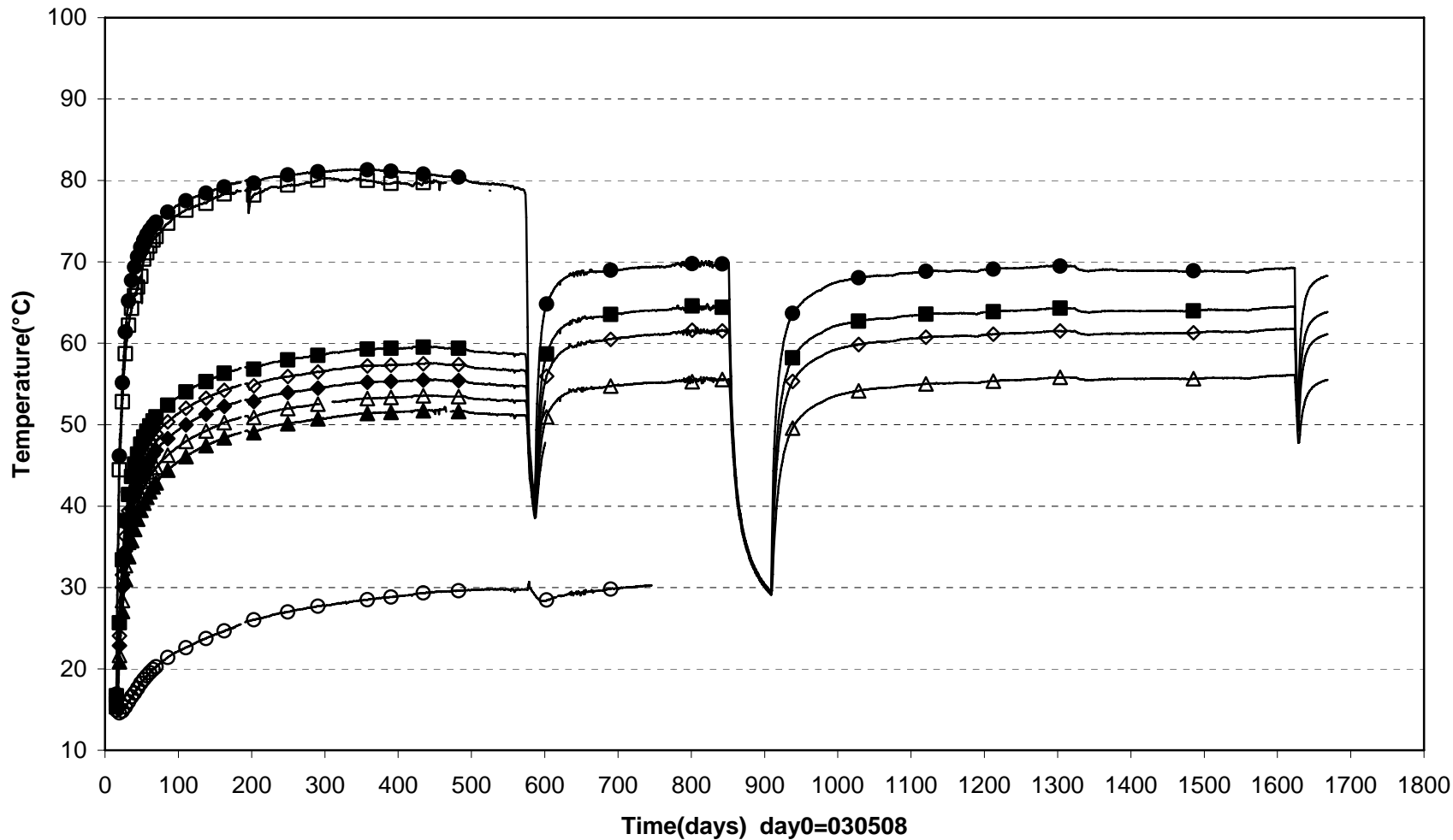

□ TB620(4.324\270°\0.535) ■ TB621(4.324\270°\0.585) ◇ TB622(4.324\270°\0.635) ◆ TB623(4.324\270°\0.685)  
 △ TB624(4.324\270°\0.735) ▲ TB625(4.324\270°\0.785) ○ TB626(4.253\270°\0.875) ● TB627(4.253\0°\0.525)

Prototype\Hole 6 \Cyl.3 and Cyl.4 (030508-071201)  
 Temperature - Pentronic

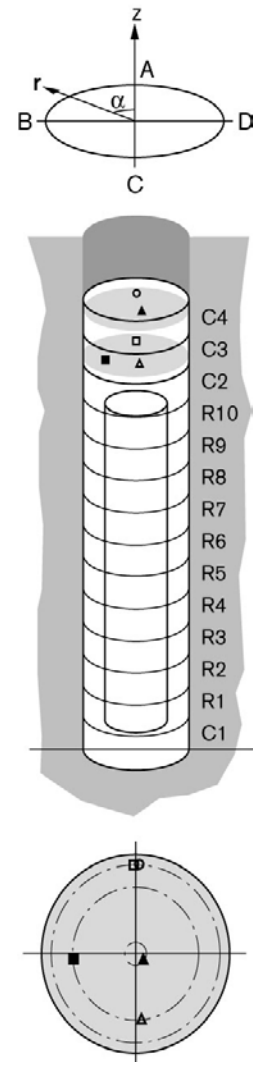
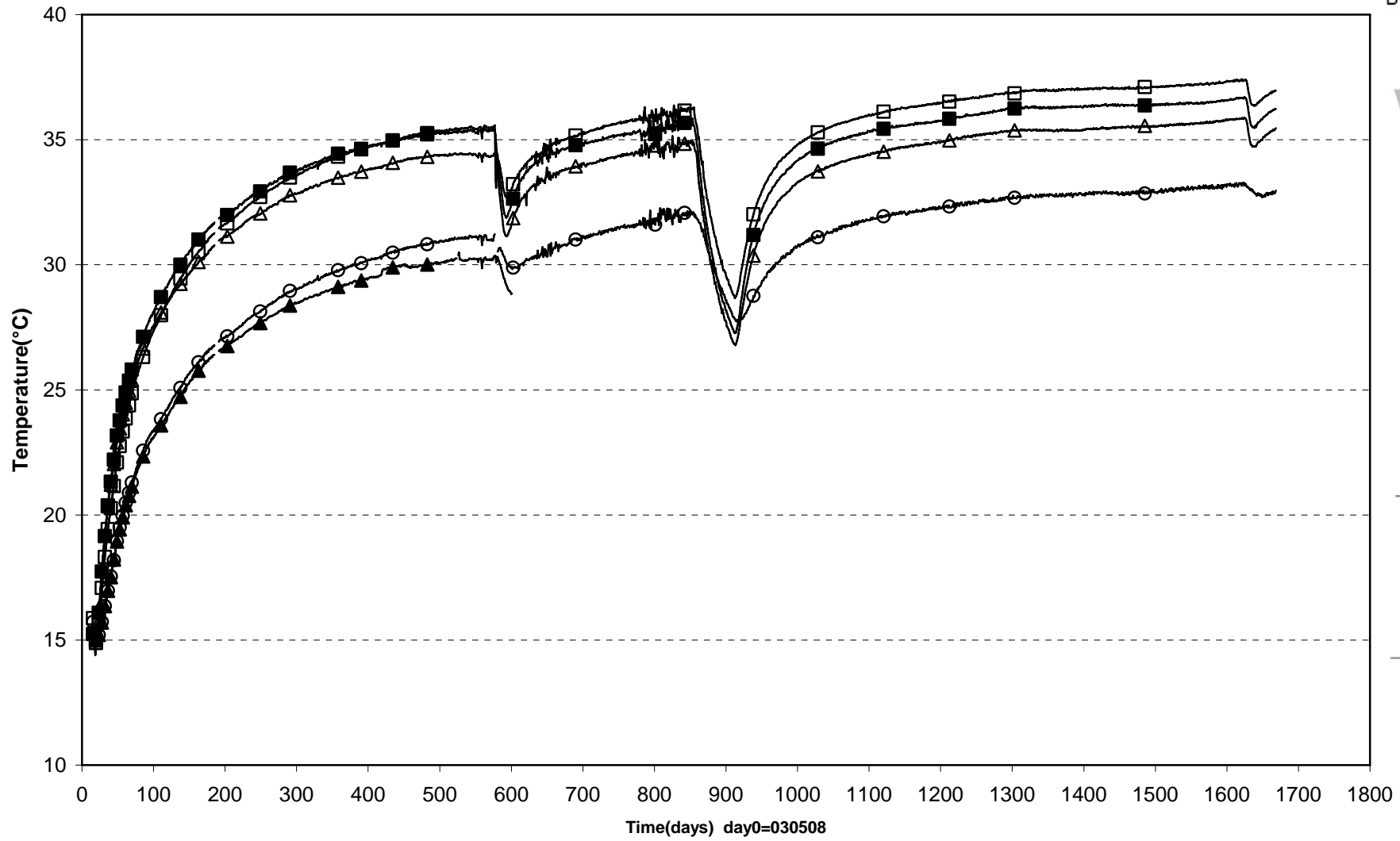

□ TB628(6.366\0°\0.785) ■ TB629(6.366\95°\0.585) △ TB630(6.366\185°\0.585) ▲ TB631(7.071\225°\0.100) ○ TB632(7.071\0°\0.785)

Prototype\Hole 6\Cyl.1 and Ring2 (030508-071201)  
 Temperature - Geokon

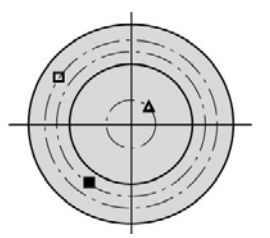
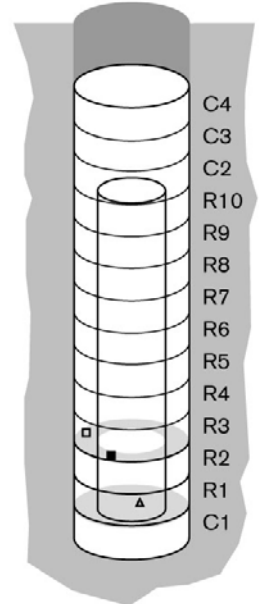
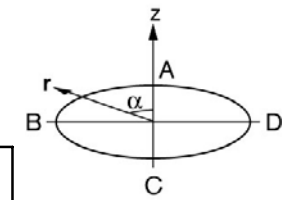
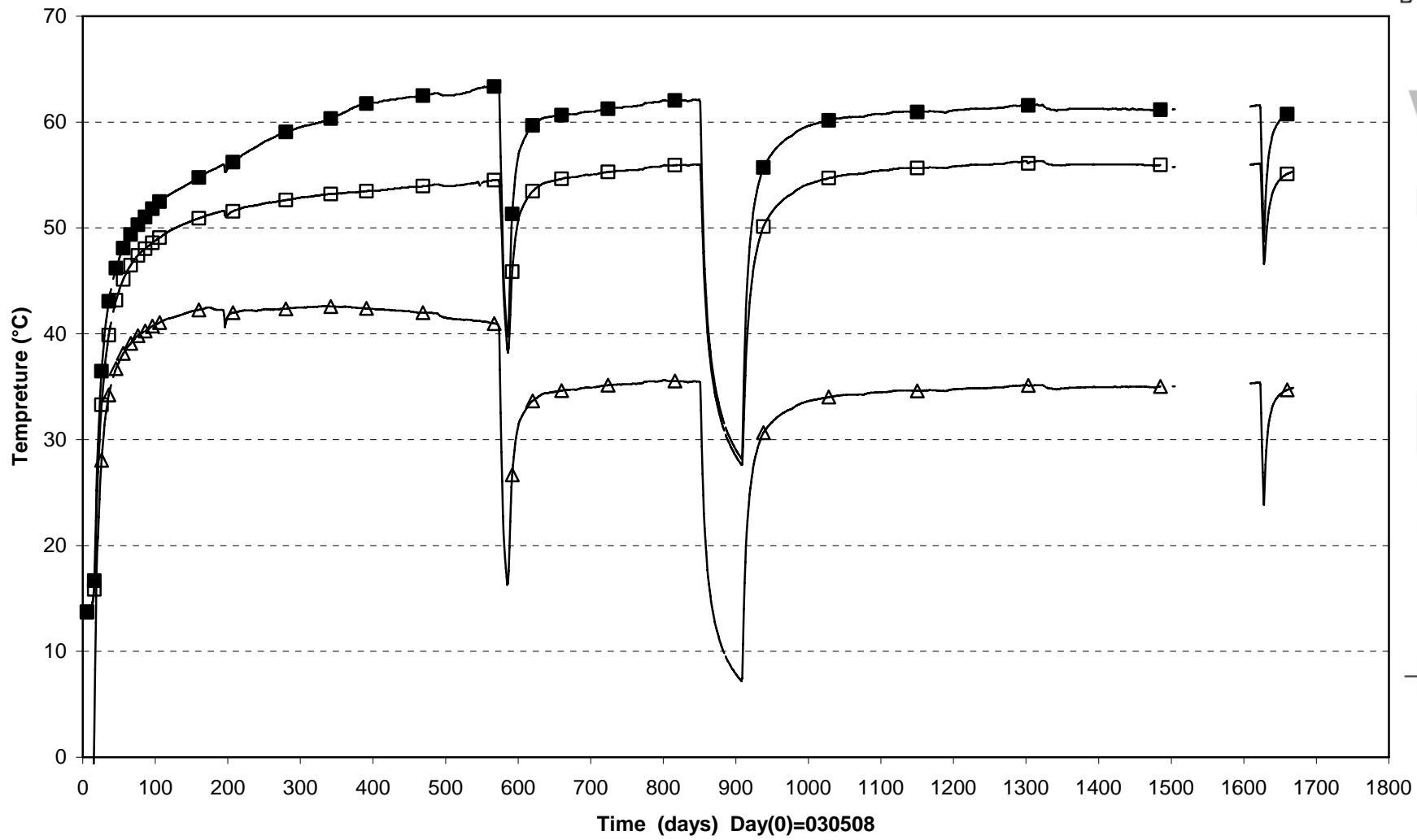

△ PB601T(0.510\315°\0.210)
□ PB606T(1.534\55°\0.735)
■ PB607T(1.534\145°\0.635)

Prototype\Hole 6\ Ring6 (030508-071201)  
 Temperature - Geokon

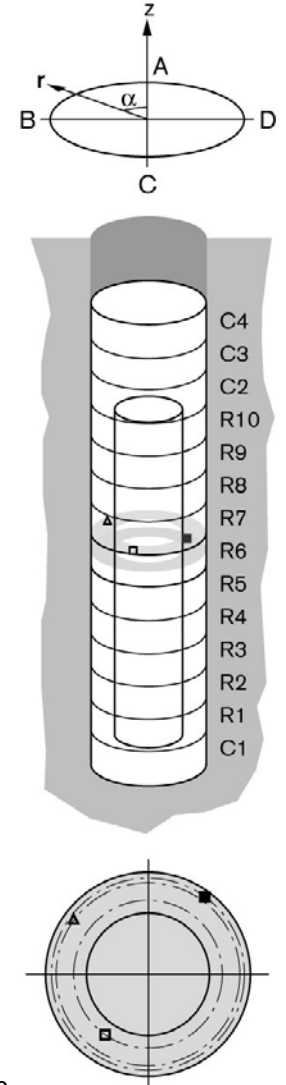
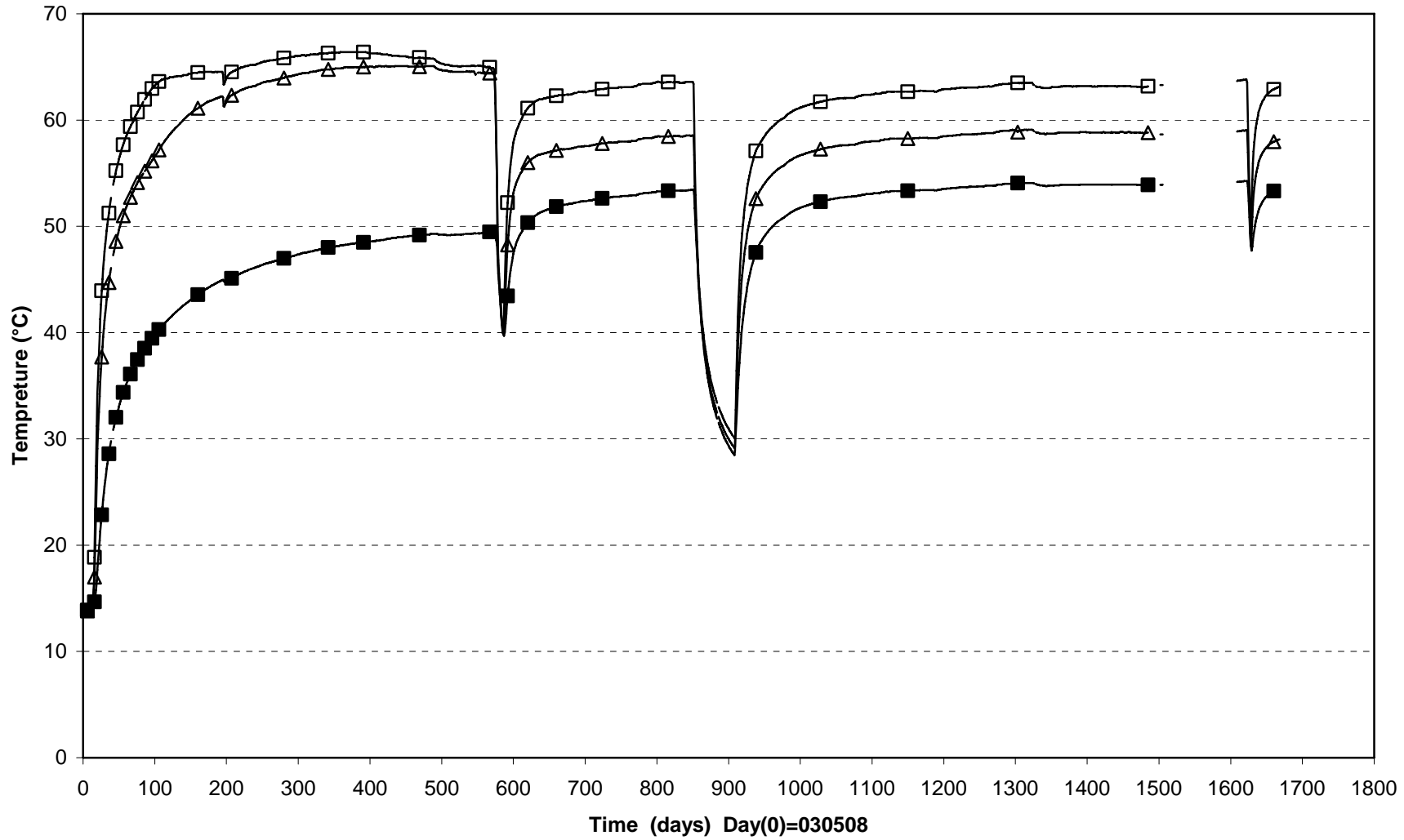

△ PB613T(3.550\55°\0.785)
□ PB614T(3.550\145°\0.635)
■ PB616T(3.253\325°\0.875)

Prototype\Hole 6\ Ring9 (030508-071201)  
 Temperature - Geokon

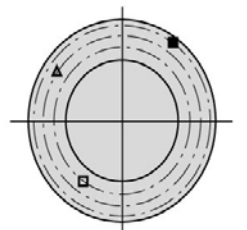
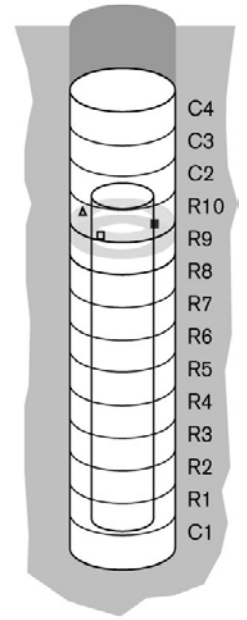
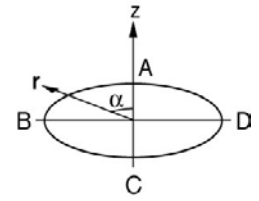
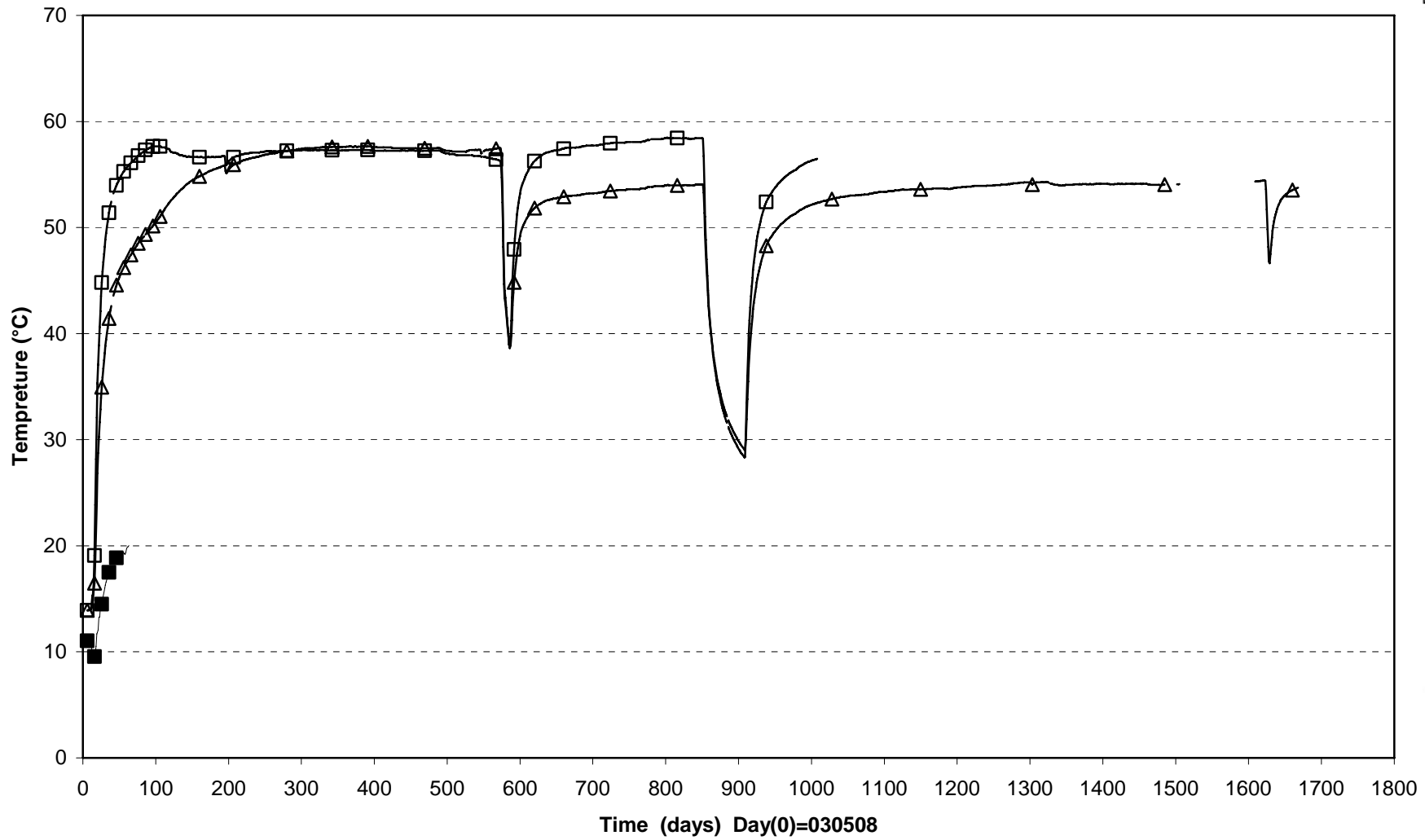

△ PB620T(5.084\55°\0.735)
□ PB621T(5.084\145°\0.635)
■ PB623T(4.753\325°\0.875)

Prototype\Hole 6\Cyl.3 and Cyl.4 (030508-071201)  
 Temperature - Geokon

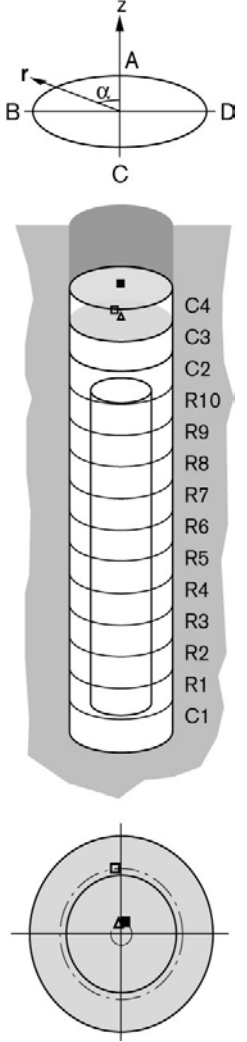
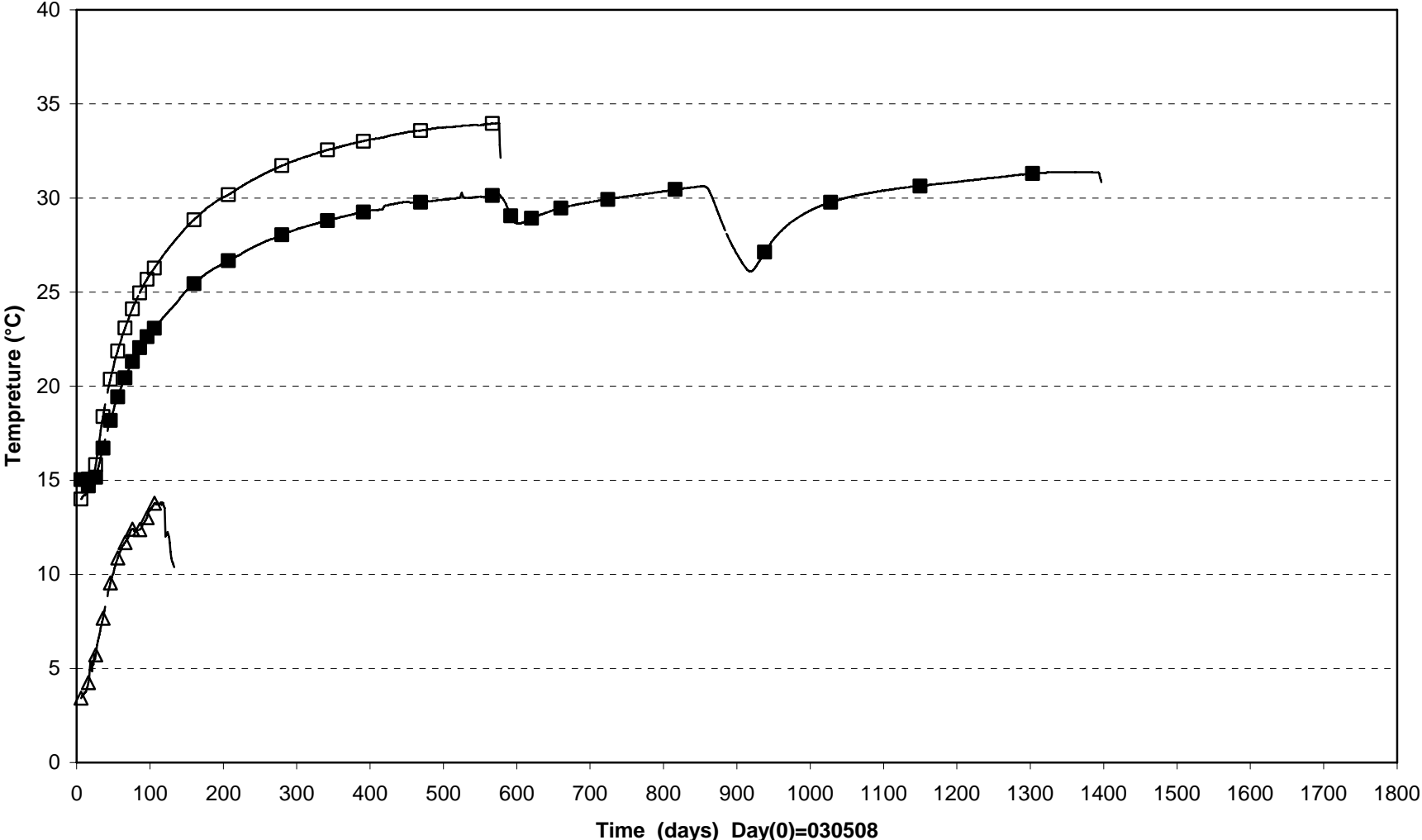

Prototype\Hole6 (030508-071201)  
Temperature- Geokon

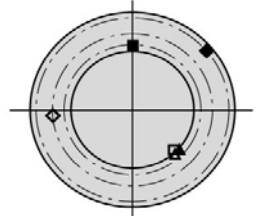
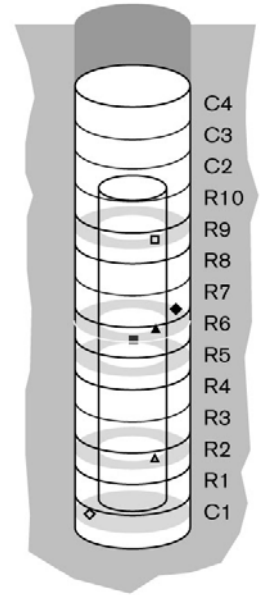
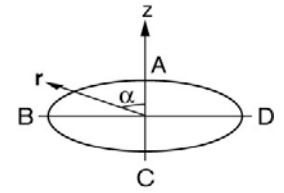
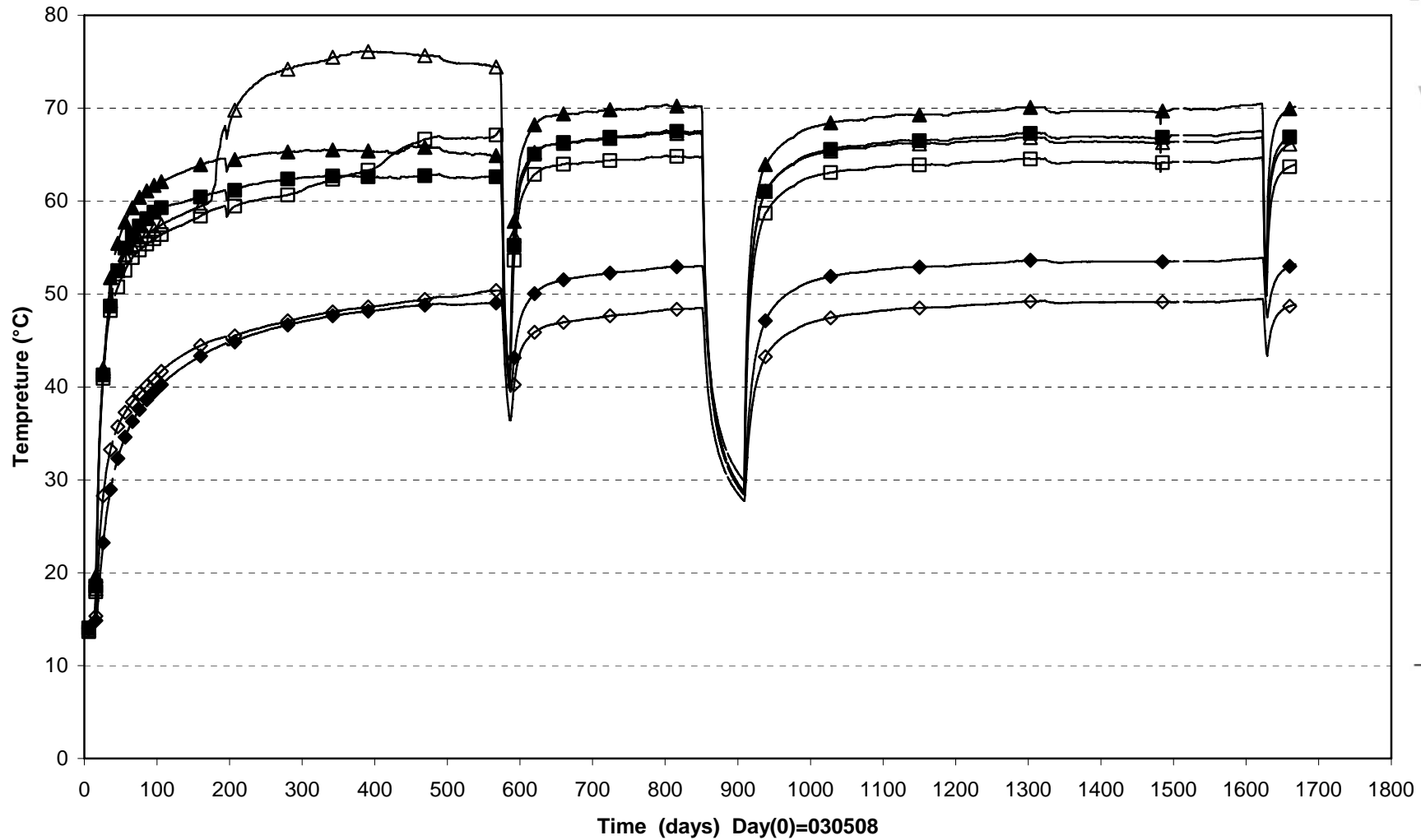

|                            |                            |                            |
|----------------------------|----------------------------|----------------------------|
| ◇ UB602T(0.260\95°\0.685)  | △ UB603T(1.284\225°\0.535) | ■ UB605T(2.795\190°\0.585) |
| ▲ UB609T(3.300\225°\0.535) | ◆ UB610T(3.253\310°\0.875) | □ UB611T(4.834\225°\0.535) |



Prototype\ Hole 6 \ Cyl1 (030508-071201)  
 Temperature - Wescor

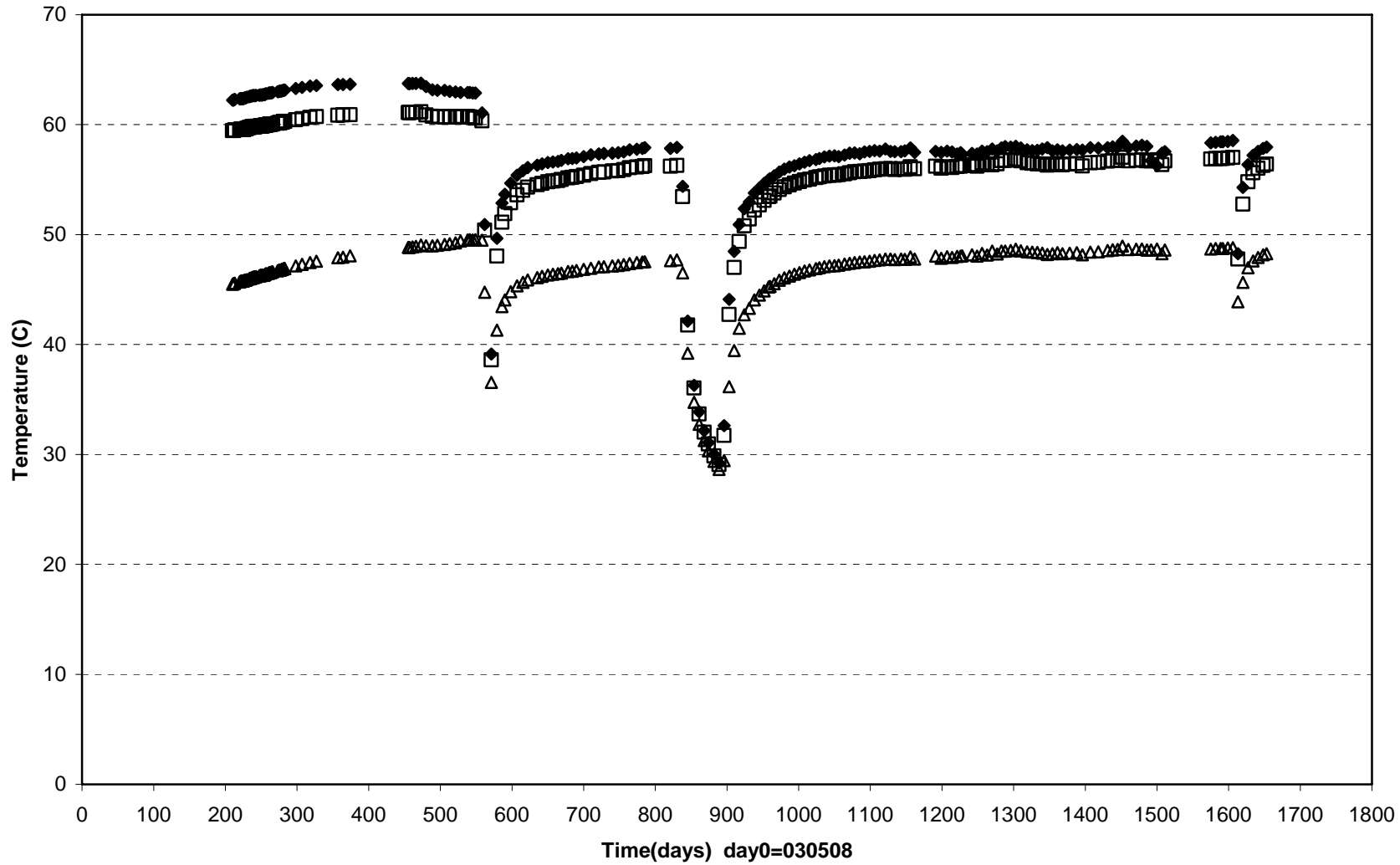

□ WB602T(0.260\225°\0.050) ◆ WB603T(0.260\260°\0.210) △ WB605T(0.260\90°\0.685)

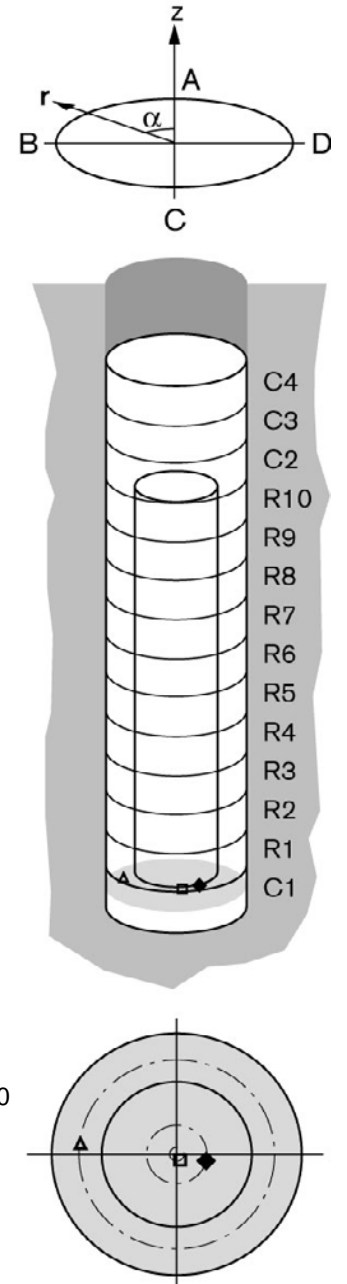

Prototype\ Hole 6 \ Ring 1 and Ring 2 (030508-071201)  
 Temperature - Wescor

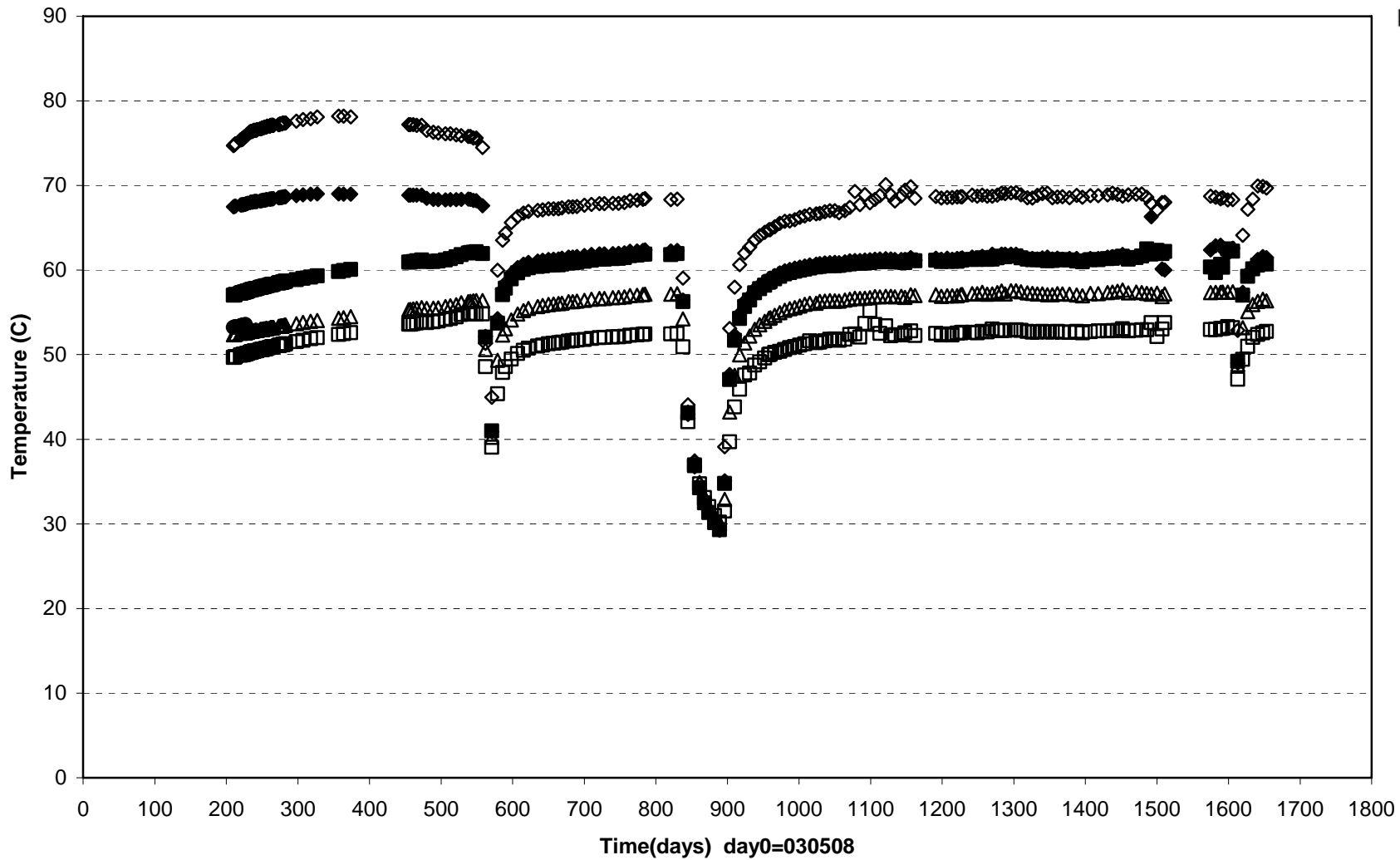

- WB608T(0.770\95°\0.685)    ◆ WB612T(0.750\185°\0.585)    □ WB611T(0.770\355°\0.785)
- △ WB614T(1.284\45°\0.735)    ■ WB616T(1.284\135°\0.635)    ◇ WB618T(1.284\235°\0.535)

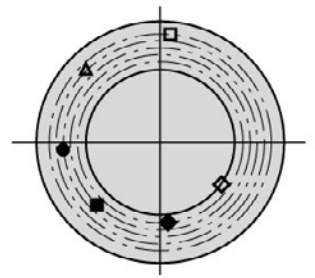
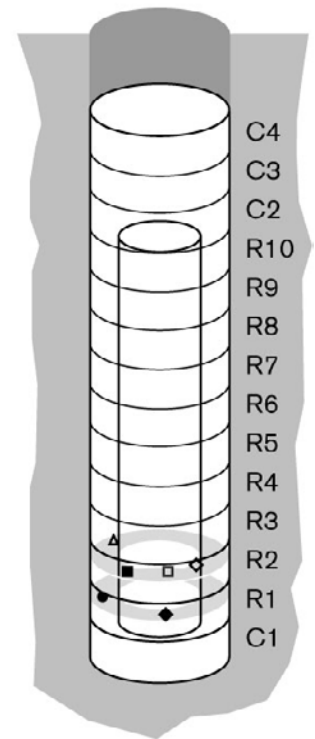
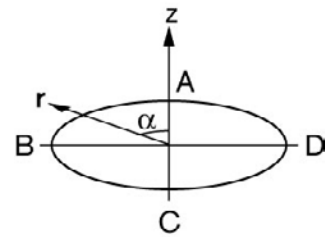

Prototype\ Hole 6 \ Ring 5 and Ring 6 (030508-071201)  
 Temperature - Wescor

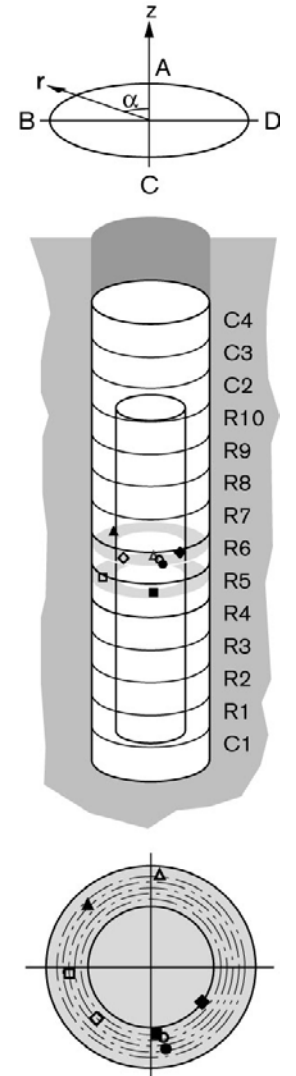
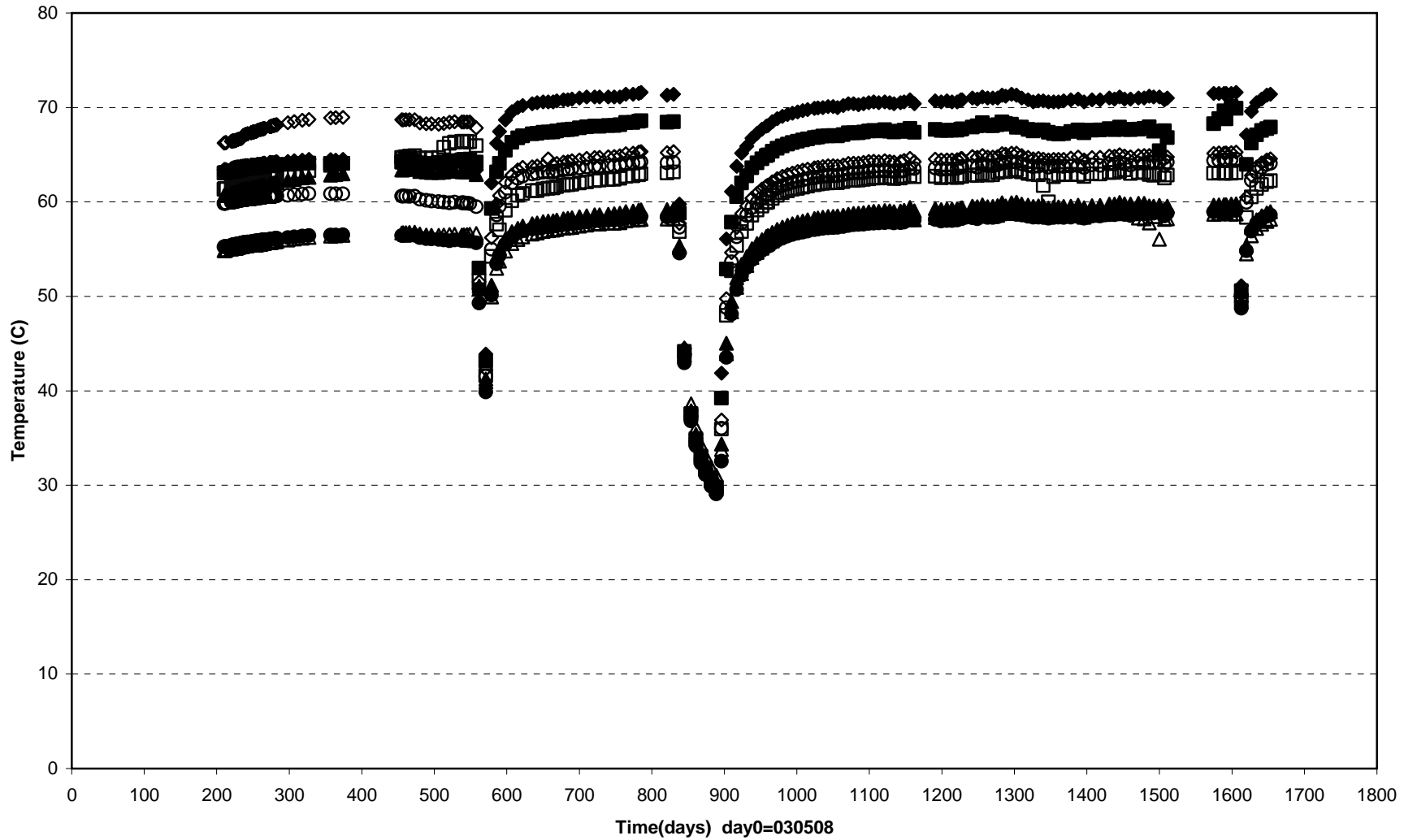

□ WB622T(2.795\95°\0.685)    ■ WB624T(2.795\185°\0.585)    △ WB625T(2.795\355°\0.785)    ▲ WB628T(3.300\45°\0.735)  
 ◇ WB630T(3.300\135°\0.635)    ◆ WB632T(3.300\235°\0.535)    ○ WB657T(3.300\190°\0.625)    ● WB658T(3.300\190°\0.725)

Prototype\ Hole 6 \ Ring 6 and Ring 8 (030508-071201)  
 Temperature - Wescor

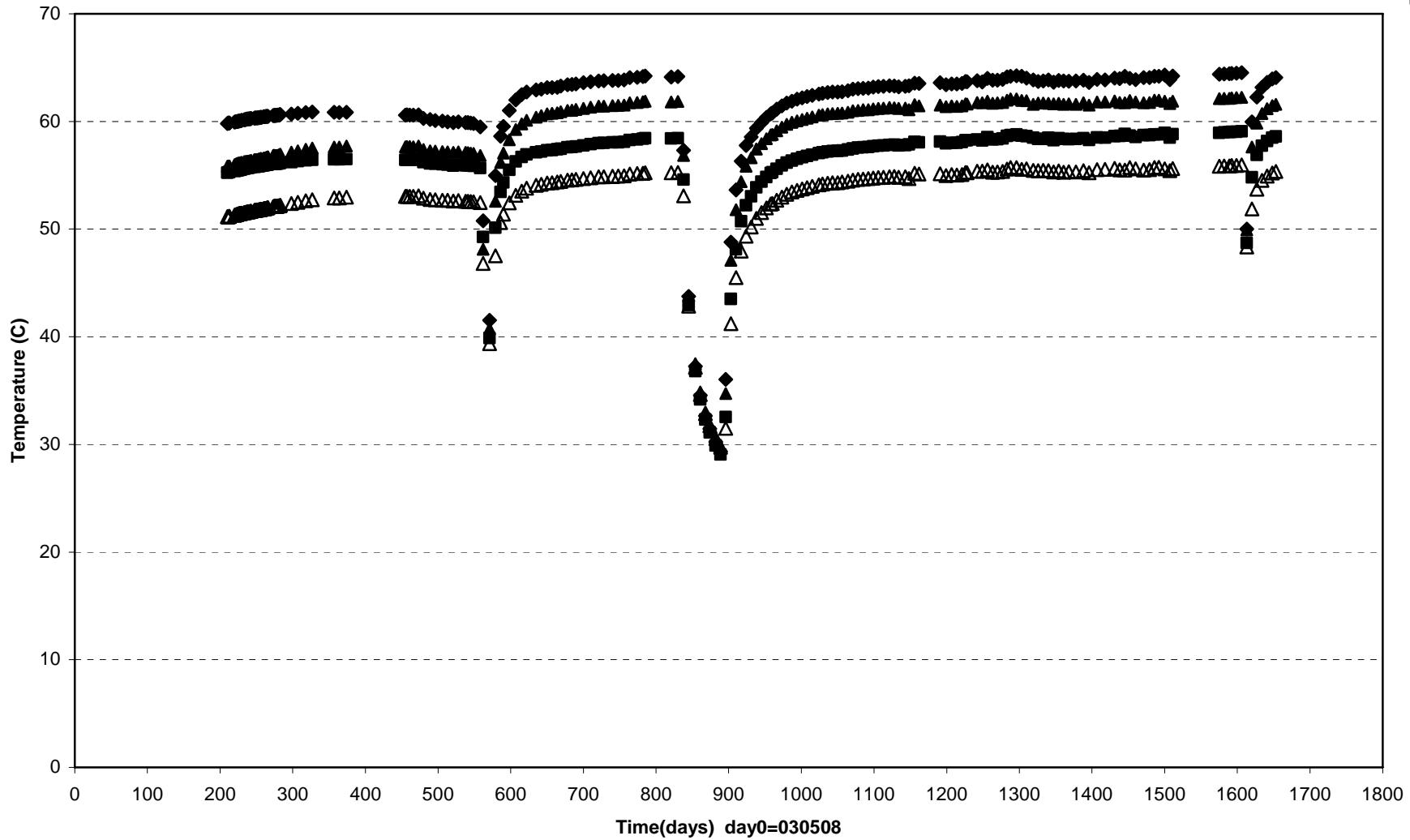

◆ WB657T(3.300\190°\0.625) ■ WB658T(3.300\190°\0.725) ▲ WB662T(4.324\280°\0.625) △ WB663T(4.324\280°\0.725)

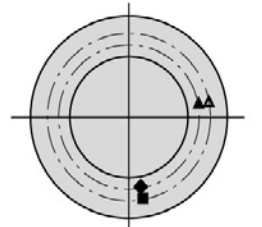
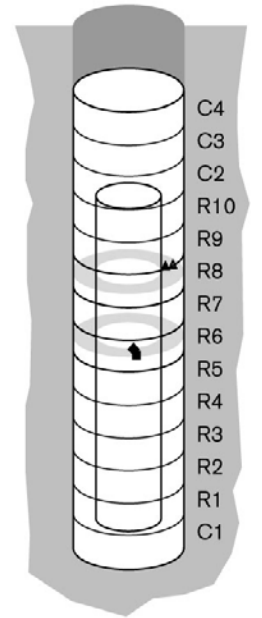
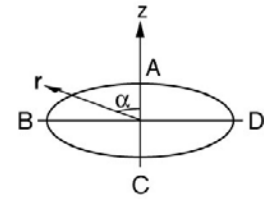

Prototype\Rock\Hole 6\ Level bottom (030508-071201)  
 Temperature - Pentronic

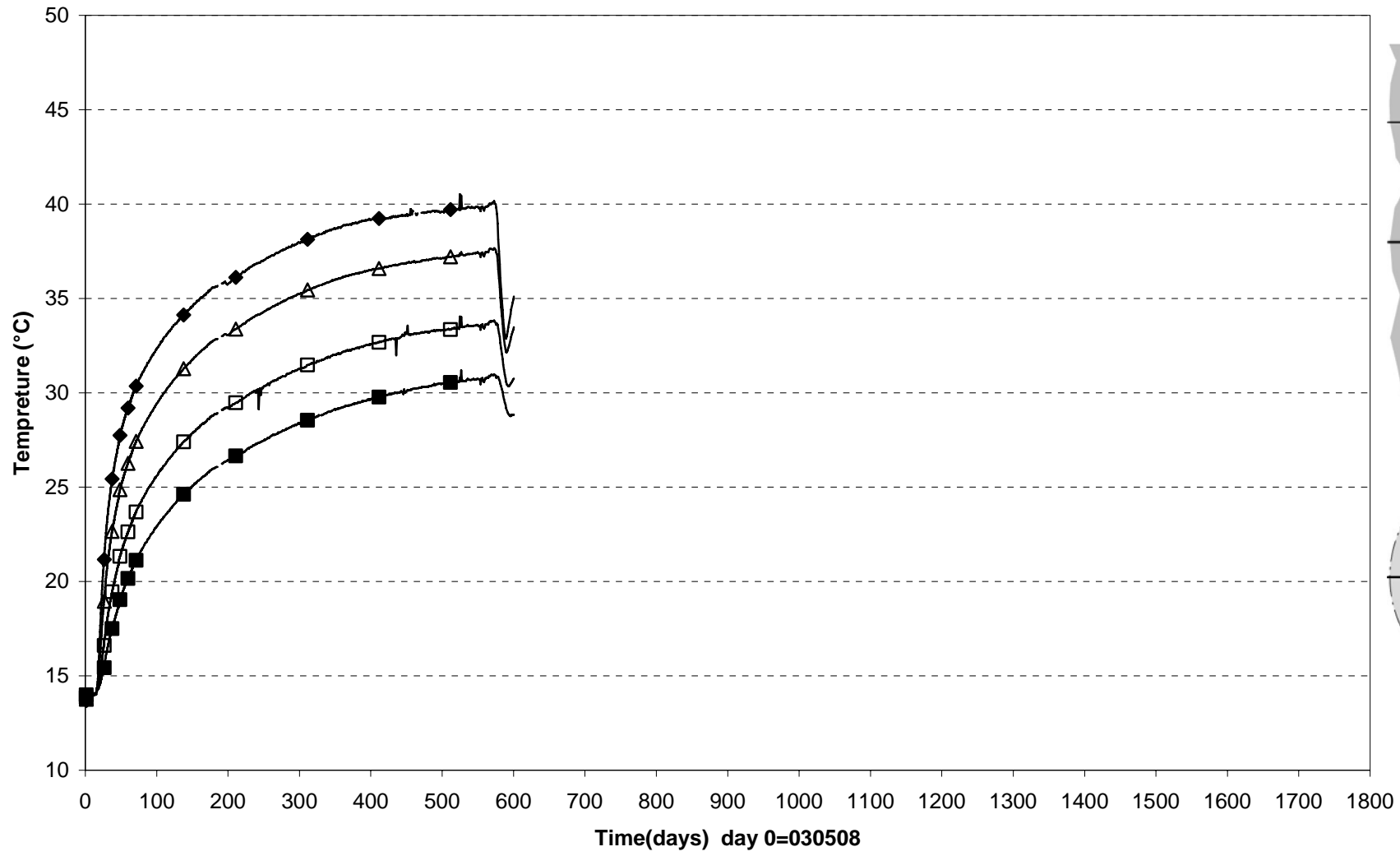

■ TR6011(-1.0\0°\ 0.0) □ TR6012(-0.5\0°\ 0.0) △ TR6013(-0.20\0°\ 0.0) ◆ TR6014(0.0\0°\ 0.0)

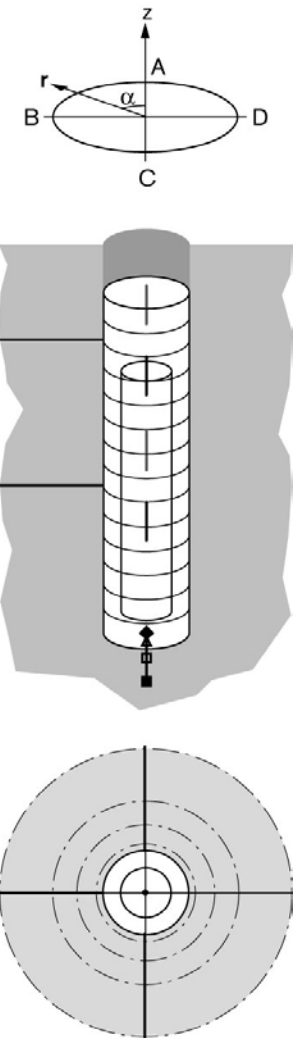

Prototype\Rock\Hole 6 \ Level 3,0 m (030508-071201)  
 Temperature - Pentronic

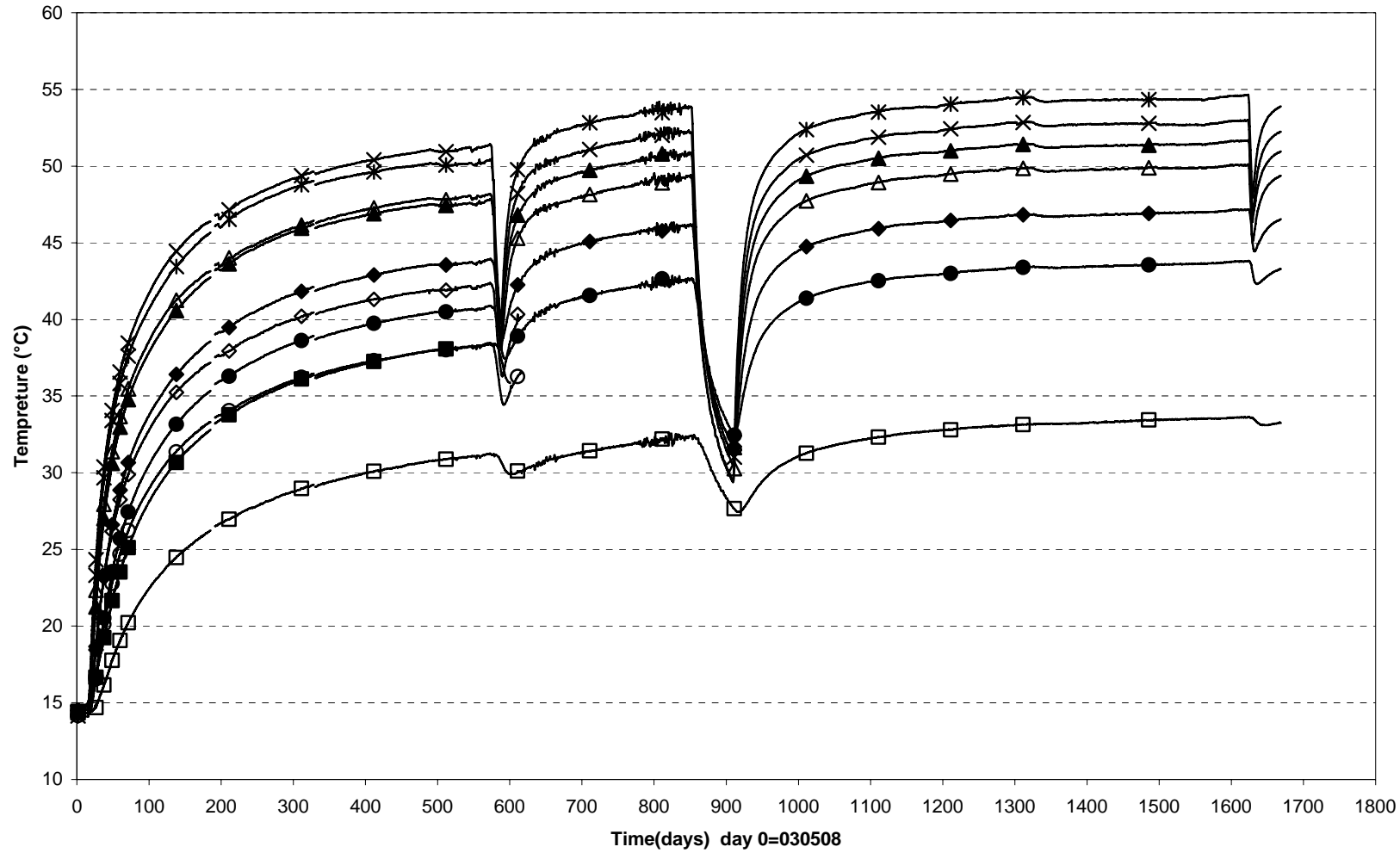

- TR6041(3.0\79°\ 3.075)    ○ TR6042(3.0\79°\ 1.975)    ◇ TR6043(3.0\79°\ 1.475)    △ TR6044(3.0\79°\ 1.075)    × TR6045(3.0\79°\ 0.875)
- TR6051(3.0\347°\3.075)    ● TR6052(3.0\347°\1.975)    ◆ TR6053(3.0\347°\1.475)    ▲ TR6054(3.0\347°\1.075)    \* TR6055(3.0\347°\0.875)

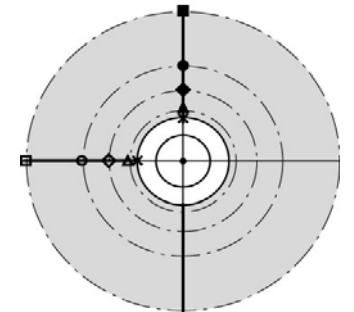
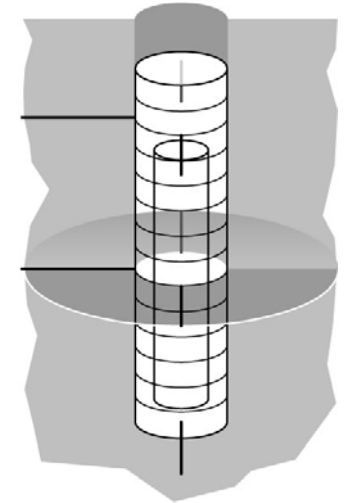
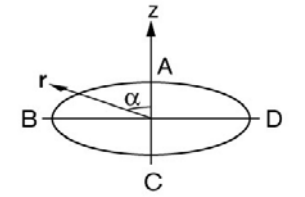

Prototype\Rock\Hole 6\ Level 6,0 m (030508-071201)  
 Temperature - Pentronic

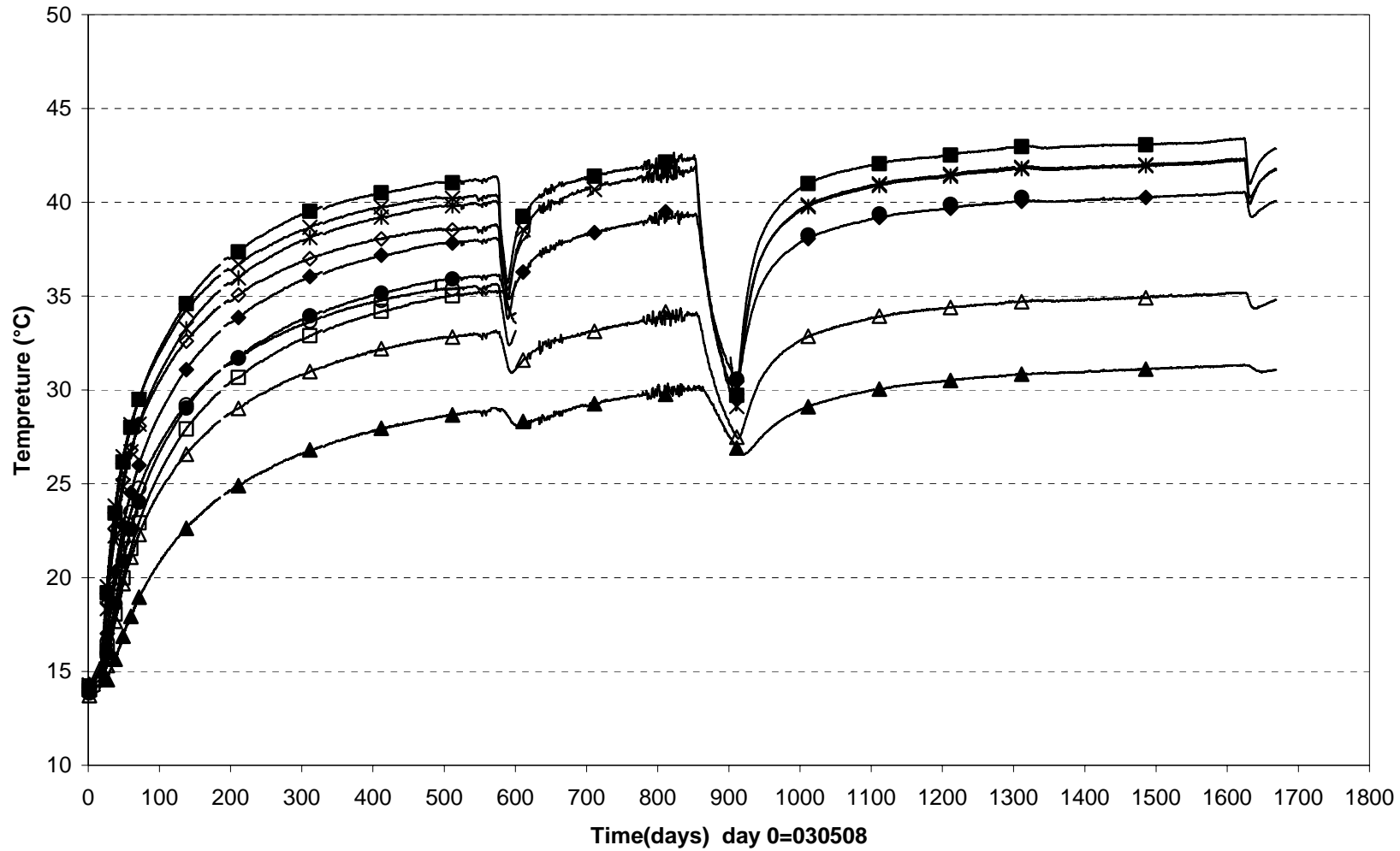

▲ TR6021(6.0\79°\ 3.075)    △ TR6022(6.0\79°\ 1.975)    ○ TR6023(6.0\79°\ 1.475)    ◇ TR6024(6.0\79°\ 1.075)    × TR6025(6.0\79°\ 0.875)  
 □ TR6031(6.0\349°\ 3.075)    ● TR6032(6.0\349°\ 1.975)    ◆ TR6033(6.0\349°\ 1.475)    ✱ TR6034(6.0\349°\ 1.075)    ■ TR6035(6.0\349°\ 0.875)

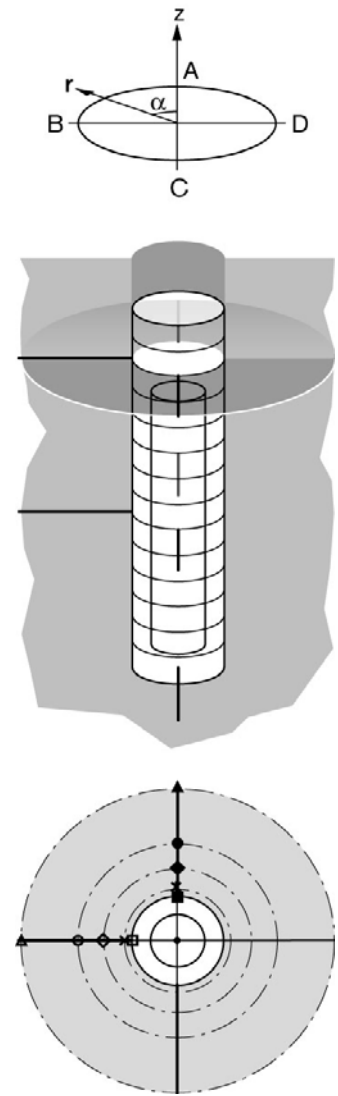

Prototype\Hole 6 (030508-071201)  
Canister power

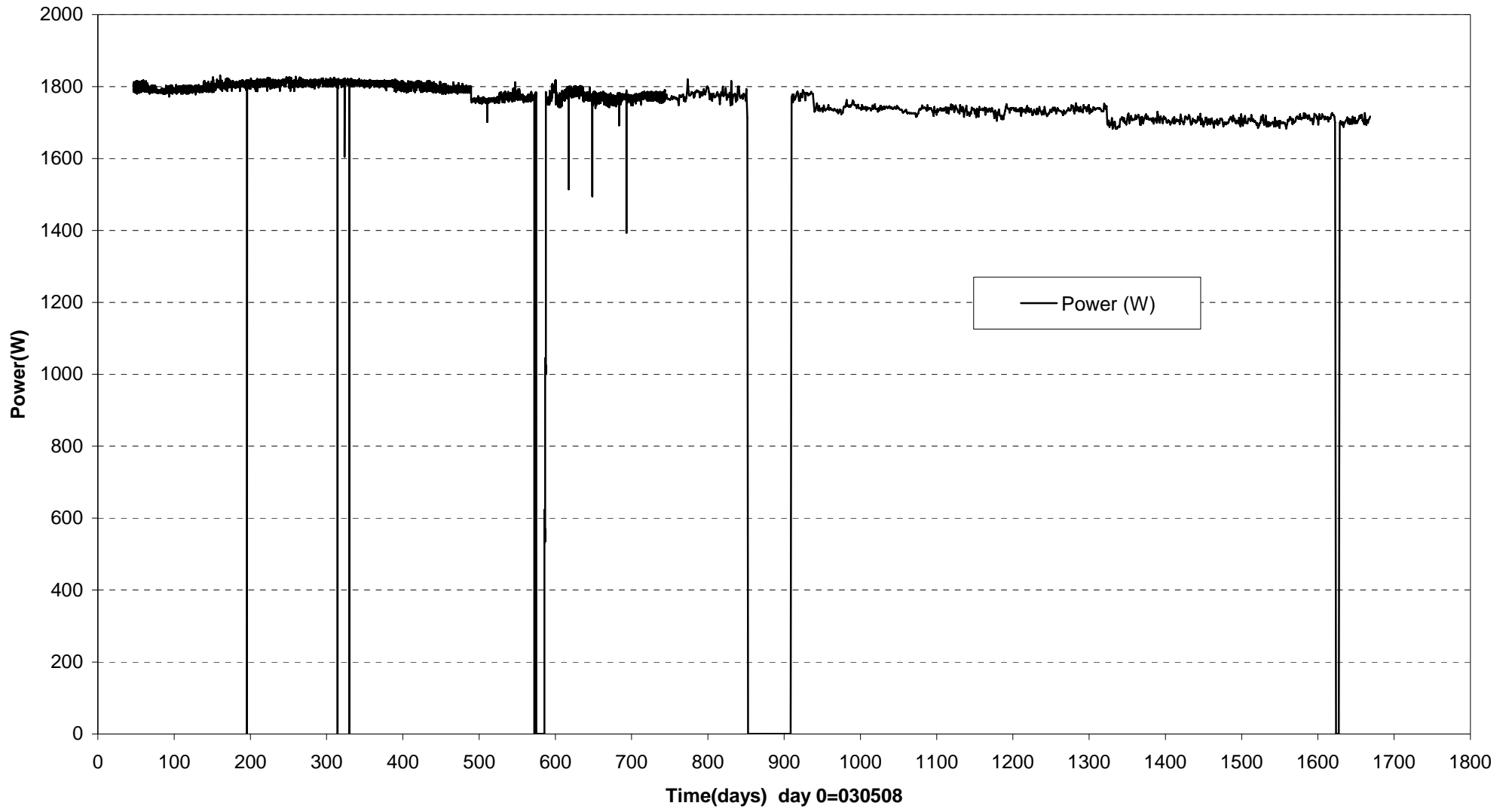



Prototype\ Hole 6 \Canister (030508-070601)  
 Max. temperature on the canister surface - Optical fiber cables

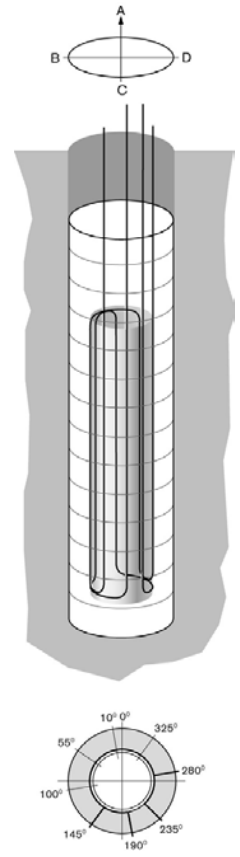
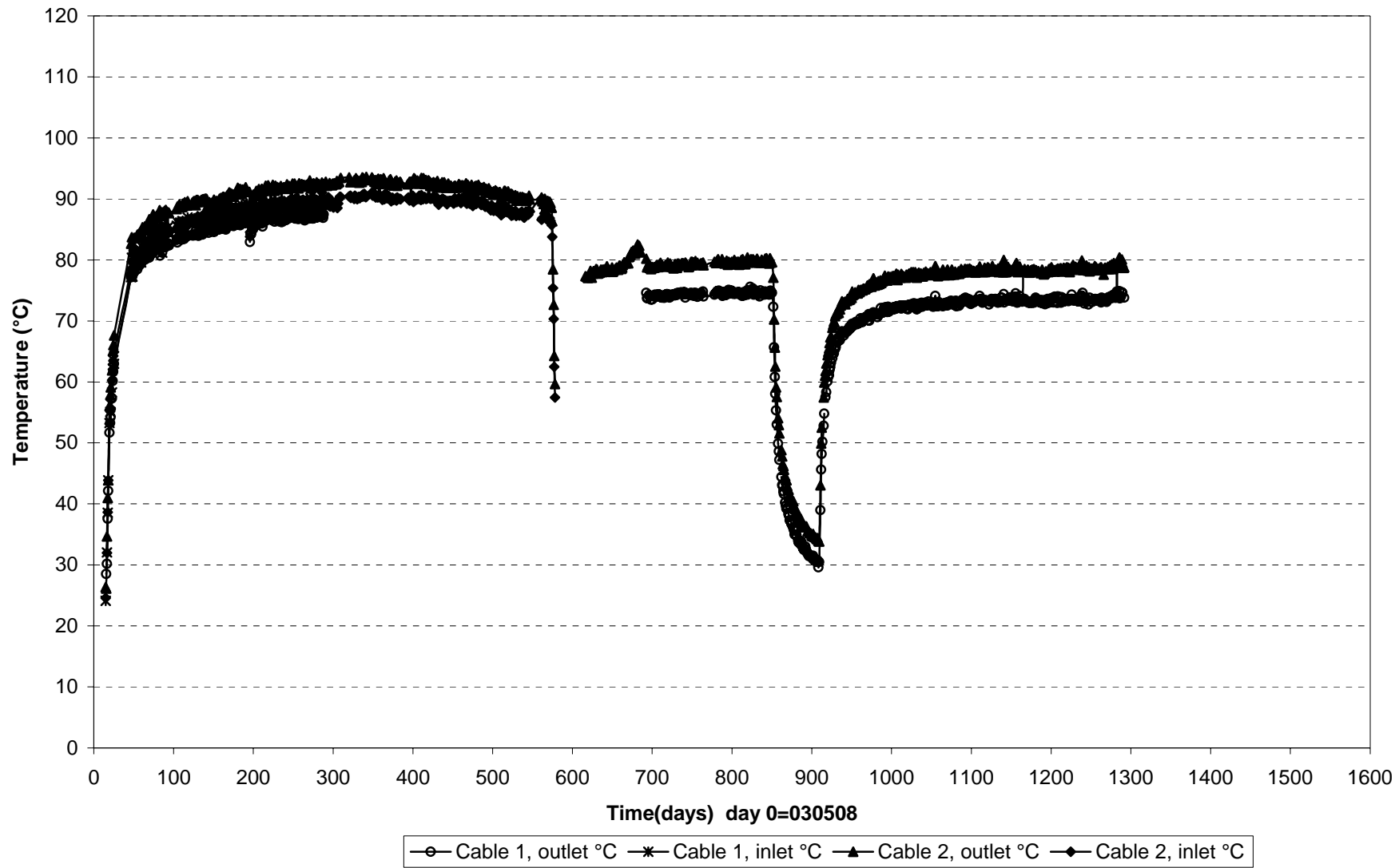

**Temperature profile on the canister surface-No6 (061119)**  
**Optical fiber cables**

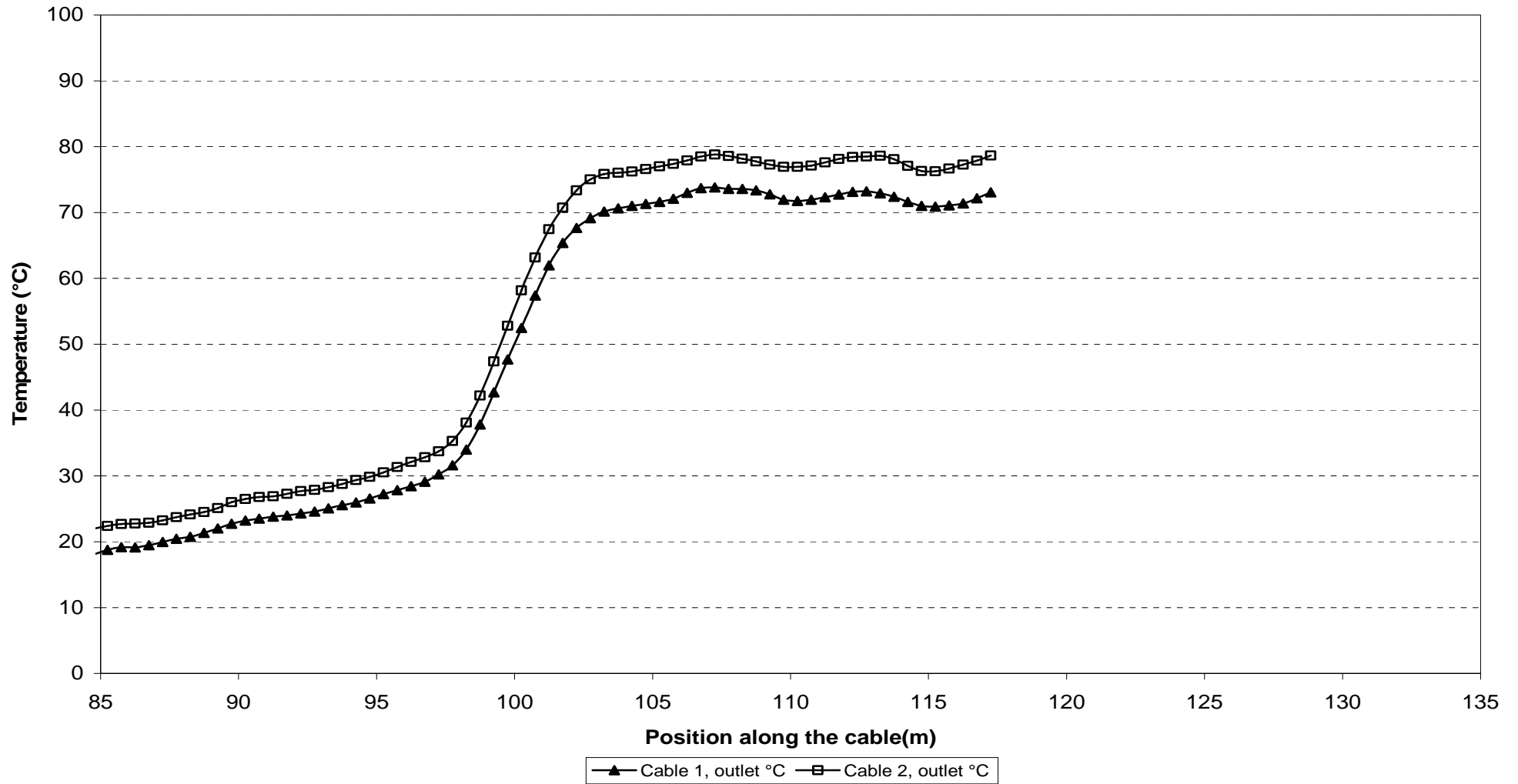

Prototype\Hole 6 \On the canister surface (030508-071201)  
 Temperature - Pentronic

