

**Technical Report**

**TR-08-10**

## **Äspö Hard Rock Laboratory**

**Annual report 2007**

Svensk Kärnbränslehantering AB

April 2008

**Svensk Kärnbränslehantering AB**

Swedish Nuclear Fuel  
and Waste Management Co  
Box 250, SE-101 24 Stockholm  
Tel +46 8 459 84 00



# **Äspö Hard Rock Laboratory**

## **Annual report 2007**

Svensk Kärnbränslehantering AB

April 2008

# Abstract

The Äspö Hard Rock Laboratory (HRL) is an important part of SKB's work with the design and construction of a deep geological repository for the final disposal of spent nuclear fuel. Äspö HRL is located in the Simpevarp area in the municipality of Oskarshamn. One of the fundamental reasons behind SKB's decision to construct an underground laboratory was to create opportunities for research, development and demonstration in a realistic and undisturbed rock environment down to repository depth. The underground part of the laboratory consists of a tunnel from the Simpevarp peninsula to the southern part of Äspö where the tunnel continues in a spiral down to a depth of 460 m. Äspö HRL has been in operation since 1995 and considerable international interest has been shown in its research, as well as in the development and demonstration tasks. A summary of the work performed at Äspö HRL during 2007 is given below.

## **Geoscience**

Geoscientific research is a basic activity at Äspö HRL. The aim of the current studies is to develop geoscientific models of the Äspö HRL and increase the understanding of the rock mass properties as well as knowledge of applicable methods of measurement. The main task within the geoscientific field is the development of the Äspö Site Descriptive Model (SDM) integrating information from the different fields. The main activities in the geoscientific fields have been: (1) Geology – besides mapping of rock surfaces and drill cores a feasibility study concerning geological mapping techniques is performed, (2) Hydrogeology – completion of the modelling work for the detailed hydro-structural model for the –450 m level and monitoring/storage of data in the computerised Hydro Monitoring System, (3) Geochemistry – sampling of groundwater in the yearly campaign and for specific experiments and (4) Rock Mechanics – field work to determine the stress levels at which core dishing occur followed by numerical modelling.

## **Natural barriers**

At Äspö HRL, experiments are performed under the conditions that are expected to prevail at repository depth. The experiments are related to the rock, its properties and in situ environmental conditions. The aim is to provide information about the long-term function of natural and repository barriers. Experiments are performed to develop and test methods and models for the description of groundwater flow, radionuclide migration, and chemical conditions at repository depth. The programme includes projects which aim to determine parameter values that are required as input to the conceptual and numerical models.

A programme has been defined for tracer tests at different experimental scales, the so-called *Tracer Retention Understanding Experiments* (True). The overall objectives of the experiments are to gain a better understanding of the processes which govern the retention of radionuclides transported in crystalline rock and to increase the credibility of models used for radionuclide transport calculations. During 2007, work has been performed in the projects: *True Block Scale Continuation* (the final report was printed in May 2007), *True-1 Continuation* (writing a series of papers where the first two papers have been published) and *True-1 Completion* (focus on the over-coring of two boreholes whereas the previous years have been focused on complementary tracer tests at the True-1 site).

The *Long Term Sorption Diffusion Experiment* complements the diffusion and sorption experiments performed in the laboratory, and is a natural extension of the True-experiments. The in situ sorption diffusion experiment was started in September 2006 and on-line measurement of the concentration of the gamma emitting tracers was made. After injection of epoxy resin the over-coring were completed in the beginning of May 2007. The over-coring turned out successfully and a 1.1 meter long and 278 mm diameter core was retrieved in one piece.

In total 34 sample cores have been drilled from the fracture surface on the core stub and from the matrix rock surrounding the test section. The sample cores have been scanned to get a first measure of the total activity and analyses of thin slices cut from the sampled cores are ongoing.

In the *Colloid Project* the stability and mobility of colloids, bentonite clay as a source for colloid generation and the potential of colloids to enhance radionuclide transport are studied. In the laboratory the stability of bentonite colloids have been studied under different conditions, for example different pH, ionic strength, temperature and exposure of irradiation. In Äspö groundwater the bentonite colloids are found to be instable mainly due to the high salinities. The results from performed transport experiments in laboratory indicate that the transport of bentonite colloids in water bearing fractures are dominated by the smaller colloids in the size distribution.

Microorganisms interact with their surroundings and in some cases they greatly modify the characteristics of their environment. Several such interactions may have a significant influence on the function of a future repository for spent fuel, and are therefore studied in the *Microbe Projects*. In the microbe laboratory, located at the -450 m level in Äspö HRL, studies of microbial processes are on-going within several projects. Bio-mobilisation and bio-immobilisation of radionuclides are studied in *Micomig* and microbial effects on the chemical stability of deep groundwater environments in *Micored*.

The project *Matrix Fluid Chemistry Continuation* focuses on the small-scale micro-fractures in the rock matrix which facilitate the migration of matrix waters. Understanding of the migration of groundwater, and its changing chemistry, is important for repository performance. Data from hydraulic testing of fracture-free and fracture-containing borehole sections in the matrix borehole are available. However, because of time constraints the compilation and reporting of data have been delayed and only some of the matrix pore water analytical data have been presented.

The *Padamot Continuation* project include developments of analytical techniques for uranium series analyses applied on fracture mineral samples and focus on the use of these analyses for determination of the redox conditions during glacial and postglacial time. The uranium series analyses are carried out on samples taken from a drill core at Äspö. The results so far are very promising in that the samples seem to mirror the redox front, both mobilisation and deposition of uranium are shown.

The basic idea behind the project *Fe-oxides in fractures* is to examine Fe-oxide fracture linings, in order to explore suitable palaeo-indicators and their formation conditions. At the same time, information about trace component uptake can be obtained from natural material as well as from studies in the laboratory under controlled conditions. The main activity carried out in 2007 involved the major analytical part of the continuation phase of the project entitled: 'To establish the penetration depth of oxidising waters below ground surface'. Although the study is not complete, the results suggest that iron oxides have formed at low-temperature down to 50 m below surface and possibly even down to a depth of approximately 90 m.

The *Single well injection withdrawal (Swiw) test with synthetic groundwater* constitutes a complement to the tests and studies performed on the processes governing retention of radionuclides in the rock, e.g. the True experiments. A feasibility study has been carried out to evaluate the possibility of performing Swiw-tests at the True Block Scale Site. The study shows that the site would be suitable. However, the on-going work with a new tunnel in the vicinity blocks the site and the hydraulic conditions at the site may be altered significantly. Swiw tests at that site may therefore be unsuitable or impossible to perform. Hence, a new site may be necessary to find.

Important goals of the activities at Äspö HRL are the evaluation of the usefulness and reliability of different models and the development and testing of methods to determine parameter values required as input to the models. An important part of this work is performed in the *Task Force on Modelling of Groundwater Flow and Transport of Solutes*. The work in the Task Force is closely tied to on-going and planned experiments at the Äspö HRL. During 2007, the work in Task 6 (performance assessment modelling using site characterisation data) has mainly been in

reporting. Task 7 (long-term pumping test in Olkiluoto, Finland) has been further defined and modelling work as well as reporting is on-going. In addition, a Meta Task (compilation of comments from reviewers) with the intention to constitute advice to future tasks has been performed.

### **Engineered barriers**

At Äspö HRL, an important goal is to demonstrate technology for and the function of important parts of the repository system. This implies translation of current scientific knowledge and state-of-the-art technology into engineering practice applicable in a real repository. It is important that development, testing and demonstration of methods and procedures are conducted under realistic conditions and at an appropriate scale. A number of large-scale field experiments and supporting activities are therefore carried out at Äspö HRL. The experiments focus on different aspects of engineering technology and performance testing.

The *Prototype Repository* is a demonstration of the integrated function of the repository and provides a full-scale reference for tests of predictive models concerning individual components as well as the complete repository system. The layout involves altogether six deposition holes, four in an inner section and two in an outer. During 2007 the monitoring of relative humidity, total pressure and temperature in different parts of the test area has continued. The data indicate that the buffer around one of the canisters (number 1) in the inner section is close to saturated whereas the buffer above and under the canister are not saturated.

The *Long Term Test of Buffer Material (Lot-experiment)* aims at validating models and hypotheses concerning physical properties in a bentonite buffer material and of related processes regarding microbiology, radionuclide transport, copper corrosion and gas transport under conditions similar to those in a KBS-3 repository. The analyses of the long-term test parcel (A2) that was successively extracted in beginning of 2006 have shown that the buffer was saturated. The mineralogical analyses on the test parcel have been finalised and were presented in a workshop in November. The three remaining test parcels have functioned without any disturbances.

The objective of the project *Alternative Buffer Materials* is to study clay materials that in laboratory tests have shown to be conceivable buffer materials. Three parcels with different combinations of buffer materials were installed in boreholes in Äspö HRL in 2006. The parcels and the experimental set-up are similar to that used in the *Lot-experiment*. The power to the heaters in two parcels has continuously been adjusted to carefully raise the buffer temperature to the goal value of 130°C. The heaters in the last parcel will be activated when the buffer is fully saturated. The first parcel will be retrieved after 1–2 years operation and the second after 2–4 years. The third parcel will be in operation for at least five years.

The *Backfill and Plug Test* is a test of the hydraulic and mechanical function of different backfill materials, emplacement methods and a full-scale plug. The inner part of the drift is backfilled with a mixture of bentonite and crushed rock and the outer part is filled with crushed rock. The compressibility of the backfill has been measured by a stepwise pressurisation of pressure cylinders (diameter 0.5 m), one at the ceiling and one at the floor in both the 30/70 and the crushed rock backfill. In spite of the long time that has elapsed since installation, these devices worked very well. The results are not yet fully evaluated but preliminary results indicate that the compressibility was very high in all cases except at the floor of the crushed rock backfill.

The *Canister Retrieval Test*, is located in the main test area at the –420 m level, and aimed to demonstrate readiness for recovering emplaced canisters even after the time when the surrounding bentonite buffer is fully saturated. In January 2006 the canister was successively retrieved. The saturation phase had, at that time, been running for more than five years with continuous measurements of the wetting process, temperature, stresses and strains. During 2007 the heaters, that had severe problems during the test, have been analysed and the conclusion was that the loss of power to the heaters was due to the failure of the external heater power cables. Analyses of the buffer and canister are ongoing.

The *Temperature Buffer Test* aims at improving our current understanding of the thermo-hydro-mechanical behaviour of buffers with a temperature around and above 100°C during the water saturation transient. The experiment has generated data since the start in 2003. The evaluation of THM processes is made through analyses of sensors data and numerical modelling. In parallel, evaluation and numerical modelling are made of lab-scale mock-up tests performed by CEA in France. The requirement for the planned gas injection test of a complete water saturation of the upper buffer is achieved and the hydration of the sand shield started during the year. The power output from the heaters was changed during the year to promote mineralogical alternation processes.

SKB and Posiva are co-operating on a programme for the *KBS-3 Method with Horizontal Emplacement* (KBS-3H). A full scale demonstration at Äspö HRL is in progress. The demonstration comprises two deposition holes: (1) one short hole (15 m) which will be used for construction and testing of a low-pH shotcrete plug and (2) one long hole (95 m) which will primarily be used for demonstration of the deposition equipment and for evaluation of the chosen excavation method. A lot of work has been performed in the project and the conclusions are that the KBS-3H concept seems to be feasible. A technical design of the concept has been developed and a preliminary safety assessment based on Olkiluoto data has been performed. However, there are still several uncertainties identified e.g. erosion and piping of bentonite, iron-bentonite interaction which have to be resolved. SKB and Posiva have decided to continue the development of the KBS-3H concept during the two coming years.

The aim of the *Large Scale Gas Injection Test* is to perform gas injection tests in a full-scale KBS-3 deposition hole. The installation phase, including the deposition of canister and buffer, was finalised in 2005. Water is artificially supplied and the evolution of the saturation of the buffer is continuously monitored. Hydraulic and gas injection tests were started in May 2007. Analysis of the gas injection data suggest that gas starts to flow into the buffer at a pressure of about 775 kPa, which is much lower than the expected gas entry pressure for intact bentonite. It therefore seems likely, that in the test, gas is flowing between the bentonite and the canister and possibly between bentonite blocks.

The objective of the project *In situ Corrosion Testing of Miniature Canisters* is to obtain a better understanding of the corrosion processes inside a failed canister. In Äspö HRL in situ experiments are performed with miniature copper canisters with cast iron inserts. The canisters will be exposed to both natural reducing groundwater and groundwater which has been conditioned by bentonite. In the beginning of 2007 all five canisters were installed in the boreholes. Data relating to the chemical conditions, corrosion of the test specimens and dimensional changes are continuously collected and analysed.

In the project *Cleaning and Sealing of Investigation Boreholes* the best available techniques are to be identified and demonstrated. In order to obtain data on the properties of the rock, boreholes are drilled during site investigations. These investigation boreholes must be cleaned and sealed, no later than at the closure of the repository. A complete sealing concept has been developed and a large-scale test was made in 2005 in a borehole at Olkiluoto in Finland. To simulate the sealing of the upper wider parts of boreholes, copper and quartz/cement plugs have been installed in two boreholes at the ground surface. In addition, plugs in shorter boreholes at the -450 m level in Äspö HRL have been successfully installed.

The *Task Force on Engineered Barrier Systems* was activated in 2004. The Task Force starts with a first phase of four years. This phase addresses two tasks: (1) THM processes and (2) gas migration in buffer material. However, in the end of 2006 it was decided to start a parallel Task Force that deals with geochemical processes in engineered barriers. During 2007, two Task Force meetings have been held. In Benchmark 1 (laboratory tests) the THM modelling is finalised and the modelling of the gas breakthrough is on-going. In Benchmark 2 (large scale field tests) modelling of the URL tests has been performed and the modelling of the Äspö HRL tests has been initiated. The geochemical Task Force has identified the need to adjust existing general geochemical modelling tools in order to successfully apply them to bentonite modelling.

### ***Äspö facility***

An important part of the activities at the Äspö facility is the administration, operation, and maintenance of instruments as well as the development of investigation methods. The main goal of the operation is to provide a safe and environmentally sound facility for everybody working or visiting the Äspö HRL. The goal of an operational time of 98% for the underground laboratory was exceeded in both 2006 and 2007. The inauguration of the Bentonite Laboratory took place in March 2007 and the laboratory is now working very well and provides good conditions for studies of buffer and backfill materials. In the laboratory for example different methods and techniques for installation of pellets and blocks in deposition tunnels have been tested. The public relations and visitor services group is responsible for presenting information about SKB and its facilities. During the year 2007 the three facilities in Oskarshamn and the site investigation activities in Oskarshamn were visited by about 15,000 visitors. In addition, a number of special events for example the guided summer-tours "Urberg 500" and the running competition in Äspö HRL have been arranged and attracted a lot of visitors.

### ***Environmental research***

Äspö Environmental Research Foundation was founded 1996 on the initiative of local and regional interested parties. The aim was to make the underground laboratory at Äspö and its resources available for national and international environmental research. The Äspö Research School started in 2002 and the research carried out focuses on environmental hydrogeochemistry. Current studies focus on the behaviour of selected chemical elements (for example niobium and uranium) in surface and groundwater, on spatial and temporal hydrochemical patterns in streams and lakes in Forsmark and Laxemar, and on the behaviour of elements during litter decomposition. Most of these studies will be included in Ph.D. theses.

### ***International co-operation***

In addition to SKB, nine organisations from eight countries co-operated on the activities at Äspö HRL during 2007. Six of them; Andra, BMWi, CRIEPI, JAEA, NWMO and Posiva together with SKB form the Äspö International Joint Committee which is responsible for the co-ordination of the experimental work arising from the international participation. Most of the organisations participating in the Äspö HRL co-operation are interested in groundwater flow, radionuclide transport and rock characterisation. Several of the organisations are participating in the experimental work at Äspö HRL as well as in the two Äspö Task Forces: (1) Task Force on Modelling of Groundwater Flow and Transport of Solutes and (2) Task Force on Engineered Barrier Systems.

# Sammanfattning

Äspölaboratoriet i Simpevarp i Oskarshamns kommun är en viktig del i SKB:s arbete med utformning, byggande (och drift) av ett slutförvar för använt kärnbränsle. Ett av de grundläggande skälen till SKB:s beslut att anlägga ett underjordslaboratorium var att skapa förutsättningar för forskning, utveckling och demonstration i en realistisk och ostörd bergmiljö på förvarsdjup. Underjordslaboratoriet utgörs av en tunnel från Simpevarpshalvön till södra delen av Äspö där tunneln fortsätter i en spiral ner till 460 meters djup. Äspölaboratoriet har varit i drift sedan 1995 och verksamheten har väckt stort internationellt intresse. Här följer en sammanfattning av det arbete som bedrivits vid Äspölaboratoriet under 2007.

## Geovetenskap

Forskning inom geovetenskap är en grundläggande del av arbetet vid Äspölaboratoriet. Det huvudsakliga målet med de pågående studierna är att utveckla geovetenskapliga modeller samt att öka förståelsen för bergmassans egenskaper och kunskapen om användbara mätmetoder. Den huvudsakliga uppgiften inom det geovetenskapliga området är utvecklingen av en platsbeskrivande modell för Äspö där information från olika ämnesområden integreras. De huvudsakliga aktiviteterna inom de olika områdena har varit: (1) Geologi – förutom kartering av bergytter och borrhål genomförs en förstudie av geologiska karteringsmetoder, (2) Hydrogeologi – slutförande av modelleringsarbetet med den detaljerade hydrostrukturella modellen för -450 m nivån och övervakning och lagring av data i det datoriserade hydro-monitoringssystemet, (3) Geokemi – den årliga provtagningen av grundvatten samt provtagning för specifika experiment och (4) Bergmekanik – fältarbete för att bestämma vilka spänningsnivåer som erfordras för att förorsaka spänningsinducerad uppsprickning av borkärnan ("core dishing") samt efterföljande numerisk modellering av processen.

## Naturliga barriärer

I Äspölaboratoriet genomförs experimenten vid förhållanden som liknar de som förväntas råda på förvarsdjup. Experimenten kopplar till berget, dess egenskaper och in situ-förhållanden. Målet med de pågående experimenten är att ge information om hur de naturliga och tekniska barriärerna fungerar i ett långtidsperspektiv. Ett viktigt syfte med verksamheten vid Äspölaboratoriet är att vidareutveckla och testa beräkningsmodeller för grundvattenströmning, radionuklidtransport och kemiska processer på förvarsnivå. I programmet ingår att bestämma värden på de parametrar som krävs som indata till konceptuella och numeriska modeller.

Bergets förmåga att fördröja transport av spårämnen studeras i olika skalor i *True-försöken*. Syftet är att öka förståelsen för de processer som styr fördröjningen av radionuklider i kristallint berg samt att öka tillförlitligheten hos de modeller som används för beräkning av radionuklidtransport. Under 2007 har arbete skett inom delprojekten: "*True Block Scale Continuation*" (slutrapporten trycktes i maj 2007), "*True-1 Continuation*" (framtagning av en artikelserie där de första två artiklarna har publicerats) och "*True-1 Completion*" (fokus på överborrning av två borrhål medan fokus under tidigare år har legat på kompletterande spårämnesförsök vid True-1).

*LTDE-försöket* är ett komplement till de sorptions- och diffusionsförsök som genomförts i laboratorium och är också en utvidgning av de experiment som genomförts inom True-programmet. Sorptions- och diffusionsförsöket in situ startade i september 2006 och koncentrationen av gammastrålande spårämnen direktmättes. Efter injicering av epoxi slutfördes överborrningen i början på maj 2007. Överborrningen genomfördes med lyckat resultat och en borkärna med längden 1,1 m och diametern 278 mm kunde återtas i en del. Totalt har 34 provkärnor borrats från sprickytan på borkärnan och från den omkringliggande bergmatrisen. Provkärnorna har scannats för att få ett första mått på den totala aktiviteten och analyser av tunna skivor från de provtagna kärnorna pågår.



I *Kolloidprojektet* studeras kolloiders stabilitet och rörlighet, bentonitens betydelse som källa för bildandet av kolloider och risken för att kolloider påskyndar radionuklidtransporten. Stabiliteten hos bentonitkolloider har studerats i laboratorium under olika förhållanden t ex vid olika pH, jonstyrka, temperatur och under bestrålning. Bentonitkolloiderna har visat sig vara instabila i grundvattnet i Äspö, huvudsakligen på grund av höga salthalter. Resultatet från genomförda transportexperiment i laboratoriemiljö indikerar att transporten av bentonitkolloider i vattenförande sprickor domineras av mindre kolloider.

Mikroorganismer samverkar med sin omgivning och kan i vissa fall ha en betydande inverkan på förhållandena där. Detta kan vara av betydelse för hur ett framtida förvar för använt bränsle fungerar och studeras därför inom *Mikrobprojektet*. I mikrolaboratoriet på 450 m djup i Äspö pågår studier av mikrobiella processer inom flera projekt. Mikrobers förmåga att mobilisera och binda radionuklider studeras i projektet Micomig, och i projektet Micored studeras mikrobiella effekter på den kemiska stabiliteten i miljöer med djupt grundvatten.

I fortsättningen av *Matrisförsöket* är fokus på hur de småskaliga mikrosprickorna i bergmatrisen underlättar matrisporvattnets rörelse. Förståelsen av grundvattnets rörelse och förändringar i vattenkemin är viktig för slutförvarets funktion. Data från de hydrauliska testerna av sprickfria och uppspruckna sektioner i matrisborrhålet finns tillgängliga. Begränsningar i tid har emellertid medfört att sammanställningen och rapporteringen av data blivit försenad och endast ett fåtal analysdata för matrisporvatten har presenterats.

I fortsättningsprojektet av *Padamot* ingår utveckling av analytiska tekniker för uranserieanalyser på sprickmineralprov med fokus på användningen av dessa analyser för bestämningen av redoxförhållanden under glaciala och postglaciala förhållanden. Uranserieanalyserna har genomförts på prov tagna från en borrhäla från Äspö. Erhållna resultat verkar lovande i det avseende att proven återspeglar redoxfronten, både mobilisering och fastläggning av uran kan påvisas.

I projektet *Järnoxider i sprickor* undersöks järnoxidtäckta sprickytor för att hitta lämpliga palaeoindikatorer och beskriva under vilka förhållande dessa bildas. På samma gång kan information inhämtas om spårämnesupptag både från naturliga material såväl som från studier i laboratoriet under kontrollerade förhållanden. Under 2007 har arbetet huvudsakligen fokuserat på den analytiska delen av projektets fortsättningsfas med titeln: 'Fastställande av penetrationsdjupet för oxiderande vatten under markytan'. Även om studien inte är färdigställd, indikerar resultaten att järnoxider har bildats vid låga temperaturer ner till 50 meters djup och eventuellt även ner till ca 90 m under markytan.

*Single well injection withdrawal (Swiw) test with synthetic groundwater* utgör ett komplement till testerna och studierna som utförts rörande de processer som styr fördröjningen av radionuklider i berget, till exempel True-experimenten. En förstudie har genomförts som visar att platsen "True Block Scale" skulle vara lämplig för att utföra Swiw-tester. Det pågående arbetet med en ny tunnel i närheten blockerar dock platsen och de hydrauliska förhållandena på platsen kan komma att förändras markant. Swiw-tester på platsen kan därför komma bli olämpliga eller omöjliga att genomföra och det kan bli nödvändigt att hitta en ny plats.

Aktiviteterna vid Äspölaboratoriet omfattar projekt med syfte att utvärdera användbarhet och tillförlitlighet hos olika beräkningsmodeller. I arbetet ingår även att utveckla och prova metoder för att bestämma parametervärden som krävs som indata till modellerna. En viktig del av detta arbete genomförs i ett internationellt samarbetsprojekt "*Äspö Task Force on Modelling of Groundwater Flow and Transport of Solutes*". Arbetet i projektet har anknytning till pågående och planerade experiment vid Äspölaboratoriet. Under 2007 har arbetet inom "Task 6" (användandet av data från platsundersökning i modellering för säkerhetsanalys) huvudsakligen legat i rapportering. "Task 7" (pumptester under lång tid i Olkiluoto, Finland) har ytterligare definierats och modelleringsarbete så väl som rapportering pågår. Dessutom har en "Meta Task" (en sammanställning av kommentarer från granskare) med målet att ge råd till framtida "Tasks" genomförts.

## **Tekniska barriärer**

Verksamheten vid Äspölaboratoriet har som mål att demonstrera funktionen hos förvarets delar. Detta innebär att vetenskapliga och teknologiska kunskaper används praktiskt i arbetet med att utveckla, testa och demonstrera de metoder och tillvägagångssätt som kan komma att användas vid uppförandet av ett slutförvar. Det är viktigt att möjlighet ges att testa och demonstrera hur förvarets delar kommer att utvecklas under realistiska förhållanden. Ett flertal projekt i full skala, liksom stödjande aktiviteter, pågår vid Äspölaboratoriet. Experimenten fokuserar på olika aspekter av ingenjörsteknik och funktionstester.

I *Prototypförvaret* pågår en demonstration av den integrerade funktionen hos förvarets barriärer. Prototypförvaret utgör dessutom en fullskalig referens för prediktiv modellering av slutförvaret och barriärernas utveckling. Prototypförvaret omfattar totalt sex deponeringshåll, fyra i en inre tunnelsektion och två i en yttre. Under 2007 har fortsatta mätningar av relativ fuktighet, totalt tryck och temperatur i olika delar av testområdet genomförts. Data indikerar att bufferten runt en av kapslarna (nummer 1) i den inre tunnelsektionen är nära vattenmättad medan bufferten över och under kapseln inte nått vattenmättad.

I *Lot-försöket* genomförs långtidsförsök på buffertmaterial som syftar till att validera modeller och hypoteser som beskriver bentonitbuffertens fysikaliska egenskaper och processer relaterade till mikrobiologi, radionuklidtransport, kopparkorrosion och gastransport under förhållanden som liknar dem i ett KBS-3-förvar. Analyser av långtidsförsökets testpaket (A2), som togs upp i början på 2006, har visat att bufferten var mättad. Mineralogiska analyser har genomförts av testpaketet och resultaten presenterades på en workshop i november. De tre återstående testpaketen har fungerat utan några störningar.

Målet med projektet *Alternativa buffertmaterial* är att studera olika lermaterial som i laboratorietester har visat sig vara tänkbara buffertmaterial. Tre paket med olika kombinationer av lermaterial har installerats i borrhål i Äspölaboratoriet under 2006. Paketet och experimentuppställningen liknar de som används vid Lot-försöket. Effekten till värmarna i två av paketet har kontinuerligt justerats för att försiktigt höja temperaturen i bufferten till måltemperaturen 130 °C. Värmarna till det sista paketet kommer att aktiveras när bufferten är vattenmättad. Det första paketet kommer att återtas efter 1–2 år och det andra efter 2–4 år. Det tredje paketet kommer att vara i drift i minst fem år.

I *Återfyllningsförsöket* undersöker man den hydrauliska och mekaniska funktionen hos olika återfyllnadsmaterial. Försöket är också en demonstration av olika metoder för inplacering av återfyllnad och installation av tunnelförslutning. Sektionens innersta del är återfylld med en blandning av krossat berg och bentonit medan den yttre delen är återfylld med krossat berg. Återfyllnadsmaterialets kompressibilitet har mätts genom en stegvis ökning av trycket på tryckcylindern (diameter 0,5 m), en vid taket och en vid golvet i både 30/70 återfyllnaden och återfyllnaden med krossat berg. Trots den långa tid som förflutit sedan installation fungerar anordningarna mycket bra. Resultaten är ännu inte helt utvärderade, men de preliminära resultaten indikerar att kompressibiliteten var mycket hög utom vid golvet i återfyllnaden med krossat berg.

*Återtagsförsöket*, ligger i försöksområdet på 420 meters djup och syftar till att prova teknik för att återta kapslar efter det att den omgivande bentonitbufferten har vattenmättats. I januari 2006 genomfördes ett lyckat återtag av kapseln. Vattenmättnadsfasen hade då pågått i mer än fem år med kontinuerliga mätningar av fukthalt, temperatur, tryck och spänningar. Under 2007 har värmarna som hade allvarliga problem under försöket analyserats och slutsatsen är att problemet orsakades av att de yttre kapslarna var trasiga. Analyser av bufferten och kapseln pågår.

Syftet med *TBT-försöket* är att förbättra förståelsen av buffertens termiska och hydromekaniska utveckling under vattenuppmättnadsfasen vid temperaturer runt eller högre än 100 °C. Experimentet har genererat data sedan starten 2003. Utvärderingen av THM-processerna görs genom analyser av sensordata och genom numerisk modellering. Parallellt görs utvärdering och numerisk modellering av laboratorieförsök utförda av CEA i Frankrike. Förutsättningarna för

det planerade gasinjekteringsförsöket, med en fullständigt vattenmättad övre buffert, är nådd och bevätningen av sandskölden har påbörjats under året. Effekten från värmarna ändrades under året för att gynna mineralogiska omvandlingsprocesser.

Ett forskningsprogram för ett *KBS-3-förvar med horisontell deponering* (KBS-3H) genomförs som ett samarbetsprojekt mellan SKB och Posiva. En fullskaledemonstration av KBS-3H pågår nu i Äspölaboratoriet. Demonstrationen omfattar två deponeringshål: (1) ett kort hål (15 m) som ska användas för att installera och testa en betongplugg av lågalkalisk cement och (2) ett långt hål (95 m) som huvudsakligen ska användas för demonstration av deponeringsutrustning men även för utvärdering av schaktmetod. Ett omfattande arbete har genomförts i projektet och slutsatsen är att KBS-3H-konceptet verkar genomförbart. En teknisk utformning av konceptet har utvecklats och en preliminär säkerhetsanalys baserat på data från Olkiluoto har genomförts. Fortfarande återstår dock flera identifierade osäkerheter som måste lösas, t ex erosion och kanalbildning av bentonit, järn-bentonit-interaktioner. SKB och Posiva har beslutat att fortsätta utvecklingen av KBS-3H-konceptet under de kommande två åren.

Syftet med ett *Gasinjekteringsförsök i stor skala* är att studera gastransport i ett fullstort deponeringshål (KBS-3). Installationsfasen med deponering av kapsel och buffert avslutades under 2005. Vatten tillförs bufferten på konstgjord väg och utvecklingen av vattenmättnadsgraden i bufferten mäts kontinuerligt. Hydrauliska tester och gasinjekteringstester påbörjades i maj 2007. Analyser av gasinjekteringsdata antyder att gasen börjar flöda in i bufferten vid ett ungefärligt tryck på 775 kPa, vilket är mycket lägre än det förväntade trycket då gas börjar flöda in i intakt bentonit. Det verkar därför troligt att gas flödar mellan bentoniten och kapseln och möjligen även mellan bentonitblocken i det genomförda testet.

Målet med projektet *In situ-testning av korrosion av miniatyrkapslar* är att få en bättre förståelse av korrosionsprocesserna inuti en trasig kapsel. Vid Äspölaboratoriet genomförs in situexperiment med miniatyrkopparkapslar med gjutjärnsinsats där kopparkapslarna kommer att utsättas för både naturligt reducerande grundvatten och grundvatten som har jämviktats med bentonit under flera år. I början av 2007 var alla fem kapslar installerade i borrhålen. Data rörande kemiska förhållanden, korrosion av provbitar och ändringar i kapselns storlek mäts kontinuerligt och analyseras.

I projektet *Rensning och förslutning av undersökningsborrhål* ska bästa möjliga tillgängliga teknik identifieras och demonstreras. I platsundersökningarna borrar undersökningsborrhål och en noggrann karakterisering genomförs för att erhålla data på bergets egenskaper. Dessa borrhål måste rensas och pluggas senast när driften av slutförvaret avslutats. Ett fullständigt referenskoncept för förslutning av borrhål har utvecklats och ett storskaligt test i borrhål utfördes i Olkiluoto, Finland, under 2005. För att simulera förslutningen av de övre, vidare delarna av borrhålet har koppar och kvartscementpluggar installerats vid markytan i två borrhål och pluggar i kortare borrhål har framgångsrikt installerats på -450 m-nivån i Äspölaboratoriet.

Ett internationellt samarbetsprojekt *"Task Force on Engineered Barrier Systems"* återupptogs under 2004. Den första fasen av projektet, som beräknas pågå i fyra år, omfattar huvudsakligen två områden: (1) THM-processer och (2) gasmigration i buffertmaterial. Under 2006 beslutades det dock att starta upp en parallell "Task Force" som behandlar geokemiska processer i ingenjörbarriärer. Två "Task Force" möten har hållits under 2007. I "Benchmark 1" (laboratorietester) har THM-modelleringen avslutats och modelleringen av gasgenombrottet pågår. I "Benchmark 2" (storskaliga fälttest) har modellering av URL-testerna genomförts och modelleringen av Äspö-försöken har initierats. Behovet av att justera befintliga generella geokemiska modelleringsverktyg för att kunna applicera dem för bentonitmodellering har identifierats av "Task Force" geokemi.

### **Äspölaboratoriet**

En viktig del av verksamheten vid Äspöanläggningen är administration, drift och underhåll av instrument samt utveckling av undersökningsmetoder. Målet med driften av Äspöanläggningen är att garantera säkerheten för alla som arbetar eller besöker anläggningen samt att driva anläggningen på ett miljömässigt korrekt sätt. Målet med en tillgänglighet i laboratoriet på 98 % uppnåddes både under 2006 och 2007. Invigningen av bentonitlaboratoriet skedde i mars 2007 och laboratoriet fungerar nu mycket bra och tillhandahåller bra förhållanden för studier av buffert- och återfyllnadsmaterial. I laboratoriet har t ex olika metoder och tekniker för installation av pellets och block i deponeringstunnlar testats. Information och besöksgruppen vid Äspölaboratoriet är ansvariga för att ta fram information om SKB och dess anläggningar. Under 2007, besöktes de tre anläggningarna i Oskarshamn och platsundersökningarna i Oskarshamn av ungefär 15 000 besökare. Dessutom har ett antal speciella evenemang arrangerats som dragit till sig många besökare. Exempel på sådana evenemang är den guidade sommarvisningen ”Urberg 500” och löpartävlingen i Äspötunneln.

### **Miljöforskning**

Äspö Miljöforskningsstiftelse grundades 1996 på initiativ av lokala och regionala intressenter, med målsättningen att göra Äspölaboratoriet och dess resurser tillgängliga även för nationell och internationell miljöforskning. Äspö:s forskarskola startade 2002 och forskningen har fokuserat på miljöhydrogeokemi. Pågående studier fokuserar på beteendet av utvalda ämnen (till exempel niob och uran) i ytvatten och grundvatten, rums- och tidsvariationer i hydrokemiska förhållanden i vattendrag och sjöar i Forsmark och Laxemar samt hur ämnen beter sig vid nedbrytning av förna. Det mesta av studierna kommer att inkluderas i doktorsavhandlingar.

### **Internationellt samarbete**

Förutom SKB har nio organisationer från åtta länder deltagit i det internationella samarbetet vid Äspölaboratoriet under 2007. Sex av dem, Andra, BMWi, CRIEPI, JAEA, NWMO och Posiva utgör tillsammans med SKB ”Äspö International Joint Committee” vilken ansvarar för att koordinera det experimentella arbetet som uppkommer från det internationella deltagandet. Flertalet av de deltagande organisationerna är intresserade av grundvattenströmning, radionuklidtransport och bergkaraktärisering. Många organisationer deltar både i det experimentella arbetet i Äspölaboratoriet och i modelleringsarbetet inom de två Äspö ”Task Force”grupperna: (1) ”Task Force on Modelling of Groundwater Flow and Transport of Solutes” och (2) ”Task Force on Engineered Barrier Systems”.

# Contents

<b>1</b>	<b>General</b>	19
1.1	Background	19
1.2	Goals	20
1.3	Organisation	21
1.4	International participation in Äspö HRL	22
1.5	Allocation of experimental sites	22
1.6	Reporting	23
1.7	Management system	23
1.8	Structure of this report	24
<b>2</b>	<b>Geoscience</b>	25
2.1	General	25
2.2	Geology	25
	2.2.1 Geological mapping and modelling	25
	2.2.2 Rock Characterisation System	26
2.3	Hydrogeology	26
	2.3.1 Hydro Monitoring Programme	27
2.4	Geochemistry	28
	2.4.1 Monitoring of Groundwater Chemistry	28
2.5	Rock Mechanics	30
	2.5.1 Stress measurements, core diskings	30
<b>3</b>	<b>Natural barriers</b>	31
3.1	General	31
3.2	Tracer Retention Understanding Experiments	32
	3.2.1 True Block Scale Continuation (BS2)	32
	3.2.2 True Block Scale Continuation (BS3)	33
	3.2.3 True-1 Continuation	35
	3.2.4 True-1 Completion	36
3.3	Long Term Sorption Diffusion Experiment	38
3.4	Colloid Project	40
3.5	Microbe Projects	43
	3.5.1 The Microbe laboratory	45
	3.5.2 Micored	47
	3.5.3 Micomig	50
3.6	Matrix Fluid Chemistry Continuation	53
3.7	Padamot	54
3.8	Fe-oxides in Fractures	56
3.9	Swiw-tests with Synthetic Groundwater	58
3.10	Task Force on Modelling of Groundwater Flow and Transport of Solutes	59
<b>4</b>	<b>Engineered barriers</b>	63
4.1	General	63
4.2	Prototype Repository	63
	4.2.1 Background	63
	4.2.2 Objectives	64
	4.2.3 Experimental concept	64
	4.2.4 Results	65
4.3	Long Term Test of Buffer Material	71
	4.3.1 Background	71
	4.3.2 Objectives	73
	4.3.3 Experimental concept	74
	4.3.4 Results	75

4.4	Alternative Buffer Materials	75
4.4.1	Background	75
4.4.2	Objectives	76
4.4.3	Experimental concept	76
4.4.4	Results	76
4.5	Backfill and Plug Test	76
4.5.1	Background	76
4.5.2	Objectives	77
4.5.3	Experimental concept	77
4.5.4	Results	78
4.6	Canister Retrieval Test	79
4.6.1	Background	79
4.6.2	Objectives	79
4.6.3	Experimental concept	79
4.6.4	Results	81
4.7	Temperature Buffer Test	81
4.7.1	Background	81
4.7.2	Objectives	81
4.7.3	Experimental concept	81
4.7.4	Results	82
4.8	KBS-3 Method with Horizontal Emplacement	86
4.8.1	Background	86
4.8.2	Objectives	87
4.8.3	Demonstration site	87
4.8.4	Results	87
4.9	Large Scale Gas Injection Test	88
4.9.1	Background	88
4.9.2	Objectives	89
4.9.3	Experimental concept	89
4.9.4	Results	90
4.10	In Situ Corrosion Testing of Miniature Canisters	91
4.10.1	Background	91
4.10.2	Objectives	91
4.10.3	Experimental concept	92
4.10.4	Results	93
4.11	Cleaning and Sealing of Investigation Boreholes	94
4.11.1	Background	94
4.11.2	Objectives	94
4.11.3	Results	97
4.12	Task Force on Engineered Barrier Systems	98
4.12.1	Background and objectives	98
4.12.2	Results	99
<b>5</b>	<b>Äspö facility</b>	101
5.1	General	101
5.2	Äspö Hard Rock Laboratory	101
5.3	Bentonite Laboratory	101
5.4	Public Relations and Visitor Services	103
<b>6</b>	<b>Environmental research</b>	105
6.1	General	105
6.2	Environmental and exogene geochemistry – studies within the Äspö Research School	105
<b>7</b>	<b>International co-operation</b>	115
7.1	General	115
7.2	Andra	115
7.2.1	Alternative Buffer Materials	115

7.3	BMW	117
7.3.1	Microbe Project	118
7.3.2	Prototype Repository	123
7.3.3	Alternative Buffer Materials	124
7.3.4	Temperature Buffer Test	125
7.3.5	Large Scale Gas Injection Test	130
7.3.6	Task Force on Engineered Barrier Systems	130
7.4	CRIEPI	132
7.4.1	Task Force on Modelling Groundwater Flow and Transport of Solutes	132
7.4.2	Task Force on Engineered Barrier Systems	135
7.5	Japan Atomic Energy Agency – JAEA	141
7.5.1	Tracer Retention Understanding Experiments	141
7.5.2	Task Force on Modelling of Groundwater Flow and Transport of Solutes	141
7.6	NWMO	145
7.6.1	Colloid project	145
7.6.2	Task Force on Modelling of Groundwater Flow and Transport of Solutes	147
7.6.3	Large Scale Gas Injection Test	148
7.6.4	Task Force on Engineered Barrier Systems	149
7.7	Posiva	151
7.7.1	Task Force on Modelling of Groundwater Flow and Transport of Solutes	151
7.7.2	Prototype Repository	151
7.7.3	Long Term Test of Buffer Material	153
7.7.4	Alternative buffer materials	153
7.7.5	Cleaning and Sealing of Investigation Boreholes	154
7.7.6	Task Force on Engineered Barrier Systems	154
7.7.7	Sealing of Tunnel at Great Depth	155
7.7.8	KBS-3 Method with Horizontal Emplacement	155
7.8	Enresa	155
7.9	Nagra	155
7.9.1	Alternative Buffer Materials	155
7.9.2	Task Force on Engineered Barrier Systems	156
7.10	Rawra	156
7.10.1	Alternative Buffer Materials	156
7.10.2	Task Force on Engineered Barrier Systems	156
<b>8</b>	<b>Literature</b>	157
8.1	References	157
8.2	List of papers and articles published 2007	162
8.3	Documents published 2007	165

# 1 General

## 1.1 Background

The Äspö Hard Rock Laboratory (HRL), in the Simpevarp area in the municipality of Oskarshamn, constitutes an important part of SKB's work with design and construction of a deep geological repository for final disposal of spent nuclear fuel. This work includes the development and testing of methods for use in the characterisation of a suitable site. One of the fundamental reasons behind SKB's decision to construct an underground laboratory was to create an opportunity for research, development and demonstration in a realistic and undisturbed rock environment down to repository depth. Most of the research is concerned with processes of importance for the long-term safety of a future final repository and the capability to model the processes taking place. Demonstration addresses the performance of the engineered barriers, and practical means of constructing a repository and emplacing the canisters with spent fuel.

The underground part of the laboratory consists of a tunnel from the Simpevarp peninsula to the southern part of Äspö where the tunnel continues in a spiral down to a depth of 460 m, see Figure 1-1. The total length of the tunnel is 3,600 m where the main part of the tunnel has been excavated by conventional drill and blast technique and the last 400 m have been excavated by a tunnel boring machine (TBM) with a diameter of 5 m. The underground tunnel is connected to the ground surface through a hoist shaft and two ventilation shafts.

The work with Äspö HRL has been divided into three phases: Pre-Investigation phase, Construction phase and Operational phase.



*Figure 1-1. Overview of the Äspö HRL facilities.*



During the *Pre-Investigation phase*, 1986–1990, studies were made to provide background material for the decision to locate the laboratory to a suitable site. The natural conditions of the bedrock were described and predictions made of geological, hydrogeological, geochemical and rock-mechanical conditions to be observed during excavation of the laboratory. This phase also included planning for the Construction and Operational phases.

During the *Construction phase*, 1990–1995, comprehensive investigations and experiments were performed in parallel with construction of the laboratory. The excavation of the main access tunnel to a depth of 450 m and the construction of the Äspö Research Village were completed.

The *Operational phase* began in 1995. A preliminary outline of the programme for this phase was given in SKB's Research, Development and Demonstration (RD&D) Programme 1992. Since then the programme has been revised every third year and the detailed basis for the period 2005–2007 is described in SKB's RD&D-Programme 2004 /SKB 2004/. In fall 2007, the detailed programme for the coming three years was published /SKB 2007a/.

## 1.2 Goals

To meet the overall time schedule for SKB's RD&D work, the following stage goals were initially defined for the work at the Äspö HRL:

1. *Verify pre-investigation methods.* Demonstrate that investigations on the ground surface and in boreholes provide sufficient data on essential safety-related properties of the rock at repository level.
2. *Finalise detailed investigation methodology.* Refine and verify the methods and the technology needed for characterisation of the rock in the detailed site investigations.
3. *Test models for description of the barrier functions at natural conditions.* Further develop and at repository depth test methods and models for description of groundwater flow, radionuclide migration and chemical conditions during operation of a repository as well as after closure.
4. *Demonstrate technology for and function of important parts of the repository system.* In full scale test, investigate and demonstrate the different components of importance for the long-term safety of a final repository and show that high quality can be achieved in design, construction and operation of repository components.

Stage goals 1 and 2 have been concluded at Äspö HRL and the tasks have been transferred to the Site Investigations Department of SKB which performs site investigations at Simpevarp/Laxemar in the municipality of Oskarshamn and at Forsmark in the municipality of Östhammar.

In order to reach present goals (3 and 4) the following important tasks are today performed at the Äspö HRL:

- Develop, test, evaluate and demonstrate methods for repository design and construction as well as deposition of spent nuclear fuel and other long-lived waste.
- Develop and test alternative technology with the potential to reduce costs and simplify the repository concept without sacrificing quality and safety.
- Increase the scientific understanding of the final repository's safety margins and provide data for safety assessments of the long-term safety of the repository.
- Provide experience and train personnel for various tasks in the repository.

- Provide information to the general public on technology and methods that are being developed for the final repository.
- Participate in international co-operation through the Äspö International Joint Committee (IJC) as well as bi- and multilateral projects.

### 1.3 Organisation

SKB's work is organised into six departments: Technology, Nuclear Safety, Site Investigations, Operations, Environmental Impact Assessment, and Public Information and Business Support. The research, technical development and safety assessment work is organised into the Technology department, in order to facilitate co-ordination between the different activities. Within the Technology department a Technical-scientific council has been set up in order to prepare technical and scientific issues concerning the research and development of the KBS-3 method. The Council shall in different issues continuously judge the state of development and the need of further work as well as advice on ongoing and planned new projects aimed at development and scientific verifying of the different parts of the KBS-3 method.

The director of the Technology department is the chair of the Technical-scientific council and there is one executive secretary appointed responsible for the preparation of issues and the documentation and follow-up of standpoints taken by the council. Other members of the council are the managers of the units within the Technology department responsible for research and development as well as the director of the Site Investigations department of SKB.

The executive secretary in the Technical-scientific council act as a representative between on one hand the clients within Repository Technology and Safety and Science and on the other the performing organisation at Äspö HRL. The executive secretary is also responsible for the co-ordination of the research performed in international co-operation.

The Äspö HRL is one of five units organised under the Technology department and is responsible for the operation of the Äspö facility and the co-ordination, experimental service and administrative support of the research performed in the facility. The Äspö HRL unit is organised in four operative groups and a secretariat:

- *Project and Experimental service (TDP)* is responsible for the co-ordination of projects undertaken at the Äspö HRL, for providing services (administration, planning, design, installations, measurements, monitoring systems etc) to the experiments.
- *Repository Technology and Geoscience (TDS)* is responsible for the development and management of the geoscientific models of the rock at Äspö and the test and development of repository technology at Äspö HRL to be used in the final repository.
- *Facility Operation (TDD)* is responsible for operation and maintenance of the Äspö HRL offices, workshops, the underground laboratory and the bentonite laboratory and for development, operation and maintenance of supervision systems.
- *Relations and Visitor Services (TDI)* is responsible for presenting information about SKB and its facilities with main focus on Äspö. The laboratories at Äspö and SKB's other research facilities are open to visitors throughout the year.

Each major research and development task is organised as a project that is led by a project manager who reports to the client organisation. Each project manager is assisted by an on-site co-ordinator with responsibility for co-ordination and execution of project tasks at the Äspö HRL. The staff at the site office provides technical and administrative service to the projects and maintains the database and expertise on results obtained at the Äspö HRL.

## 1.4 International participation in Äspö HRL

The Äspö HRL has so far attracted considerable international interest. During 2007, nine organisations from eight countries in addition to SKB participated in the Äspö HRL or in Äspö HRL-related activities. The participating organisations were:

- Agence Nationale pour la Gestion des Déchets Radioactifs (Andra), France.
- Bundesministerium für Wirtschaft und Technologie (BMWi), Germany.
- Central Research Institute of Electric Power Industry (CRIEPI), Japan.
- Japan Atomic Energy Agency (JAEA), Japan.
- Nuclear Waste Management Organization (NWMO), Canada.
- Posiva Oy, Finland.
- Empresa Nacional de Residuos Radiactivos (Enresa), Spain.
- Nationale Genossenschaft für die Lagerung Radioaktiver Abfälle (Nagra), Switzerland.
- Radioactive Waste Repository Authority (RAWRA), Czech Republic.

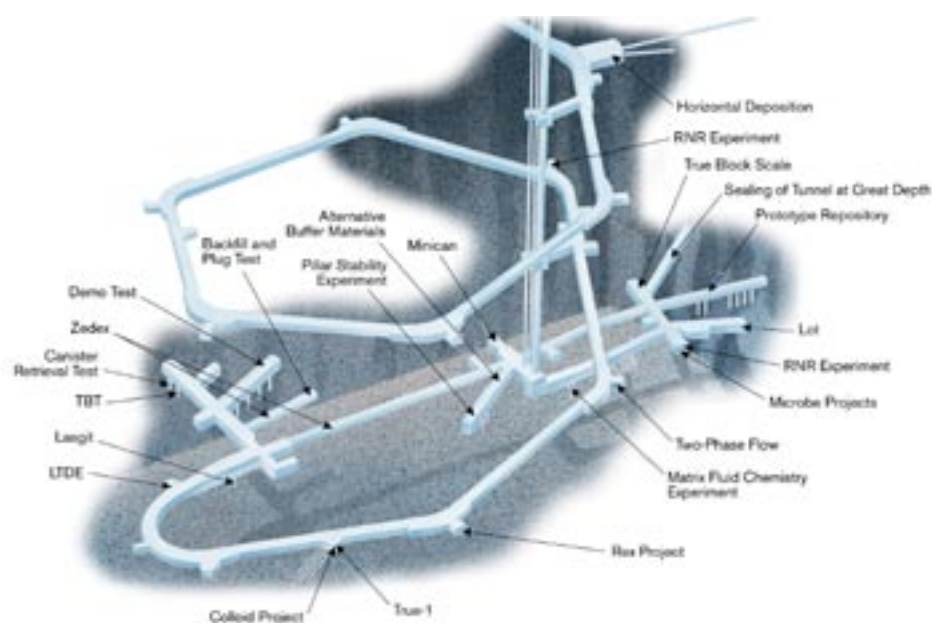
Andra, BMWi, CRIEPI, JAEA, NWMO and Posiva together with SKB form the Äspö International Joint Committee (IJC), which is responsible for the co-ordination of the experimental work arising from the international participation.

Task Forces are another form of organising the international work. Several of the international organisations in the Äspö co-operation participate in the two Äspö Task Forces on Modelling of: (a) Groundwater Flow and Transport of Solutes and (b) Engineered Barrier Systems.

SKB also takes part in several international EC-projects and participates in work within the IAEA framework.

## 1.5 Allocation of experimental sites

The rock volume and the available underground excavations are divided between the experiments performed at the Äspö HRL. It is essential that the experimental sites are located so that interference between different experiments is minimised. The allocation of some of the experimental sites within the underground laboratory is shown in Figure 1-2.



*Figure 1-2. Allocation of experimental sites from -220 m to -450 m level.*

## 1.6 Reporting

Äspö HRL is an important part of SKB's RD&D Programme. The plans for research and development of technique during the period 2005–2010 are presented in SKB's RD&D Programme 2004 /SKB 2004/. The RD&D Programme for the period 2008–2013 is presented in SKB's RD&D Programme 2007 /SKB 2007a/. The information given in the RD&D Programme related to Äspö HRL is detailed in the Äspö HRL Planning Report /SKB 2007b/ and this plan is revised annually. Detailed account of achievements to date for the Äspö HRL can be found in the Äspö HRL Annual Reports that are published in SKB's Technical Report series. This report describes the achievements during 2007. In addition, Status Reports are prepared quarterly.

Joint international work at Äspö HRL, as well as data and evaluations for specific experiments and tasks, are reported in Äspö International Progress Report series. Information from Progress Reports is summarised in Technical Reports at times considered appropriate for each project. SKB also endorses publications of results in international scientific journals. Table 1-1 provides an overview of Äspö HRL related documents and the policy for review and approval.

Data collected from experiments and measurements at Äspö HRL are mainly stored in SKB's site characterisation database, Sicada.

## 1.7 Management system

SKB is since 2001 certified according to the Environmental Management System ISO 14001 as well as the Quality Management Standard ISO 9001. Since 2003 SKB is also certified according to the up-graded ISO standard 9001:2000.

The structure of the management system is based on procedures, handbooks, instructions, identification and traceability, quality audits etc. The overall guiding documents for issues related to management, quality and environment are written as quality assurance documents.

The documentation can be accessed via SKB's Intranet where policies and quality assurance documents for SKB (SD-documents) as well as specific guidelines for Äspö HRL (SDTD-documents) can be found. Employees and contractors related to the SKB organisation are responsible that work is performed in accordance with SKB's management system.

**Table 1-1. Overview of Äspö HRL related documents.**

Report	Reviewed by	Approved by
SKB RD&D-programme – Äspö HRL related parts	Executive secretary, Technical-scientific council	SKB
Planning report – Detailed plans covering each calendar year	Contributors	Executive secretary, Technical-scientific council
Annual report – Summary of work covering each calendar year	Contributors	Executive secretary, Technical-scientific council
Status report – Short summary of work covering each 3 month period	Principal investigators or project managers	Executive secretary, Technical-scientific council
Technical Report (TR)	Project manager	Executive secretary, Technical-scientific council
International Progress Report (IPR)	Project manager	Executive secretary, Technical-scientific council
Internal technical document (ITD)	Case-by-case	Project manager
Technical document (TD)	Case-by-case	Project manager

SKB is constantly developing and enhancing the security, the working environment and the quality-control efforts to keep up with the company's development as well as with changes in circumstances. One of the cornerstones of both the existing operations and in the planning of new facilities is the efficient utilisation of available resources.

The guiding principles of all SKB's activities and each employer's work are expressed in three key words:

- Safety
- Efficiency
- Responsiveness

## **1.8 Structure of this report**

The achievements obtained at Äspö HRL during 2007 are in this report described in seven chapters:

- Geoscience – experiments, analysis and modelling to increase the knowledge of the surrounding rock.
- Natural barriers – experiments, analysis and modelling to increase the knowledge of the repository barriers under natural conditions.
- Engineered barriers – demonstration of technology for and function of important engineered parts of the repository barrier system.
- Äspö facility – operation, maintenance, data management, monitoring, public relations etc.
- Environmental research.
- International co-operation.

## 2 Geoscience

### 2.1 General

During the pre-investigations for the Äspö HRL in the late 1980's the first geoscientists came to Äspö. Most of them were consultants that mainly worked off-site. A new site organisation was developed when the HRL was taken into operation 1995. Posts as site geologist and site hydrogeologist were then established. These posts have been broadened with time, and today the responsibility of the holder involves maintaining and developing the knowledge and methods of the scientific field, as well as scientific support to various projects conducted at Äspö. Geoscientific research and activities are conducted in the fields of geology, hydrogeology, geochemistry and rock mechanics.

Geoscientific research is a part of the activities at Äspö HRL as a complement and an extension of the stage goals 3 and 4, see Section 1.2. Studies are performed in both laboratory and field experiments, as well as by modelling work. The overall aims are to:

- Establish and develop geoscientific models of the Äspö HRL rock mass.
- Establish and develop the understanding of the Äspö HRL rock mass material properties as well as the knowledge of applicable measurement methods.

The main task within the geoscientific field is the development of the Äspö Site Descriptive Model (SDM) integrating the information from the fields of geology, hydrogeology, geochemistry and rock mechanics. The activities further aim to provide basic geoscientific data to the experiments and to ensure high quality of experiments and measurements related to geosciences.

### 2.2 Geology

The geological work at Äspö HRL is covering several fields. Major responsibilities are mapping of tunnels, deposition holes and drill cores, as well as continuous updating of the geological three-dimensional model of the Äspö rock volume and contribution with input knowledge in projects and experiments conducted at Äspö HRL. Also, development of new methods in the field of geology is a major responsibility. As a part of the latter, the Rock Characterisation System (RoCS) feasibility study is being conducted, see Section 2.2.2.

#### 2.2.1 Geological mapping and modelling

##### ***Background and objectives***

All rock surfaces and drill cores are mapped at Äspö HRL. This is done in order to increase the understanding of geometries and properties of rocks and structures, which is subsequently used as input in the 3D modelling, together with other input data.

##### ***Results***

During 2007, three core boreholes (KI0010B01, KI0014B01 and KI0016B01), drilled from the TASI-tunnel in order to investigate the location of the new TASS-tunnel ("The injection test tunnel – sealing fractures at great depth"), have been mapped in Boremap. The excavation of the new tunnel at the –450 m level has commenced and two fronts of the tunnel have been mapped.

The floor of the TASQ tunnel (Sections 45–59 and 71–81.5) has been mapped and entered into the TMS (Tunnel Mapping System). Also the mapping of the shallow niche NASQ0036A has been entered into TMS.

The work with the detailed 3D structural geological and hydrogeological model of the –450 m level is now completed and the report will be finished during spring 2008. The aim of the model is to visualise water bearing structures around the –450 m level.

During 2007, the core logging facility has been supplied with new computer equipment and camera.

## **2.2.2 Rock Characterisation System**

### ***Background and objectives***

A feasibility study concerning geological mapping techniques is performed beside the regular mapping and modelling tasks. The project Rock Characterisation System (RoCS) is conducted as an SKB-Posiva joint-project. The purpose is to investigate if a new system for rock characterisation has to be adopted when constructing a future final repository. The major reasons for the RoCS project are aspects on objectivity of the data collected, traceability of the mappings performed, saving of time required for mapping and data treatment, and precision in mapping. These aspects all represent areas where the present mapping technique may not be adequate. In this initial feasibility study-stage, the major objective is to establish a knowledge base concerning existing and possible future methods and techniques to be used for a mapping system suitable for SKB's and also Posiva's requirements.

### ***Results***

The first part of the feasibility study, establishing of the technical state-of-the-art, is completed and the results have been published /Magnor et al. 2007/. Tests of data collection methods have been performed using both digital photogrammetry and laser scanning. Several complementary techniques, like geophysical survey methods, have been investigated, as well as software applications. During 2007, the results from the laser scanning of the TASQ tunnel, performed during 2006, have been delivered and a report will be printed during the first half of 2008.

After 2007, the RoCS-project will no longer be treated as separated project but will continue as a part of the ordinary tasks within the discipline at Äspö HRL. The aim will in the future be concentrated on geological matters.

## **2.3 Hydrogeology**

### ***Background and objectives***

The major aims of the hydrogeological activities are to:

- Establish and develop the understanding of the hydrogeological properties of the Äspö HRL rock mass.
- Maintain and develop the knowledge of applicable measurement methods.
- Ensure that experiments and measurements in the hydrogeological field are performed with high quality.
- Provide hydrogeological support to active and planned experiments at Äspö HRL.

The main task is the development of the integrated Äspö Site Descriptive Model. An important part of the site description is the numerical groundwater model which is to be continuously developed and calibrated. The intention is to develop the model to a tool that can be used for predictions, to support the experiments and to test hydrogeological hypotheses. Another part of the work with the site description is the continued development of a more detailed model of hydraulic structures at the main experimental levels below 400 m.

## **Results**

The main achievement during 2007 has been the completion of the modelling work for the detailed hydro-structural model for the –450 m level.

### **2.3.1 Hydro Monitoring Programme**

#### **Background**

The hydro monitoring programme is an important part of the hydrogeological research and a support to the experiments undertaken in the Äspö HRL. It was conditioned by the water rights court, when granting the permission to execute the construction works for the tunnel, that a monitoring programme should be put in place and that the groundwater head conditions should continue to be monitored until the year 2004.

The monitoring of water level in surface boreholes started in 1987 while the computerised Hydro Monitoring System (HMS) was introduced in 1992. The HMS collects data on-line of pressure, levels, flow and electrical conductivity of the groundwater. The data are recorded by numerous transducers installed in boreholes and in the tunnel. The number of boreholes included in the monitoring programme has gradually increased, and comprise boreholes in the tunnel in the Äspö HRL as well as surface boreholes on the islands of Äspö, Ävrö, Mjälén, Bockholmen, and some boreholes on the mainland at Laxemar. The tunnel construction started in October 1990 and the first pressure measurements from tunnel drilled boreholes were included in the HMS in March 1992. The tunnel excavation began to affect the groundwater level in many surface boreholes during the spring 1991.

#### **Objectives**

The scientific grounds of maintaining the hydro monitoring programme are:

- To establish a baseline of the groundwater head and groundwater flow situations.
- To provide information about the hydraulic boundary conditions for the experiments in the Äspö HRL.
- To provide data to various model validation exercises, including the comparison of predicted head with actual head.

#### **Results**

The monitoring system and the monitoring points have been maintained during the year. Maintenance and improvements are continuously made on the system to increase the performance. Instrumentation, measurement methods and the monitoring during 2006 is described in a report /Nyberg et al. 2007/.

The main activities in the Hydro Monitoring Programme during 2007 have been:

- Inventory of borehole installations in the tunnel and the compilation of a maintenance plan.
- A study about renovation of cored surface boreholes.
- Quality check and calibration of data. The data from the surface boreholes were checked in January, May, and September, and the data from the tunnel were checked in April, August, and December.
- Preparations in the Site characterisation database (Sicada) for automatic transfer of data from HMS. This has included development of the transfer software, correction of section information in the database, and the development of new data tables.



## 2.4 Geochemistry

### **Background and objectives**

The major aims within geochemistry are to:

- Establish and develop the understanding of the hydrogeochemical properties of the Äspö HRL rock volume.
- Maintain and develop the knowledge of applicable measuring and analytical methods.
- Ensure that experimental sampling programmes are performed with high quality and meet overall goals within the field area.

One of the overall main tasks within the geoscientific programme is to develop an integrated site description of the Äspö HRL. An important part is the geochemical description. The use of the information generated will facilitate the understanding of the geochemical conditions of the sites and the way in which they change during the period of operation. The intention is to develop the model as to be used for predictions, to support and plan experiments, and to test hydrogeochemical hypotheses. This is important in terms of distinguishing undisturbed and disturbed conditions. In general hydrogeochemical support is provided to active and planned experiments in Äspö HRL.

During the year, the need of further investigating the gas and water phase, is identified and addressed. The database does not have enough data points and no isotope values are reported (of the gas phase). For upcoming modelling purpose (Äspö site description) we need to complement the dataset. In this project, isotope data will be analysed in both the gas, and the water phase within the same sample. Until now methods for sampling have been tested and test plans are being set up. Before starting a sampling campaign the sampling methodology is to be determined, for example the sampling volumes required for obtaining reliable results on isotope values must be defined. In addition, the evolution of the redox conditions is further being evaluated within other projects. Hydrogeochemical sampling has been performed, mainly within the injection activities for the building of the new TASS-tunnel and the Megapacker installation in the KBS-3H tunnel in Äspö HRL. The sampling included colloids and general chemistry parameters (pH, alkalinity, Cl, Na, K, Ca, Mg, metals and organic content etc). The aim is to track changes in the surrounding groundwaters and to determine whether this gives any stability changes for the formation of colloids.

### **2.4.1 Monitoring of Groundwater Chemistry**

#### **Background**

During the Äspö HRL construction phase, different types of water samples were collected and analysed with the purpose of monitoring the groundwater chemistry and its evolution as the construction proceeded. The samples were obtained from boreholes drilled from the ground surface and from the tunnel. At the beginning of the Äspö HRL operational phase, sampling was replaced by a groundwater chemistry monitoring programme, with the aim to sufficiently cover the evolution of hydrochemical conditions with respect to time and space within the Äspö HRL.

#### **Objectives**

The monitoring programme is designed to provide information to determine where, within the rock mass, the hydrogeochemical changes are taking place and at what time stationary conditions are established. In addition, all ongoing experiments have the possibility to request additional sampling of interest for their projects.

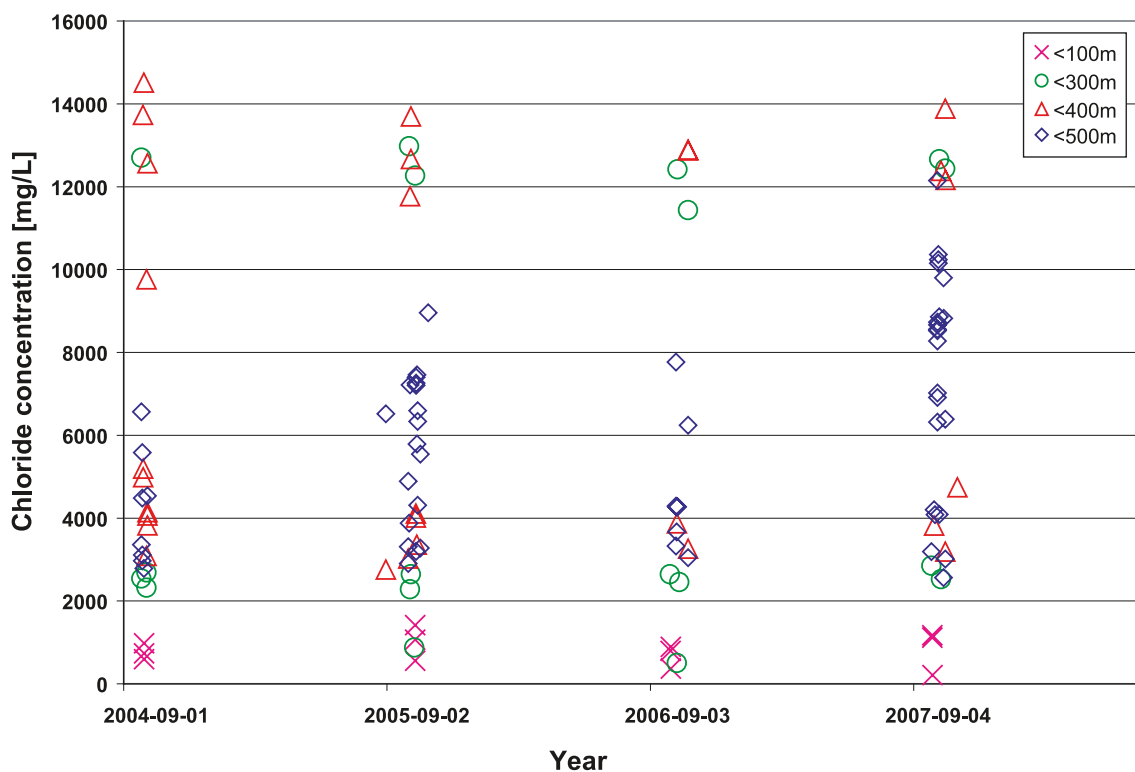
## Results

Monitoring of the groundwater at Äspö was performed as planned during 2007. Sampling and analysing of additional parameters such as ATP (indirect measure of bacterial activity) was also performed. These results will be reported and evaluated separately, however, it seems that the method needs to be adopted for the conditions at Äspö.

Groundwater fluctuations due to different project activities, such as drilling, blasting during the construction of a new tunnel, hydraulic tests, grouting, injection of resins etc, may cause indirect changes in groundwater pressure, flow and thus also in groundwater chemistry.

There are some boreholes sampled from the surface that reaches down to more than 800 m below sea level. When evaluating all the data at Äspö (including project data), the trend of increasing salinity is apparent. In Figure 2-1 measured chloride concentration in boreholes at different depths during the last four years are compiled.

Since the monitoring programme is only performed once a year and sampling is performed of only a minor part of the existing boreholes, the trend with increasing salinity is not as obvious when studying these data. By analysing a complete set of parameters and adding new ones, including isotopes, trends and effects due to impact from experiments and tunnel excavation can be followed. Changes in the programme are continuously being made to adapt to ongoing experiments and activities in the tunnel. The monitoring programme will therefore be performed twice during 2008, in May and October.



*Figure 2-1. Measured chloride concentrations given in mg/L for different depths. Data points are from the monitoring campaign during the last four years (2004–2007).*

## 2.5 Rock Mechanics

Rock Mechanics studies are performed with the aims to increase the understanding of the mechanical properties of the rock but also to recommend methods for measurements and analyses. This is done by laboratory experiments and modelling at different scales and comprises:

- Natural conditions and dynamic processes in natural rock.
- Influences of mechanical, thermal, and hydraulic processes in the near-field rock including effects of the backfill.

Before 2007, work was also performed within the project Äspö Pillar Stability Experiment. This project was, however, finished during 2006 and reported as a Ph.D. study and an SKB report /Andersson 2007/.

### 2.5.1 Stress measurements, core dinking

#### *Background and objectives*

The objective of this study is to determine the stress levels at which core dinking (solid cores) and ring dinking (hollow cores) develop. This is achieved by overcoring, supplemented with core drilling, in an area where stress conditions are reasonably well known, i.e. in this case the TASQ tunnel at Äspö HRL. In addition to the field work, geological modelling and numerical stress analysis are conducted to aid in explaining field observations.

#### *Experimental concept and results*

The conducted field work comprised drilling of four vertical boreholes (KQ0062G05, KQ0062G06, KQ0061G10 and KQ0062G04) in the tunnel floor in the vicinity of deposition hole DQ0063G01. Pilot hole drilling (to obtain hollow cores) was made in all four of these, whereas three-dimensional overcoring measurements were attempted in three boreholes. Practical difficulties and time constraints inhibited additional planned core drilling. Detailed core logging was performed, followed by geological modelling and creating a model in RVS (Rock Visualization System) of the test site. The numerical modelling was conducted using the three-dimensional distinct element code 3Dec /Itasca 2003/.

The results from this work showed that it was not possible to fulfil the primary objective, i.e. to determine stress levels at which core dinking occurs. The reasons for this were: (i) the lack of systematic core dinking in the boreholes (only a few, separate, instances of dinking observed) and (ii) the practical difficulties in drilling and overcoring. However, the performed stress measurements, the observed isolated instances of core dinking and the borehole breakouts indicate low stresses in the test volume. For the majority of the investigated rock mass volume at the test site, an estimated upper bound of the maximum tangential stress in the horizontal direction prior to drilling the holes was 40–55 MPa. Locally, higher stresses probably exist, as evidenced by the observed core dinking and the numerical stress modelling. There also appeared to be a strong link between observed core dinking and the occurrence of sub-vertical fractures intersecting the boreholes. Slightly elevated stresses above and below a fracture coupled with (potentially) weaker rock near the fracture may be a reason for observed core dinking.

Any further work along these lines must focus on achieving as low variability as possible in the factors controlling core dinking. This means homogeneous geology with as few fractures as possible, well-defined stress conditions and simple stress-path history, better drilling control, and the ability to drill more tests holes and conduct more measurements (to achieve redundancy in the results).

## 3 Natural barriers

### 3.1 General

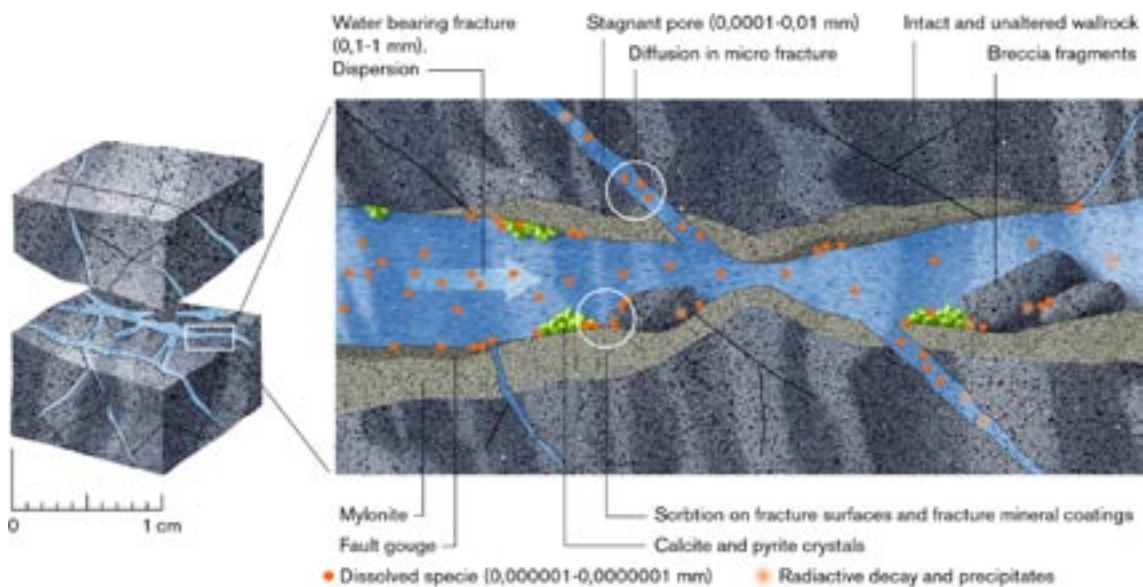
To meet Stage goal 3 (see Section 1.2), experiments are performed to further develop and test methods and models for description of groundwater flow, radionuclide migration, and chemical conditions at repository depth, see Figure 3-1.

The experiments are related to the rock, its properties and in situ environmental conditions. The programme at Äspö HRL includes projects with the aim to evaluate the usefulness and reliability of different conceptual and numerical models and to develop and test methods for determination of parameters required as input to the models. The overall purposes are to:

- Improve the scientific understanding of the final repository's safety margins and provide input data for assessments of the repository's long-term safety.
- Obtain the special material needed to supplement data from the site investigations in support of an application for a siting permit for the final repository.
- Clearly present the role of the geosphere for the barrier functions: isolation, retardation and dilution.

The ongoing experiments and projects within the Natural Barriers at Äspö HRL are:

- Tracer Retention Understanding Experiments.
- Long Term Sorption Diffusion Experiment.
- Colloid Dipole Project.
- Microbe Projects.
- Matrix Fluid Chemistry Continuation.
- Padamot.
- Fe-oxides in fractures.
- Swiw-tests with Synthetic Groundwater.
- Äspö Task Force on Groundwater Flow and Transport of Solutes.



*Figure 3-1. Illustration of processes that influence migration of species along a natural rock fracture.*

## 3.2 Tracer Retention Understanding Experiments

### **Background**

A programme has been defined for tracer tests at different experimental scales, the so-called Tracer Retention Understanding Experiments (True) /Bäckblom and Olsson 1994/. The overall objective of the defined experiments is to increase the understanding of the processes which govern retention of radionuclides transported in crystalline rock, and to increase the credibility in models used for analyses of radionuclide transport in safety assessments.

### **Objectives**

The True experiments should achieve the following general objectives:

- Improve understanding of radionuclide transport and retention in fractured crystalline rock.
- Evaluate to what extent concepts used in models are based on realistic descriptions of rock and whether adequate data can be collected during site characterisation.
- Evaluate the usefulness and feasibility of different approaches to model radionuclide migration and retention. Provide in situ data on radionuclide migration and retention.

During 2001, it was decided to collect all future True work in two separate projects: True Block Scale Continuation and True-1 Continuation. Although the experimental focus is placed on the respective True experimental sites developed at the Äspö HRL, integration and co-ordination of experimental activities at and between the sites is emphasised.

### **Experimental concept**

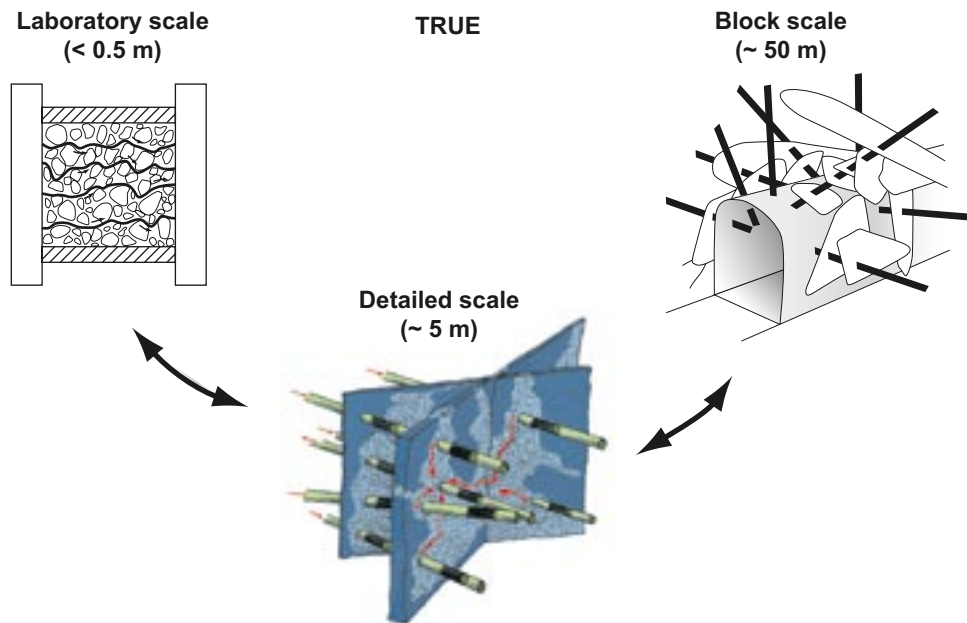
The basic idea is to perform a series of in situ tracer tests with progressively increasing complexity. In principle, each tracer experiment will consist of a cycle of activities beginning with geological characterisation of the selected site, followed by hydraulic and tracer tests. An option is to characterise the tested pore space and analyse tracer fixation using epoxy resin injection. Subsequently, the tested rock volume will be excavated and analysed with regards to flow-path geometry and tracer concentration.

Together with supporting laboratory studies of diffusion and sorption characteristics made on core samples, the results of the in situ tests will provide a basis for integrating data on different scales, and testing of modelling capabilities for radionuclide transport up to a 100 m scale, see Figure 3-2. The integration and modelling of data from different length scales and assessments of effects of longer time perspectives, partly based on True experimental results, is made as part of Task 6 in the Task Force on Modelling of Groundwater Flow and Transport of Solutes, see Section 3.10.

### **3.2.1 True Block Scale Continuation (BS2)**

The True Block Scale Continuation (BS2) project had its main focus on the existing True Block Scale site. The True Block Scale Continuation was divided into two separate phases:

- BS2a Complementary modelling work in support of BS2 in situ tests. Continuation of the True Block Scale (phase C) pumping and sampling including employment of developed enrichment techniques to lower detection limits.
- BS2b Additional in situ tracer tests based on the outcome of the BS2a analysis. In situ tests are preceded by reassessment of the need to optimise/remediate the piezometer array. The specific objectives of BS2b are to be formulated on the basis of the outcome of BS2a.



*Figure 3-2. Schematic representation of transport scales addressed in the True programme.*

### **Objectives**

The overall objective of BS2 can be summarised as: “Improve understanding of transport pathways at the block scale, including assessment of effects of geometry, macro-structure and micro-structure”. Special consideration is in this context put on the possibility to explore the role of more low-permeable parts of the studied fracture network, including background fractures, the latter without developed wall rock alteration and fault gouge signatures.

### **Results**

The final report of the project was printed in May 2007 /Andersson et al. 2006/. The basic results of the project are discussed in the annual report for 2006 /SKB 2006/.

### **3.2.2 True Block Scale Continuation (BS3)**

In the aftermath to the BS2 project a discussion has been in process to set up a second step of continuation of the True Block Scale (BS3). This step would not have specific experimental components, but rather emphasise consolidation and integrated evaluation of all relevant True data and findings collected so far. This integration would not necessarily be restricted to True Block Scale, but could also include incorporation of True-1 and True-1 Continuation results.

### **Reporting results of the True Block Scale/Block Scale Continuation experiments in the peer-review scientific literature**

The working titles of a three-part series of papers are proposed as – Transport and retention from single to multiple fractures in crystalline rock at Äspö (Sweden): (I) Evaluation of tracer test results, effective properties and sensitivity, (II) Structural and hydro-dynamic modelling and (III) A macro-scale retention model and impact of micro-scale heterogeneity. Tracer test evaluation and inference of effective parameters are the main topic of Part I. An important novelty of the work is an explicit quantification of sensitivity of the transport model to different hydrodynamic and retention parameters. In Part II, the flow and advective transport properties in True Block Scale/Block Scale Continuation will be investigated using a DFN (discrete fracture network) simulation tool for the purpose of setting realistic constraints on the range of retention material properties, as presented in Part I. This is to include analysis of macro-structural

properties and possible network effects for evaluating sorbing tracer test results. In Part III, a study of the impact of micro-structural heterogeneity on retention, in particular the depth-wise trend in the matrix porosity is proposed. The novelty in this work will be to assess the constraints that the porosity trends set on effective retention properties and significantly, to assess our predictive capability for effective retention properties for the Äspö diorite. In addition, a synthesis of the entire True programme in terms of the improved understanding of retention, predictive capability and implications for site characterisation have been proposed for Part III.

### **Incorporating new experimental data for constraining True retention parameter estimates**

The evaluation of the results from True-1 and True-BS tracer tests was based on several simplifying assumptions regarding retention processes. The retention was estimated with a relatively wide range of sorption properties such as  $K_d$  and  $K_a$ . In situ values of these properties were not available at the time. New data on sorption properties was made available during 2006 from laboratory sorption experiment on rim zone and fault gauge materials. This enabled introduction of new constraints in the evaluation, thereby further reducing the uncertainty in estimated ranges of material retention parameters. Furthermore, True-1 and True-BS tracer test evaluation had given theoretically possible effective (in situ) ranges of the physical retention parameter (hydrodynamic control parameter or “flow-wetted surface”). New data on apertures and matrix porosity estimates was available 2006 (“Fault Rock Zones Characterisation Project”), from structures not tested by our tracer experiments, but with strong structural relationship with Feature A (True-1) and Structure #20 (True Block Scale). This made it possible to introduce new constraints in the True-1 and True Block Scale evaluations, in order to reduce uncertainty in obtained estimates of physical retention properties (e.g. aperture).

## **Results**

### **Reporting results of the True Block Scale/Block Scale Continuation experiments in the peer-review scientific literature**

During the year Part I, providing a state-of-the-art evaluation of the experimental results, has been completed.

The assumption for the three-part series of manuscripts was that the discrete fracture network (DFN) simulations of the True Block Scale rock volume, as carried out by JAEA/Golder, would be sufficient for Part II, whereas the analysis of rim zone heterogeneity effects as reported in /Cvetkovic and Cheng 2002/ and /Cheng and Cvetkovic 2005/ was considered sufficient for completing Part III. However, during 2007, these assumptions had to be reassessed.

First, it was deemed necessary, to meet the goals of the planned journal article, to employ the state-of-the-art DFN tool ConnectFlow (CF) (used as part of another SKB project by the WRE/KTH team) in order to carry out new DFN simulations of the experiments run in the True Block Scale rock volume. This was seen as potentially very beneficial both for strengthening the argument in Part II, to provide a more solid basis for constraining retention properties in Part III, but also to strengthen the confidence in the CF simulation tool (important for performance and safety assessment) as applied to a well known case study – the True Block Scale/Block Scale Continuation experiments. The main DFN simulations for Part II were carried out outside the WRE/KTH True project budget, and the results are considered important for completing the entire series of papers.

The additional effort in simulating DFN flow and advective transport in the True Block Scale rock volume, delayed the completion of the Part I, but also redirected human resources from Part III in order to complete Parts I and II during the 2007 budget. Second, the rim zone heterogeneity as investigated in /Cvetkovic and Cheng 2002/ and /Cheng and Cvetkovic 2005/ was mainly focused on longitudinal variability. The depth-wise trend in porosity (relatively large porosity in the “enhanced porosity zone” adjacent to the fracture and low porosity of the unaltered rock matrix approximately 10 mm from the fracture), was accounted for in the evalu-

ation of tracer tests only approximately /Cvetkovic and Cheng 2002, Jacobsson and Bäckström 2005/, never in a direct and rigorous manner. Furthermore, it became apparent during 2007 that further development of the SKB's new PA/SA simulation tool MARFA /Painter et al. 2007/ also required a rigorous resolution of the depth-wise porosity trend impact on transport, which was not currently available. In view of these requirements, a decision was made to pursue the issue as part of Part III, with a newly developed code. Resources for such a development were not available within the budget for 2007, hence the task is planned as an activity for 2008.

The aim is now to deliver a draft of Part I and II early 2008 and send them into circulation among the partners. We also have a new draft outline for Part III. In addition, preliminary code development has been completed for a rigorous analysis of the depth-wise porosity trend on tracer transport at the True Block Scale site, to be pursued during 2008.

### **Incorporating new experimental data for constraining True retention parameter estimates**

As part of this activity, possible ranges of sorption parameters  $K_d$ ,  $K_a$  and physical properties of porosity  $\theta$  and the hydrodynamic control parameter (slope)  $k$  were reevaluated and these estimations of chemical and physical retention parameters were compared with the laboratory data. The role of fault gouge materials and the effect of heterogeneity from physical parameter (e.g. aperture) were analysed. The main conclusion is that the new and direct  $K_d$  data measurements are too few to enable significant reduction of the uncertainty in the True-1 and True Block Scale estimated parameter ranges. Nevertheless, this analysis provides some new insight into the patterns of the estimated retention properties at the two sites (True-1 and True Block Scale), in particular the for the sorption coefficient.

Equilibrium models are typically used in the evaluation of the results of the ongoing site characterisation /Byegård et al. 2006/. However, it is well established, see /Byegård et al. 1998/, that results from batch test exhibit kinetic effects that are presumably due to diffusion. A possible diffusion-sorption model for interpreting laboratory batch test results have been presented in an Appendix in a draft report delivered during fall 2007. The point with including the Appendix in the draft report was to highlight an uncertainty aspect of batch tests when determining  $K_d$  in the laboratory. However, there is potential interest to use the presented tool also in the evaluation of site characterisation data. The report in its current form has a prime purpose to provide the data/evaluation basis for the ongoing and planned publication effort 2008–2009, and may not be entirely suitable as a stand-alone publication. Also, it is possible that the proposed model for interpretation/evaluation of batch tests and inference of  $K_d$  will be published separately. Discussions during 2008 will determine the final strategy for how the results will be presented.

### **3.2.3 True-1 Continuation**

The True-1 Continuation project is an extension of the True-1 experiments, and the experimental focus is primarily on the True-1 site. The continuation includes performance of the planned injection of epoxy resin in Feature A at the True-1 site and subsequent overcoring and analysis (True-1 Completion, see Section 3.2.4). Additional activities include: (a) test of the developed epoxy resin technology to fault rock zones distributed in the access tunnel of the Äspö HRL (Fault Rock Zones Characterisation project), (b) laboratory sorption experiments for the purpose of verifying  $K_d$ -values calculated for altered wall rock and fault gouge, (c) writing of scientific papers relating to the True-1 project. A previously included component with the purpose of assessing fracture aperture from radon data has been omitted due to resources prioritisation.

#### **Objectives**

The objectives of True-1 Continuation are to:

- Obtain insight into the internal structure of the investigated Feature A, in order to allow evaluation of the pore space providing the observed retention in the experiments performed (see section on True-1 Completion below).



- Provide an improved understanding of the constitution, characteristics and properties of fault rock zones (including fault breccia and fault gouge) (Fault Rock Zones Characterisation).
- Provide quantitative estimates of the sorption characteristics of the altered rim zone and fault rock materials of fault rock zones.

The scope of work for the field and laboratory activities includes:

- Characterisation of a number of typical fault rock zones of variable thickness. Injection of epoxy resin and subsequent sampling. Assessment of pore space and quantification of in situ porosity of fault gouge material.
- Writing of three scientific papers accounting for the SKB True Project team analysis of the True-1 experiments.
- Batch sorption experiments on rim zone and fault gouge materials from the True Block Scale site and from other locations along the access tunnel.
- Injection of epoxy resin into the previously investigated Feature A, with subsequent excavation and analyses (True-1 Completion, see below).

## **Results**

The progress in the True-1 Continuation project has been affected by heavy involvement of project team in site characterisation and site modelling during 2007. Work has, however, been done in the Fault Rock Zones Characterisation project, primarily with the image analysis report and the final report. Updating of the reports still remains before the reports can be completed.

Only limited work on Complementary laboratory tests on rim zone and fault gouge materials was performed during 2007.

The first two in the series of papers on the True-1 experiment have been published /Widstrand et al. 2007, Cvetkovic et al. 2007/. The third and last of the papers, focussing on effects of heterogeneity in retention properties, was submitted late 2007 /Cvetkovic and Cheng, submitted/.

### **3.2.4 True-1 Completion**

The True-1 Completion project is a sub-project of the True-1 Continuation project with the experimental focus placed on the True-1 site. True-1 Completion constitutes a complement to already performed and ongoing projects. The main activity within True-1 Completion is the injection of epoxy with subsequent over-coring of the fracture and following analyses of pore structure and, if possible, identification of sorption sites. Furthermore, several complementary in situ experiments will be performed prior to the epoxy injection. These tests are aimed to secure important information from Feature A and the True-1 site before the destruction of the site, the latter which is the utter consequence of True-1 Completion.

## **Objectives**

The general objectives of True-1 Completion are to:

- Perform epoxy injection and through the succeeding analyses improve the knowledge of the inner structure of Feature A and to improve the description and identification of the immobile zones that are involved in the noted retention.
- Perform complementary tracer tests with relevance to the ongoing SKB site investigation programme, for instance in situ Kd- and Swiw-test (Single Well Injection Withdrawal).
- Improve the knowledge of the immobile zones where the main part of the noted retention occurs. This is performed by mapping and by mineralogical-chemical characterisation of the sorption sites for Cs.
- Update the conceptual micro structural and retention models of Feature A.

The scope of work for identified field and laboratory activities related to the True-1 site includes:

- Re-instrumentation of boreholes KXTT3 and KXTT4 in order to; a) ensure that the planned activities at the True-1 site do not in anyway interfere with the other projects at Äspö HRL in general and the Long Term Diffusion Experiment (LTDE) in particular and b) successfully perform the complementary tracer tests, the epoxy injection and the subsequent over-coring of KXTT3 and KXTT4.
- Complementary tracer tests, Swiw-tests and cation exchange capacity (CEC) tests.
- Epoxy injection, over-coring of KXTT3 and KXTT4, and dismantling of infrastructure at the True-1 site.
- Analysis of core material using picture analysis, microscopy and chemical mineralogy aiming to improve the description of the inner structure of Feature A and possible identification of the immobile zones involved in the noted retention.

## **Results**

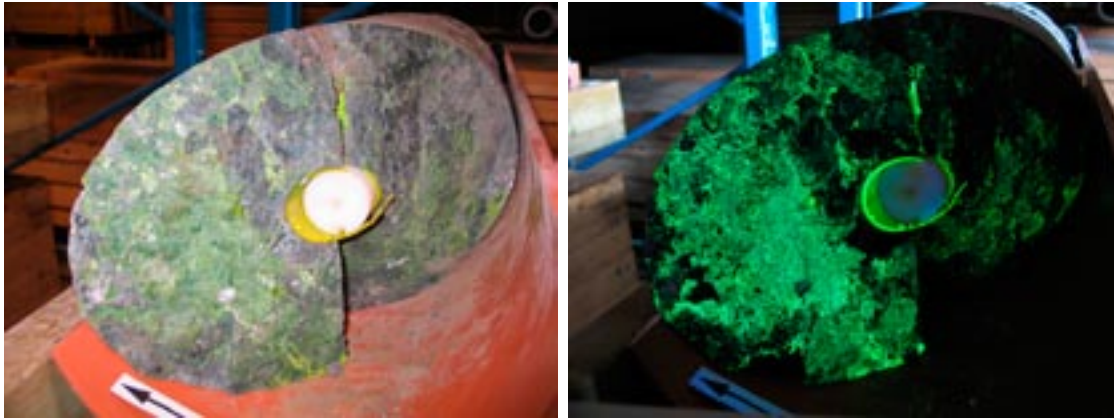
During the past year True-1 Completion has entered a new phase with focus on the over-coring of the boreholes KXTT3 and KXTT4 whereas the previous years have been focused on complementary tracer tests at the True-1 site.

A complication for the planned work at the True-1 site is that the True-1 and LTDE sites are hydraulically connected. In view of the urge for a relative hydraulic tranquillity on the part of LTDE, a priority for advancing LTDE was set by SKB. Consequently, the epoxy injection and following over-coring at the True-1 site were postponed until vital parts of LTDE were completed.

The epoxy injection of Sections KXTT3:S3 and KXTT4:T3 was performed in late March of 2007. In KXTT3:S3, 4.1 l epoxy was injected. Due to lower hydraulic conductivity, it was harder to inject epoxy in KXTT4:T3. Hence, only 0.4 l epoxy was injected in KXTT4:T3. However, despite the relatively small volume of epoxy injected in KXTT4:T3, it was still considered enough to facilitate the subsequent over-coring and analysis.

The over-coring at the True-1 site started with KXTT3 in May 2007 after the over-coring at LTDE was completed. The over-coring was performed with 300 mm core and the core was retrieved gradually during the drilling. In the target section, KXTT3: S3, uranine tagged epoxy from the previous injection was visible in several fractures as seen in Figure 3-3. Unfortunately, the forces acting on the core during drilling and/or retrieving were too large in order to keep the core intact around some fractures in the target section. The method has been used previously within the True projects with good results. However, in previous over-coring the boreholes were approximately horizontal and about 5 m deep whereas the over-coring within True-1 Completion were performed with an inclination of about  $-37^\circ$  and to about 15 m depth. These two factors were complicating the over-coring and retrieval of cores more than anticipated with the result of an extended drilling campaign. Despite the breakage in the target structures, the cores were still considered to provide a lot of valuable information in coming analysis. Hence, also KXTT4 was over-cored between June and August with a similar result as in KXTT3.

Since the cores from the target sections consisted of more pieces than anticipated an increased effort was necessary to reconstruct and characterise the cores prior to the detailed analysis of the cores. The original plan for the analysis of the cores was assuming intact cores around the target structures. Since this was not the result of the over-coring, the plan had to be reviewed during the fall of 2007. The breakage of the target structures appears to complicate some parts in the analysis process but on the other hand also provide new analysis opportunities. However, the final decision about analysing methods in the new analysis plan will be taken at a project meeting early 2008.



**Figure 3-3.** Feature A in KXTT3. To the left in ordinary light and to the right in UV light where the uranine tagged epoxy is clearly visible as green.

Another activity during 2007 within True-1 Completion was the evaluation of the previously performed complementary tracer tests. However, due to heavy involvement within SKB's site investigation programmes by some of the project participants the report was not finalised during 2007.

### 3.3 Long Term Sorption Diffusion Experiment

#### **Background**

The Long Term Sorption Diffusion Experiment (LTDE-SD) constitutes a complement to performed diffusion and sorption experiments in the laboratory, and is a natural extension of the performed in situ experiments, e.g. the True-1 and the True Block Scale experiments. The difference is that the longer duration (approximately 5–7 months) and the well controlled geometry of the experiment is expected to enable an improved understanding of diffusion and sorption both in the vicinity of a natural fracture surface and in the matrix rock.

Matrix diffusion studies using radionuclides have been performed in several laboratory experiments. Some experimental conditions such as pressure and natural groundwater composition are however difficult to simulate with good stability in long-term laboratory experiments. Investigations of rock matrix diffusion at laboratory scale imply that one uses rock specimens in which damage due to drilling and unloading effects (rock stress redistribution) may have caused irreversible changes of the rock properties. Matrix diffusion in non-disturbed rock is therefore preferably investigated in situ. Through the proposed experimental technique one will also obtain some information of the adsorption behaviour of some radionuclides on exposed granitic rock surfaces.

#### **Objectives**

The LTDE Sorption Diffusion experiment aims at increase the scientific knowledge of sorption and diffusion under in situ conditions and to provide data for performance and safety assessment calculations. Specific objectives of LTDE-SD are to:

- Obtain data on sorption properties and processes of individual radionuclides on natural fracture surfaces and internal surfaces in the matrix.
- Investigate the magnitude and extent of diffusion into matrix rock from a natural fracture in situ under natural rock stress conditions and hydraulic pressure and groundwater chemical conditions.

- Compare laboratory derived diffusion constants and sorption coefficients for the investigated rock fracture system with the sorption behaviour observed in situ at natural conditions, and to evaluate if laboratory scale sorption results are representative also for larger scales.

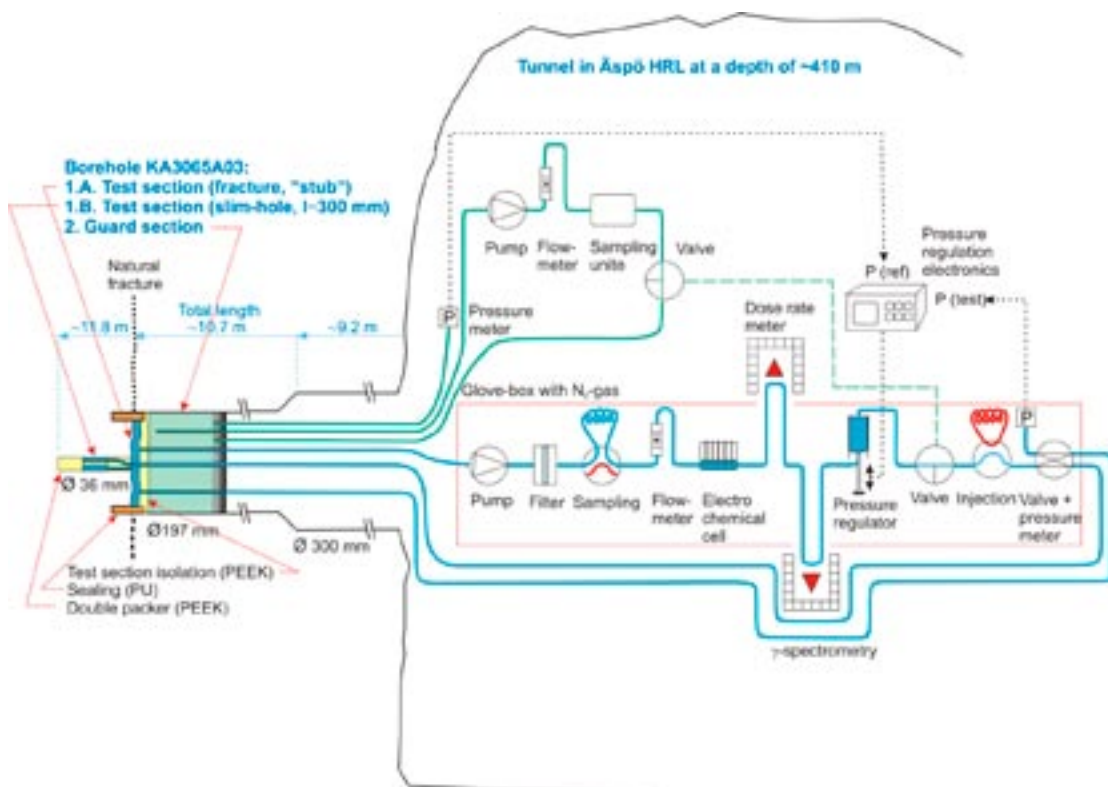
### Experimental concept

A core stub with a natural fracture surface is isolated in the bottom of a large diameter telescoped borehole. In addition a small diameter borehole is drilled through the core stub into the intact undisturbed rock beyond the end of the large diameter borehole. A cocktail of non-sorbing and sorbing tracers are circulated in the test section for a period of approximately 5–7 months after which the core stub is over-cored, and analysed for tracer content and tracer fixation.

The experiment is focussed on a typical conductive fracture identified in a pilot borehole (KA3065A02). A telescoped large diameter borehole (300/197 mm) (KA3065A03) is drilled sub-parallel to the pilot borehole in such a way that it intercepts the identified fracture some 10 m from the tunnel wall and with an approximate separation of 0.3 m between the mantel surfaces of the two boreholes.

The natural fracture as seen on the surface of the stub is sealed off with a polyurethane cylinder and a peek lid, which constitutes a “cup-like” packer. The remainder of the borehole will be packed off with a system of one mechanical and two inflatable packers. The small diameter (36 mm) extension is packed off using a double packer system leaving a 300 mm long section that will be exposed for the radionuclides. The system of packers and an intricate pressure regulating system will be used to eliminate the hydraulic gradient along the borehole, see Figure 3-4.

During the circulation of tracer, samples of water will be collected at various times over the duration of the experiment. The redox situation in the circulation loop will be monitored continuously with a flow through electrochemical cell, which will measure pH, Eh and temperature. After completion of tracer circulation, the core stub will be over-cored, sectioned and analysed for different radionuclide tracers.



**Figure 3-4.** LTDE-SD experimental set-up in the experimental borehole including the water circulation system to the test-section and the hydraulic pressure control system.

The project also involves a variety of mineralogical, geochemical and petrophysical analyses. In addition, laboratory experiments with the core material from KA3065A03 (Ø 277, 177 and 22 mm) and the fracture “replica” material will be performed. Both “batch” sorption and through diffusion experiments are planned.

## **Results**

The in situ sorption diffusion experiment, started on September 27<sup>th</sup> 2006, was finished according to plan on April 12<sup>th</sup> 2007, after 6 ½ months faultless operation. The concentration of the gamma emitting tracers in the test section groundwater was measured by an on-line HPGe (high purity germanium) detector. Test section was also sampled on a regular basis by extracting small volumes (1–10 ml) of water to be analysed for the non-gamma emitting tracers by means of scintillation or mass spectrometry, depending on tracer.

After final sampling subsequent epoxy resin injection, removal and dismantling of borehole equipment and over-coring were completed on May 4<sup>th</sup>. The over-coring turned out successfully and a 1.1 metre long and 278 mm diameter core was retrieved in one piece, containing the core stub with the target fracture and matrix rock surrounding the test section in the small diameter (36 mm) extension borehole (Figure 3-5). Geological mapping and detailed planning were carried out for the extraction of small diameter sample cores (24 mm) from the large core. Sample cores have been extracted both from the fracture surface on the core stub and from the matrix rock surrounding the test section in the small diameter (36 mm) extension borehole. In total 18 cores were drilled on the fracture surface, covering about 34% of the fracture surface on the core stub, and 16 cores drilled in the matrix rock surrounding the test section.

The sample cores were scanned with scintillation detector and mass spectrometry to get a first measure of total activity before they were geologically mapped in detail. At present the sample cores are underway to be cut into thin slices and scanned with autoradiography. So far 8 sample cores of totally 34 have been sliced and scanned. Scanning of the first slices showed that some radionuclide tracers had been transported by the drill bit along the envelope surface on the sample cores during drilling of the cores. To remove this contamination the following sample cores were sawed into square profile bars before slicing. Preliminary results from analysis of saw fluid (alcohol) and saw debris from slicing shows penetration depth up to about 30 mm for <sup>22</sup>Na and <sup>85</sup>Sr. The final radionuclide specific penetration profiles will be determined by analysis of radionuclide tracer content in the thin slices. Figure 3-6 shows an example of a sample core.

## **3.4 Colloid Project**

### **Background**

Colloids are small particles in the size range of 10<sup>-6</sup> to 10<sup>-3</sup> mm. Because of their small size and their often negatively charged surfaces in neutral pH, they have the potential to transport radionuclides from a defect waste canister towards the biosphere. Of special interest is that the bentonite buffer under specific conditions, in contact with dilute glacial water, can release colloids, i.e. bentonite can be eroded. Bentonite erosion would not only endanger the buffer functionality, but could also facilitate transport of radionuclides sorbed onto bentonite colloids.

SKB has for more than ten years conducted field monitoring of natural colloids. The outcome of the studies performed nationally and internationally concluded that the colloids in the Swedish granitic bedrock consist mainly of clay, silica and iron hydroxide particles and that the mean concentration is around 20–45 ppb which is considered to be a low value /Laaksoharju et al. 1995/. The low colloid concentration is controlled by often high salinities in deep old granitic groundwater and also by filtration in filling material etc which reduces both the stability of the colloids and their mobility in aquifers. Low concentrations of organic colloids are found in these types of groundwater, where the concentrations decrease with depth.



**Figure 3-5.** The 278 mm diameter core from LTDE-SD, including the 177 mm diameter core stub and rock surrounding the small diameter extension borehole. Core has been coated with epoxy resin to prevent cross-contamination during cutting and extraction of sample cores.



**Figure 3-6.** Sample core A6, about 18 cm long, drilled from the fracture surface on the core stub. Underneath the protective coating of epoxy resin a thin layer of calcite and chlorite is seen on the fracture surface. The rock is altered into about 4 cm from the fracture surface. Close to and in parallel to the fracture surface two fractures sealed with calcite are visible.

It has been argued that e.g. plutonium is immobile owing to its low solubility in groundwater and strong sorption onto rocks. Field experiments at the Nevada Test Site, where hundreds of underground nuclear tests were conducted, indicate however that plutonium is transported as colloids in the groundwater. The  $^{240}\text{Pu}/^{239}\text{Pu}$  isotope ratio of the samples established that an underground nuclear test 1.3 km north of the sample site is the origin of the plutonium /Kersting et al. 1999/. Also other radionuclides from the nuclear test source were shown to have travelled far by colloidal transport, for example Co associated to clay colloids.

The findings of potential transport of solutes by colloids and access to more sensitive instruments for colloid measurements motivated a Colloid Project at Äspö HRL. The project was initiated by SKB in 2000 and in the end of 2004 the Colloid Dipole project started as a continuation. The Colloid Dipole ended 2007, and the project is going into a new phase with a new name Colloid. The project is planned to continue to 2010.

### **Objectives**

The overall goal of the project is to determine in what conditions colloid transport is significant in the system of a deep bedrock repository of spent nuclear fuel. Two important questions that are important to try to answer within the project is when colloid transport should be taken into account in the safety assessment, and how the colloid transport should be include into modelling. More specific the aims and objectives are to:

- Investigate under what conditions the bentonite barrier can release colloids.
- Study stability and transport of bentonite colloids in dilute to saline groundwater.
- Study actinide and bentonite colloid transport in dilute to more saline groundwater.
- Study stability and transport of other types of natural inorganic and organic colloids in dilute to saline groundwater.
- Monitor background concentrations of colloids in granitic groundwaters.
- Study radionuclide – colloid interactions in dilute to saline groundwaters.

The results from the project will be used mainly in the future development of safety assessment modelling of bentonite erosion and radionuclide migration in the presence of bentonite as well as of other natural colloids.

### **Experimental concept**

The Colloid Project comprises laboratory experiments as well as field experiments and colloid transport modelling. The following topics are included in the project and will be summarised in a final report, before the project continues into the phase II during 2008.

- *Stability of colloids.* Stability of colloids in solution is a key factor since if stable they have the potential to be transported long distances. The effects of the groundwater composition on bentonite colloid stability have been extensively studied. The individual and combined effects of pH, ionic strength, and cation composition, presence of organic or other natural colloids have been investigated in the laboratory. Also effects of temperature and exposure of irradiation have been studied /García-García et al. 2006, 2007/.
- *Colloid transport.* Bentonite colloid transport in water bearing fractures is studied on different scales. The colloid transport in a fracture is influenced by for example flow, aperture distribution, surface roughness, physical filtration and sorption onto fracture walls. The effects of the colloid characteristics on the transport, as colloid size distribution, colloid conformation, surface charge and density are taken into account in the experiments /Vilks and Miller 2006/.
- *Transport modelling* is performed on the colloid transport experiments. The vision is to be able to model colloid transport in any fracture with different apertures, roughness and minerals with colloids of different size, shape and origin.

All results from the Colloid project performed during 2004–2007 will be summarised in a report, thereafter, the project will continue into phase II.

## **Results**

Experimental results within the project suggest that natural organic colloids in Äspö groundwaters could act as a mobilizing agent for actinides under certain conditions. Bentonite colloids on the other hand, have been found to be unstable in Äspö groundwaters mainly due to the high salinities. In these types of waters, the presence of inorganic colloids would rather contribute to radionuclide retention than mobilization. Colloid transport by inorganic colloids under these conditions is very unlikely. Exposing Na-montmorillonite colloids in solution for  $\gamma$ -irradiation increases their stability. Sorption experiments with both cations sorbing by cationic exchange, and surface complexation are performed to see if changes in surface characteristics can be reflected in sorption. In dilute groundwaters (ionic strength 0.001 M) at neutral pH, the bentonite colloid stability increases when increasing the temperature. In the scenario of intrusion of dilute melt water to repository depth, eroded bentonite colloids will stay stable for long times.

Colloid transport experiments indicate that transport of bentonite colloids in water bearing fractures are dominated by the smaller colloids in the size distribution, leaving the larger ones behind. In high water flows, bentonite and latex colloid transport are very similar in water bearing fractures and latex colloids can therefore be used as model colloid for bentonite in transport experiments under these conditions. Latex colloids of comparable sizes to bentonite colloids are more efficiently transported in water bearing fractures, possibly due to the homogenous conformation of latex compared to the heterogeneous conformation of bentonite colloids, and the more even charge density. Probably also the density plays a role. Latex colloids are used in the transport experiments for reference material, to help sorting all the data for difference in colloid transport according to fracture characteristics as well as colloid characteristics.

## **3.5 Microbe Projects**

### ***Microbial processes***

Microorganisms interact with their surroundings and in some cases they greatly modify the characteristics of their environment. Several such interactions may have a significant influence on the function of a future deep repository for spent fuel /Pedersen 2002/.

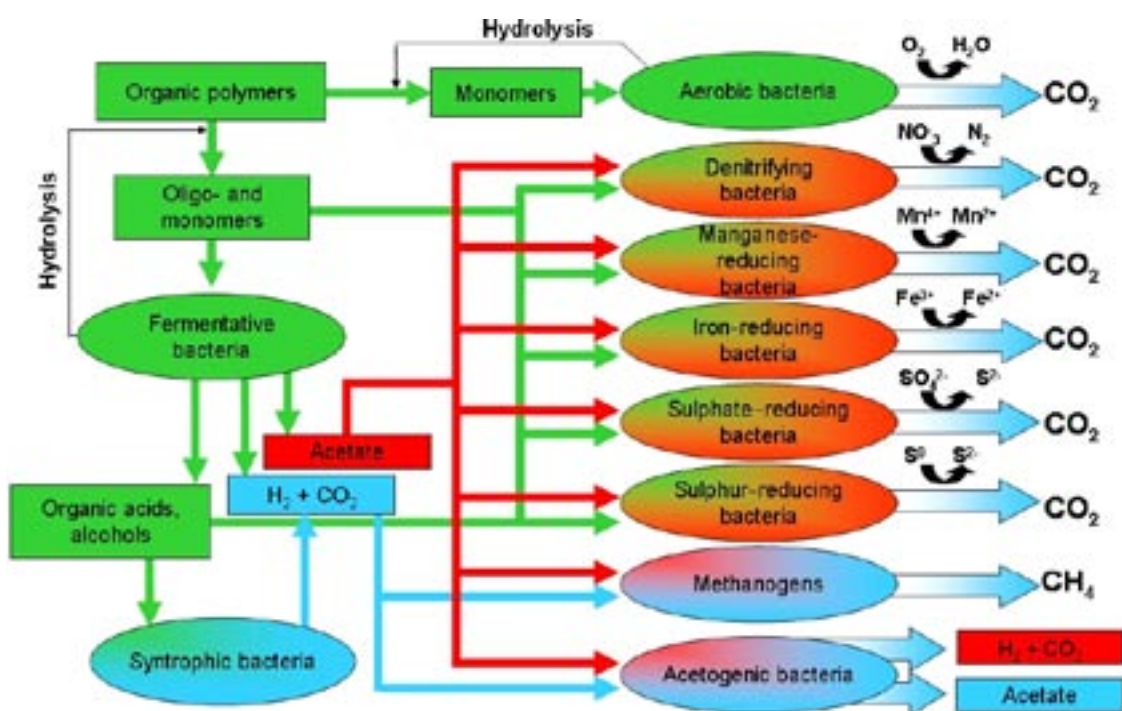
The study of microbial processes in the laboratory gives valuable contributions to our knowledge about microbial processes in repository environments. However, the concepts suggested by laboratory studies must be tested in a repository like environment. The reasons are several. Firstly, at repository depth, the hydrostatic pressure reaches close to 50 bars, a setting that is very difficult to reproduce in the microbiology laboratory. The high pressure will influence chemical equilibrium and the content of dissolved gases. Secondly, the geochemical environment of deep groundwater, on which microbial life depends and influence, is complex. Dissolved salts and trace elements, and particularly the redox chemistry and the carbonate system are characteristics that are very difficult to mimic in a university laboratory. Thirdly, natural ecosystems, such as those in deep groundwater, are composed of a large number of different species in various mixes /Pedersen 2001/. The university laboratory is best suited for pure cultures and therefore the effect from consortia of many participating species in natural ecosystems cannot easily be investigated there. The limitations of university laboratory investigations arrayed above have resulted in the construction and set-up of an underground laboratory in the Äspö HRL tunnel. The site is denoted the Microbe laboratory and is situated at the -450 m level.

There are presently four specific microbial process areas identified that are of importance for proper repository functions and that are best studied at the Microbe laboratory within separate projects. They are: Bio-mobilisation of radionuclides (Micomig), bio-immobilisation of radionuclides (Micomig), microbial effects on the chemical stability of deep groundwater environments (Micored) and microbial corrosion of copper (Biocor). The Microbe laboratory, Micomig and Micored are presented here.



Microbiological decomposition and production of organic material depend on the energy sources and electron acceptors present (Figure 3-7). Organic carbon and methane and reduced inorganic molecules, including hydrogen, are possible energy sources in the subterranean environment. During the microbial oxidation of these energy sources, microbes preferentially use electron acceptors in a particular order (as depicted in the image): first oxygen, and thereafter nitrate, manganese, iron, sulphate, sulphur, and carbon dioxide are utilized. Simultaneously, fermentative processes supply the metabolising microorganisms with, for example, hydrogen and short-chain organic acids. As the solubility of oxygen in water is low, and because oxygen is the preferred electron acceptor of many bacteria that utilize organic compounds in shallow groundwater, anaerobic environments and processes usually dominate at depth in the subterranean environment.

The reduction of microbial electron acceptors may significantly alter groundwater chemistry. Dissolved nitrate is reduced to gaseous nitrogen, solid manganese and iron oxides are reduced to dissolved species, and the sulphur in sulphate is reduced to sulphide. In addition, the metabolic processes of some microorganisms produce organic carbon, such as acetate, from the inorganic gases carbon dioxide and hydrogen, while other microorganisms produce methane from these gases; these processes generally lower the redox potential, Eh. Most of those microbiologically mediated reactions will not occur in a lifeless groundwater environment without the catalyzing enzymes of microorganisms. The mere presence of sulphide in a low-temperature granitic groundwater provides undisputable evidence of microbiological sulphate reduction. However, concentrations of reduced electron acceptors alone will not reveal when, where and at what rate the individual microbial processes take place. Hence, robust, sound, and reproducible methods for estimating the total number of viable microorganisms in groundwater, their diversity, and the rate at which their microbial processes run have been developed at the Microbe site at 447 m depth in the Äspö tunnel.



**Figure 3-7.** Possible pathways for the flow of carbon in the subterranean environment. Organic carbon is respired with oxygen, if present, or else fermentation and anaerobic respiration occur with an array of different electron acceptors.

### 3.5.1 The Microbe laboratory

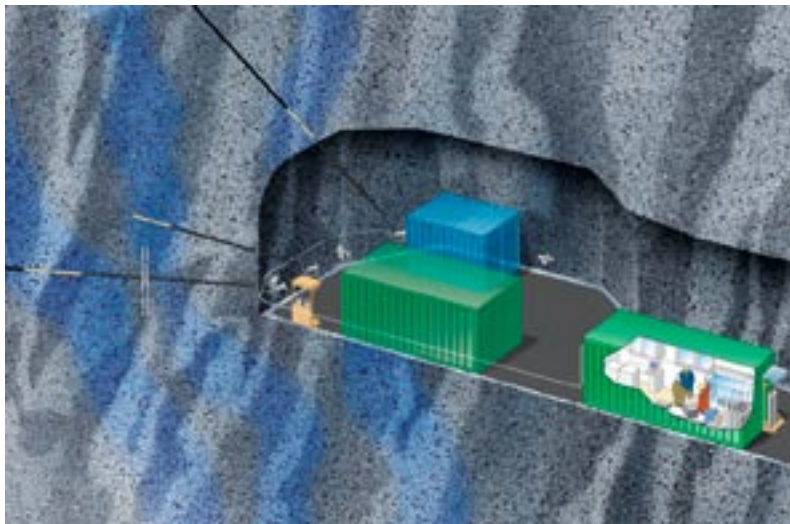
#### **Objectives**

The major objectives for the Microbe laboratory are to:

- Provide in situ conditions for the study of bio-mobilisation of radionuclides (Micomig).
- Present a range of conditions relevant for the study of bio-immobilisation of radionuclides (Micomig).
- Offer proper circumstances for research on the effect of microbial activity on the long term chemical stability of the repository environment (Micored).
- Enable investigations of bio-corrosion of copper under conditions relevant for a deep repository for spent fuel (Biocor).

#### **Experimental concept**

The Microbe laboratory is situated at the –450 m level in the F-tunnel (Figure 3-8). A laboratory container has been installed with laboratory benches and a climate control system. Three core drilled boreholes, KJ0050F01, KJ0052F01 and KJ0052F03, intersect water conducting fractures at 12.7, 43.5 and 9.3 m, respectively. They are connected to the Microbe laboratory via 1/8" PEEK tubing. The boreholes are equipped with metal free packer systems that allow controlled circulation of groundwater via respective fracture /Pedersen 2000/. Each borehole has been equipped with two circulation systems offering a total of 2,112 cm<sup>2</sup> of test surface in each circulation flow cell set up (four flow cells) for biofilm formation at in situ pressure, temperature and chemistry conditions. The systems operate at pressures around 30 bars. The flow through the flow cells is adjusted to 25–30 ml per minute, which corresponds to a flow rate over the surfaces of about 1 mm per second. Temperature is controlled and kept close to the in situ temperature at around 15–16°C. Remote alarms and a survey system have been installed for high/low pressure, flow rate and temperature. A detailed description of the Microbe laboratory can be found in an International Progress Report (IPR) /Pedersen 2005/.



**Figure 3-8.** The artists view of the Microbe 450 m site and the metal free packer configuration. The laboratory is situated in a steel container and connected to three discrete fractures in the rock matrix. PEEK tubing connects the systems in the lab with the groundwater.

## Results

A set of cultivation methods was adapted and applied in analysing the diversity of microorganisms using different electron acceptors and energy donors in deep groundwater. Groundwater from boreholes at Microbe in the Äspö HRL tunnel was analysed using the cultivation methods, and the results were compared to hydrogeochemical analysis data. The reproducibility of the cultivation methods was tested and evaluated. Methods for analysing microbial process rates were developed and tested under open and closed in situ conditions in a laboratory. Groundwater containing microorganisms from a fracture adjacent to the laboratory was circulated under in situ pressure and chemistry via flow cells that mimicked the conditions of fractured rock. The focus was determining the reduction rate of sulphate to sulphide and the production rate of acetate from hydrogen and carbon dioxide. A conceptual model of microbial processes that can be coupled to hydrogeochemical modelling have been outlined. The results have been compiled in a manuscript accepted for publication in Applied Geochemistry during 2008.

The Microbe site has been used as a base for investigations of the Prototype repository that offers a unique opportunity to explore microbe-gas-chemistry interactions in the bentonite buffer and backfill. Over all, the observations made strongly supported the present hypothesis (confer Micored) that oxygen will be consumed by bacteria within a short time span (i.e. weeks to years), as opposed to the long time span predicted by abiotic processes (many years). The gas data generally showed that oxygen is disappearing and that methane oxidizing bacteria (MOB) were responsible for at least some of the oxygen decrease. The microbes also affected the chemistry in the Prototype repository, both indirectly by being active and changing redox and pH and possibly directly with compound-specific ligands.

Analysis of the gases hydrogen, helium, nitrogen, oxygen, carbon monoxide, carbon dioxide, methane, ethane and ethene was performed on samples from 16 hydrochemical sampling points within the Prototype repository. The sampling points in the repository that delivered porewater were analysed for total number of cells (TNC), the amount of adenosine triphosphate (ATP), cultivable heterotrophic aerobic bacteria (CHAB), sulphate-reducing bacteria (SRB), MOB and autotrophic acetogens (AA). The collected porewater from the Prototype repository was sent for chemical analysis. The sampling and analysis protocols worked properly and were improved during 2007, when pressure vessels in stainless steel were introduced to extract porewater from the Prototype repository. By this, it was possible to extract water from nine of the 16 sampling points, compared to the previous six. During the years of examination of the gas composition, microbial composition and chemistry in the Prototype repository, it has been revealed that many of the hydro chemical sampling points differs quite remarkably from each other. The 16 sampling points have therefore been divided into seven sampling groups with similar properties. One sampling group (KBU10002+8) resembles the groundwater while others (KBU10004+6, KBU10005, KFA01-04) are different in e.g. microbial composition and salinity, sulphate content, concentration of Ca, K, Mg, Na, pH and many dissolved metals, actinides and lanthanides. One sampling group contains sampling points that seems to have contact with tunnel air (KBU10003+7). One sampling group contains sampling points near the canisters in the buffer (KB513, 514, 613 and 614) where most of the porewater likely evaporates leaving very little porewater with very high pH and salt content. One sampling point in the backfill has not yet been reached by the groundwater (KBU10001).

The gas composition in the sampling groups was uniform in the aspect that the nitrogen content was increasing and the oxygen content was decreasing with time. In most sampling groups, the oxygen content in the gas phase was around 3–7% (May 2007), which can be compared to the oxygen content in 2005 of 10–18%. Hydrogen, methane, helium and carbon dioxide concentrations varied, especially in the sampling groups with extractable porewater. The variation of these gases could be due to microbial activity. High numbers of MOB correlated with high oxygen content. High numbers of CHAB correlated with high carbon dioxide content and high numbers of AA correlated with high hydrogen content and low carbon dioxide content. Hydrogen seemed to stimulate SRB. ATP analyses showed that the biomass in the Prototype repository is increasing. The microbiological results showed that aerobic bacteria such as MOB and CHAB

bacteria thrived in the aerobic Prototype environment, where 120–2,300 times more microbes of the respective kind were found in comparison to the surrounding groundwater. Anaerobic SRB were increasing in abundance in the Prototype repository and were occasionally 12 times higher than the number of SRB outside the repository. AA was found in numbers 200 times over the surrounding groundwater. The chemistry data showed differences between the sampling groups. pH and concentrations of Na and K were higher in the porewater than in the groundwater outside. Ca and sometimes Mg were lower than in the groundwater. Obviously, cation exchange in the montmorillonite interlayers had occurred. Occasionally, high concentrations of Al, Ni, Zn and Cu were observed in the Prototype repository porewater. Corrosion of the heavy instrumentation can be a possible explanation. However, in sampling points with active microbes, Rb, Cs, V and U are enriched from two to over 400 times compared to the groundwater. It is possible that microbes were responsible of the dissolution by excretion of compound-specific ligands (confer Micomig below).

### **3.5.2 Micored**

#### ***Background***

Microorganisms can have an important influence on the chemical situation in groundwater /Haveman and Pedersen 2002/. Especially, they may execute reactions that stabilise the redox potential in groundwater at a low and, therefore, beneficial level for the repository. It is hypothesised that hydrogen from deep geological processes contributes to the redox stability of deep groundwater via microbial turnover of this gas. Hydrogen, and possibly also carbon monoxide and methane energy metabolisms will generate secondary metabolites such as ferrous iron, sulphide, acetate and complex organic carbon compounds. These species buffer towards a low redox potential and will help to reduce possibly introduced oxygen. The circulations in the Microbe laboratory have microbial populations that are reproducible in numbers and species distribution over time under stable hydrological conditions. All groups execute influence on the redox situation. Anaerobic microbial ecosystems generally force the redox potential towards the range of redox in which they are active. Iron and manganese reducing bacteria are active at higher redox potentials (approximately –100 to –200 mV) than the methanogens and acetogens (approximately –300 to –400 mV). Sulphate reducing bacteria are most active between the optimal redox potentials for those groups (approximately –200 to –300 mV). The stable populations of sulphate reducing bacteria and methanogens and acetogens at the Microbe laboratory makes it very well suited for research on the influence of microorganisms on the evolution and stability of redox potential in groundwater.

#### ***Objectives***

The major objectives for the Micored project are to:

- Clarify the contribution from microorganisms to stable and low redox potentials in near- and far-field groundwater.
- Demonstrate and quantify the ability of microorganisms to consume oxygen in the near- and far-field areas.
- Explore the relation between content and distribution of gas and microorganisms in deep groundwater.
- Create clear connections between investigations of microorganisms in the site investigations for a future repository and research on microbial processes at Äspö HRL.

#### ***Experimental concept***

Six underground circulation systems with flow cells for biofilm development have been installed in the Äspö HRL at 450 m depth /Nielsen et al. 2006/. They connect directly to aquifers at the in situ pressure of approximately 30 bars. The systems can be isolated from the

aquifer and groundwater with indigenous microbes is then circulated through the flow cells without contact with the aquifer. In the open mode, biofilms develop on the surfaces in the flow cells. When the systems are turned to the closed mode, the in situ pressure, and the anaerobic and reduced conditions are kept as in the open mode.

## **Results**

A suit of microbial isolates have been obtained, briefly characterized and archived. Several of these isolates have been further characterized. The micro-diversity of sulphate reducing bacteria has been investigated, with emphasis on *Desulfovibrio aespoeensis*. More than five closely related strains were discovered. The presence of a diverse suite of virus that attack bacteria was found in groundwater from 70 to 450 m in Äspö tunnel groundwater. Several viruses that are specific for *Desulfovibrio aespoeensis* have been isolated. The discovery of naturally occurring viruses in groundwater at numbers approaching a maximum of ten billion particles per litre of groundwater adds a new and very important dimension to modelling of microbial processes – predation. In addition, these numbers of bacteriophages, typical phage size is a couple of hundred nanometers, contribute significantly to the number of colloids in groundwater.

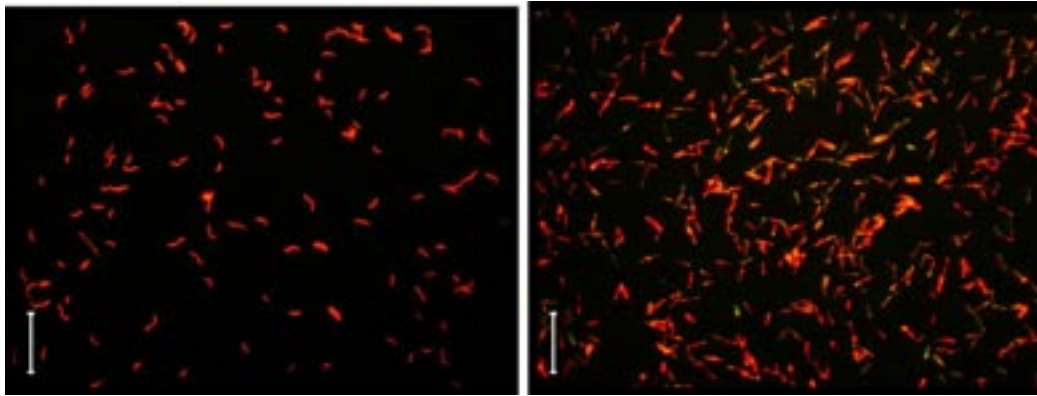
### **Effect of hydrogen on microbial growth and activity**

The circulation systems were used to investigate the effect of hydrogen on growth and activity during 2006. Publication is in progress. All three systems increased initially in cell numbers and the hydrogen added system increased most. This trend was consistent also for acetate and sulphide production. Acetate is produced by autotrophic acetogens. The cell numbers decreased after about a month, but the production of sulphide and acetate continued. This may look controversial at first, but we are convinced this is an effect from virus predation. When the cell numbers approached one million cells per litre groundwater, it seems as if the viruses became very contagious and forced the numbers back towards the numbers observed at start. The two most important results consequently are: 1) hydrogen stimulates microbial growth and activity, and 2) virus predation control microbial populations in the underground. The DNA of the biofilms has been extracted, cloned and sequenced. Microscopic investigations revealed significant differences in morphology as a result of the treatments. The acetate system developed very large cells with an unusual, worm-like morphology, while the hydrogen system fostered thin, *Hyphomicrobium* like biofilms. The control showed a mixture of these morphologies. Clone libraries have now been established, we presently use quantitative PCR (Q-PCR) to determine the amounts of different species. Methods for genetic characterisation will be continuously adapted. Circulation experiments with various combinations of energy sources will be continued and followed with microelectrodes, cultivations, DNA sequence determinations and with functional and species specific genetic probes.

### **Microdiversity**

Four strains of *Desulfovibrio aespoeensis* (Da2, 3, 5, 22) and five of *Acetobacterium carbinolicum* (Ac1–4, 6) were isolated from groundwater at 450 m depth in the tunnel at Äspö HRL and identified with the 16S rRNA and adenosine 5'-phosphosulphate A (apsA) gene sequences. In addition, the type strain of *D. aespoeensis* previously isolated from Äspö was investigated [Motamedi and Pedersen 1998]. The newly isolated *D. aespoeensis* strains had identical 16S rRNA and apsA gene sequences but differed in 8 and 30 positions, respectively, compared to the type strain of *D. aespoeensis*. The five strains of *A. carbinolicum* had identical 16S rRNA gene sequences. This sequence was identical to the sequence of *A. carbinolicum* X96956.

Recently, we discovered that the isolated *D. aespoeensis* (Da) strains had different morphologies (Figure 3-9). Therefore, we examined the genotypic and phenotypic diversity of the *D. aespoeensis* strains and also of the *A. carbinolicum* (Ac) strains further. The whole genome



**Figure 3-9.** Fluorescent microscopy of the vibrioid *D. aespoeensis* strain Da22 (to the left) and the rod shaped *D. aespoeensis* strain Da3 (to the right) stained with acridine orange. The bars represent 10  $\mu\text{m}$ .

was investigated using Enterobacterial Repetitive Intergenomic Consensus PCR (ERIC-PCR). To evaluate if the differences in genotypes were reflected in the phenotypes, the strains were incubated at several temperatures, salt concentrations and with different carbon sources.

The ERIC-PCR revealed a clear genetic diversity of the analysed strains. All Da strains had substantially different ERIC-PCR patterns compared to the type strain of *D. aespoeensis*. The Da strains, especially strain Da3, differed between themselves in ERIC-PCR profiles despite identical 16S rRNA and *apsA* sequences. Strain Ac1 and Ac2 had almost identical ERIC-PCR profiles. Ac6 had a similar profile compared to these but nevertheless lacked the 1,400 bp long band, which existed in Ac1 and Ac2. Ac3 and Ac4 were similar to each other and lacked bands longer than 500 bp.

The genotypic diversity of the 10 strains, revealed by ERIC-PCR, was clearly reflected in the phenotype. The cells of the Da strains were slightly longer than the type strain of *D. aespoeensis*. This strain also differed from the other Da strains in its optimal, lower, growth temperature and inability to grow on lactate without addition of yeast extract. The phenotypic diversity was reflected in Da3 being a straight rod compared to the vibrioid shape of Da2, 5 and 22. Furthermore, Da3 was able to grow autotrophically on H<sub>2</sub> without addition of yeast extract. All the Da strains grew best at 37°C and with 0.7% NaCl. However, strain Da5 and Da22 (having identical ERIC-PCR profiles) grew only slightly faster at 37°C compared to 16°C–22°C, while Da2 grew considerably faster at 37°C compared to 16°C–22°C. Strain Ac1 and Ac2 had similar ERIC-PCR profiles and grew in the temperature interval 22°C–37°C. Strain Ac3 and Ac4 had similar ERIC-PCR profiles and grew in the temperature interval 16°C–22°C. Strain Ac6, with a unique ERIC-PCR profile, differed from the other Ac strains in the ability to grow on lactate without addition of yeast extract and to grow in a wide NaCl interval (0.7%–4%).

In conclusion, the genotypic ERIC-PCR profiles and the phenotypic characters of the studied *D. aespoeensis* and *A. carbinolicum* strains were investigated independently of each other and were found to correlate. ERIC-PCR and phenotypic characterisation revealed a strain diversity that was absent in the 16S rRNA gene sequence information. Differences in the phenotype as well as the genotype were evident for the *D. aespoeensis* and *A. carbinolicum* strains, despite identical 16S rRNA gene sequences. Micro-diversity is clearly present among microbes isolated from the deep Äspö HRL biosphere.

### Viruses in deep groundwater

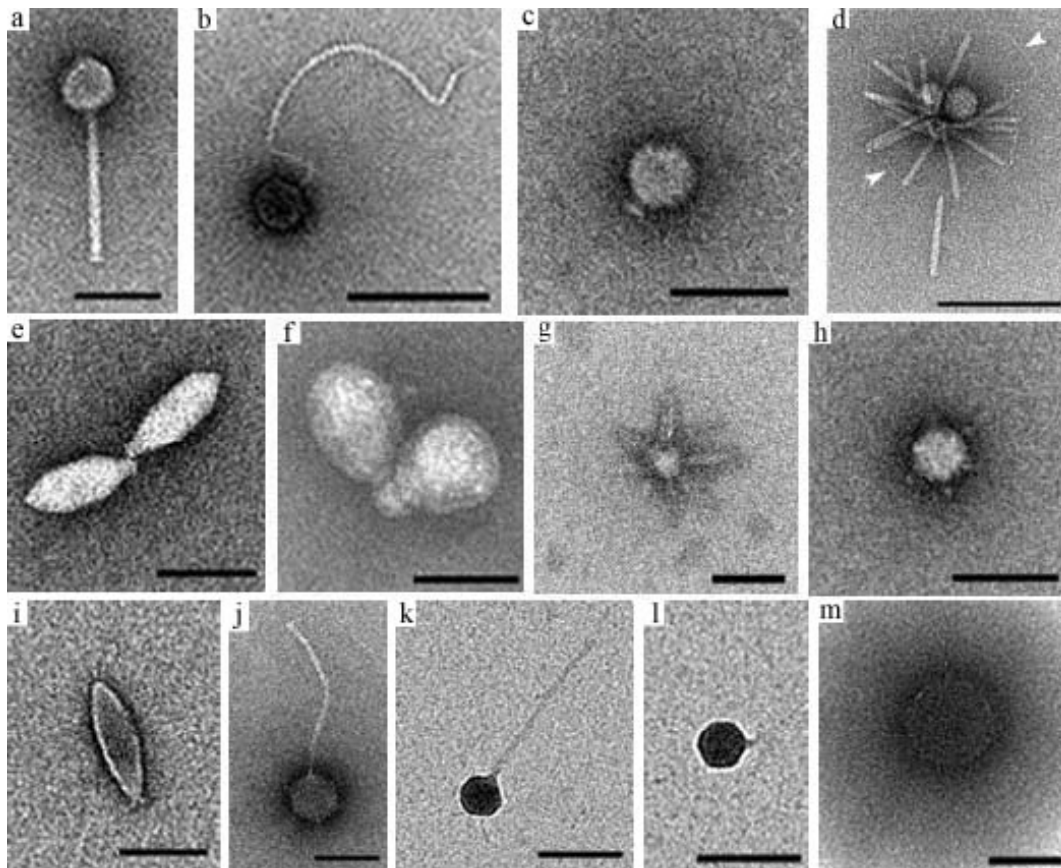
Groundwater samples were collected from 69 to 450 m below the surface from Äspö HRL to determine if viruses are present and active members of the deep subterranean biosphere /Kyle et al. 2008/. Fluorescent microscopy counts were in the range of 10<sup>5</sup> to 10<sup>7</sup> virus-like particles

(VLP)  $\text{mL}^{-1}$  groundwater. Principle component analysis revealed strong positive correlations of VLPs with bacterial abundance and dissolved organic carbon, and strong negative correlations with salinity and ionic strength. Transmission electron microscopy revealed four distinct bacteriophage groups (polyhedral, tailed, filamentous, and pleomorphic) within the subsurface with at least seven phage families of which some are known to be lytic (Figure 3-10). The presence of lytic viruses in deep groundwater is a direct indicator of predator-prey (virus-microbe) interactions in intraterrestrial ecosystems that would release nutrients (i.e. cellular debris) into the system. The infection of microorganisms by viruses also contributes to DNA transfer, implying that viral transduction is important for the diversification of intraterrestrial microorganisms. Modelling of microbial effects in a future repository must include the effect from viruses on the microbial populations.

### 3.5.3 Micomig

#### Background

It is well known that microbes can mobilise trace elements /Pedersen 2002/. Firstly, unattached microbes may act as large colloids, transporting radionuclides on their cell surfaces with the groundwater flow. Secondly, microbes are known to produce ligands that can mobilise soluble trace elements and that can inhibit trace element sorption to solid phases /Johnsson et al. 2006, Essén et al. 2007/.



**Figure 3-10.** Transmission electron micrographs of viruses from Åspö HRL groundwater. Viral morphotypes found near depths of 69 m (a–h), 294 m (i, j), 415 m (k, l), and 447 m (m) are shown: a, Siphoviridae (B1); b, polyhedral virus with base plate; c, Myoviridae with base plate; and d, Inoviridae connected by filaments around the outer ends (arrows). Two polyhedral viruses are also shown: e, Salterprovirus; f, Guttaviridae; g, polyhedral virus with spike-like protrusions; h, polyhedral virus (STIV-like); i, Fuselloviridae with twinned tail; j, Siphoviridae (B1) with curved tail; k, Siphoviridae (B1) with straight tail; and m, polyhedral virus. Scale bar is 125 nm, except in a and d where it is 250 nm.

A large group of microbes catalyse the formation of iron oxides from dissolved ferrous iron in groundwater that reaches an oxidising environment /Ferris et al. 1999, 2000/. Such biological iron oxide systems (Bios) will have a retardation effect on many radionuclides. Typically, microbes form stalks and sheaths that increase the volume of the iron oxides from densely packed inorganic oxides to a fluffy, rust-like material with water contents of up to 99%. The microbes contribute to the exposure of a large oxide area to trace elements flowing by with the groundwater and the organic biological material adds a strong retention capacity in addition to iron oxides /Anderson and Pedersen 2003, Anderson et al. 2006c/.

Biofilms in aquifers will influence the retention processes of radionuclides in groundwater. Recent work /Anderson et al. 2006ab/ indicate that these surfaces adsorb up to 50% of these radionuclides in natural conditions with  $K_a$ -values (m) approaching  $10^5$  and  $10^6$  for Co and Pm respectively. The formation of colloids accounted for a further 20% to 40% of aqueous Co and Pm complexation. The anaerobic biofilms and rock surfaces share similar adsorption capacities for Pm but not for Co. The biofilms seemed to isolate the rock surface from the groundwater as diffusion to the rock surface must first proceed through the biofilms. The possible suppression of adsorption by biofilms needs further research. So far this has been observed only with one biofilm type in one Microbe laboratory circulation.

### **Objectives**

The major objectives for the Micomig project are to:

- Evaluate the influence from microbial complexing agents on radionuclide migration.
- Explore the influence of microbial biofilms on radionuclide sorption and matrix diffusion.

### **Experimental concept**

In situ formation of complexing agents in the Microbe laboratory circulations have been investigated /Essén et al. 2007/. The experimental concept from laboratory work /Johnsson et al. 2006/ was adapted to the field. Following up these experiments, pressure safe containers will be amended with radionuclide cocktails and groundwater from closed and active Microbe laboratory circulations will be added under ambient pressure, pH and redox potential. The distribution of the radionuclides between solid and liquid phases will be analysed as previously done in the laboratory.

New experiments with biofilm effects on radionuclide migration will utilise the tested and recently published experimental concept /Anderson et al. 2006ab/. Different groundwater will be analysed. The types of biofilm microorganisms have been analysed. It is planned to drill for the analysis of biofilms on fracture surfaces during 2008.

### **Results**

#### **Siderophores produced by *Pseudomonas stutzeri***

The siderophore production of the facultative anaerobe *Pseudomonas stutzeri*, strain CCUG 36651, grown under both aerobic and anaerobic conditions, was investigated by liquid chromatography and mass spectrometry. The bacterial strain has been isolated at a 626 m depth at the Äspö HRL, where experiments concerning the geological disposal of nuclear waste are performed. In bacterial culture extracts, the iron in the siderophore complexes was replaced by gallium to facilitate siderophore identification by mass spectrometry. *P. stutzeri* was shown to produce ferrioxamine E (nocardamine) as the main siderophore together with ferrioxamine G and two cyclic ferrioxamines having molecular masses 14 and 28 atomic mass units lower than that of ferrioxamine E, suggested to be ferrioxamine D2 and ferrioxamine X1, respectively. In contrast, no siderophores were observed from anaerobically grown *P. stutzeri*. None of the siderophores produced by aerobically grown *P. stutzeri* were found in anaerobic natural water samples from the KJ0052F01 borehole circulation at the Microbe site /Ekendahl et al. 2003, Essén et al. 2007/.

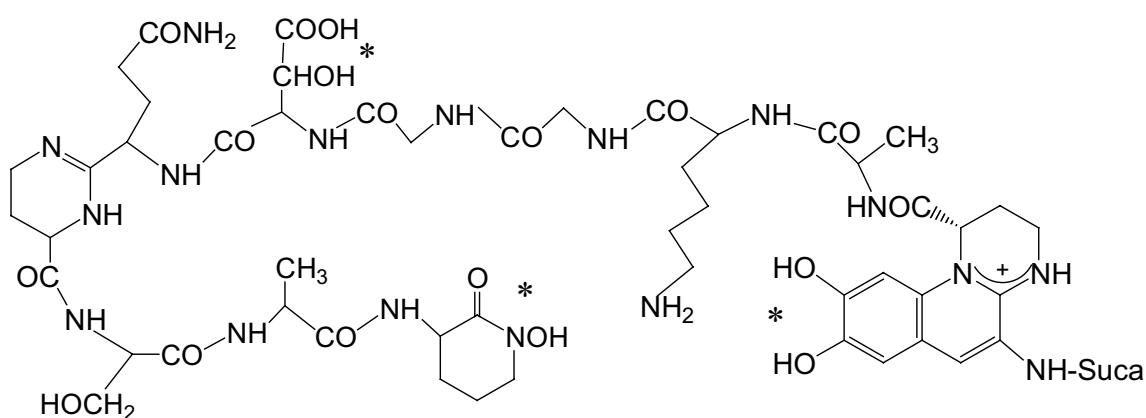


The information gained from the deep groundwater investigation is valuable with respect to the safety analyses of future repositories for spent nuclear fuel. High concentrations of the complexing compounds in question would enhance the transport of several radionuclides because many radionuclides combine with siderophores as discussed in the introduction. Of course, the results here represent only a few of many possible conditions in and around a repository, but the first steps have been taken with respect to method development in the survey of deep groundwater environments for the presence of microbially produced complexing compounds. Future investigations should be expanded to search for complexing compounds produced by fungi in the near and far fields of a repository /Reitner et al. 2005/. Fungi have been found in groundwater, and they are present in the bentonite clay to be used as backfill and buffer. A larger variety of groundwater than investigated here should also be scanned for complexing compounds, and the array of methods for their detection may need to be expanded. This was, to our knowledge, the first study that has analysed anaerobic cultures or has investigated anaerobic deep groundwater samples specifically for the presence of siderophores.

### Siderophores produced by *Pseudomonas fluorescens*

Several *Pseudomonas* species synthesize siderophores called pyoverdins under iron-deficient conditions. Pyoverdins produced by different species display many structural similarities: they are yellow–green, water-soluble, and, due to the presence of a chromophore, fluorescent pigments that are very effective in complexing and transporting iron (III). Structurally, they can be divided into three different parts: a) a peptide chain composed of 6 to 12 mainly hydrophilic amino acids bound via their N-termini to the carboxyl group of the chromophore, b) the chromophore (1S)-5-amino-2,3-dihydro-8,9-dihydroxy-1H-pyrimido[1,2-a]quinoline-1-carboxylic acid and c) an acyl chain attached to the NH<sub>2</sub> group of the chromophore consisting of dicarboxylic acid residues, for example, succinate or its amide form depending on the growth conditions (Figure 3-11). The composition of the peptide chain displays great diversity depending on the producing strain. To date, more than 50 different pyoverdins have been reported in the literature. So far only one pyoverdin produced by a *P. fluorescens* strain has been structurally determined using X-ray analysis.

Pyoverdin-type siderophores have a high potential to dissolve, bind, and thus transport uranium in the environment. The formation of complexes of UO<sub>2</sub><sup>2+</sup> with pyoverdins released by the groundwater bacterium *Pseudomonas fluorescens* (CCUG 32456) isolated at a depth of 70 m



**Figure 3-11.** Structure of the pyoverdin from *P. fluorescens* (CCUG 32456) with a succinamide (Suca) side chain (Suca-Chr-Ala-Lys-Gly-Gly-OH)Asp-(Gln-Dab)-Ser-Ala-cOHOrn). Asterisks indicate the complexation sites. The amino acids Ala, Lys, and Gln (underlined) are D-configured.

in the Äspö HRL was studied. Mass spectrometry indicated that the cells produce a pyoverdinin mixture with four main components: pyoverdinin with a succinamide side chain, pyoverdinin with a succinic acid side chain, ferribactin with a succinamide side chain, and ferribactin with a glutamic acid side chain. Three pK values could be determined from the pH-dependent changes in the absorption spectra of the pyoverdinin mixture:  $\log \beta_{012} = 22.67 \pm 0.15$  ( $\text{pK}_1 = 4.40$ ),  $\log \beta_{013} = 29.15 \pm 0.05$  ( $\text{pK}_2 = 6.48$ ), and  $\log \beta_{014} = 33.55 \pm 0.05$  ( $\text{pK}_3 = 10.47$ ). The fluorescence properties of the pyoverdinin mixture were pH dependent. The emission maximum changed from 448 nm at pH = 2.1 to 466 nm in the pH 3.8–8.9 range. At pH > 4 a monoexponential fluorescence decay dominates with a decay time of  $5,865 \pm 640$  ps. A drastic change in the intrinsic fluorescence properties, e.g. static fluorescence quenching, occurred due to the complex formation with  $\text{UO}_2^{2+}$ . Species containing  $\text{UO}_2^{2+}$  of the type  $\text{M}_p\text{L}_q\text{H}_r$  were identified from the dependencies observed in the ultraviolet visible and time-resolved laser-induced fluorescence spectroscopy spectra at pyoverdinin concentrations below 0.1 mM. The following average formation constants were determined:  $\log \beta_{112} = 30.00 \pm 0.64$  and  $\log \beta_{111} = 26.00 \pm 0.85$  at ionic strength  $I = 0.1$  M ( $\text{NaClO}_4$ ). The determined stability constants can be used directly in safety calculations of the mobilizing effect of released pyoverdins on uranium, in uranium-contaminated environments such as mine and radioactive waste disposal sites.

### 3.6 Matrix Fluid Chemistry Continuation

#### **Background**

The first phase of the Matrix Fluid Chemistry experiment (1998–2003) increased the knowledge of matrix pore space fluids/groundwaters from crystalline rocks of low hydraulic conductivity ( $K < 10^{-10}$  ms<sup>-1</sup>), and this complemented the hydrogeochemical studies already conducted at Äspö. The results of this first phase were published in early 2004 /Smellie et al. 2003/.

The continuation phase (2004–2006) focussed on areas of uncertainty which remain to be addressed:

- The nature and extent of the connected porewaters in the Äspö bedrock (chemical, hydraulic and transport properties).
- The nature and extent of the microfracture groundwaters which penetrate the rock matrix (chemical, hydraulic and transport properties) and the influence of these groundwaters (by in- and out-diffusion) on the chemistry of the porewaters.
- The confirmation of rock porosity values previously measured in the earlier studies.

This continuation phase also saw the completion of a feasibility study to assess the effects on the matrix borehole and its surroundings due to the untimely excavation of a new tunnel for the Äspö Pillar Stability Experiment carried out in April/May 2003. There was concern that repercussions from this excavation may have influenced the hydraulic (and therefore the hydrochemical) character of the matrix borehole and the host rock vicinity.

#### **Objectives**

Because of the possibility that the hydraulic and hydrochemical character of the matrix borehole and the host rock vicinity has been disturbed, the following objectives were identified:

- To establish the impact of tunnel construction on the matrix borehole by evaluating the monitored pressure profiles in the hydro monitoring system (HMS) registered on the isolated borehole sections during the period of construction (small-scale).
- To establish the impact of tunnel construction on boreholes located in the near-vicinity of the matrix borehole in the F-tunnel by similar means (large-scale).

- If the evaluation indicates that the rock hosting the matrix borehole has been unaffected by tunnel construction, the experiment will proceed first to hydrochemically and hydraulically characterise the presently isolated borehole sections containing microfractures and, secondly, to hydrochemically and hydraulically characterise the original fracture-free borehole sections.
- To carry out additional porosity measurements on drillcore samples to be compared with values already measured.

### **Experimental concept**

The first phase of the Matrix Fluid Chemistry Experiment was designed to sample matrix porewater from predetermined, isolated borehole sections. The borehole was selected on the basis of: (a) rock type, (b) mineral and geochemical homogeneity, (c) major rock foliation, (d) depth in the tunnel, (e) presence and absence of fractures, and (f) existing groundwater data from other completed and ongoing experiments at Äspö HRL.

Special downhole equipment, see Figure 3-12, was constructed ensuring: (a) an anaerobic environment, (b) minimal contamination from the installation, (c) minimal dead space in the sample section, (d) the possibility to control the hydraulic head differential between the sampling section and the surrounding bedrock, (e) in-line monitoring of electrical conductivity and drilling water content, (f) the collection of porewaters (and gases) under pressure and (g) convenient sample holder to facilitate rapid transport to the laboratory for analysis.

This experimental equipment, with some modifications, is being used in the continuation phase to sample groundwaters from the microfractures, to measure the hydraulic parameters of the microfractures and the rock matrix, and finally to conduct the long term in situ diffusion experiment.

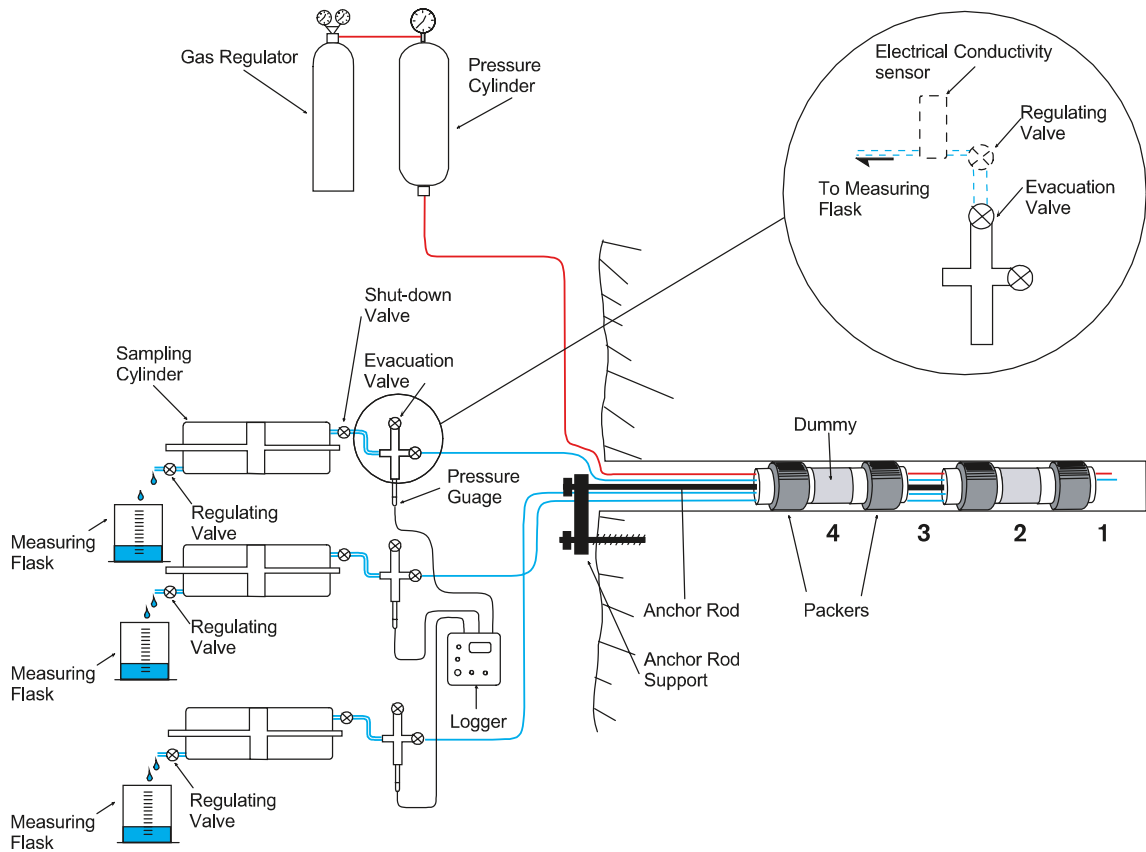
### **Results**

No new data were expected during 2007. Emphasis was planned on compilation and reporting of 2006 results based on analytical data from matrix porewater sampling in May 2005 and data from hydraulic measurements which were carried out in the matrix borehole during 2006. Unfortunately because of time constraints this was not achieved. However, some of the matrix porewater analytical data have been presented and discussed /Waber and Smellie 2008/.

## **3.7 Padamot**

### **Background**

Palaeohydrogeology is a relatively new term used as a common name for information from fracture minerals that is used for interpretations of past hydrogeochemical and hydrogeological systems. The need for such interpretations has become evident in the geological/hydrogeological modelling of sites within the radwaste programmes of several countries. An EC-founded 3-year project with the name Equip (Evidences from Quaternary Infills for Palaeohydrogeology) was therefore started in 1997. When the Equip project ended in 2000 /Bath et al. 2000/ there was a need for continued fracture mineral investigations and model testing of the obtained results. A new EC-project called Padamot (Palaeohydrogeological Data Analysis and Model Testing) was therefore initiated in the beginning of 2002 and was ended and reported to EC in 2005. A continuation of the Swedish part of the project at Äspö has thereafter been agreed by SKB. This is called Padamot Continuation.



**Figure 3-12.** Matrix Fluid Chemistry Experimental set-up. Borehole Sections 2 and 4 were selected to collect matrix fluid, sections 1–4 were continuously monitored for pressure.

### Objectives

The objectives for the Padamot Continuation project include:

- Further developments of analytical techniques for uranium series analyses applied on fracture mineral samples.
- Focus on the use of these analyses for determination of the redox conditions during glacial and postglacial time.
- Summarise the experiences of palaeohydrogeological studies carried out at Äspö.

### Results

The uranium series analyses are carried out on samples from boreholes KAS17 at Äspö. This borehole penetrates the large E-W fracture zone called the Mederhult zone and several sections with fractured rocks are intersected by the borehole. Six samples from different depths (ranging from 19 to 200 m core length) have been sieved into different grain sizes and the most fine grained (usually  $< 0.125 \mu\text{m}$ ) fractions have been split into three (and if possible four) parts.

Two samples were used for uranium series analyses at two different laboratories; Helsinki University and SUERC in Glasgow. The analyses will be carried out using different techniques, both whole sample analysis and sequential leaching were applied by the two laboratories and results will be interpreted in common. The results available at present are from Helsinki University. The results are very promising in that the samples seem to mirror the redox front, both mobilisation and deposition of uranium are shown by the samples. In addition, the results obtained with whole sample technique and sequential leaching technique seems to be in good correspondence with each other. More analyses will be carried out during the spring 2008.

One sample was analysed using ICP (chemical characterisation) which also included determination of the ratio  $^{234}\text{U}/^{238}\text{U}$  with mass spectrometry. The fourth part was used for XRD diffractometry in order to determine the mineralogical composition. The results from the ICP and XRD analyses showed that the sampled material consist of quartz, K-feldspar, albite, chlorite, calcite and clay minerals of mixed layer clay type. Uranium contents in the samples varied from 6 to 27 ppm.

A paper presenting the methodology for palaeohydrogeological studies applied in the presently ongoing site investigations at Forsmark and Simpevarp is accepted for publication in Applied Geochemistry.

### 3.8 Fe-oxides in Fractures

#### **Background**

Uptake of radioactive elements in solid phases can lead to immobilisation, thus minimising the release to the environment. Uptake extent depends on solution conditions such as concentration, pH, Eh, temperature, pressure and the presence of other species. Transition metals, lanthanides and actinides are often incorporated by identical processes. Therefore, better understanding of the behaviour of the two first groups mentioned strengthens the understanding also of the actinides, which are difficult to study. Moreover, presence of trace components in minerals can provide information about a mineral's genesis conditions and history.

Fractures lined with Fe-oxides are found in the Äspö bedrock and they are present as minor components nearly everywhere at the Earth's surface. Their affinity for multivalent species is high but Fe-oxide uptake of lanthanides and actinides has not been studied to any great extent. Fe(II)-oxyhydroxides, known as "green rust", form in Fe-bearing solutions under reducing conditions and are associated with the early stages of corrosion. Their uptake capacity during formation and transition to Fe(III)-oxides is essentially unknown at present. These minerals could be an important sink for radioactive species where Fe is abundant in the natural fractures or in materials brought into the repository. Fe itself can be an indicator of redox state. Fe-isotope fractionation, a very new topic of research, might give clues about redox conditions during Fe-mineral formation or as a result of its inclusion in other secondary fracture minerals.

There are three questions relevant for radioactive waste disposal in fractured granite:

- How extensive is the capacity for Fe(III)-oxides, in fracture linings, to take up and retain radionuclides or other toxicants from solutions, and what happens during transformation of the oxides to more stable phases?
- What capacity do the reduced Fe(II)-oxides have for uptake and retention?
- Does the suite of trace components and isotopes measured in minerals from fracture linings provide information about conditions of the water that passed through them in the past?

These questions can be rephrased more specifically, for direct application to problems for Swedish waste disposal, as:

- Can more detailed information about the uptake of higher valent elements such as  $\text{Eu}^{3+}$  provide a model for actinide behaviour and  $\text{Cr}^{3+}$  as a palaeo-redox-indicator?
- Can stable Fe-isotopes from Fe-oxides or from other minerals tell us anything about solution conditions during genesis?
- What is the uptake and retention capacity of green rust under solution conditions relevant for Äspö?
- Is it possible to find evidence to support or dispute the hypothesis that, at the time of glacier retreat, oxidising water might have penetrated to or below the depth of the planned final repository?
- How might secondary Fe-minerals affect the migration of radionuclides released from a repository?

### **Objectives and experimental concept**

The basic idea of the project is to examine Fe-oxide fracture linings, in order to explore suitable palaeo-indicators and their formation conditions. For example, potential low temperature oxidation under a deglaciation is expected to result in the removal of Fe (II)-bearing phases with precipitation of Fe (III) oxides. At the same time knowledge about the behaviour of trace component uptake can be obtained from natural material as well as through studies in the laboratory under controlled conditions.

A glove-box set-up, where Atomic Force Microscopy is possible in situ, will be used to investigate green rust under a stable atmosphere at reducing conditions. More possibilities for extracting chemical information from the secondary Fe-oxides will be tested and the merits of stable Fe- and O-isotope fractionation as well as Mössbauer (MS) and energy dispersive X-ray (EDS) spectroscopy will be examined.

### **Results**

The main activity carried out in 2007 involved the major analytical part of the continuation phase of the project entitled: 'To establish the penetration depth of oxidising waters below ground surface'; this is related to potential effects from a deglaciation. The work has largely been on schedule and has involved the following components.

#### **X-ray diffraction, Mössbauer Spectroscopy and Electron Microscopy**

These studies were carried out to identify the different Fe-oxides and Fe-oxyhydroxides (e.g. haematite, goethite and magnetite). Three types of Fe-oxides have been identified:

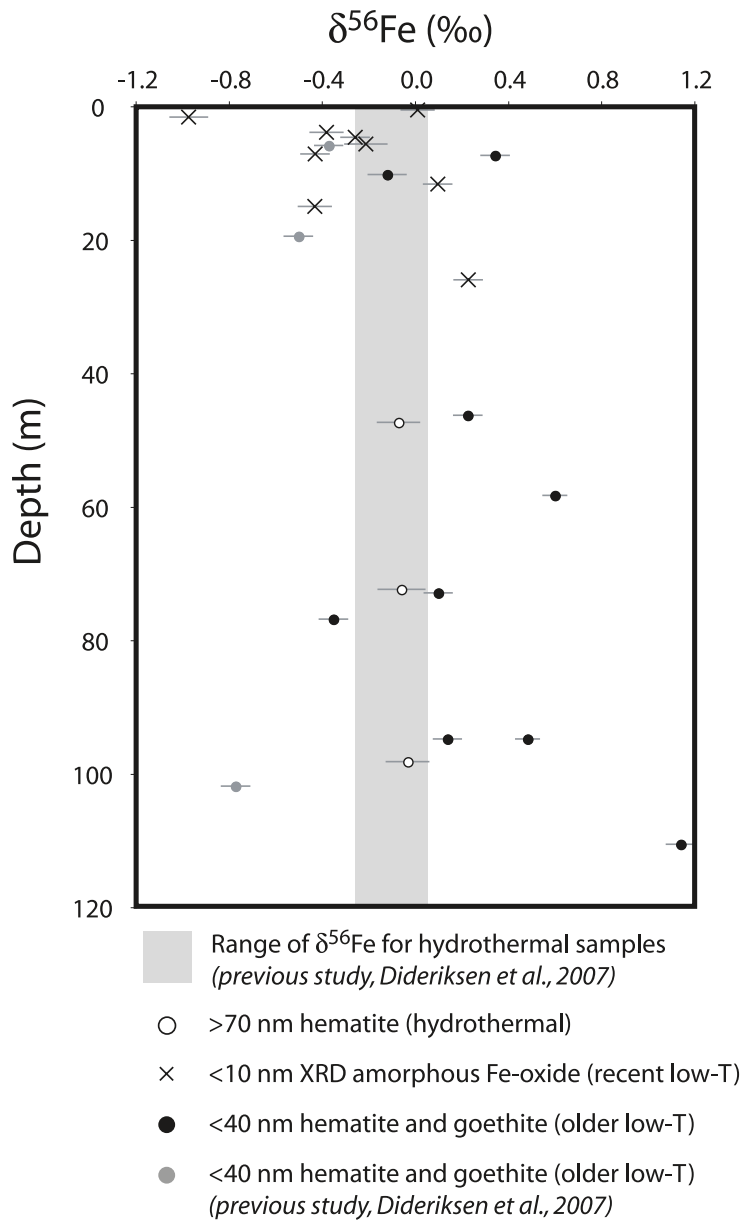
- Well-crystallised haematite with grain-size above 70 nm (hydrothermal origin).
- X-ray amorphous Fe-oxide with grain-size below 10 nm (recent, low-temperature origin).
- Well-crystallised haematite with grain-size below 40 nm and goethite (older, low temperature origin).

#### **Iron isotope composition**

Fe isotopes are expected to fractionate more at lower temperature. Thus, the Fe-isotope composition of low-temperature samples should be more extreme. By using iron isotope systematics it was possible to differentiate between hydrothermal haematites and both recent, and older, low temperature Fe-oxides (see Figure 3-13). The results found that low-temperature Fe-oxides formed  $\leq 100$  m below surface, in a region of high hydraulic conductivity.

Amorphous and very fine-grained Fe-oxides have been identified down to approximately 20 m and crystalline fine-grained Fe-oxides down to approximately 50 m. In addition, finer-grained goethite has been identified to depths of approximately 60 m and 90 m respectively, which is interesting because it is not usually found in such environments.

Although the study is not complete, these results suggest that iron oxides have formed at low-temperature down to 50 m below surface and possibly even down to a depth of approximately 90 m (Figure 3-13). Unfortunately, the lower boundary for the passage of oxidised water is constrained by having only two hydrothermal samples. To resolve this situation, an additional three samples from the longer drill core KLX09A have been made available to look for Fe-oxides at greater depth. The following work will include further microanalysis of the near-surface Fe-oxides to confirm their origin and studying of the samples collected from greater depths along hydraulically-active fracture zones to determine the maximum potential extent of these low temperature Fe-oxides.



**Figure 3-13.** Differentiation between hydrothermal haematites and both recent and older low temperature Fe-oxides using iron isotope systematics. The data show clearly the greater fractionation of Fe isotopes at lower temperatures.

### 3.9 Swiw-tests with Synthetic Groundwater

#### Background

The Single Well Injection Withdrawal (Swiw) tests with synthetic groundwater constitute a complement to performed tests and studies on the processes governing retention, e.g. the True-1 and the True Block Scale experiments as well as Swiw tests performed within the SKB site investigation programme. This project aims to deepen the understanding for the processes governing retention. Swiw tests with synthetic groundwater facilitate the study of diffusion in stagnant water zones and in the rock matrix. It also facilitates the possibility to test the concept of measuring fracture aperture with the radon concept.

## **Objectives**

The general objective of the Swiw test with synthetic groundwater is to increase the understanding of the dominating retention processes and to obtain new information on fracture aperture and diffusion.

## **Experimental concept**

The basic idea is to perform Swiw tests with synthetic groundwater with a somewhat altered composition, e.g. replacement of chloride, sodium and calcium with nitrate, lithium and magnesium, compared to the natural groundwater at the site. Sorbing as well as non-sorbing tracers may be added during the injection phase of the tests. In the withdrawal phase of the tests the contents of the “natural” tracers (chloride, sodium and calcium) as well as the added tracers in the pumping water is monitored. The combination of tracers, both added and natural, may then provide desired information of diffusion, for example if the diffusion is dominated by the rock matrix or stagnant zones.

## **Results**

The work within Swiw with synthetic groundwater during 2007 consisted of a feasibility study. The objectives of the study were to investigate if True Block scale may be used as a test site, to investigate the possibility of producing synthetic groundwater of sufficient purity and amount and finally to perform scoping calculations in order to simulate and optimize the tests.

The original location in mind for the tests was the True Block Scale site and the well characterised Structures #19 and #20. The feasibility study shows that the site would be suitable for the tests. However, the ongoing work with a new tunnel in the vicinity blocks the site for Swiw tests until the tunnel is completed (early 2009). At that point the hydraulic conditions at the site may be altered significantly so that a performance of Swiw tests there may be unsuitable or impossible. Hence, a new site to perform the Swiw tests may be necessary to find.

The feasibility study shows that the combination of tracers and Swiw tests with and without waiting period presents new opportunities to investigate if the diffusion is dominated by fast or slow processes, i.e. if the diffusion is dominated by stagnant zones or rock matrix. The study also shows that it is possible to produce synthetic groundwater of sufficient purity and amount.

The plan for 2007 also, besides the feasibility study, included to write a project plan and to prepare for pre-tests and main tests. However, since the test site in mind for the experiments, True Block Scale, was occupied and no decision about an alternative site was taken during 2007, no preparation for tests was possible.

## **3.10 Task Force on Modelling of Groundwater Flow and Transport of Solutes**

### **Background**

The work within Äspö Task Force on modelling of groundwater flow and transport of solutes constitutes an important part of the international co-operation within the Äspö HRL. The group was initiated by SKB in 1992. A Task Force delegate represents each participating organisation and the modelling work is performed by modelling groups. The Task Force meets regularly about once to twice a year.



Different experiments at the Äspö HRL are utilised to support the Modelling Tasks. To date modelling issues and their status are as follow:

- Task 1: Long term pumping and tracer experiments (completed).
- Task 2: Scooping calculations for some of the planned detailed scale experiments at the Äspö site (completed).
- Task 3: The hydraulic impact of the Äspö tunnel excavation (completed).
- Task 4: The Tracer Retention and Understanding Experiment, 1<sup>st</sup> stage (completed).
- Task 5: Coupling between hydrochemistry and hydrogeology (completed).
- Task 6: Performance assessment modelling using site characterisation data (ongoing).
- Task 7: Long-term pumping experiment (ongoing).

### **Objectives**

The Äspö Task Force is a forum for the organisations supporting the Äspö HRL project to interact in the area of conceptual and numerical modelling of groundwater flow and solute transport in fractured rock. In particular, the Task Force shall propose, review, evaluate, and contribute to such work in the project. The Task Force shall interact with the principal investigators responsible for carrying out experimental and modelling work for Äspö HRL of particular interest for the members of the Task Force.

Much emphasis is put on building of confidence in the approaches and methods in use for modelling of groundwater flow and migration in order to demonstrate their use for performance and safety assessments.

The ongoing Task 6 was initiated in 2001, and is now in the final reporting stage. Task 6 does not contain experimental work but it uses experimental results of the former Task 4 and True Block Scale project. Task 4 included a series of tracer tests performed in a single feature over transport distances of about 5 m using simple flow geometry and both conservative and sorbing tracers. In True Block Scale, a series of tracer tests was performed in a fracture network over tens of metre distances. The main objectives of Task 6 are to:

- Assess simplifications used in performance assessment (PA) models.
- Assess the constraining power of tracer experiments for PA models.
- Provide input for site characterisations programme from PA perspective.
- Understand the site-specific flow and transport at different scales using site characterisation models.

Task 7 was presented at the 19<sup>th</sup> International Task Force meeting in Finland, 2004. Hydraulic responses during construction of a final repository are of great interest because they may provide information for characterisation of hydraulic properties of the bedrock and for estimation of possible hydraulic disturbances caused by the construction. Task 7 will focus on the underground facility Onkalo at the Olkiluoto site in Finland, and is aimed at simulating the hydraulic responses detected during a long-term pumping test carried out in borehole KR24. In addition, Task 7 is addressing the usage of Posiva Flow Log (PFL) data and issues related to open boreholes.

### **Results**

In the Task Force on groundwater flow and transport of solutes, work during 2007 has been in progress in Task 6 and 7. Task 6 addresses performance assessment modelling using site characterisation data and Task 7 addresses a long-term pumping test in Olkiluoto, Finland.

Occasionally, there is work done in so-called Meta Tasks, which are normally not directly coupled to a specific modelling task, but have an overview perspective. Such a task has been performed this year. It was dedicated to compile comments from reviewers on task management. The document has been published on the projects internal web site with the intention that the advices could be utilised for future tasks.

In Task 6, all modelling reports, except one, have been printed. The final manuscript to the missing modelling report has been received. The review report covering sub-task 6D–6F has been printed as well /Hodgkinson 2007/. A number of modelling papers and one overview paper have been submitted to a scientific journal.

The work within Task 7 is in progress. The task has been further defined and updated. Preliminary results were presented at the workshop on Task 7, which was held in Gothenburg, Sweden in June 2007. Updated preliminary results of sub-task 7A have been submitted by the modellers to the secretariat in addition to a few draft reports.

The 22<sup>nd</sup> International Task Force meeting, hosted by SKB was held in January, 2007 in Stockholm, and the 23<sup>rd</sup> Task Force meeting, hosted by Nuclear Waste Management Organization (NWMO), was held in Toronto end of October. Two minutes and one proceeding of these International Task Force meetings have been distributed and published on the Task Force web site of SKB.

An overview of the status of the ongoing work in Task 6 and Task 7 is given in Table 3-1.

**Table 3-1. Task descriptions and status of the specific modelling sub-tasks.**

<b>6</b>	<b>Performance Assessment (PA) modelling using Site Characterisation (SC) data</b>
6A	Model and reproduce selected True-1 tests with a PA model and/or a SC model to provide a common reference. (External review report printed).
6B	Model selected PA cases at the True-1 site with new PA relevant (long term/base case) boundary conditions and temporal scales. This sub-task serves as means to understand the differences between the use of SC-type and PA-type models and the influence of various assumptions made for PA calculations for extrapolation in time. (External review report printed).
6C	Develop semi-synthetic, fractured granite hydrostructural models. Two scales are supported (200 m block scale and 2,000 m site-scale). The models are developed based on data from the Prototype Repository, True Block Scale, True-1 and Fracture Characterisation and Classification project (FCC). (External review report printed).
6D	This sub-task is similar to sub-task 6A and is using the synthetic structural model in addition to a 50 to 100 m scale True Block Scale tracer experiment. (Most modelling reports printed and final review report available).
6E	This sub-task extends the sub-task 6D transport calculations to a reference set of PA time scales and boundary conditions. (Most modelling reports printed and final review report available).
6F	Sub-task 6F is a sensitivity study, which is proposed to address simple test cases, individual tasks to explore processes and to test model functionality. (Most modelling reports printed and final review report available).
<b>7</b>	<b>Long-term pumping experiment</b>
7A1	Hydrostructural model implementation. (Preliminary results were presented at the Task Force Workshop in June).
7A2	Pathway simulation within fracture zones. (Preliminary results were presented at the Task Force Workshop in June).
7A3	Conceptual modelling of PA relevant parameters from open hole pumping.
7A4	Quantification of compartmentalisation from open hole pumping tests and flow logging.
7A5	Quantification of transport resistance distributions along pathways.
7B	This sub-task is addressing the same as sub-task 7A but in a smaller scale, i.e. rock block scale. Sub-task 7B is using 7A as boundary condition.
7C	Here focus is on deposition hole scale issues, resolving geomechanics, buffers, and hydraulic views of fractures.
7D	Tentatively this Sub-task concerns integration on all scales.

## 4 Engineered barriers

### 4.1 General

To meet stage goal 4, to demonstrate technology for and function of important parts of the repository barrier system, work is performed at Äspö HRL. This implies translation of current scientific knowledge and state-of-the-art technology into engineering practice applicable in a future repository.

It is important that development, testing and demonstration of methods and procedures, as well as testing and demonstration of repository system performance, are conducted under realistic conditions and at appropriate scale. A number of large-scale field experiments and supporting activities are therefore conducted at Äspö HRL. The experiments focus on different aspects of engineering technology and performance testing, and will together form a major experimental programme.

With respect to technology demonstration important overall objectives of this programme are:

- To furnish methods, equipment and procedures required for excavation of tunnels and deposition holes, near-field characterisation, canister handling and deposition, backfill, sealing, plugging, monitoring and also canister retrieval.
- To integrate these methods and procedures into a disposal sequence, that can be demonstrated to meet requirements of quality in relation to relevant standards, as well as practicality.

With respect to repository function, the objectives are to test and demonstrate the function of the engineered barriers as well as the function of the integrated repository system.

The main experiments that are installed in Äspö HRL or under way are:

- Prototype Repository.
- Long Term Test of Buffer Material.
- Alternative Buffer Materials.
- Backfill and Plug Test.
- Canister Retrieval Test.
- Temperature Buffer Test.
- KBS-3 method with Horizontal Emplacement.
- Large Scale Gas Injection Test.
- In situ Testing of Miniature Canisters.

### 4.2 Prototype Repository

#### 4.2.1 Background

Many aspects of the KBS-3 repository concept have been tested in a number of in situ and laboratory tests. Models have been developed that are able to describe and predict the behaviour of both individual components of the repository, and the entire system. However, processes have not been studied in the complete sequence, as they will occur in connection to repository construction and operation. There is a need to test and demonstrate the execution and function of the deposition sequence with state-of-the-art technology in full-scale. In addition, it is needed

to demonstrate that it is possible to understand and qualify the processes that take place in the engineered barriers and the surrounding host rock. This technology was developed and is tested and demonstrated in the Prototype Repository.

The execution of the Prototype Repository is a dress rehearsal of the actions needed to construct a final repository from detailed characterisation to resaturation of deposition holes and backfill of tunnels. The Prototype Repository provides a demonstration of the integrated function of the repository and provides a full-scale reference for test of predictive models concerning individual components as well as the complete repository system. The Prototype Repository should demonstrate that the important processes that take place in the engineered barriers and the host rock are sufficiently well understood.

The installation of the Prototype Repository has been co-funded by the European Commission with SKB as co-ordinator. The EC-project started in September 2000 and ended in February 2004. The continuing operation of the Prototype Repository is funded by SKB.

#### **4.2.2 Objectives**

The main objectives for the Prototype Repository are to:

- Test and demonstrate the integrated function of the final repository components under realistic conditions in full-scale and to compare results with model predictions and assumptions.
- Develop, test and demonstrate appropriate engineering standards and quality assurance methods.
- Simulate appropriate parts of the repository design and construction processes.

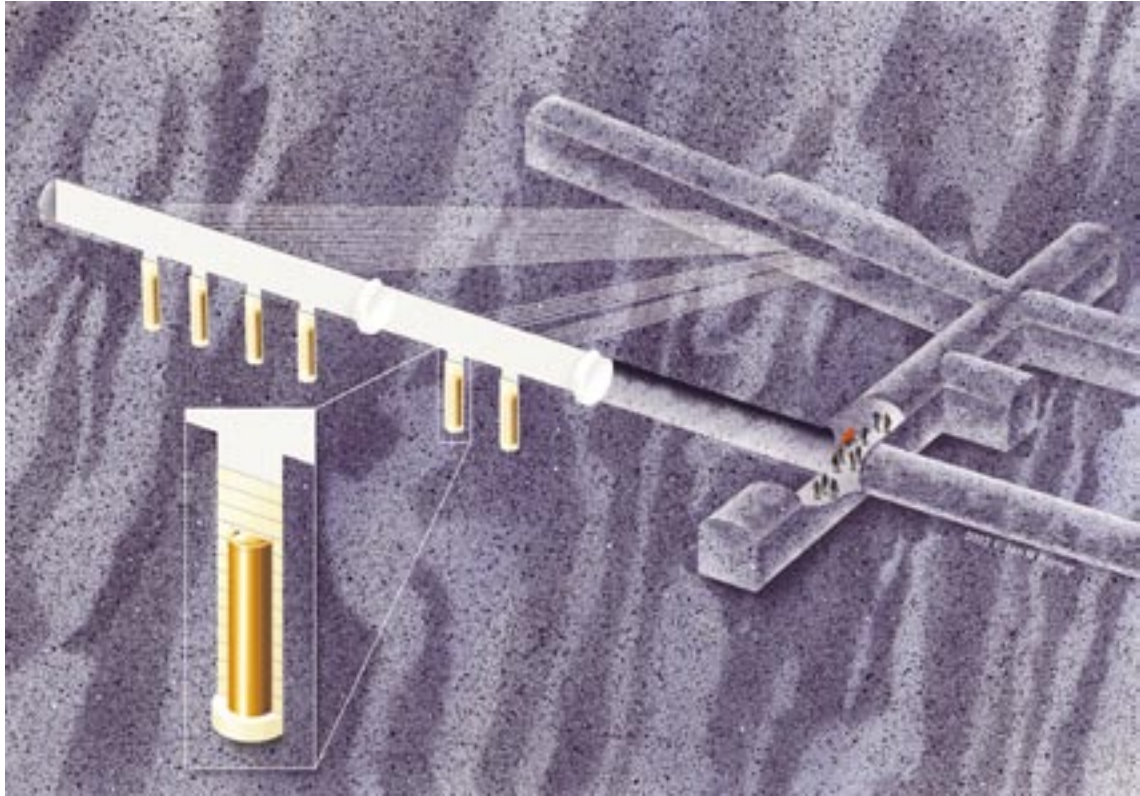
The evolution of the Prototype Repository should be followed for a long time, possibly up to 20 years. This is made to provide long term experience on repository performance to be used in the evaluation that will be made after the initial operational stage in the real deep repository.

#### **4.2.3 Experimental concept**

The test location chosen is the innermost section of the TBM-tunnel at the -450 m level. The layout involves altogether six deposition holes, four in an inner section and two in an outer, see Figure 4-1. The sections are backfilled with a mixture of bentonite and crushed rock (30/70). A massive concrete plug, designed to withstand full water and swelling pressures, separates the test area from the open tunnel system and a second plug separates the two sections. This layout provides two more or less independent test sections. Canisters with dimension and weight according to the current plans for the final repository and with heaters to simulate the thermal energy output from the spent nuclear fuel have been positioned in the holes and surrounded by bentonite buffer. The deposition holes are placed with a centre distance of 6 m. This distance was evaluated considering the thermal diffusivity of the rock mass and the maximum acceptable surface temperature of the canister.

The decision when to stop and decommission the test will be influenced by several factors including performance of monitoring instrumentation, results successively gained, and the overall progress of the Swedish deep repository project. It is envisaged that the outer test section will be decommissioned after approximately five years to obtain interim data on buffer and backfill performance. Instrumentation is used to monitor processes and evolution of properties in canister, buffer material, backfill and near-field rock. Examples of processes that are studied include:

- Water uptake in buffer and backfill.
- Temperature distribution (canisters, buffer, backfill and rock).
- Displacement of canister.
- Swelling pressure and displacement in buffer and backfill.



*Figure 4-1. Schematic view of the layout of the Prototype Repository (not to scale).*

- Stress and displacement in the near-field rock.
- Water pressure build up and pressure distribution in rock.
- Gas pressure in buffer and backfill.
- Chemical processes in rock, buffer and backfill.
- Bacterial growth and migration in buffer and backfill.

#### **4.2.4 Results**

The installation of Section I was done during summer and autumn 2001. The heating of the canister in deposition hole 1 started with an applied constant power of 1,800 W at 17<sup>th</sup> September. This date is also marked as start date. The backfilling started early September and was finished in the end of November and the plug was cast at in the middle of December. In order to simulate the radioactive decay, the power was decreased 40 W one year after start of the first heater. In the beginning of September 2004 the power in deposition holes 1–4 was decreased with about 30 W to 1,710 W. At the beginning of December 2005, 2006 and 2007 new reductions of the power were made. The applied power after the latest reduction is 1,630 W.

The installation of Section II was done during spring and summer 2003. The heating of the canister in hole 5 started with an applied constant power of 1,800 W at 8<sup>th</sup> of May. This date is also marked as start date. The backfilling started in the end of April and was finished in the end of June and the plug was cast at in September. In the beginning of September 2004 the power in deposition holes 5–6 was decreased with about 30 W to 1,770 W. The interface between the rock and the outer plug was grouted at the beginning of October 2004. At the beginning of December 2005, 2006 and 2007 new reductions of the power were made. The applied power after the latest reduction is 1,680 W.

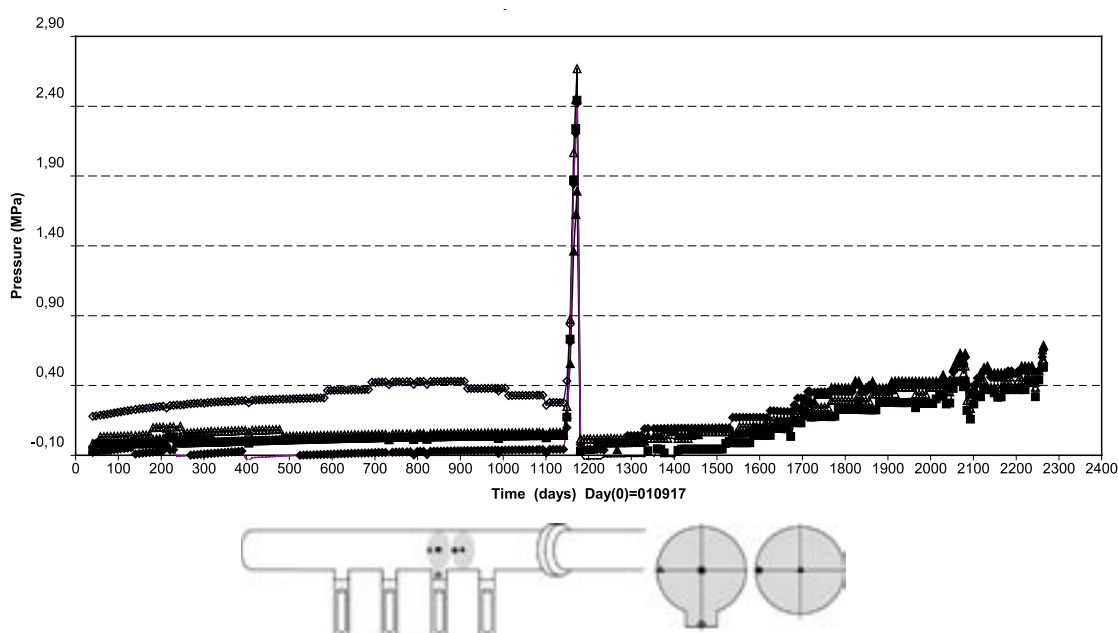
At the beginning of November 2004 the drainage of the inner part of Section I and the drainage through the outer plug were closed. For these two sections this dramatically affected the pressure (both total and pore pressure) in the backfill and the buffer. Example of data from the measurements in the backfill of the total pressure is shown in Figure 4-2. The maximum pressures were recorded around 1<sup>st</sup> January 2004. At that date the heating in canister 2 failed. It was then decided to turn off the power to all of the six canisters. Four days later, also damages on canister 6 were observed. The drainage of the tunnel was then opened again. During the next week further investigations on the canisters were done. The measurements showed that the heaters in canister 2 were so damaged that no power could be applied to this canister. The power to the rest of the canisters was applied 15<sup>th</sup> of November 2004 again. The drainage of the tunnel was kept open. At the beginning of August 2005 another failure of canister 6 was observed. The power to this canister was switched off until beginning of October 2005 when the power was switched on again.

### **Measurements in rock, backfill and buffer**

Altogether more than 1,000 transducers were installed in the rock, buffer and backfill /Collin and Börgesson 2002, Börgesson and Sandén 2002, Rhén et al. 2003/. The transducers measure the temperature, the pore pressure and the total pressure in different part of the test area. The water saturation process is recorded by measuring the relative humidity in the pore system of the backfill and the buffer, which can be converted to total suction.

Furthermore transducers were installed for recording the displacement of the canisters in deposition hole 3 and 6 /Barcena and Garcai Sineriz 2001/. In addition resistivity measurements are made both in buffer and backfill /Rothfuchs et al. 2003/. The out come from these measurements is profiles of the resistivity which can be interpreted to water ratios of the backfill and the buffer. Most transducers are still working and are giving reliable data.

Transducers for measuring the stresses and the strains in the rock around the deposition holes in Section II have also been installed /Bono and Röshoff 2003/. The purpose with these measurements is to monitor the stress and strain caused by the heating of the rock from the canisters.

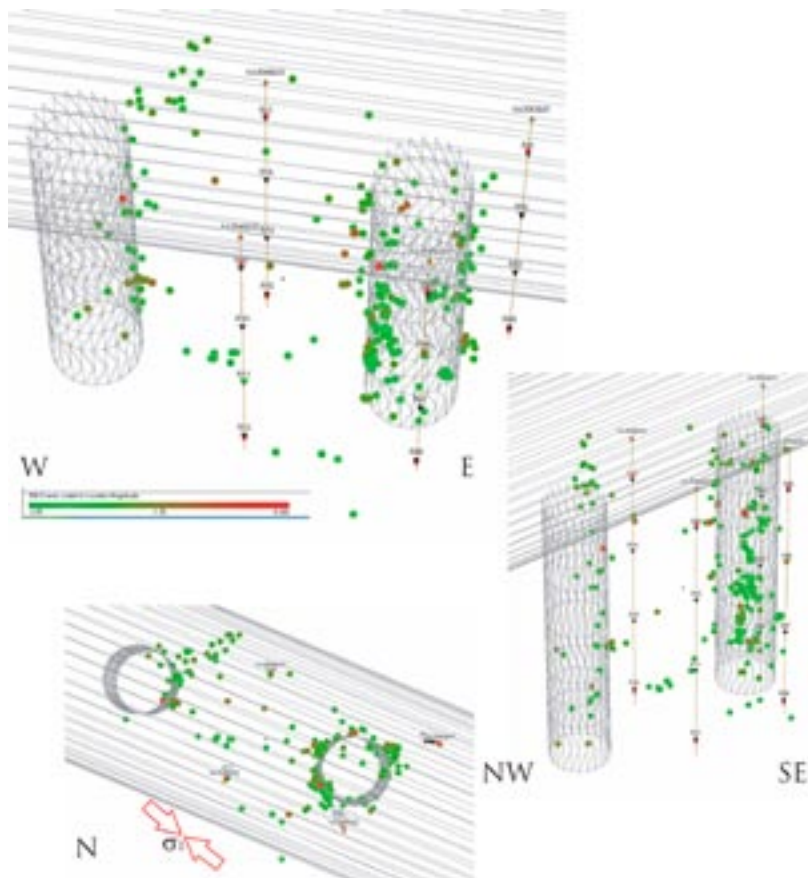


**Figure 4-2.** Examples of measured total pressure in the backfill around deposition hole 3 (17<sup>th</sup> September 2001 to 1<sup>st</sup> December 2007).

A large programme for measuring the water pressure in the rock close to the tunnel is also ongoing /Rhén et al. 2003/. The measurements are made in boreholes which are divided into sections with packers. In connection with this work a new packer was developed that is not dependent of an external pressure to seal off a borehole section. The sealing is made by highly compacted bentonite with rubber coverage. Tests for measuring the hydraulic conductivity of the rock are also made with the use of the drilled holes. This work has been made in test campaigns since the installation. The latest date (test campaign 8) has recently been published /Forsmark 2007/. Tracer dilution tests in order to evaluate the ground water flow in the rock has also been performed and published during 2007 /Norman and Andersson 2007/.

An ultrasonic monitoring system has been installed around deposition hole 6. The system consists of twenty-four ultrasonic transducers installed into four instrumentation boreholes. The ultrasonic monitoring has been conducted since 1999 and the latest measurements have been published in two reports during 2007 /Haycox and Pettitt 2006, Zolezzi et al. 2007/. Two techniques are utilised here to investigate the processes occurring within the rock mass around the deposition hole: ultrasonic survey and acoustic emission (AE). Ultrasonic surveys are used to “actively” examine the rock. Amplitude and velocity changes on the ray paths can then be interpreted in terms of changes in the material properties of the rock. AE monitoring is a “passive” technique similar to earthquake monitoring but on a much smaller distance scale (source dimensions of millimetres). AE’s occur on fractures in the rock when they are created or when they move. Results from AE monitoring during the heating phase of the Prototype Repository are shown in Figure 4-3.

Equipment for taking gas and water samples both in buffer and backfill have been installed /Puigdomenech and Sandén 2001/. A report where analyses of microorganisms, gases and chemistry in buffer and backfill during 2004–2007 are described will soon be published.



**Figure 4-3.** Projections of all acoustic emissions during the heating phase (20<sup>th</sup> March 2003 to 31<sup>st</sup> March 2007). Events are scaled to location magnitude.

## **Recording of THM processes**

### **The saturation of the buffer in the deposition holes**

The Prototype tunnel has until 1<sup>st</sup> November 2004 been drained. Most of the water coming into the inner section has been drained. This affects the water uptake both in the buffer and in the backfill. The saturation of the buffer has reached different levels in the six deposition holes due to variation in the access to water.

Many of the sensors for measuring total pressure, placed at the canister level in deposition hole 1 are recording high pressures. Also some pore pressure sensors placed at the same level are measuring high pressures. The installed sensors for measuring relative humidity (RH) placed at mid height of the canister have stopped giving reliable values after they have reached 100% RH. This is indicating that the buffer around the canister is close to saturated. Corresponding measurements in the buffer above and under the canister are indicating that these parts of the buffer are not saturated.

The measurements of the total pressure, pore pressure and relative humidity in the buffer in deposition hole 3 are indicating that the buffer is not saturated although some total pressure sensors placed in buffer block underneath the canister (C1) and in a ring surrounding the canister (R10, the upper most ring) are measuring maximum pressures of about 2–3 MPa.

The saturation of the buffer in deposition hole 5 indicated by both RH-sensors and total pressure sensors is complex. Some total pressure sensors are measuring rather high pressures (higher than 2.5 MPa) while others measure very low pressures. The sensors giving high pressures are placed both in block C1 and rings R5 and R10 (the uppermost ring). There are also some RH-sensors which are measuring relative humidity of ~100%, indicating a high saturation of the buffer. In other parts of the buffer most of the sensors (both RH-sensors and total pressure sensors) indicate a slow wetting of the buffer with time. Although the sensors reacted rather strongly just before and after the power was switched on and off at the beginning of December 2004, the saturation rate indicated by the sensors is not changed radically over the time. One sensor which is measuring the total pressure in block R5 at the inner slot towards the canister, measured at the end of this measuring period a pressure of about 2,600 kPa. This sensor started to react around day 200 which might be an indication of the time when the inner slot was closed.

The saturation of the buffer in deposition hole 6 was affected by the quick increase in pressure when the drainage of the tunnel was closed, indicated by both RH-sensors and total pressure sensors. The total pressure was also affected when the power was switched off again at the beginning of September 2005. The drop in total pressure was very large and rapid and the pressure started to increase before the power to the canister was switched on again. When the power was switched on pressure increased very fast to the same level as before the power was switched off. This course of events is indicating that the change in total pressure is an effect of the changes in water volume in the bentonite caused by variation in temperature. At present several total pressure sensors placed in the buffer below the canister lid are measuring high total pressures, indicating a high degree of saturation while the sensors placed above the canister are measuring lower pressures, indicating a lower degree of saturation.

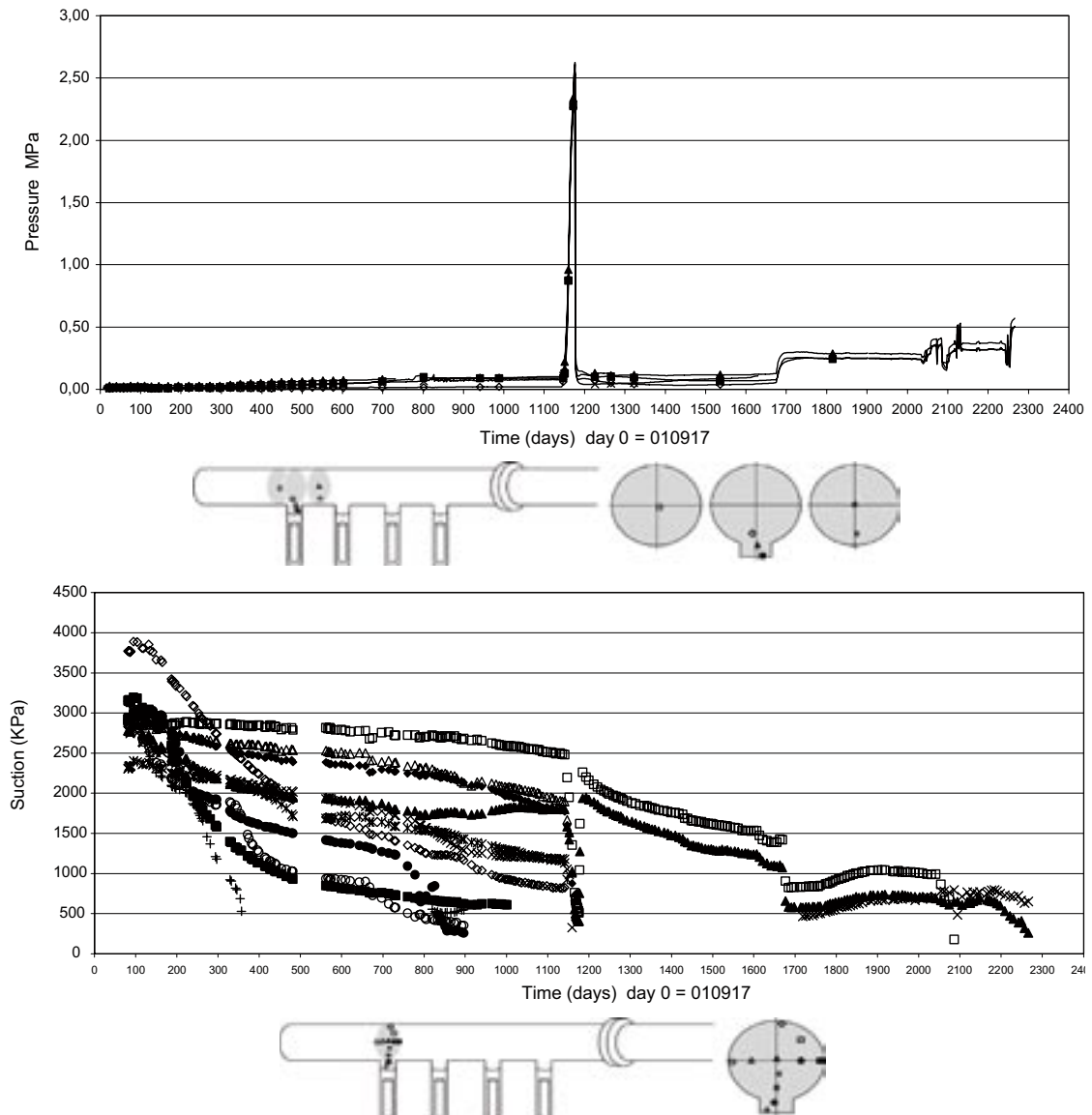
### **Hydration of the backfill**

The pore pressure in the backfill in Section I increased fast from a low level when the drainage of the tunnel was closed (see Figure 4-4). This affected the rate in which the backfill was saturated measured both with soil psychrometers and with resistivity measurements made by Gesellschaft für Anlagen- und Reaktorsicherheit (GRS) mbH. After the drainage was reopened the pore pressure stabilised on the same level as before it was close. Figure 4-4 shows some results from measurements of suction in the backfill of Section I over deposition hole 1. The measurements are made with soil psychrometers. The curves indicate as expected a faster saturation of the backfill close to the roof and the walls of the tunnel while very slow changes in suction over time is recorded by transducers placed in the centre of the tunnel. This is valid

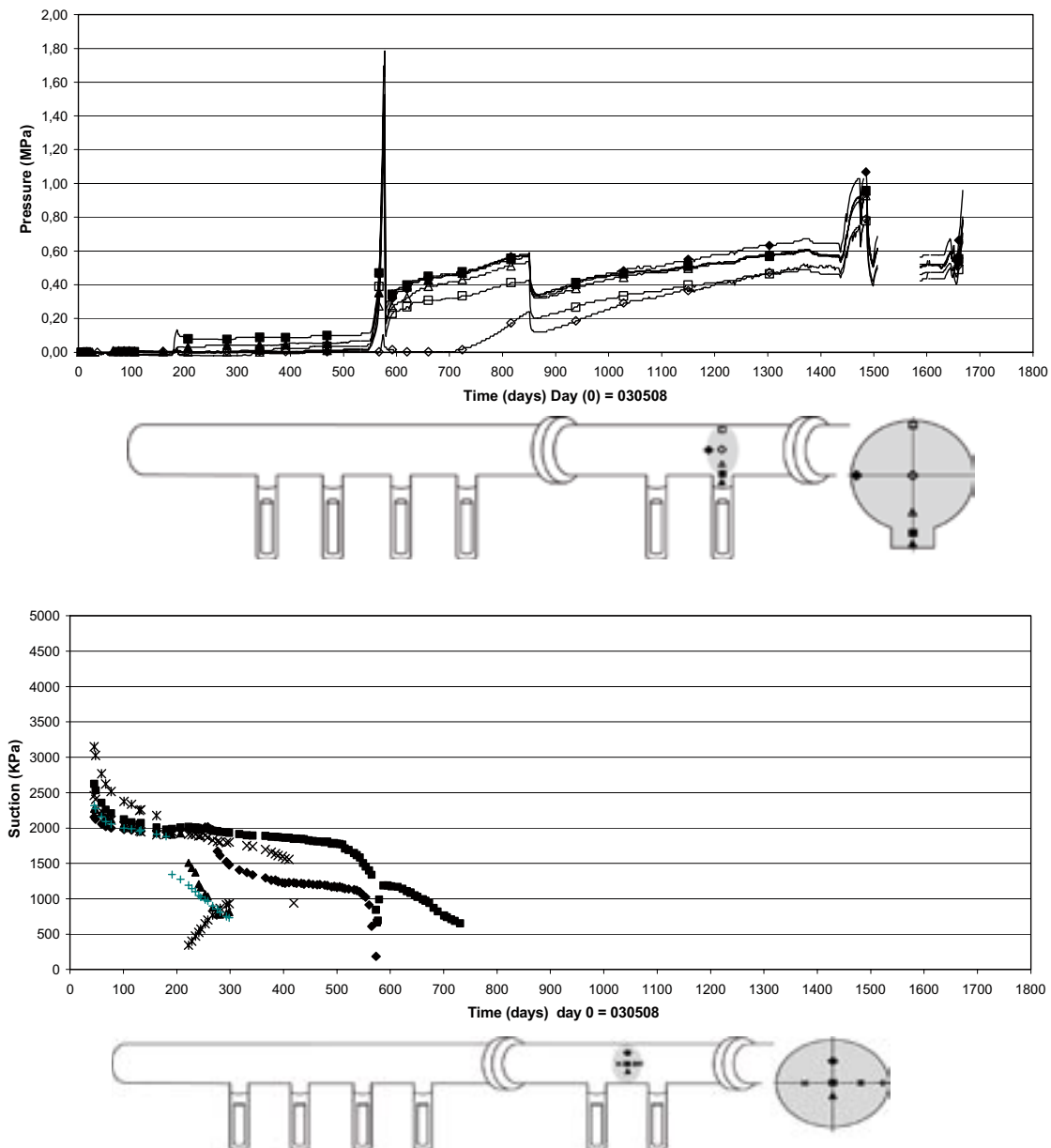


up to the time when the drainage of the tunnel was closed. The sensors, which still gave reliable values, indicated a faster hydration after this event. However, after the reopening of the drainage most of the sensors, which still gave reliable data, indicated similar hydration rate as before the closing of the drainage. When a packer placed in a borehole in Section I was broken (at the middle of April 2006) the pressure in the backfill (both total pressure and pore pressure) increased with about 300 kPa (see Figure 4-4). The increase in pressure affected also the measured suction values (measured with soil psychrometers). Six of the sensors measured a decrease in suction of about 500 kPa due to the broken packer. At the beginning of April 2007 the work with the new tunnel nearby the Prototype tunnel started. This work has affected the pore pressure and the saturation measured with the soil psychrometers since then, see Figure 4-5.

The pore pressure, measured both with total and pore pressure transducers placed in the backfill in Section II, increased also fast from a low level when the drainage of the tunnel was closed (see Figure 4-5) and this affected the rate in which the backfill was saturated measured both with soil psychrometers and with resistivity measurements in the backfill. After the drainage was reopened again the pore pressure stabilised on a higher level than before the drainage was



**Figure 4-4.** Examples of pore pressure and suction measured in the backfill in Section I above deposition hole 1 (17<sup>th</sup> September 2001 to 1<sup>st</sup> December 2007).



**Figure 4-5.** Examples of pore pressure and suction measured in the backfill in Section II close to deposition hole 6 (8<sup>th</sup> May 2003 to 1<sup>st</sup> December 2007).

closed. Most of the installed soil psychrometers measure very low suction values after the closing/opening of the drainage witch indicates that the backfill is close to fully saturated. The pore pressure in the backfill continued to increase although the drainage was kept open. The measurement of the pore pressure was very much affected by the work with the new tunnel. An increase of the pore pressure of about 400 kPa was measured when this work started.

### **Modelling of THM processes**

The model used in the predictions and evaluations of the various processes in the Prototype Repository buffer and backfill has been described in detail in /Pusch 2001/ and predictive modelling has been reported /Pusch and Svemar 2003/. The following is a brief summary of the major features of the models used for predicting the THM evolution:

- Thermal evolution in the buffer, backfill and near-field rock.
- Hydration of the buffer and backfill.
- Build-up of swelling pressure in the buffer and backfill.

The THM modelling of the Prototype Repository at Clay Technology has been made with Code\_Bright. The work has been made in steps, where the first step was to make a 3D thermal model of the Prototype Repository. The 3D thermal analysis has the following main objectives:

- Find relevant time-dependent thermal boundary conditions for local THM models of the individual deposition holes.
- Investigate how well the measured rock temperatures can be reproduced assuming one global and constant value of the rock heat conductivity.
- Check the influence of the backfill thermal properties on the overall thermal development around canister mid-height, i.e. the region where maximum temperature is expected.
- Explore the effect of the open ventilated tunnel.

This work has been published in a report /Kristensson and Hökmark 2007/.

Examples of results from the analyses are shown in Figure 4-6 where the calculated temperatures in the rock at mid height of the canister near deposition hole 5 are compared with measured temperatures, both along the tunnel axis (upper part of the figure) and 90° off the tunnel axis.

The second step in the modelling work was to model the water uptake of the buffer with the use of a 1D model. In this work the focus was aimed at the engineered buffer system between the canister and the hosting rock wall. There are three different sections between the canister and rock wall. The main part constitutes of bentonite powder compressed into blocks. There is a slot between the blocks and the rock wall that is filled with bentonite pellets. There is also a slot between the canister and bentonite blocks that is open (see Figure 4-7).

The main topics of the investigation were the water saturation process and homogenisation in the buffer. Thermal, hydrologic and mechanical conditions and processes are considered in the numerical study. This study also serves as a general investigation of the usefulness of the numerical tool, Code\_Bright, in this field of application.

An example of data from the calculations is shown in Figure 4-8 where the calculated total pressures (made for different assumption) are compared with the measured pressure (solid thick line) as function of time from the start of the test. This work will soon be published in a report.

## **4.3 Long Term Test of Buffer Material**

### **4.3.1 Background**

Bentonite clay has been proposed as buffer material in several concepts for HLW repositories. In the Swedish KBS-3 concept the demands on the bentonite buffer are to serve as a mechanical support for the canister, reduce the effects on the canister of a possible rock displacement, and minimise water flow over the deposition holes.

The decaying power from the spent fuel in the HLW canisters will give rise to a thermal gradient over the bentonite buffer by which original water will be redistributed parallel to an uptake of water from the surrounding rock. A number of laboratory test series, made by different research groups, have resulted in various buffer alterations models. According to these models no significant alteration of the buffer is expected to take place at the prevailing physico-chemical conditions in a KBS-3 repository, neither during nor after water saturation. The models may to a certain degree be validated in long term field tests. Former large-scale field tests in Sweden,

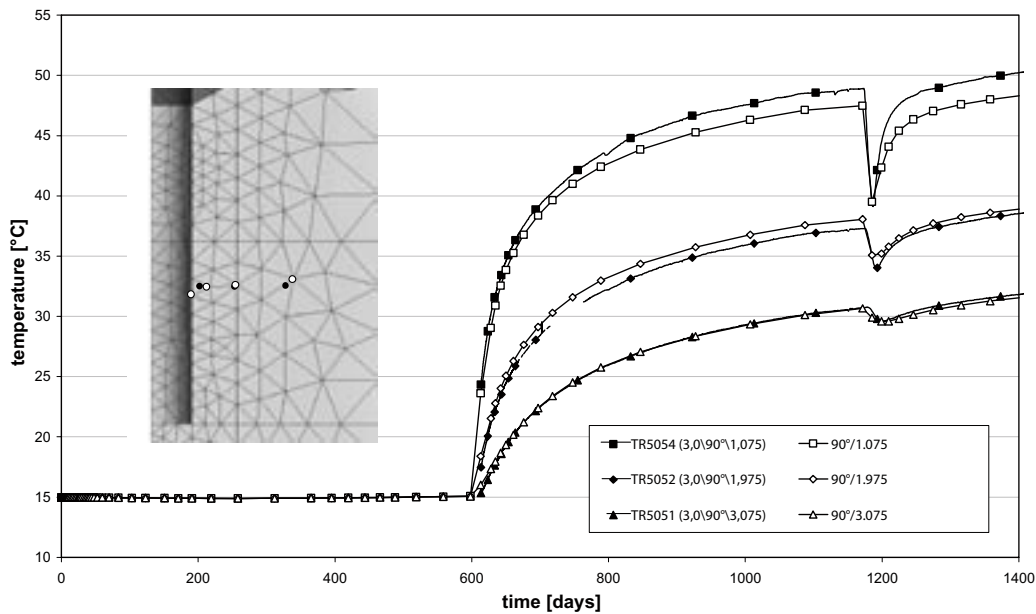
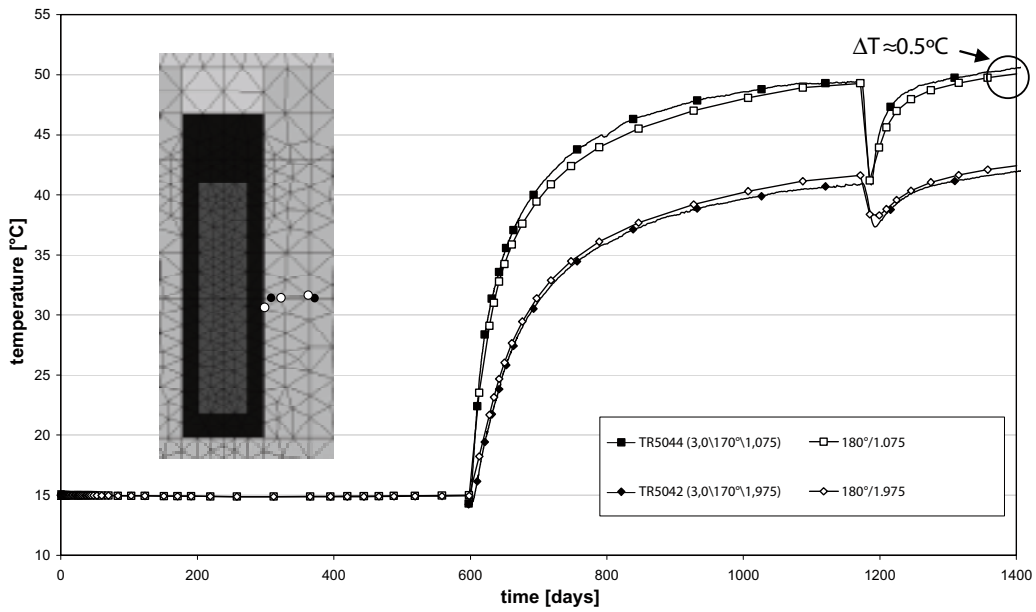


Figure 4-6. Rock temperatures close to hole 5. Comparison between measured (white dots) and calculated (black dots) temperatures. Upper figure: Positions along tunnel axis. Lower figure: Positions 90° off axis.

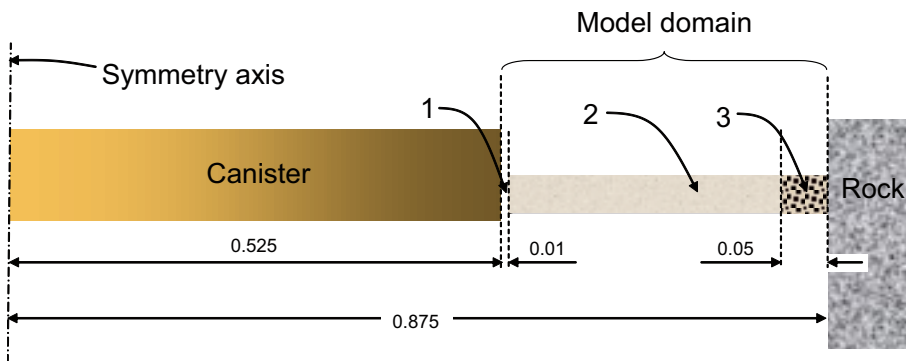
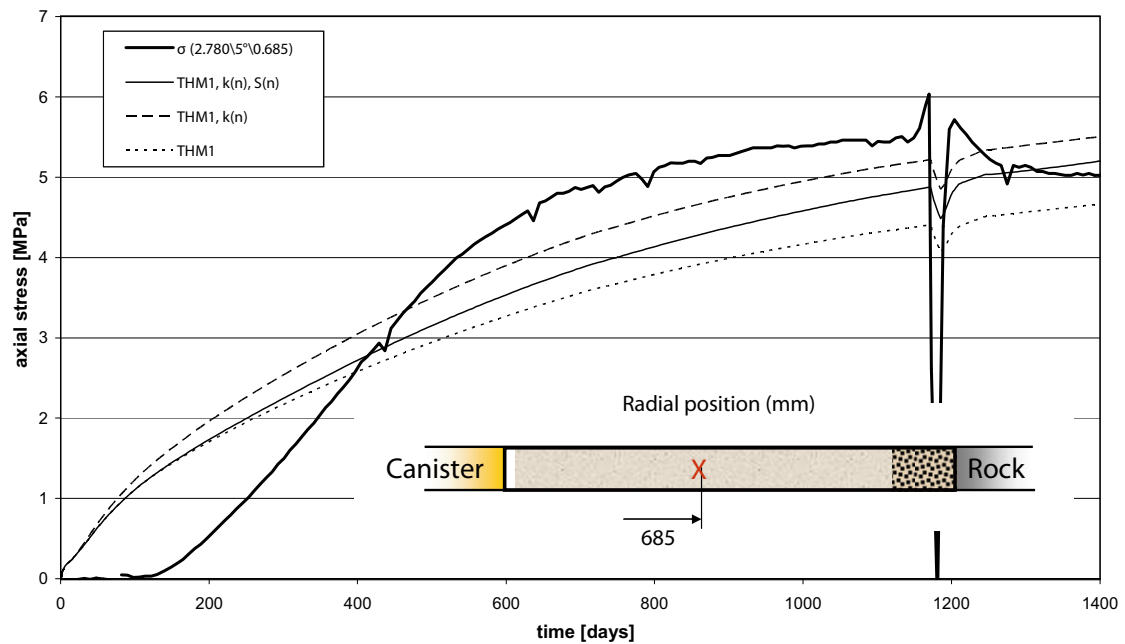


Figure 4-7. 1D model geometry: (1) slot between bentonite blocks and rock (filled with bentonite pellets), (2) bentonite blocks and (3) open slot between canister and bentonite blocks.



**Figure 4-8.** Measured ( $\sigma$ ) and calculated (THM1) axial stress history in the buffer in deposition hole 1 ( $r = 0.685$  m).

Canada, Switzerland and Japan have in some respects deviated from possible KBS-3 repository conditions and the testing periods have generally been dominated by initial processes, i.e. water uptake and temperature increase.

### 4.3.2 Objectives

The present test series within the project Long Term Test of Buffer Material (Lot) aims at validating models and hypotheses concerning the evolution of bentonite buffer properties. In addition, related processes regarding microbiology, radionuclide transport, copper corrosion and gas transport under conditions similar to those expected in a KBS-3 repository are studied. The expression “long term” refers to a time span long enough to study the buffer performance at full water saturation, but obviously not “long term” compared to the lifetime of a repository. The objectives may be summarised in the following items:

- Collect data for validation of models concerning buffer performance under quasi-steady state conditions after water saturation, e.g. swelling pressure, cation exchange capacity and hydraulic conductivity.
- Check of existing models on buffer-degrading processes, e.g. illitisation and salt enrichment.
- Collect data concerning survival, activity and migration of bacteria in the buffer.
- Check of calculation results concerning copper corrosion, and information regarding type of corrosion.
- Check existing models for diffusive transport of cations.
- Collect information, which may facilitate the realisation of the full-scale test series, with respect to clay preparation, instrumentation, data handling and evaluation.

### 4.3.3 Experimental concept

The testing principle for all tests is to emplace parcels containing heater, central tube, pre-compacted clay buffer, instruments and parameter controlling equipment in vertical boreholes with a diameter of 300 mm and a depth of around 4 m, see Figure 4-9. The test series concern realistic repository conditions except for the scale and the controlled adverse conditions in three tests, see Table 4-1.

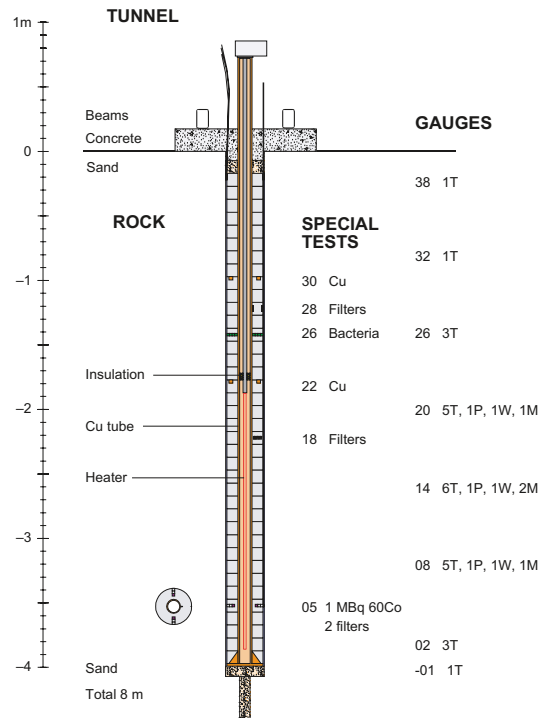
**Table 4-1. Buffer material test series.**

Type	No.	max T (°C)	Controlled parameter	Time (years)	Remark
A	1	130	T, [K <sup>+</sup> ], pH, am	1	Reported
A	0	130	T, [K <sup>+</sup> ], pH, am	1	Analysed
A	2	130	T, [K <sup>+</sup> ], pH, am	5	Analysed
A	3	120–150	T	>> 5	Ongoing
S	1	90	T	1	Reported
S	2	90	T	5	Ongoing
S	3	90	T	>>5	Ongoing

A = adverse conditions, S = standard conditions, T = temperature, [K<sup>+</sup>] = potassium concentration, pH = high pH from cement, am = accessory minerals added.



The first figures in the columns "special tests" and "gauges" denote block number and second figures in the column "gauges" denote the number of sensors. T denotes thermocouple, P total pressure sensor, W water pressure sensor, and M moisture sensor.



**Figure 4-9.** Illustration of the experimental set-up in the Long Term Test of Buffer Material (Lot) (left) and a cross-section view of one S-type parcel (right).

Adverse conditions in this context refer to high temperatures, high temperature gradients over the buffer, and additional accessory minerals leading to for example high pH and high potassium concentration in clay pore water. The central copper tubes are equipped with heaters in order to simulate the decay power from spent nuclear fuel. The heater effect are regulated or kept constant at values calculated to give a maximum clay temperature of 90°C in the standard condition tests and in the range of 120 to 150°C in the adverse condition tests.

Each parcel contains 25 thermocouples, 3 total pressure gauges, 3 water pressure gauges, 4 relative humidity sensors, 7 filter tubes, and 12 water sampling cups. The power is controlled and temperature, total pressure, water pressure and water content are continuously being measured.

At termination of the tests, the parcels are extracted by overlapping core-drilling outside the original borehole. The water distribution in the clay is determined and subsequent well-defined chemical, mineralogical analyses and physical testing is performed.

#### **4.3.4 Results**

##### ***Experimental***

The three remaining test parcels (see Table 4-1) have functioned without any disturbance, and only minor maintenance and improvement work have been made. Water pressure, total pressure, temperature and moisture have been continuously measured and stored every hour, and the data have been checked monthly.

Mineralogical analyses of the A2 parcel made by laboratories in Finland, France, Germany, Sweden and Switzerland have been finalised and were presented at a workshop in Lund in November 2007.

In general, the bentonite material was fully water saturated and all planned test and analyses concerning the bentonite mineralogy and physical properties, copper corrosion, tracer element distribution and bacteria activity have been accomplished. The comprehensive set of results from all laboratories will be compiled in a technical report during the first half of 2008. However, further minor work concerning mineralogy and rheology in the A2 parcel material will continue during 2008. In addition, experimental and modelling of core infiltration experiments is ongoing at the Bern University, Switzerland.

##### ***Modelling***

Model development has been performed, particularly concerning the influence of concentration discontinuities on ion transport in bentonite. This study will be submitted for publication. In addition, a dialog with one (T Appello) of two creators of the geochemical modelling tool Phreeqc has been initiated. The aim is to enable handling of the concentration discontinuities in modelling of bentonite by use of an updated Phreeqc version.

## **4.4 Alternative Buffer Materials**

### **4.4.1 Background**

Bentonite clay has been proposed as buffer material in several concepts for HLW repositories. In the Swedish KBS-3 concept the main demands on the bentonite buffer are to minimise the water flow over the deposition hole, reduce the effects on the canister of a possible rock displacement and prevent sinking of the canister. The MX-80 bentonite from American Colloid Co (Wyoming) has so far been used by SKB as a reference material. A large scale programme to study the use of possible alternative buffer material has been initiated, mainly to correlate the physical and chemical properties to fundamental mineralogical properties.

A number of commercial bentonite materials, from large producers, have been investigated with respect to mineralogy and swelling properties. So far the investigations have been done on the reference material MX-80, four samples from India (Ashapura) and one sample from Greece (Silver and Baryte). This project aims at studying the long term stability of bentonite and the influence by the accessory minerals in the materials.

#### **4.4.2 Objectives**

The project is carried out using material that according to laboratory studies are conceivable buffer materials. The project objectives are to:

- Verify results from laboratory studies during more realistic conditions with respect to temperature, scale and geochemical circumstances.
- Discover possible problems with manufacturing and storage of bentonite blocks.
- Give further data for verification of THM and geochemical models.

#### **4.4.3 Experimental concept**

The experiment will be carried out in the same way and scale as the Lot experiment at Äspö HRL (Section 4.3). Three parcels containing heater, central tube, pre-compacted clay buffer, instruments and parameter controlling equipment have been emplaced in vertical bore-holes with a diameter of 300 mm and a depth of 3 m. Parcel #1 will be retrieved after 1–2 years operation, parcel #2 after 2–4 years and parcel #3 will be in operation for at least five years.

Parcels #1 and #2 are artificially wetted whereas parcel #3, which will be in operation for the longest time, will only be wetted only if it at some point is found necessary.

Parcels #1 and #3 are heated from the very beginning, whereas, the heaters in parcel #2 will be activated when the buffer is fully saturated.

In addition to the bentonite blocks deposited in the three parcels, identical bentonite blocks will be stored to monitor the effects of storage.

#### **4.4.4 Results**

During 2007 the parcels were monitored closely as the buffer starts to saturate and the temperature increases. The power to the heaters in parcels #1 and #3 has continuously been adjusted to carefully raise the buffer temperature to the goal value of 130°C.

The buffer analyses test plan was finalised and the first analyses of reference bentonite materials have been conducted.

The activities specified in the project plan for 2007 are mostly fulfilled, remaining is the printing and distribution of the installation report which is now available as draft. In November a project meeting was held in Lund. At this meeting it was agreed upon that the first parcel should not be retrieved until the goal temperature, 130°C, has been held for one year. In reality this will be achieved early 2009.

### **4.5 Backfill and Plug Test**

#### **4.5.1 Background**

The Backfill and Plug Test include tests of backfill materials, emplacement methods and a full-scale plug. It is a test of the integrated function of the backfill material and the near-field rock in a deposition tunnel excavated by blasting. It is also a test of the hydraulic and mechanical functions of a plug. This test is partly a preparation for the Prototype Repository (see Section 4.2).



## 4.5.2 Objectives

The main objectives of the Backfill and Plug Test are to:

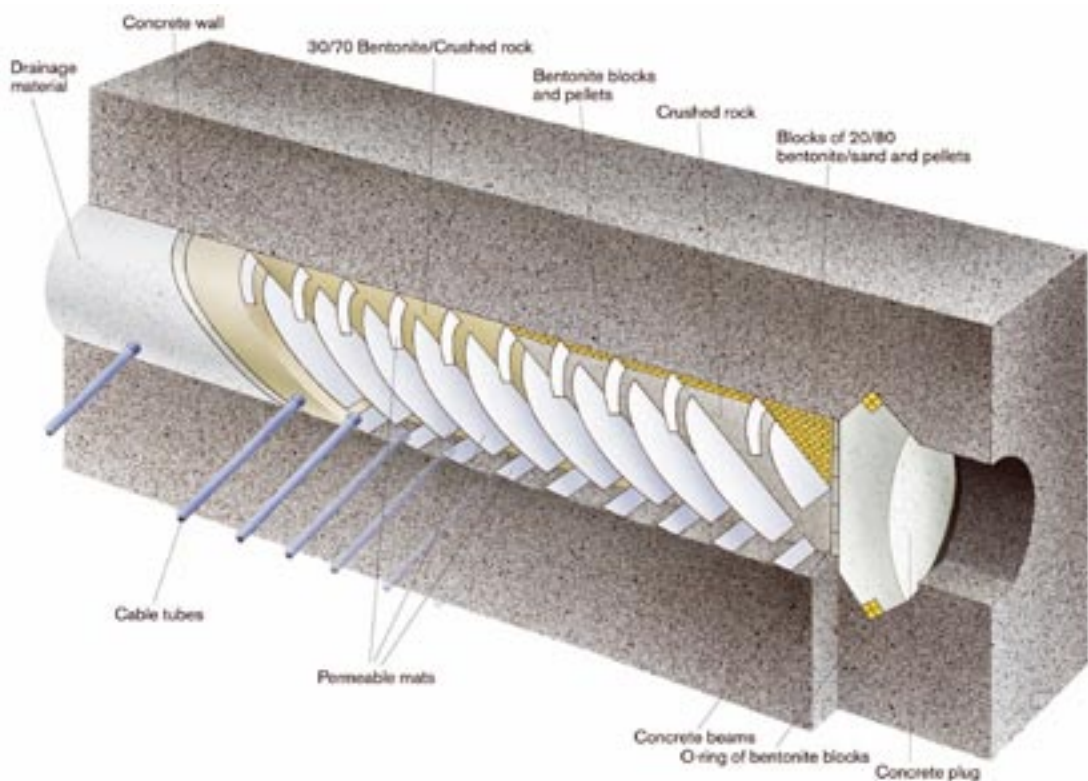
- Develop and test different materials and compaction techniques for backfilling of tunnels excavated by blasting.
- Test the function of the backfill and its interaction with the surrounding rock in full-scale in a tunnel excavated by blasting.
- Develop technique for building tunnel plugs and to test their function.

## 4.5.3 Experimental concept

The test region for the Backfill and Plug Test is located in the old part of the Zedex tunnel. Figure 4-10 shows a 3D visualisation of the experimental set-up. The test region, which is about 30 m long, is divided into the following three test parts:

- The inner part (six sections).
- The outer part (four sections).
- The concrete plug.

The inner test part is filled with a mixture of bentonite and crushed rock with a bentonite content of 30%. The composition is based on results from laboratory tests and field compaction tests. The outer part is filled with crushed rock with no bentonite additive. Since the crushed rock has no swelling potential, but may instead settle with time, a slot of a few decimetres was left between the backfill and the ceiling. The slot was filled with a row of highly compacted blocks, with 100% bentonite content, in order to ensure a good contact between the backfill and the rock. The remaining irregularities between these blocks and the ceiling were filled with bentonite pellets.



*Figure 4-10. Illustration of the experimental set-up of the Backfill and Plug Test.*

The backfill sections are applied layer wise and compacted with vibrating plates that are developed and built for this purpose. It was concluded from preparatory tests that inclined compaction should be used in the entire cross section from the floor to the ceiling and that the inclination should be about 35 degrees.

Both the inner and outer test parts are divided by drainage layers of permeable mats in order to apply hydraulic gradients between the layers and to study the flow of water in the backfill and near-field rock. The mats are also used for the water saturation of the backfill. The mats were installed in both test parts with the individual distance of 2.2 m. Each mat section was divided in three units in order to be able to separate the flow close to the ceiling from the flow close to the floor and also in order to separate the flow close to the rock surface from the flow in the central part of the backfill.

The outer test part ends with a wall made of prefabricated concrete beams for temporary support of the backfill before casting of the plug. Since in situ compaction of the backfill cannot be made in the upper corner, this triangle was instead filled with blocks of bentonite/sand mixture with 20% bentonite content.

The plug is designed to resist water and swelling pressures that can be developed. It is equipped with a filter on the inside and a 1.5 m deep triangular slot with an "O-ring" of highly compacted bentonite blocks at the inner rock contact.

The backfill and rock are instrumented with piezometers, total pressure cells, thermocouples, moisture gauges, and gauges for measuring the local hydraulic conductivity. The axial conductivities of the backfill and the near-field rock are after water saturation tested by applying a water pressure gradient along the tunnel between the mats and measuring the water flow. All cables from the instruments are enclosed in Tecalan tubes to prevent leakage through the cables. The cables are led through the rock in boreholes drilled between the test tunnel and the neighbouring demonstration tunnel hosting the data acquisition room.

#### **4.5.4 Results**

The installation was completed and the wetting of the backfill from the permeable mats started at the end of 1999. The water pressure in the mats was increased to 500 kPa in steps of 100 kPa between October 2001 and January 2002 and kept at 500 kPa until the backfill was judged to be water saturated in the beginning of 2003. During 2003 the equipment was rebuilt for flow testing and the flow testing started at the end of that year. The year 2004 and most of 2005 were used for flow testing of the six test sections of the 30/70 bentonite/crushed rock mixture.

In 2006 measurements of a) hydraulic conductivity in single points by pressurising filter equipped tubes and b) the water flow into the backfill were performed in the inner part. These tests largely confirmed the previous results although a somewhat lower hydraulic conductivity was measured.

During 2007, the tests have been supervised and measured results from all sensors except for the relative humidity sensors have been logged. The relative humidity sensors were disconnected since all sensors showed full water saturation. A data report covering the period up to 1<sup>st</sup> January 2007 has been published /Goudarzi et al. 2008/.

The compressibility of the backfill has been measured by a stepwise pressurisation of the pressure cylinders (diameter 0.5 m). In spite of the long time that has elapsed since installation, these devices worked very well. One cylinder in the ceiling and one in the floor in both the 30/70 and the crushed rock backfill had been installed and were tested. The results are not yet fully evaluated but the following preliminary results were reached.

In the outer part filled with crushed rock, the final total displacement was only 20 mm in the backfill at the floor (at 5 MPa) and 180 mm at the ceiling (at 1.7 MPa). In the inner part, filled with a 30/70 mixture of bentonite/crushed rock, the total displacement in the backfill at the floor

was 200 mm already at a pressure of 1 MPa and 200 mm at the ceiling at a pressure of 0.65 Pa. The compressibility was thus very high in all cases except at the floor of the crushed rock backfill.

In addition to the field testing, laboratory experiment and modelling with the aim to evaluate the hydraulic conductivity of the backfill materials are in progress but are delayed.

## **4.6 Canister Retrieval Test**

### **4.6.1 Background**

The stepwise approach to safe disposal of spent nuclear fuel implies that if the evaluation of the deposition after the initial stage is not judged to give a satisfactory result the canisters may need to be retrieved and handled in another way. The evaluation can very well take place so long after deposition that the bentonite has swollen and applies a firm grip around the canister. The canister, however, is not designed with a mechanical strength that allows it to be just pulled out of the deposition hole. The canister has to be made free from the grip of the bentonite before it can be taken up.

The Canister Retrieval Test is aiming at demonstrating the readiness for recovering of emplaced canisters also after the time when the bentonite is fully saturated and has its maximum swelling pressure.

### **4.6.2 Objectives**

The overall aim of the Canister Retrieval Test (CRT) is to demonstrate to specialists and to the public that retrieval of canisters is technically feasible during any phase of operation. The following was defined to fulfil the aim of the CRT:

- Two vertically bored test holes in full repository scale, which fulfil the quality requirements deemed necessary for the real repository.
- Careful and documented characterisation of the properties of these holes including the boring disturbed zone.
- Emplacement of bentonite blocks, bentonite pellets and canisters with heaters, and artificial addition of water. However, only one of these deposition holes has been used for implementation of the Canister Retrieval Test.
- Saturation and swelling of the buffer are monitored under controlled conditions.
- Preparations for and demonstration of canister retrieval.

Boring of full-scale deposition holes and geometrical/geotechnical characterisation of holes as well as emplacement of bentonite and canister with heaters were made within sub-projects that concern also other tests in the Äspö HRL. In addition to the retrieval test, the results from monitoring of the buffer and the laboratory testing of excavated parts of the buffer will be used to increase the understanding of the THM processes in a deposition hole.

### **4.6.3 Experimental concept**

The Canister Retrieval Test is located in the main test area at the –420 m level. The tunnel is excavated by conventional drill and blast techniques and is 6 m wide and 6 m high. The test period is separated into three phases:

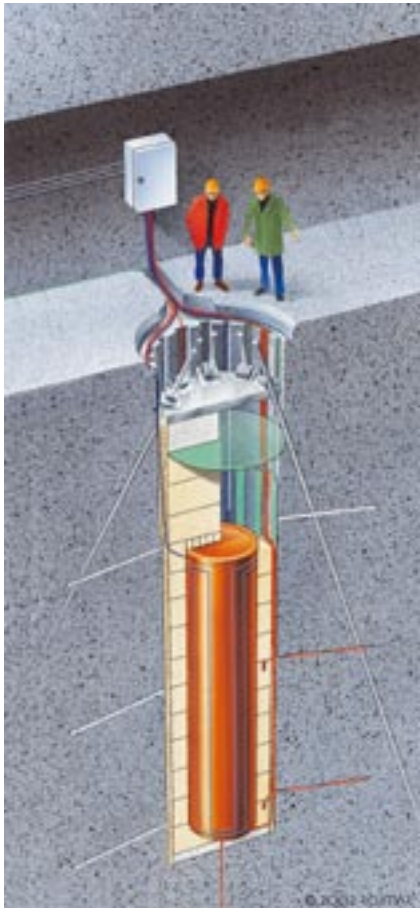
- Installation Phase – Boring of deposition holes and installation of instrumented bentonite blocks and canister with heaters in one hole. This hole is covered in the top with a lid of concrete and steel.

- Saturation Phase – Saturation of the bentonite and evolution of the thermal regime with measurement of thermal, hydraulic and mechanical processes.
- Retrieval Phase – Test of freeing the canister from the bentonite, docking the gripping device to the canister lid and lifting of the canister up to the tunnel floor and into the radiation shield on the deposition machine (reversed deposition sequence).

The buffer was installed in the form of blocks of highly compacted Na-bentonite, with a full diameter of 1.65 m and a nominal height of 0.5 m. Instruments for measuring temperature, relative humidity, total pressure and pore pressure were installed in the bentonite in many of the blocks. When the stack of blocks was 6 m high the canister equipped with electrical heaters was lowered down in the centre. Cables to heaters, thermocouples in the rock and strain gauges in the rock were connected, and additional blocks were emplaced until the hole was filled up to 1 m from the tunnel floor. On top, the hole was sealed with a plug made of concrete and a steel plate as cover. The plug was secured against heave caused by the swelling clay with 9 cables anchored to the rock. The tunnel will be left open for access and inspections of the plug support. The experimental set-up is shown in Figure 4-11.

Artificial addition of water was provided evenly around the bentonite blocks by means of permeable mats attached to the rock wall. The design of the mats was done so that they are not disturbing the future test of retrieval.

The predicted saturation time for the test was 2–3 years in the 350 mm thick buffer along the canister and 5–10 years in the buffer below and above the canister. The instrumentation in the buffer was similar to the instrumentation in the Prototype Repository and yield comparable information during the Saturation Phase.



**Figure 4-11.** Illustration of the experimental set-up of the Canister Retrieval Test.

#### **4.6.4 Results**

Based on the information regarding saturation of the buffer and the problems with the heaters, excavation and sampling of the bentonite buffer started in January 2006. The canister was successfully retrieved in the summer the same year.

During 2007 the heaters have been further analysed. The results are presented in a report published by Studsvik /Zhu and Hermansson 2007/. The results from the analysis have also been forwarded to other projects using the same type of heater setup at Äspö HRL. The report mainly states that the heaters are affected by the environment inside the canister, but that they are functional. This concludes that the loss of power to the heaters is due to the failure of the external heater power cables.

Further buffer analyses have also been conducted by Clay Technology during 2007, the results will be presented in the first Äspö HRL status report for 2008.

Modelling of the buffer saturation and experiment progress is now part of the Task Force on Engineered Barrier Systems (see Section 4.12) and has been initiated during 2007.

### **4.7 Temperature Buffer Test**

#### **4.7.1 Background**

The Temperature Buffer Test (TBT) is carried out by Andra at Äspö HRL in co-operation with SKB. TBT aims at verifying and possibly improving current THM models of buffer materials at high temperatures, well over 100°C. Moreover, the experimental setup has been characterised by stationary, well defined, boundary conditions. This implies that the experimental activities at the test site up till 2006 have been run mostly at a routine basis, while the focus has been on different modelling tasks and general successive evaluation of obtained results.

#### **4.7.2 Objectives**

The Temperature Buffer Test aims at improving the current understanding of the thermo-hydro-mechanical behaviour of clay buffers at temperatures around and above 100°C during the water saturation transient, in order to be able to model this behaviour.

#### **4.7.3 Experimental concept**

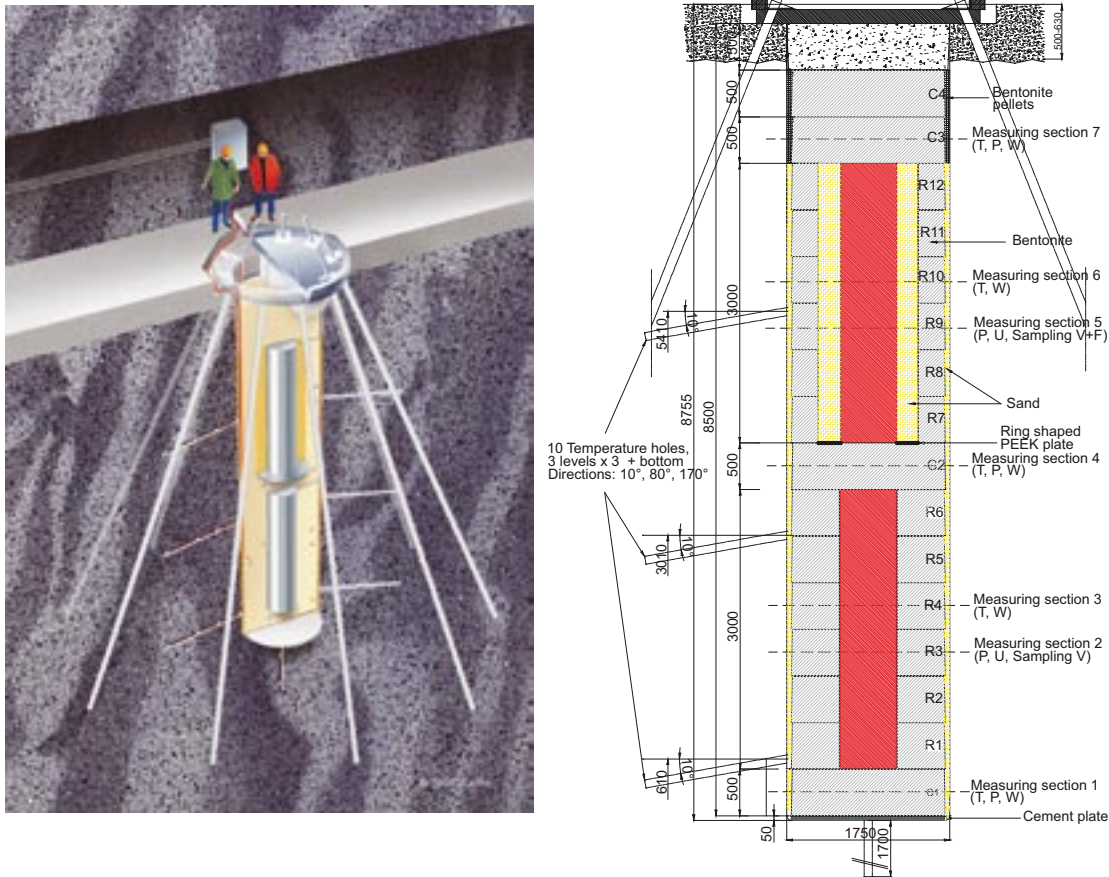
TBT is located in the same test area as the Canister Retrieval Test (CRT) at the -420 m level. Two identical heaters, each 3 m long and 0.6 m in diameter, are stacked in a vertical 1.8 m diameter deposition hole. The principle design of the test and the experimental set-up are shown in Figure 4-12.

Two buffer arrangements are being investigated:

- One heater is surrounded by bentonite in the usual way, allowing the temperature of the bentonite to exceed 100°C locally.
- The other heater has a ring of sand between the heater and the bentonite, as thermal protection for the bentonite, the temperature of which is kept below 100°C.

The principle of the TBT test is to observe, understand and model the behaviour of the deposition hole components, starting from an initial unsaturated state under thermal transient and ending with a final saturated state with a stable heat gradient.

Heat transfer comes into play from the start of the test, possibly redistributing water being present in the buffers, with partial desaturation of very hot zones (> 100°C). Inflow of water then causes saturation and consequent swelling of the bentonite.



**Figure 4-12.** Principle design and experimental set-up of the Temperature Buffer Test.

The effects of a bentonite desaturation/resaturation cycle on the confinement properties are not well known. An open question which TBT is designed to answer is whether the mechanical effects of desaturation (cracking of the material) are reversible.

The similar geometries of CRT and TBT, the similar artificial water saturation systems, and the use of MX-80 bentonite buffer will facilitate interpretation of data and comparisons of results.

#### 4.7.4 Results

The evaluation of THM processes has been made through analyses of sensors data (for the latest report, see /Goudarzi et al. 2007/), through numerical modelling /Hökmark et al. 2007, Åkesson 2006a/ and through evaluation and numerical modelling of parallel lab-scale mock-up tests /Åkesson 2006b, Ledesma et al. 2006/. The final evaluation of the field test will be made when data from the future dismantling and sampling will be available.

Two project meetings were held during 2007: in Weimar in May and in Lille in September.

A number of experimental activities have been planned for the period 2007–2009. Three steps are identified for the activity planning of the upper section of the deposition hole: (i) evaluation of the THM processes; (ii) a gas injection tentative and; (iii) a retrieval test. The gas injection test would aim at revealing the effect of gas breakthrough on bentonite buffer properties. Results should be compared to those of the Large Scale Gas Injection Test. Within TBT, the plan is to pressurise the sand shield, located between the upper heater and the buffer. A requirement for the test, the complete water saturation of the upper buffer, has been achieved. The hydration of the shield was therefore started during 2007.

For the lower section the evaluation of the THMC processes, with operation at high temperatures, is the main point of interest. In order to promote mineralogical alteration processes in the lower package, the thermal output from the heaters has been changed during 2007.

### ***Change of water quality for injection***

The quality of the water used for hydration through the sand filter was changed on 17<sup>th</sup> April from formation water to de-ionised water. The reason for this was to avoid salts precipitation from the formation water. A larger pressure tank was taken in use on 13<sup>th</sup> August. The pressure drop between injection pressure and filter pressure decreased quickly to reach approximately 1 bar at the end of the year. It is therefore possible to maintain a filter pressure of at least 4 bar (absolute).

### ***Shield gas sampling***

A protocol for the hydration of the sand shield was developed in the beginning of 2007. A concern for the upcoming gas injection test (and thus for the hydration of the shield) was to make sure that no pockets of “dry gas” remained in the shield. As a first step, the gas in the shield was therefore sampled and analysed. The sample was characterised by relatively high contents of carbon dioxide, helium, hydrogen and methane.

### ***Hydration of sand shield***

The hydration activity was launched in September with the aim to saturate the sand shield around the upper heater with water. It was soon noticed that the injection points in the shield (or their surroundings) exhibited a high flow resistance as soon as water was injected through them. This difficulty limited the rate of hydration, and therefore high injection pressures (20–40 bar) applied. The flow resistance decreased however with time and at the end of December it was possible to inject approximately 10 litres per day. Approximately 250 litres, i.e. half of the available pore volume, had been injected at the end of the year.

### ***Change in power output***

The power output from the heaters was changed during the last two months of the year. The power from the lower heater was increased from 1,600 to 2,000 W, while the output from the upper heater was decreased from 1,600 W to 1,000 W. All changes were made in weekly steps of 100 W.

This change has altered the thermal conditions in the experiment. At the end of the year the temperature on the mid-section of the lower heater was 158°C. The corresponding value for the upper heater was 89°C (Figure 4-13). This alteration has also influenced the hydro-mechanical conditions as recorded by the sensors for total pressure and pore pressure. Prior to the power change, only one capacitive relative humidity sensor (in cylinder 1 – below the lower heater) still showed values below saturation. This sensor reached however 100% during the power change (Figure 4-14). Significant increase in pore pressure levels around the lower heater indicates the ongoing water saturation process. However pore pressures reached are still below the sand filter water pressure in the sand filter (Figure 4-15). There are no remaining capacitive RH-sensors in the buffer that has not yet indicated saturated conditions. The total pressure sensors also responded temporarily as a result of the change in the thermal conditions. The cable forces appear however to have stabilised (Figure 4-16). The continuing evolution of these parameters will reveal if this is a true indication of total saturation.

January 1, 2007

January 1, 2008

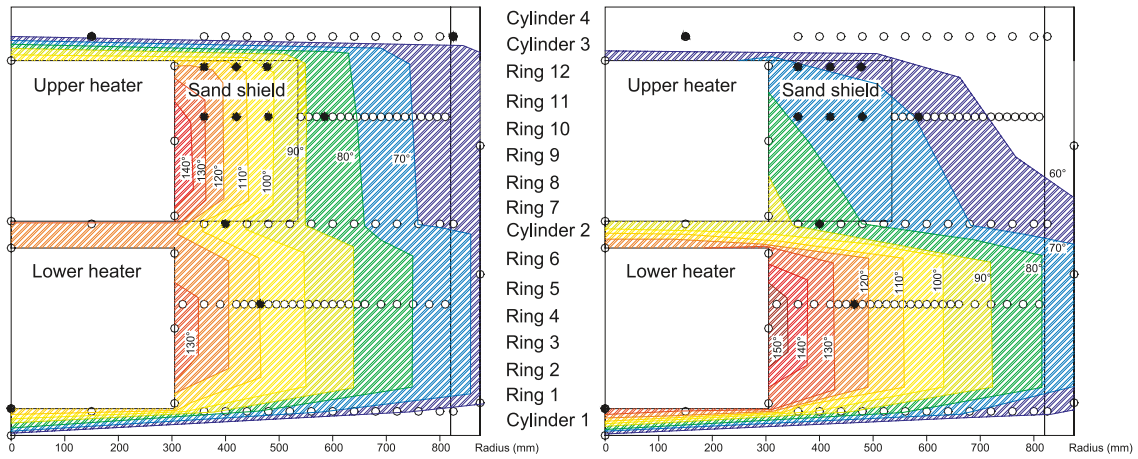


Figure 4-13. Temperature distribution at 1<sup>st</sup> January 2007 (left) and 2008 (right). Rings indicate sensor positions. Filled rings indicate sensors out of order.

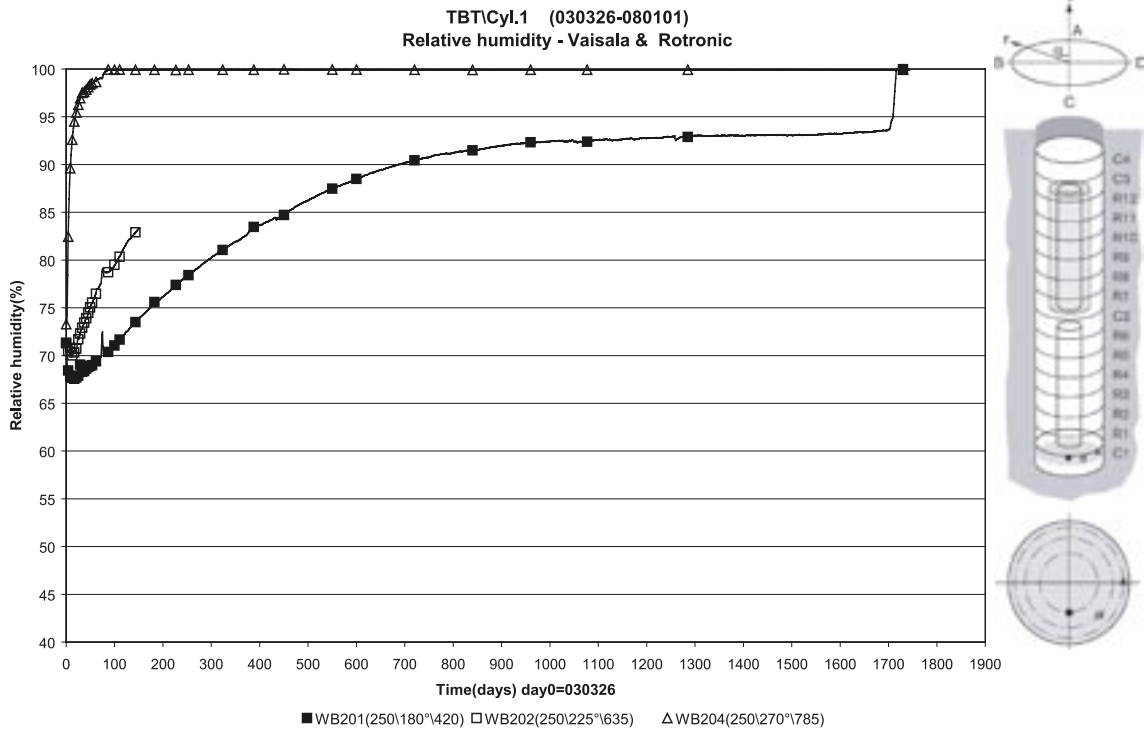


Figure 4-14. Measured relative humidity in Cylinder1 (C1) (26<sup>th</sup> March 2003 to 1<sup>st</sup> January 2008).



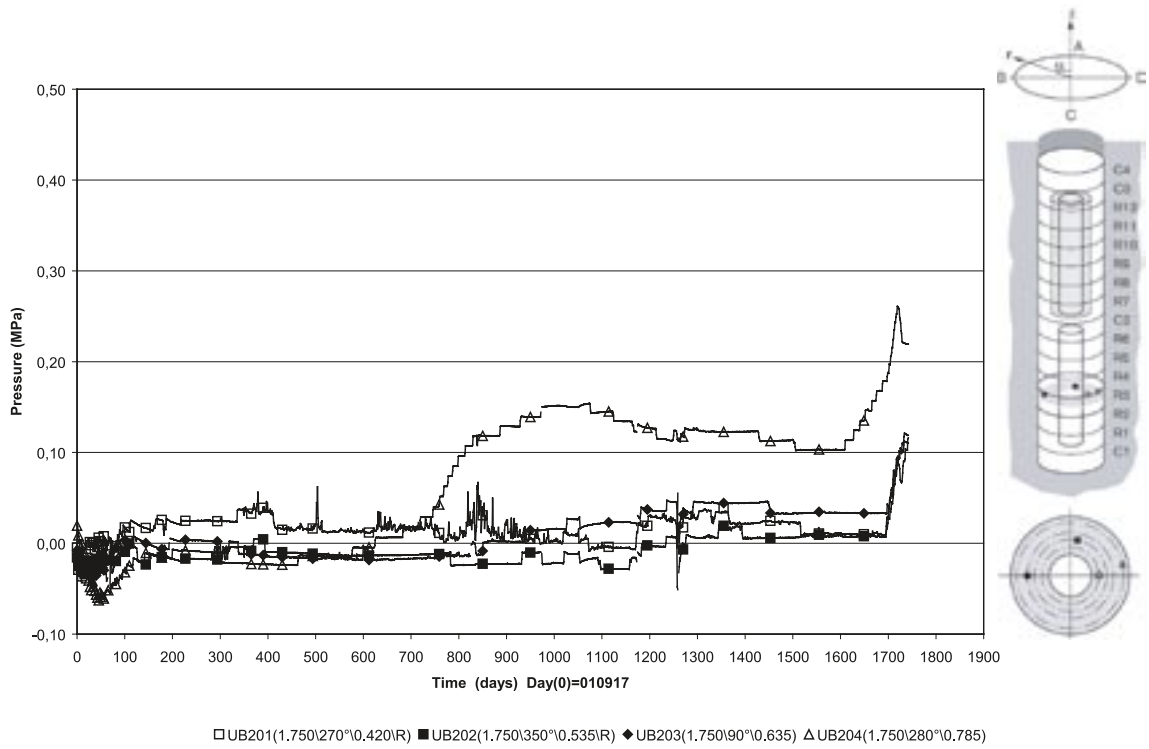


Figure 4-15. Measured pore pressure in Ring 3 (26<sup>th</sup> March 2003 to 1<sup>st</sup> January 2008).

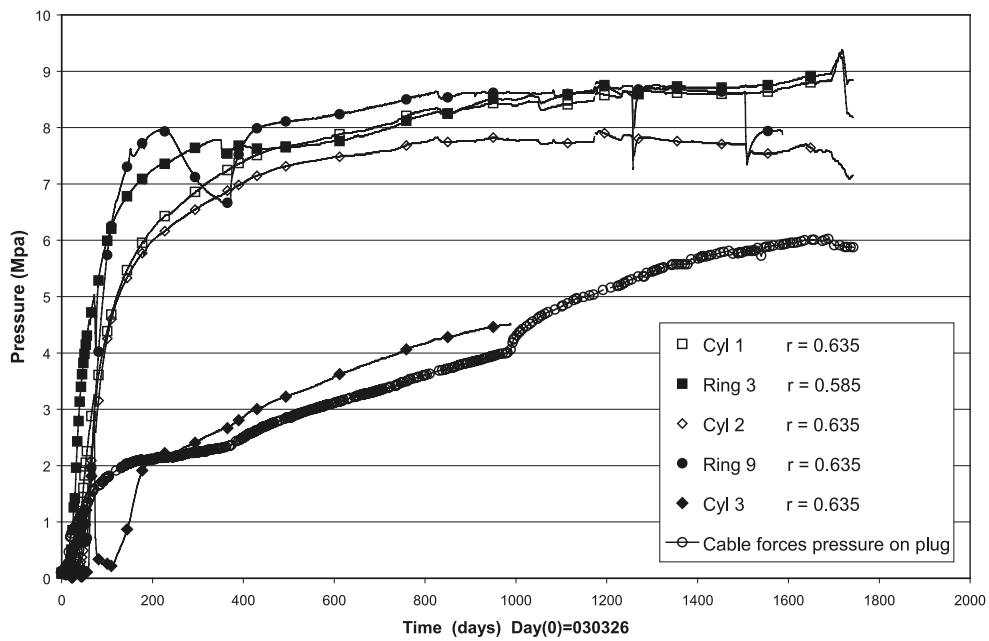


Figure 4-16. Axial pressure measured in different sections. Cable forces are shown as pressures, assuming an even distribution over the rock hole area (2.40 m<sup>2</sup>)

## 4.8 KBS-3 Method with Horizontal Emplacement

### 4.8.1 Background

The KBS-3 method, which is based on the multi-barrier principle, has been accepted by the Swedish authorities and the government as a basis for planning the final disposal of spent nuclear fuel. The possibility to modify the reference method and make a serial deposition of canisters in long horizontal holes (KBS-3H), see Figure 4-17, instead of vertical emplacement of single canisters in separate deposition hole (KBS-3V) which is SKB's reference design, has been considered since early nineties. The deposition process for KBS-3H requires the assembly of each copper canister and its buffer material in a prefabricated, so-called Supercontainer.

Most of the positive effects of horizontal emplacement compared with vertical emplacement are related to the smaller volume of excavated rock. Examples of positive effects are:

- Less environmental impact during construction.
  - Reduced disturbance on the rock mass during construction and operation.
  - Reduced cost for construction and backfilling of the repository compared to KBS-3V.
- However, great efforts are required developing the KBS-3H design.

At the end of 2001 SKB published a RD&D programme for the KBS-3 method with horizontal emplacement. The RD&D programme /SKB 2001/ which is divided into four parts: Feasibility study, Basic design, Demonstration of the concept at Äspö HRL and Evaluation is carried through by SKB in co-operation with Posiva. The development of the deposition equipment is partly funded by the European Commission Esdred (Engineering Studies and Demonstration of Repository Design) Programme for studies on deposition equipment during the 2002–2006 period.

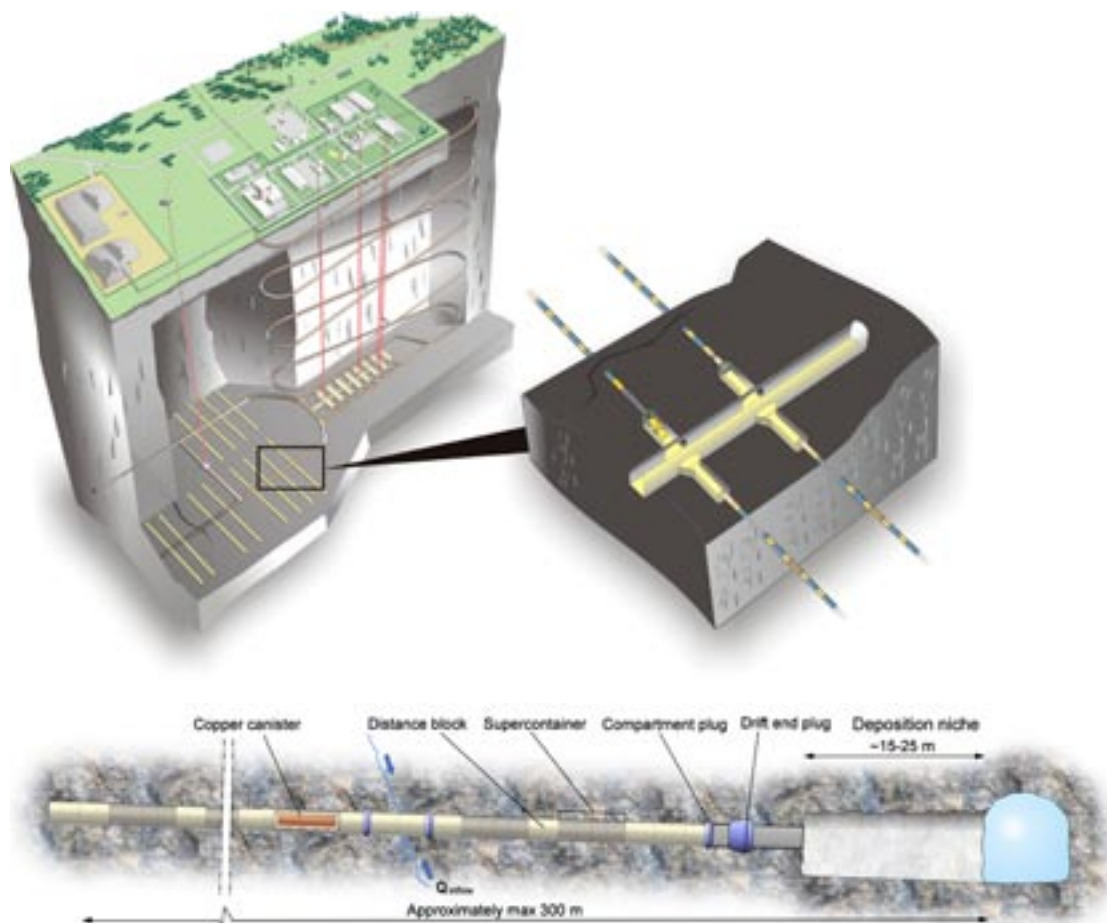


Figure 4-17. Schematic illustrations of KBS-3H.

## 4.8.2 Objectives

The objective of the first part of the project, the Feasibility study, was to evaluate whether horizontal emplacement is a realistic alternative, and if so, to give SKB and Posiva a basis for continued evaluation of KBS-3H. The feasibility study focused on differences compared to the reference design KBS-3V. Highlighted tasks were excavation of the drifts, the deposition technique and the function of the buffer.

The second part, the Basic design study /Thorsager and Lindgren 2004/, focuses on technology for excavation of holes, emplacement of Supercontainers, but also the design of the bentonite buffer inside the Supercontainers. In addition, an evaluation of the long term safety of the concept was carried out.

## 4.8.3 Demonstration site

The need to demonstrate the KBS-3H concept was foreseen in the KBS-3H feasibility study. Investigations into a suitable location and preparation of a demonstration site at Äspö HRL were decided upon. The demonstration site is located at the –220 m level in a niche with the dimensions 15 by 25 meters. The niche is designed to accommodate the vehicles, machinery and auxiliary equipment used for drilling the holes. Two horizontal holes with a diameter of 1.85 m have been excavated, one hole is 15 m long and the other is 95 m. The short hole is used for construction and testing of e.g. a low-pH shotcrete plug and other design drift components, and the long hole is primarily used for demonstration of the deposition equipment and also for some full-scale tests.

## 4.8.4 Results

Results and conclusions of the KBS-3H project phase 2004–2007 was summarised in end of 2007. A lot of work has been performed in the project and the conclusions are that the KBS-3H design seems to be feasible. A technical design of the concept has been developed and a preliminary safety assessment based on Olkiluoto data has been performed. In the design there are still several uncertainties identified e.g. erosion and piping of bentonite, iron-bentonite interaction which have to be resolved. Both SKB and Posiva have decided to continue the development of the KBS-3H design for the two coming years.

### ***Deposition equipment***

During 2007 the testing and demonstration of the horizontal emplacement technique of spent fuel using the developed and manufactures deposition equipment could be performed. Problem with balancing of the deposition machine was solved in mid February and the site acceptance test (SAT) could be performed and the equipment approved.

After the SAT started the long term test of the equipment and the cumulative travel distance in the 95 m long drift at –220 m level of the deposition machine with a Supercontainer was approximately 12,000 m. The performance requirement of an average deposition speed of 20 mm per second was reached. In general the emplacement technique functions very well. Problem with the water cushion pressure relief valves due to a tendency to jam after a period of operation, resulting in high cushion pressures that can damage the cushions has been solved by replacing the valves with another manufacture. Further tests with the new valves will be performed.

### ***Megapacker test***

A new post grouting device (Megapacker) for KBS-3H was developed and manufactured during the first half of 2007. In autumn the Megapacker has been tested in the 95 meter hole. Two of the five identified fracture zones in the drift have been grouted in the first test phase with good

results. The leakages were significantly decreased from 0.45 L/min to 0.015 L/min in zone number 3 and from 2.2 L/min to 0.007 L/min in zone number 1. The total inflow to the drift was reduced from 4.4 L/min to 2.77 L/min.

The remaining fracture zones (number 2, 4 and 5) will be grouted in the second test phase of the Megapacker test during the first half of 2008. Prior the second test phase the Megapacker will be somewhat improved. The issues are mostly related to work environment but minor upgrades in functionality will also be implemented.

### ***Compartment plug***

Originally a steel compartment plug should have been installed and tested during 2007. For several reasons it was during spring 2007 decided not to perform the plug installation. Preparations, including the plug rock notch, should still be conducted, mainly to test the method to excavate the notch by sawing.

Several cuts were made with 3–4 cm distance. The notch with the profile of a “v” with a flat bottom was created by varying the depths of the cuts. When all cuts were made the discs between the cuts were broken off.

The sawing was found successful. The notch was excavated in the 15 meter drift some 50 cm from the drift face and is ready for a future compartment plug installation.

### ***Pipe removal***

Two design variants are considered for the KBS-3H design: the Basic Design and the DAWE (drainage, artificial watering and air evacuation) design. To verify the ability to remove the saturation pipes, in DAWE, three tests on pulling out water pipes through bentonite are planned. The first test was installed in October 2007 and was still in operation at the end of 2007. The second and possibly the third test will be executed during 2008.

The preliminary result indicates that the pipes can safely be removed during the first week after filling the slot between the rock and buffer with water.

## **4.9 Large Scale Gas Injection Test**

### **4.9.1 Background**

The bentonite buffer is an important barrier in the KBS-3 system. A key purpose of the buffer is to serve as a diffusion barrier between the canister and the groundwater in the rock. An important performance requirement of the buffer material is that it should not cause any harm to the other barrier systems. Gas build-up from, for example, corrosion of the iron insert could potentially affect the buffer performance in three ways:

- Permanent pathways in the buffer could form at gas breakthrough. This could potentially lead to a loss of the diffusion barrier.
- If the buffer does not let the gas through, the pressure could lead to mechanical damage of the other barriers.
- The gas could de-hydrate the buffer.

Current knowledge pertaining to the movement of gas in initially water saturated buffer bentonite is based on small-scale laboratory studies. While significant improvements in our understanding of the gas-buffer system have taken place, recent laboratory work has highlighted a number of uncertainties, notably the sensitivity of the gas migration process to experimental boundary conditions and possible scale-dependency of the measured responses. These issues are best addressed by undertaking large scale gas injection tests.

## 4.9.2 Objectives

The aim of the Large Scale Gas Injection Test (Lasgit) is to perform a gas injection test in a full-scale KBS-3 deposition hole. The objective of this experimental programme is twofold. Firstly, to provide data to improve process understanding. Secondly, to test and validate modelling approaches which might be used in a performance assessment. Specific objectives are:

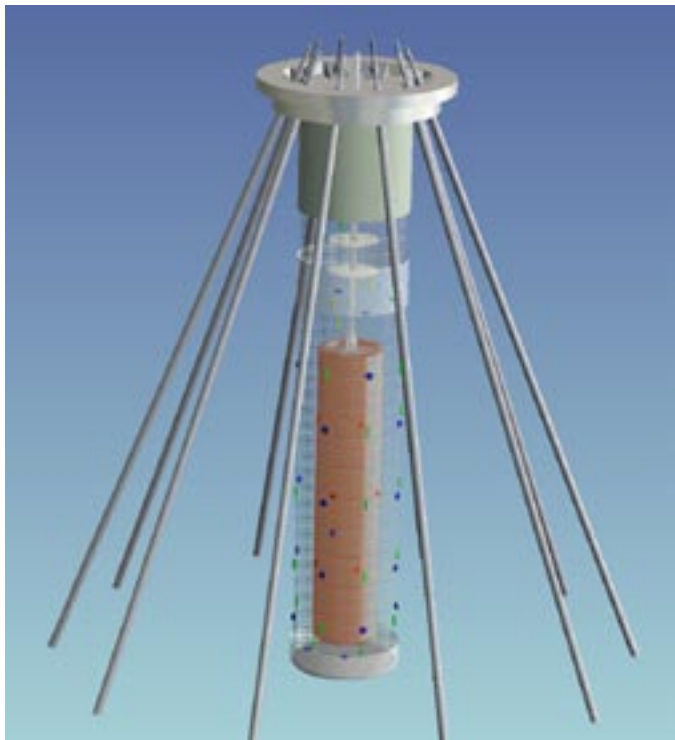
- Perform and interpret a large scale gas injection test based on the KBS-3 repository design concept.
- Examine issues relating to up-scaling and its effect on gas movement and buffer performance.
- Provide additional information on the processes governing gas migration.
- Provide high-quality test data to test and validate modelling approaches.

## 4.9.3 Experimental concept

Lasgit is a full-scale demonstration project conducted in the assembly hall area in Äspö HRL at a depth of –420 m. A deposition hole, 8.5 m deep and 1.8 m in diameter, has been drilled into the gallery floor. A full-scale KBS-3 canister (without heater) has been emplaced in the hole. Thirteen circular filters of varying dimensions are located on the surface of the canister to provide point sources for the injection of gas to mimic canister defects. Pre-compacted bentonite blocks with high initial water saturation have been installed in the deposition hole. The hole has been capped by a conical concrete plug retained by a reinforced steel lid capable of withstanding over 5,000 tonnes of force (Figure 4-18).

In the field laboratory, instruments continually monitor variations in the relative humidity of the clay, the total stress and porewater pressure at the borehole wall, the temperature, any upward displacement of the lid and the restraining forces on the rock anchors.

The experiment is a “mock-up test” which does not use any radioactive materials.



**Figure 4-18.** Layout of the Lasgit experiment showing the copper canister, the bentonite buffer, the location of some of the instrumentation, the plug and rock anchors.

The Lasgit experiment consists of three operational phases; the installation phase, the hydration phase and the gas injection phase. The installation phase was undertaken from 2003 to early 2005 and consisted of the design, construction and emplacement of the infrastructure necessary to perform the Lasgit experiment.

The hydration phase began on the 1<sup>st</sup> February 2005 with the closure of the deposition hole. The aim of this phase of the experiment is to fully saturate and equilibrate the buffer with natural groundwater and injected water. The saturation is monitored by measuring pore pressure, total pressure and suction at both the buffer/rock interface and key locations within individual clay blocks. The hydration phase provides an additional set of data for (T)HM modelling of water uptake in a bentonite buffer. However, no such modelling is planned within the project at this stage.

When the buffer is considered to be fully saturated, the *gas injection phase* will start. A series of detailed gas injection histories will be performed and the processes and mechanisms governing gas flow in bentonite will be examined.

#### 4.9.4 Results

At the request of project stakeholders a preliminary gas injection test was undertaken during 2007 with a view to verifying the operation and data reduction methodologies outlined in the original concept report and to provide qualitative data on hydraulic and gas transport parameters for a bentonite buffer during the hydration process. It was decided the preliminary mass transport measurements would be undertaken in one of the 100 mm filters positioned in the lower canister array.

The hydraulic and gas injection tests were started on the 25<sup>th</sup> May 2007 with the isolation of the lower canister filters (FL901 to FL904) while artificial hydration continued through all other canister filters and filter mats. After a period of 27 days a constant head test was initiated on filter FL903, raising its pressure to 4.3 MPa for 28 days and then reducing it to 560 kPa for a further 19 days. Gas injection to FL903 was then begun with an initial volume of gas being compressed at a steady rate for 13 days, a period of 22 days with gas pressure held constant and then a further period of 22 days during which pressures were raised again. Compression of the gas was then halted and the pressure monitored as it decayed for a further four weeks.

Preliminary modelling of the hydraulic test has been carried out using a 2D axisymmetric variably saturated finite element porewater flow model. Fits were obtained to the initial pressure decay data for the four filters that were isolated using values for hydraulic conductivity ranging from  $9 \times 10^{-14}$  to  $1.6 \times 10^{-13} \text{ ms}^{-1}$  and specific storage values ranging from  $5.5 \times 10^{-5}$  to  $4.4 \times 10^{-4} \text{ m}^{-1}$ . The constant pressure test on filter FL903 was fitted with a hydraulic conductivity of  $7.5 \times 10^{-14} \text{ ms}^{-1}$  and a specific storage of  $2.5 \times 10^{-5} \text{ m}^{-1}$ . The modelling done to set the initial conditions also shows that a significant zone around each of the canister filters remains unsaturated.

Analysis of the gas injection data suggest that gas starts to flow into the buffer at a pressure of about 775 kPa, which is much lower than the expected gas entry pressure for intact bentonite. It therefore seems likely that gas is flowing between the bentonite and the canister and possibly between bentonite blocks. The sudden reduction in gas flow when injection pressure was held constant is strongly indicative of pathway rather than visco-capillary flow within the original porosity of the clay.

Upon restarting gas injection, pathway propagation continues at the outset. Gas flux into the clay gradually increases as the pressure in the system rises. At a gas pressure marginally greater than the local total stress measured on the rock wall (but a little smaller than the radial and axial stresses measured on and near the canister surface respectively), flux into the clay rapidly

increases. Gas pressure continues to rise reaching a peak pressure of 5.66 MPa, which is marginally greater than the axial stress measured at PB902. This is followed by a small spontaneous negative transient leading to a quasi steady state. The post peak gas flux exhibits dynamic behaviour (over and undershooting flux into the system) suggestive of unstable gas flow. This general behaviour is reminiscent of the responses observed in previous laboratory scale tests.

Following the cessation of injection, the pressure initially drops rapidly but then decays very slowly towards an asymptotic capillary threshold pressure, which is estimated to be about 4,900 kPa, close to the average radial stress measured on the canister surface of 4,900 kPa.

Following peak gas pressure a well pronounced increase in radial stress occurs around the entire base of the deposition hole, with the highest increase noted in the vertical plane below the point of injection. Porewater pressure data from the deposition hole wall exhibit similar behaviour, though initial results suggest that the pulse in porewater pressure dissipates at a faster rate than that of the radial stress.

Porewater pressure sensors located within the buffer show no obvious sensitivity to the injection of gas. In contrast, axial stress sensors located beneath and above the canister appear to register the passage of gas providing evidence for the time dependent propagation of gas pathways.

While it is difficult to make definitive statements regarding the exact direction and number of gas flow paths, it seems highly probable that the gas moved generally downwards away from the injection filter and then along the interface between blocks. This is logical as there is a clear axial stress gradient running from high to low from the top of the deposition hole to the lowest stress sensor. Under most conditions gas would propagate along such a stress vector.

However, the general coupling between gas, stress and porewater pressure at the repository scale is extremely important and can readily be explained through concepts of pathway dilatancy. The reduction in flux when gas pressure was held constant supports this hypothesis. These observations are qualitatively similar to those reported by previous laboratory based studies.

## **4.10 In Situ Corrosion Testing of Miniature Canisters**

### **4.10.1 Background**

The evolution of the environment inside a copper canister with a cast iron insert after failure is of great importance for assessing the release of radionuclides from the canister. After failure of the outer copper shell, the course of the subsequent corrosion in the gap between the copper shell and the cast iron insert will determine the possible scenarios for radionuclide release from the canister. This has been studied experimentally in the laboratory and been modelled. In this project miniature copper canisters containing a cast iron insert will be exposed for several years in boreholes in the Äspö HRL. Defects have been deliberately introduced into the outer copper canister so that evolution of corrosion inside the canisters can be investigated. The corrosion will take place under reducing, oxygen-free condition in the presence of microbial activity present in the groundwater; such conditions are very difficult to create and maintain for longer periods of time in the laboratory. Consequently the in situ experiments at Äspö HRL will be invaluable for understanding the development of the environment inside the canister after initial penetration of the outer copper shell.

### **4.10.2 Objectives**

The main objective of the work is to provide information about how the environment inside a copper canister containing a cast iron insert would evolve if failure of the outer copper shell were to occur. This is important because the development of corrosion products in the gap

between the copper shell and the cast iron insert could affect the rate of radionuclide release from the canister. The results of the experiment will be used to support process descriptions and safety analyses. The following specific issues are being addressed:

- Does water penetrate through a small defect into the annulus between the cast iron insert and the outer copper canister?
- How does corrosion product spread around the annulus in relation to the leak point?
- Does the formation of anaerobic corrosion product in a constricted annulus cause any expansive damage to the copper canister?
- Is there any detectable corrosion at the copper welds?
- Are there any deleterious galvanic interactions between copper and cast iron?
- Does corrosion lead to failure of the lid on the iron insert?
- Are there any effects of microbial corrosion on the canister?
- What are the corrosion rates of cast iron and copper in the repository environment?
- What is the risk of stress corrosion cracking of the copper?

#### **4.10.3 Experimental concept**

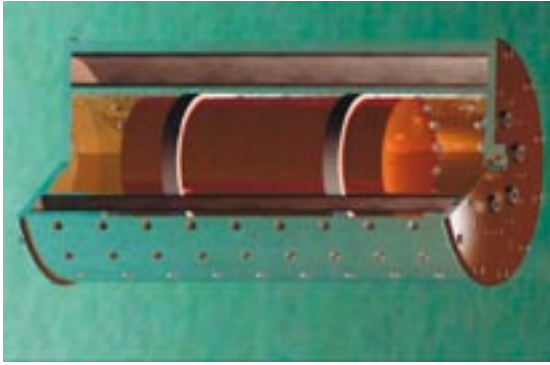
Miniature canisters with a diameter of 14.5 cm and length 31.5 cm have been set up in five boreholes with a diameter of 30 cm and a length of 5 m. The model canister design simulates the main features of the SKB canister design. The cast iron insert contains four holes simulating the fuel pin channels, together with a bolted cast iron lid sealed with a Viton O-ring. The copper lid and base are electron beam welded to the cylindrical body. The annulus between the cast iron insert and the outer copper body is < 30 µm wide. All the canisters have one or more 1 mm diameter defects in the outer copper shell, in a range of different orientations. The canisters are mounted in electrically insulated support cages (Figure 4-19), which contain bentonite clay of two different densities. There is no direct electrical contact between the copper canister and the stainless steel support cages. One experiment does not contain any bentonite, to investigate the direct effect of raw groundwater on the corrosion behaviour. Cast iron and copper corrosion coupons are mounted inside the support cages of each experiment and corrosion behaviour is monitored electrochemically. Cast iron and copper weight loss specimens are also present. Each support cage contains a 'sandwich type' copper-cast iron specimen to investigate oxide jacking effects and galvanic corrosion. U-bend and wedge open loading stress corrosion specimens are mounted in one of the boreholes in direct contact with the groundwater, to assess the possible risk of stress corrosion cracking of copper. In addition, two of the canisters will be monitored using strain gauges to monitor any expansion effects. The redox potential, Eh, is being monitored using a combination of metal oxide, platinum and gold electrodes. The experiments are located where there are many fractures around the boreholes, leading to a plentiful supply of natural reducing groundwater to the experiments (Figure 4-20).

#### **Monitoring**

The experiments are continuously monitored to measure the following parameters:

- Corrosion potential of the model canister, cast iron and copper.
- Electrochemical potential of gold, platinum and a mixed metal oxide Eh probe.
- Corrosion rate of cast iron and copper, using linear polarisation resistance, AC impedance and electrochemical noise.
- Strain on the surface of two of the model canisters.





**Figure 4-19.** Design of model canister experiment showing copper canister in support cage.

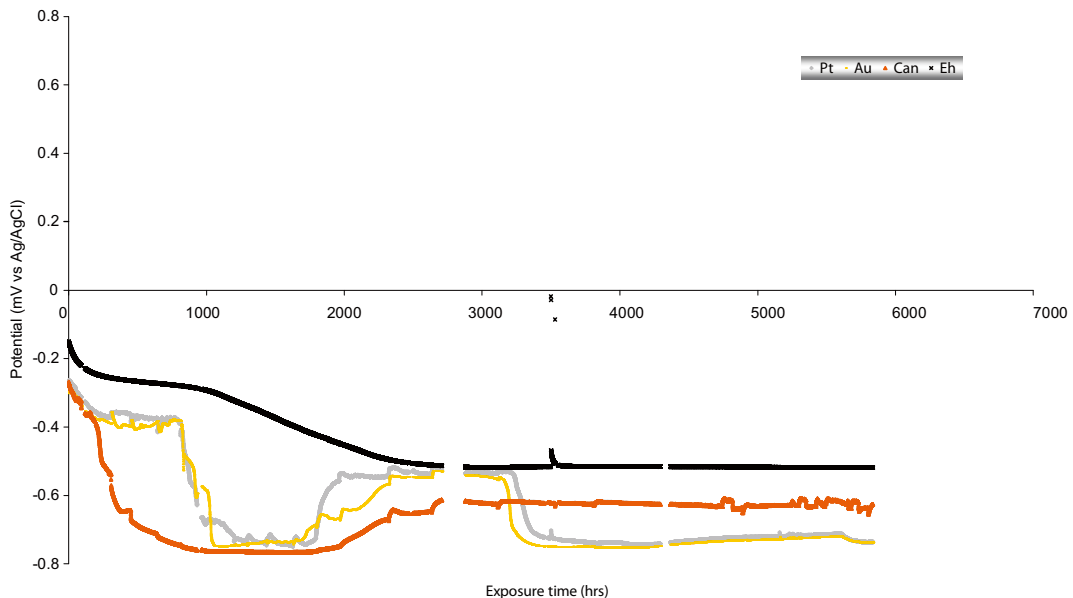


**Figure 4-20.** Installation of model canister experiment.

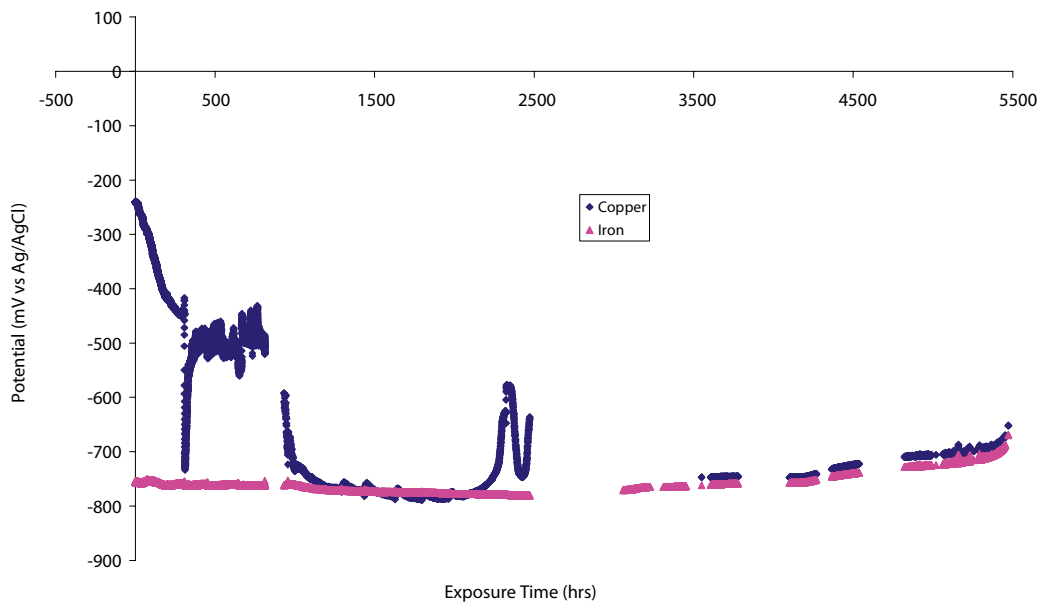
Regular water samples are taken from within the support cages to monitor the development of the local chemistry. The experiments will remain in situ for several years, after which they will be dismantled and the evolution of the corrosion front inside the canister will be analysed.

#### 4.10.4 Results

Installation of the canisters was completed at the beginning of January 2007, since when automated monitoring of the experiments has been in progress. Some examples of the data acquired are shown below (Figure 4-21 and Figure 4-22). Data are being collected for corrosion rate of copper and iron electrodes, and electrochemical potentials for a range of electrodes, including Eh, iron and copper. In addition strain gauge data are being collected for two of the canisters. Water analysis, including analysis of microbial content of the water, has been carried out periodically. A report on the set up of the experiments and the first year's activities and results is in preparation.



**Figure 4-21.** Electrochemical potential measurements in Borehole 3, for platinum, gold, the miniature canister and the Eh probe, which is mounted outside the canister assembly.



**Figure 4-22.** Electrochemical potential measurements in Borehole 3, for iron and copper electrodes inside the miniature canister assembly.

## 4.11 Cleaning and Sealing of Investigation Boreholes

### 4.11.1 Background

Investigation boreholes are drilled during site investigations and detailed characterised in order to obtain data on the properties of the rock. These boreholes must be sealed, no later than at the closure of the final repository, so that they do not constitute flow-paths from repository depth to the biosphere. Hence, the sealed boreholes must have a hydraulic conductivity that does not exceed that of the surrounding rock. A project was therefore initiated in 2002 by SKB and Posiva, with the aim to identify and demonstrate the best available techniques for cleaning and sealing of investigation boreholes.

Sealing of boreholes with cementitious materials is commonly used in construction work and can be performed with well-known techniques. Earlier studies, e.g. the Stripa project, have shown that sealing with cementitious material include a potential risk for degradation due to leaching and the sealing can not be guaranteed over time-periods longer than hundreds of years. The required long term function requires use of swelling clay materials, such as compacted bentonite blocks or bentonite pellets. Sealing with bentonite blocks has been tested in the framework of the Stripa project, in boreholes with a length of 200 m, with very promising results. A further development of this technique is, however, required to show that boreholes with lengths of up to 1,000 m can be sealed.

### 4.11.2 Objectives

The main objective of this project is to identify, demonstrate and – if necessary – develop new techniques for cleaning and sealing of investigation boreholes. Cleaning means removal of any instrumentation and rinsing of borehole walls. The project comprises three phases. Phase 1, mainly an inventory of available techniques, was finalised in 2003. Phase 2 aims to develop a complete cleaning and sealing concept “Basic Concept”. In Phase 3, which was completed in 2007, the techniques have been tested and demonstrated by performing full-scale lab and field tests. The work was divided in the four sub-projects described below.

### Sub-project 1

This sub-project comprises detailed design of borehole plugs of clay and cement, respectively.

For the clay plugs a Basic Concept has been developed using highly compacted clay in perforated tubes see Figure 4-23. The Basic Concept is primarily intended for use in boreholes with up to 1,000 m depth. Three alternative plug concepts have been tested: 1) highly compacted clay in closed container to be opened at any desired depth for placing the clay (this has however not yet been tested under realistic conditions at great depth), 2) highly compacted rings of clay stacked on a copper rod that is left in the holes (Couronne Concept) and 3) highly compacted clay pellets filled in the hole (Pellet Concept). It is concluded that alternatives 2 and 3 are applicable mainly to relatively short holes.

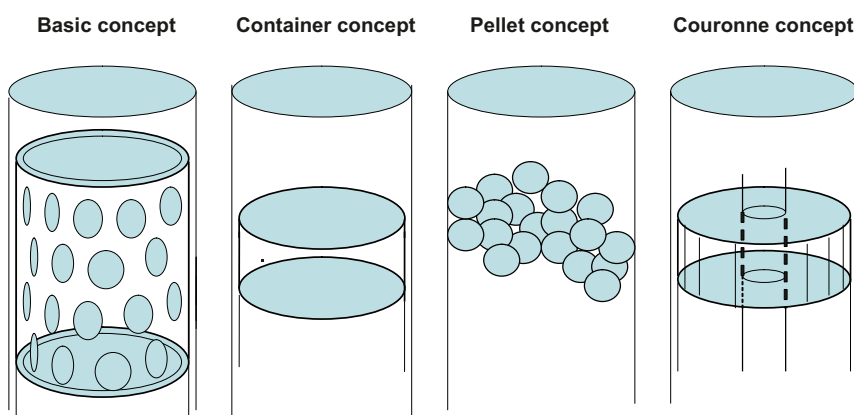
For cement-based plugs different concrete mixtures and laboratory techniques are investigated through the Swedish Cement and Concrete Research Institute (CBI) for preparation of concrete with a low content of cement (silica cement) and a suitably graded quartz grain ballast, fulfilling the requirement that it must not collapse even if total loss of the cement component takes place. This goal has been achieved.

The work comprises the following steps:

- Theoretical modelling of the hydration and maturation of the clay components in the respective plugs.
- Definition of the most suitable density and water content of clay components, or the available density, based on the modelling.
- Laboratory and small-scale field testing of erodability of clay components in perforated tubes.
- Laboratory testing of the maturation rate for assessment of the theoretical model using different water salinities and perforation geometries.
- Manufacturing of clay components for plugging of short and long holes.
- Investigation and pre-testing of all four methods.

### Sub-project 2

This sub-project includes two studies: 1) An estimate of the practicality and general applicability of the various plugging techniques studied within sub-project 1 and 2) Determination of the maturation rate of the plugs under realistic conditions in rock.



**Figure 4-23.** Illustration of “Basic Concept” for plugging of boreholes together with three alternative concepts. “Basic Concept” – Bentonite in perforated copper tubes. “Container Concept” – bentonite blocks in a container. “Pellet Concept” – Bentonite pellets. “Couronne Concept” – Bentonite blocks with a hole in the centre placed on a copper rod.

The first study includes assessment of how doable the plugs are, estimation of the need for rigs and tools for placement and possible retrieval, and required forces for bringing the plugs into and out from the holes, as well as estimation of the possibility to plug graded horizontal and upward-directed holes.

The second study is made using hydraulically characterised 5 m deep, 76–80 mm diameter boreholes at Äspö, including all four plugging methods. In each of the holes the plug is installed upon a hydraulic jack that can be pressurised by a pump placed on the floor and connected to the jack through an equally deep hole that intersected the plugged hole at its lower end. The principle is to examine the maturation rate by stepwise increasing the load on the clay plug until it starts moving, which gives the plug/rock adhesion strength. This strength increases as a function of the wetting and homogenisation rates of the plugs and hence gives information on the maturation rate.

### **Sub-project 3**

This sub-project has two parts. The first and major activity is to install cement and clay plugs in the 76 mm wide core hole OL-KR24 at Olkiluoto at levels selected on the basis of borehole data respecting hydraulic performance and fracture frequency. The other part of the project includes placement of cement and clay plugs in two 5 m deep 76 mm boreholes on the 210 m level at Äspö. The major issues are:

- Demonstration of the feasibility of the basic plugging method, i.e. placement of segments of jointed units of perforated copper tubes filled with highly compacted Na-bentonite columns at about 525 m depth (the basic concept).
- Demonstration of the feasibility of filling parts of the borehole that intersect fracture zones with chemically stable quartz-cement at 520–530 m depth.
- Demonstration and evaluation of a technique to bring down a dummy for checking the clearance of a real plug segment before installing it.
- Demonstration of the feasibility of replacing natural water in the hole by tap water.

Posiva has the responsibility of stabilising, cleaning and preparation of the deep hole at Olkiluoto while SKB is responsible for constructing the plugs. The placement in the deep hole is a joint SKB/Posiva project. This sub-project includes definition of a detailed laboratory analysis programme for investigation of the cement and clay plugs when they are extracted from the rock a few years after placement.

For the short holes at the –210 m level in the Äspö HRL, the same analysis programme will be applied. This study is intended to take place about half a year after placement, which would make it possible to identify the early chemical interaction between clay and cement, while the Olkiluoto samples would show later phases in such interaction. Sampling of the plugs in Äspö HRL will require overcoring for which no date has yet been decided.

### **Sub-project 4**

The aim of this sub-project was to test the feasibility of two candidate techniques intended for mechanical securing of the tight seals emplaced in the upper part of deep boreholes or near the galleries in holes bored from their interior.

This sub-project comprises demonstration of plugging of boreholes (20 m deep, 200 mm diameter) from the ground surface, and plugging and testing of plugs in three boreholes (1.5 m deep, 200 mm diameter) at about 400 m depth in the Äspö HRL. They are located in the same area as the 5 m long holes investigated in Sub-project 2. The two types are represented by (1) concrete

using silica cement developed by CBI adding quartz fragments for stiffening and (2) metal copper plugs of expander type. The shallow tests are made with concrete and copper in separate holes. The plugs at depth are all made with concrete as plug material but with different contents of quartzite fragments. They extend into 30 mm high and deep recesses and are tested after about 30 days of maturation by loading them axially for determining the shear strength.

### **4.11.3 Results**

The entire Phase 3 was successful and the outcome of the four sub-projects can be summarised as follows.

#### ***Subproject 1***

Theoretical modelling of the hydration and maturation of the clay components in the respective plugs has been accomplished. Suitable clay densities and water contents as well as preparation techniques have been developed. Erosion resistance of “Basic-type” clay plugs has been determined, indicating that such plugs may be installed at up to 1,000 m depth, but preferably not deeper than 500 m.

#### ***Sub-project 2***

All the proposed designs are applicable but there are restrictions respecting the depth of the holes to be plugged:

- Basic Concept – is suitable in holes oriented in any direction down to 500–1,000 m depth.
- Pellet Concept – is suitable in short downward-oriented holes.
- Couronne Concept – is suitable in up to hundred meter long, steep holes and in a few tens of metres long holes oriented in any direction.
- Container Concept – have a potential of being used in holes of at least 1,000 m depth. ” This has however not yet been tested.

The extrusion experiments showed that the maturation rate is relatively high. It can be predicted with reasonable accuracy if the rock structure and piezometric conditions are known. In principle, the adhesion of all the plug types is sufficiently high to make them resist axial forces of several kN after a week.

#### ***Sub-project 3***

The deep hole at Olkiluoto was successfully plugged with silica cement and clay of “Basic-type”. Further experiments are called for in order to ensure that borehole stabilisation can be performed and that relevant characterisation of the boreholes can be made for selecting levels for stabilisation and placement of cement-based and clay-based plugs. The plugs in the shorter holes in Äspö HRL have been successfully installed and should be sampled for physical and chemical analysis as soon as possible.

#### ***Sub-project 4***

The techniques developed for sealing near-end large-diameter boreholes are feasible. The plug type represented by concrete using silica cement and adding quartz fragments for stiffening had very high strength, and metal copper plugs of expander type may take even higher axial loads, represented by the water pressure in kilometre-deep holes.

## 4.12 Task Force on Engineered Barrier Systems

### 4.12.1 Background and objectives

The Task Force on Engineered Barrier Systems is a natural continuation of the modelling work in the Prototype Repository Project. Modelling work on other experiments, both field and laboratory tests, are also conducted. The Äspö HRL International Joint Committee (IJC) decided that in the first phase of this Task Force (period 2004–2008), work should concentrate on:

- Task 1: THM modelling of processes during water transfer in buffer, backfill and near-field rock. Only crystalline rock is considered in this phase.
- Task 2: Gas transport in saturated buffer.

All defined tasks are given in Table 4-2.

The objectives of the Tasks are to: (a) verify the capability to model THM and gas migration processes in unsaturated as well as saturated bentonite buffer, (b) refine codes that provide more accurate predictions in relation to the experimental data and (c) develop the codes to 3D standard (long term objective).

Participating organisations besides SKB are at present: Andra (France), BMWi (Germany), CRIEPI (Japan), Nagra (Switzerland), Posiva (Finland), NWMO (Canada) and RAWRA (Czech Republic). All together 12–14 modelling teams are participating in the work.

Since the Task Force does not include geochemistry, a decision was taken by IJC to also start a parallel Task Force that deals with geochemical processes in engineered barriers. This Task Force was initiated at the end of 2006 and during 2007 SKB (Clay Technology), Nagra (University of Bern) and Posiva (VTT) has participated. Recently the geochemical Task Force was also joined by Andra. The two Task Forces have common secretariat (Clay Technology) but separate chairmen (THM/Gas: A. Gens, UPC and Geochemistry: Urs Mäder, University of Bern).

**Table 4-2. Modelled tests in this first phase of the Task Force on Engineered Barrier System.**

---

#### Benchmark 1 – Laboratory tests

##### Task 1 – THM tests

- 1.1.1 Two constant volume tests on MX-80 (CEA)
- 1.1.2 Two constant volume tests on Febex bentonite – one with thermal gradient and one isothermal (Ciemat)
- 1.1.3 Constant external total pressure test with temperature gradient on Febex bentonite (UPC)

##### Task 2 – Gas migration tests

- 1.2.1 Constant external total pressure (BGS)
- 1.2.2 Constant volume (BGS)

#### Benchmark 2 – Large scale field tests

##### Task 1 – THM tests

- 2.1 URL tests Buffer/Container Experiment and Isothermal Test (AECL)
  - 2.2 Canister Retrieval Test in Äspö HRL (SKB)
-

## 4.12.2 Results

Two Task Force meetings have been held during 2007; one in Weimar in May and one in Stockholm in November.

### **THM/Gas**

#### *Benchmark 1 – Laboratory tests*

For Task 1 (THM) tests three Benchmark tests have been modelled by the teams. Two tasks concern the Spanish reference buffer material (Febex bentonite) and the other task concerns the Swedish reference buffer material (MX-80). The tasks were to model well documented laboratory tests of water uptake and temperature gradient induced water redistribution. Reports from the modelling teams have been delivered. The modelling results have been presented and compared with measurements in earlier meetings. In the meeting in Weimar the final evaluation of the results and the codes used were presented by the chairman. An evaluation report will be published.

For Task 2 (Gas) two Benchmark tests have been presented and attempts made to model these tests. Both tasks concern gas breakthrough in highly compacted water saturated MX-80. The modelling groups have had considerable problems in the modelling and so far the models used do not seem to be appropriate. Written reports have been delivered for compilation and review.

#### *Benchmark 2 – Large scale field tests*

For Task 1 the Buffer/Container Experiment and the Isothermal Test carried out by AECL have been presented and specifications delivered (Task 2.1). Results of two laboratory tests that could be used for parameter checking and calibration have also been distributed. The modelling has been performed and results have been presented at the meetings. Many modelling teams could get good results by changing parameter values, especially the retention curve of the buffer and the properties of the rock, but not for both the laboratory tests and the field tests with the same parameters (unless using divient approaches like a “cluster model”).

The other task (Task 2.2), that concerns modelling of the Canister Retrieval Test at Äspö HRL, has been revised and a final task description has been delivered to the participating teams and organisations. Modelling of this test will take place in 2008.

### **Geochemistry**

The geochemical Task Force has identified the need to adjust existing general geochemical modelling tools in order to successfully apply them to bentonite modelling – the intricate electrochemical characteristics of water saturated bentonite must be considered. In regard to this one of the creators (Tony Appello) of the popular geochemical modelling tool Phreeqc, was invited to present the newest features of this code. Several of these are directly useful for bentonite modelling, e.g. diffuse double layers, Donnan equilibrium and multicomponent diffusion. Further model development has been performed, particularly concerning the influence of concentration discontinuities on ion transport in bentonite. A dialog with Tony Appello has been initiated in order to continue the work of inclusion of these bentonite specific features into Phreeqc.

Results from the analysis of the Long Term Test of Buffer Material (Lot) A2-parcel was presented and modelling of the redistribution of minerals found in this parcel (mainly sulphates) as well as in pre-Lot laboratory studies was decided to be a common benchmark. Furthermore, results from and modelling of ongoing core infiltration experiments at Bern University on both bentonite (suitable as another common modelling benchmark) and claystone, was presented. A predictive geochemical modelling into the far future (100,000 years) of groundwater in a repository tunnel section backfilled with 30% bentonite/70% crushed rock performed at Technical Research Centre of Finland (VTT) was presented.

In parallel to the ongoing geochemical modelling and model development, molecular dynamics (MD) simulations of montmorillonite have been performed at Clay Technology. Using this technique, self diffusion coefficients of water and ions have been calculated for different water ratios and compared with those obtained from neutron scattering experiments. This study has been submitted for publication. Furthermore, using MD, accurate counter ion density profiles in montmorillonite have been calculated. These have been used to quantify the validity range of analytical continuum expressions (using the Poisson-Boltzmann equation) and are a key ingredient for understanding the very different chemico-mechanical behaviour of sodium and calcium montmorillonite.



## 5 Äspö facility

### 5.1 General

Important parts of the Äspö facility are the administration, operation, and maintenance of instruments as well as development of investigation methods. The Public Relations and Visitor Services group is responsible for presenting information about SKB and its facilities e.g. the Äspö HRL. They arrange visits to the facilities all year around as well as special events.

### 5.2 Äspö Hard Rock Laboratory

#### **Background**

The main goal for the operation of the rock laboratory is to provide a facility which is safe for everybody working in, or visiting it, and for the environment. This includes preventative and remedial maintenance in order to ensure that all systems such as drainage, electrical power, ventilation, alarm and communications are available in the underground laboratory at all times.

#### **Results**

No unplanned service interruptions have occurred during 2007, and thus the facility's goal, to have a degree of operational time of 98%, has been exceeded. The facility is serviced according to plan, and the front of all buildings has been repainted.

An automatic registration system is planned to be taken into use. This has been delayed because of the extensive control and documentation procedure needed. The system is being tested, but cannot be implemented until all procedures are completed.

A warehouse for machineries used has been completed at the tunnel entrance and a large tent has been bought and set up at the Bentonite Laboratory for storing of bentonite.

Preparations are ongoing for the building of an archive with the status of a National Archive. However, this has been delayed since the design of the archive was changed and because no license was obtained from the County Administrative Board for a planned drain-pipe. Both the archive and the drain-pipe are foreseen to be completed during 2008.

To increase road safety for the road leading to the rock laboratory, road barriers have been installed and trees have been cut down along the road to improve visibility.

### 5.3 Bentonite Laboratory

#### **Background**

Before building a final repository, further studies of buffer and backfill under different installation conditions are required. SKB has therefore built a Bentonite Laboratory at Äspö designed for studies of buffer and backfill materials. The laboratory has been in operation since spring 2007.

## **Objectives**

The laboratory, a hall with dimensions 15×30 m, includes two stations where the emplacement of buffer material at full scale can be tested under different conditions. The hall will also be used for testing of different types of backfill material and the further development of techniques for the backfilling of deposition tunnels.

## **Results**

The laboratory is working very well and provides good conditions for further work to secure the barriers function of the bentonite after installation. Performed activities and planned activities are presented below.

To prevent influence from leaking water on the buffer during the backfilling activities, there is a need for a buffer protection in the deposition hole, a protection that later will be removed. After development work and testing in the laboratory a solution comprising a bottom plate, buffer protection, alarm and drainage has been suggested. Some optimisations still remain before the installation including the foundation of low pH-concrete will be tested in full scale.

In the project “Full Scale Testing of Block Filling” different methods and techniques for installation of pellets and blocks in the deposition tunnels have been tested. The tests have been concentrated on different materials and the influence of inflowing water.

The “Pellets Installation Tests” have been performed in half scale and full scale size. In the Bentonite Laboratory there is a “tunnel” in half scale where the roof can be dismantled to see the filling after installation and also a full scale tunnel of wood. The tests have so far been successful, and in the beginning of 2008 a test with a spraying robot will be made.

In the project “Full Scale Testing of Block Filling”, a foundation/bedding for block installation has been tested. The properties of the bedding are important for the result of the block emplacement. A lot of work is remaining. Several materials have been adjusted and compacted in different designs at different water inflows in the tunnel. Blocks were thereafter stacked on the bedding and their positions were measured precisely after different periods.

It is not only a stable foundation that is requested, the material also has to hold as much water as possible. The bedding has in the tests been adjusted in a traditional way with an excavator and been compacted with a vibrating tool. Further work will aim at development of a new technique for adjusting and compacting. In a later phase the technique will be applied and tested on the unit for pellets installation.

Block stacking tests have been performed in the Bentonite Laboratory in full scale (see Figure 5-1). The tests show that it is necessary with a well functioning and adaptable equipment to stack the bentonite blocks in a certain flow and accuracy. The requested equipment will be unique for the project and be developed during the coming years. The tests and performed calculations also show that the requirements for backfilling are very high.

Several tests with regards to piping and erosion have been performed. At present, tests in half scale with installed blocks and pellets are executed in the Bentonite Laboratory (see Figure 5-2). The aims with these tests are to understand the behaviour of the system at different water inflows. The tests will continue until summer 2008.

Some tests with regards to the adhesion ability of the bentonite have been performed in the Bentonite Laboratory. The tests have been performed within the frame of the KBS-3H Project and started during the autumn 2007.



*Figure 5-1. Stacking of testblocks in full scale.*



*Figure 5-2. Piping and erosion test.*

## **5.4 Public Relations and Visitor Services**

### **General**

SKB operates three facilities in the Oskarshamn municipality. Äspö HRL, Central interim storage facility for spent nuclear fuel (Clab) and Canister Laboratory.

The main goal for the Public Relations and Visitor Services Group is to create public acceptance for SKB, which is done in co-operation with other departments at SKB. The goal will be achieved by presenting information about SKB, the Äspö HRL, and the SKB siting programme on surface and underground. The team is also responsible for visitor services at Clab and as from 2008 also at the Canister Laboratory. The information group has a special booking team at Äspö HRL which books and administrates all visitors. The booking team is also at OKG's service according to agreement.

In addition to the main goal, the information group takes care of and organises visits for an expanding amount of foreign guests every year. The visits from other countries mostly have the nature of technical visits, and the total number of foreign visitors 2007 was 1,990. The number of visiting politicians has doubled compared to 2006. Furthermore technical visits, both nationally and internationally, together with visits from priority target groups regionally shows an increasing trend.

During the year 2007 the three facilities in Oskarshamn and the site investigation activities in Oskarshamn were visited by 15,124 persons. The visitors represented the general public, municipalities where SKB perform site investigations, teachers, students, politicians, journalists

and visitors from foreign countries. The total number of visitors to all SKB facilities and site investigation activities in Oskarshamn and Forsmark was 25,669. During 2006 the total number was 28,217 (see Figure 5-3).

### Special events

- A series of lectures with special connection to the research and development of techniques conducted at the Äspö facility started during 2007 and is planned to continue the coming years. The intention is to combine the lectures with guided tours to the underground laboratory. The first lecture was held 2<sup>nd</sup> March by Christer Andersson when he took his doctor's degree. The title of his thesis is "Rock Mass Response to Coupled Mechanical Thermal Loading Äspö Pillar Stability Experiment, Sweden". The event was visited by almost 80 persons.
- The inauguration of the Bentonite Laboratory took place 29<sup>th</sup> March. Special guests were invited and the inauguration was also an open event for interested people. The event was visited by about 110 persons. The inauguration was conducted of the chairman of the Regional Council in Kalmar County.
- The guided summer-tours "Urberg 500" started in the end of June and ended the 19<sup>th</sup> August. 3,204 persons visited the laboratory, which were 300 more visitors than the last year. The goal for 2007 was 3,000 visitors.
- Activities organised during the national event "Geology Day" attracted about 150 visitors, divided into two separate events. The arrangements took place the 14<sup>th</sup>–15<sup>th</sup> of September. The theme for the local events was the archipelago.
- The 28<sup>th</sup> of September a contribution to "EU's Researchers' Night" was held at Äspö, with the research on microbes in focus. In the afternoon there was first a seminar for special invited guests, where the new Nova R&D platform was launched at the same time. In the evening there was an open event for the public. The both events attracted about 80 persons.
- A contribution to "Oskarshamn in Light" was held at Äspö on the 1<sup>st</sup> of December. The event consisted of a light-and-music-show down in the underground laboratory. 80 people took the chance to visit Äspö and at the same time see the show.
- The Äspö Running Competition took place on the 8<sup>th</sup> of December and attracted 76 runners, which was a new record, seen to the amount of participants. The event celebrated 10 years anniversary 2007.

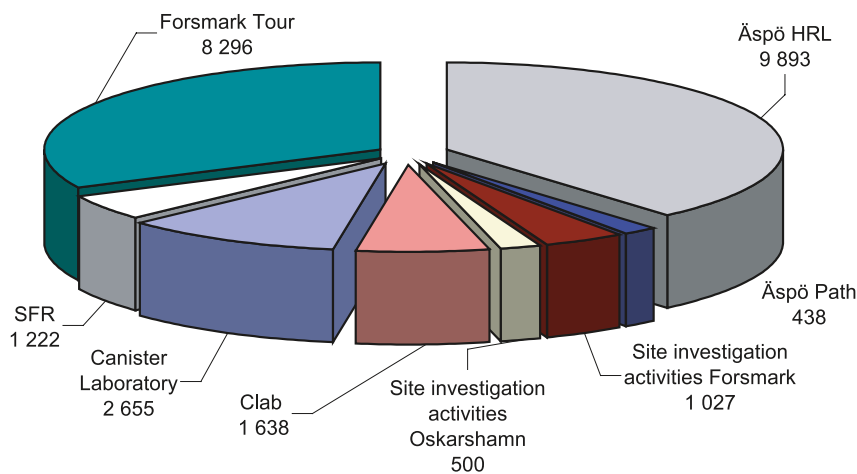


Figure 5-3. The number of visitors to the different SKB facilities during 2007.

## 6 Environmental research

### 6.1 General

Äspö Environmental Research Foundation was founded 1996 on the initiative of local and regional interested parties. The aim was to make the underground laboratory at Äspö and its resources available for national and international environmental research. SKB's economic engagement in the foundation was concluded in 2003 and the activities thereafter concentrated to the Äspö Research School.

### 6.2 Environmental and exogene geochemistry – studies within the Äspö Research School

The research carried out within the Äspö Research School focuses on environmental and exogene hydrogeochemistry. The sites of research include the Äspö HRL, Laxemar, Forsmark, other sites in the region such as Degerhamn on Öland, and selected sites abroad. Within the first few years of activities there has been an effort to analyse existing hydrogeochemical data from Äspö and the Site Investigations, as such data both contains a wealth of interesting and relevant scientific information and form a suitable background for further more detailed and specific hydrogeochemical studies. Current studies focuses on the behaviour of selected chemical elements (for example niobium and uranium) in surface and ground water, on spatial and temporal hydrochemical patterns in streams and lakes in Forsmark and Laxemar, and on the behaviour of major and trace elements during litter decomposition. In addition, experiments are currently carried out at carefully selected sites elsewhere, in order to widen the understanding of hydrogeochemical processes and trace-element mobility and transport in various natural environments. Below follows a short description of the various projects carried out by the Ph.D. students and researchers at the Äspö Research School.

#### ***Cross-utilisation of geochemical data (Pasi Peltola)***

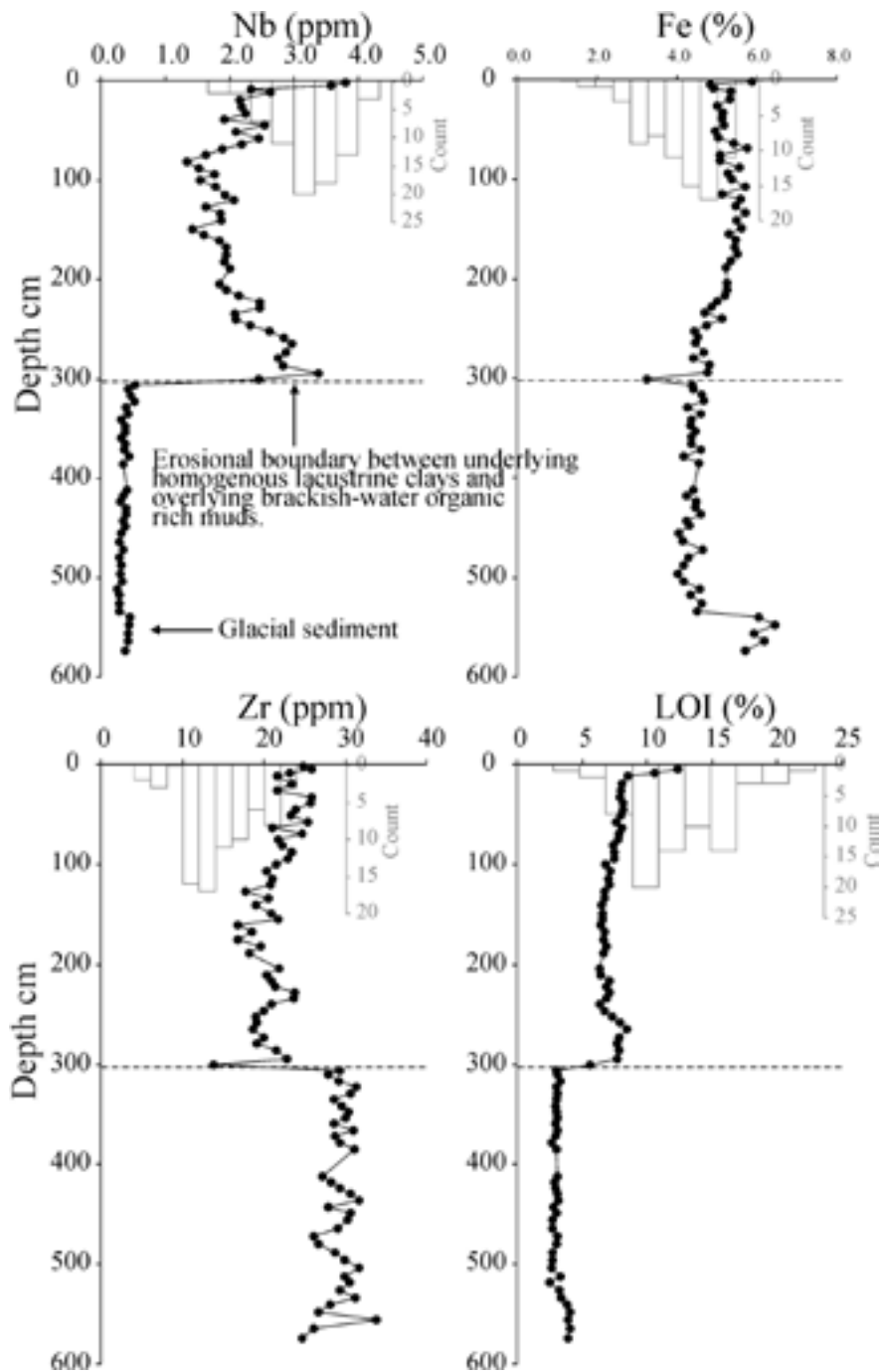
##### **Background and objectives**

Various environmental geochemical data, such as concentrations of various elements in soil, water and biota, is today produced in a multitude by many organisations and researchers. For instance environmental monitoring programmes produce much data. Many times the aim of various projects and data is focused on single or only a few research questions. This was of course appropriate earlier when data production (chemical analysis) was more time-consuming and, for example, only single elements of special interest were determined. During recent decades the use of multi-element techniques together with multi parameter approaches has become common, while at the same time quality has increased and the costs for many analyses have decreased. This is also partly the basis of the SKB's site investigations where a multitude of parameters are determined, many with an instant use in site descriptions and safety assessment, but also several parameters are "only" presented in a basic way and stored in the data base. This type of data (and stored samples) can be of greater scientific interest. One way of "dusting off" data and stored samples is to compare these data against new data when investigating the behaviour of specific elements. In the most simplified form this type of investigation could be a form of review but when using the original datasets much more extensive comparisons can be made.

The main goal is to expand the knowledge about the behaviour of chemical elements in the environment using geochemical results from various biogeochemical compartments. Elements of special interest are those having radioactive isotopes.

## Results

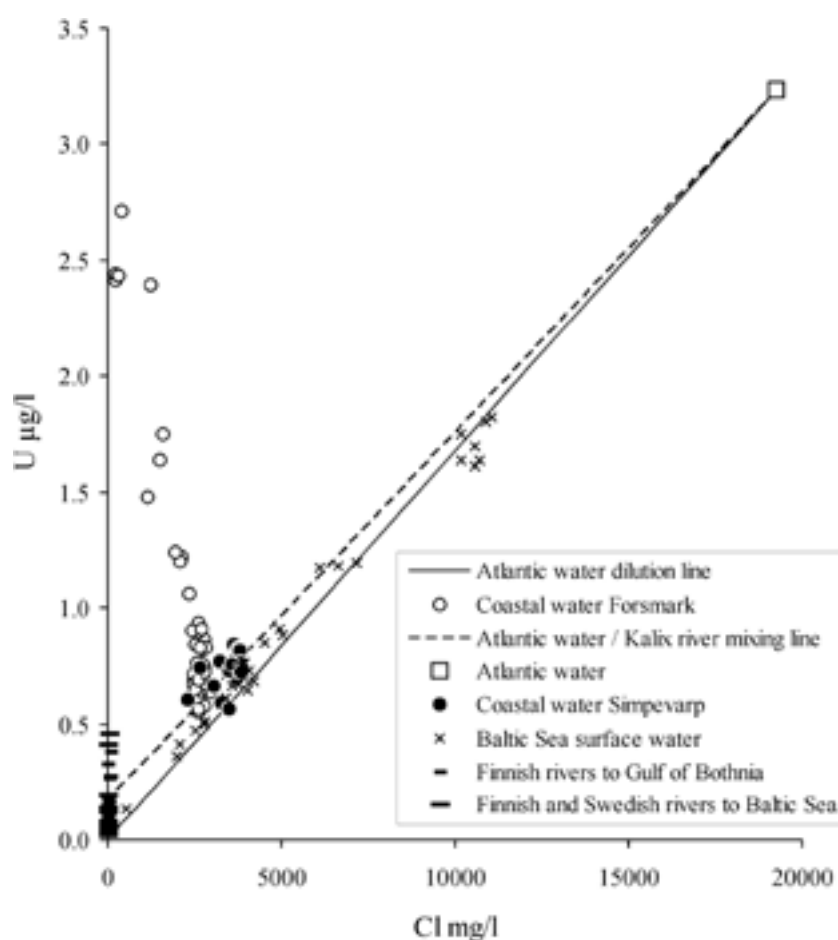
Several projects are currently in progress. Niobium has been studied in a multitude of environmental compartments such as sediments, stream water and groundwater /Åström et al. 2008a/. The most pronounced feature of Nb is found in Baltic Sea sediments where a distinct enrichment of Nb occurs when moving from lacustrine (Ancyclus) to brackish (Litorina) water sediments (Figure 6-1). While other data in the study showed that non-detrital Nb is bound to organic ligands the sedimentary results show that Nb is far more enriched than the present organic matter (LOI) in the sediment. These findings have implications for the behaviour of radioniobium in the environment.



**Figure 6-1.** Distribution of aqua regia extractable concentrations of metals (Nb, Fe, Zr) and loss on ignition (LOI) in a sediment core (filled circles) and in recent sediments at 75 sites (frequency distribution) in the Archipelago Sea.

Another study focuses on the aqueous behaviour of uranium in the boreal zone, with special attention to waters at Simpevarp and Forsmark /Åström et al. 2008b/. In this study both well water, regional geochemical stream-water and groundwater data is used. In Figure 6-2 uranium and chloride concentrations in and around the Baltic Sea are compiled for Atlantic water /Chen et al. 1986/, Atlantic water/Kalix river mixing line /Andersson et al. 1995/, Baltic Sea surface water (samples at a depth of 0–5 m from various sampling stations) /Löfvendahl 1987/, Finnish rivers to Gulf of Bothnia (median of time series of 21 rivers including the Munsala stream) /Roos and Åström 2005/ and 13 Finnish and Swedish rivers to Baltic Sea /Edén and Björklund 1994/. Chloride concentrations, when not available, were calculated from salinity and/or the concentration of sodium. For more details on the references, contact Pasi Peltola ([pasi.peltola@hik.se](mailto:pasi.peltola@hik.se)). From these data it is evident that coastal waters at Forsmark receive a natural input from stream-water and possibly also from groundwater.

Future studies with the same approach will include data from a peat core and data from plant-litter decay experiments, etc. Elements of interest are especially micronutrients and elements mimicking these, such as rubidium, caesium and thallium. A study tracing the sources and reasons for high K/Rb ratios in streams has been completed /Peltola et al. 2008/.



**Figure 6-2.** Uranium versus chloride concentrations for terrestrial and Baltic Sea surface waters. Note that uranium concentration in /Chen et al. 1986, Andersson et al. 1995/ and /Löfvendahl 1987/ is given in µg/kg.

***Hydrochemical characteristics of surface- and groundwater in two boreal granitoidic settings, Forsmark and Simpevarp/Laxemar (Pernilla Rönneck, dissertation November 2007)***

**Background and objectives**

The Baltic Sea and its terrestrial surroundings consist of a unique environment due to the brackish water and still active land uplift (up to 8–9 mm/year). These two features plus the northern location result in a combination of characters of small near-coastal catchments including melt-water discharge in spring, huge increase in biological activity during the short but bright summer months, strongly developed seasonality, sporadic intrusions of brackish waters, and young relatively unweathered soils. This region thus consists of an area of significant scientific interest in terms of providing knowledge of causal relationships among contrasting parameters affecting surface- and groundwater chemistry.

The overall aim of the project was to increase the understanding of the chemical dynamics that control water chemistry in small natural catchments in this region, with focus on spatial and temporal trends. The work was done within the Swedish nuclear waste programme and both Forsmark, which has a carbonate-rich till, and Laxemar (Figure 6-3), with a carbonate-poor till, are studied. The project also assessed the catchment properties and hydrochemical features in relation to the potential threats of spent nuclear fuel waste. The work resulted in a Ph.D. thesis which was defended (and accepted) in November 2007.

**Experimental concept**

Surface water (lake and stream water) and groundwater (overburden and bedrock water) were collected and analysed for major elements, nutrients and trace elements, uranium and rare earth elements (REE's). The data are owned by SKB and stored in the site investigation database Sicada. For surface water, the samples were collected continuously during nearly four years while the groundwater samples are collected sporadically during the same period. Continuous flow measurement was carried out in some of the catchments over the last two years.



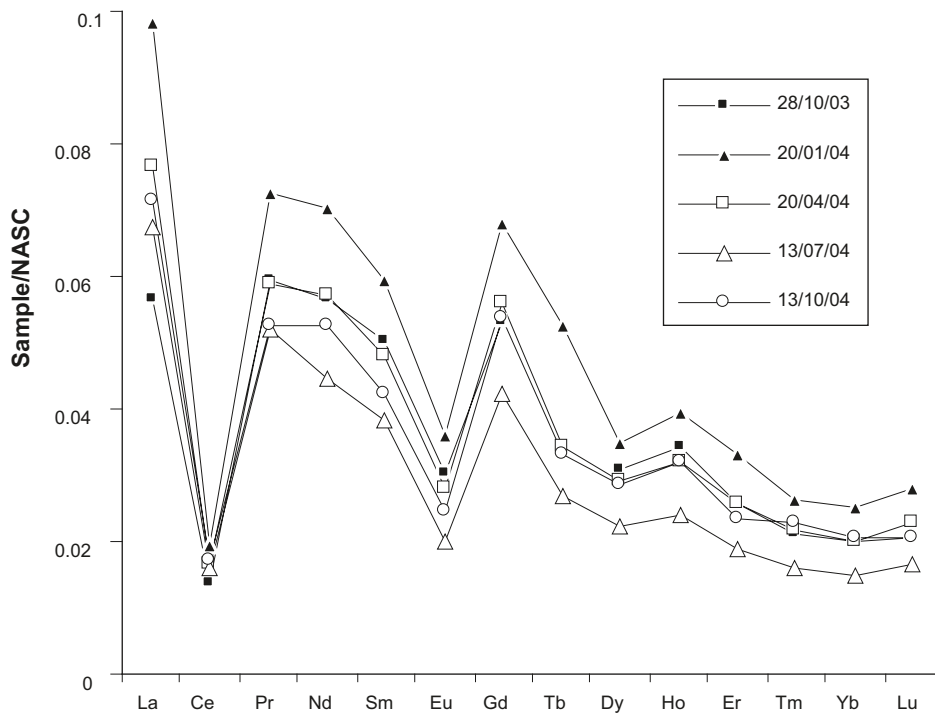
**Figure 6-3.** Sampling point PSM002087 at Laxemar catchments area.



## Results

Repetitive seasonal cycles in surface water chemistry have been observed each year along with seasonal cycles in stream discharge. The major findings in surface water chemistry were: (1) the concentrations of elements derived from rock weathering increased in stream water during low flow, (2) sporadic intrusions of brackish water from the Baltic Sea, particularly seen in Forsmark, resulted in strong increase in salinity ( $\text{Na}^+$ ,  $\text{Cl}^-$ ,  $\text{Br}^-$ ,  $\text{SO}_4^{2-}$ ), (3) a huge increase in biological activity during summer months resulted in decreased concentrations of  $\text{NH}_4^+$ ,  $\text{NO}_3^-$  and Si and increased pH and concentrations of chlorophyll a,  $\text{O}_2$ , DON, POC, PON and POP and (4) the uranium concentrations were high at both areas in comparison with surface waters in the Barents region, and a possible source is reduced uranium minerals in the overburden due to the young and unweathered soil.

The concentrations and fraction patterns of REE's were examined in both surface- and groundwater. Large variations existed in REE abundance, REE-fractionation patterns and in the behaviour of Ce and Eu among different water types, but also between similar water types in the two areas. The highest concentrations were found in overburden groundwater, which were characterised by enrichment of light Rare Earth Elements and negative Ce and Eu anomalies (Figure 6-4). The Visual MINTEQ speciation calculations predicted that all REE's in all waters were closely associated with dissolved organic matter. There were however strong indication (in overburden groundwaters in particular) of association with inorganic colloids, which were not included in the speciation model. The REE's are of particular interest because of the systematic change in behaviour across the lanthanide series and as they consist analogues for several radionuclides.



**Figure 6-4.** A characteristic NASC (North American Shale Composite) -normalised REE fractionation pattern in overburden groundwater (sample SFM0029 from Forsmark). The symbols correspond to day/month/year.

## ***Patterns in major and trace element contents in boreal forest ecosystems, with particular focus on the litter layer (Christian Brun)***

### **Background and objectives**

The main concept is to examine the content of a large number of major and trace elements in different parts of the boreal forest ecosystem. The sample material is partly from long term studies in the 1980's and partly from SKB's site investigations at Forsmark and Simpevarp.

The process of litter decomposition is an important part of many biogeochemical element cycles. Nutrients are being recycled, while other elements are rather firmly bound to the recalcitrant litter fractions and others yet are being leached downward into the soil profile. The knowledge of different elements' behaviour during decomposition of litter is limited to a rather small number of elements that are either essential to plants (i.e. nutrients) or potentially toxic (i.e. "heavy metals").

The objectives of this study is to determine differences in the behaviour of a large number of major and trace elements, for which very little is known. Long term multielement studies of the litter decomposition process are quite rare, and studies of an entire ecosystem are even more so.

### **Experimental concepts**

The main part of this project consists of studies of the multielement dynamics during litter decomposition, while additional samples from different vegetation and soil compartments are used in the studies from SKB's site investigations. The litter decay process was examined using the litterbag method, where fresh local litter was contained in nylon net bags and incubated for up to eight years in the humus layer. The samples were then analysed for a large number of major and trace elements using ICP-MS and ICP-AES at accredited laboratories. Statistical analysis was carried out using both multivariate (Principal Component Analysis) and univariate statistical methods.

### **Results**

Through examination of PCA and scatter plots, three principal patterns were found in the data, although there was a slight variation in these groups depending on the species studied. One group, mostly containing nutrients, showed a trend where the amounts decreased during decomposition. These elements are thus loosely bound to the litter and/or easily released, so that there is a net leaching from the litterbags (Ca shown in Figure 6-5). A second, rather large group of elements, mostly consisting of unessential elements and metals, showed a trend with increasing amounts during decomposition (Pb shown in Figure 6-5). This means that there was a net addition of the elements into the litterbags over the study period. All these elements were also, according to the PCA-scores plot, more or less negatively correlated to the latitude of the locations. Some elements, e.g. Cd, Hf, Hg and Zr increased during the first years after which there was a decrease to an amount that was similar to the initial value. These elements thus accumulate in the litter initially, but are later leached, possibly into lower horizons and potentially more sensitive ecosystems. A third group, not distinctly different from the group dominated by nutrients contains e.g. Cr, Zn and Au, that seem to be somewhere between a slow decrease and a steady state throughout the decomposition process. Zinc and chrome are not tightly bound to organic material and are thus more susceptible to leaching than most other heavy cations.

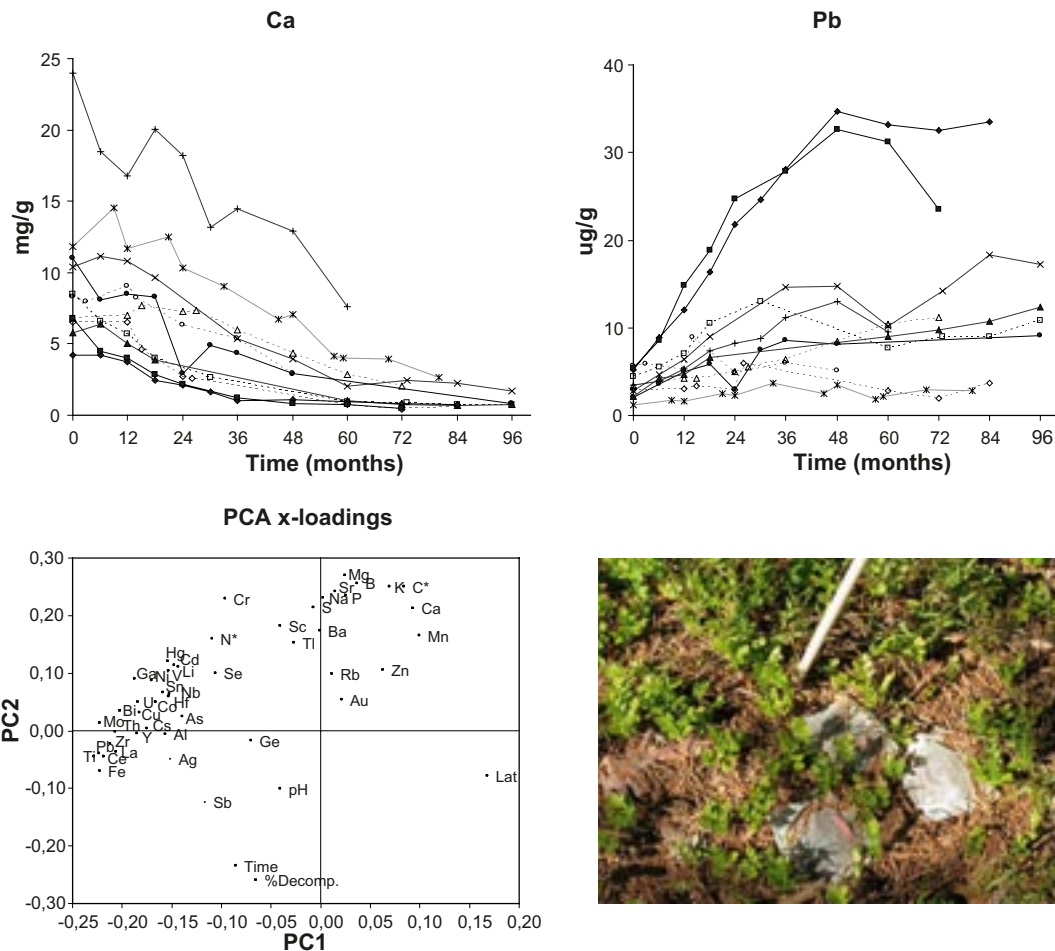


Figure 6-5. Total amounts of (a) Ca and (b) Pb with time and (c) PCA loadings from (d) the Norway spruce/Scots pine litter decomposition study.

### Behaviour of sulphur and metals in an alum shale environment (Ulf Lavergren)

#### Background and objectives

Alum shale, internationally usually called black shale, is a sedimentary rock with Swedish as well as worldwide occurrences. It was formed from sediments deposited in stagnant aquatic environments with high organic productivity and oxygen deficiency at the bottom, creating sediments rich in organic matter and sulphides. Alum shale is also known to contain high concentrations of many potentially toxic trace elements such as arsenic, cadmium and uranium. The shale is readily weathered when exposed to air and water and can produce acidic drainage water rich in various metals, thus constituting a potential contamination source for soils and waters. Such effects have also been observed in some international studies.

In Sweden alum shale has historically been mined for production of alum and quicklime, leaving behind exposed surfaces of the bedrock together with deposits of burnt shale. In 1999 high cadmium concentrations were found in sewage sludge in a local wastewater treatment plant in Degerhamn, Öland, an area where alum shale previously have been mined and burnt on site. It was soon realised that the former mining area was the source of the metal pollution, motivating further studies to assess the extent of metal leakage in the area.

The overall aim of this project is to characterise the mobilisation of trace elements, e.g. arsenic, cobalt, chromium, copper, molybdenum, nickel, uranium, vanadium and zinc, when exposed

alum shale undergoes chemical weathering. The knowledge obtained from this study can be used in risk assessments for areas where this type of material is abundant, in Sweden and globally.

### **Experimental concepts**

The Degerhamn area functions as study area and two main approaches are used in the study, in which both the natural bedrock shale (Figure 6-6) and the burnt shale originating from the historical industrial activities are being investigated. First, the abundances and mobility of trace elements in the material are analysed through a series of different leaching test (batch test, availability test, oxidised availability test and humidity cell test) together with sequential chemical extractions. These tests provide not only information on the metal mobility in the material but also on which type of extractions that preferably should be used in environmental studies regarding this type of material. Second, the geochemistry in the area is monitored in situ. This includes monthly sampling of groundwater, for a period of eight months, in 16 groundwater tubes installed in the area. Surface water samples are also taken in five small watercourses, when available. This provides information of the actual magnitude of metal dispersion under field conditions.

### **Results**

The laboratory tests shows that the alum shale is very rich in arsenic, cadmium, molybdenum, uranium and vanadium, and that cadmium and molybdenum in the natural shale bedrock potentially has a very high mobility. Uranium and vanadium are in both types of material found mainly in weathering resistant mineral phases and shows a comparatively low mobility, while arsenic upon oxidation is transferred to stable solid phases and thus not mobilised. The material is also relatively rich in copper, nickel and zinc, of which the latter two are easily mobilised while copper is less mobile. The tests thus shows that this type of material has a high potential for releasing several metals to the environment during weathering, and further that an oxidised availability test (utilising pH-controlled leaching media and hydrogen peroxide) is a suitable procedure for assessing this potential release.

The in situ study shows that the area displays large spatial variations in groundwater chemistry between nearby sampling points. At some locations the groundwater is highly acidic from oxidising sulphides, while at others it is circumneutral. In general, however, the groundwater is clearly affected by the shale material, as shown by elevated metal concentrations. The acidic groundwater is found in an area covered by extensive deposits of burnt shale where the conditions for sulphide oxidation are especially favourable, and the water there is strongly elevated



*Figure 6-6. Alum shale outcrop in Degerhamn, Öland, Sweden.*

in several metals including cadmium, cobalt, copper, nickel, uranium and zinc. Uranium and cadmium are, however, also abundant in the circumneutral groundwater only affected by the natural bedrock, together with molybdenum. Altogether, this shows that the mobilisation of metals clearly is enhanced by the historical mining activities, but also that weathering of the natural alum shale bedrock in itself can be a considerable source for metal contamination of the groundwater.

### ***Behaviour of major and trace elements in water, soils and sediments in the SubAndean Amazonia (Lina Lindell)***

#### **Background and objectives**

In the great Amazon basin there are still continuous and vast areas of primary forest that holds a unique biodiversity and an ecological and biogeochemical complexity largely unknown to man. The pressure from anthropogenic activities, however, results in an ever increasing extent of deforested areas. One of the regions experiencing the most severe deforestation is the Andean Amazon. The main reason for deforestation in this region is small scale sustenance agriculture which continuously increases due to population growth caused by migration from other regions. The Andean Amazon is, for several reasons, a very important part of the Amazon basin. According to Conservation International, the Tropical Andes is the richest and most diverse region on Earth. Further, the Andean Amazon is the main source of river-transported chemical and physical components in the downstream Amazon plain. Deforestation in the Andean Amazon has thus the potential to strongly affect the hydrochemical and hydrophysical characteristics of the Amazon River, its adjacent floodplain, and estuary.

The objective of this study is to enhance the current understanding on how deforestation and the subsequent land-use change effects the natural environment (water and soil) and the people living in the SubAndean Amazon. The environmental data (including results on behaviour of potentially toxic metals, soil-nutrient losses and water-quality degradation) together with the sociological data (perceptions on resource degradation) will be an important asset for the planning of environmental sustainability and socioeconomic growth in this and similar regions.

#### **Experimental concepts**

Two catchments located in the SubAndean Amazon were selected as study areas. During the first round of field work water samples were collected at 50 tributaries to the main rivers in these two basins. The chemical compounds and elements were evaluated in respect to each other and to discharge, sub-basin characteristics, lithology and land cover. The latter was produced by analysing optical remote sensing data.

Historical water chemistry and geochemistry data are virtually non-existing in this region, thus, to study historical changes in geochemistry five vertical profiles of floodplain sediments were collected and analysed. The geochemistry of this sediment type has often been used for tracking natural and anthropogenic processes in catchments.

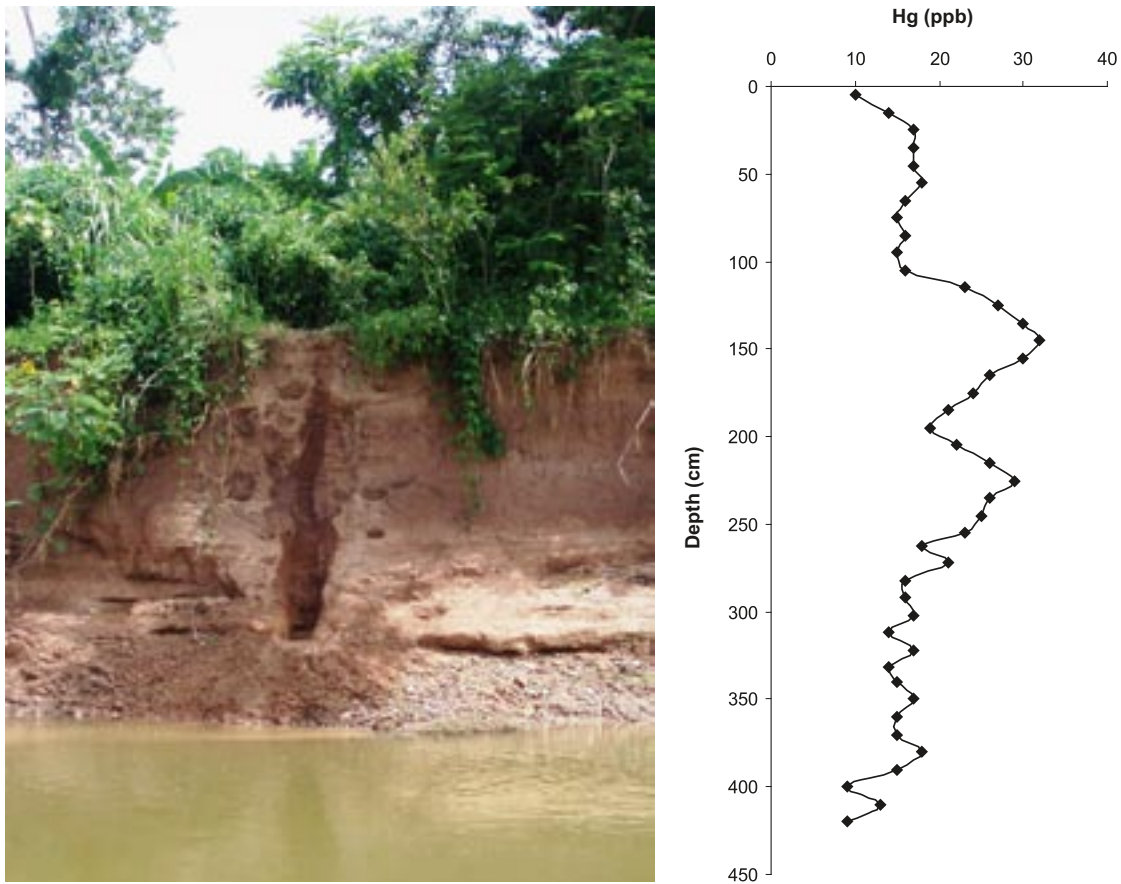
In the current land practices (slash and burn agriculture) the soils capacity to carry crops rapidly decreases after deforestation. As a result 80% of the deforested area in this region is composed of abandoned land. A more effective way to cultivate the soils could assist in reducing the extent of deforestation. To investigate changes in soil quality, samples were collected from pristine forest and varying kinds of land use. The material is currently being analysed.

An interview study focusing on attitudes and perceptions towards natural resources and environmental change was carried out. Differences between replies from locals, colonists from the high Andes, non-governmental organisations and mayors will be analysed. The interviews were semi-structured and performed in situ.

## Results

The water chemistry is dominated by dissolution of carbonate rock with massive evaporitic deposits. Variations in lithology and topography dominate the water chemistry.

However, effects from deforestation cannot be ruled out (especially for K, dissolved oxygen and water temperature) as they may be masked by the strong signal from lithology. We detected significant deviations from background concentrations in the floodplain sediments, especially for the following metal cations: Hg, Pb, Cd, Mn, Co, Ni, As, Cu. Figure 6-7 shows an example of the mercury concentration in a sediment profile. The origin of the peaks may be deforestation followed by increased surface erosion, causing a deposition of sediments enriched in organic material complexing atmospherically deposited elements. However, in situ processes may also, partly or entirely, have caused the accumulation of metals.



*Figure 6-7. Sediment profile from Sisa Basin and its mercury concentration with depth.*

## 7 International co-operation

### 7.1 General

Nine organisations from eight countries have in addition to SKB participated in the co-operation at Äspö HRL during 2007. Six of them; Andra, BMWi, CRIEPI, JAEA, NWMO and Posiva together with SKB form the Äspö International Joint Committee (IJC), which is responsible for the co-ordination of the experimental work arising from the international participation. The committee meets once every year. In conjunction with each IJC meeting a Technical Evaluation Forum (TEF) is held. TEF consists of scientific experts appointed by each participating organisation. For each experiment the Äspö HRL management establishes a peer review panel consisting of three to four Swedish or international experts in fields relevant to the experiment. Presentations of the organisations represented in the IJC are given below.

Most of the organisations participating in the Äspö HRL co-operation are interested in groundwater flow, radionuclide transport, rock characterisation and THMC modelling. Several of the organisations are participating in the two Äspö Task Forces on (a) Modelling of Groundwater Flow and Transport of Solutes and (b) THMC modelling of Engineered Barrier Systems. These specific technical groups, so called Task Forces, are another form of organising the international work. The Task Force on Modelling of Groundwater Flow and Transport of Solutes, which is a forum for co-operation in the area of conceptual and numerical modelling of groundwater flow and solute transport in fractured rock, has been working since 1992. The Task Force on Engineered Barrier Systems, a forum for code development on THMC processes taking place in a bentonite buffer and gas migration through a buffer will be increasingly active and a prioritised area of work in the coming years.

SKB also takes part in several international EC-projects and participates in work within the IAEA framework.

The international organisations are taking part in the projects, experiments and Task Forces described in Chapters 2, 3 and 4 (Geoscience, Natural barriers and Engineered barriers). The co-operation is based on separate agreements between SKB and the organisations in question. The participation by JAEA and CRIEPI is regulated by one agreement. The participation of each organisation is given in Table 7-1.

### 7.2 Andra

The Agence nationale pour la gestion des déchets radioactifs (Andra) is involved in various Äspö projects devoted to the understanding of the THMC behaviour of engineered barrier systems. The work carried out in 2007 with the support of the French agency has been fully integrated in the projects and is described in detail in the respective project sections.

However, in support of the Alternative Buffer Materials project, a new mock-up test has been implemented in the French Commissariat à l'Énergie Atomique CEA laboratories and is further presented below.

#### 7.2.1 Alternative Buffer Materials

In France, Andra is developing an underground research laboratory in a layer of Callovo-Oxfordian argillite (Cox). Samples of this material have been installed in the Alternative Buffer Materials boreholes in Äspö HRL. Cox argillite is used in two forms; rock blocks and remoulded material. Thus the Cox behaviour will be compared with other swelling clays.

**Table 7-1. International participation in the Äspö HRL projects during 2007.**

Projects in the Äspö HRL during 2007	Andra	BMWi	CRIEPI	JAEA	NWMO	Posiva	Enresa	Nagra	RAWRA
<b>Natural barriers</b>									
Tracer Retention Understanding Experiments	X			X		X			
Long Term Sorption Diffusion Experiment									
Colloid Project					X				
Microbe Project		X							
Radionuclide Retention Project									
Task Force on Modelling of Groundwater Flow and Transport of Solutes	X		X	X	X	X			
<b>Engineered barriers</b>									
Prototype Repository	X	X		X		X			
Long Term Test of Buffer Materials									X
Alternative Buffer Materials	X	X		X		X		X	X
Temperature Buffer Test	X	X					X		
KBS-3 Method with Horizontal Emplacement							X		
Large Scale Gas Injection Test	X	X			X	X			
Cleaning and Sealing of Investigation Boreholes							X		
Task Force on Engineered Barrier Systems	X	X	X		X	X		X	X
<b>Participating organisations:</b>									
Agence nationale pour la gestion des déchets radioactifs, Andra, France									
Bundesministerium für Wirtschaft und Technologie, BMWi, Germany									
Central Research Institute of the Electronic Power Industry, CRIEPI, Japan									
Japan Atomic Energy Agency, JAEA, Japan									
Nuclear Waste Management Organisation, NWMO, Canada									
Posiva Oy, Finland									
Empresa Nacional de Residuos Radiactivos, Enresa, Spain									
Nationale Genossenschaft für die Lagerung Radioaktiver Abfälle, Nagra, Switzerland									
Radioactive Waste Repository Authority, RAWRA, Czech Republic									

To complement the THMC characterisation of the Cox argillite during water saturation under high temperature, a mock-up test is operated and will last a couple of years. It makes use of the CEA mock-up cell previously used for TBT with a clay specimen made of remoulded Cox (see Figure 7-1).

Clay specimen thickness in the mock-up is 20 cm compared to 10 cm in the ring shaped blocks used in Äspö HRL. Therefore a wider range of temperature can be applied to the clay specimen, while keeping the same thermal gradient in both tests (Figure 7-2).



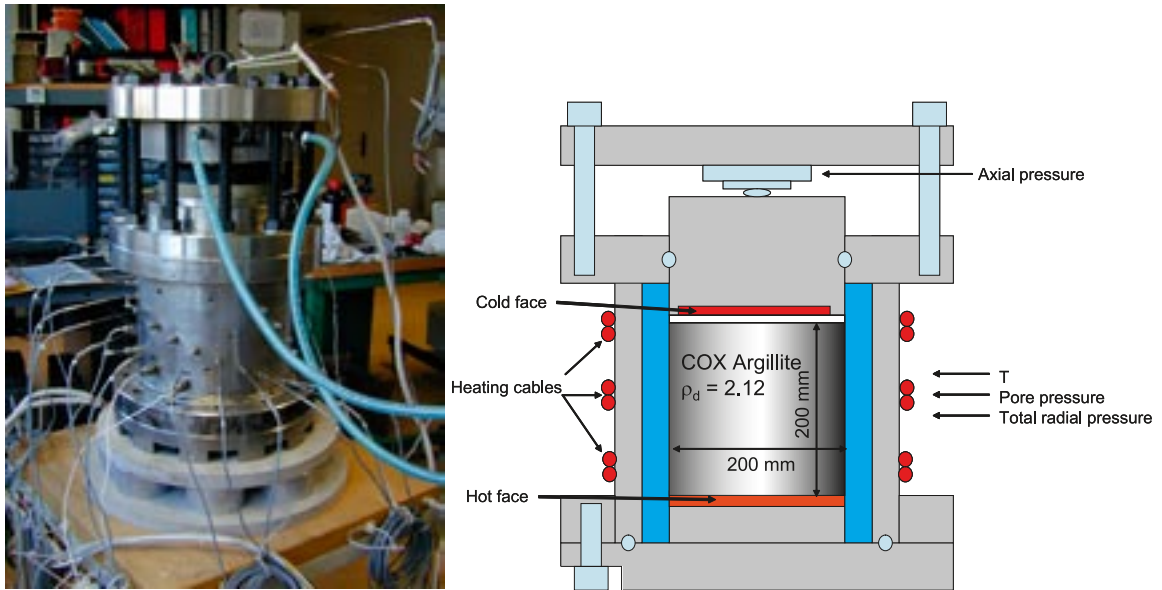


Figure 7-1. Picture and cross-cut of the mock-up cell.

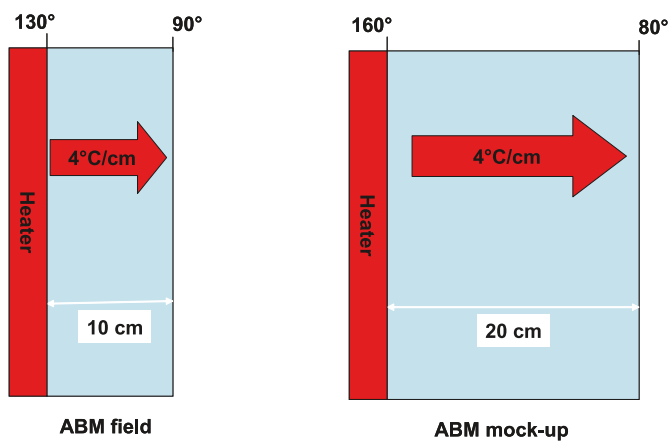


Figure 7-2. Temperature field and thermal gradient in the CEA mock-up cell (right) and in the Alternative Buffer Material project in Äspö HRL (left).

### 7.3 BMWi

In 1995 SKB and the then BMBF (Bundesministerium für Bildung, Wissenschaft, Forschung und Technologie) signed the co-operation agreement being the frame for participating in the activities in the Äspö HRL. In 2003 the agreement was extended for a period of six years. On behalf of and/or funded by the BMWi (Bundesministerium für Wirtschaft und Technologie) five research institutions are currently participating in experiments and activities connected to Äspö HRL: Bauhaus Universität Weimar, Federal Institute for Geosciences and Natural Resources (BGR), DBE Technology, Forschungszentrum Dresden-Rossendorf (FZD), and Gesellschaft für Anlagen- und Reaktorsicherheit (GRS) mbH.

The general purpose of the co-operation is to complete the state of knowledge concerning potential host rocks for high-level waste repositories in Germany and to extend the knowledge of the behaviour of the EBS (engineered barrier systems). Topics of special interest are:

- Studying the buffer material behaviour and the related basic processes by experiments and modelling.

- Investigations of the migration behaviour of radionuclides, especially actinides, under near field and far field conditions.
- Geochemical modelling of individual processes controlling migration.
- Investigation of the microbial activity with regard to the interaction with radionuclides.
- Thermodynamic databases for radionuclides relevant for long term safety.

The work carried out in 2007 is described below.

### 7.3.1 Microbe Project

#### **Introduction**

The contributions of the Forschungszentrum Dresden-Rossendorf (FZD)/Institute of Radiochemistry (IRC) within the microbe project – as part of the international co-operation in the Äspö HRL – are concentrated in a project addressing the mobilisation of actinides by released bioligands in the aquifer system from relevant Äspö bacteria. The ongoing study is focused on: (i) isolation and characterisation of microbial ligands produced from a subsurface strain of *Pseudomonas fluorescens* isolated at Äspö, (ii) interaction of U(VI), Np(V), and Cm(III) with the microbial ligands including compounds simulating the functionality of the microbial ligands and the surface of the bacteria and (iii) spectroscopic characterisation of the formed actinide complexes/compounds. The formation constants determined will be used directly in speciation and transport models. This project should help to identify the dominating process of the interaction between actinides and microbes (direct or indirect ones). The research performed in our project improves the understanding of the behaviour of colloids and microbes and their respective interaction with radionuclides.

The activities in 2007 were concentrated on (a) complexation studies of U(VI) with the secreted bioligand mixture of *P. fluorescens* found at Äspö HRL, (b) complexation studies of Cm(III) with relevant pyoverdins model compounds and (c) complexation studies of U(VI) and Cm(III) with model molecules simulating the functionality of bacterial cell envelopes to explain the interactions of actinides in biologically systems on a molecular level. Selected results of the topics (a) and (b) will be reported here.

#### **(a) – Uranium(VI) complexation with pyoverdins secreted by a subsurface strain of *Pseudomonas fluorescens***

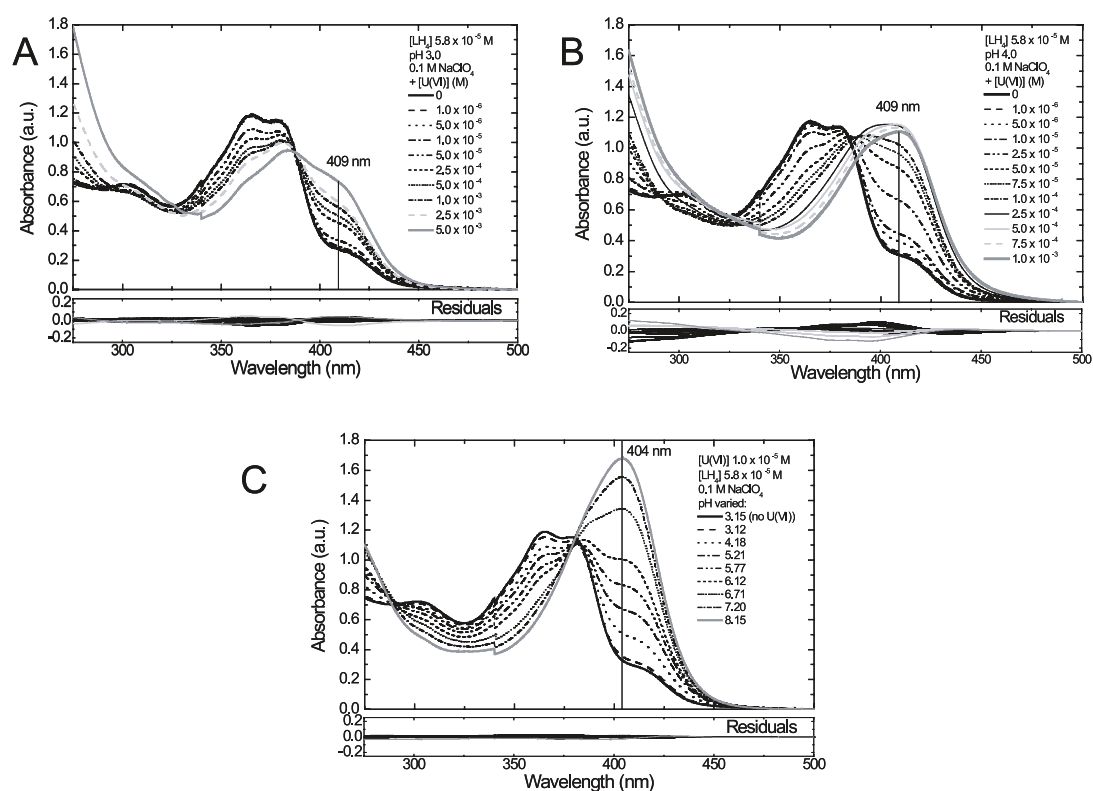
Fluorescent *Pseudomonas* species secrete pyoverdins-type siderophores with a high potential to dissolve, bind, and thus transport uranium in the environment. The formation of complexes of  $\text{UO}_2^{2+}$  with pyoverdins released by the groundwater bacterium *Pseudomonas fluorescens* (CCUG 32456) isolated at a depth of 70 m in the Äspö HRL was studied. Mass spectrometry indicated that the cells produce a pyoverdinmixture with four main components: two pyoverdins and two ferriactins. A drastic change in the intrinsic fluorescence properties, e.g. static fluorescence quenching, occurred due to the complex formation with  $\text{UO}_2^{2+}$ . Species containing  $\text{UO}_2^{2+}$  of the type  $\text{M}_p\text{L}_q\text{H}_r$  were identified from the dependencies observed in the ultraviolet visible and time-resolved laser-induced fluorescence spectroscopy spectra at pyoverdin concentrations below 0.1 mM. The following average formation constants were determined:  $\log \beta_{112} = 30.00 \pm 0.64$  and  $\log \beta_{111} = 26.00 \pm 0.85$  at ionic strength  $I = 0.1 \text{ M}$  ( $\text{NaClO}_4$ ).

*P. fluorescens* (CCUG 32456 A) pyoverdins were isolated and characterised according to /Moll et al. 2008/. Three different series of experiments were performed to explore the complexation behaviour of uranium(VI) with the isolated pyoverdin mixture. In two series, in which the pH was set to 3 and 4, respectively, we investigated  $\text{UO}_2^{2+}$  complex formation by varying the uranyl concentration between  $1 \times 10^{-6}$  and  $1 \times 10^{-3} \text{ M}$  at a fixed pyoverdin concentration  $[\text{LH}_4]$  of  $5.8 \times 10^{-5} \text{ M}$ . In the third series, the uranyl and the pyoverdin concentrations were kept constant at  $1 \times 10^{-5}$  and  $5.8 \times 10^{-5} \text{ M}$ , respectively, while varying the pH between 3.0 and 8.2. The absorption spectroscopy experiments were performed using a CARY5G UV-vis-NIR spectrometer

(Varian Co.) at  $22 \pm 1^\circ\text{C}$ . Three series of experiments were performed using fs-TRLFS. In two series, one without  $\text{UO}_2^{2+}$  and one with  $1 \times 10^{-6}$  M  $\text{UO}_2^{2+}$ , at a total pyoverdinin concentration of  $8.1 \times 10^{-6}$  M, the spectral changes were investigated as a function of pH between 2.1 and 8.9. In series 2, at a fixed pyoverdinin concentration of  $5.7 \times 10^{-5}$  and a pH of 4.0, the uranyl concentration was changed between  $1 \times 10^{-6}$  and  $1 \times 10^{-4}$  M. All experiments were made at an ionic strength of 0.1 M ( $\text{NaClO}_4$ ). The spectra were evaluated using the factor analysis program SPECFIT. Experimental details of the fs-TRLFS setup are given in /Geipel et al. 2004/.

Figure 7-3 depicts the absorption spectra of the *P. fluorescens* (CCUG 32456) pyoverdins in the  $\text{UO}_2^{2+}$  system as they depend on the varied physico-chemical parameter.

Processes of interaction between  $\text{UO}_2^{2+}$  and the pyoverdins ( $\text{LH}_4$ ) can be identified directly in Figure 7-3A and B. The absorption maxima at 365 and 379 nm decrease with increasing  $\text{UO}_2^{2+}$  concentration at pH 3 and 4. The formation of pyoverdinin- $\text{UO}_2^{2+}$  species is indicated by the increased absorption band at 409 nm as shown in Figure 7-3A and B. The formation of complexes of  $\text{UO}_2^{2+}$  with *P. fluorescens* (CCUG 32456) pyoverdins was dependent on  $\text{UO}_2^{2+}$  concentration and pH at a constant pyoverdinin concentration of  $5.8 \times 10^{-5}$  M. At pH 3, significant changes in the UV-vis spectra were detectable at  $\text{UO}_2^{2+}$  concentrations greater than  $5.0 \times 10^{-5}$  M, whereas at pH 4 effects were already visible one order of magnitude earlier. Figure 7-3C shows the pH dependence of the  $\text{UO}_2^{2+}$  pyoverdinin complex formation equilibria at fixed concentrations of  $\text{UO}_2^{2+}$  and  $\text{LH}_4$  ( $1.0 \times 10^{-5}$  and  $5.8 \times 10^{-5}$  M, respectively). In light of relevant complexation studies of pyoverdinin-type bioligands with metals /Albrecht-Gary et al. 1994, Bouby et al. 1999/,



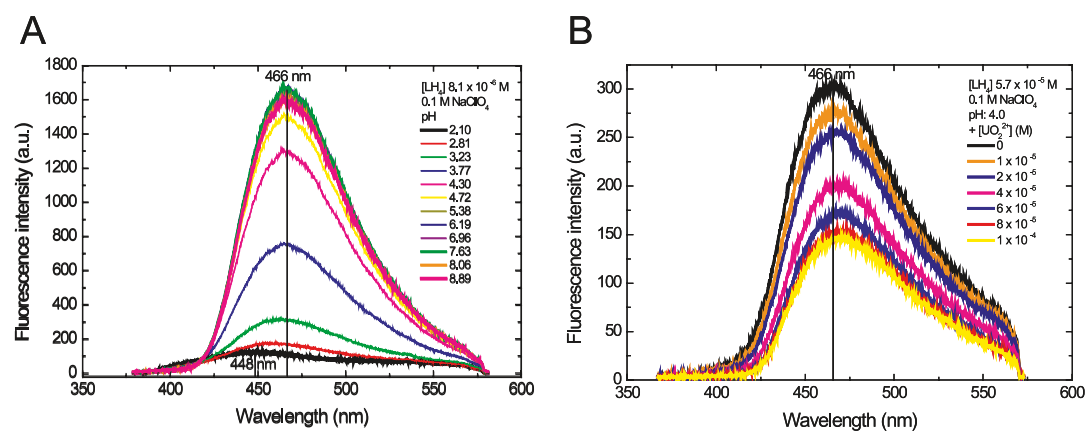
**Figure 7-3.** Absorption spectra of the *P. fluorescens* (CCUG 32456) pyoverdins measured in the  $\text{UO}_2^{2+}$  system at an ionic strength of 0.1 M ( $\text{NaClO}_4$ ): A) and B) at  $[\text{LH}_4]$   $5.8 \times 10^{-5}$  M and at pH 3 and 4, respectively, as a function of uranyl concentration; and C) at  $[\text{UO}_2^{2+}]$   $1.0 \times 10^{-5}$  M and  $[\text{LH}_4]$   $5.8 \times 10^{-5}$  M as a function of pH. The residual absorption spectra after SPECFIT analysis are included.

and taking into consideration the deprotonation of the pyoverdinin molecule, possible  $\text{UO}_2^{2+}$ -pyoverdinin species of the  $\text{M}_p\text{H}_q\text{L}_r$  type were introduced into the data analysis procedure using SPECFIT. As a result, we were able to develop a chemical model describing the observed processes in the  $\text{UO}_2^{2+}$ -*P. fluorescens* (CCUG 32456) pyoverdinin system. The dependencies found in the UV-vis data could be expressed by the following equilibria:



Formation constants for reactions (1) and (2) were calculated to be  $\log \beta_{112} = 30.50 \pm 0.40$  and  $\log \beta_{111} = 26.60 \pm 0.40$ , respectively. The absorption spectra calculated in the SPECFIT evaluation procedure agree fairly well with the measured ones, as indicated by the residuals in Figure 7-3.

The fluorescence maxima and fluorescence intensity of the *P. fluorescens* (CCUG 32456) pyoverdins are pH dependent: at pH 2.1 the fluorescence maximum lies at 448 nm whereas between pH 3.8 and 8.9 the fluorescence maximum is at 466 nm independent of pH (Figure 7-4A). A strong increase in fluorescence intensity was observed between pH 2.1 and 4.7, while at pH values above 4.7 the fluorescence intensity remained nearly unchanged. As a result of the SPECFIT evaluation, one pK value of 3.83 could be determined, which corresponds fairly well to the  $\text{pK}_1$  value obtained from the UV-vis measurements /Moll et al. 2008/. Time-resolved measurements indicated that the fluorescence decay of the *P. fluorescens* (CCUG 32456) pyoverdins in aqueous solution was dependent on the pH. At  $\text{pH} < 3.0$ , biexponential decay behavior involving a fast decay component with a decay time of  $2,135 \pm 600$  ps and a second fluorescence component with a longer decay time of  $5,865 \pm 638$  ps were detected. The fast fluorescence decay component decreased to  $580 \pm 195$  ps between pH 3 and 4, whereas the lifetime of the second fluorescence component remained unchanged. At  $\text{pH} > 4.0$ , monoexponential fluorescence behaviour with a decay time of  $5,865 \pm 638$  ps is dominant. In all samples containing  $\text{UO}_2^{2+}$  a strong quenching of the fluorescence intensity was observed (Figure 7-4B). It follows that the  $\text{UO}_2^{2+}$ -*P. fluorescens* (CCUG 32456) pyoverdinin species emit no fluorescence light. The fluorescence lifetimes were not influenced within the investigated  $[\text{UO}_2^{2+}]$  concentration range. This indicates that a static fluorescence quench process occurs due to the complex formation reactions. In addition, we detected a slight red shift of the fluorescence emission maximum from 466 to 470 nm at  $[\text{UO}_2^{2+}] > 2 \times 10^{-5}$  M at pH 4 (Figure 7-4B). As a result of the SPECFIT analysis of the fs-TRLFS spectra, we could confirm the conclusions drawn from the UV-vis measurements. Two 1:1  $\text{UO}_2^{2+}$ -*P. fluorescens* (CCUG 32456) pyoverdinin species with the following formation constants were identified:  $\log \beta_{112} = 29.60 \pm 0.43$  and  $\log \beta_{111} = 25.40 \pm 0.76$ .



**Figure 7-4.** fs-TRLFS spectra of *P. fluorescens* (CCUG 32456) pyoverdins at an ionic strength of 0.1 M ( $\text{NaClO}_4$ ); A) at  $[\text{LH}_4] 8.1 \times 10^{-6}$  M as a function of pH and B) at  $[\text{LH}_4] 5.7 \times 10^{-5}$  M as a function of  $[\text{UO}_2^{2+}]$  at pH 4.0.

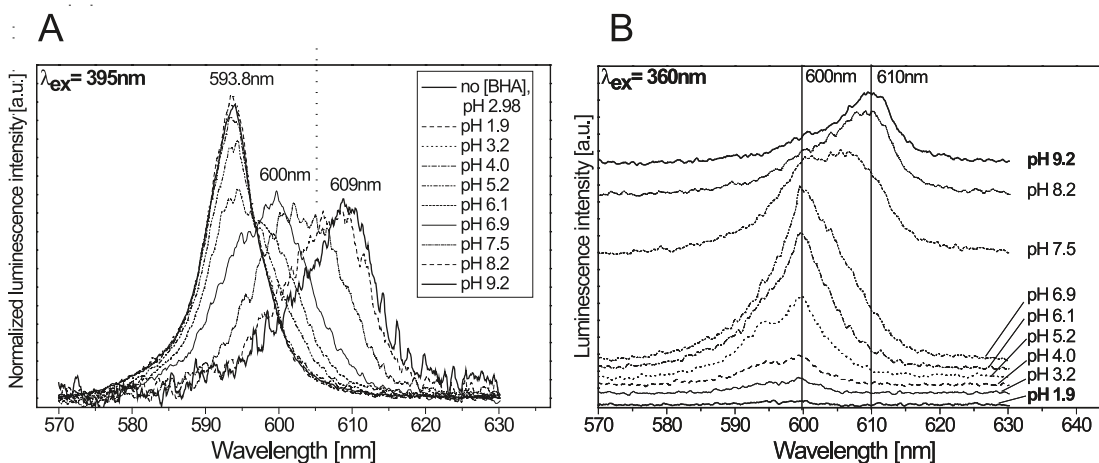
The present results help improve our understanding of  $\text{UO}_2^{2+}$  coordination chemistry with natural pyoverdinin-type siderophores in aqueous solution. Such complexation studies of selected bioligands are essential for explaining the overall processes by which uranium interacts with microbes at a molecular level. The determined stability constants can be used to quantify the uranium-mobilising effect of the bioligands released, for example, in the vicinity of a mine waste disposal site.

**(b) – Complexation of curium(III) with pyoverdinin model compounds – salicylhydroxamic (SHA) and benzohydroxamic acid (BHA)**

The complex formation of curium(III) with two hydroxamic acids, salicylhydroxamic (SHA) and benzohydroxamic acid (BHA) was studied by time-resolved laser-induced fluorescence spectroscopy (TRLFS). The luminescence properties, lifetimes and individual luminescence spectra of the Cm(III) hydroxamate species were explored. In both Cm(III)-hydroxamic acid systems a 1:1 and a 1:2 complex of the type  $\text{M}_p\text{L}_q\text{H}_r$  could be identified from the luminescence spectra having peak maxima at 600 and 609 nm, respectively. An indirect excitation mechanism of the Cm(III) luminescence was observed in the presence of the hydroxamic acids. Consistent stability constants were determined by using either indirect or direct excitation mode of the Cm(III) luminescence.

To understand the complex interaction processes of actinides in biological systems on a molecular level, it is necessary to explore the complexation behaviour of actinides with selected bioligands of relevant functionalities as model compounds. The studied ligands are model compounds for pyoverdins, which are natural bioligands secreted from *Pseudomonas* ssp. possessing a high potential to bind actinides. In continuation of previous studies investigating the complexation of pyoverdinin model compounds with uranium(VI) /Glorius et al. 2007, 2008a/ and to address the lack of studies of the complexation of hydroxamic acids with trivalent actinides, this work was focused on the complex formation of two hydroxamic acids with curium(III).

The luminescence spectroscopy experiments were carried out at fixed Cm(III) concentration of  $3 \times 10^{-7}$  M as a function of the ligand concentration ( $10^{-5}$  M to  $10^{-3}$  M) between pH 2 and 9. The ionic strength was adjusted to 0.1 M ( $\text{NaClO}_4$ ). The experiments were performed under  $\text{N}_2$  atmosphere at 25°C. To avoid carbonate complexation of Cm(III), carbonate free water and NaOH solution were used. The TRLFS spectra were recorded at 25°C using a flash lamp pumped Nd:YAG-OPO laser system (Continuum). Two excitation wavelengths of 360 and 395 nm were used. Details on the experimental setup are summarised in /Glorius et al. 2008b/. The stability constants were determined using the factor analysis program SPECFIT. The luminescence spectra of  $3 \times 10^{-7}$  M Cm(III) with  $1.5 \times 10^{-4}$  M BHA as a function of pH at an excitation wavelength of 395 nm and 360 nm are shown in Figure 7-5 A and B, respectively.



**Figure 7-5.** Luminescence spectra of  $3 \times 10^{-7}$  M  $\text{Cm}^{3+}$  and  $1.5 \times 10^{-4}$  M BHA as a function of pH at an excitation wavelength of A) 395 nm and B) 360 nm.

**Table 7-2. Summary of emission maxima, lifetimes, complex stability constants log  $\beta$  and log K of the identified Cm(III) complexes (L = C<sub>6</sub>H<sub>4</sub>CONHO).**

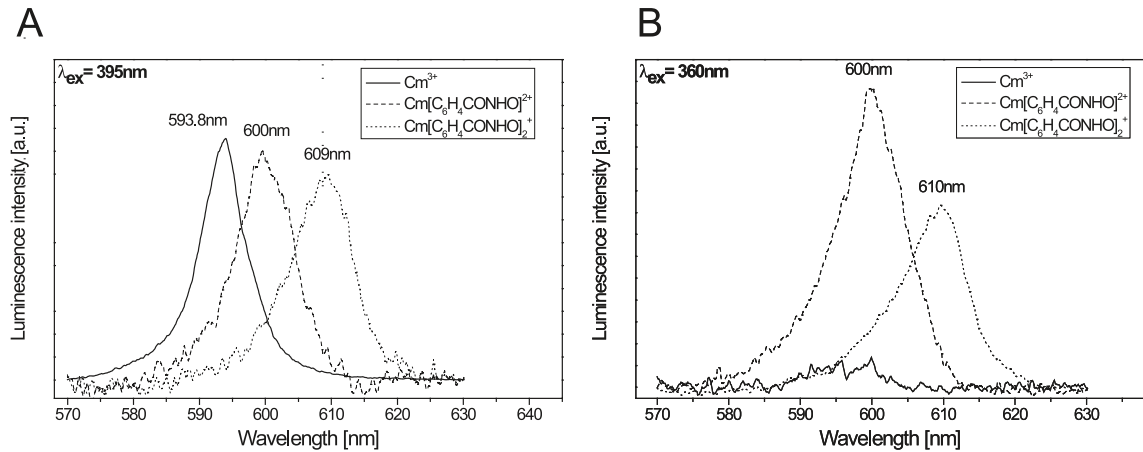
Ligand	Cm <sup>3+</sup>	SHA		BHA	
		Cm[LOH] <sup>2+</sup>	Cm[LOH,LO]	CmL <sup>2+</sup>	CmL <sub>2</sub> <sup>+</sup>
Complex					
M <sub>p</sub> H <sub>q</sub> L <sub>r</sub>					
P q r	100	111	121	110	120
Emission [nm]	593.8	600	608	600	609
Lifetime [ $\mu$ s]	68 (1)	80 (5)	200 (28)	85 (8)	150 (23)
log $\beta$		16.52 (0.14)	24.09 (0.62)	6.52 (0.19)	11.60 (0.50)
log K		6.47	14.04	6.52	11.60

In both hydroxamic acid-curium(III) systems, we observed at an excitation wavelength of 395 nm a pronounced red shift of the emission maxima with increasing pH from the characteristic emission maximum of the Cm<sup>3+</sup> aquo ion at 593.8 nm via 600 nm to an emission maximum at 608 nm. This indicates the complex formation between Cm(III) and both ligands. At an excitation wavelength of 360 nm (Figure 7-5B), we identified an increasing fluorescence intensity and red shift of the emission maxima with increasing pH. From this we can conclude that the concentration of the Cm(III)-hydroxamate species increased with increasing pH. So, the luminescence properties of Cm(III)-hydroxamate complexes can be also determined by an excitation at 360 nm via an energy transfer from the hydroxamate molecule to the Cm(III). The complexation is accompanied by an increase of the luminescence lifetime. The determined emission maxima, lifetimes and stability constants are summarised in Table 7-2. For a better direct comparison of the strength of the formed species the determined log  $\beta$  values were recalculated in log K values using the involved aqueous ligand species. The log K values of the 1:1 complexes of SHA and BHA show, that the two hydroxamic acids form 1:1 complexes with curium(III) with similar stability. In case of the 1:2 complexes BHA has a lower stability constant than SHA, which indicates a stronger complex formation of Cm(III) with SHA.

This is in agreement with the results obtained with uranium (VI) /Glorius et al. 2007, 2008a/ and other metals like Fe(III) /O'Brien et al. 2000/. The larger stability constant of SHA are probably caused by the influence of the additional phenolic OH group.

The stability constants determined either by indirect (360 nm) or direct (395 nm) excitation of the Cm(III) luminescence are consistent and show the applicability of the indirect excitation to determine complex formation equilibria. As an example the single component spectra of the curium-benzohydroxamate species at both excitation wavelengths are shown in Figure 7-6. The emission maxima of both benzohydroxamate species are in agreement measured either with direct or indirect excitation.

To summarise, we studied the interaction of Cm(III) with hydroxamic acids using TRLFS. We determined the stability constants of the Cm(III)-SHA and Cm(III)-BHA species by direct (395 nm) and indirect (360 nm) excitation of the Cm(III) luminescence. The stability constants will be compared to those of natural pyoverdins. The stability constants determined by indirect excitation of the Cm(III) luminescence agree well with the constants determined by direct excitation of the Cm(III) luminescence. Therefore, the investigation of complex formation equilibria by indirect excitation points to a new possibility to study the complex formation of luminescent actinides with organic ligands. The results contribute to a better understanding of the speciation and mobilisation of trivalent actinides by hydroxamate compounds by exploring their luminescence properties.

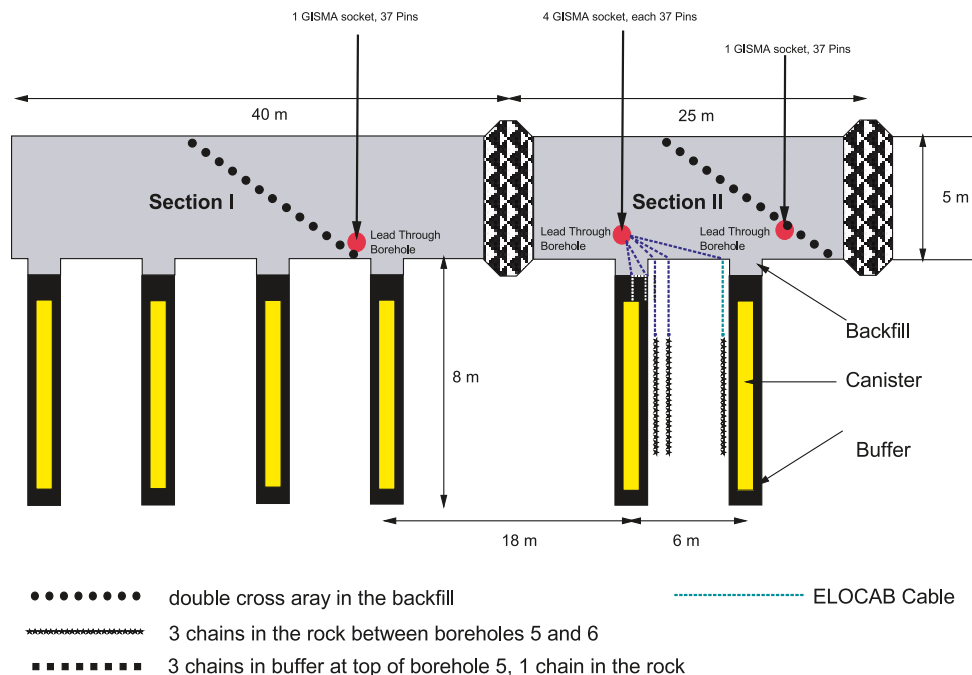


**Figure 7-6.** Luminescence spectra of the single components in the  $Cm^{3+}$ -BHA system at an excitation wavelength of A) 395 nm and B) 360 nm.

### 7.3.2 Prototype Repository

In the Prototype Repository Project electric resistivity measurements are conducted in boreholes and backfilled tunnel sections in order to investigate time-dependent changes of water content in the buffer, the backfill, and in the rock. In these investigations advantage is taken of the dependence of the electrical resistivity of geomaterials on their water content. In order to enable correlation of the measured resistivity with the actual water content, laboratory calibration measurements were performed in the geotechnical laboratory of GRS in Braunschweig, Germany.

The measuring programme, agreed on by SKB and GRS, includes the monitoring of two electrode arrays in the backfilled drift above the deposition boreholes 3 and 6, an electrode array in the buffer at the top of deposition hole 5, and three electrode chains in the rock between deposition holes 5 and 6, see Figure 7-7.



**Figure 7-7.** Arrangement of electrode arrays in the Prototype Repository. The deposition holes are numbered from left to right (1 to 6).

Special watertight cables and connectors were selected for connections between the electrodes and the geoelectric monitoring system which was installed in the data acquisition room in the parallel G-tunnel.

In 2007, the measurements have been continued as planned. In section I of the backfill the resistivity has now been below 2  $\Omega\text{m}$  in the whole measuring cross section for the last half year, without any further decrease. This corresponds to water content above 25%. From the geoelectric point of view the backfill in section I is now fully saturated.

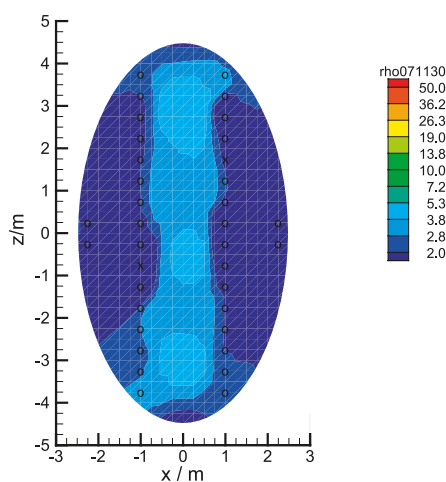
In section II, the resistivity is further decreasing. Only in the center of the section a small region with higher resistivity is maintained (see Figure 7-8), but decreasing in size. Section II is close to saturation as well.

The measurements in the buffer can no longer be evaluated in terms of water content because of the failure of several electrodes at the end of 2005. The reason for the failure is still unclear; an excavation of the electrodes in the course of post-test investigations will yield the necessary information.

The resistivity distributions along the three electrode chains installed in the rock are quite similar to each other. Close to the electrodes, the resistivity ranges around 200  $\Omega\text{m}$ . This value characterises the watersaturated concrete used for backfilling the electrode boreholes. Further away from the boreholes, the resistivity rises to values of 2,000 to 7,000  $\Omega\text{m}$  which is characteristic for saturated granite. During the last 1½ years, a progressing resistivity increase around the electrode chain close to deposition hole 5 has been detected (Figure 7-9) which might be attributed to the drying of the concrete backfill of the electrode hole and possibly of the surrounding rock. At the other chains in the rock, no such behaviour was detected.

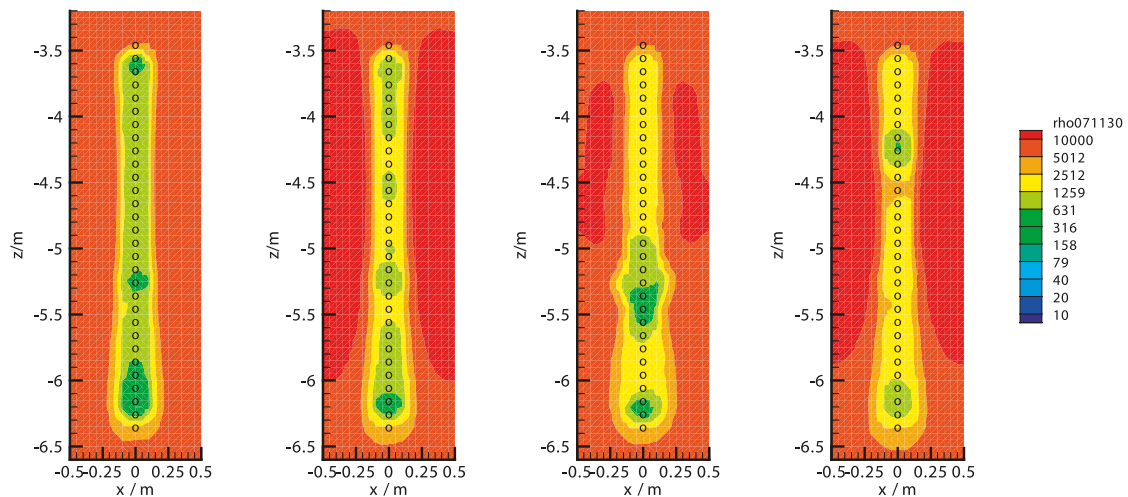
### 7.3.3 Alternative Buffer Materials

Bentonite is currently being investigated as candidate buffer material in the multi barrier systems for the safe storage of high level radioactive waste (HLRW). Its high swelling and adsorption capacity and the very low permeability are believed to play a key role in most of the European HLRW storage concepts. The performance of bentonite under repository like conditions is extensively investigated for some decades. However, less attention has been paid to the different properties of different types of bentonites which, in general, have been underestimated. The rather different performances of different bentonites in a specific application is frequently reported but hardly ever explained. Therefore, BGR research currently concentrates on (a) the



**Figure 7-8.** Resistivity distribution in backfill Section II, November 2007. o: Electrodes. Colour scale in  $\Omega\text{m}$ .





**Figure 7-9.** Resistivity evolution along the electrode chain in the rock close to deposition hole 5. From left to right: 31<sup>st</sup> May 2006, 30<sup>th</sup> November 2006, 31<sup>st</sup> May 2007, 30<sup>th</sup> November 2007. o: Electrodes. Colour scale in  $\Omega m$ .

identification of possible weaknesses of bentonites under the conditions expected and hence on (b) the identification of the optimum bentonite for this application. Accordingly, the relevant conditions and interfaces are simulated in several laboratory tests using well defined bentonites. Starting from numerous small scale tests in the laboratory it is exciting to get valuable information from large scale in situ application tests which are conducted in underground research laboratories (URL). At Äspö, one of the few European URLs, two long term tests are currently running which are particularly important with respect to the above mentioned BGR research goals.

The Long Term Test of Buffer Material (Lot) is one of the outstanding tests due to the long test period accounting for 6 years including 5 years heating period. After the heating period the copper and bentonite parcel was recovered together with the surrounding rock by percussion drilling. Many samples were collected and investigated by different research groups from all over Europe (including the BGR clay laboratory). The results show that, expectedly, mineralogical and chemical changes of the bentonite after storage are difficult to detect. However, special mineralogical methods revealed a few potential weaknesses of the bentonite that was used in the Lot experiment. These results were presented at the Andra conference in Lille, 2007 which focused on clays in engineered barriers.

In the frame of the second large scale experiment, the Alternative Buffer Material test, eleven different clays (mostly bentonites) are situated in contact with a heated steel tube and stored for several years. The heating period started recently and current research is devoted to the analysis of the precursor materials. Accordingly, the BGR clay laboratory carried out detailed mineralogical investigations using a set of specialised analytical tools. The results will be discussed in the next Task Force meeting.

### 7.3.4 Temperature Buffer Test

As the temperature is one of the main forces of hydromechanical changes within the bentonite/sand barrier, the simulation of the temperature development is of major importance, especially for the design of an engineered barrier system, since in Germany a limit of 100°C at the bentonite boundary is a well accepted design criterion. The parameter approach presented in this report is the result of various parameter variation calculations and of the adaptation of calculation values to values measured in situ. Based on the simulation, the development of the pore water pressure is modelled by means of thermo-hydraulically coupled calculations.

The calculation described was performed using Tough2 (Transport of Unsaturated Groundwater and Heat) /Pruess et al. 1990/. Tough2 has been developed at the Ernest Orlando Lawrence Berkeley National Laboratory (LBNL) since 1991. The program allows the generation of one-, two-, and three-dimensional models of non-isothermal groundwater flow and transport processes in loose and solid rock, i.e. flow in porous media and along fracture planes. The simulation program Tough2 also comprises the so called EOS module (Equation of State). Within this module the number and types of substances (components and phases) are defined and the thermo-physical properties of the flowing media are initialised. Tough2 uses an extended equation based on Darcy’s law for multiphase flow to simulate the flow and the energy equation including thermal conduction and convection for thermal transport. There are different EOS modules which can be applied depending on the problem to be examined. For a complete program system the main program has to be combined with one of the various EOS modules. For the present work with Tough2, the EOS3 module (water and air) was used for the simulation of the temperature dependent saturation of the bentonite/sand barrier.

The thermo-hydraulic calculation (TH) was performed using a simplified axially symmetric 2D model (Figure 7-10). The model consists of 11,346 zones. Along the x-axis the model ranges from the symmetry axis (centre of heater) until 58.0 m and along the y-axis from -53.5 m until 61.5 m. This covers the essential elements of the TBT-experiment. For the sake of simplicity, the section above the test room was modelled with a height and width of 5 m each. Furthermore, the surrounding solid rock was first configured as hydraulically impermeable and later as slightly permeable.

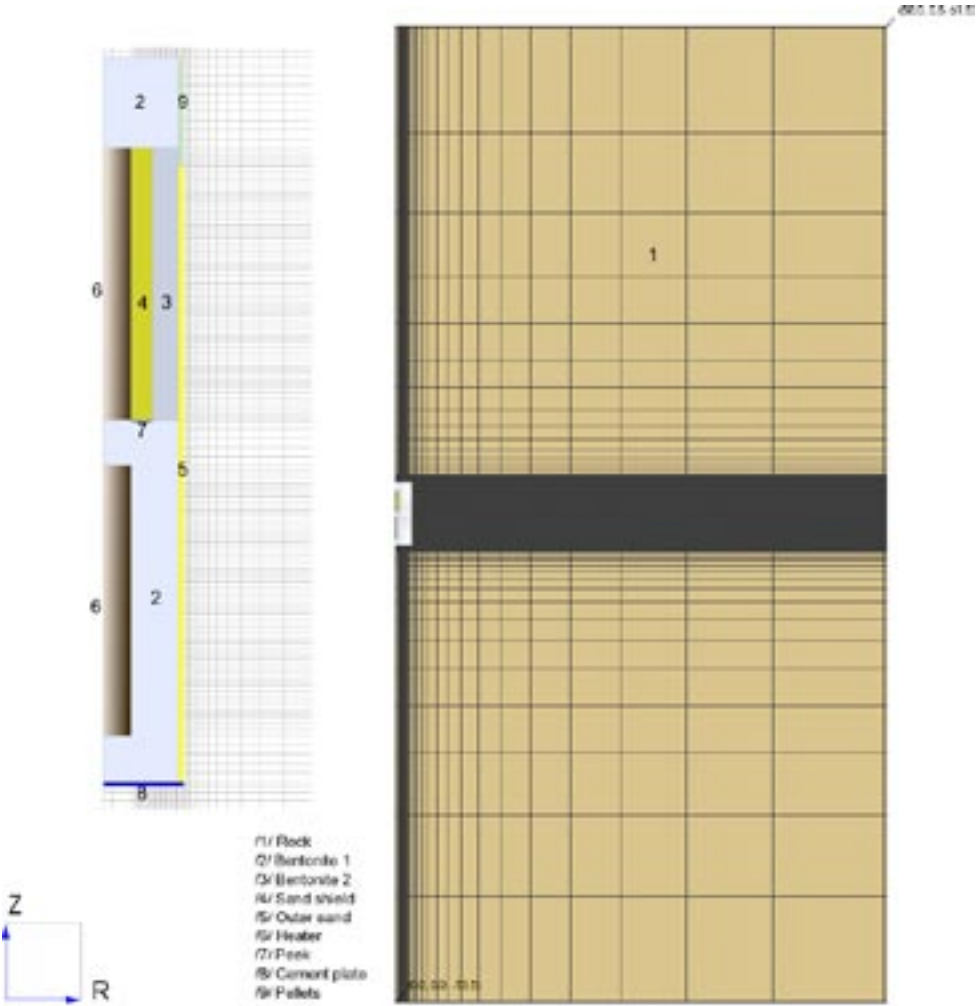


Figure 7-10. Model geometry and materials considered (2D axially symmetric).

In the beginning the definition of the model parameters was based on the modelling guidelines of 2003/2004 /Hökmark and Fälth 2003, Hökmark et al. 2004/. The material characteristics of this first calculation approach were taken from published data /Ledesma et al. 2005/ and some were adapted for their application in the relative permeability and capillary pressure laws implemented in Tough2 /van Genuchten 1980/. Based on in situ measurement values, the sand filter surrounding the borehole was saturated depending on time and the two heaters were modelled with the different heat output values of the experiment (including down times). Calculations using different parameter settings to improve the model-to-measurement fit were performed focusing on thermal issues mostly.

In Table 7-3–Table 7-5 the parameters used are given as well as the starting variables and assumptions made for the calculation.

**Table 7-3. Thermal conductivity  $\lambda_c$  (W/mK), specific heat capacity  $c$  (J/kg, K).**

Material	Law	$\lambda_c$ (W/mK)		$c$ (J/kgK)
		$\lambda_{c, dry}$	$\lambda_{c, sat}$	
Bentonite 1		0.57	1.36	1,091
Bentonite 2		0.57	1.36	1,091
Solid rock		1.73	3.0	800
Pellets	$\lambda_c = \lambda_{c,dry} + \sqrt{S_l \cdot (\lambda_{c,sat} - \lambda_{c,dry})}$	0.6	0.8	1,091
Sand buffer		0.4	1.38	900
Sand filter		0.6	1.7	900
Steel		50.16	50.16	460

**Table 7-4. Capillary pressure function /van Genuchten 1980/.**

Material	Law	$\lambda$	$S_{lr}$	$1/P_0$ (1/Pa)	$P_{max}$ (Pa)	$S_{is}$
Bentonite 1		0.33	0.001	2.33E-08	9.0E+07	1.0
Bentonite 2		0.33	0.001	2.33E-08	9.0E+07	1.0
Solid rock	$P_{cap} = -P_0 ((S^*)^{-1/\lambda} - 1)^{1-\lambda}$	–	–	–	–	–
Pellets	$S^* = (S_l - S_{lr}) / (S_{ls} - S_{lr})$	0.4	0.001	5.00E-05	8.0E+07	1.0
Sand buffer	$-P_{max} \leq P_{cap} \leq 0$	0.3	0.001	1.00E-05	8.0E+07	1.0
Sand filter		0.3	0.001	1.00E-05	8.0E+07	1.0
Steel		–	–	–	–	–

**Table 7-5. Relative permeabilities /Mualem 1976, van Genuchten 1980/.**

Material	Law	$\lambda$	$S_{lr}$	$S_{is}$	$S_{gr}$
Bentonite 1		0.8	0.05	1.0	0.1
Bentonite 2		0.8	0.05	1.0	0.1
Solid rock		0.3	0.1	1.0	0.1
Pellets		0.8	0.1	1.0	0.1
Sand buffer	$k_{rl} = \begin{cases} \sqrt{S^*} \left[ 1 - (1 - (S^*)^{1/\lambda})^\lambda \right]^2 & \text{if } S_l < S_{ls} \\ 1 & \text{if } S_l \geq S_{ls} \end{cases}$	0.8	0.05	1.0	0.1
Sand filter	$k_{rg} = \begin{cases} 1 - k_{rl} & \text{if } S_{gr} = 0 \\ (1 - \hat{S})^2 \cdot (1 - \hat{S}^2) & \text{if } S_{gr} \geq 0 \end{cases}$	0.8	0.05	1.0	0.1
Steel		–	–	–	–

$$0 \leq k_{rl}, k_{rg} \leq 1; \quad S^* = (S_l - S_{lr}) / (S_{ls} - S_{lr}), \quad \hat{S} = (S_l - S_{lr}) / (1 - S_{lr} - S_{gr})$$

Figure 7-11 shows the adjustment of the capillary pressure curve to data determined in experiments based on bentonite MX-80 /Hökmark et al. 2004/. It is pointed out that recent experimental data indicate even higher values for the capillary suction power. The strict limitation of  $P_{max}$  to values below  $1.0 \times 10^8$  Pa was introduced due to calculation problems. For the bentonite saturation range relevant to this case ( $> 0.7$ ) this limitation has no effect.

In the model the water inflow rate was designated as a hydraulic boundary condition at the sand filter and set according to the inflow measurements.

In a first calculation run all materials were initialised without capillary pressure properties. As a consequence, only the sand filter was saturated completely. The complete saturation leads to a pressure build-up in the sand filter which in turn initialised the saturation process in the surrounding bentonite. This first model version was chosen as a thermal boundary condition for subsequent calculations as the saturation has a significant influence on the thermal conductivity of materials. Based on this, a huge amount of calculations were performed using variations of the saturation dependent thermal conductivities and employing capillary pressure properties. These calculations resulted in the “best fit” parameters listed in Table 7-3. In Figure 7-12 and Figure 7-13 the measured (light colour) and calculated (dark colour) temperature curves are compared. The comparison of measurement and calculation values was performed at significant measurement points with the radii 0.36 m (near heater, Ring 4 – in bentonite, Ring 10 – in sand buffer), approximately 0.54 m (in bentonite, Ring 4 – bentonite, Ring 10 – bentonite near sand buffer) and 0.78 m (in bentonite, near sand filter).

The calculations have been focused on the very transient phase where significant temperature changes occur. The measurement and calculation values showed a very good fit in the area of the lower heater (Ring 4). It is of note that the thermal conductivities in the model are saturation dependent (as already described, Table 7-3). The hydraulic approach is currently modelled using only one set of parameters per material. A change in the saturation behaviour of the sand filter would thus affect the thermal conductivity.

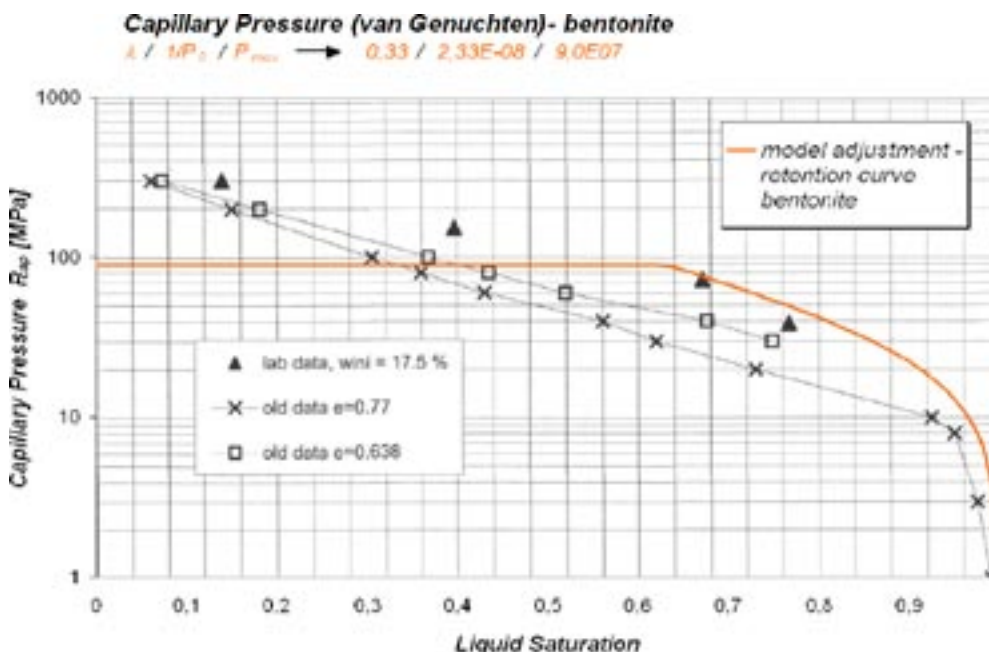
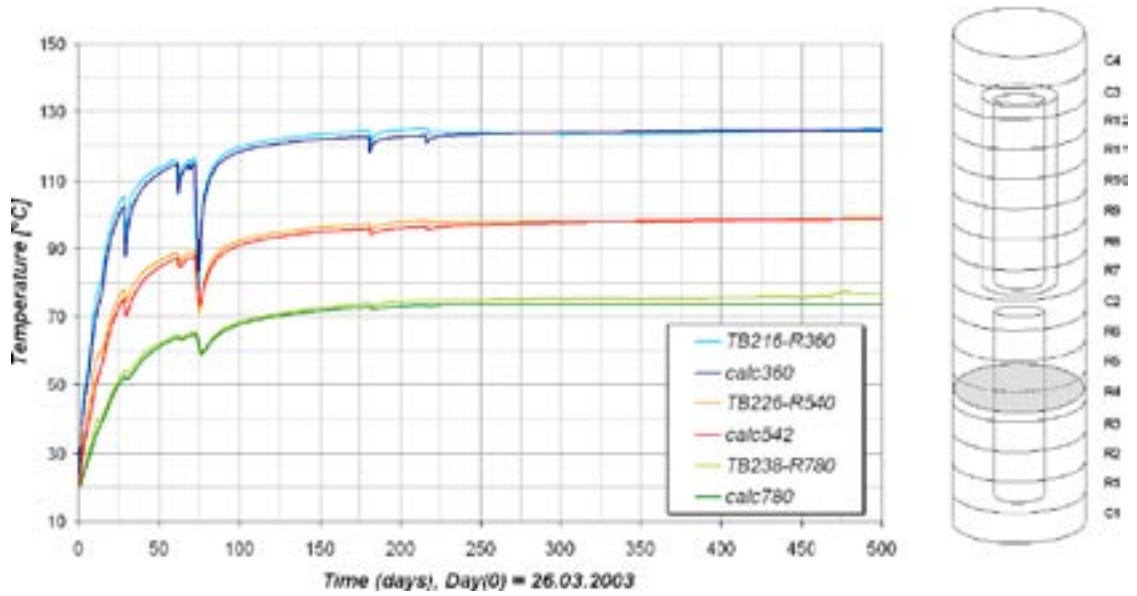
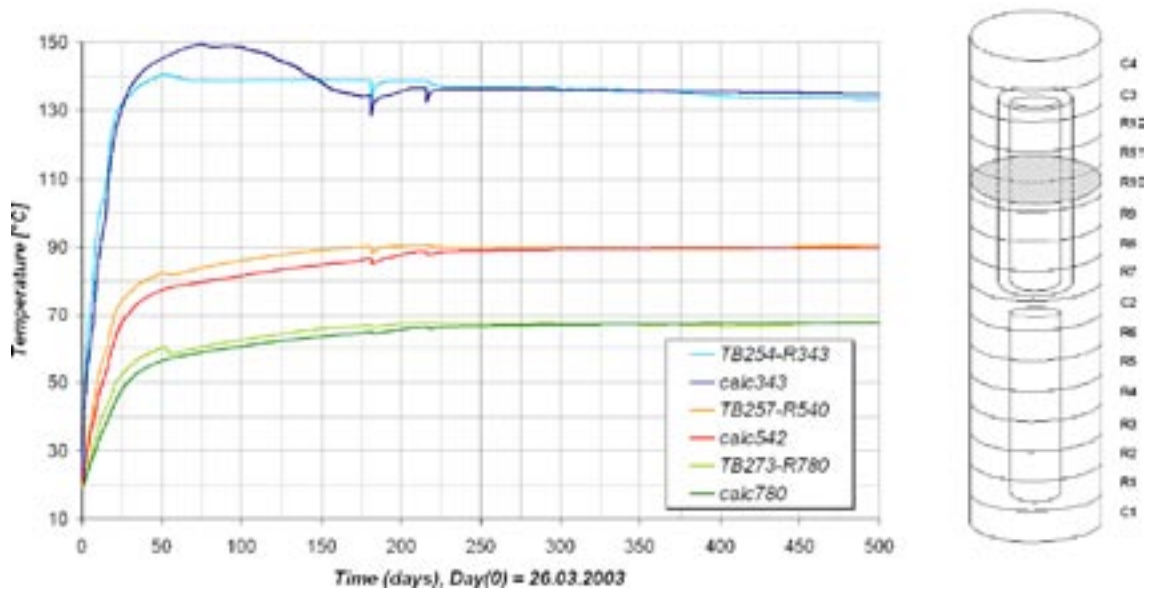


Figure 7-11. Model parameter adjustment for bentonite /Hökmark et al. 2004/.



**Figure 7-12.** Temperature curves at observation Ring 4 (heater 1), Comparison of measured (light colour) and calculated values (dark colour).



**Figure 7-13.** Temperature curves at observation Ring 10 (heater 2), Comparison of measured (light colour) and calculated (dark colour) values.

The temperature comparison at Ring 10 shows a slightly low prediction of the temperature field in the bentonite until approximately day 250. Until day 25 ( $t = 25$  days) the temperatures near the heater (in the sand buffer) are predicted too low. This indicates that the initial saturation dependent thermal conductivity in the sand buffer near the heater surface, which was set to  $\lambda_{c,dry} = 0.4 \text{ W m}^{-1}\text{K}^{-1}$ , was a bit too high.

In the further course of the calculation the calculated temperature value in the area of the sand filter is significantly higher than the measured temperature value but approaches the measurements again until simulation date  $t = 225$  days. At later times the measurement and calculation values show a very good fit in the area of the upper heater (Ring 10), see Figure 7-13.

The next step will be to compare measured and calculated pore pressure values in order to fine tune the hydraulic processes in the model with simultaneous consideration of the thermal fitting already achieved.

### **Summary**

First analyses show a good fit of the measured and calculated temperature fields. A comparison with the values measured by the temperature, pressure, and moisture sensors now permits further parameter variations in order to achieve an even better fit. As the model considers saturation dependent thermal conductivities of the materials, an accurate modelling of the saturation process also has a major effect on the thermal calculation. A much better fit of the temperature evolution has been obtained after introduction of saturation dependent thermal conductivities than in the previous modelling phase.

### **7.3.5 Large Scale Gas Injection Test**

The hydraulic tests with surface packer systems that BGR conducted in the framework of the Lasgit project have been summarised and documented in the International Progress Report /Nowak 2007/.

### **7.3.6 Task Force on Engineered Barrier Systems**

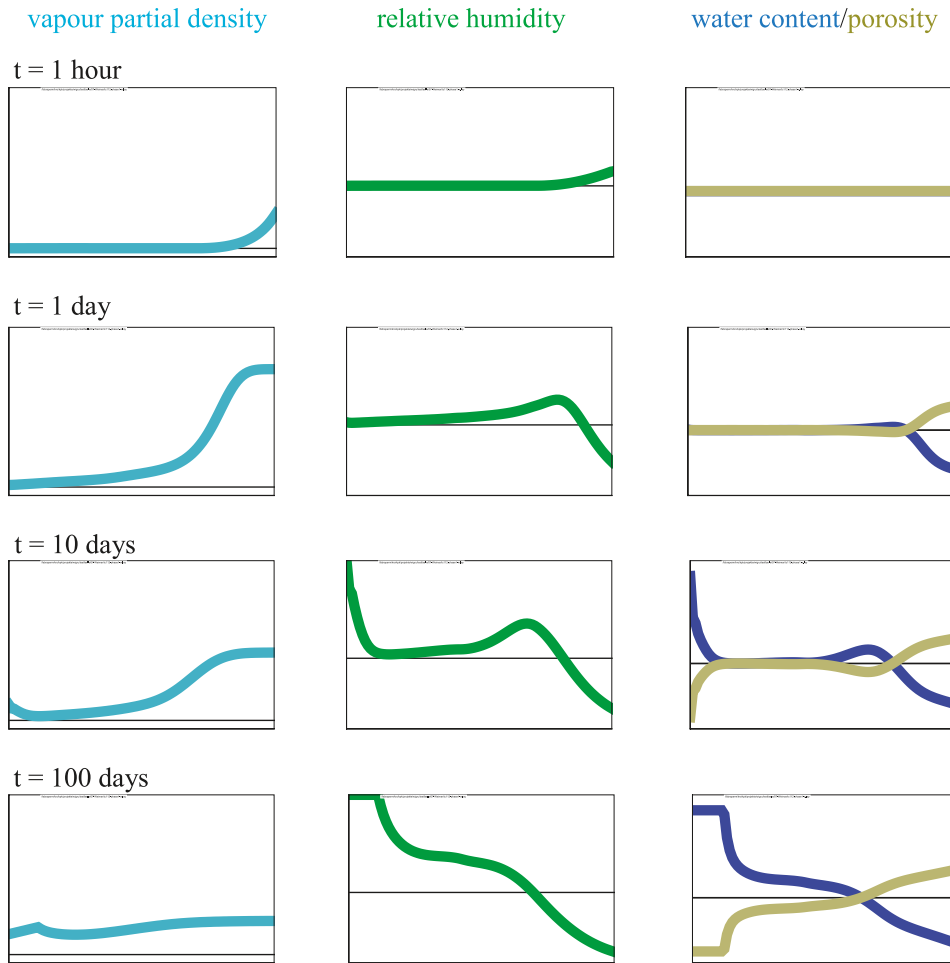
BGR participates in Task 1 (THM-coupled processes) and Task 2 (gas migration processes) in the clay rich buffer materials. In 2007 a summary report was published /Nowak 2007/, which describes the modelling of the benchmarks concerning THM-coupled processes in geotechnical barriers (MX-80 and Febex bentonite) with the code GeoSys/RockFlow at laboratory scale (Benchmark 1). The measured data from these benchmarks can be reproduced with the code, in most cases quantitatively, in few cases only qualitatively. Agreement between measured data and calculated data may be enhanced by adjusting parameter values.

The modelling of the Benchmark 2 – large scale in situ tests – started in 2007. First results for the Canadian Isothermal Test and the Buffer/Container Experiment have been presented at the Project Meeting in Stockholm (22<sup>nd</sup>–23<sup>rd</sup> November 2007).

In 2006 GRS further developed the code Viper, based upon the code Vapmod, to include the effect of non-isothermal conditions on bentonite resaturation via water vapour. At the end of 2006 a preliminary version of VIPER was able to reproduce the moisture redistribution in a bentonite sample due to an applied thermal gradient. The modelling was based on phase 1 of Benchmark test 1.1.2 of the Task Force on Engineered Barrier Systems of SKB and UPC.

The development of code Viper was continued in 2007 aiming at reproducing also phase 2 of this test case which included an additional uptake of liquid water. Work on this problem revealed a previously unnoticed recursion in the partial derivative of water content with respect to temperature which was resolved by a new iterative procedure. Furthermore, the unexpected complex relation between the secondary variables involved in the non-isothermal water uptake became evident by explaining their evolution during the simulation (Figure 7-14).

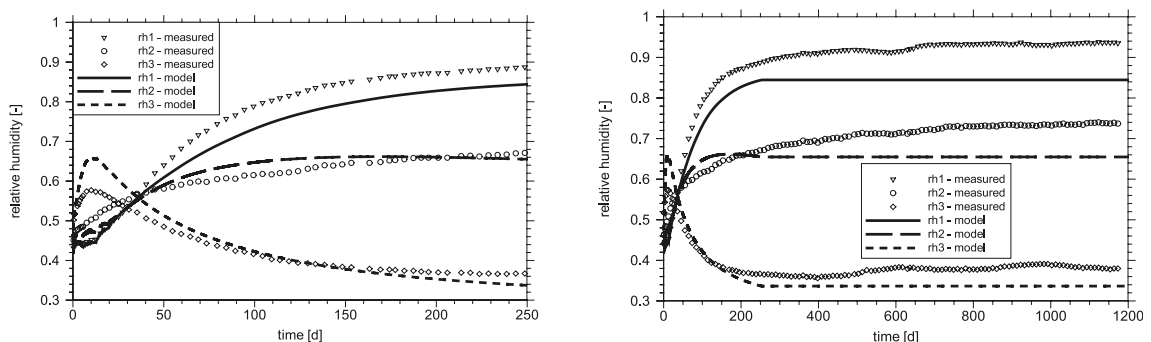
As another problem the question about steady-state conditions of the underlying laboratory test came into focus. The present state of knowledge is reflected by the choice of test cases in the Task Force on Engineered Barrier Systems that do not provide conclusive evidence about the terminal conditions. Presently realised in VIPER is the idea that resaturation stops when no further hydration and thus swelling is possible for geometrical reasons. Vapour transport in



**Figure 7-14.** Evolution of characteristic primary and secondary variables during non-isothermal bentonite resaturation.

the pore space becomes very fast in this situation because it is not slowed down by hydration anymore. Such conditions evolve firstly at the inflow boundary. Where swelling is not possible anymore, the vapour partial density is kept at that value that is prescribed at the inflow boundary of the model. Physically, this assumption means that the water-air interface does not move and the non-shrinking pore space is quickly filled with vapour.

Based on these advancements in VIPER it was possible to model the complete Benchmark test 1.1.2 and achieve a satisfying match between the measurements and model results (Figure 7-15).



**Figure 7-15.** Measured and calculated relative humidity; close-up and full data set.

Bauhaus Universität Weimar performed THM-column experiments at the laboratory of soil mechanics on a highly compacted sand/bentonite mixture. Results of these tests may be proposed as additional benchmark data if requested later. Upon hydration by vapour our fluid, time series of water content, temperature and total suction in a sample with a volume of about 10 litres were monitored. First data show, compared with column data of this size, significant low scatter in the measurements. The experimental concept applied allows data acquisition during all stages of hydration. Additional to hydraulic gradients swelling pressures were measured and it was possible to apply thermal gradients.

Moreover, the further development of the approach to identify coupled THM process described by numerical models was performed. Using inverse modelling and employing different optimisation techniques like particle swarm optimiser and genetic approach, problems were quantitatively treated as swelling pressure for isochoric conditions (one step and multi step procedures, volumetric behaviour under oedometric boundary conditions). The software used for the forward model was Comes-Geo and Code\_Bright. Model identification is successfully done by considering data generated by experiments performed in the laboratory of soil mechanics at Weimar.

## **7.4 CRIEPI**

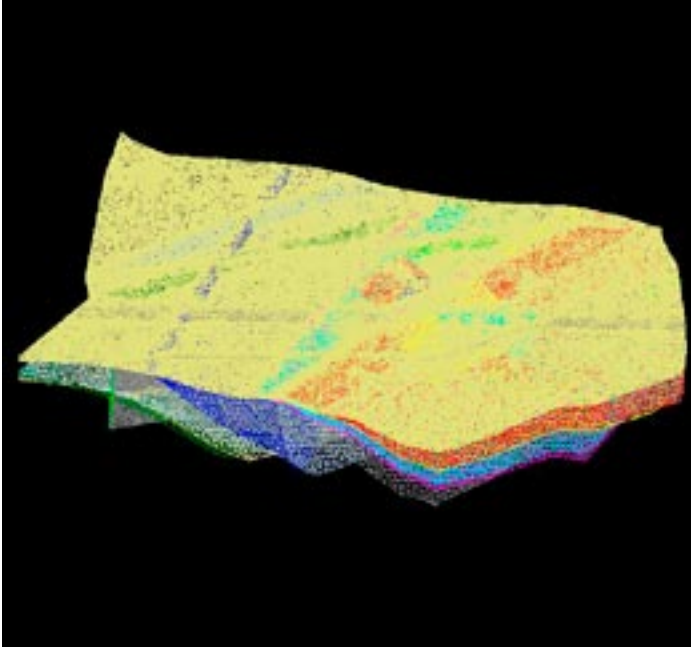
Central Research Institute of Electric Power Industry (CRIEPI) participates mainly in modelling activities. CRIEPI has participated in the Task Force on Modelling Groundwater Flow and Transport of Solutes and performed modelling work for Task 7, Long Term Pumping Test at Olkiluoto in Finland. CRIEPI has also participated in the Task Force on Engineered Barrier Systems, tackled benchmark problems and compiled a report on the calculation results.

### **7.4.1 Task Force on Modelling Groundwater Flow and Transport of Solutes**

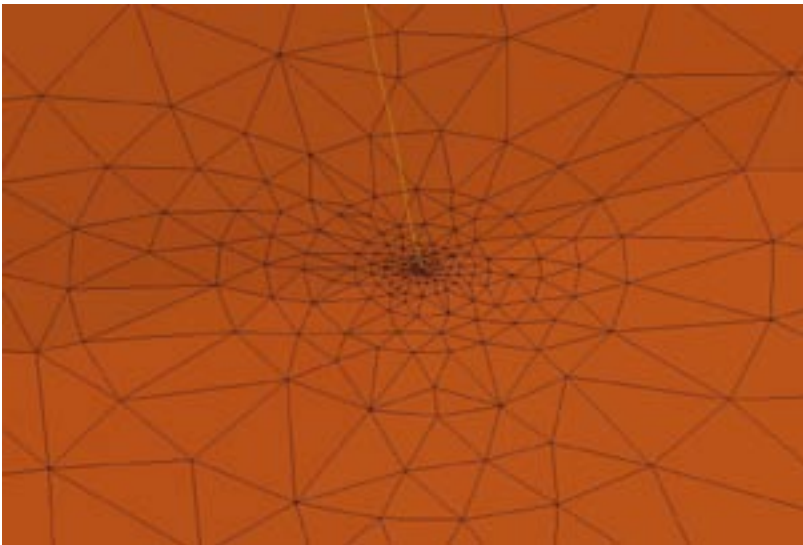
During 2007, CRIEPI continued to perform a numerical analysis for sub-task 7A which concerns site-scale modelling of long term pumping test at Olkiluoto in Finland. In the analysis, groundwater flow at site scale was calculated under the natural condition as well as during the pumping test. The modelled domain was an approximately 10 km<sup>2</sup> region enclosed by five major hydraulic conductors. 15 fracture zones and 38 boreholes were incorporated into the numerical model. The near-surface background rock from 0–80 metres was also incorporated into the model as porous media, but deeper background rock was not taken into consideration. Figure 7-16 shows the finite element mesh used for the numerical analysis. 1-, 2- and 3-dimensional elements were used to express the boreholes, the fracture zones and the near-surface rock, respectively. The 2-dimensional elements were subdivided into smaller elements in the neighbourhood of the intersections of a fracture zone with other fracture zones or boreholes (see Figure 7-17). The 3-dimensional elements were also subdivided into smaller elements in the neighbourhood of boreholes (see Figure 7-18).

The hydraulic heterogeneity of the fracture zones was taken into consideration. The transmissivity measured at the intersection of a fracture zone with a borehole was assigned to the area within a 100-meter radius of the intersection and the geometric mean of transmissivities measured at each fracture zone was assigned to the other areas of the fracture zone (see Figure 7-19). Hydraulic conductivity of the near-surface background rock was assumed to be  $2 \times 10^{-7}$  m/s as recommended. The influence of salinity on groundwater flow was not considered in the analysis.

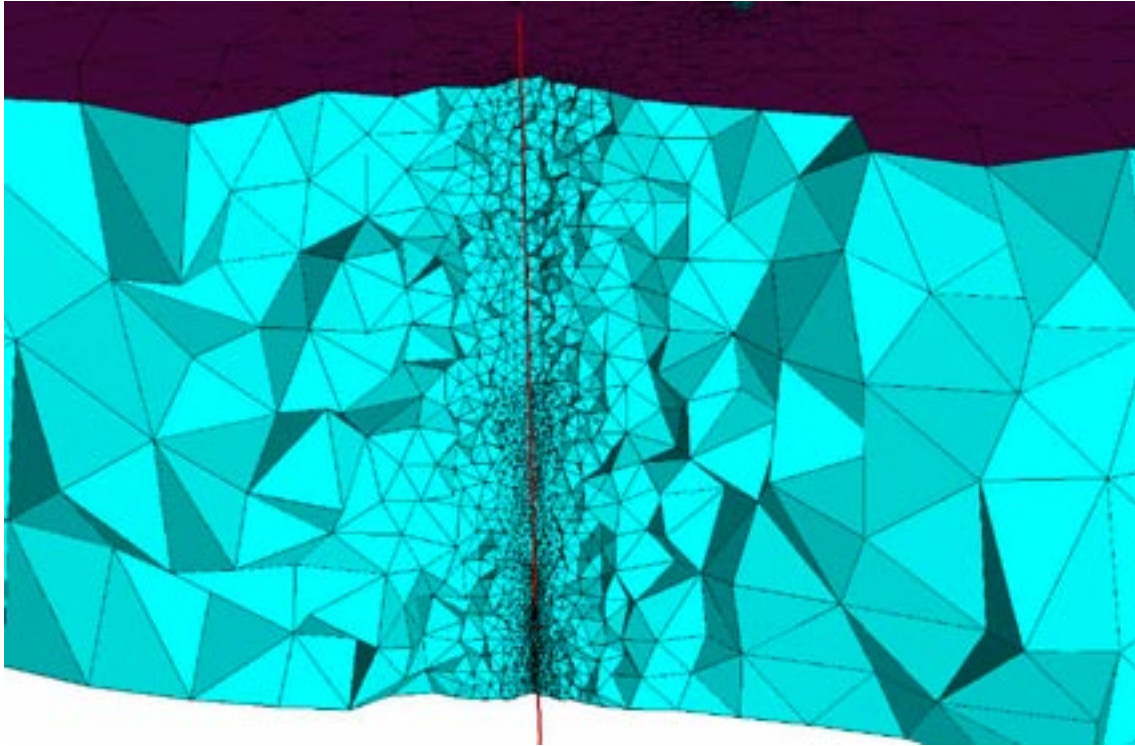




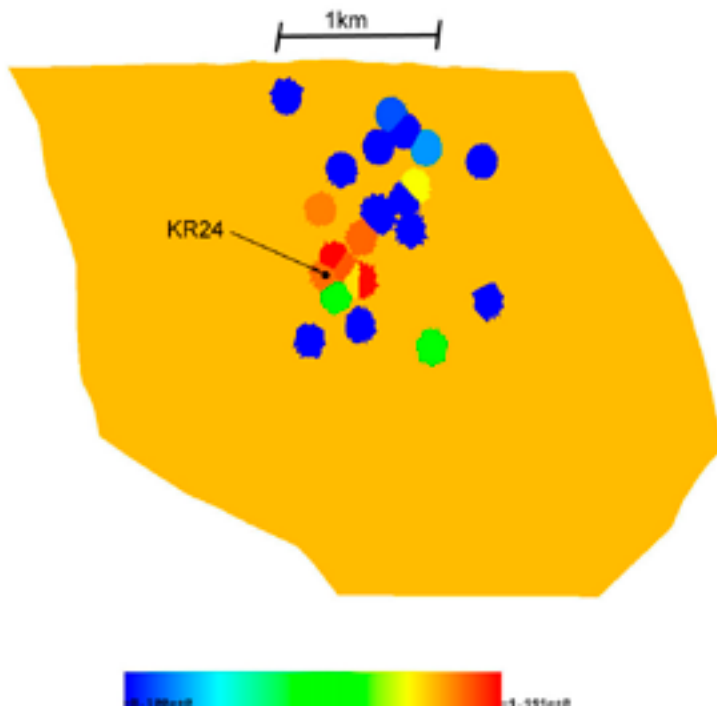
*Figure 7-16. Finite element mesh (Overall view).*



*Figure 7-17. Finite element mesh (2-D elements adjacent to a borehole).*



*Figure 7-18. Finite element mesh (3-D elements adjacent to the pumping borehole, KR24).*



*Figure 7-19. An example of distribution of transmissivity allocated to a fracture zone (fracture zone HZ20A).*

Groundwater was withdrawn at 18  $\lambda$ /min from the pumping borehole during the pumping test. The drawdowns caused by pumping were simulated. The following index,  $S$ , was introduced in this simulation.

$$S = \sum_{i=1}^{20} \frac{s_i^m - s_i^c}{s_i^m}$$

where  $s_i^m$  is the drawdown measured at the  $i$ -th monitoring section and  $s_i^c$  is the calculated drawdown. The potential groundwater recharge from the top surface was calibrated so that the value of the index,  $S$ , became zero. As a result, the potential groundwater recharge was estimated to be 80 mm/year. The calculated drawdowns are showed with the measured ones in Figure 7-20. The drawdowns could be reproduced well on the whole.

The groundwater inflow from the rock through the fracture zones was also calculated for several monitoring boreholes. The changes of the inflow caused by pumping are shown in Figure 7-21. The figure also shows the changes of the inflow calculated in the simulation case where the fracture zones were assumed to be homogeneous hydraulically. The heterogeneous-fracture model could reproduce the measured change of the inflow better than the homogeneous-fracture model.

#### 7.4.2 Task Force on Engineered Barrier Systems

CRIEPI has been developing the thermal-hydrological-mechanical (THM) coupling code Lostuf for evaluating the phenomena that will occur around the engineered barrier system. In 2007, Benchmark test 2.1 was carried out, and Lostuf was applied to the Buffer/Container Experiment (BCE) and Isothermal Test (ITT) which were carried out by AECL at its Underground Research Laboratory (URL) in Canada.

In the ITT, a 5-m-deep by 1.24-m-diameter borehole was excavated in the unfractured, homogeneous granite rock. The bentonite-sand buffer material was compacted in situ in the bottom of the borehole (0–2 m). A 1.25-m-thick concrete plug was overlaid on the compacted bentonite-sand buffer to provide a vertical restraint against swelling. Various instruments were installed in the buffer and the surrounding rock in order to monitor the resaturation process.

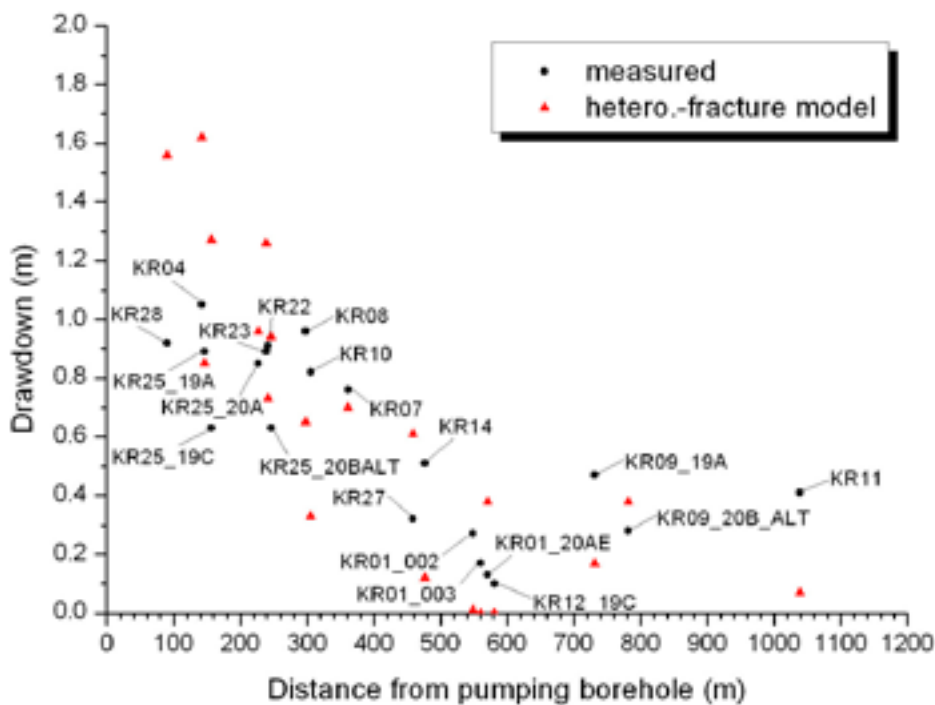


Figure 7-20. Drawdowns in monitoring boreholes during pumping test.

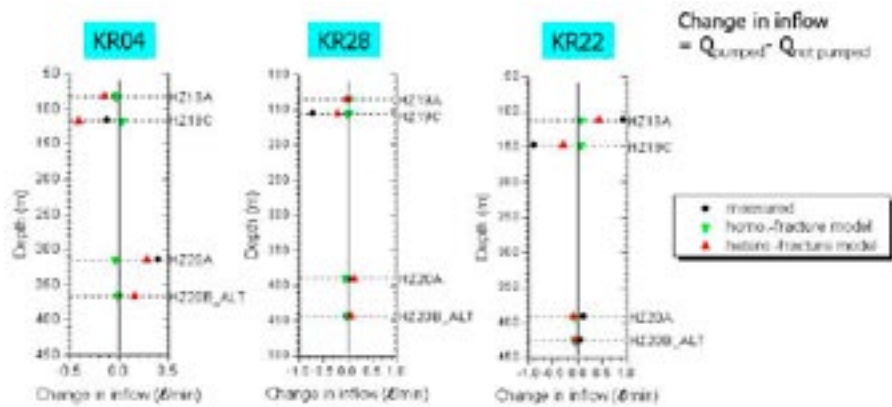


Figure 7-21. Changes of groundwater inflow to monitoring boreholes caused by pumping.

Figure 7-22 shows the finite element mesh that was used for the simulation of ITT. It focuses on the borehole and its vicinity. Two different cases were conducted. The difference between them is the value of the intrinsic permeability. Figure 7-23 shows the contour maps of water content in buffer at four selected times in the simulation case 1. The value of intrinsic permeability  $\kappa$  is equal to  $1.0 \times 10^{-20} \text{ m}^2$ , which is in the range given in specification. Figure 7-24 shows the contour maps obtained from the simulation case 2. The value of  $\kappa$  is one tenth of that used in case 1. Figure 7-25 shows the measured water content distribution at the end of ITT. In case 1, the infiltration was too fast. On the other hand, the infiltration in case 2 was a little slower than the measured data, but a better prediction was obtained.

The BCE consisted of an electric heater installed in buffer in a 5 m deep and 1.24 m diameter borehole. A 50 mm thick layer of sand was installed between the heater and the surrounding buffer. A 1 m thick layer of backfill was installed in the upper part of the borehole, above the buffer and the cell cap and reaction frame. Figure 7-26 shows the finite element mesh used in the analysis of BCE. It focuses on the vicinity of the borehole. Figure 7-27 shows the temperature profile on the level of mid-height of buffer. Calculated temperatures are in good agreement with the measured ones. Figure 7-28 shows the pore pressure at the boreholes (HG8 and HG9). The variation of calculated pore pressures along the boreholes was small although thermal induced increase of pore pressures was monitored. Local heterogeneity of rock mass is one possible reason for this variation of pore pressure. Figure 7-29 and Figure 7-30 show calculated and measured water content contour in buffer, respectively. Calculated water infiltration was faster than measured data, especially in the side of heater. Figure 7-31 shows the total pressure profiles at five selected sensors. Prediction was not perfect, but caught the tendency of increasing total pressure.

Further investigation is required in the determination of hydraulic properties of buffer materials. The results of laboratory infiltration tests using the same buffer material were delivered after these simulations. Another case will be conducted after the hydraulic properties of this buffer material are calibrated through the analyses for the laboratory tests. Lostuf will also be applied to the analyses for Canister Retrieval Test in 2008 as Benchmark test 2.2.

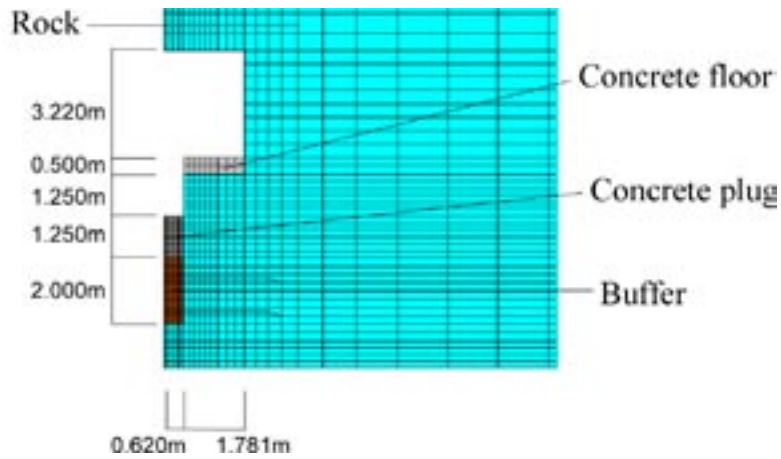


Figure 7-22. Finite element mesh around the borehole in ITT.

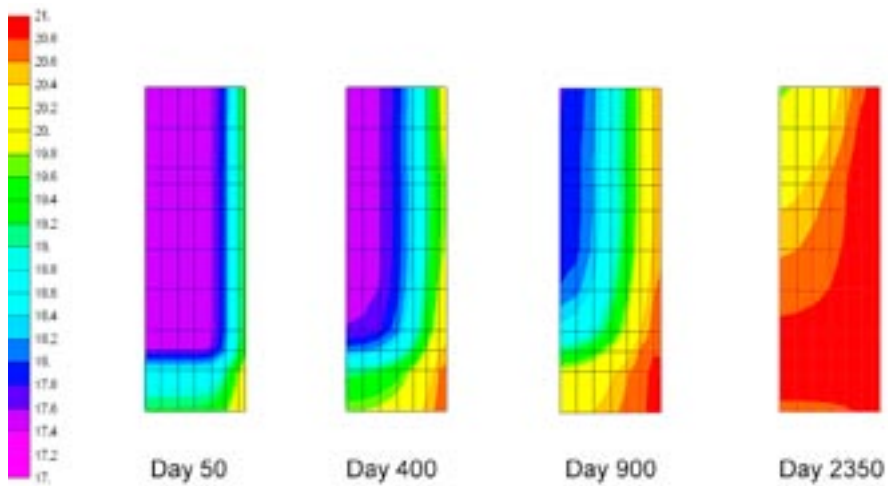


Figure 7-23. Contour maps of water content in buffer (Case 1:  $\kappa = 1.0 \times 10^{-20} \text{ m}^2$ ).

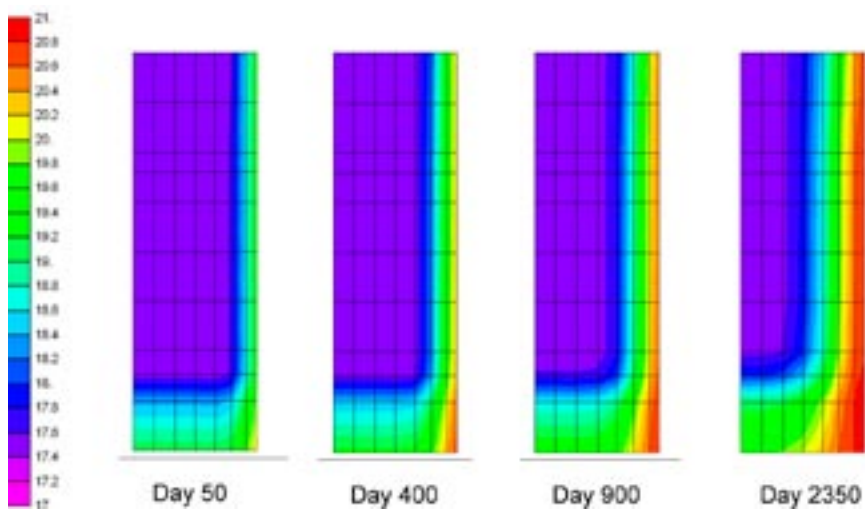


Figure 7-24. Contour maps of water content in buffer (Case 2:  $\kappa = 1.0 \times 10^{-21} \text{ m}^2$ ).

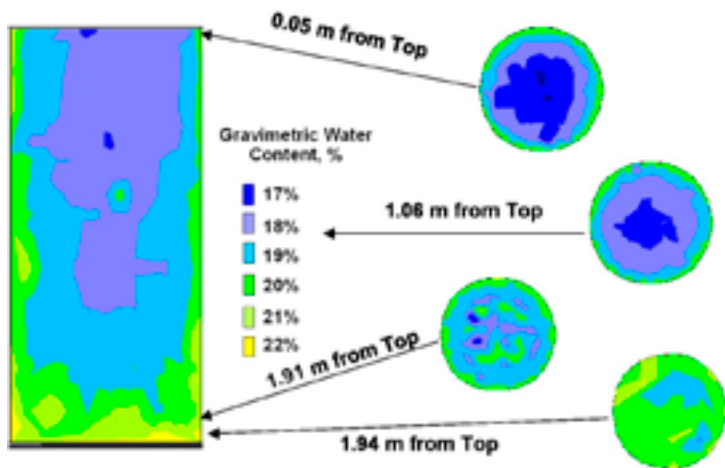


Figure 7-25. Contour map of water content in buffer at the end of ITT (after AECL).

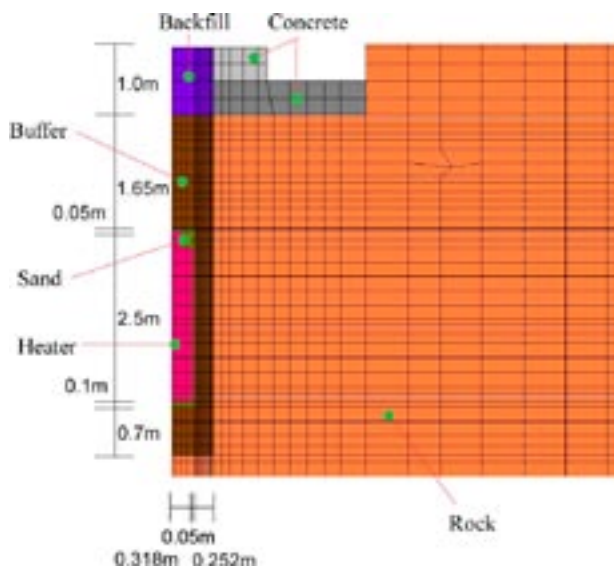


Figure 7-26. Finite element mesh around the borehole in BCE.

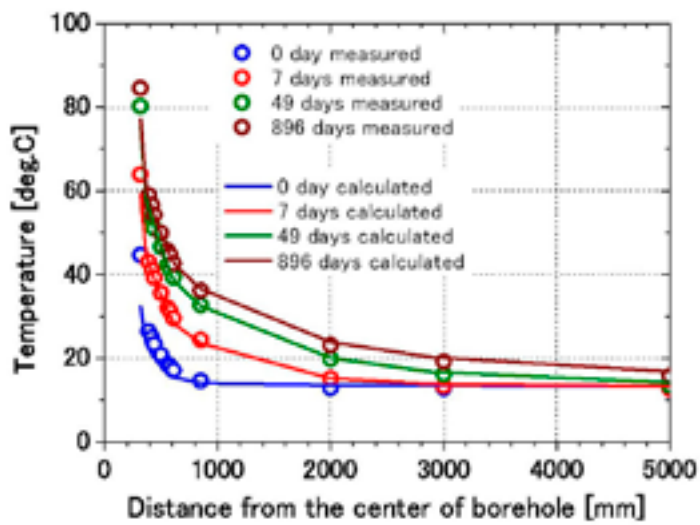


Figure 7-27. Temperature profile on the mid-height of buffer.

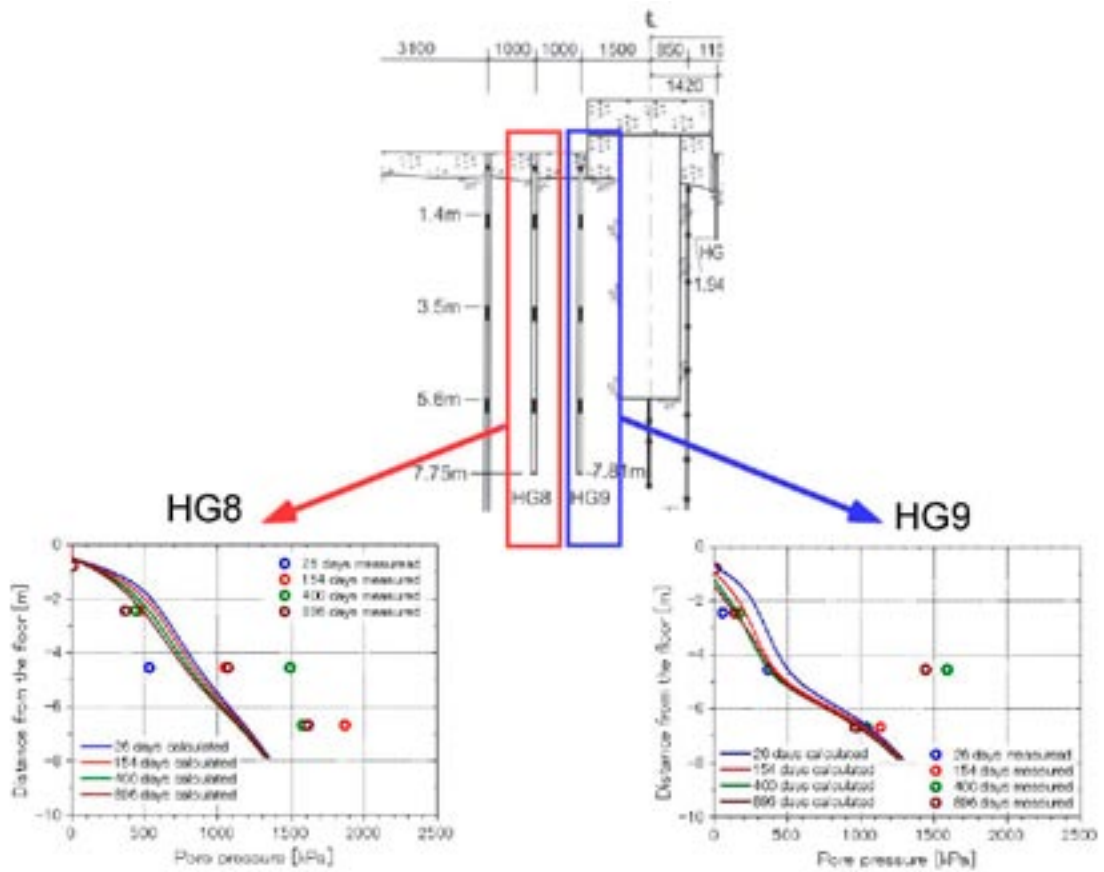


Figure 7-28. Pore pressures in the surrounding rock.

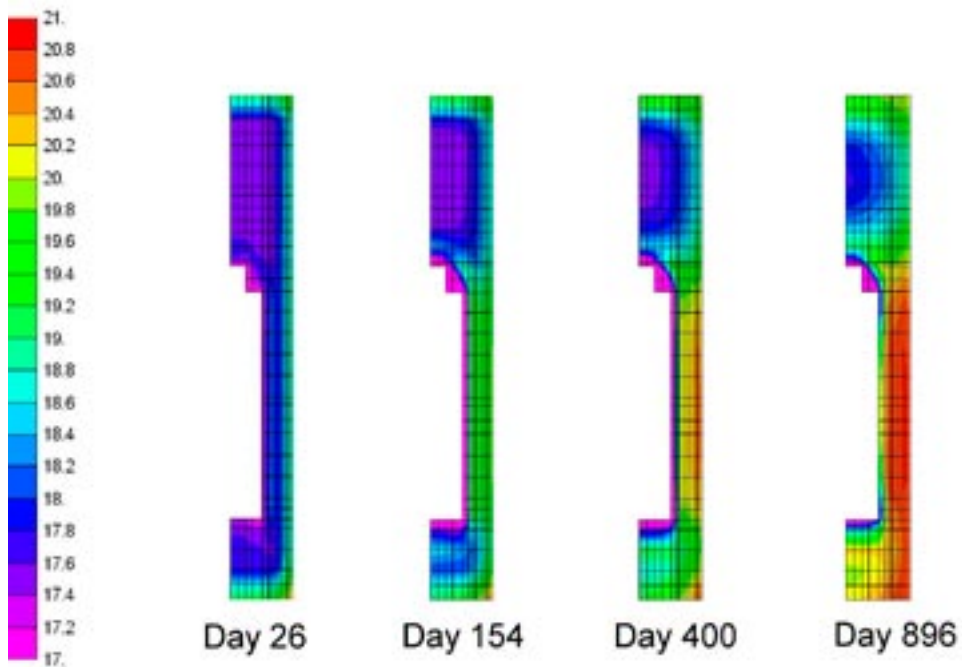


Figure 7-29. Calculated contour maps of water content in buffer at selected four times.

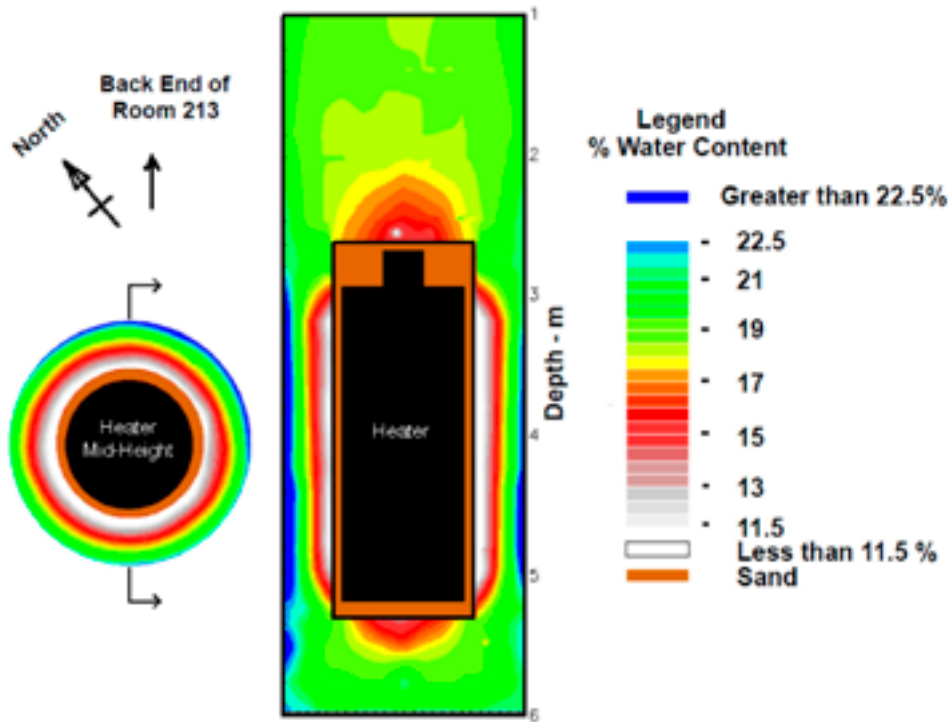


Figure 7-30. Contour map of water content obtained at the end of BCE (after AECL).

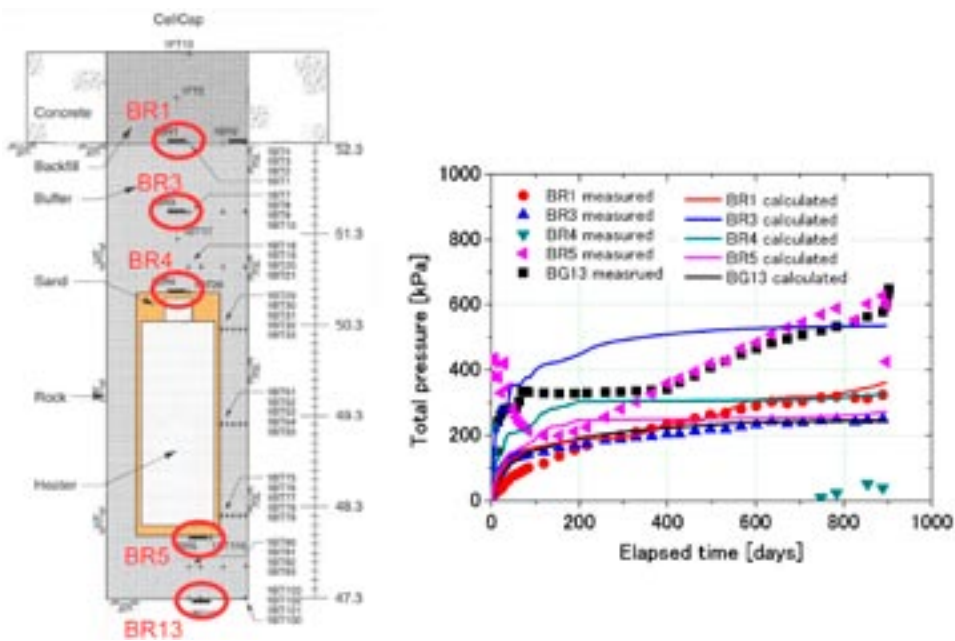


Figure 7-31. Positions of total pressure sensors and total pressure profiles.



## 7.5 Japan Atomic Energy Agency – JAEA

The role of Japan Atomic Energy Agency (JAEA) in the Äspö laboratory directly contributes to JAEA's mission as providing technical basis for repository site characterisation, safety assessment, and regulation in Japan. The Äspö HRL provides practical information that directly benefits JAEA's underground radioactive waste research laboratories at Horonobe and Mizunami, Japan.

JAEA's research objectives at Äspö during 2007 included improved understanding of:

- site characterization technologies, particularly flow logging and hydraulic interference,
- flow and transport in fractured rock,
- underground research laboratory experiments and priorities,
- safety assessment technologies.

These objectives are designed to support high level waste repository siting, regulation, and safety assessment in Japan.

### 7.5.1 Tracer Retention Understanding Experiments

JAEA has participated in the Tracer Retention Understanding Experiments (True) since 1997. During 2007, JAEA assisted in the preparation of professional papers for Journal of Hydrogeology describing work carried out as part of the Task Force on Modelling of Groundwater Flow and Transport of Solutes, using information and approaches developed as part of the True project.

### 7.5.2 Task Force on Modelling of Groundwater Flow and Transport of Solutes

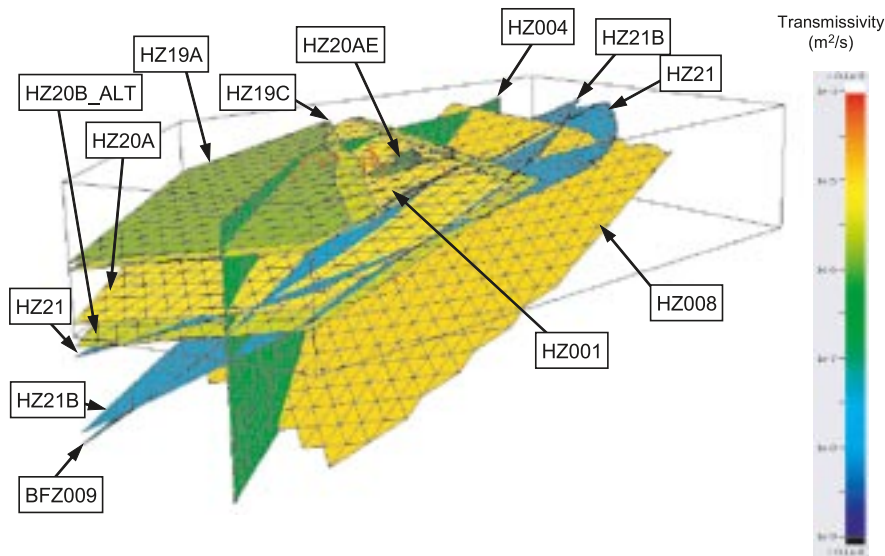
JAEA's participation in the Äspö Task Force on Groundwater Flow and Transport of Solutes during 2007 focused on development of specifications and modelling for sub-task 7A, within the general context of Task 7, Long-Term Pumping Experiment at Olkiluoto, Finland. JAEA's goals from participating in Task 7 include an improved understanding of site characterisation methodologies and of how hydrogeologic model uncertainty can be reduced, in order to understand how the evaluated uncertainty affect parameters relevant for a performance assessment (PA).

#### ***Sub-task 7A – Large Scale Hydro-Test at Borehole KR24, Olkiluoto, Finland***

Sub-task 7A focuses on larger scale issues, related to the geometry and property of fracture zones. The test site is a region of approximately 24 km<sup>2</sup> surrounding borehole KR24 at the Olkiluoto site in Finland. A long-term pumping test was performed in KR24. The test setup included pumping from two borehole sections. The lower part of KR24 was partially isolated using a by-pass packer (throttle valve) so that the deeper sections of the borehole experienced a smaller drawdown than the upper section during the pumping.

During 2007 a team from JAEA implemented a new hydrostructural model for the Olkiluoto site and carried out finite element flow and particle tracking solute transport simulations using the FracMan hybrid discrete fracture network (DFN)/continuum porous media hydrodynamic model. The preliminary implementation of this model was presented at the Task Force meeting in Stockholm, January 2007. Further flow and transport modelling results were presented at the workshop in Gothenburg in June, and the Task Force meeting in Toronto, November 2007.

The JAEA team implemented the Olkiluoto hydrostructural model including most of the open and packed off section of boreholes and fracture zones listed in the sub-task 7A specification (see Figure 7-32). The horizontal spatial extent of the modelling region is about 6×4 km as

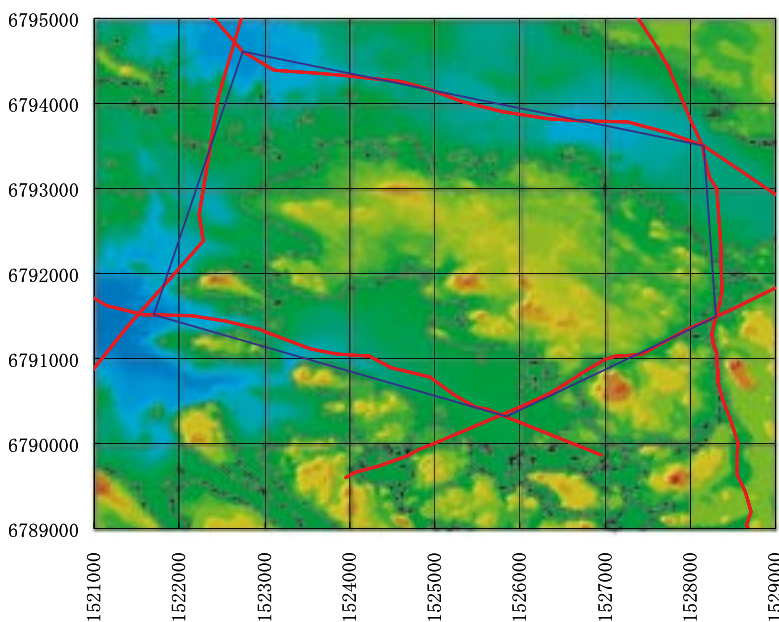


**Figure 7-32.** Fault zones and transmissivity modelled in JAEA hydrostructural model.

shown in Figure 7-33, as defined by regional scale of four vertical fault zones. The vertical extent is from ground surface of Olkiluoto and the Baltic Sea down to the bottom at  $-1,000$  m. Transmissivity, storativity, and aperture for the zones were defined homogeneously at each zone based on the sub-task 7A specification. The shallow portion of the model from the topographic surface down to  $-70$  m under both Olkiluoto and the Baltic Sea was modelled as a continuum porous media using a  $20 \times 20 \times 20$  m scale grid. The hydraulic conductivity of this layer was also assigned according to the sub-task 7A specification.

Boundary conditions were implemented as follows:

- Olkiluoto ground surface: (1) Constant head (=elevation) for Base case, and (2) Infiltration (Phreatic surface) boundary and calibrated to  $5$  mm/y for the calibration cases.
- Baltic sea: constant head (=0).
- Sides and Bottom: no flow.



**Figure 7-33.** Horizontal spatial extent of the model Red line: Regional scale of fault zone defined by sub-task 7A specification Blue line: Simplified pentagon shape of boundary used in the model.

Open boreholes and packed off sections were represented by FracMan’s “group flux” boundary condition, in which flow is allowed to occur through the well to obtain a single steady state head throughout the well, with a zero net flow out of the well. The model concepts are summarized in Figure 7-34. Figure 7-35 illustrates an example of the steady state flow simulation results for SS01 case.

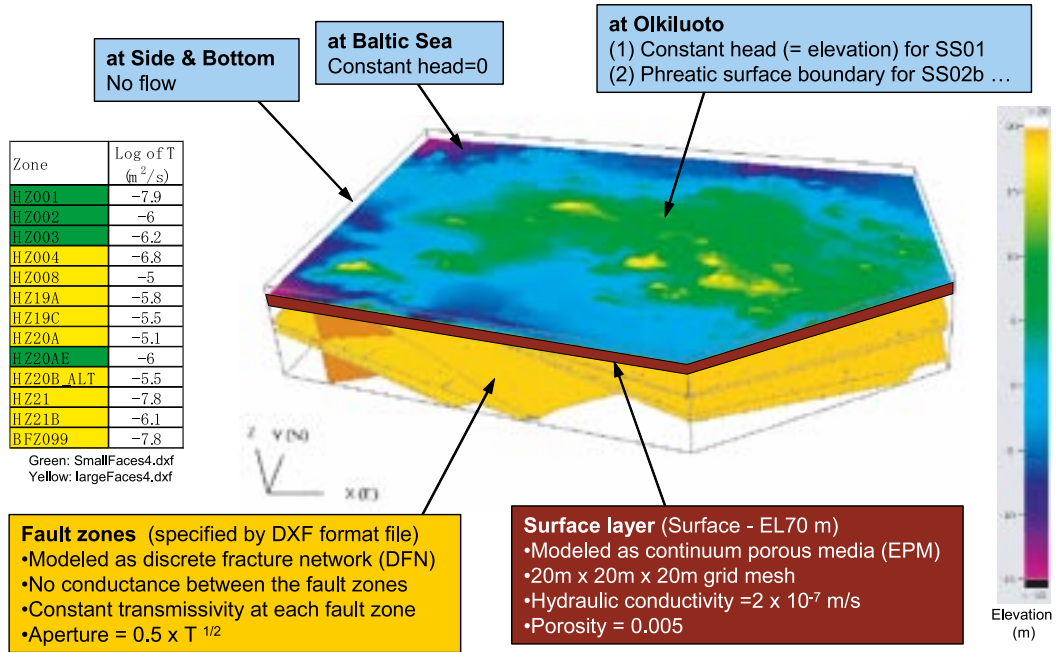


Figure 7-34. Summary of the modelling concepts.

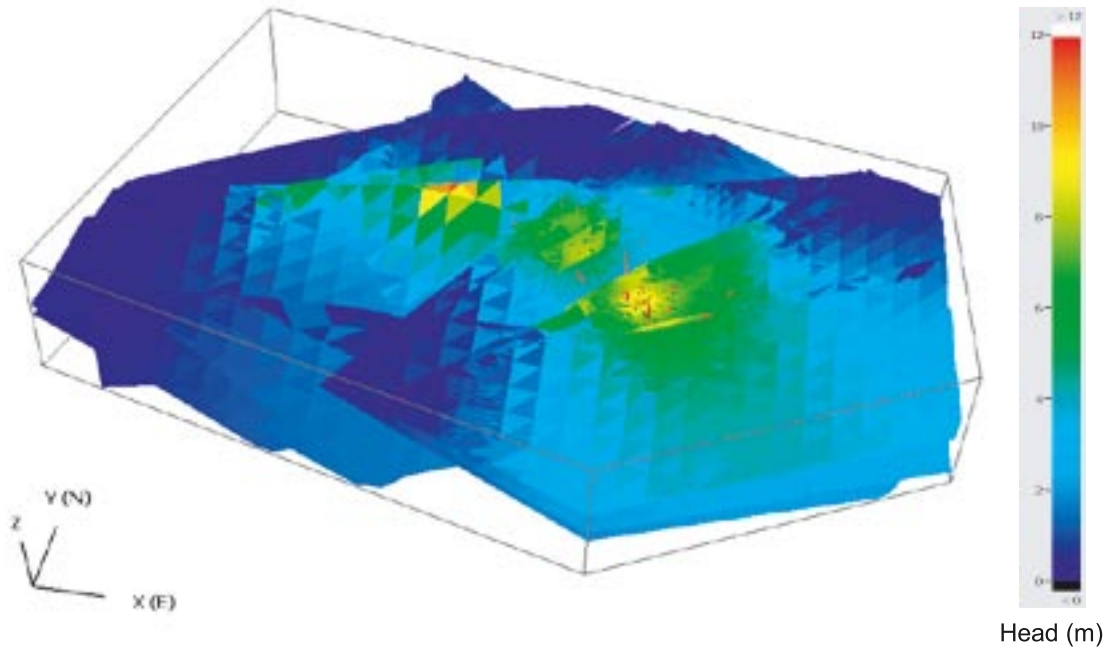


Figure 7-35. An example of steady state flow simulation results. Head distribution at fault zones.

The sub-task 7A simulation cases carried out by the JAEA team during 2007 are shown in Table 7-6. JAEA carried out both base case and sensitivity simulations. Cases SS02b and SS04b are primarily calibration cases matching measured and modelled head and flow distribution along the boreholes. JAEA's sensitivity studies therefore focus on the uncertainty of fault zone's transmissivity, which is one of the key parameters affecting the head and flow distribution.

**Table 7-6. Selected cases for JAEA team studies for sub-task 7A, with basic plan for the simulations and check points at each case.**

Case Name	Description	Forward/ Inverse	Boreholes	Basic plan for simulations	Check points
SS01	Steady state flow conditions without pumping	Forward	No boreholes	Reference K and T Constant head at Olkiluoto ground surface No flow borehole model	Infiltration rate through Olkiluoto ground surface Head distribution along boreholes
SS02a	Steady state flow conditions with open boreholes	Forward	Boreholes are open and free to cross-flow.	Reference K and T Constant head at Olkiluoto ground surface Free to cross-flow borehole model	Infiltration rate through Olkiluoto ground surface Head distribution along boreholes Flow distribution along boreholes (PFL)
SS02b	Steady state flow conditions with open boreholes	Inverse	Boreholes are open and free to cross-flow.	Infiltration (Phreatic surface) boundary at Olkiluoto ground surface and calibrated to 5 mm/y  <b>Sensitivity cases</b> Change T of fault zones	Head distribution along boreholes Flow distribution along boreholes (PFL) Head distribution along boreholes Flow distribution along boreholes (PFL)
SS02c	Steady state flow conditions without pumping	Based on SS02b	No boreholes	Best case of SS02b No flow borehole model	Head distribution along boreholes
SS03	Steady states flow with extraction from KR24	Forward	KR24 only	Pumping from KR-24 with flowing borehole model No flow borehole model for others	Head distribution along boreholes Flow rate at KR24
SS04a	Steady states flow with extraction from KR24	Forward	KR24 + monitoring boreholes	Free to cross-flow borehole model Pumping from KR-24	Head distribution along boreholes Flow rate at KR24 Flow distribution along boreholes (PFL)
SS04b	Steady states flow with extraction from KR24	Inverse	KR24 + monitoring boreholes	<b>Sensitivity cases</b> Change T of fault zones	Head distribution along boreholes Flow rate at KR24 Flow distribution along boreholes (PFL)
PA01	Transport pathway simulation from KR24 to discharge under PA relevant BCs		No boreholes	Particle tracking from each release point along KR24	Statistics of the travel time

**Table 7-7. Transmissivity of each fault zone of the sensitivity cases for SS02b and SS04b.**

Fault zone	Log of Transmissivity (m <sup>2</sup> /s)		Selected uncertain range	Sensitivity analysis cases					
	Geometric mean	Standard deviation		T1 (19 max)	T2 (19 min)	T3 (20 max)	T4 (20 min)	T5 (21 max)	T6 (21 min)
HZ19A	-5.8	1.6		<b>-4.2</b>	<b>-7.4</b>	-5.8	-5.8	-5.8	-5.8
HZ19C	-5.5	1.3	± 1.6	<b>-3.9</b>	<b>-7.1</b>	-5.5	-5.5	-5.5	-5.5
HZ20A	-5.1	0.7		-5.1	-5.1	<b>-4.2</b>	<b>-6.0</b>	-5.1	-5.1
HZ20B_ALT	-5.2	0.9	± 0.9	-5.2	-5.2	<b>-4.3</b>	<b>-6.1</b>	-5.2	-5.2
HZ21	-7.8	1.8		-7.8	-7.8	-7.8	-7.8	<b>-6.0</b>	<b>-9.6</b>
HZ21B	-6.1	0.9	± 1.8	-6.1	-6.1	-6.1	-6.1	<b>-4.3</b>	<b>-7.9</b>

In the sub-task 7A specification, the standard deviation of transmissivity at each fault zone was summarized with the recommended value (geometric mean). JAEA studies variations in properties for six major fault zones (HZ19A, HZ19C, HZ20A, HZ20B\_ALT, HZ21 and HZ21B), grouped into three groups based on similarity of location, strike and dip. For each group, a maximum range of uncertainty was estimated from the standard deviation and six sensitivity cases were defined as listed in Table 7-7, varying transmissivity independently.

## 7.6 NWMO

In 2007, Ontario Power Generation (OPG) assigned the SKB/OPG Äspö Project Agreement to the Nuclear Waste Management Organization (NWMO). In 2007, work was performed on behalf of the NWMO by Atomic Energy of Canada Limited (AECL), Université Laval and Intera Engineering. The results of this work are briefly described below. In addition, NWMO also worked with SKB to support development of the backfill (Baclo) project and the proposed Rock Shear Experiment (Rose).

### 7.6.1 Colloid project

The Äspö Colloid Project is evaluating the potential ability of bentonite colloids, released from repository buffer and backfill materials, to facilitate radionuclide transport in Äspö groundwater. In 2007, the NWMO in collaboration with SKB, continued to support bentonite colloid transport experiments at AECL's Whiteshell Research Laboratory using the Quarried Block (QB) sample, a 1×1×0.7 m block of granite containing a single, complex, but well characterized, through-going, variable aperture fracture /Vilks and Miller 2006/. The purpose of this laboratory-scale experimental programme was to improve on the understanding of physical retardation processes that effect bentonite colloid mobility in crystalline rock fractures.

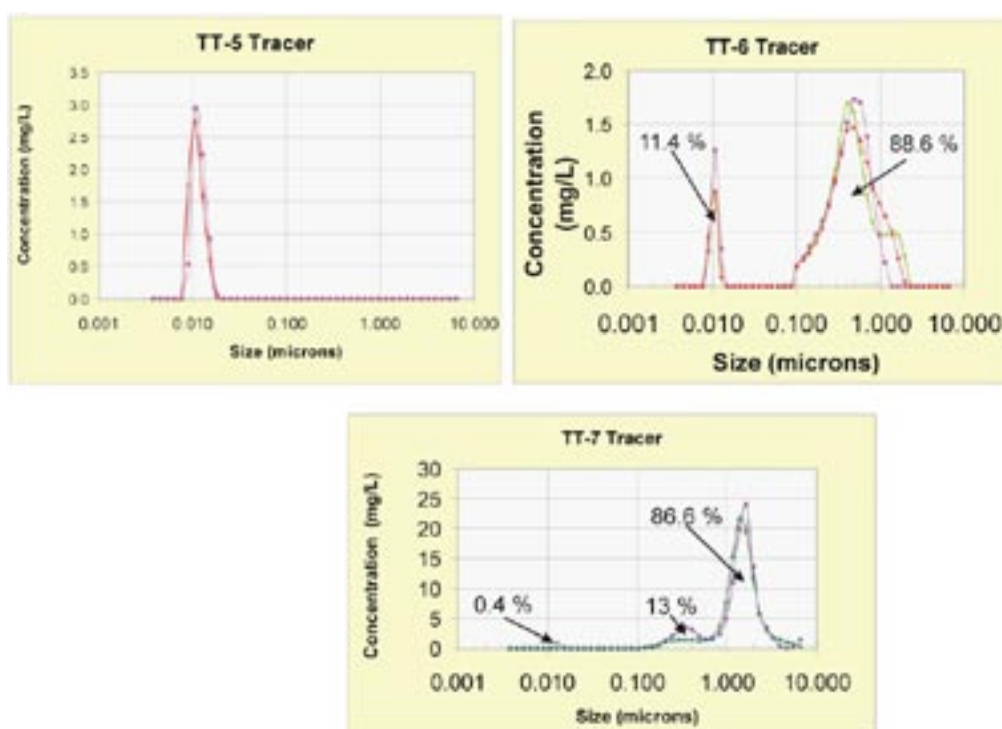
It is important to note that bentonite colloids form a polydisperse solution with particle size distributions that can range from a few nm to approximately 2µm. Through the use of an Ultrafine Particle Size Analyzer (UPA) and a two step analysis process involving the removal of particles larger than 0.1 µm, it was determined that the particle size distributions of the bentonite colloid tracer solutions were bimodal, with peaks at approximately 8 nm and between 200 and 300 nm. A methodology to determine particle size distributions at various points along the elution profiles of tracer tests was applied to better quantify the transport behaviour of various colloid size fractions within the polydisperse solutions.

In 2007, migration experiments were conducted to supplement the results of the 2006 activities reported by /Vilks and Miller 2006/. The work programme included experiments to: a) investigate the transport behaviour of 100 nm latex colloids in saline, Äspö-type water, b) explore the differences in transport behaviour between mono-disperse and polydisperse suspensions of bentonite and latex colloids and c) provide additional colloid transport data over longer transport distances and low transport velocities suitable for future numerical modelling activities by SKB.

Size analysis of the 100 nm latex colloids suspended in the saline solution showed that the latex colloids had formed flocs with an average size of 1.6 µm. This behaviour contributed to significantly different transport behaviour, notably lower tracer recovery, than would be predicted based on behaviour of latex colloids suspended in dilute water.

To explore the transport behaviour of various size fractions within a polydisperse bentonite suspension, a centrifuge based separation process was followed to generate three colloid tracers of increase size fractions that were separately injected into the QB fracture during tests TT-5, TT-6 and TT-7. The bentonite colloid size distributions within each class are illustrated in Figure 7-36. The percent bentonite recovery was the highest for the injection of the small colloids (90%), and progressively decreased to 81% and 13.7% as the proportion of large colloids was increased within the injected tracer solutions. This behaviour is consistent with previous findings and reinforces the observation that bentonite colloid transport is dominated by the smaller particle sizes that remain in suspension while the larger sizes tend to be retained in the fracture.

The final phase of the work programme consisted of opening the QB fracture for post-test analyses that included photographing the distribution of fluorescent latex colloids under ultraviolet light and quantifying colloid deposition on the fracture surfaces using a grid-based swabbing method.

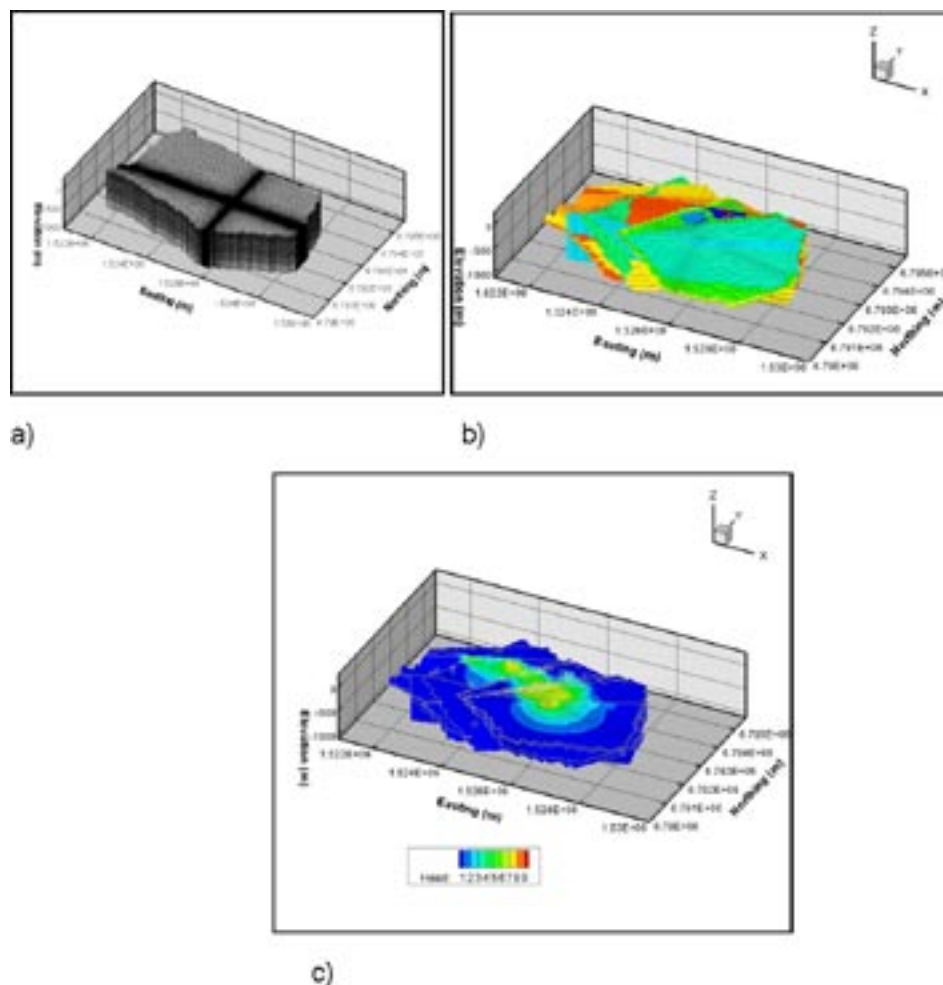


**Figure 7-36.** Bentonite tracer size distributions used in experiments to evaluate the effect of particle size on bentonite colloid transport.

## 7.6.2 Task Force on Modelling of Groundwater Flow and Transport of Solutes

Canada is participating in the Äspö Modelling Task Force's Task 7. A modelling team from the Université Laval is participating in Task 7, which involves the numerical modelling of hydraulic responses in the fractured crystalline rock environment located on Olkiluoto Island in Finland. A large data set is available associated with investigations for Posiva's Onkalo underground rock characterization facility. Task 7 modelling activities have been subdivided into two related sub-tasks: The sub-task 7A is focused on simulating a long-term pump test conducted in borehole KR24, which intersects a domain of several large, interconnected, fracture zones and sub-task 7B involves simulating hydraulic responses in a series of interference tests completed at a block scale with borehole separations on the order of 10 m and with the intention of characterizing the rock mass between the large 7A fracture zones. One of the unique aspects of the data set is that it includes Posiva Flow Log (PFL) measurements in several open boreholes, both prior to and during the hydraulic tests.

In 2007, the Laval modelling team has participated in two task force meetings (in Stockholm, Sweden and in Toronto, Canada) and one modellers meeting (Chalmers University in Gothenburg, Sweden). Modelling activities in the Äspö Modelling Task Force focused on completion of sub-task 7A and preliminary definition of sub-task 7B. New FRAC3DVS model development methodologies applied in 2007 allowed for a more realistic representation of 2D irregular fracture zones within a regular 3D mesh and allowed for improved simulations of the KR24 pump test. An example of modelling results is shown in Figure 7-37.



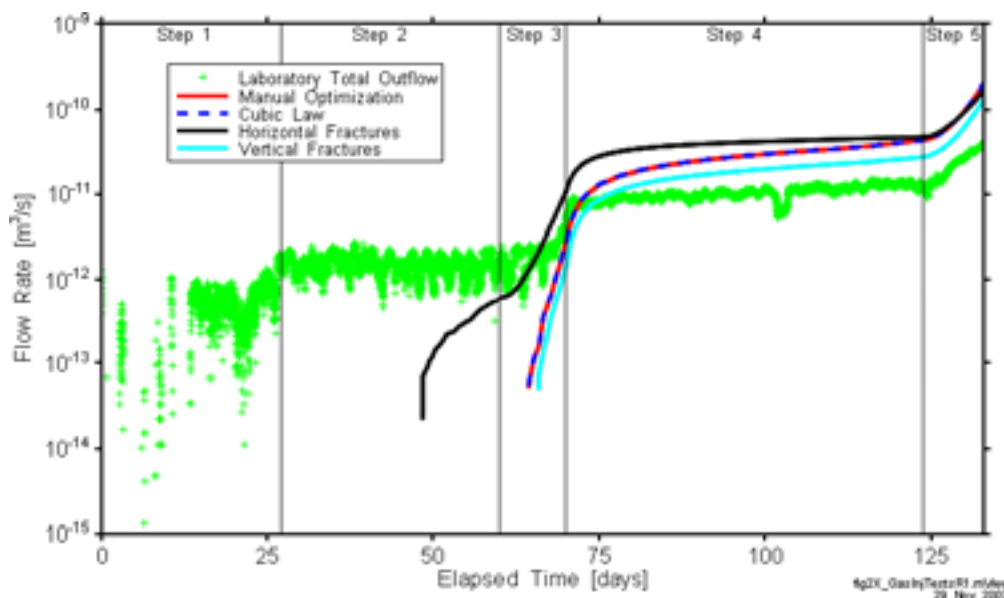
**Figure 7-37.** Example sub-task 7A modelling results: a) FRAC3DVS model grid, b) fracture zones represented as 2D elements and c) head change (m) in fracture zone elements.

Simulations for sub-task 7A have demonstrated the impact of deep, open boreholes whose lengths reach several hundred metres. These open boreholes tend to reduce vertical hydraulic gradients in the fractured rock mass by enhancing the equivalent vertical hydraulic conductivity. Calibration to both hydraulic heads and observed PFL flow rates in boreholes has proven challenging for all modelling teams. The Laval team has undertaken simulations of travel time probabilities as a useful alternative methodology for the assessment of travel times and illustration of subsurface pathways, complementing the performance assessment related activities within the Task Force. A Task Force report will be completed in early 2008 to summarize the sub-task 7A results. Task Force activities will also focus on completion of sub-task 7B.

### 7.6.3 Large Scale Gas Injection Test

Gas may be generated by container corrosion. The low permeability of the surrounding buffer will tend to contain this gas near the container. In order to understand the gas behaviour, NWMO is participating in the Large Scale Gas Injection Test (Lasgit) at SKB's Äspö Hard Rock Laboratory. In particular, NWMO is providing gas transport modelling of the experiment through Intera Engineering, using the Tough2 code. Modifications have been done to the code to simulate anticipated gas transport mechanisms, mainly micro- and macro- fracturing of the bentonite, by allowing pressure-induced changes to the bentonite permeability and capillary pressure.

In 2007, the modified Tough2 model was applied to the MX-80 laboratory-scale experiment of gas transport in bentonite, as well as to the initial test design analysis for the Lasgit experiment prior to availability of gas testing results. The model could simulate a gas breakthrough event through the bentonite obtained in the laboratory experiments. Different model options (fracture directionality and heterogeneous permeability field) are capable of improving model results, particularly in distributing the gas outflow as observed in the laboratory experiment (Figure 7-38).



**Figure 7-38.** Model gas outflow results comparing the impact of fracture directionality and the capillary pressure function with a laboratory-scale test. (Note that the lab outflow prior to Step 3 is primarily liquid outflow.)



Also, 2007 modelling of the Lasgit test design has examined the sensitivity of the results to certain model parameters. Two-phase flow parameters of importance include bentonite permeability, initial gas saturation, and host rock permeability; modified permeability parameters of importance include the pressure-induced factor and residual liquid saturation for the relative permeability function. Once results of the preliminary gas injection tests are available, our modelling will focus on these parameters and will also examine the influence of fracture directionality and heterogeneous permeability fields in the Lasgit borehole.

In the next few years, results from the full set of gas injection tests will be available. Comparison of our modified Tough2 modelling results with the gas injection test observations and with the modelling results from other organisations will increase our understanding of gas transport through bentonite and will improve our modelling capability in future performance assessments.

#### **7.6.4 Task Force on Engineered Barrier Systems**

NWMO is represented by AECL on the Engineering Barrier Systems Task Force. In 2007, AECL provided the Task Force with a detailed description of two full-scale in situ tests of buffer materials previously conducted at AECL's Underground Research Laboratory in Canada in order to evaluate the effectiveness of numerical models in predicting the evolution of coupled processes in unsaturated clay-based materials.

The Buffer/Container Experiment consisted of a full-sized electric heater to simulate a used fuel container installed in a vertical borehole in granite surrounded by a clay-based buffer (Figure 7-39). The Isothermal Test consisted of an identical vertical borehole filled with clay-based buffer designed to investigate the hydraulic effects without a thermal gradient.

AECL conducted coupled thermo-hydro-mechanical (THM) numerical simulations of the evolution of the Buffer/Container Experiment (BCE) and the Isothermal Test (ITT) using Code\_Bright and compared the simulations with measured data from the in situ experiments /Guo 2007/ (Figure 7-40). The Code\_Bright simulations included the following results for the BCE:

- Temperatures modelled in the rock and in the buffer matched the measured data reasonably well at most of the sampled locations;
- Thermally-induced moisture movement in the buffer captured the main characteristics of this phenomena including saturation of the buffer near the surface of the borehole at the mid height of the heater; and
- Rock displacement in response to the heating agreed reasonably well with measured data.

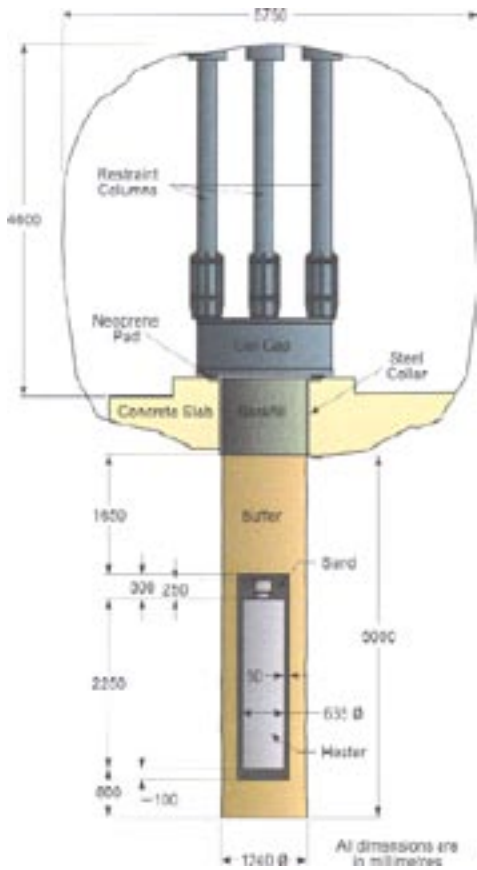


Figure 7-39. Layout and dimensions of the Buffer/Container Experiment /Guo 2007/.

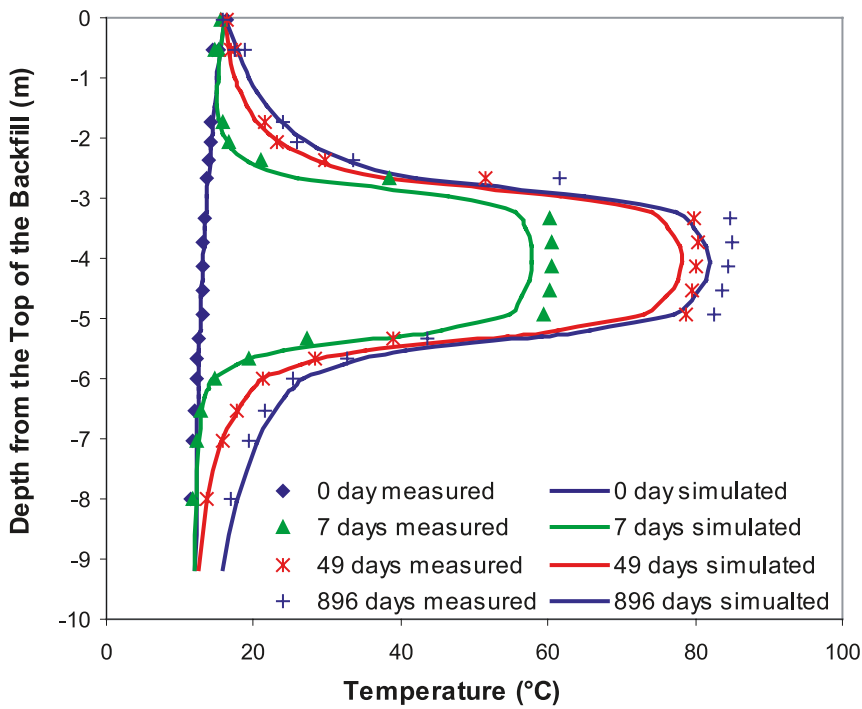


Figure 7-40. Buffer/Container Experiment: Simulated and Measured Temperatures through the borehole centre using Code\_Bright /Guo 2007/.

## 7.7 Posiva

Posiva's co-operation with SKB has been continued with the co-operation agreement signed in the autumn of 2006. The focus of the co-operation has been on encapsulation and repository technology and on bedrock investigations.

Posiva also contributed to several research projects within Natural barriers. The implementation and construction of the underground rock characterisation facility Onkalo at Olkiluoto in Finland offered possibilities to co-operate within the research and development of underground construction technology. Posiva participated in the following projects:

- Task Force on Modelling of Groundwater Flow and Transport of Solutes
- Prototype Repository
- Long Term Test of Buffer Materials
- Alternative Buffer Materials
- KBS-3 Method with Horizontal Emplacement
- Large Scale Gas Injection Test
- Cleaning and Sealing of Investigation boreholes
- Task Force on Engineered Barrier Systems
- Sealing of Tunnel at Great Depth

Posiva's co-operation is divided between Äspö HRL and more generic work that can lead to demonstrations in Äspö HRL. The work performed during 2007 is described below.

### 7.7.1 Task Force on Modelling of Groundwater Flow and Transport of Solutes

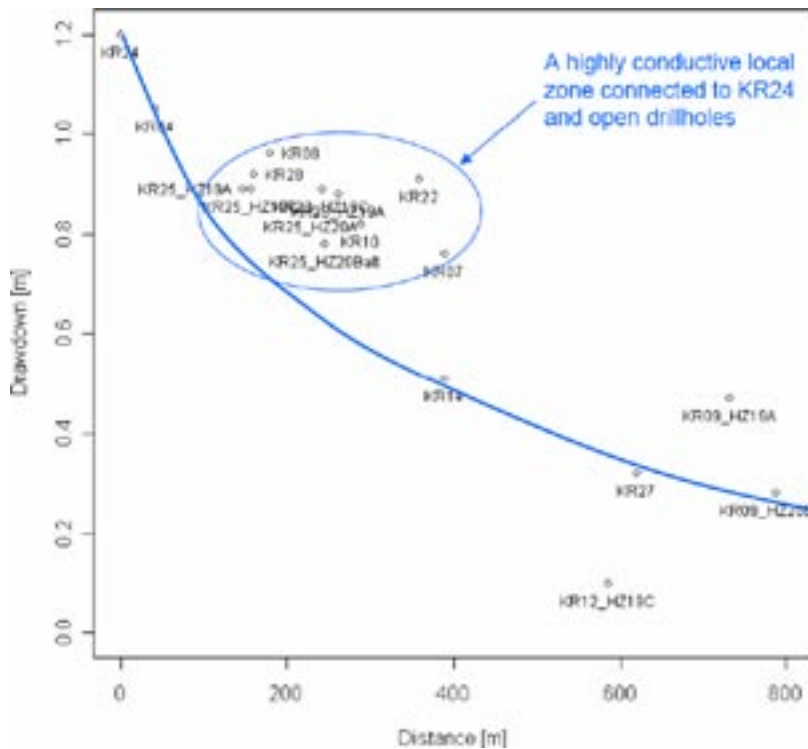
Äspö Task Force Task 7 is an ongoing project exploring whether and how the Posiva Flow Log (PFL) measurements can reduce the uncertainty in performance assessment. In more practical words, the task approaches the problem with modelling the site scale pumping test that was carried out at borehole OL-KR24 in 2004, before the commencement of the excavation of the Onkalo underground research and development facility. The responses of the pumping test were detected with the PFL in a number of open boreholes, together with pressure responses also in packed-off boreholes.

In 2007, Posiva/VTT's (Technical Research Centre of Finland) contribution to Äspö Task Force Task 7 consisted in the calibration of the transmissivities of hydrogeological zones at the Olkiluoto site. This has been achieved with properly adjusting the effective values of the transmissivities of the dominant hydrogeological zones (HZ19 and HZ20 systems). On the other hand, as the flow responses, measured with the PFL DIFF device, are greatly sensitive to the local properties in the vicinity of the boreholes, the calibration against the flow observations was obtained with locally changing, or conditioning to the transmissivities at the boreholes. Posiva/VTT also developed a sophisticated statistical automatic calibration and uncertainty/sensitivity evaluation technique based on the so-called ensemble Kalman filtering method.

A careful examination of the responses strongly implied that the flow system in the pumping test was dominated by a single hydrogeological zone, which was named HZ19C in the Site Descriptive Model that was developed in 2006. On the other hand, the responses were also transmitted by the open boreholes (Figure 7-41).

### 7.7.2 Prototype Repository

The study aims within the Prototype Repository project are to perform geochemical data-interpretation, and modelling in collaboration with SKB. Data collection is the first step to



**Figure 7-41.** Pressure head drawdown as a function of the distance from the pumping borehole in the long term pumping test that was carried out in borehole OL\_KR24 at Olkiluoto in 2004.

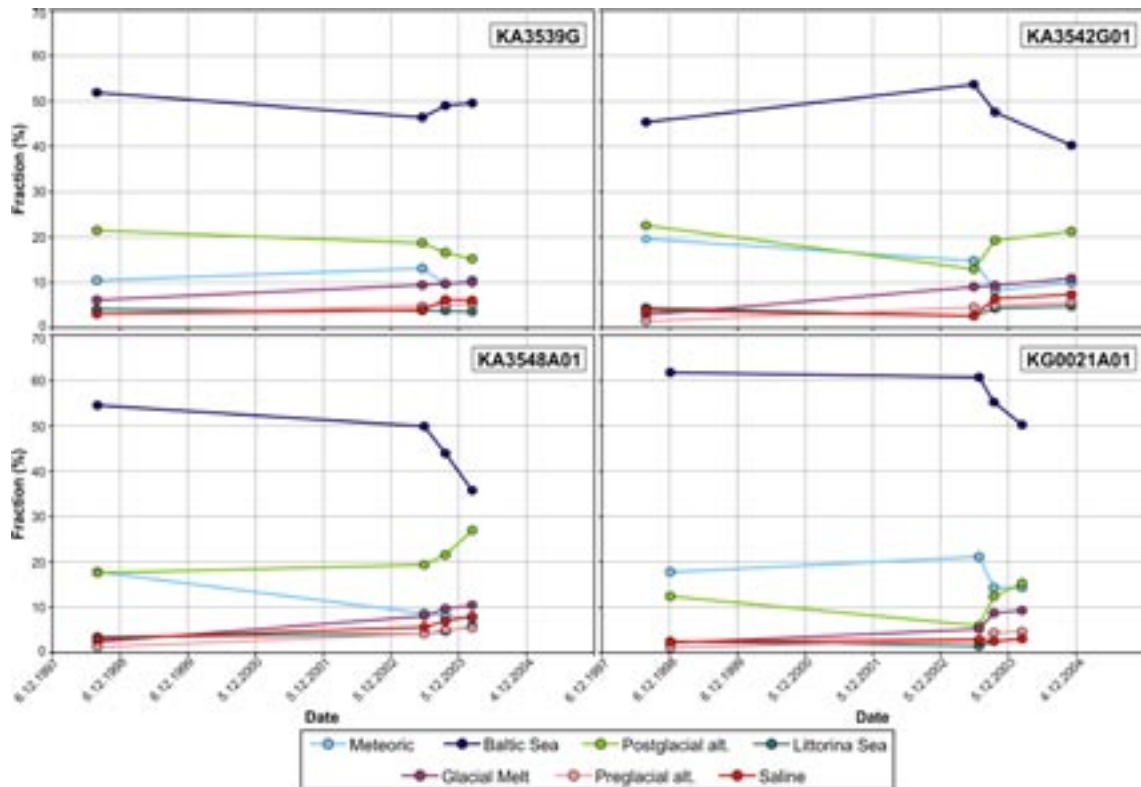
geochemical understanding of the engineered barrier system. The growing knowledge of geochemical processes is the way to more adaptive modelling attempts for the complete repository system.

A set of geochemical data from the Prototype surroundings has been available for geochemical interpretations. Furthermore, during late 2007, a small set of results became available from the Prototype Repository tunnel backfill porewater.

Consequently, the studies during year 2007 concentrated to the available groundwater geochemical samplings done in time-series at several locations in the Prototype near-field bedrock. These sampling results were interpreted with an inverse modelling approach that is implemented within the Phreeqc-2 hydrogeochemical modelling code. The main purpose of the inverse modelling was to find mixing fractions of identified reference water types in the collected samples. Calculations produce also mass-transfer results that indicate net amount of geochemical reactions needed for reproduction of individual samples.

The modelling results indicate that the fracture system surrounding the Prototype Repository is connected to the bottom of the Baltic Sea (Figure 7-42). Assumptions can be made on the fracture systems towards the water sources, e.g. on the hydraulic conductivities and zone geometries, and on the channelling of the groundwater flow within fracture zones.

A short survey of the tunnel backfill porewater results were done as well. It is indicated that groundwater infiltration into tunnel backfill results in strong changes in major cation ratios of porewater. Gypsum likely dissolves from the backfill resulting in significant sulphate level rise within the porewater. Calculations also indicate slight dissolution of  $\text{SiO}_2$  and iron oxyhydroxides, and small consumption of organic matter as a result of bacterial activity. Calculations predict calcite precipitation into the tunnel backfill. The salinity rise within the porewater is likely related to the saturation of the bentonite i.e. uptake of water in the montmorillonite interlayers resulting in rising salinity in the residual porewater.



**Figure 7-42.** Selected water fraction time-series from the Prototype near-field. The evolution of reference water mixing fractions are shown with lines.

### 7.7.3 Long Term Test of Buffer Material

Posiva's task in the Long Term Test of Buffer Material project is to study the porewater chemistry in the bentonite. The task is carried out at VTT. The aim of the work is to obtain data on the chemical conditions which develop in the bentonite considering the effect of temperature, additives and rock features. The study gives information about the chemical processes occurring in the bentonite, but also supports the other planned studies of the chemical conditions.

In the year 2007, preparations were done for a detailed study of CEC in bentonite, because a systematic increase of the CEC was noticed in the analyses performed by Clay Technology AB on the samples of the parcel A2. The experimental work will be realised in the year 2008. Preparations of the common report of all the participants on the parcel A2 were continued during 2007.

### 7.7.4 Alternative buffer materials

Posiva joined the Alternative Buffer Material (ABM) project in the year 2007. The clay materials of interest in the Posiva's studies are MX-80, Deponit, Asha and Friedland Clay. The focus of the work to be carried out at VTT is on the chemical processes occurring in the bentonites. During 2007, work comprised studies with the reference materials. The aim of those studies is to get information about the materials before they have been in the field experiment and to test the research methods, which will be used when the packages have been retrieved. Laboratory experiments have been started with the bentonite materials of ABM in order to study the total porosity and the porosity available for chloride as a function of clay density and dissolving components, pH and Eh in the porewater.

### **7.7.5 Cleaning and Sealing of Investigation Boreholes**

The Phase 3 of the joint SKB and Posiva programme was finished in 2007. Reports for the four sub-projects as well as a final report for the Phase 3 have been completed. The final report will be published in the report series of SKB and Posiva.

A status seminar of Phase 3 was held with SKB and Posiva representatives in February to go through the status of the borehole sealing programme and to discuss and initiate planning of its continuation.

The Joint Work Programme (JWP) on Borehole Sealing was signed between SKB and Posiva commencing the Phase 4. The programme consists of following issues:

- Developing a conceptual plugging plan for selected boreholes.
- Detailed design for implementation.
- Testing and demonstration work.
- Performance Assessment.
- QC/QA.

The borehole OL-KR29 to be sealed in the future as part of the final closure, was selected for the conceptual design. The borehole represents typical rock conditions of the site and it is variable enough from the geological, structural and hydrogeological points of view.

### **7.7.6 Task Force on Engineered Barrier Systems**

Äspö HRL International Joint Committee has set up a Task Force on Engineered Barrier Systems (EBS) which objective is to develop effective tools for analysis of THM(C) behaviour of buffer and backfill. The objective of the year 2007 was to improve capabilities of simulating the THM behaviour of the EBS in the KBS-3V concept. The computer code used in the simulations by Posiva was FreeFEM++. The purpose of the work was to start the simulations of the THM Benchmark 2. The THM Benchmark 2 is divided into two parts: AECL's isothermal test and buffer/container experiment simulation (Benchmark test 2.1) and SKB's canister retrieval test (Benchmark test 2.2).

The AECL's full scale isothermal test (ITT) and The Buffer/Container Experiment investigated how the heat from used fuel affects the performance of the dense bentonite-sand buffer that has been proposed for use around the container in one repository concept. The tests were run for several years and were very thoroughly instrumented and documented and constitute therefore a very good benchmark test. The problem in the viewpoint of KBS-3V simulations is that the rock in these tests was very homogeneous and practically unfractured, so that the change in the water content was very small, and, furthermore, the montmorillonite content of the buffer material was relatively low.

The task in one Benchmark test (Canister Retrieval Test in Äspö HRL) was to simulate the resaturation phase of SKB's canister retrieval test (CRT). The task description was finished in November 2007, and the simulation will take place in 2008.

The Posiva Team's simulation results of other Benchmark test (URL tests Buffer/Container Experiment and Isothermal Test, AECL) were difficult to compare to the measurements, because the low water inflow makes the relative errors big. The most important outcome of the simulations was the increase in confidence of the thermodynamic approach to the THM-modelling.

### **7.7.7 Sealing of Tunnel at Great Depth**

Posiva has implemented R20 programme for groundwater inflow management in ONKALO-facility. One Task is to prepare a suitable grouting process that fulfils the requirements arising from long-term safety considerations. Posiva's participation to the "Sealing of tunnel at Great Depth" has taken place as information exchange regarding the grouting materials and techniques.

### **7.7.8 KBS-3 Method with Horizontal Emplacement**

At the end of 2001 SKB published a RD&D programme for the KBS-3 method with horizontal emplacement. The RD&D programme /SKB 2001/ which is divided into four parts: Feasibility study, Basic design, Demonstration of the concept at Äspö HRL and Evaluation is carried through by SKB in co-operation with Posiva. The development of the deposition equipment is partly funded by the European Commission Esdred (Engineering Studies and Demonstration of Repository Design) Programme for studies on deposition equipment during the 2002–2006 period, see Section 4.8.

## **7.8 Enresa**

SKB and Empresa Nacional de Residuos Radioactivos, S.A. (Enresa) signed a project agreement in February 1997 covering the co-operation for technical work to be performed in the Äspö HRL. Both parties renewed the agreement in January, 2002. Due to the decision taken in the Spanish parliament in December 2004 to focus on a central interim storage of spent nuclear fuel before 2010, Enresa in 2004 chose not to renew this agreement and have now left the central and active core of participants.

Enresa is, however, still participating in the Temperature Buffer Test in Äspö HRL. Enresa is also co-ordinating the integrated project Esdred within the 6<sup>th</sup> EU framework programme. Some of the demonstration work of the integrated project Esdred is carried out in Äspö HRL.

## **7.9 Nagra**

The Nationale Genossenschaft für die Lagerung Radioaktiver Abfälle (Nagra) has the task to provide scientific and technical basis for the safe disposal of radioactive waste in Switzerland. Nagra has had agreements with SKB for participation in Äspö HRL since 1994 to include mutual co-operation and participation in Äspö HRL and Grimsel Test Site projects. The last agreement expired 2003 and Nagra has now left the central and active core of participants.

Nevertheless, Nagra supports the Äspö activities and participates in specific tasks as shown below.

### **7.9.1 Alternative Buffer Materials**

Samples from the Long Term Test of Buffer Material were analysed by University of Berne and porewater extracted from the bentonite has been characterised. The results were presented in the Workshop in Lund in November 2007.

## **7.9.2 Task Force on Engineered Barrier Systems**

Nagra has participated in the modelling meetings. In addition, Nagra is supporting the newly formed group for the geochemical aspects within the Task Force on Engineered Barrier Systems. In 2007, Nagra sponsored the participation of foreign experts to the meetings and supported the overall management of this group via University of Bern.

## **7.10 Rawra**

Radioactive Waste Repository Authority (RAWRA) in Czech Republic has been involved in experimental and/or modelling tasks. RAWRA is represented by three teams: Czech Technical University (Center of Experimental Geotechnics – CEG), Technical University Liberec (TUL) and Nuclear Research Institute Rez (NRI). In 2007, the activities were concentrated on modelling of Canister Retrieval Test, hydromechanical and gas transport modelling.

### **7.10.1 Alternative Buffer Materials**

Experiments are performed with the aim of supporting model development, especially the gas migration models. In the experiments, compacted bentonite excavated from the Czech site Rokle is used.

### **7.10.2 Task Force on Engineered Barrier Systems**

The work of CEG has focused on development and verification of mathematical models of processes inside a deep repository including their implementation. The inputs are processed using the results of Canister Retrieval Test experiment. A final report has to be finished by the end of 2008.

The objective of TUL's activities is to study thermo-hydro-mechanical processes in engineering barriers of the geological repository. Numerical models were calibrated using results from laboratory or in situ experiments. Later the models were used to interpret experimental results. The model is based on the assumption that water is present in two phases – vapour in pores and sorbed (interlamellar) vapour in solid grains. Non-equilibrium exchange between vapour and sorbed water is controlled by a sorption curve. The simulation code is implemented in the Java language.

Parameter calibration for Benchmark test 1.1.3 laboratory experiment (on Febex bentonite) was done using the code Ucode enabling automatic optimisation. A much better fit was obtained than in the former steps. First results were put out in the thermal simulation of a 3D problem representing the in situ experiment Benchmark test 2.1 (“Buffer Container Experiment” in Canada), but the fit is not satisfactory yet.

NRI provided a set of experiments necessary as an input to gas transport modelling. These experiments were compared to those of the benchmark tests. As a partial conclusion it was stated that when the gas pressure increases slowly, it is difficult to predict the value of breakthrough pressure. The breakthrough shows to be chaotic and a substantial fraction of pore water can be expelled from the material. By transport pathways closure, water is sucked in back and as a consequence, the structure of bentonite changes and the possibility of transport pathways closure is limited.

It is proposed to perform additional experiments that will be optionally evaluated using GoldSim and Tough2 codes.



## 8 Literature

### 8.1 References

- Albrecht Gary A M, Blanc S, Rochel N, Ocakatan A Z, Abdallah M A, 1994.** Bacterial iron Transport: Coordination Properties of Pyoverdine PaA, a Peptidic Siderophore of *Pseudomonas aeruginosa*. *Inorg Chem* 33, 6391–6402.
- Anderson C, Jakobsson A M, Pedersen K, 2006a.** “Influence of in situ biofilm coverage on the radionuclide adsorption capacity of subsurface granite”, *Environmental Science and Technology*, vol. 41, no. 3, pp. 830–836.
- Anderson C, Jakobsson A M, Pedersen K, 2006b.** Autoradiographic comparisons of radionuclide adsorption between subsurface anaerobic biofilms and granitic host rocks. *Geomicrobiology Journal* 23, 15–29.
- Anderson C R, James R E, Fru E C, Kennedy C B, Pedersen K, 2006c.** In situ ecological development of a bacteriogenic iron oxide-producing microbial community from a subsurface granitic rock environment, *Geobiology*, vol. 4, pp. 29–42.
- Anderson C R, Pedersen K, 2003.** In situ growth of *Gallionella* biofilms and partitioning of lanthanids and actinides between biological material and ferric oxyhydroxides. *Geobiology* 1, 169–178.
- Andersson P, Byegård J, Billaux D, Cvetkovic V, Dershowitz W, Doe T, Hermanson J, Poteri A, Tullborg E L and Winberg A (ed) 2006.** True Block Scale Continuation Project, Final report. SKB TR-06-42, Svensk Kärnbränslehantering AB.
- Andersson P S, Wasserburg G J, Chen J H, Papanastassiou D A, Ingri J, 1995.** U-238-U-234 and TH-232-TH-230 in the Baltic Sea and in river water *Earth and Planetary Science Letters* 130 (1–4): 217–234 1995.
- Andersson J C, 2007.** Äspö Pillar Stability Experiment, final report. Rock Mass Response to Coupled Mechanical Thermal Loading. SKB TR-07-01, Svensk Kärnbränslehantering AB.
- Barcena I, Garcai Sineriz J L, 2001.** Prototype Repository. System for Canisters Displacement Tracking. SKB IPR-02-06, Svensk Kärnbränslehantering AB.
- Bath A, Milodowsk A, Ruotsalainen P, Tullborg E L, Cortés Ruiz A, Aranyossy J F, 2000.** Evidence from Mineralogy and Geochemistry for the Evolution of Groundwater Systems During the Quaternary for Use In Radioactive Waste Repository Assessment (EQUIP Project). Final Report, Contract No FI4W-CT96-0031. Euratom/EC-DG-Research, Report EUR 19613EN. 157 pp. European Commission, Luxembourg.
- Bono N, Röshoff K, 2003.** Prototype Repository. Instrumentation for stress, strain and displacement measurements in rock. SKB IPR-03-19, Svensk Kärnbränslehantering AB.
- Bouby M, Billard I, Maccordick H J, 1999.** Selective Behaviour of the Siderophore Pyoverdine A towards  $\text{UO}_2^{2+}$ ,  $\text{Th}^{4+}$ ,  $\text{U}^{4+}$  and other Cations. *Czechoslovak J. Phys.* 49, 147–150.
- Byegård J, Johansson H, Skålberg M, Tullborg E L, 1998.** The interaction of sorbing and non-sorbing tracers with different Äspö rock types. Sorption and diffusion experiments in the laboratory. SKB TR-98-18, Svensk Kärnbränslehantering AB.
- Byegård J, Gustavsson E, Tullborg E L, 2006.** Bedrock transport properties. Data evaluation and retardation model. Preliminary site description Laxemar subarea – version 1.2. SKB R-06-27, Svensk Kärnbränslehantering AB.

- Bäckblom G, Olsson O, 1994.** Programme for tracer retention understanding experiments. SKB IPR 25-94-24, Svensk Kärnbränslehantering AB.
- Börgesson L, Sandén T, 2002.** Prototype Repository. Instrumentation of buffer and Backfill in Section II. SKB IPR-03-21, Svensk Kärnbränslehantering AB.
- Chen J H, Edwards R L, Wasserburg G J, 1986.** U-238,U-234 and TH-232 in seawater Earth and Planetary Science Letters 80 (3–4): 241–251 1986.
- Cheng H, Cvetkovic V, 2005.** Evaluation of the BS2B sorbing tracer tests using the LASAR approach. True Block Scale Continuation Project, Äspö Hard Rock Laboratory. SKB IPR-05-39, Svensk Kärnbränslehantering AB.
- Collin M, Börgesson L, 2002.** Prototype Repository. Instrumentation of buffer and Backfill for measuring THM processes. SKB IPR-02-09, Svensk Kärnbränslehantering AB.
- Cvetkovic V, Cheng H, 2002.** Evaluation of block scale tracer retention understanding experiments at Äspö HRL. True Block Scale Project, Äspö Hard Rocik Laboratory. SKB IPR-02-33, Svensk Kärnbränslehantering AB.
- Cvetkovic V, Cheng H (submitted).** Sorbing tracer experiments in a crystalline rock fracture at Äspö (Sweden): 3. Effect of micro-scale heterogeneity. Manuscript submitted to Water Resour. Res.
- Cvetkovic V, Cheng H, Widestrand H, Byegård J, Winberg A, Andersson P, 2007.** Sorbing tracer experiments in a crystalline rock fracture at Äspö (Sweden): 2. Transport model and effective parameter estimation, Water Resour. Res., 43, W11421, doi:10.1029/2006WR005278.
- Eden P, Björklund A, 1994.** Ultra-low density sampling of overbank sediment in Fennoscandia. JOURNAL OF GEOCHEMICAL EXPLORATION 51 (3): 265–289 SEP 1994.
- Ekendahl S, O'Neill A H, Thomsson E, Pedersen K, 2003.** Characterisation of yeasts isolated from deep igneous rock aquifers of the Fennoscandian Shield, Microbial Ecology, vol. 46, pp. 416–428.
- Essén S A, Johnsson A, Bylund D, Pedersen K, Lundström U S, 2007.** Siderophore production by *Pseudomonas stutzeri* under aerobic and anaerobic conditions, Applied and Environmental Microbiology, vol. 73, no. 18, pp. 5857–5864.
- Ferris F G, Konhauser K O, Lyuvén B, Pedersen K, 1999.** Accumulation of metals by bacteriogenic iron oxides in a subterranean environment. Geomicrobiology Journal 16, 181–192.
- Ferris F G, Hallberg R O, Lyvén B, Pedersen K, 2000.** Retention of strontium, cesium, lead and uranium by bacterial iron oxides from a subterranean environment. Applied Geochemistry 15, 1035–1042.
- Forsmark T, 2007.** Prototype Repository. Hydraulic tests and deformation measurements during operation phase. Test campaign 7. Single hole tests. SKB IPR-07-02, Svensk Kärnbränslehantering AB.
- García García S, Jonsson M, Wold S, 2006.** Temperature effect on the stability of bentonite colloids in water. J. Colloid Interface Sci., (2006), 298(2), 694–705.
- Garcia Garcia S, Wold S, Jonsson M, 2007.** Kinetic determination of critical coagulation concentrations for sodium- and calcium-montmorillonite colloids in NaCl and CaCl<sub>2</sub> aqueous solutions. J. Colloid Interface Sci. (2007), 315(2), 512–519.
- Geipel G, Acker M, Vulpius D, Bernhard G, Nitsche H, Fanghänel Th, 2004.** An Ultra fast Time-Resolved Fluorescence Spectroscopy System for Metal Ion Complexation Studies with Organic Ligands. Spectrochim. Acta 60, 417–424.

- Glorius M, Moll H, Bernhard G, 2007.** Complexation of uranium(VI) with aromatic acids in aqueous solution – A comparison of hydroxamic acids and benzoic acid. *Radiochim. Acta* 95, 151–157.
- Glorius M, Moll H, Geipel G, Bernhard G, 2008a.** Complexation of uranium(VI) with aromatic acids such as hydroxamic and benzoic acid investigated by TRLFS. *J. Radioanal. Nucl. Chem.*, in press.
- Glorius M, Moll H, Bernhard G, 2008b.** Complexation of Curium(III) with Hydroxamic Acids Investigated by Time-Resolved Laser-Induced Fluorescence Spectroscopy. *Polyhedron*, submitted.
- Goudarzi R, Åkesson M, Hökmark H, 2007.** Äspö Hard Rock Laboratory. Temperature Buffer Test. Sensors data report (period 030326–070701) Report No:10. SKB IPR-07-21, Svensk Kärnbränslehantering AB.
- Goudarzi R, Johannesson L E, Börgesson L, 2008.** Backfill and Plug test. Sensors data report (Period 990601–070101) Report No:14. SKB IPR-08-02, Svensk Kärnbränslehantering AB.
- Guo S, 2007.** EBS task-force modelling report: modelling AECL's tests – isothermal test and buffer container experiment. Prepared by Atomic Energy of Canada Limited. Nuclear Waste Management Organization report NWMO TR 2007 13. Toronto, Ontario.
- Haveman S A, Pedersen K, 2002.** Microbially mediated redox processes in natural analogues for radioactive waste. *J. Contam. Hydrol.* 55, 161–174.
- Haycox J, Pettitt W, 2006.** Acoustic emission and ultrasonic monitoring results from deposition hole DA3545G01 in the Prototype Repository between April 2006 and September 2006. SKB IPR-06-36, Svensk Kärnbränslehantering AB.
- Hodgkinson D, 2007.** Äspö Task Force on modelling of groundwater flow and transport of solutes. Review of Tasks 6D, 6E, 6F and 6F2. SKB TR-07-03, Svensk Kärnbränslehantering AB.
- Hökmark H, Fälth B, 2003.** Temperature Buffer Test. Predictive Modelling Programme, SKB document F12.1G-1012125, Sweden.
- Hökmark H, Fälth B, Akkeson M, 2004.** TBT, Evaluation Modelling Programme, Step 2, Clay Technology AB. Lund, Sweden.
- Hökmark H, Ledesma A, Lassabatere T, Fälth B, Börgesson L, Robinet J C, Sellali N, Sémété P, 2007.** Modelling heat and moisture transport in the ANDRA/SKB temperature buffer test. *Physics and Chemistry of the Earth*, 32, p753–766.
- Itasca, 2003.** 3DEC – 3 dimensional distinct element code. User's manual. Itasca Consulting Group Inc., Minneapolis.
- Jacobsson L, Bäckström A, 2005.** Uniaxial compression tests of intact rock specimens at dry condition and at saturation by three different liquids: distilled, saline and formation water. SKB IPR-05-33, Svensk Kärnbränslehantering AB.
- Johnsson A, Arlinger J, Pedersen K, Ödegaard Jensen A, Albinsson Y, 2006.** Solid-Aqueous Phase Partitioning of Radionuclides by Complexing Compounds Excreted by Subsurface Bacteria. *Geomicrobiology Journal* 23, 621–630.
- Kersting A B, Efured D W, Finnegan D L, Rokop D J, Smith D K, Thompson L J, 1999.** Migration of plutonium in groundwater at the Nevada Test Site. *Nature*, 297, 7 January, 56–59.
- Kristensson O, Hökmark H, 2007.** Thermal 3D modelling of Äspö Prototype Repository. SKB IPR-07-01, Svensk Kärnbränslehantering AB.

- Kyle J E, Eydal H SC, Ferris F G, Pedersen K, 2008.** Viruses in granitic groundwater from 69 to 450 m depth of the Äspö hard rock laboratory, Sweden. ISME J advance online publication, February 14, 2008; doi:101038/ismej200813 1–4.
- Laaksoharju M, Degeldre C I, Skårman C, 1995.** Studies of colloids and their importance for repository performance assessment. SKB TR 95-24, Svensk Kärnbränslehantering AB.
- Ledesma A, Chen G, Jacinto A, 2005.** TBT – Evaluation Modelling Programme Step 2 (extended version), ENRESA Contribution. UPC, Barcelona, Spain.
- Ledesma A, Jacinto A, Velasco M, 2006.** Temperature Buffer Test, ENRESA contribution, Final report, CIMNE-UPC.
- Löfvendahl R, 1987.** Dissolved Uranium in the Baltic Sea. Marine Chemistry 21 (3): 213–227 1987.
- Magnor B, Hardenby C, Kemppainen K, Eng A, 2007.** Rock Characterisation System – RoCS. Final report – feasibility study, phase I. State-of-the-art in 3D surveying technology. SKB IPR-06-07, Svensk Kärnbränslehantering AB.
- Moll H, Glorius, M, Bernhard G, Johnsson A, Pedersen, K, Schäfer M, Budzikiewicz H, 2008.** Characterization of Pyoverdins Secreted by a Subsurface Strain of *Pseudomonas fluorescens* and their Interactions with Uranium(VI). Geomicrobiology (in press).
- Motamedi M, Pedersen K, 1998.** *Desulfovibrio aespoensis* sp. nov. a mesophilic sulfate-reducing bacterium from deep groundwater at Äspö hard rock laboratory, Sweden, International Journal of Systematic Bacteriology, vol. 48, pp. 311–315.
- Mualem Y, 1976.** A New Model for Predicting the Hydraulic Conductivity of Unsaturated Porous Media, Water Resour. Res., Vol. 12, No. 3, pp. 513–522.
- Nielsen M E, Pedersen K, Fisk M, Istok J, 2006.** Microbial nitrate respiration of lactate at in situ conditions in groundwater from a granitic aquifer situated 450 m underground, Geobiology, vol. 4, pp. 43–52.
- Norman K G, Andersson P, 2007.** Prototype Repository. Tracer dilution tests during operation phase, test campaign 2. SKB IPR-07-03, Svensk Kärnbränslehantering AB.
- Nowak T, 2007.** Äspö Task Force Engineered Barrier System, Modelling of THM-coupled processes for Task 1, Benchmarks 1, using GeoSys/RockFlow. SKB IPR-07-13: 47 p. 30 fig. 3 tab.; Svensk Kärnbränslehantering AB.
- Nyberg G, Jönsson S, Wass E, 2007.** Äspö Hard Rock Laboratory. Hydro monitoring programme. Report for 2006. SKB IPR-07-10, Svensk Kärnbränslehantering AB.
- O’Brien E C, Farkas E, Gil M J, Fitzgerald D, Castineras A, Nolan K B, 2000.** Metal complexes of salicylhydroxamic acid ( $H_2Sha$ ), anthranilic hydroxamic acid and benzohydroxamic acid. Crystal and molecular structure of  $[Cu(phen)_2(Cl)]Cl \cdot x H_2Sha$ , a model for a peroxidase-inhibitor complex. J. Inorg. Biochem. 79, 47–51.
- Painter S, Mancillas J, Cvetkovic V, Pensado O, 2007.** Time-domain particle tracking methods for simulating transport with retention and first-order transformations, Water Resour. Res., 44, W01406, doi:10.1029/2007WR005944.
- Pedersen K, 2000.** The microbe site. Drilling, instrumentation and characterisation. SKB IPR-00-36, pp 1–25, Svensk Kärnbränslehantering AB.
- Pedersen K, 2001.** Diversity and activity of microorganisms in deep igneous rock aquifers of the Fennoscandian Shield. In Subsurface microbiology and biogeochemistry. Edited by Fredrickson J.K. and Fletcher M. Wiley-Liss Inc., New York. pp 97–139.

- Pedersen K, 2002.** Microbial processes in the disposal of high level radioactive waste 500 m underground in Fennoscandian shield rocks. In Interactions of microorganisms with radionuclides. Edited by Keith-Roach M.J. and Livens F.R. Elsevier, Amsterdam. pp 279–311.
- Pedersen K, 2005.** The MICROBE framework: Site descriptions, instrumentation, and characterization. SKB IPR-05-05, pp. 1–85, Svensk Kärnbränslehantering AB.
- Peltola P, Brun C, Åström M, 2008.** High K/Rb ratios in stream waters – exploring plant litter decay, ground water and lithology as potential controlling mechanisms.
- Pruess K, Oldenburg C, Moridis G, 1990.** TOUGH2 USER'S GUIDE, Version 2.0, Earth Sciences Division, Lawrence Berkeley National Laboratory, University of California, Berkeley, California 94720.
- Puigdomenech I, Sandén T, 2001.** Prototype Repository. Instrumentation for gas and water sampling in Buffer and Backfill. Tunnel Section I. SKB IPR-01-62, Svensk Kärnbränslehantering AB.
- Pusch R, 2001.** Prototype Repository. Selection of THMCB models. SKB IPR-01-66, Svensk Kärnbränslehantering AB.
- Pusch R, Svemar C, 2003.** Prototype Repository. Predictive modelling of EBS performance in the Prototype Repository Project. SKB IPR-03-26, Svensk Kärnbränslehantering AB.
- Reitner J, Schumann G A, Pedersen K, 2005.** Fungi in subterranean environments, in: Gadd, G.J. (ed) Fungi in biogeochemical cycles, pp 788–1002, Cambridge University Press, Cambridge.
- Rhén I, Forsmark T, Magnusson, Alm P, 2003.** Prototype Repository. Hydrogeological, Hydrochemical and Temperature Measurements in boreholes during the operation phase of the Prototype Repository Tunnel Section II. SKB IPR-03-22, Svensk Kärnbränslehantering AB.
- Roos M, Åström M, 2005.** Hydrochemistry of rivers in an acid sulphate soil hotspot area in western Finland. *Agricultural and Food Science* 14 (1): 24–33 2005.
- Rothfuchs T, Hartwig L, Komischke M, Mieke R, Wiczorek K, 2003.** Prototype Repository. Instrumentation for resistivity measurements in buffer backfill and rock in Section II. SKB IPR-03-48, Svensk Kärnbränslehantering AB.
- SKB, 2001.** Forsknings-, utvecklings- och demonstrationsprogram för ett KBS-3-förvar med horisontell deponering. SKB R-01-55, Svensk Kärnbränslehantering AB.
- SKB, 2004.** RD&D-Programme 2004. Programme for research, development and demonstration of methods for the management and disposal of nuclear waste. SKB TR-04-21, Svensk Kärnbränslehantering AB.
- SKB, 2006.** Äspö Hard Rock Laboratory. Annual Report for 2006. SKB TR-07-10, Svensk Kärnbränslehantering AB.
- SKB, 2007a.** RD&D-Programme 2007. Programme for research, development and demonstration of methods for the management and disposal of nuclear waste. September 2007, Svensk Kärnbränslehantering AB.
- SKB, 2007b.** Äspö Hard Rock Laboratory. Planning Report for 2007. SKB IPR-07-06, Svensk Kärnbränslehantering AB.
- Smellie J A T, Waberg H N, Frape S K, 2003.** Matrix fluid chemistry experiment. Final report. June 1998-March 2003. SKB R-03-18, Svensk Kärnbränslehantering AB.
- Thorsager P, Lindgren E, 2004.** KBS-3H Summary report of work done during Basic Design. SKB R-04-42, Svensk Kärnbränslehantering AB.

**Van Genuchten M Th, 1980.** A Closed-Form Equation for Predicting the Hydraulic Conductivity of Unsaturated Soils, *Soil Sci. Soc.* , Vol. 44, pp. 892–898.

**Vilks P, Miller N H, 2006.** Laboratory bentonite colloid migration experiments to support the Äspö colloid project. Supporting technical report. 06819-REP-01300-10123-R00. Ontario Power Generation, Canada.

**Waber N H, Smellie J A T, 2008.** Characterisation of Pore Water in Crystalline Rocks, to be published in a Special Issue of *Applied Geochemistry* during 2008.

**Widestrand H, Byegård J, Cvetkovic V, Tullborg E L, Winberg , Andersson P, Siitari-Kauppi M, 2007.** Sorbing tracer experiments in a crystalline rock fracture at Äspö (Sweden): 1. Experimental setup and microscale characterization of retention properties. *Water Resour. Res.*, 43, W10413, doi:10.1029/2006WR005277.

**Zhu B, Hermansson H P, 2007.** Impedansmätningar, dokumentation, provtagning och analys i samband med nedkörning och öppnande av återtagskapseln, Studsvik /N-07-179/.

**Zolezzi F, Haycox J, Pettitt W, 2007.** Acoustic emission and ultrasonic monitoring results from deposition hole DA3545G01 in the Prototype Repository between October 2006 and March 2007. SKB IPR-07-12, Svensk Kärnbränslehantering AB.

**Åkesson M, 2006a.** Temperature Buffer Test. Evaluation modelling – Field Test. SKB IPR-06-10, Svensk Kärnbränslehantering AB.

**Åkesson M, 2006b.** Temperature Buffer Test. Evaluation modelling – Mock-up Test. SKB IPR-06-11, Svensk Kärnbränslehantering AB.

**Åström M, Peltola P, Virtasalo J, Kotilainen A, Salminen, 2008a.** Niobium in boreal stream waters and brackish-water sediments. *Geochemistry: Exploration, Environment, Analyses*.

**Åström M, Peltola P, Rönnback P, Lavergren U, Bergbäck B, Tarvainen T, Backman B and Salminen R, 2008b.** Uranium in surface and ground waters in Boreal Europe. *Geochemistry: Exploration, Environment, Analysis*.

## **8.2 List of papers and articles published 2007**

### ***Colloid project***

**Bouby M Geckeis H, Schäfer T, Lützenkirchen J, Seher H, Bauer A, Plaschke M, Hauser W, Kienzler B, 2007.** Laboratory study on colloid stability and radionuclide-colloid interaction under Äspö groundwater condition. Poster Migration '07. Poster and Oral 3rd Annual Workshop FUNMIG 2007.

**Garcia Garcia S, Wold S, Jonsson M, 2007.** Kinetic determination of critical coagulation concentrations for sodium- and calcium-montmorillonite colloids in NaCl and CaCl<sub>2</sub> aqueous solutions. *J. Colloid Interface Sci.*, 315(2), 512–519.

**Garcia Garcia S, Wold S, Jonsson M, 2007.** pH and temperature effects on the stability of bentonite colloid suspensions. Poster Migration '07.

**Garcia Garcia S, Wold S, Jonsson M, 2007.** Effects of temperature on the stability of montmorillonite colloids at different pH and ionic strength. Submitted for publication.

**Holmboe M, Wold S, Jonsson M, 2007.** Detrimental effects of ionizing radiation on the buffer capacity in a deep bedrock repository for spent nuclear fuel – Effects of  $\gamma$ -irradiation on Na-montmorillonite colloid stability. Submitted for publication.

**Holmboe M, Wold S, Jonsson M, 2007.** Effects of  $\gamma$ -radiation on bentonite suspensions. Implications for bentonite erosion. Poster Migration '07.

**Vilks P, Miller N H, Vorauer A, 2007.** Laboratory bentonite colloid migration experiments to support the Äspö Colloid Project. Submitted for publication.

**Vilks P, Miller N H, Vorauer A, 2007.** Laboratory bentonite colloid migration experiments to support the Äspö Colloid Project. Oral presentation Migration '07.

**Wold S, Eriksen T, 2007.** Diffusion of humic colloids in compacted bentonite. *Physics and Chemistry of the Earth*. 32, 477–484.

### **Microbe project**

**Eriksson S, Jägevall S, Pedersen K, 2007.** Micro-diversity of *Desulfovibrio aespoeensis* and *Acetobacterium carbinolicum* in deep granitic groundwater. *Bacteria and GENetics in ECOlogy (BAGECO)* 9, 23–27 June, Wernigerode, Germany.

**Essén S A, Johnsson A, Bylund D, Pedersen K and Lundström U S, 2007.** Siderophore production by *Pseudomonas stutzeri* under aerobic and anaerobic conditions. *Appl Environ Microbiol* 73, 5857–5864.

**Eydal H S C and Pedersen P, 2007.** Use of an ATP assay to determine viable microbial biomass in Fennoscandian Shield groundwater from depths of 3–1000 m. *J Microbiol Meth* 70, 363–373.

**Kyle J E, Eydal H S C, Ferris F G, Pedersen K, 2008.** Viruses in granitic groundwater from 69 to 450 m depth of the Äspö hard rock laboratory, Sweden. *ISME J* advance online publication, February 14, 2008; doi:101038/ismej200813 1–4.

**Moll H, Johnsson A, Schäfer M, Pedersen K, Budzikiewicz K, Bernhard G, 2007.** Curium(III) complexation with pyoverdins secreted by a groundwater strain of *Pseudomonas fluorescens*. On line first: *Biometals* DOI 101007/s10534-007-9111-x.

**Pedersen K, 2007.** The significance of biogeochemical processes in geological disposal of high level radioactive waste. 9<sup>th</sup> May, Institute of Radiochemistry, Forschungszentrum Rossendorf, Dresden, Germany.

**Pedersen K, 2007.** The significance of biogeochemical processes in geological disposal of high level radioactive waste. 10<sup>th</sup> May, Department of Chemistry, TU Bergakademie Freiberg, Freiberg, Germany.

**Pedersen K, 2007.** Characterisation of diversity and activity of microorganisms in deep aquifers of the Fennoscandian Shield. *International Workshop on Biogeochemical Processes in Groundwater Systems*. September 10–11, GSF-Forschungszentrum für Umwelt und Gesundheit (GmbH), Neuherberg, Germany.

**Pedersen K, Masurat P, Eriksson S, 2007.** Evidence for indigenous sulphate reducing bacteria in commercial MX-80 bentonite. *Workshop on Long-term performance of smectite clays embedding canisters with highly radioactive waste*. 26–28 November, Ideon, Lund Sweden.

**Pedersen K, Masurat P, Eriksson S, 2007.** Microbial sulphide production in compacted Wyoming MX-80 bentonite under in situ conditions relevant for a repository for high level radioactive waste. *Workshop on Long-term performance of smectite clays embedding canisters with highly radioactive waste*. 26–28 November, Ideon, Lund Sweden.

### **Äspö Research School**

**Rönnback P, 2007.** Ph.D thesis: Major and trace elements in surface and ground waters in two near-coastal granitoidic settings in eastern Sweden.

**Rönnback P and Åström M, 2007.** Hydrochemical patterns of a small lake and a stream in an uplifting area proposed as a repository site for spent nuclear fuel, Forsmark, Sweden. *Journal of Hydrology* 344: 223–235.

**Brun C, Åström M, Peltola P, Johansson M B.** Trends in major and trace elements in decomposing needle litters during a long-term experiment in Swedish forests. *Plant and Soil*, accepted.

**Lavergren U, Åström M, Bergbäck, Holmström H.** Mobility of trace elements in black shale assessed by leaching tests and sequential chemical extraction. *Geochemistry: Exploration, Environment, Analysis*, accepted.

**Rönnback P, Åström M.** Concentrations and fractionation patterns of rare earth elements in surface waters and ground waters in a granite and till environment. *Applied Geochemistry*, accepted.

### **Andra**

**Gatabin C, Guillot W, 2007.** Projet ABM\_1 mock-up, Rapport final, CEA, RT DPC/SVCME 07-764-A.

### **BMW**

**Barkleit A, Moll H, Bernhard G, 2007.** Reaction of Uranium(VI) with Lipopolysaccharide – A Laser Spectroscopy Study. Lecture presented at the 11<sup>th</sup> International Conference MIGRATION'07, München, Germany, August 2007; Paper B4-2.

**Glorius M, Moll H, Geipel G, Bernhard G, 2007.** Uranium(VI) Complexation Studies with Selected Aromatic Acids – A Comparison of Different Spectroscopic Techniques. Poster presented at the 11<sup>th</sup> International Conference MIGRATION'07, München, Germany, August 2007; Paper PA3-3.

**Glorius M, Moll H, Bernhard G, 2007.** Complexation of uranium(VI) with aromatic acids in aqueous solution – A comparison of hydroxamic acids and benzoic acid. *Radiochimica Acta* 95, 151–157.

**Glorius M, Moll H, Bernhard G, 2007.** Complexation of U(VI) with aromatic acids having different functionalities studied by UV-vis spectroscopy. *Institute of Radiochemistry Annual Report 2006*, FZR-459, 18.

**Glorius M, Moll H, Bernhard G, 2007.** U(VI) complexation with aromatic acids having different functionalities studied by TRLFS. *Institute of Radiochemistry Annual Report 2006*, FZR-459, 19.

**Moll H, Bernhard G, 2007.** Complex formation of curium with amino acids of different functionalities (L2-amino-butyric acid, L-threonine and O-phospho-L-threonine) studied by TRLFS. *Institute of Radiochemistry Annual Report 2006*, FZR-459, 25.

**Moll H, Bernhard G, 2007.** Complex formation of curium(III) with amino acids of different functionalities: L-Threonine and O-Phospho-L-Threonine. *Journal of Coordination Chemistry* 60(16), 1795–1807.

**Moll H, Bernhard G, 2007.** Complexation of curium(III) with L2-aminobutyric acid investigated by time-resolved laser-induced fluorescence spectroscopy (TRLFS). *Journal of Radioanalytical and Nuclear Chemistry* 274(3), 603–608.



**Moll H, Johnsson A, Glorius M, Geipel G, Pedersen K, Bernhard G, 2007.** Aqueous pyoverdinin species of *Pseudomonas fluorescens* (CCUG 32456 A) investigated by UV-vis and fs-TRLFS. Institute of Radiochemistry Annual Report 2006, FZR-459, 38.

**Moll H, Johnsson A, Glorius M, Pedersen K, Bernhard G, 2007.** The interaction of U(VI) with pyoverdins secreted by a subsurface strain of *Pseudomonas fluorescens* investigated by UV-vis spectroscopy. Institute of Radiochemistry Annual Report 2006, FZR-459, 39.

**Moll H, Johnsson A, Schäfer A, Budzikiewicz H, Pedersen K, Bernhard G, 2007.** Isolation of bioligands secreted by cells of *Pseudomonas fluorescens* (CCUG 32456 A) and their characterization by mass spectrometry. Institute of Radiochemistry Annual Report 2006, FZR-459, 37.

**Moll H, Johnsson A, Schäfer A, Glorius M, Pedersen K, Budzikiewicz H, Bernhard G, 2007.** Complexation of Actinides with Bioligands Secreted by a Subsurface Strain of *Pseudomonas fluorescens*. Poster presented at the 11<sup>th</sup> International Conference MIGRATION'07, München, Germany, August 2007; Paper PB4-2.

### **NMWO**

**Guo S, 2007.** EBS task-force modelling report: modelling AECL's tests – isothermal test and buffer container experiment. Prepared by Atomic Energy of Canada Limited. Nuclear Waste Management Organization report NMWO TR-2007-13. Toronto, Ontario.

## **8.3 Documents published 2007**

During 2007 the following reports and documents have been published in the SKB series.

### **Technical Reports**

**Andersson J C, 2007.** Äspö Pillar Stability Experiment, final report. Rock Mass Response to Coupled Mechanical Thermal Loading. SKB TR-07-01, Svensk Kärnbränslehantering AB.

**SKB, 2006.** Äspö Hard Rock Laboratory. Annual Report for 2006. SKB TR-07-10, Svensk Kärnbränslehantering AB.

**Hodgkinson D, 2007.** Äspö Task Force on modelling of groundwater flow and transport of solutes. Review of Tasks 6D, 6E, 6F and 6F2. SKB TR-07-03, Svensk Kärnbränslehantering AB.

### **International Progress Reports**

**Mærsk Hansen L, Hermansson J, Staub I, Tullborg E L, 2003.** True-1 Continuation project. Fault rock zones characterisation. Preliminary structural-geological description of target structures based on borehole data and tunnel mapping. SKB IPR-03-50, Svensk Kärnbränslehantering AB.

**Wass E, 2005.** LTDE Long-Term Diffusion Experiment. Hydraulic conditions of the LTDE experimental volume – results from Pre-Test 0.1–6. SKB IPR-05-25, Svensk Kärnbränslehantering AB.

**Widestrand H, Byegård J, Börjesson S, Bergelin A, Wass E, 2006.** LTDE Long Term Diffusion Experiment. Functionality tests with short-lived radionuclides 2005. SKB IPR-06-05, Svensk Kärnbränslehantering AB.

**Magnor B, Hardenby C, Kemppainen K, Eng A, 2007.** Rock Characterisation System – RoCS. Final report – feasibility study, phase I. State-of-the-art in 3D surveying technology. SKB IPR-06-07, Svensk Kärnbränslehantering AB.

- Birgersson M, Johannesson L E, 2006.** Prototype Repository. Statistical evaluation of buffer density. SKB IPR-06-15, Svensk Kärnbränslehantering AB.
- Poteri A, 2006.** Äspö Task Force on modelling of groundwater flow and transport of solutes. Modelling of Task 6D, 6E, 6F and 6F2 using the Posiva streattube approach. SKB IPR-06-17, Svensk Kärnbränslehantering AB.
- Grenier C, Bernard Michel G, 2006.** Äspö Task Force on modelling of groundwater flow and transport of solutes. Modelling Task 6D, 6E, 6F and 6F2 using Cast3M code. SKB IPR-06-18, Svensk Kärnbränslehantering AB.
- Crawford J, Moreno L, 2006.** Äspö Task Force on modelling of groundwater flow and transport of solutes. Modelling of Task 6D, 6E and 6F, using CHAN3D. SKB IPR-06-19, Svensk Kärnbränslehantering AB.
- Cheng H, Cvetkovic V, 2006.** Äspö Task Force on modelling of groundwater flow and transport of solutes. Modelling of Task 6D, 6E and 6F, flow and transport simulations in fracture networks. SKB IPR-06-20, Svensk Kärnbränslehantering AB.
- Svensson U, 2006.** Äspö Task Force on modelling of groundwater flow and transport of solutes. Modelling of Task 6D, 6E, 6F and 6F2, flow, transport and retention in a sparsely fractured granite. SKB IPR-06-21, Svensk Kärnbränslehantering AB.
- Lindbæk Skovbjerg L, 2005.** Reduction of hexavalent chromium by green rust sulphate: determination of end product and reduction mechanism. SKB IPR-06-25, Svensk Kärnbränslehantering AB.
- Pusch R, Ramqvist G, 2006.** Cleaning and sealing of Borehole. Report of Sub-project 1 on design and modelling of the performance of borehole plugs. SKB IPR-06-28, Svensk Kärnbränslehantering AB.
- Pusch R, Ramqvist G, 2006.** Cleaning and sealing of Borehole. Report of Sub-project 2 on plugging of 5 m boreholes at Äspö. SKB IPR-06-29, Svensk Kärnbränslehantering AB.
- Pusch R, Ramqvist G, 2006.** Cleaning and sealing of Borehole. Report of Sub-project 3 on plugging of borehole OL-KR24 at Olkiluoto and reference boreholes at Äspö. SKB IPR-06-30, Svensk Kärnbränslehantering AB.
- Pusch R, Ramqvist G, 2007.** Cleaning and sealing of Borehole. Report of Sub-project 4 on sealing of 200 mm diameter holes. SKB IPR-06-31, Svensk Kärnbränslehantering AB.
- Mattsson H, 2006.** The magnetic anisotropy of rocks across the deformation zone NE-1 at the Äspö HRL. SKB IPR-06-32, Svensk Kärnbränslehantering AB.
- Goudarzi R, Johannesson L E, Börjesson L, 2006.** Backfill and Plug test. Sensors data report (Period 990601–060701) Report No:13. SKB IPR-06-34, Svensk Kärnbränslehantering AB.
- Goudarzi R, Börjesson L, Röshoff K, Edelman M, 2005.** Canister Retrieval Test. Sensors data report (Period 001026–060501) Report No:12. SKB IPR-06-35, Svensk Kärnbränslehantering AB.
- Haycox J R, Pettitt W S, 2006.** Acoustic emission and ultrasonic monitoring results from deposition hole DA3545G01 in the Prototype Repository between April 2006 and September 2006. SKB IPR-06-36, Svensk Kärnbränslehantering AB.
- Luo S, 2006.** Canister Retrieval Test. Investigation of possible thermal induced stress damage by UCS testing and simulations. IPR-06-37, Svensk Kärnbränslehantering AB.
- Kristensson O, Hökmark H, 2007.** Prototype Repository. Thermal 3D modelling of Äspö Prototype Repository. SKB IPR-07-01, Svensk Kärnbränslehantering AB.

**Forsmark T, 2007.** Prototype Repository. Hydraulic tests and deformation measurements during operation phase. Test campaign 7. Single hole tests. SKB IPR-07-02, Svensk Kärnbränslehantering AB.

**Gokall Norman K, Andersson P, 2007.** Prototype Repository. Tracer dilution tests during operation phase, test campaign 2. SKB IPR-07-03, Svensk Kärnbränslehantering AB.

**Äspö Hard Rock Laboratory, 2007.** Status Report. October – December 2006. SKB IPR-07-04, Svensk Kärnbränslehantering AB.

**Goudarzi R, Johannesson L E, 2006.** Prototype Repository. Sensors data report (Period: 010917–061201). Report No:16. SKB IPR-07-05, Svensk Kärnbränslehantering AB.

**Äspö Hard Rock Laboratory, 2007.** Planning Report for 2007. SKB IPR-07-06, Svensk Kärnbränslehantering AB.

**Goudarzi R, Åkesson M, Hökmark H, 2007.** Temperature Buffer Test. Sensors data report (Period: 030326–070101) Report No:9. SKB IPR 07-07, Svensk Kärnbränslehantering AB.

**Äspö Hard Rock Laboratory, 2007.** Status Report. January – March 2007. SKB IPR-07-09, Svensk Kärnbränslehantering AB.

**Nyberg G, Jönsson S, Wass E, 2006.** Hydro Monitoring Programme. Report for 2006. SKB IPR-07-10, Svensk Kärnbränslehantering AB.

**Äspö Hard Rock Laboratory, 2007.** Status Report. April – June 2007. SKB IPR-07-11, Svensk Kärnbränslehantering AB.

**Zolezzi F, Haycox J R, Pettitt W S, 2007.** Acoustic emission and ultrasonic monitoring results from deposition hole DA3545G01 in the Prototype Repository between October 2006 and March 2007. SKB IPR-07-12, Svensk Kärnbränslehantering AB.

**Nowak T, 2007.** Äspö Task Force on Engineered Barrier Systems. Modelling of THM-coupled processes for Task 1, Benchmarks 1, using GeoSys/Rock Flow. SKB IPR 07 13, Svensk Kärnbränslehantering AB.

**Goudarzi R, Johannesson L E, 2007.** Prototype Repository. Sensors data report (Period: 010917–070601). Report No:17. SKB IPR-07-19, Svensk Kärnbränslehantering AB.

**Äspö Hard Rock Laboratory, 2007.** Status Report. July – September 2007. SKB IPR-07-20, Svensk Kärnbränslehantering AB.

### ***Technical documents***

No technical documents were produced during 2007.

### ***International technical documents***

No international technical documents were produced during 2007.