

R-99-12

Compaction of bentonite blocks

Development of techniques for production of blocks with different shapes and sizes

Lars-Erik Johannesson, Lennart Börgesson
Clay Technology AB

September 1998

Svensk Kärnbränslehantering AB

Swedish Nuclear Fuel
and Waste Management Co
Box 5864

SE-102 40 Stockholm Sweden

Tel 08-459 84 00

+46 8 459 84 00

Fax 08-661 57 19

+46 8 661 57 19



Compaction of bentonite blocks

Development of techniques for production of blocks with different shapes and sizes

Lars-Erik Johannesson, Lennart Börgesson

Clay Technology AB

September 1998

Keywords: Clay, bentonite, compaction, blocks of bentonite, compaction pressure, form geometry, granulometry, compaction technique

This report concerns a study which was conducted for SKB. The conclusions and viewpoints presented in the report are those of the author(s) and do not necessarily coincide with those of the client.

TABLE OF CONTENTS

	ABSTRACT	iii
	SAMMANFATTNING	v
	EXECUTIVE SUMMARY	vii
	SYMBOLS	ix
1	INTRODUCTION	1
2	MATERIALS	3
3	TECHNIQUES	7
3.1	GENERAL	7
3.2	LABORATORY COMPACTION	8
3.3	COMPACTION OF LARGE BLOCKS	9
4	LABORATORY COMPACTION	11
4.1	GENERAL	11
4.2	GRANULATED BENTONITE OF MX-80 TYPE	12
4.2.1	General	12
4.2.2	Material description	13
4.2.3	Compaction tests	14
4.2.4	Influence of lubricant on the form	14
4.3	TESTS WITH THE SPANISH CLAY	16
4.3.1	General	16
4.3.2	Compaction tests	17
5	COMPACTION OF BRICK SIZE BLOCKS	19
5.1	GENERAL	19
5.2	COMPACTION TECHNIQUE	19
5.3	COMPACTION OF IBECO BENTONITE	22
5.4	COMPACTION OF SPANISH BENTONITE	23
6	COMPACTION OF CYLINDRICAL BLOCKS WITH ϕ 250 MM	25
6.1	GENERAL	25
6.2	FORM CONSTRUCTION	25
6.3	COMPACTION TECHNIQUE	26
6.4	RESULTS FROM THE COMPACTION TESTS	27

7	COMPACTION OF RING SHAPED BLOCKS	33
7.1	GENERAL	33
7.2	FORM CONSTRUCTION	33
7.3	COMPACTION TECHNIQUE	35
7.4	RESULTS FROM THE COMPACTION TESTS	36
7.5	BLOCK DAMAGES	44
8	COMPACTION OF CYLINDRICAL BLOCKS WITH ϕ 1000 MM	47
8.1	GENERAL	47
8.2	FORM CONSTRUCTION	47
8.3	COMPACTION TECHNIQUE	48
8.4	RESULTS FROM THE COMPACTION TESTS	51
8.5	BLOCK DAMAGES	54
9	CONCLUSIONS AND DISCUSSION	57
	REFERENCES	59

ABSTRACT

In this report useful techniques for producing both smaller blocks manageable by man (weight of the blocks: 10-15 kg) and larger blocks which need special equipment for handling (weight up to 600 kg) are described.

Tests for producing blocks with a weight of approximately 10 kg were carried out at Höganäs Bjuv AB in Bjuv. This industry is normally producing refractory bricks and other refractory products. The plant has facilities for handling large volumes of clay. It also has machines suitable for producing uniaxially compacted blocks. Tests performed at the plant show that it is possible to compact blocks with good quality. The best quality was reached with a coarsely ground bentonite at a water ratio of 17 %. The compaction rate was high and performed with lubricated form and stepwise loading.

Tests, in order to find a technique for producing larger blocks with a diameter of the same size as a deposition hole (about 1.65 m), were also made. The technique was developed in a smaller scale (ϕ 250 mm). Ring-shaped blocks with the same outer diameter and with an inner diameter of about 156 mm were also compacted. The compaction was made with vacuum in the form. The outer surface of the form was conical and most of the tests were performed with a lubricated form. Tests were performed with different water ratios of the bentonite. All the blocks had a good quality. In consequence of the good test results a form with a 1000 mm diameter was constructed and a number compaction tests were performed. The same technique was used as for the smaller blocks. The compaction pressure in most tests was 100 MPa (maximum compaction load 80.000 kN). The tests were performed at HYDROWELD in Ystad in a press with maximum a capacity of 300.000 kN. All tests were performed with MX-80. Most of the blocks had a good quality. A small damage close to the upper surface of all blocks was observed but is considered to be of no importance for the possibility to handle the blocks and is not affecting the properties of the buffer mass once the bentonite becomes saturated. The tests show that it should be possible to compact blocks with a diameter of 1.65 m.

SAMMANFATTNING

Denna rapport behandlar och beskriver framtagandet av användbara tekniker för framställning av kompakterade bentonitblock. Rapporten behandlar bara enaxiellt kompakterade block. Tekniker för både små block (vikt på blocken: 10-15 kg) med en volym och vikt som möjliggör manuell hantering och större block med en vikt upp till ca 600 kg beskrivs.

Tester för framtagande av block med en vikt på ca 10 kg har utförts på Höganäs Bjuf AB i Bjuv. Vid denna anläggning framställs normalt eldfast tegel och andra eldfasta produkter. Anläggningen har utrustning som möjliggör en automatisk hantering av stora volymer lera. Vidare finns på anläggningen pressar som är lämpliga för framställning av enaxiellt kompakterade block. Utförda tester med befintlig utrustning visar att det är möjligt att framställa block av bentonit med god kvalitet. Bäst resultat erhöles med granulerad bentonit med en vattenkvot på omkring 17%. Kompakteringen skedde med smord form och i flera laststeg för att undvika att sprickor uppstår i blocken.

Tester i syfte att ta fram en teknik för kompaktering av stora block med diameter i samma storleksordning som ett deponeringshål (ca 1.65 m) har också utförts. Tekniken utvecklades först i en mindre skala (diameter på blocken ca 250 mm). Ringformiga block med samma ytterdiameter och med en innerdiameter av 156 mm kompakterades också. För att få så bra block som möjligt utfördes kompakteringen relativt långsamt under vakuumsugning av bentoniten. Formen har konisk ytteryta och smordes före fyllning. I försöken varierades vattenkvoten på bentoniten. De kompakterade blocken fick en god kvalitet. Som följd av de goda resultaten konstruerades en form med diametern 1000 mm. Ett antal försök utfördes med formen. Samma teknik som utvecklades för de mindre blocken användes vid försöken. Kompakteringstrycket var i de flesta försöken 100 MPa (motsvarar en kompakteringslast på ca 80.000 kN). Testerna utfördes vid HYDROWELD i Ystad i en press med maximal kompakteringslast av 300.000 kN. Alla försöken utfördes med Na-bentonit MX-80. På samtliga block kunde en mindre spricka observeras nära blockens överyta efter kompakteringen. Skadorna på blocken har bedömts att inte påverka hanterbarheten hos blocken. Inte heller bedöms bufferten efter inplacering, påverkas av sprickorna. Försöken visar på att det bör vara möjligt att kompaktera block med en diameter på 1.65 m.

EXECUTIVE SUMMARY

Available techniques for compacting bentonite blocks are isostatical compaction and uniaxial compaction. The blocks made for the Buffer Mass Test in Stripa in 1981 were isostatically compacted.

In isostatical compaction the bentonite is enclosed in a membrane, which is surrounded by a pressurized liquid pressure medium. The pressure acts uniformly over the entire outer surface of the block.

When the uniaxial compaction technique is used the bentonite is poured into a rigid form and a piston is placed on the surface of the bentonite. The piston is pushed into the form by a press device so that the bentonite is compacted uniaxially. The disadvantage of this technique is that the blocks may become inhomogeneous if the material close to the piston gets more compacted than other parts of the block due to the friction between the bentonite and the form.

This report deals with uniaxial compaction of bentonite blocks. In this work uniaxial compaction of bentonite have been carried out in four scales:

1. laboratory scale with diameters of the samples of 35-50 mm
2. blocks of brick size
3. blocks with a diameter of 250 mm
4. blocks with a diameter of 1000 mm

Most of the blocks were compacted with a 100 MPa pressure.

The tests performed in laboratory scale (in small form with a diameter of 50 mm) showed the following:

- When using lubricant on the form (MOLYKOTE BR 2 plus[®] with molybdenum disulfide, MoS₂) it was possible to get a homogeneous sample for both the water ratios and when the ratio between the height and the diameter of the sample was as large as $H/D = 2$. Previous tests have shown that without lubricant the ratio should not be larger than 0.4 in order to get a homogeneous sample. The tests also showed that at a water ratio of about 18% it was possible to get a rather homogeneous sample even without lubricated form ($H/D = 2$).
- Tests performed with coarse-grained MX-80 at low water ratio showed that the density after compaction was somewhat higher than

corresponding samples compacted with standard MX-80. At higher water ratio the effect of the granulation was insignificant.

- Tests performed with the Spanish Ca-bentonite 70-IMA-3-4-0 gave a similar compaction curve as MX-80.

Experiments with compaction of both small "brick size" blocks and larger blocks were performed. The large blocks had a diameter of 1000 mm. Ring-shaped blocks with an outer diameter of about 250 mm were also compacted. The results from the tests showed that:

- Blocks of bentonite with various size and shape can be produced with an acceptable quality.
- The "brick size" blocks were compacted rather rapidly. In order to avoid damages on the blocks due to entrapped air the compaction has to be made stepwise and a more coarsely ground bentonite should be used. The form should also be lubricated.
- Ring shaped blocks have been compacted with good results. The blocks were homogeneous and did not have comprehensive damages. The blocks were compacted rather slowly and the compaction was made with vacuum in the form. Furthermore, the form was lubricated and the outer cylindrical surface had a conical shape. Even though the blocks were rather small the (outer diameter 250 mm, inner diameter 156 mm) the results indicate that it is possible to compact rings shaped blocks with full size of a deposition hole.
- Cylindrical blocks with 250 and 1000 mm diameter were compacted. The same technique as for the ring shaped blocks was used. The quality of the smaller blocks was very good. The larger ones had a damage close to the upper surface that was considered to be of no importance for the handling of the blocks and for the properties of the buffer mass.

SYMBOLS

e	=	void ratio
E	=	Young's modulus
S_r	=	degree of saturation
w	=	water ratio
w_L	=	liquid limit
W	=	moment of resistance
ϵ_f	=	maximum tensile strain
ρ	=	density
ρ_d	=	dry density
ρ_m	=	density at saturation
ρ_s	=	density of the particles
ρ_w	=	density of water
σ_t	=	maximum tensile stress
τ_f	=	maximum shear stress

1 INTRODUCTION

The Swedish KBS3 concept for disposal of nuclear waste implies that the bentonite barrier around the waste canisters is composed of blocks of highly compacted bentonite, which yield a uniform buffer mass after water saturation, swelling and homogenization. The requirements concerning shape, void ratio, and homogeneity of the blocks are very strict and it might also be desirable to make blocks with a high and uniform degree of water saturation. The techniques for compacting blocks of bentonite are mainly two; isostatic compaction and uniaxial compaction. This project deals with development and testing of a technique for uniaxial compaction.

The volume and weight of the blocks can roughly be divided into two groups:

1. Blocks of brick size that are manageable by hand. They are termed "brick blocks" in this report.
2. Blocks of "magnum" type that need tools to be handled. They are termed "magnum blocks" in this report.

For the first group of blocks the upper weight limit is 10-15 kg. The weight of the second group of blocks is limited by the compaction device but also by the capacity of the tools for handling the blocks. The brick-size blocks need to be compacted at a high rate for obtaining an acceptable production capacity. Common techniques for manufacturing refractory bricks appear to be suitable. Magnum blocks require a very large compaction device (form and press) that can produce a very high force. For this type of blocks one can accept low compaction rates and individual handling. This report deals with both techniques.

Pervious performed work concerning block preparation with uniaxial compaction is reported by Johannesson et al (1995).

2 MATERIALS

Three different bentonite types have been used in the tests, one sodium-converted Ca-bentonite from Greece (IBECO), one naturally occurring bentonite with Na as major adsorbed cation from Wyoming, USA and one Ca-bentonite from Spain. Two different kinds of the natural Na-bentonite have been used in previous tests, namely MX-80 and SPV200. Most of the tests reported in this work have been performed with MX-80. The sodium-converted bentonite (IBECO) was used in the form of a fine powder and four different grain size distributions. The different grain size distributions have been achieved by sieving and grounding the material to different extents.

Typical results from chemical analyze of the Wyoming bentonites and IBECO-bentonite is shown in Table 2-1. The density of the solid particles (ρ_s) for the two bentonites is assumed to be 2.78 g/cm^3 .

Table 2-1. Results from chemical analyses of IBECO bentonite and Wyoming bentonites (MX-80 and SPV200).

Sample	SiO ₂ (%)	Al ₂ O ₃ (%)	Fe ₂ O ₃ (%)	TiO ₂ (%)	MgO (%)	CaO (%)	K ₂ O (%)	Na ₂ O (%)	P ₂ O ₅ (%)
IBECO-Na ^{*)}	63.8	19.8	5.0	0.8	3.2	3.1	1.0	2.8	0.2
MX-80 ^{**)}	66.9	20.8	4.7	0.2	3.1	1.9	0.6	2.8	0.1
SPV200 ^{***)}	64.6	23.3	3.7		3.4	0.4	0.5	2.6	

^{*)} Karland et al 1992

^{**)} Karland et al 1994

^{***)} According to the data sheet from the deliverer of the bentonite

The grain size distributions of the bentonites are shown in Figs 2-1 and 2-2. The grain size distributions of the bentonites in dispersed form are plotted in Figure 2-1. The diagram shows that more than 80% of the dispersed grains are smaller than 0.002 mm and thus belong to the clay fraction.

The grain size distributions of the bulk materials with their natural content of water are shown in Figure 2-2. For MX-80 more than 50% of the granules in the bulk material are larger than 0.2 mm. The granule size distribution of the coarsely ground IBECO-bentonites varies a lot. The most coarsely ground bentonite (IBECO-C) has almost no granules smaller than 0.5 mm while the most finely ground IBECO bentonite is somewhat coarser than MX-80.

The fall-cone liquid limit determined according to standard geotechnical procedures is shown in Table 2-2. The two natural occurring bentonites (MX-80 and SPV200) have liquid limits in the same range while the liquid limit for of the sodium-converted bentonites is lower.

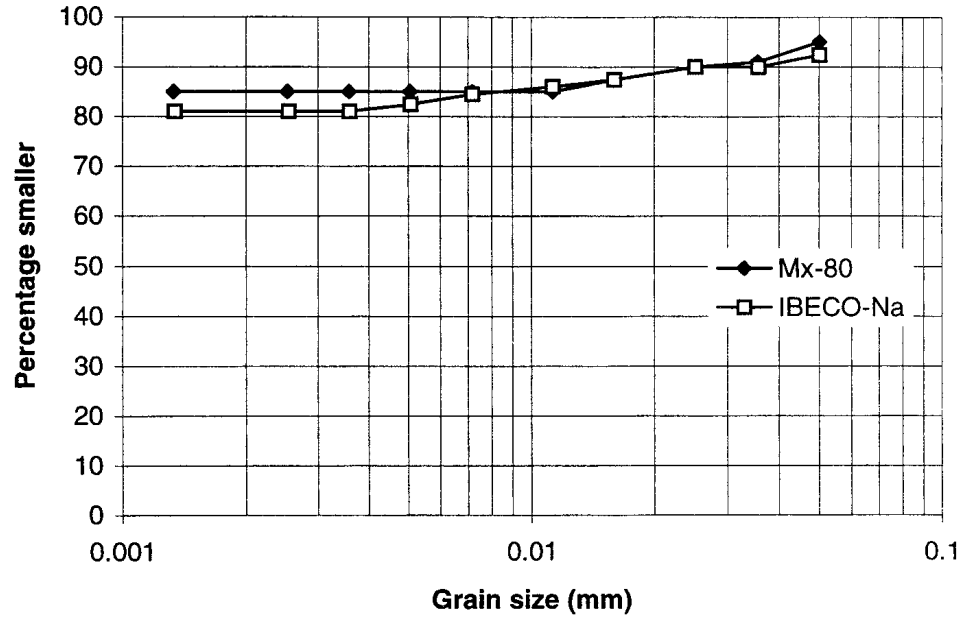

Figure 2-1. Grain size distribution of dispersed MX-80 and IBECO-Na.

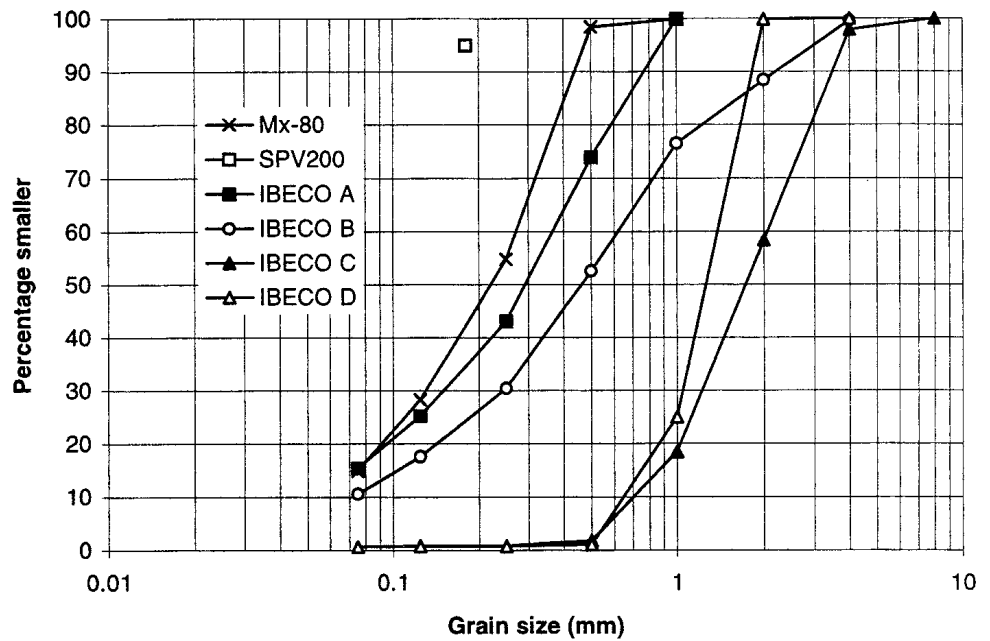

Figure 2-2. Grain size distribution of the bentonites in bulk form.

Table 2-2. The liquid limit w_L of the bentonites.

Type	w_L , % (%)
IBECO-Na	400
IBECO A	393
IBECO-B	410
IBECO C	340
IBECO D	322
MX-80	518
SPV 200	484

Tests have also been carried out on the clay used in the Spanish full size test FEBEX. The clay is a Spanish domestic clay named 70-IMA-3-4-0. It is classified as a Calcium bentonite with a liquid limit of about 100%. The density of the solid particles (ρ_s) is assumed to be 2.78 g/cm^3 . The grain size distribution is shown in Figure 2-3 where it can be seen that the Spanish clay is much coarser than MX-80.

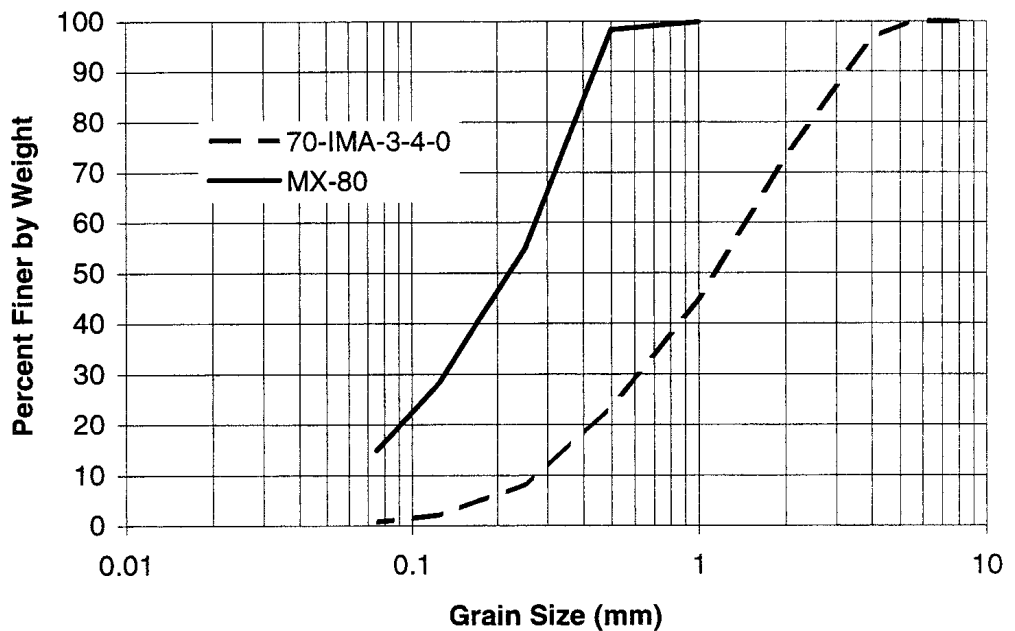

Figure 2-3. Grain size distribution of MX-80 and 70-IMA-3-4-0 in bulk forms (a Spanish Ca-bentonite).

3 **TECHNIQUES**

3.1 **GENERAL**

Available techniques for compacting bentonite blocks are isostatical compaction and uniaxial compaction. The blocks made for the Buffer Mass Test in Stripa in 1981 were isostatically compacted.

In isostatical compaction the bentonite is enclosed in a membrane which is surrounded by a pressurized liquid pressure medium. The pressure acts uniformly over the entire outer surface of the block. The advantage with isostatic compaction is that there is no mould that may cause problems with friction, resulting in homogeneous blocks even if the height-diameter ratio is high. However, this technique also has two major drawbacks. One is that the production of each block requires much preparative work and is time-consuming which means that the technique is only useful for large blocks. The other drawback is that the shape of the block may deviate from the required. In order to obtain the required geometry it may be necessary to shape the block with a saw or a turning after compaction. If the preparation and sawing is time-consuming the surface of blocks with a high degree of water saturation might dry.

When uniaxial compaction technique is used the bentonite is poured into a rigid form and a piston is placed on the surface of the bentonite. The piston is pushed into the form by a press device so that the bentonite is compacted uniaxially. The disadvantage of this technique is that the blocks may become inhomogeneous if the material close to the piston gets more compacted than other parts of the block due to the friction between the bentonite and the form. The following precautions may be taken in order to avoid this:

- Have a low ratio between the height and diameter of the sample
- Use both an upper and a lower piston at the compaction
- Compact blocks to a high degree of saturation
- Use lubricant on the form

In this work uniaxial compaction of bentonite have been carried out on four scales:

1. laboratory scale with diameter samples 35-50 mm
2. blocks of brick size
3. blocks with a diameter of 250 mm
4. blocks with a diameter of 1000 mm

Most of the blocks were compacted with a pressure of 100 MPa.

3.2 LABORATORY COMPACTION

Most of the samples in the laboratory tests were compacted in a cylinder of steel (see Figure 3-1). The cylinder was attached to a bottom plate which had a small hole in the center covered by a steel filter. The hole and the filter allowed the air in the sample to dissipate during the compaction. The mixture of bentonite and water was poured into the cylinder and a steel piston applied on the sample that was compacted in a press at a constant rate of strain. After compaction, the bottom plate was released and the sample pushed out from the cylinder by use of the piston.

In some of the tests the load and displacement of the sample were measured during the compaction.

Some tests were carried out in a compaction cylinder with a diameter of ≈ 35 mm. The height/diameter ratio in most tests was $2/5$. Compaction cylinders with a diameter of ≈ 50 mm were also used and in these tests the height of the samples varied between 5 and 100 mm in order to investigate the influence of the height/diameter ratio.

After compaction, the bulk density (ρ) and the water ratio (w) were determined. In some cases the sample was cut in 10 mm slices and each slice investigated separately in order to study the homogeneity of the sample.

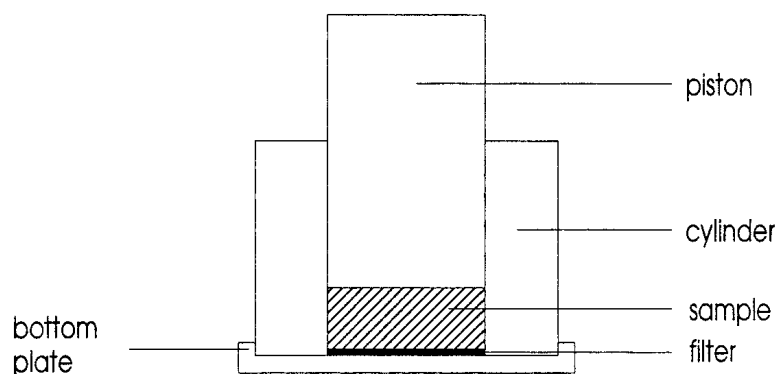

Figure 3-1. Schematic drawing of the compaction cylinder.

3.3 COMPACTION OF LARGER BLOCKS

Compaction of larger blocks was done in two ways:

- Compaction of blocks with brick size which are manageable by man (weight of about 10 - 20 kg)
- Compaction of large blocks which need machines to be handled

The compaction of smaller blocks was made rather rapidly and without vacuum. Furthermore the compaction was made with both an upper and a lower piston. The technique is described in detail by Johannesson et al., 1995 and in Section 5.2 in this report.

Compaction of blocks with larger volumes was carried out in three different forms; one with a diameter of 250 mm, one ring shaped form with an outer diameter of 250 mm and an inner diameter of 156 mm, and one with a diameter of 1000 mm. In these tests the block were compacted uniaxially with only an upper piston.

Blocks with a height of 100 mm were compacted in the form with a diameter of 250 mm. The compaction pressure varied between 50 - 100 MPa which means that the compaction load varied between 2500 - 5000 MN. Most tests were carried out in a somewhat conical form. The used technique is described in detail in Section 6.3.

There are two reasons for using a conical form:

1. To make it easier to release the block from the form
2. To minimise occurrence of cracks in the blocks

The cracks mainly occurred in blocks with low water ratio. Previous laboratory tests indicated that the elastic volume expansion of the samples after compaction was as large as 11% when bentonite with a low water ratio was compacted. Figure 3-2 shows a schematic drawing of the technique for releasing a block from the form. At first the block is compacted by the piston. The block affects the form with a horizontal pressure that is still present after load-relief due to the swelling tendency. The block is then pushed out of the form by the piston. In the second picture almost the whole block has been pushed out of the form. The part of the block, which is outside the form, has expanded while the part still inside the form is prevented from expanding. This will cause large strains in the lower part of the block which may result in cracks. Using bentonite with a high water ratio but also, as mentioned earlier, by making the form conical can prevent this type of cracks.

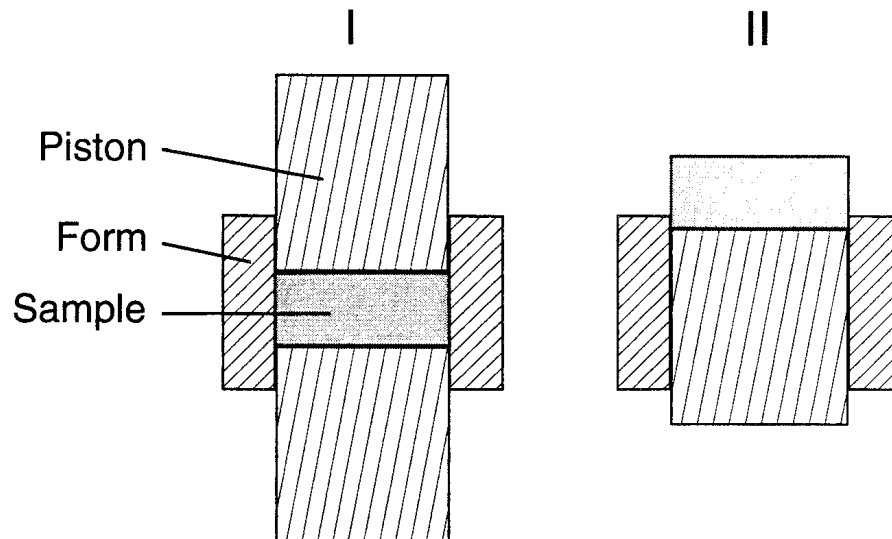

Figure 3-2. Schematic drawing of the technique used for pushing a block out of a form.

The same technique was used to compact very large blocks with a diameter of 1000 mm and an approximate height of 350 mm. This form was also conical. The used technique is described in detail in Section 8.3.

Ring shaped blocks were also compacted with an outer diameter of approximately 250 mm and an inner diameter of 156 mm, (see Section 7.3). The outer surface of the form was conical while the inner surface was cylindrical. The height of these blocks varied between 25 and 100 mm. The procedure described earlier was also used for these blocks.

After compaction several small samples were taken from different positions in the blocks and the bulk density (ρ) and the water ratio (w) were determined.

4 LABORATORY COMPACTION

4.1 GENERAL

Two main types of tests have been performed in the laboratory:

- Compaction of small samples
- Determination of water ratio and density on both small samples compacted in the laboratory but also on samples taken out from larger blocks

Results from laboratory compaction of small samples are described in Section 4.2 - 4.3

The water ratio (w) is defined as the loss in weight of the sample after 24 hours drying in an oven at 105 °C, divided by the weight of the dry sample. The bulk density (ρ) of the samples was determined by using "the paraffin method" (see Pusch 1973). From the measured parameters the degree of saturation (S_r) and void ratio (e) can be calculated using Eqn. 4-1 and Eqn. 4-2.

$$S_r = \frac{w \cdot \rho \cdot \rho_s}{[\rho_s \cdot [w + 1] - \rho] \cdot \rho_w} \quad (4-1)$$

$$e = \frac{\rho_s - \rho}{\rho - \rho_w \cdot S_r} \quad (4-2)$$

where ρ_w is the density of the water and ρ_s is the density of the solid particles of the soil.

The pore volume of the compacted samples contains both water and gas if the degree of saturation is less than 100%. If the pores are completely filled with water the density is the maximum density at a certain void ratio. This density, which can be calculated by use of equation 4-3 by applying $S_r = 1.00$, is called *the density at saturation* (ρ_m). The so-called *dry density* (ρ_d) can also be calculated from equation 4-3 by applying $S_r = 0$. The dry density is the minimum density for a sample at a certain void ratio.

$$\rho = \frac{\rho_s + \rho_w \cdot S_r \cdot e}{1 + e} \quad (4-3)$$

In Figure 4-1 the density at saturation and the dry density are plotted as a function of the void ratio (Eqn 4-3) for $\rho_s = 2.78 \text{ g/cm}^3$ and $\rho_w = 1.00 \text{ g/cm}^3$. A sample of bentonite with a certain void ratio thus has a bulk density between these values. Sometimes it is useful to calculate the maximum density for a specific water ratio. This can be made by applying Eqn. 4-4.

$$\rho_m = \frac{1+w}{\frac{w}{\rho_w} + \frac{1}{\rho_s}} \quad (4-4)$$

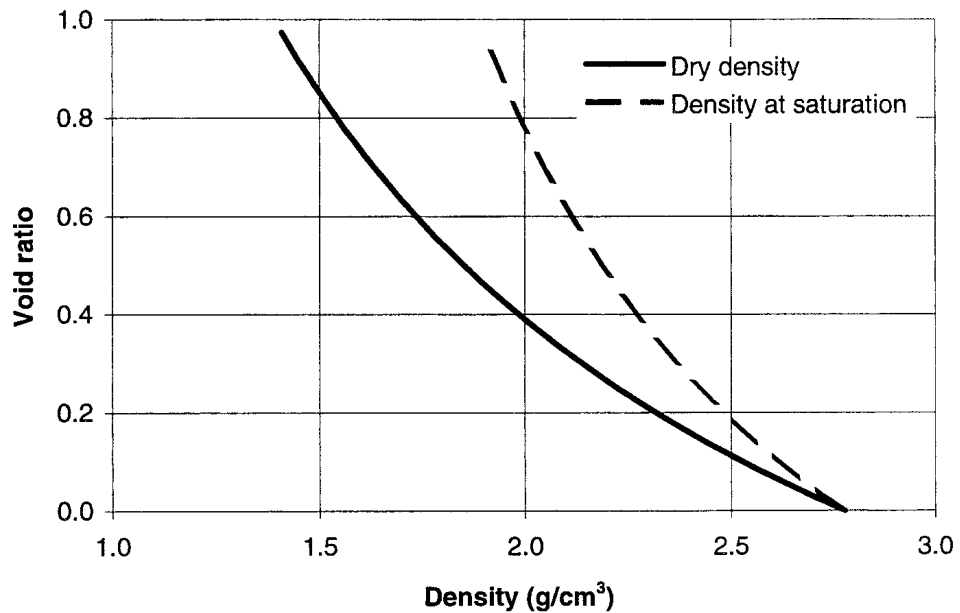

Figure 4-1. The density at saturation and dry density as a function of water ratio assuming $\rho_s = 2.78 \text{ g/cm}^3$ and $\rho_w = 1.00 \text{ g/cm}^3$.

Some tests have been performed in laboratory scale. The purpose of most of these tests was to test different type of clays and compare the compaction characteristics with those of other clays (particularly MX-80). Tests were also performed in order to investigate how different lubricants on the form affected the compaction characteristic.

4.2 GRANULATED BENTONITE OF MX-80 TYPE

4.2.1 General

One problem associated with compaction of larger blocks of bentonite is the appearance of cracks due to entrapped air in the blocks (Johannesson et al. 95). Previous tests have shown that this type of damage could be avoided by using a coarsely ground material instead of a fine powder allowing the air to seep out from the blocks more easily during the compaction. Another way of

making a material with larger "grains" is to granulate the clay. By using special equipment it is possible to wet and granulate the material to a specified granule size in the same procedure. A granulated material might also be easier to transport and to fill in the form.

4.2.2 Material description

Granulated MX-80 was produced at Fa. Eirich in Hardheim, Germany. The clay was mixed, wetted and granulated in an Eirich R80 mixer. Varying the water content, number of revolutions of the mixer and the mixing time, produced different granule size distributions. Five of the granulated materials were investigated in the laboratory. The initial water contents of the investigated materials are shown in Table 4-1. The table shows that the water ratios were rather high. In order to get the grain size distribution the materials were at first dried to a water ratio of about 10% and then sieved. In Figure 4.2 the size distribution of the granules is shown together with the granule size of MX-80.

Table 4-1. Water ratio of the granulated materials (MX-80) after drying to a water ratio of 10%.

mtrl	w (%)
2	31.8
3	31.9
4/2	29.1
5	26.5
Pretest	22.0

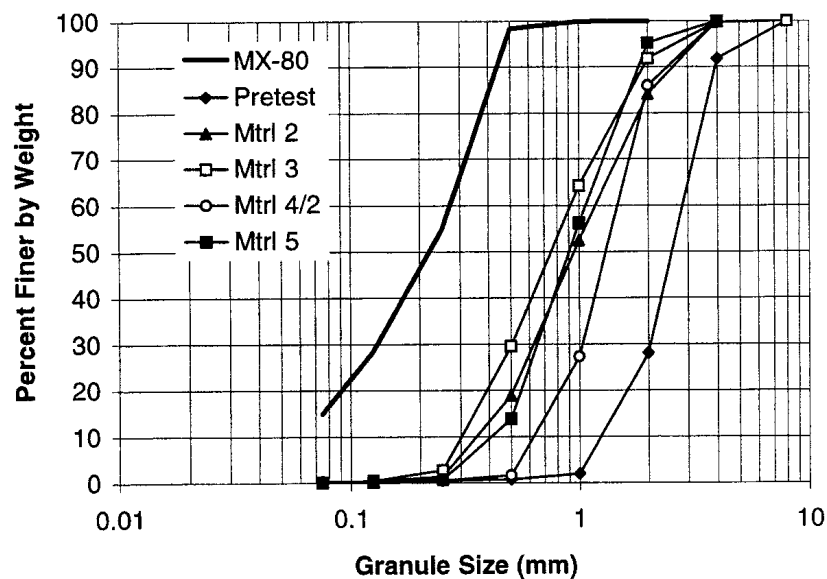

Figure 4-2. Granule size distributions of granulated MX-80 after drying to 10% water ratio.

4.2.3 Compaction tests

The materials were compacted with a compaction pressure of 100 MPa at three different water ratios in a form with 50 mm diameter, whereafter the density and water ratio were measured. The results from the tests are shown in Figure 4.3. The figure shows that the granulated materials, particularly the material with large granules (Mtrl Pretest), gave samples with lower void ratio than MX-80 at a specified water ratio. This was especially obvious at a low water ratio.

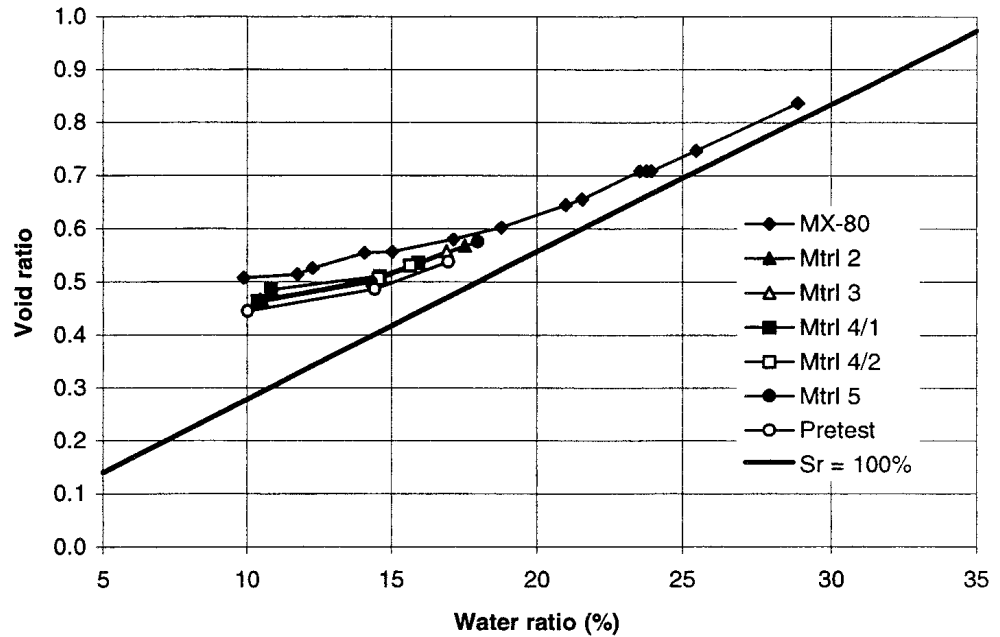

Figure 4-3. The void ratio as a function of water ratio for different types of granulated MX-80.

4.2.4 Influence of lubricant on the form

The ratio of the diameter and height of a form is expected to affect the homogeneity of a compacted sample due to the friction between the sample and the form. It is possible to minimize this effect by lubricating the form. In order to investigate this effect, samples of MX-80 and granulated material (mtrl 2) were compacted at a 100 MPa pressure in a cylinder with a diameter of 49 mm and a height of 240 mm. Samples with 100 mm height were compacted at two different water ratios; $\approx 10-11\%$ and $\approx 17-19\%$. The lubricant used was MOLYKOTE BR 2 plus[®] with molybdenum disulfide (MoS_2). After compaction, the samples were cut in 10 mm thick slices for which the density and water ratio were measured. The degree of saturation and void ratio were then calculated using Eqn 4-1 and Eqn 4-2.

The results from the tests are shown in Figure 4-4 and Figure 4-5, where the void ratio is plotted as a function of the distance from the upper surface of the sample.

The samples of MX-80 with a 10-11% water ratio and no lubricant on the form (cf. Figure 4-4) showed an increase in void ratio along the sample from $e=0.5$ near the top of the sample close to the piston, to $e=0.7$ near the bottom. This indicated a strong influence of the friction between the sample and the walls of the form on the homogeneity of the sample. With a lubricated form the void ratio varied between 0.47 to 0.52 over the sample. The results from the samples compacted with granulated material yielded similar results (same change in void ratio per mm). The results indicated that the Molybdenum disulfide was minimizing the friction along the surface of the form very efficiently.

At 17-19% water ratio (cf. Figure 4-5) there was no significant difference in void ratio along the samples compacted with MX-80 (with and without lubricant on the form), which indicated that there was only little friction between the sample and the walls of the form. For the granulated material there were some small differences in the void ratio over the sample when no lubricant was used on the form. When the form was lubricated, the sample became almost homogeneous.

The results of the tests showed that by using MOLYKOTE BR 2 plus[®] as lubricant the inhomogeneity of the compacted samples due to friction between the bentonite and the form was reduced.

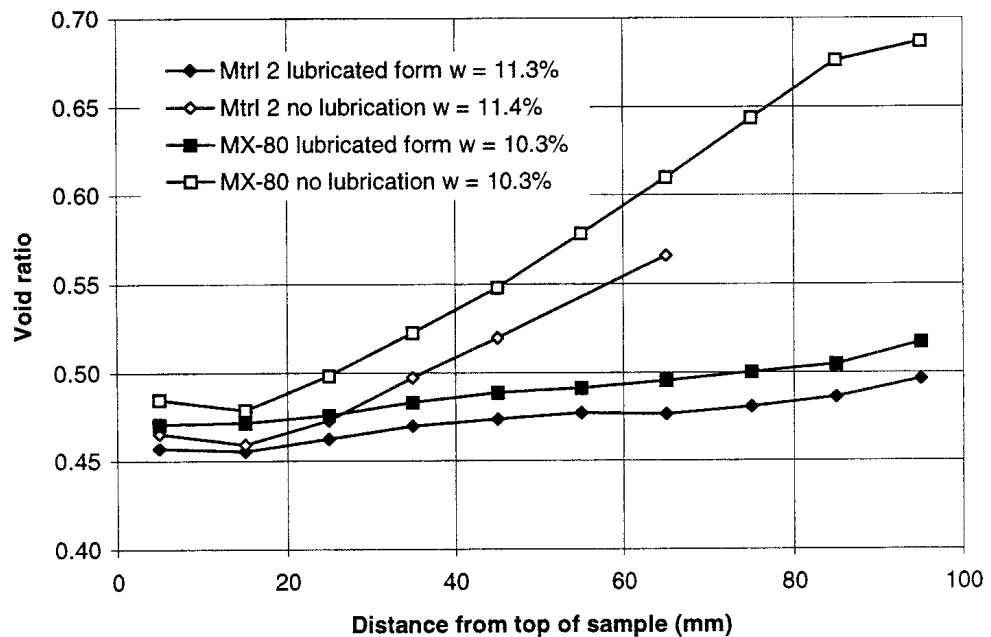

Figure 4-4. The void ratio as a function of the distance from top surface of the samples after compaction. Both granulated (mtrl 2) and natural MX-80 were compacted. Water ratio $\approx 11\%$.

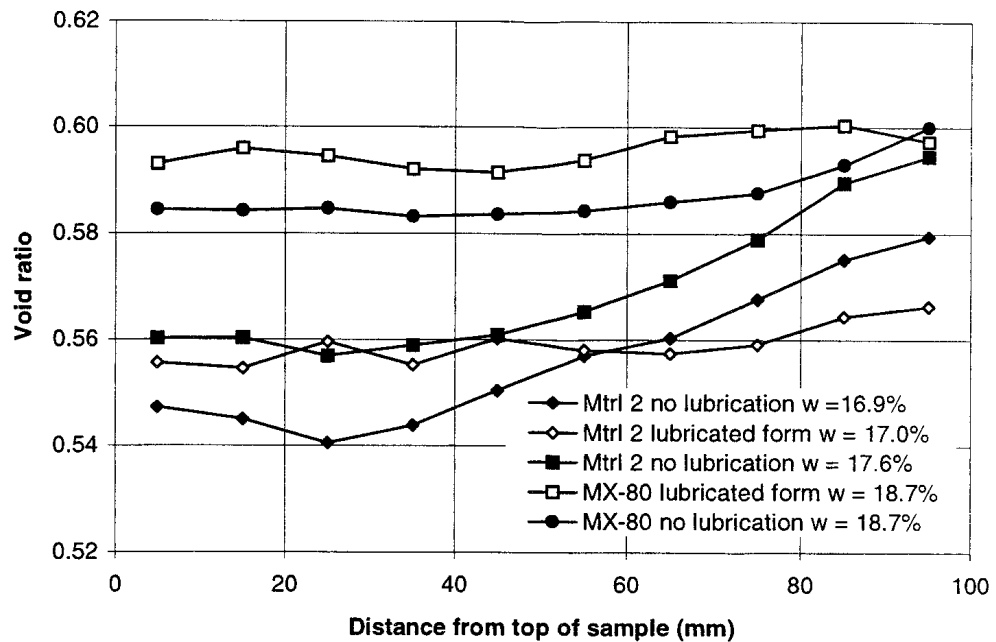

Figure 4-5. The void ratio as a function of the distance from top surface of the samples after compaction. Both granulated (mtrl 2) and natural MX-80 were compacted. Water ratio \approx 17-19%.

4.3 TESTS WITH THE SPANISH CLAY

4.3.1 General

In the Spanish concept for a repository of high activity radioactive waste, precompacted blocks of bentonite are also used as buffer material. The proposed concept is tested in a large field test called FEBEX. The blocks for the test were fabricated in a factory for production of firebricks. The technique used for compacting the blocks was similar to the technique described in Section 5.2 with the following exceptions:

- no lubricant was used on the form
- the form had conical shaped sides
- the compaction load was about 50 MPa

The blocks had a very good quality. In order to investigate if it was possible to get the same quality by using the technique described in Section 5.2, tests were performed with the Spanish clay both in laboratory scale and in larger scale (see Section 5.4) and then compared with the test results of MX-80. The clay was described in Section 2.

4.3.2 Compaction tests

The compaction tests were made in a form with 50 mm diameter. The clay was compacted with two different compaction loads, 50 and 100 MPa, at different water ratios. The results from the tests are shown in Figure 4-6 together with results from compaction tests on MX-80. These results indicate the following:

- Very small differences in the compaction characteristics between 70-IMA-3-4-0 and MX-80 were observed (compaction pressure 100 MPa)
- An increase of the compaction load from 50 to 100 MPa, gave, as expected, somewhat lower void ratio (higher density). This was more obvious at lower water ratios.

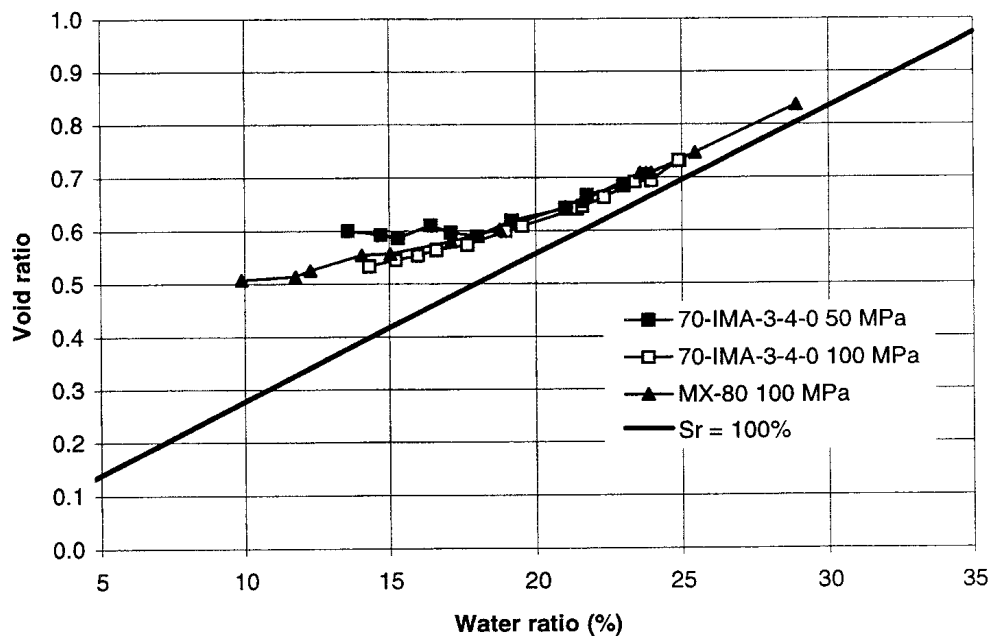

Figure 4-6. The void ratio as a function of water ratio for MX-80 and 70-IMA-3-4-0 (Spanish Ca-bentonite).

5 COMPACTION OF BRICK SIZE BLOCKS

5.1 GENERAL

Small blocks with a weight of about 10 kg can be used as buffer material and in other locations in a repository (e.g. in a plug). Suitable equipment (press, form mixer etc.) for producing this type of blocks can be found in fire bricks factories. Tests have earlier been performed at Höganäs Bjuf AB where blocks with different type of clays were compacted. The tests and the results from the tests are described by Johannesson et al (1995). These tests show that it was necessary to use a clay with rather large grains (aggregates of clay particles) in order to prevent cracks due to entrapped air. The clay was produced by sieving and grounding the material to different extents. The previous tests also indicated that if the clay was too coarse the edges of the blocks tended to get loose and fall off.

The tests described in this report were performed with a 50/50 mixture of IBECO A and IBECO D at Höganäs Bjuf AB in Bjuv. Some tests were also performed with the Spanish clay 70-IMA-3-4-0. The clays are described in Section 2.

5.2 COMPACTION TECHNIQUE

In some of the tests the clay was mixed with water in a mixer before compaction. The mixer is shown in Figure 5-1. It was normally used for mixing clays for refractory products and had a capacity to mix about 300 kg clay at each batch. At compaction the ordinary technique used for compacting firebricks was used except for the transportation of the block after compaction. The technique can be summarised in the following way:

- The clay was stored in a small silo above the press (see Figure 5-2)
- The form was lubricated by spraying oil on the form
- The form was automatically filled with the clay
- The clay was compacted in three steps (see Figure 5-3)
- The block was removed from the form and placed on a pallet (see Figure 5-4)
- The pallet and the blocks were wrapped in plastic

The press was compacting the blocks with both an upper and a lower piston. The lower piston was also used for pressing the block out of the form. By compacting the blocks in three steps and lifting the piston from the upper

surface of the block between the steps it was possible to minimise the damages on the blocks caused by entrapped air.

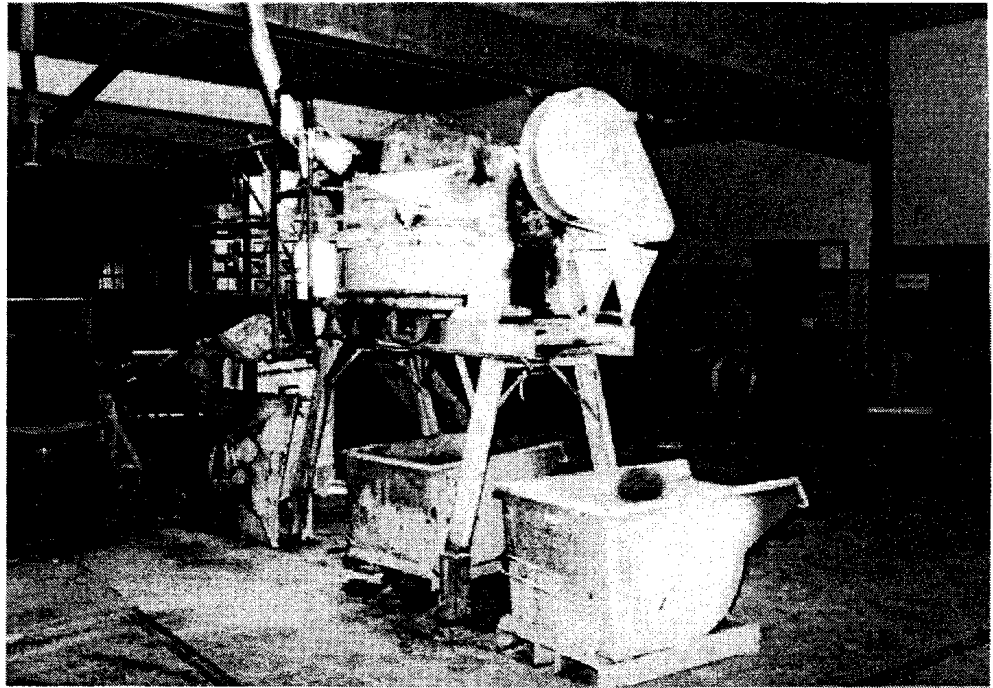

Figure 5-1. The mixer used in the tests.

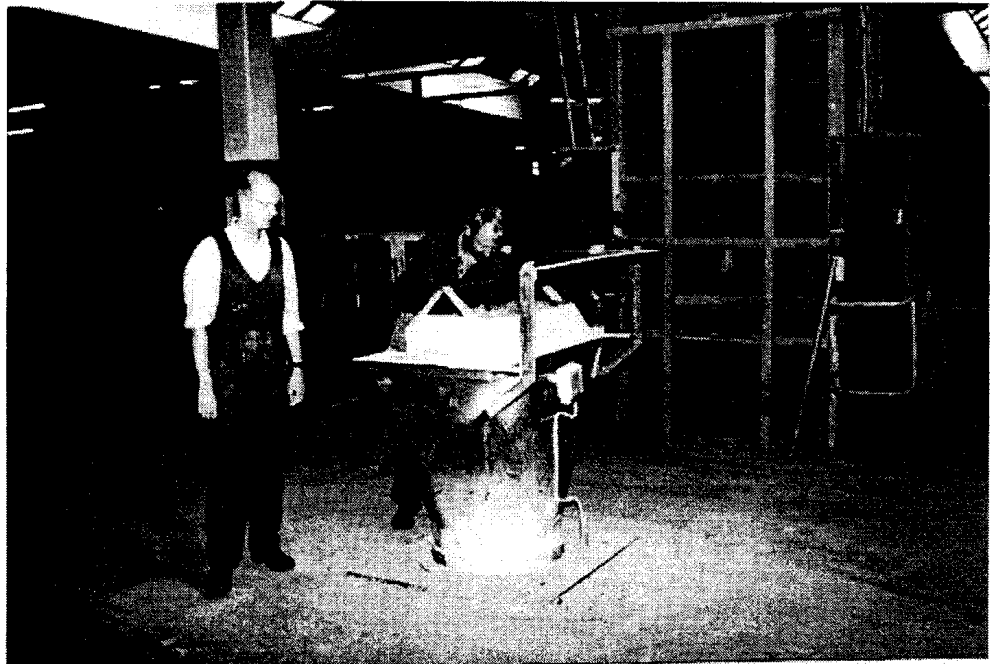

Figure 5-2. The silo for the mixed clay placed above the press.

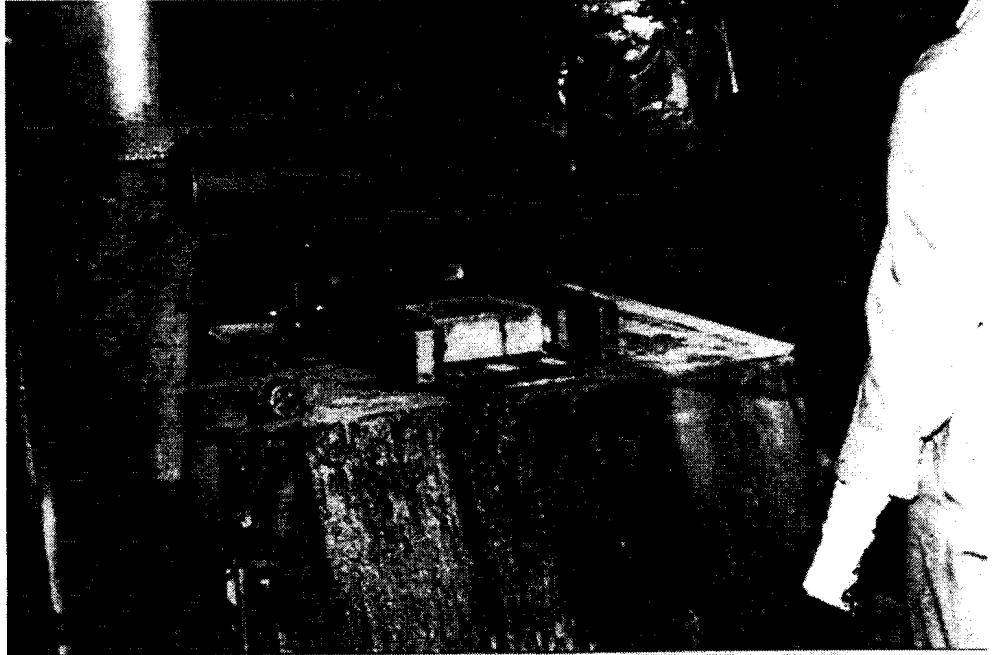

Figure 5-3. The press with a compacted block.

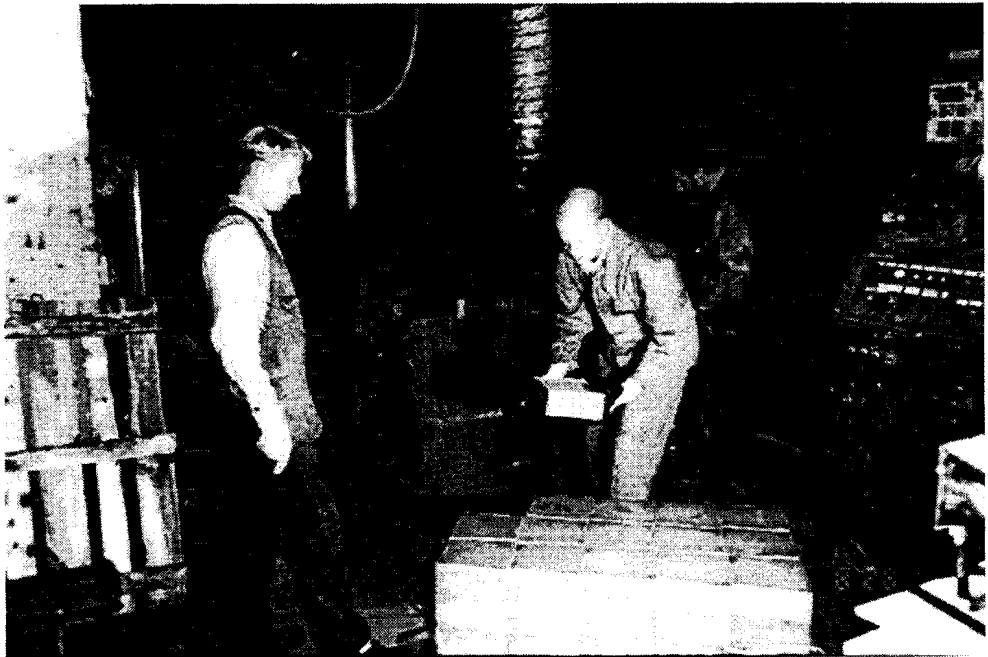

Figure 5-4. The block is removed from the press and placed on a pallet.

5.3 COMPACTION OF IBECO BENTONITE

About 800 kg of the mix of 50/50 of IBECO A and IBECO D was mixed to a water ratio of about 17% in a large mixer at Höganäs Bjuv AB. After mixing the clay was stored for about one month.

The form produced blocks with the dimensions shown in Figure 5-5. 73 blocks in total were compacted. The compaction was made with the technique described in Section 5.2.

Density, water ratio and homogeneity were measured on 8 blocks. 4 samples were taken for investigation of the density and water ratio from each block. The locations of the samples are shown in Figure 5-5. The results from block 5 are as an example shown in Table 5-1. The results indicate that there are small differences in density within the block.

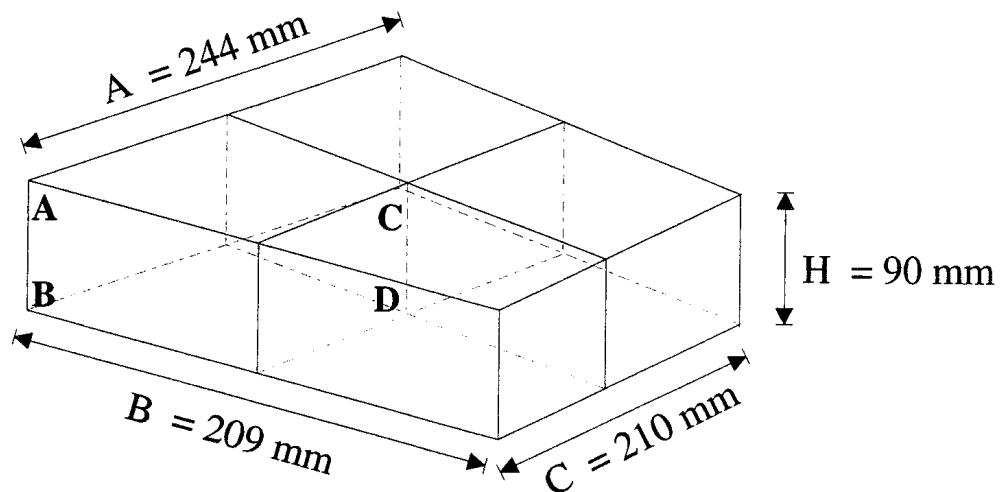

Figure 5-5. The dimensions of the blocks of IBECO compacted at Höganäs Bjuv AB in Bjuv. The points where samples were taken are also shown (A, B, C and D).

During the production of the 73 blocks the compaction pressure was changed which resulted in different densities of the blocks. This is shown in Table 5-2 where the water ratio, density etc. is shown.

All of the blocks had an acceptable quality. Directly after compaction there were no damages on the blocks. However, after the blocks had been stored for several months the edges of the blocks tended to become fragile.

Table 5-1. Water ratio (w), density (ρ), degree of saturation (S_r) and density at full saturation (ρ_m) at different locations in block 5 compacted at Höganäs Bjuf AB (IBECO bentonite).

Point	w (%)	ρ (g/cm ³)	S_r	e	ρ_m (g/cm ³)
A	17.4	2.06	0.825	0.587	2.12
B	17.5	2.05	0.825	0.591	2.12
C	17.3	2.08	0.840	0.571	2.13
D	17.1	2.08	0.836	0.569	2.14

Table 5-2. Water ratio (w), density (ρ), degree of saturation (S_r) and density at full saturation (ρ_m) for 8 blocks compacted at Höganäs Bjuf AB (IBECO bentonite).

No	w (%)	ρ (g/cm ³)	S_r	e	ρ_m (g/cm ³)
1	17.4	2.09	0.857	0.564	2.14
2	17.6	2.08	0.855	0.573	2.13
3	17.3	2.08	0.840	0.571	2.13
4	17.5	2.07	0.837	0.581	2.13
5	17.3	2.07	0.832	0.579	2.13
6	17.3	2.06	0.821	0.587	2.12
7	17.0	2.05	0.804	0.587	2.12
Contr.bl.	17.5	2.05	0.824	0.591	2.12

5.4 COMPACTION OF THE SPANISH BENTONITE

As described in Section 4.3.1 the technique used for producing the blocks of Spanish bentonite for the FEBEX field test was somewhat different from the technique used in the tests at Höganäs Bjuf AB (see Section 5.2). The blocks produced for the FEBEX test had a good quality. In order to see if it was possible to get the same results using the technique at Höganäs Bjuf AB some tests were performed with the Spanish bentonite named 70-IMA-3-4-0. The dimension of the form is shown in Figure 5-6. Tests with the same form were also performed with MX-80 and with a 50/50 mixture of IBECO A and IBECO D.

The compaction pressure was about 100 MPa. The tests were performed with the water ratio shown in Table 5-3. Both tests with and without lubricated form were performed (see Table 5-3). After compaction, the water ratio and density were measured at four different locations in the block (see Figure 5-6). The results from the measurements are shown in Table 5-3 where it can be seen that the tests with lubricated form yielded

somewhat lower void ratio of the blocks than the corresponding test with no lubricant on the form.

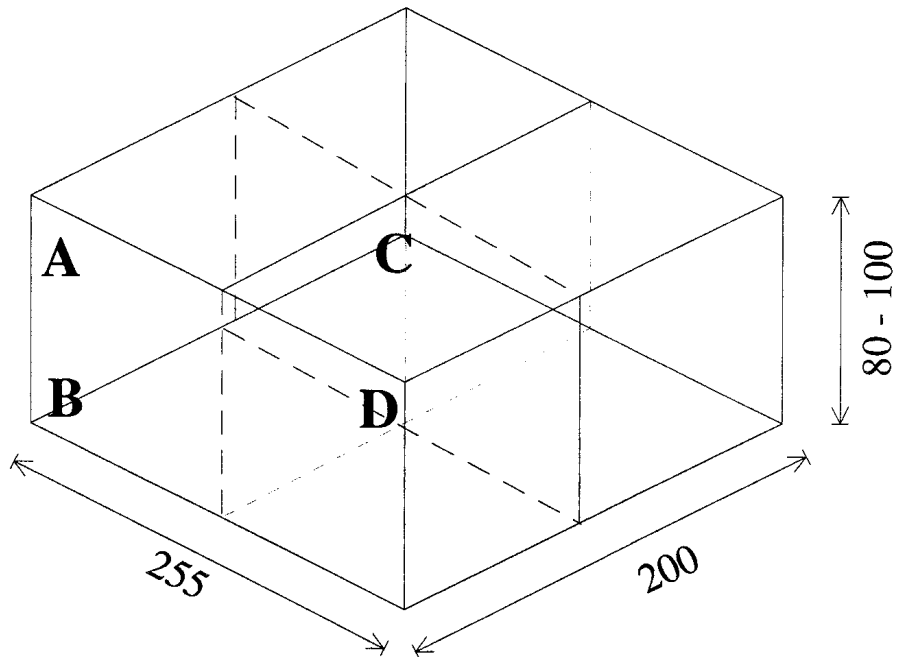

Figure 5-6. The dimensions of the blocks of 70-IMA-3-4-0 (Spanish clay) compacted at Höganäs Bjuv AB in Bjuv. The points where samples were taken are also shown (A, B, C and D).

Table 5-3. Water ratio (w), density (ρ), degree of saturation (S_r), void ratio (e) and density at full saturation (ρ_m) for 7 blocks compacted at Höganäs Bjuv AB.

No	Mtrl	Lubr.	w (%)	ρ (g/cm ³)	S_r	e	ρ_m (g/cm ³)
1	Spanish	Yes	14.3	2.05	0.720	0.55	2.15
6	Spanish	Yes	14.1	2.06	0.728	0.54	2.16
5	Spanish	No	14.1	2.04	0.704	0.56	2.14
2	MX-80	Yes	9.8	2.05	0.555	0.49	2.19
4	MX-80	No	9.7	2.01	0.519	0.52	2.17
7	IBECO	Yes	10.1	1.99	0.524	0.54	2.16
3	IBECO	No	10.2	2.00	0.535	0.53	2.16

After compaction the quality of the blocks was investigated. The edges of all blocks were damaged. The damages were not considered to affect the strength required for handling the blocks. The blocks compacted with the Spanish clay did not have as good quality as the blocks compacted for the FEBEX test which indicates that compaction with a conical form is favourable.

6 COMPACTION OF CYLINDRICAL BLOCKS WITH ϕ 250 MM

6.1 GENERAL

One way of constructing the buffer mass around the canister in the Swedish concept is to compact blocks with a full size diameter (ϕ 1650 mm). In order to investigate if this is possible, pretests were made in a form with a diameter of 250 mm. The compaction pressure varied between 50- 100 MPa (maximum compaction load 5000 kN). The tests were performed at Lund Institute of Technology, School of Civil Engineering in a press with maximum capacity of 10000 kN using the two clays MX-80 and IBECO C.

6.2 FORM CONSTRUCTION

A specially designed form was manufactured for the tests. Figure 6-1 shows a drawing of the form. Finn Jonsson at Finn Jonsson Engineering made the design of the form. It has a diameter of about 250 mm and produces blocks with a height of 100 mm. The form consists of three main parts; a bottom plate (No 12 in Figure 6-1), a cylinder (No 3) and a piston (No 1). The lowest part of the cylinder is conical (see Section 3.3) with an angle of about 1.4° to 100 mm from the bottom plate. There are filter stones (No 9) both in the piston and in the bottom plate. During the tests a vacuum pump can be connected to the filter stones and the compaction can be made with vacuum in the form. In order to retain the vacuum during the compaction, O-rings were installed both in the piston (No 4) and in the bottom plate (No 6). In the form there is an upper (No 10) as well as a lower sealing ring (No 11). The rings prevent bentonite from being squeezed out between the piston and the cylinder and between the cylinder and the bottom plate. To prevent damages on the cylinder, that may occur if the piston comes askew during the compaction, two guiding devices were placed between the form and the piston (No 8 and No 7).

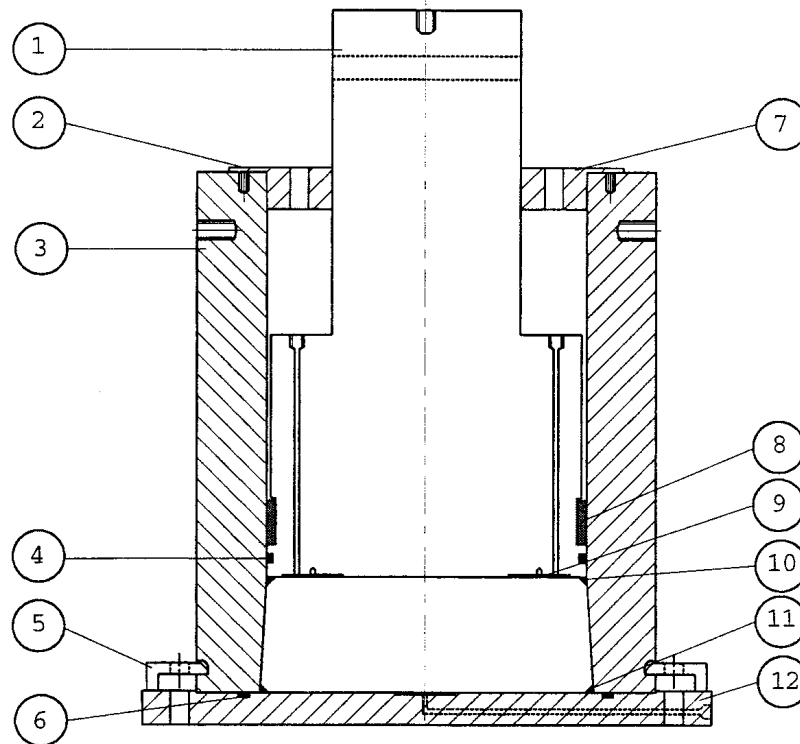

Figure 6-1. The form used for compaction of blocks with diameter 250 mm and height 100 mm.

6.3 COMPACTION TECHNIQUE

In some of the tests water was added to the clay in a mixer that can be seen in Figure 6-2. In most cases the mixtures rested for a couple of days before compaction in order to become more homogenous. The compaction was done in the following steps:

- the form was attached to the bottom plate
- the cylinder was lubricated
- the form was filled with bentonite
- the form was placed in the press
- vacuum was applied for evacuating the air from the bentonite in the form
- the bentonite was compacted with the press at a rate of 0.2 mm/s
- the ring was detached from the bottom plate
- the ring and the bentonite block were lifted and placed on a cylinder and the block was pushed out at a rate of 0.2 mm/s

In most of the tests the cylinder was lubricated with oil. During the compaction the load and the deformation were measured. In some tests the load was also measured when the blocks were pushed out from the form.

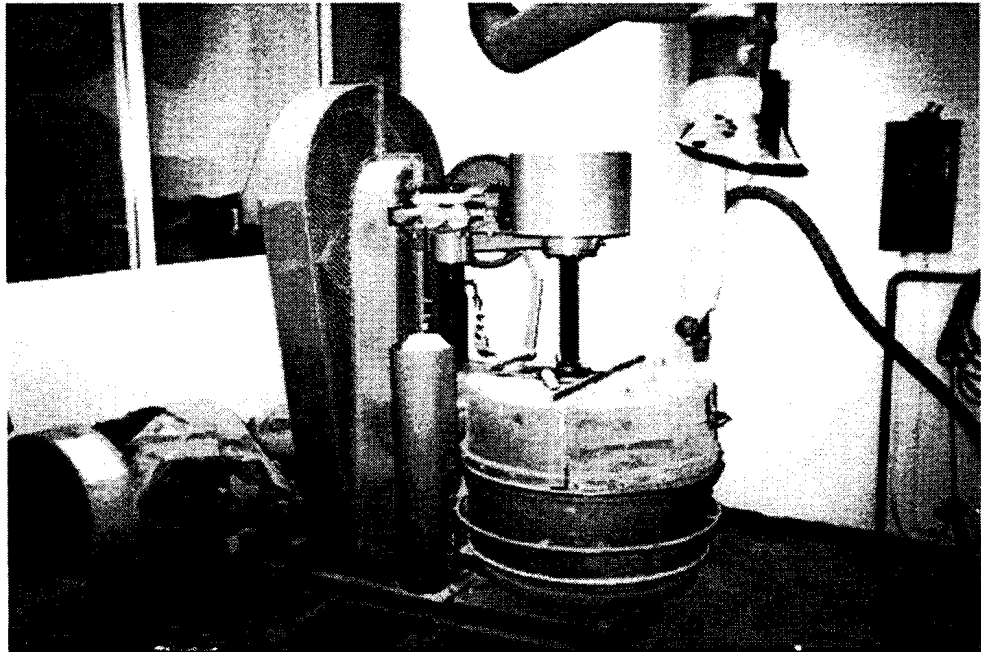

Figure 6-2. The mixer used in the tests.

6.4 RESULTS FROM THE COMPACTION TESTS

Compaction tests have been performed with two different clays, MX-80 and IBECO C (see Section 2) and with a water ratio that varied between 9% and 21%. In order to prevent damages on the form the blocks with a higher water ratio than 12% were compacted with a maximum compaction pressure of 50 MPa while blocks with lower water ratio were compacted with 100 MPa. All blocks were compacted at a constant deformation rate of 0.2 mm/s.

Results from measurements of compaction pressure as a function of the deformation at different water ratios are shown in Figure 6-3. Since the final height of the blocks is about 100 mm the figure shows that the bentonite was compacted to nearly half its initial volume. Furthermore, the figure shows that at low compaction pressure, the increase in stress with decreasing volume was rather small (small derivative). The derivative of the curves is increasing with increasing deformation. At high loads a rather small deformation resulted in a large increase in stress. This was especially obvious at a high water ratio.

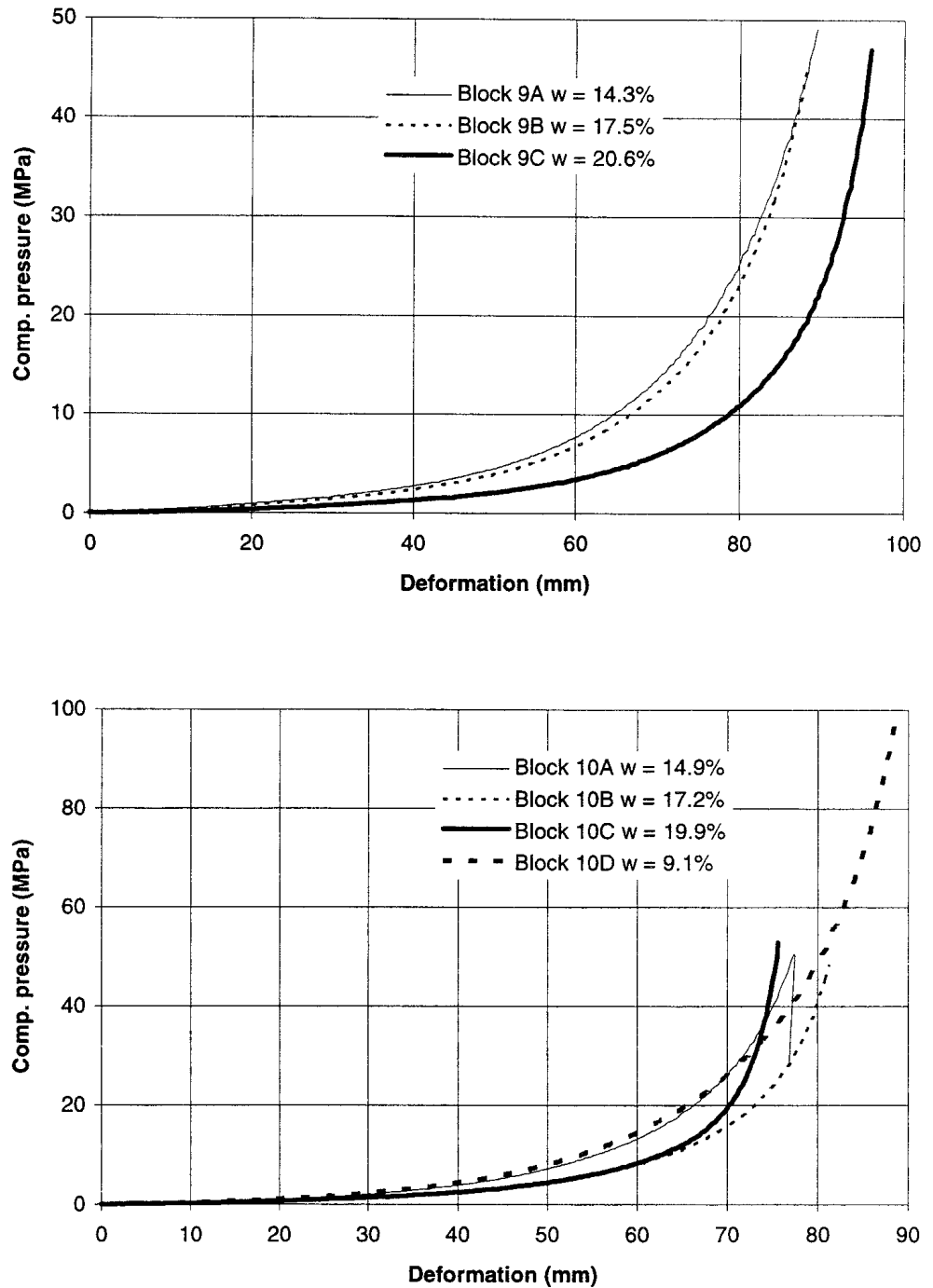

Figure 6-3. Compaction pressure as a function of the deformation of the bentonite during compaction of blocks of IBECO C (upper) and MX-80 (lower) at different water ratios.

Figure 6-4 shows the load during release of the blocks from the form after compaction plotted as a function of displacement of the piston. The figure shows that the required load decreased with increasing water ratio of the clay. The figure also shows that the maximum load was reached at a displacement between 1 and 2 mm (1 - 2% of the height of the blocks) and then decreased rather rapidly. The results show that with a conical form the

blocks can rather easily be released from the form with a load smaller than 3% of the compaction load.

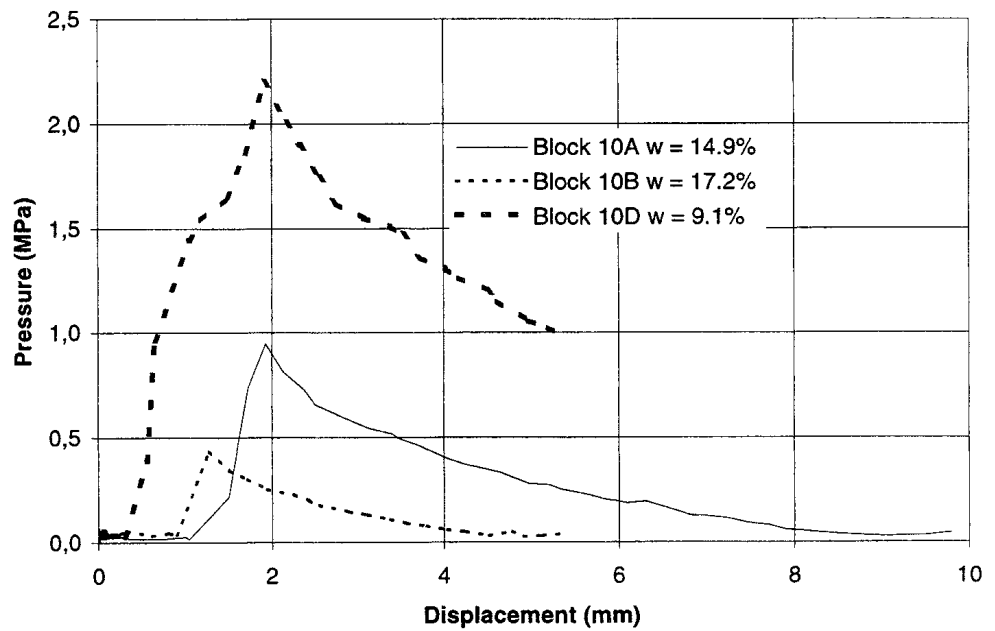
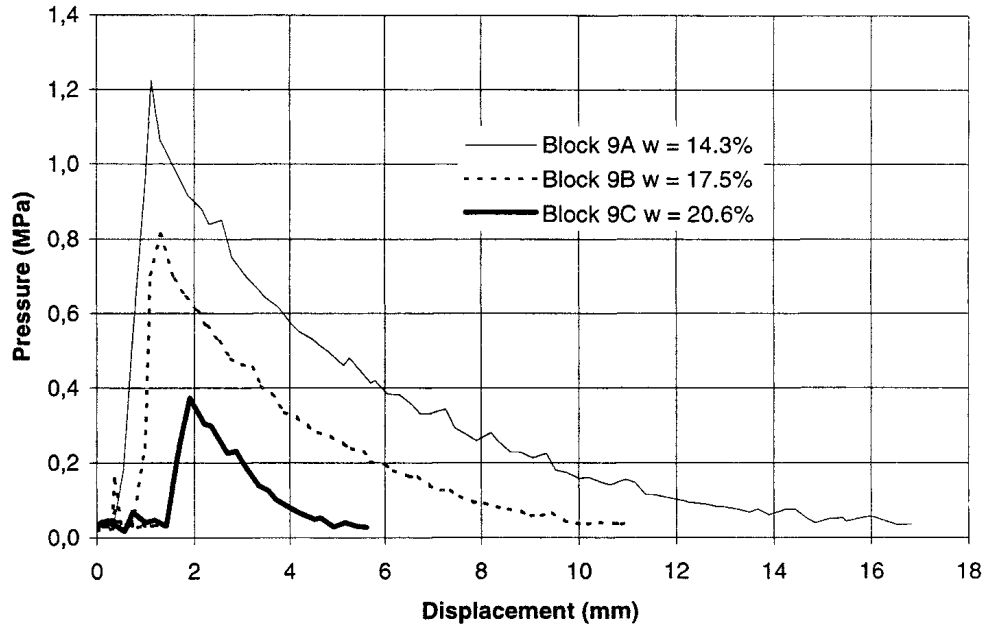

Figure 6-4. The pressure during release of the blocks from the form as function of the displacement of the piston for blocks of IBECO C (upper) and MX-80 (lower) at different water ratios.

The density and water ratio after compaction were measured at four different locations within the blocks (see Figure 6-5). Those densities and other properties of the blocks are shown in Table 6-1. The mean values of water ratio and density are used to calculate the void ratio (e) and the degree of saturation (S_r). The table indicates that most blocks were fairly homogeneous. The blocks from Series 1 to 4 (see Table 6-1) were compacted in a form which was not conical. All blocks in those series had damages on the upper part due to the elastic deformation during the release of the blocks from the form (see also Section 3.3). After series 4 the form was reconstructed to the final design shown in Figure 6-1. With the new form no damages were observed on the blocks. Figure 6-6 shows a picture of a block of IBECO C. In Figure 6-7 the void ratio is plotted as a function of water ratio for all the blocks and some smaller samples. The figure shows the following:

- The void ratio of the blocks compacted with 100 MPa is somewhat lower than for smaller samples (higher density)
- The void ratio of the blocks compacted with IBECO is somewhat lower than for those compacted with MX-80

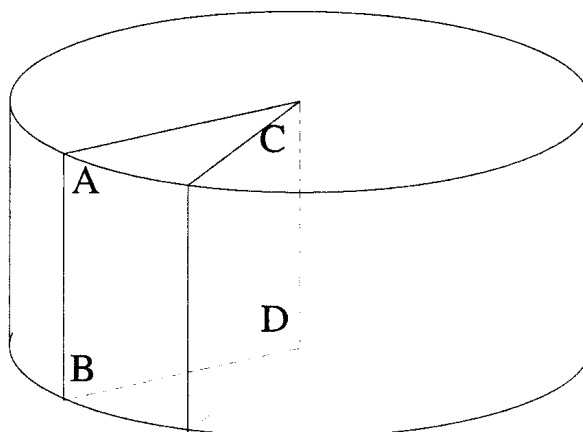

Figure 6-5. *The location of the points where samples were taken from the blocks.*

Table 6-1. Water ratio (w), density (ρ), degree of saturation (S_r), void ratio (e) and density at full saturation (ρ_m) for the blocks compacted in the form with ϕ 250 mm.

No		Comp (MPa)	ρ_A (g/cm ³)	ρ_B (g/cm ³)	ρ_C (g/cm ³)	ρ_D (g/cm ³)	ρ_{mean} (g/cm ³)	w (%)	S_r	e	ρ_m (g/cm ³)
1:1	MX-80	50	2.03	2.03	2.01	2.04	2.03	14.9	0.719	0.576	2.13
1:2	MX-80	50	2.05	2.05	2.03	2.06	2.05	18.1	0.832	0.604	2.11
1:3	MX-80	50	2.06	2.06	2.04	2.05	2.05	20.7	0.907	0.634	2.09
1:4	MX-80	100	2.11	2.12	2.09	2.12	2.11	11.5	0.679	0.470	2.21
2:1	MX-80	50	2.01	2.02	1.99	2.02	2.01	14.6	0.695	0.585	2.12
2:2	MX-80	50	2.04	2.03	2.01	2.04	2.03	18.2	0.817	0.618	2.10
2:3	MX-80	50	2.05	2.05	2.01	2.04	2.04	20.6	0.885	0.647	2.08
2:4	MX-80	100	2.11	2.10	2.07	2.10	2.10	10.6	0.630	0.466	2.21
3:1	MX-80	50	2.04	2.02	2.00		2.02	14.6	0.703	0.578	2.13
3:2	MX-80	50	2.04	2.04	2.01	2.03	2.03	17.9	0.810	0.613	2.10
3:3	MX-80	50	2.04	2.05	2.01	2.05	2.04	20.6	0.886	0.645	2.08
3:4	MX-80	100	2.10	2.10	2.06	2.10	2.09	11.1	0.646	0.476	2.21
4:1	MX-80	50	2.05	2.03	2.02	2.03	2.03	14.8	0.719	0.571	2.13
4:2	MX-80	50	2.04	2.04	2.03	2.04	2.04	17.8	0.814	0.607	2.11
4:3	MX-80	50	2.06	2.06	2.06	2.06	2.06	20.4	0.906	0.624	2.10
4:4	MX-80	100	2.11	2.09	2.07	2.10	2.09	9.6	0.587	0.455	2.22
6:1	MX-80	50	2.01	2.00	2.00	2.01	2.00	14.1	0.674	0.584	2.12
6:2	MX-80	50	2.03	2.02	2.02	2.02	2.02	16.7	0.769	0.602	2.11
6:3	MX-80	50	2.05	2.06	2.06	2.06	2.06	20.3	0.902	0.626	2.09
6:4	MX-80	100	2.10	2.10	2.10	2.10	2.10	12.1	0.692	0.485	2.20
7:1	IBECO C	50	1.97	1.99	1.98	1.95	1.97	15.7	0.693	0.630	2.09
7:2	IBECO C	50	2.00	2.02	2.00	1.98	2.00	18.4	0.791	0.646	2.08
7:3	IBECO C	50	2.02	2.02	2.02	1.99	2.01	20.9	0.866	0.671	2.07
8:1	IBECO C	50	1.97	1.98	1.97	1.96	1.97	15.9	0.696	0.634	2.09
8:2	IBECO C	50	1.99	1.99	1.99	1.98	1.99	18.8	0.789	0.662	2.07
8:3	IBECO C	50	2.01	2.02	2.00	1.99	2.00	19.8	0.833	0.661	2.07
9:1	IBECO C	50	1.96	1.90	1.95		1.94	14.3	0.622	0.638	2.09
9:2	IBECO C	50	1.99	1.97	1.99	1.99	1.98	17.5	0.750	0.648	2.08
9:3	IBECO C	50	2.01	1.99	2.01	2.01	2.01	20.6	0.854	0.672	2.06
10:1	MX-80	50		1.98	2.00	2.01	2.00	14.9	0.689	0.601	2.11
10:2	MX-80	50		2.00	2.01	2.01	2.01	17.2	0.769	0.621	2.10
10:3	MX-80	50		2.04	2.03	2.05	2.04	19.9	0.878	0.631	2.09
10:4	MX-80	100		2.01	2.08	2.07	2.05	9.1	0.529	0.477	2.21
11:1	MX-80	50	2.06	2.04	2.05	2.05	2.05	19.7	0.880	0.624	2.10
11:2	MX-80	100	2.08	2.05	2.07	2.07	2.07	9.2	0.549	0.466	2.21
12:1	IBECO C	50	2.02	1.98	2.02	2.01	2.01	20.6	0.855	0.671	2.07
12:2	IBECO C	50		1.90	1.95		1.93	14.2	0.611	0.643	2.08



Figure 6-6. A compacted block of IBECO C. Compaction pressure 50 MPa.

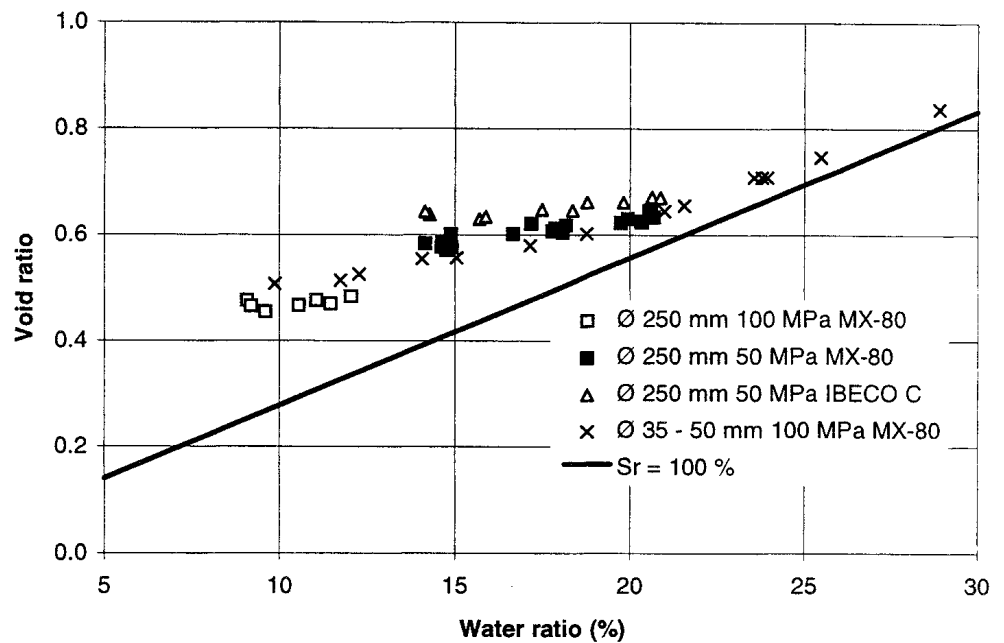

Figure 6-7. Compilation of compaction results. Void ratio as a function of water ratio for blocks (ϕ 250 mm) and smaller sample (ϕ 35 - 50 mm).

7 COMPACTION OF RING SHAPED BLOCKS

7.1 GENERAL

As mentioned in Section 6.1 one way of making the buffer material for a repository is to compact blocks with full diameter (ϕ 1650 mm). In the position of the canister the blocks must be ring shaped with an inner diameter of about 1070 mm. In order to investigate the possibility to compact rings of bentonites, blocks were compacted with an outer diameter of 250 mm and an inner diameter of 156 mm. All the tests were made with MX-80 and a compaction pressure of 100 MPa.

7.2 FORM CONSTRUCTION

A special designed form shown in Figure 7-1 was manufactured for the tests. Finn Jonsson at Finn Jonsson Engineering designed the form. The form consist of four main parts; a bottom plate (No 2 in Figure 7-1), an outer cylinder (No 1), an inner cylinder (No 3) and a piston (No 4). The lowest part of the outer cylinder is conical. The outer cylinder wall is inclined about 1.4° from the symmetry axis up to 100 mm from the bottom plate. There are filter stones in the bottom plate (No 12). During the tests a vacuum pump can be connected to the filter stones and the compaction can be made with vacuum in the form. Both in the piston (No 15 and 16) and in the bottom plate (No 14 and 17) there are O-rings in order to retain the vacuum during the compaction. There are two upper (No 8 and 9) and two lower sealing rings (No 10 and 11). The rings prevent bentonite from being squeezed out between the piston and the cylinders and between the cylinders and the bottom plate during compaction. To prevent the piston from inclining during the compaction two guiding devices were placed on the outer cylinder and on the piston (No 6 and 23). Placing rings of steel at the bottom of the form (No 7) made it possible to vary the block heights between 25, 50, 75 and 100 mm. Figure 7-2 shows a picture of the device and the press.

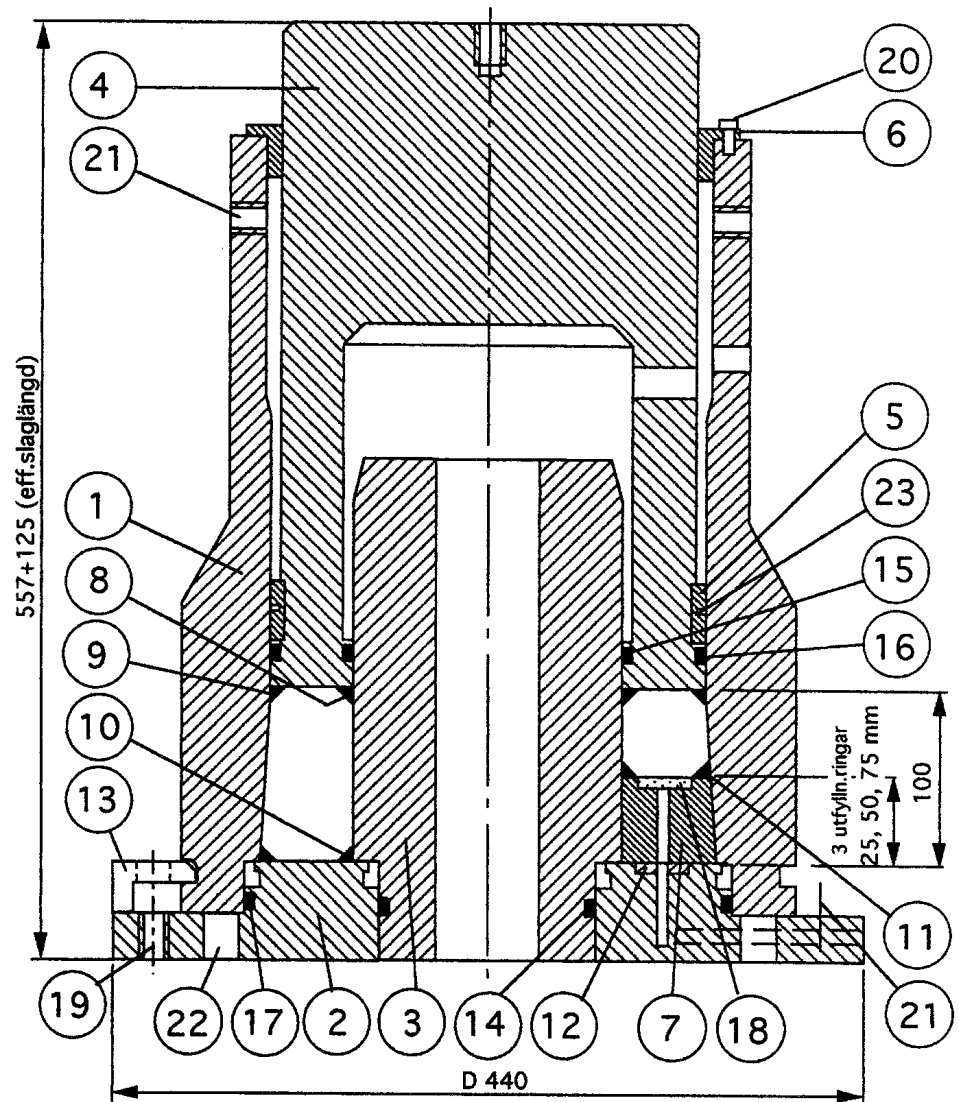

Figure 7-1. The form used for compaction of ring shaped blocks with an inner diameter of 156 mm and an outer diameter of 250 mm.

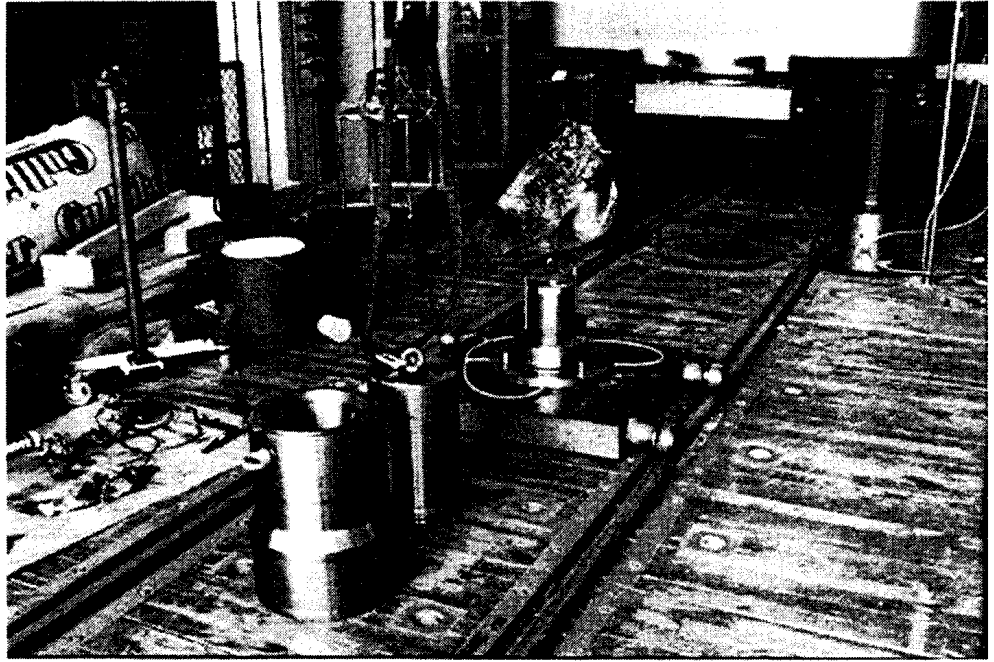

Figure 7-2. The outer cylinder, the piston, the inner cylinder placed on the bottom plate, together with the used press.

7.3 COMPACTION TECHNIQUE

In some of the tests the clay was mixed with water in a mixer before it was compacted. A picture of the mixer is shown in Figure 7-3. The mixer is constructed for mixing smaller volumes of mortar. The mixtures usually rested for a couple of days in order to become more homogeneous. The procedure for compacting the blocks is the same as described in Section 6.3.

In most of the tests the cylinders were lubricated with MOLYKOTE BR 2 plus[®] with molybdenum disulfide (MoS_2). The load and the deformation were measured during the compaction. In some tests the load was also measured when the blocks were pushed out from the form. Due to the expansion of the blocks after removal from the outer cylinder no force was needed to release the inner cylinder from the blocks. The blocks were wrapped in plastic in order to avoid desiccation.

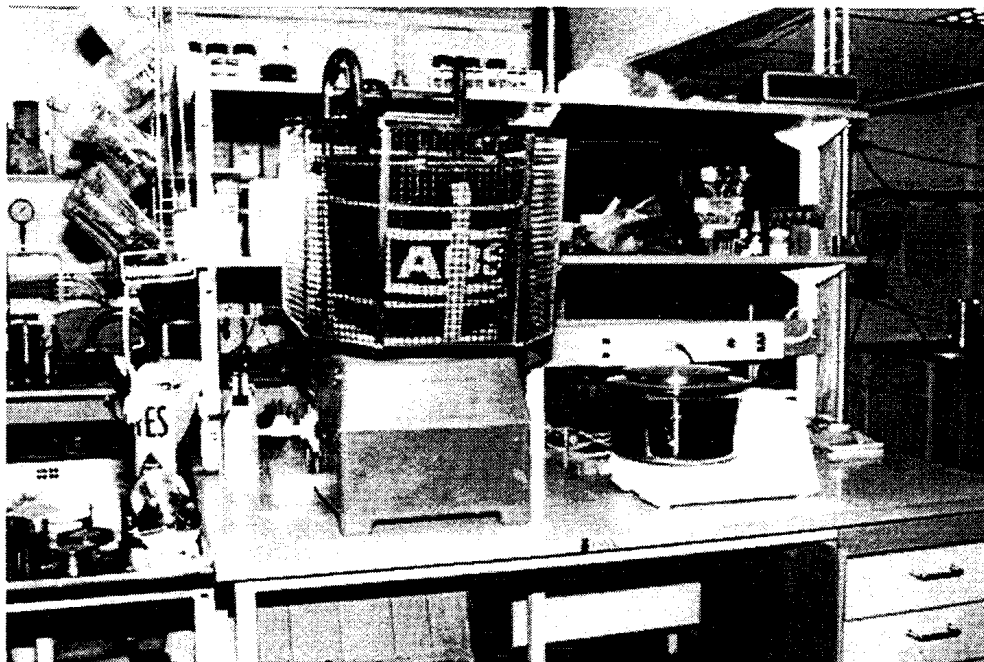

Figure 7-3. The mixer to the left was used in the tests.

7.4 RESULTS FROM THE COMPACTION TESTS

A total number of 28 blocks were compacted in the form. The water ratio and the height of the blocks were varied. The density and water ratio after compaction were measured at different locations within the blocks (see Figure 7-4) as well as the total weight and volume of the blocks. The mean of the measured water ratio and density (from measurement of weight and volume) are shown in Table 7-1 as well as the calculated void ratio (e) and degree of saturation (S_r). A picture of compacted blocks is shown in Figure 7-5. In Figure 7-6 void ratio is plotted as function of water ratio. The figure also shows the results from compaction of small, samples (ϕ 35-50 mm) that were not ring-shaped. The plot shows that the differences in void ratio between the blocks with different heights are small although the blocks with 25 mm height of 25 mm tended to have a slightly higher void ratio (lower density).

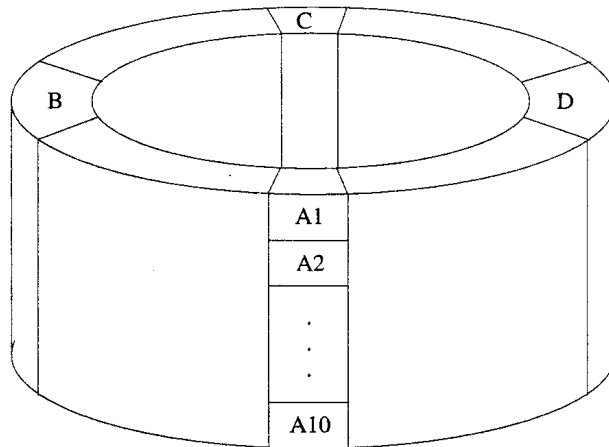

Figure 7-4. The location of the points where samples were taken from the ring shaped blocks. Total amount of samples was 13.

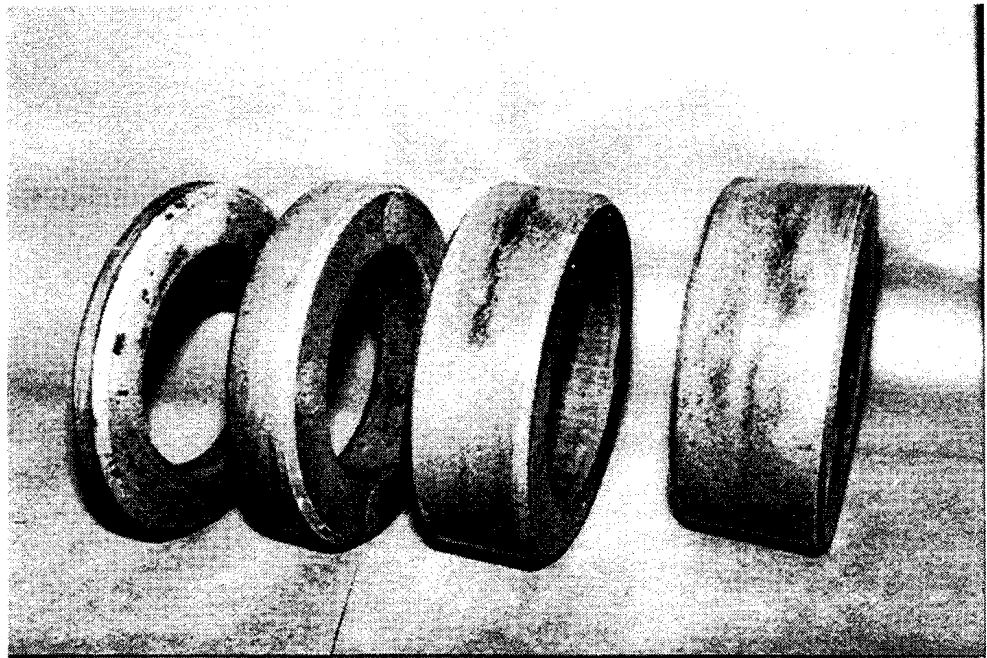

Figure 7-4. Blocks of MX-80 compacted in the ring shaped form.

Table 7-1. Water ratio (w), density (ρ), degree of saturation (S_r), void ratio (e) and density at full saturation (ρ_m) for the blocks compacted with the ring shaped form with different heights. Compaction pressure 100 MPa.

No	Height (mm)	w (%)	ρ (g/cm ³)	S_r	e	ρ_m (g/cm ³)
Ring 1	101.0	8.6	2.04	0.494	0.482	2.20
Ring 2	75.4	8.5	2.04	0.497	0.478	2.20
Ring 3	49.9	8.6	2.03	0.493	0.484	2.20
Ring 4	24.9	8.7	2.03	0.492	0.489	2.20
Ring 5	100.0	14.8	2.05	0.733	0.559	2.14
Ring 6	75.0	14.9	2.08	0.778	0.534	2.16
Ring 7	50.0	14.9	2.08	0.769	0.540	2.16
Ring 8	25.0	14.7	2.07	0.761	0.538	2.16
Ring 9	99.8	16.1	2.10	0.829	0.539	2.16
Ring 10	75.7	16.7	2.09	0.846	0.549	2.15
Ring 11	51.1	16.2	2.08	0.816	0.553	2.15
Ring 12	25.6	15.4	2.06	0.767	0.559	2.14
Ring 13	100.1	19.3	2.06	0.885	0.607	2.11
Ring 14	75.4	18.6	2.07	0.867	0.596	2.12
Ring 15	49.7	18.5	2.07	0.865	0.595	2.12
Ring 16	25.5	18.7	2.03	0.833	0.623	2.10
Ring 17	97.2	13.7	2.10	0.749	0.508	2.18
Ring 18	73.2	13.6	2.09	0.746	0.508	2.18
Ring 19	49.7	12.4	2.10	0.703	0.492	2.19
Ring 20	26.9	12.3	2.00	0.614	0.558	2.14
Ring 21	101.4	10.3	2.03	0.562	0.508	2.18
Ring 22	100.9	10.3	2.05	0.572	0.499	2.19
Ring 23	98.7	17.4	2.09	0.859	0.562	2.14
Ring 24	99.0	17.5	2.08	0.850	0.571	2.13
Ring 25	100.5	20.8	2.06	0.916	0.631	2.09
Ring 26	75.8	20.6	2.06	0.909	0.630	2.09
Ring 27	49.7	20.5	2.07	0.922	0.618	2.10
Ring 28	25.3	20.6	2.08	0.933	0.612	2.10

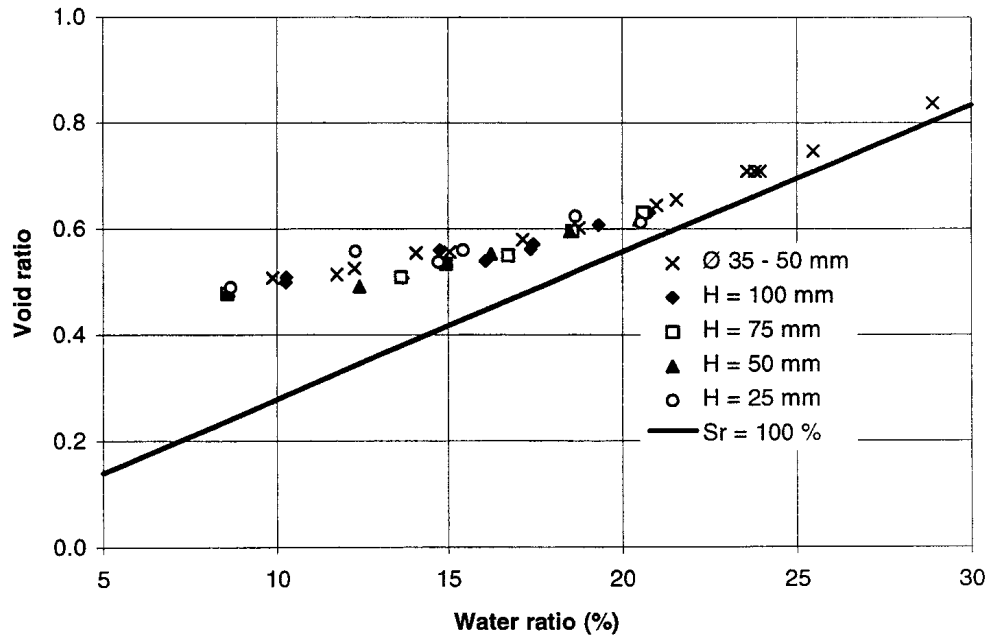

Figure 7-6. *Compilation of compaction results, showing void ratio as a function of water ratio for ring shaped blocks with different heights and small not ring shaped sample (ϕ 35 - 50 mm). The compaction pressure is 100 MPa.*

In Figure 7-7 the bulk density of blocks with four different heights and two different water ratios is plotted as a function of location within the block (see Figure 7-4). The figure indicates that the bulk density is rather uniform for blocks with heights between 50 - 100 mm while blocks with a 25 mm height show a rather high 25 mm inhomogeneity. This is more apparent for the block with low water ratio. This phenomenon could be due to that

- the bentonite was not filled in the form to a uniform density and this became permanent when the deformation of the bentonite during the compaction was small, that is for the lower blocks. At the compaction of higher blocks the primary inhomogeneity was smoothed out during the large deformation of the bentonite.
- the height of the bentonite before compaction varied in the form. For a low block the variation could be large in comparison with the block height which resulted in a large variation in density.

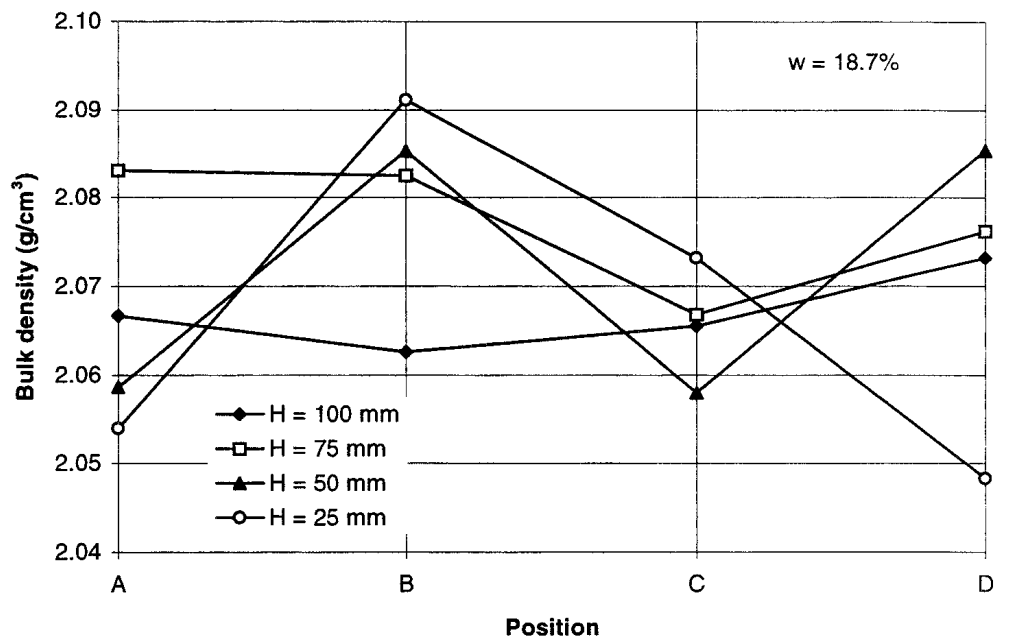
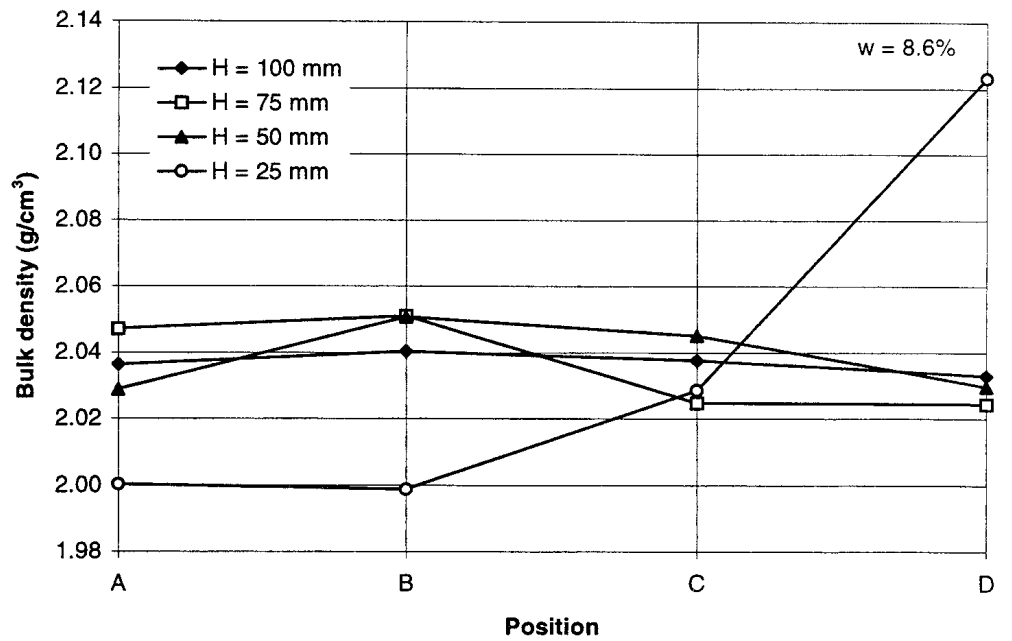

Figure 7-7. Bulk density plotted as functions of location in the blocks with four different heights and two different water ratios (8.6% and 18.7%). Compaction pressure 100 MPa.

Figure 7-8 shows the measurements in section A of the blocks (see Figure 7-4). The form was lubricated in all tests. The density and void ratio are plotted as functions of distance from the top of the blocks. The following conclusions can be drawn from these results:

- The highest density in the blocks was reached about 30 mm from top of the blocks
- In most of the tests the lowest density was reached at the bottom
- Although the blocks were very homogeneous the variation in the density is tended to increase with decreasing water ratio, except for the block with water ratio 20.8 % which was the most inhomogeneous block.

Figure 7-9 shows the results from tests where the effect of lubricant on the form was investigated. Blocks with similar water ratio were compacted using the device described above both with and without lubricant. The figure indicates that at a low water ratio (10.3%), the lubricant has some effect on the homogeneity of the blocks, while at a higher water ratio (17.3 - 17.5%) the effect is negligible. For the block compacted with no lubricant and $w = 10.3\%$ the density varied between $1.98 - 2.09 \text{ g/cm}^3$ while for the corresponding block compacted with lubricated form the density varied between $2.02 - 2.07 \text{ g/cm}^3$.

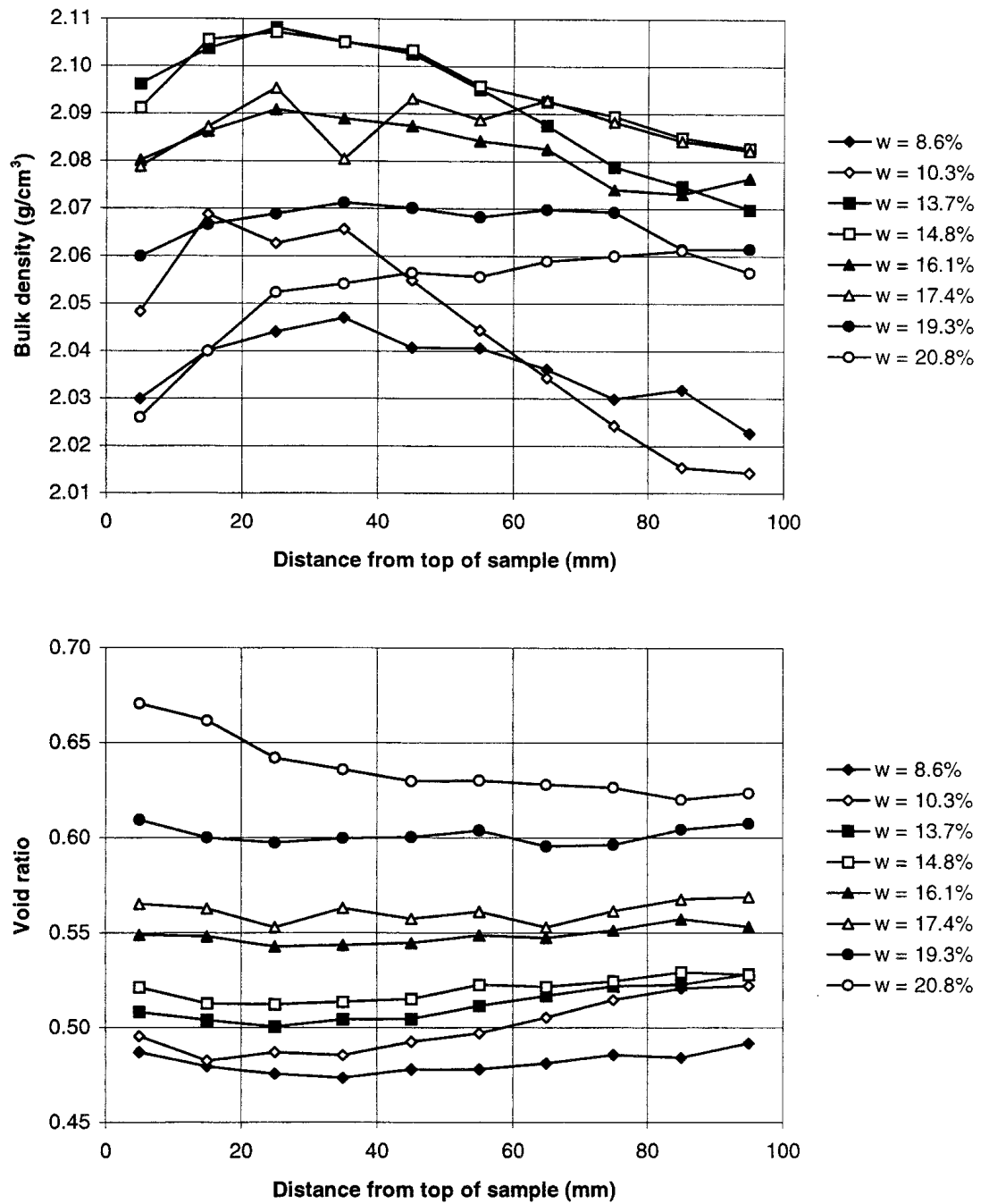

Figure 7-8. Bulk density and void ratio plotted as functions of the distance from the top surface for blocks with different water ratios. Compaction pressure 100 MPa.

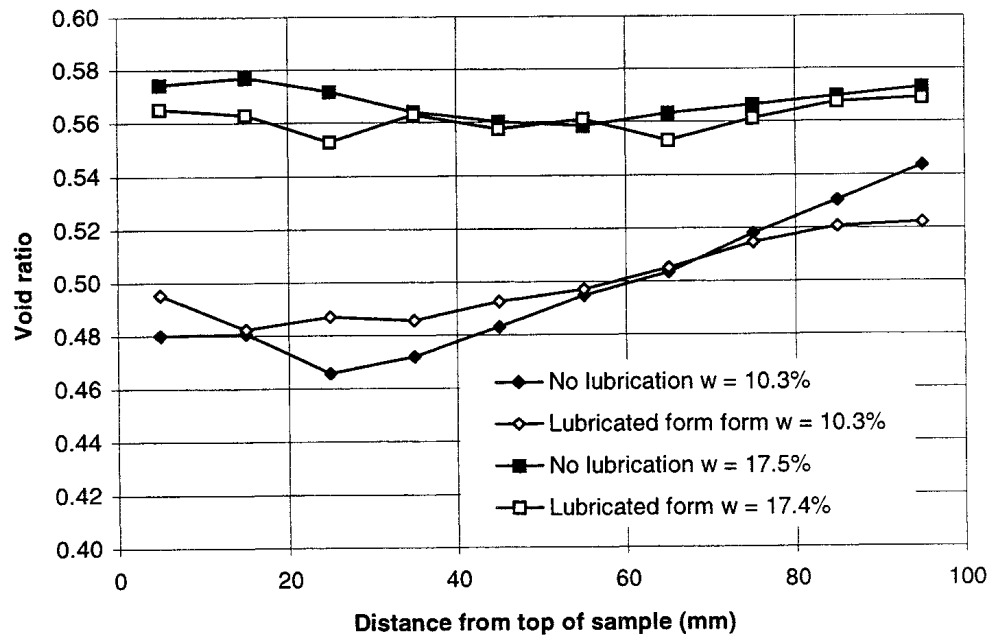
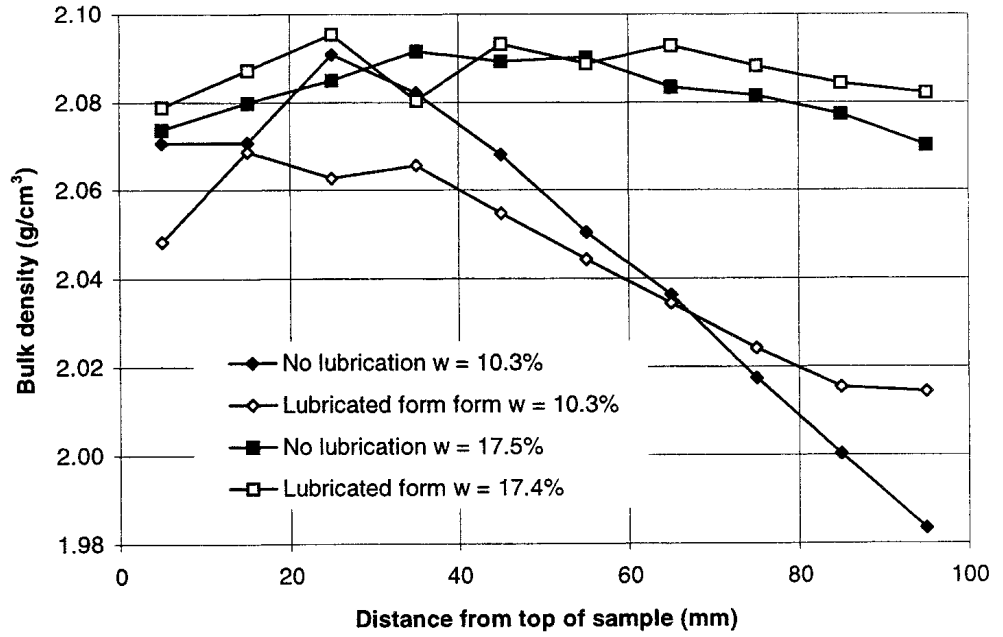

Figure 7-9. Bulk density and void ratio plotted as functions of the distance from the top surface of the blocks with and without lubricant on the form. Compaction pressure 100 MPa.

7.5 BLOCK DAMAGES

Cracks were observed both on the inner and the outer surface of some blocks, particularly those with low water ratio and without lubricant on the form at the compaction. Figure 7-10 shows two pictures of block 21 which was compacted without lubricant and with a low water content of the bentonite (10.3%). The picture shows small cracks both on the inner and outer surface at the top of the blocks. The cracks did not extend very far into the blocks and did not seem to affect the possibility to handle the blocks. The explanation for these cracks is most probably that the blocks swelled upwards in axial direction during the reloading after compaction, causing a high radial pressure due to the conical surface of the form (see also Section 8.5).

The cracks may be avoided by minimizing the swelling of the blocks and the friction between the bentonite and the form. This can be achieved by using bentonite with high water ratio and a lubricated form. Another way to avoid the cracks is to allow the blocks to swell downwards in axial direction after compaction. This can be obtained by locking the piston to the form at maximum compaction load and then detach the form from the bottom plate before reloading the block.

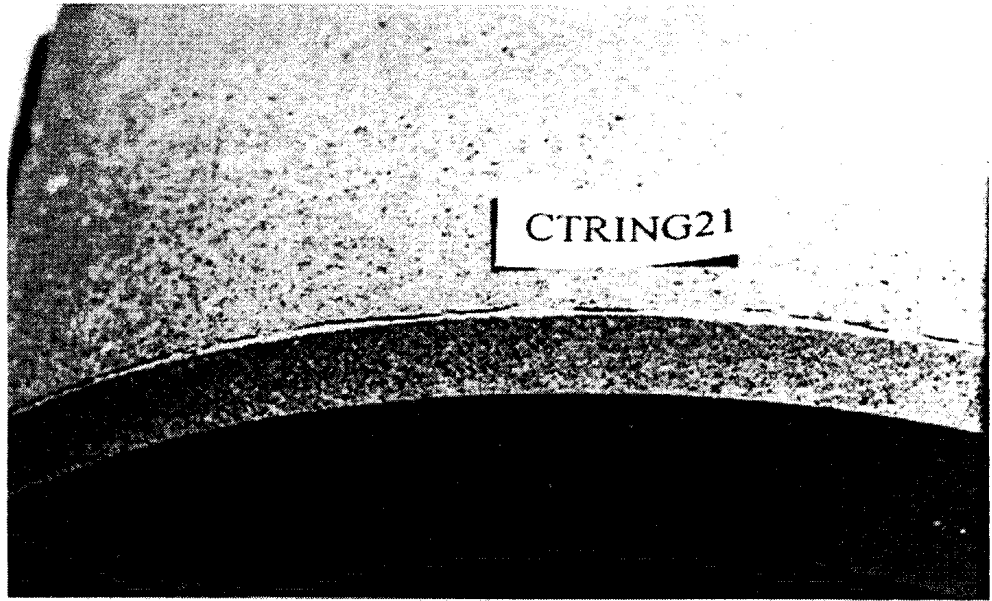

Figure 7-10. Pictures of block 21. The block was compacted without lubricant on the form and with a water ratio of 10.3%. Compaction pressure 100 MPa.

8 **COMPACTION OF CYLINDRICAL BLOCKS WITH ϕ 1000 MM**

8.1 **GENERAL**

In the tests described in Section 6, blocks with a 250 mm diameter were compacted. The results from these tests indicate that it might be possible to use the technique for compacting full size blocks (ϕ 1650 mm). The next step in developing the compaction technique was to compact blocks with an almost full size. A form with a diameter of 1000 mm was constructed and a number of compaction tests were performed. The compaction pressure at most tests was 100 MPa (compaction load 80.000 kN). The tests were performed at HYDROWELD in Ystad in a press with a maximum capacity of 300.000 kN. All tests were performed with MX-80.

8.2 **FORM CONSTRUCTION**

Figure 8-1 shows a drawing of the form. Finn Jonsson at Finn Jonsson Engineering made the design of the form. The form has a diameter of 1000 mm and a height of about 625 mm. After compaction the blocks had a height of about 350 mm. The form consists of three main parts; a bottom plate (No 4 in Figure 8-1), a cylinder (No 1), and a piston (No 2). The most-lower part of the cylinder is conical in order to prevent damages on the blocks during removal from the cylinder (see Section 3.3). The lower part of the cylinder wall is inclined about 1.4° to the distance 350 mm from the bottom plate. There are filter stones (No 10) both in the piston and in the bottom plate. A vacuum pump can be connected to the filter stones and the compaction can be made with vacuum. In order to retain the vacuum during the compaction there are O-rings both in the piston (No 9) and in the bottom plate. There are both an upper (No 6) and a lower sealing ring (No 7) in the form. No further guiding of the piston was used in the tests.

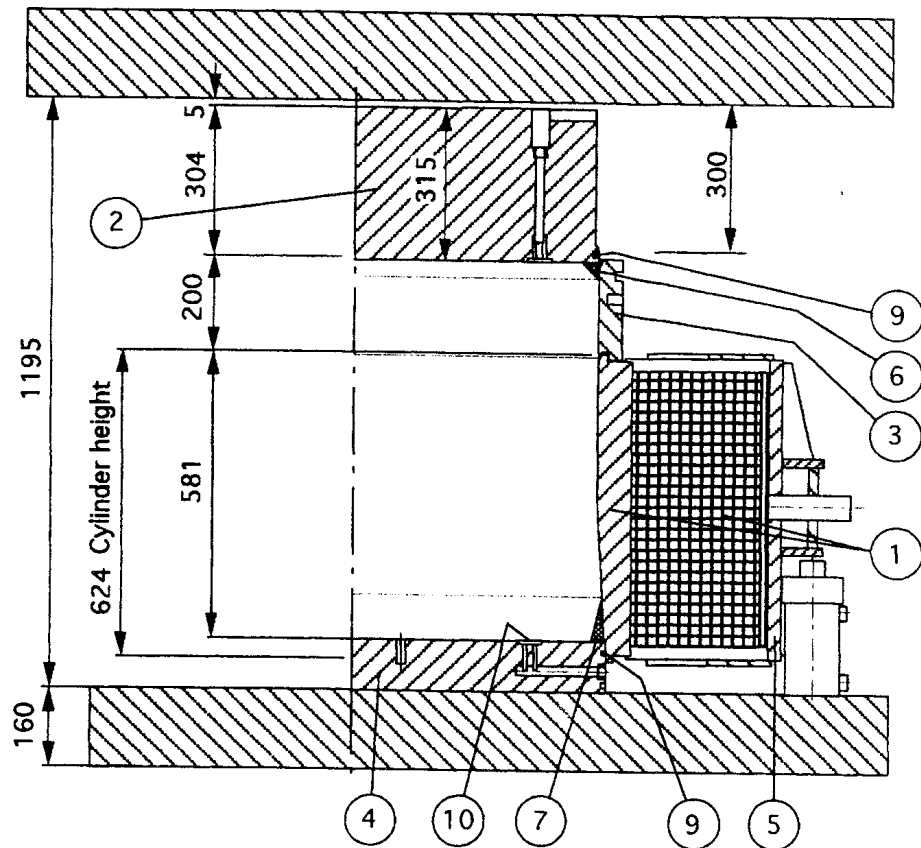

Figure 8-1. The form used for compaction of blocks with the diameter 1000 mm. The main components of the form are described in the text.

8.3 COMPACTION TECHNIQUE

In some of the tests the clay was mixed with water in a mixer which is shown in Figure 8-2 and which normally is used for mixing concrete. The capacity of the mixer is about 150 kg. The mixtures were allowed to rest for a couple of days in order to be more homogeneous. The compaction procedure was the same as described in Section 6.3.

A picture of the form and the press is shown in Figure 8-3. The form is placed on a movable platform, which can be rolled into the press.

The blocks weighed about 600 kg and in order to be able to handle them two holes were drilled and screws attached to the blocks (see Figure 8-5). The block was then lifted with an overhead crane.

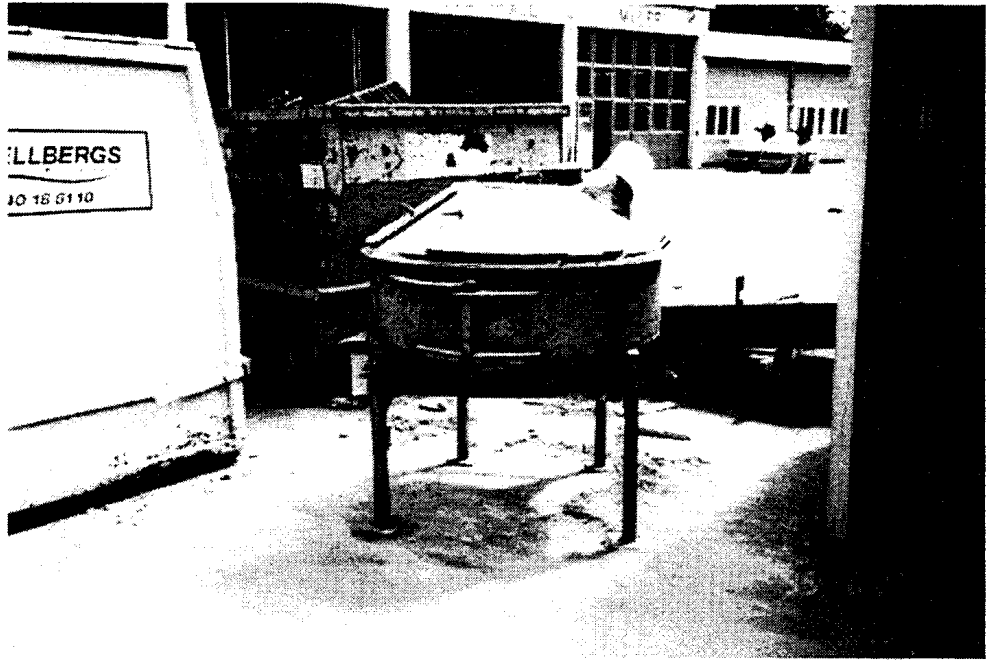

Figure 8-2. The mixer used for the tests.

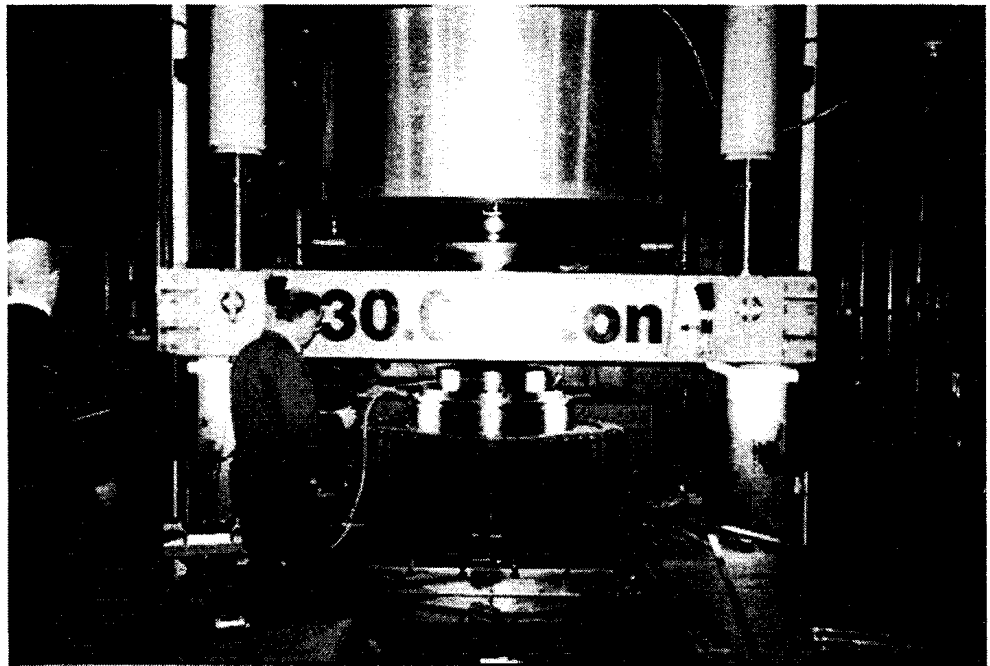

Figure 8-3. The form and the press.

The cylinder was lubricated in all tests. Two types of lubricant were used; an oil and the grease MOLYKOTE BR 2 plus[®] with molybdenum disulfide (MoS₂). In some tests the deformation and load were measured during compaction. In some tests the load was also measured when the blocks were released from the form. At the beginning of the tests the compaction rate was about 6-7 mm/s. After the compaction load had reached 20 to 40 MN, the compaction rate was decreased to about 0.1 mm/s. Results from two tests are shown in Figure 8-4.

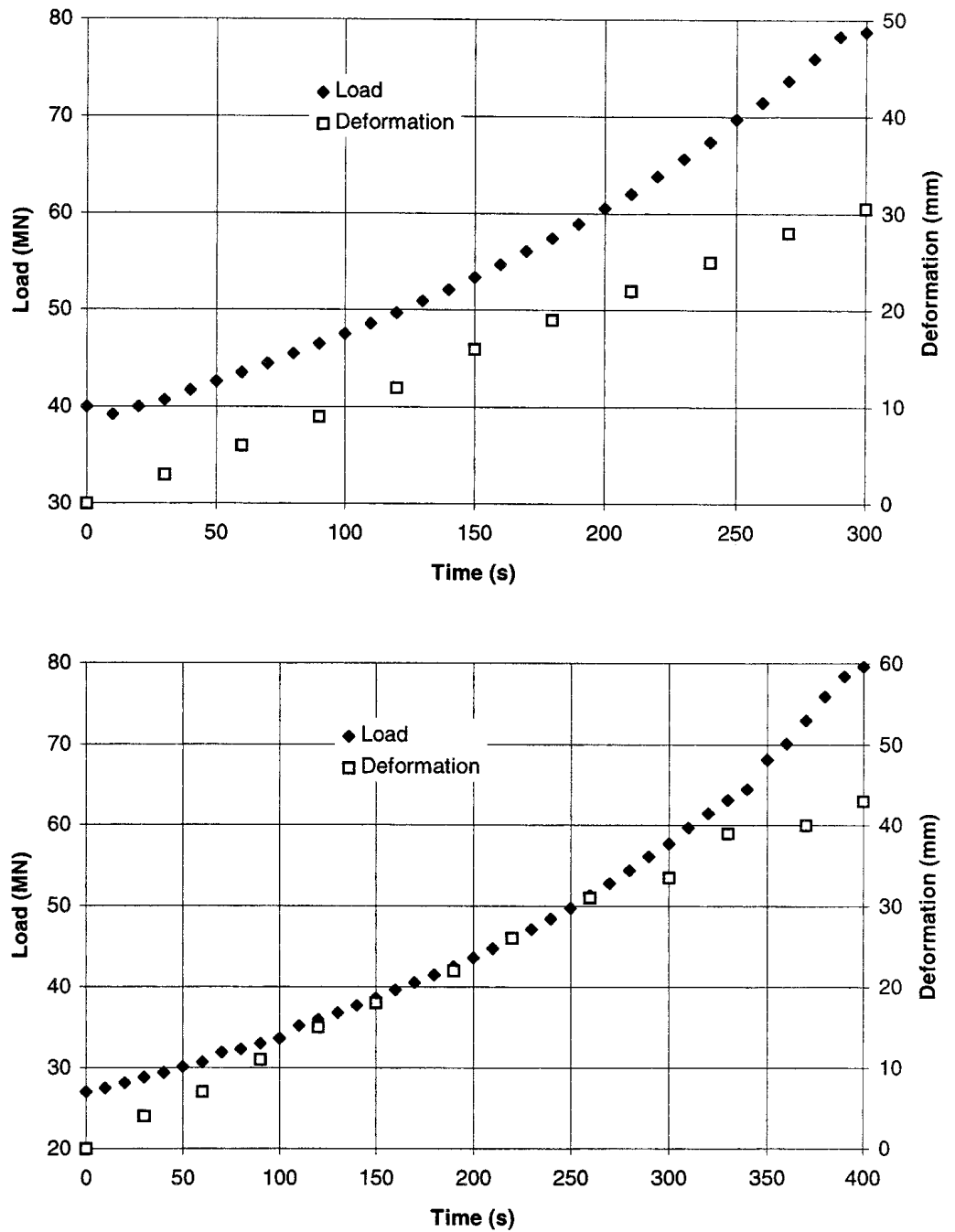

Figure 8-4. Compaction pressure and deformation as a function of time for Block 3 (a) and Block 4 (b).

8.4 RESULTS FROM THE COMPACTION TESTS

13 large blocks were compacted. One of them is shown in Figure 8-5. After compaction pieces, were sawed from the blocks (see Figure 8-6). The density and water ratio were measured at different locations within the pieces (see Figure 8-6). The total weight and volume of the blocks were also measured. The results from measured and calculated properties of one block are shown in Table 8-1. The table shows that the density was rather uniform in the block. The lowest density was measured in the periphery at the bottom of the block (point 15 in Figure 8-6). The density in the rest of the block is rather uniform.

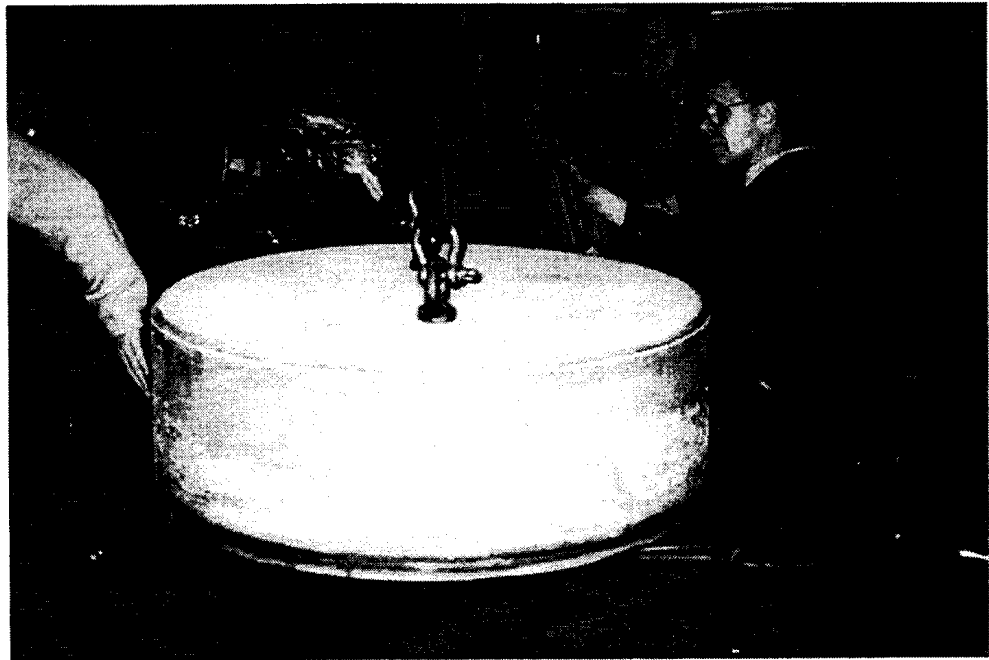

Figure 8-5. A compacted block

The mean value and standard deviation of the density of all blocks are shown in Table 8-2. The blocks with a low water ratio had a larger standard deviation due to higher friction between the bentonite and the form. MOLYKOTE BR 2 plus[®] as a lubricant (test 8, 9 and 11) implied smaller standard deviation than corresponding (same water ratio) tests with oil.

In Figure 8-7 the void ratios of the blocks are plotted as a function of water ratio. In the figure are also the results from compaction of smaller samples (ϕ 35-50 mm) plotted. The void ratio of the blocks is in general somewhat lower (higher dry density) than the void ratio of the smaller samples. The figure is also show that the void ratio of the block compacted at 150 MPa is, as expected, lower than for corresponding block compacted at 100 MPa.

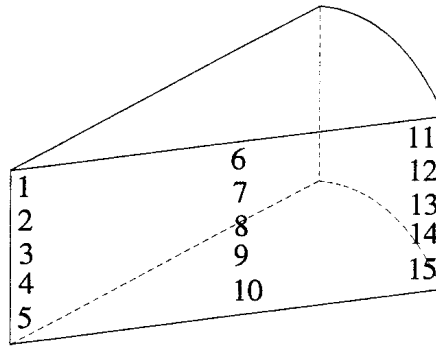

Figure 8-6. The location of the points where samples were taken from the blocks. The total amount of samples was 15.

Table 8-1. Water ratio (w), density (ρ), degree of saturation (S_r), void ratio (e) and density at full saturation (ρ_m) for block 8.

No	w (%)	ρ (g/cm^3)	S_r	e	ρ_m (g/cm^3)
1	16.4	2.10	0.840	0.544	2.15
2	16.8	2.09	0.848	0.550	2.15
3	16.6	2.10	0.845	0.546	2.15
4	16.5	2.10	0.847	0.542	2.15
5	16.8	2.09	0.847	0.550	2.15
6	15.9	2.10	0.824	0.537	2.16
7	16.6	2.09	0.840	0.549	2.15
8	16.7	2.09	0.845	0.548	2.15
9	16.3	2.10	0.840	0.539	2.16
10	16.8	2.09	0.847	0.550	2.15
11	16.2	2.10	0.834	0.540	2.16
12	16.6	2.11	0.855	0.539	2.16
13	16.4	2.09	0.831	0.549	2.15
14	16.1	2.09	0.822	0.544	2.15
15	16.6	2.08	0.826	0.558	2.14
Mean	16.5	2.09	0.839	0.546	2.15

Table 8-2. Water ratio (w), mean density (ρ), variation in density, standard deviation of density, degree of saturation (S_r), void ratio (e) and density at fully saturation (ρ_m) for blocks with ϕ 1000 mm.

No	Comp.stress (MPa)	w (%)	ρ_{mean} (g/cm ³)	$\rho_{\text{max}} - \rho_{\text{min}}$ (g/cm ³)	St.dev. ρ_{mean} (g/cm ³)	S_r	e	ρ_m (g/cm ³)
1	100	10.8	2.09	0.09	0.021	0.632	0.474	2.21
2	100	11.1	2.11	0.07	0.016	0.663	0.465	2.22
3	100	11.4	2.10	0.08	0.017	0.671	0.473	2.21
4	100	11.4	2.10	0.08	0.019	0.667	0.475	2.21
5	150	11.4	2.16	0.05	0.010	0.730	0.434	2.24
6	100	14.9	2.08	0.01	0.005	0.769	0.539	2.16
6B	100	14.3	2.09	0.05	0.011	0.766	0.518	2.17
7	100	17.5	2.07	0.01	0.005	0.838	0.580	2.13
7B	100	17.5	2.08	0.03	0.007	0.853	0.571	2.13
8	100	16.5	2.09	0.03	0.006	0.839	0.546	2.15
9	100	10.9	2.10	0.04	0.010	0.649	0.466	2.21
10	100	21.0	2.05	0.01	0.004	0.907	0.643	2.08
11	50-100	22.7	2.04	0.02	0.006	0.938	0.674	2.06

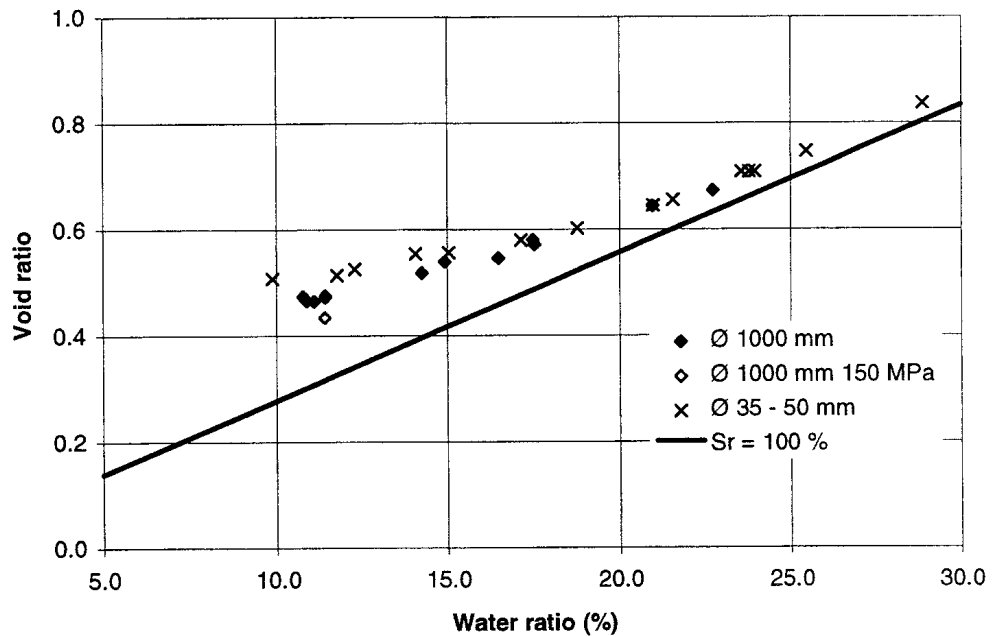

Figure 8-7. Compilation of compaction results. Void ratio as a function of water ratio for blocks with ϕ 1000 mm and for small samples (ϕ 35 - 50 mm). Compaction pressure 100 MPa.

8.5 BLOCK DAMAGES

After removal from the form the blocks were inspected and pieces were cut from the blocks. A crack was observed in the upper part in most blocks. The damages were more common on blocks compacted with low water ratio. Block 11, with the highest water ratio ($w = 22.7\%$), had no cracks. An example of the typical crack is shown in Figure 8-8. The length of the crack was 3- 5 cm. It was not considered to affect the strength required for handling the blocks. One hypothesis is that the swelling of the blocks during the relief of the compaction pressure causes the cracks. In Figure 8-9 the load and swelling of block 2 in vertical direction during unloading is plotted. The figure indicates that the block swelled more than 9 mm. Since the form is conical the swelling of the block creates large horizontal stresses in the upper part of the block. Expansion of the diameter of the blocks can also create large horizontal stresses. In Figure 8-10 the expansion of both ring-shaped and cylindrical blocks are plotted as functions of the water ratio. The expansion (ϵ) is defined as

$$\epsilon = \frac{D_{Block} - D_{form}}{D_{form}} \quad (8-1)$$

where D_{Block} is the diameter of the block and D_{form} is the corresponding diameter of the form. The figure shows that the expansion decreases with increasing water ratio, which explains why the damages are more common in blocks with low water ratio.

Three blocks (Block 3, 6 and 7) had more comprehensive damages. The damages were assumed to be caused by air trapped in the block during the compaction. Complete evacuation of air during compaction is required to avoid this type of damages.

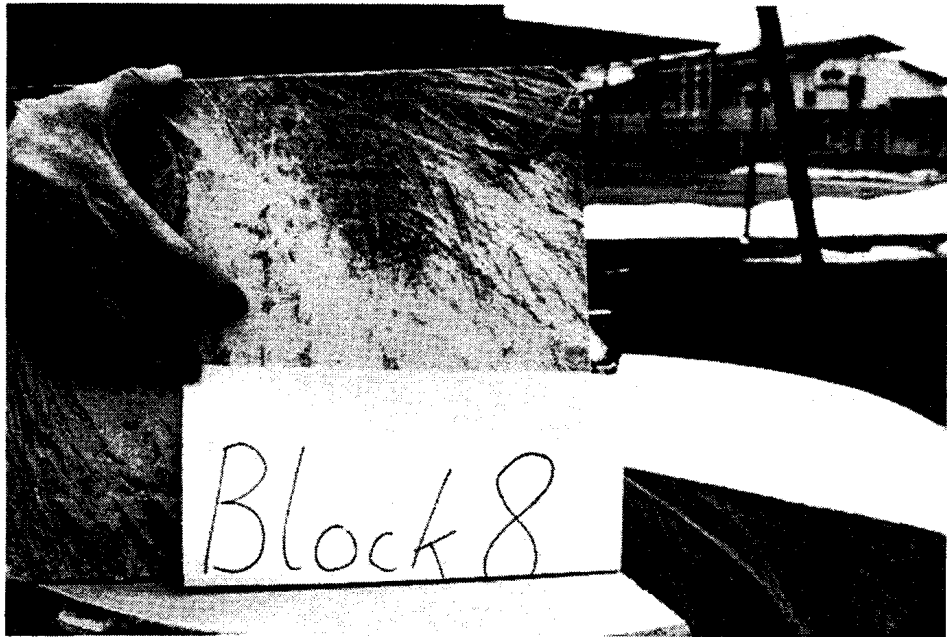

Figure 8-8. Block 8 after a slice of bentonite was sawed from the block.

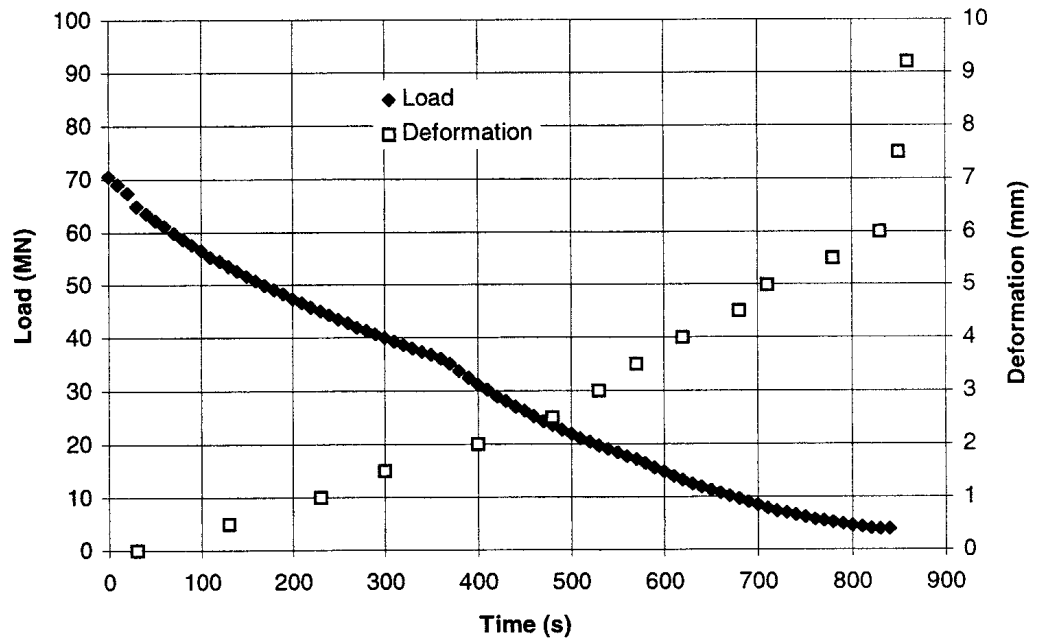

Figure 8-9. *Compaction force and deformation as a function of time for Block 2 during unloading of the block.*

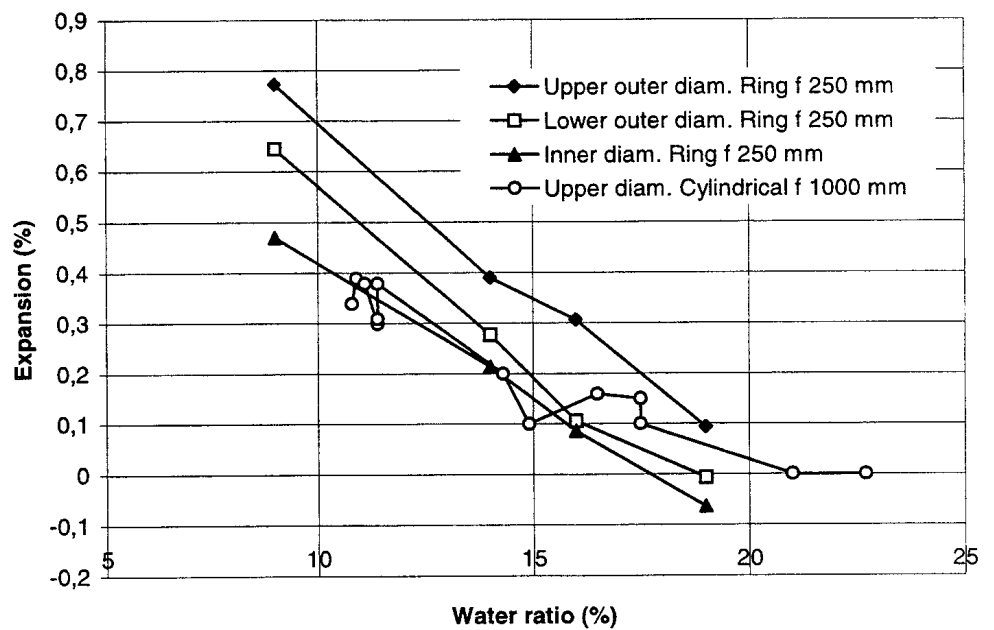

Figure 8-10. *The expansion of the diameter of both ring-shaped and cylindrical blocks as a function of the water ratio at compaction.*

9 CONCLUSIONS AND DISCUSSION

The tests performed in laboratory scale (in a small form with a 50 mm diameter) showed that

- when using lubricant on the form (MOLYKOTE BR 2 plus[®] with molybdenum disulfide (MoS₂)) it was possible to get a homogeneous sample even if the ratio between the height and the diameter of the sample was as large as $H/D = 2$ and the water ratio was low. Previous tests have shown that without lubricant the ratio should not be larger than 0.4 in order to get a homogenous sample. The tests also showed that at a water ratio of about 18% it was possible to get a rather homogenous sample even without lubricated form ($H/D = 2$).
- tests performed with granulated MX-80 after drying showed that at low water ratio the density reached at compaction was somewhat higher than for the corresponding samples compacted with untreated MX-80. A possible explanation is that the density of the granules is higher after drying. At higher water ratio the effect of the granulation was insignificant.
- tests performed with the Spanish Ca-bentonite 70-IMA-3-4-0 gave a similar compaction curve as for MX-80.

Experiments with compaction of both small "brick size" blocks and larger blocks were performed. The large blocks had a diameter of 1000 mm. Ring shaped blocks with an outer diameter of about 250 mm were also compacted. The results from the tests showed the following:

- Blocks of bentonite with various size and shape can be produced with an acceptable quality.
- The "brick size" blocks were compacted rather rapidly. In order to avoid damages on the blocks due to entrapped air the compaction have to be done stepwise and a more coarsely ground bentonite should be used. The form should also be lubricated. It might also be favorable if the sides of the form are not parallel (conical form)
- Ring shaped blocks have been compacted with good results. The blocks were homogeneous and did not have comprehensive damages. The blocks were compacted rather slowly and the compaction was done with vacuum in the form. Furthermore, the form was lubricated and the outer

cylindrical surface had a conical shape. Even though the blocks were rather small (outer diameter 250 mm, inner diameter 156 mm) the results indicate the possibility to compact ring-shaped blocks with the same diameter as a deposition hole.

- Cylindrical blocks with 250 mm and 1000 mm diameter were compacted. The same technique as for the ring shaped blocks was used. The quality of the smaller blocks was very good. The larger ones had a damage close to the upper surface. The damages have been considered to be of no importance for the handling of the blocks and the behavior after deposition.

Figure 9-1 shows a compilation of some results from compaction tests performed with MX-80 summarized. The figure shows that the void ratio for the smaller samples are higher (lower density) than for the larger blocks. The figure also indicates that the ring shaped blocks had a somewhat higher void ratio than the rest of the blocks.

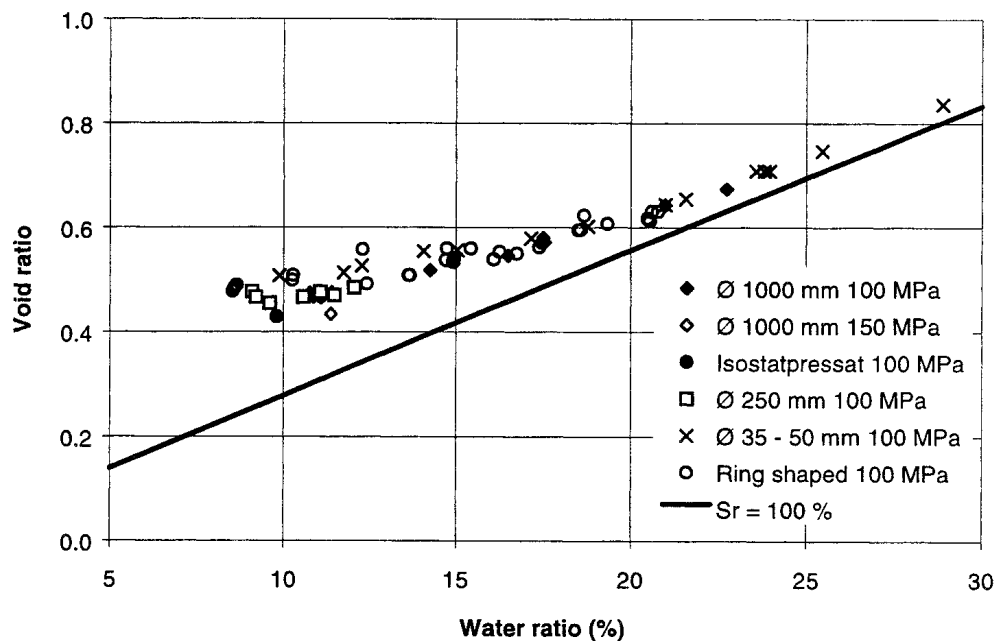

Figure 9-1. Compilation of compaction results. Void ratio as a function of water ratio for blocks with different sizes. Compaction pressure 100 MPa.

REFERENCES

Börgesson L, Johannesson L-E, Fredrikson A, 1993. Laboratory investigation of highly compacted bentonite blocks for buffer material. Compaction technique and material composition. SKB Projektrapport PR 44-93-009.

Börgesson L, Johannesson L-E, Fredrikson A, 1993. Laboratory investigation of highly compacted sand/bentonite blocks for backfilling. Compaction technique, material properties and repository function. SKB Projektrapport PR 44-93-010.

Johannesson L-E, Börjesson L, Sandén T, 1994. Compaction in an industrial environment of blocks which are manageable by man (in Swedish). SKB TPM 94-4430-02.

Johannesson L-E, Börjesson L, Sandén T, 1995. Compaction of bentonite blocks for buffer material (in Swedish). SKB AR D-95-001.

Johannesson L-E, Börjesson L, Sandén T, 1995. Compaction of bentonite blocks. Development of technique for industrial production of blocks which are manageable by man. SKB TR 95-19.

Karnland O, Pusch R, Sandén T, 1992. Characterization of buffer material. Laboratory methods for determining mineralogical and physical properties (in Swedish). SKB AR 94-60.

Karnland O, Pusch R, Sandén T, 1994. Concerning bentonite/cement interaction, 4 month tests. SKB Arbetsrapport AR 94-22.

Pusch, R, 1973. Densitet vattenhalt och portal. Förslag till geotekniska laboratorieanvisningar (in Swedish). Byggforskningens informationsblad B5:1973.