

International  
Progress Report

**IPR-06-31**

# Äspö Hard Rock Laboratory

## Cleaning and sealing of Borehole

### Report of Sub-project 4 on sealing of 200 mm boreholes at Äspö

Roland Pusch  
Geodevelopment International AB

Gunnar Ramqvist  
Eltekno AB

February 2007

***Svensk Kärnbränslehantering AB***

Swedish Nuclear Fuel  
and Waste Management Co  
Box 5864  
SE-102 40 Stockholm Sweden  
Tel 08-459 84 00  
+46 8 459 84 00  
Fax 08-661 57 19  
+46 8 661 57 19



**Äspö Hard Rock  
Laboratory**



Report no.  
**IPR-06-31**

Author  
**Roland Pusch  
Gunnar Ramqvist**

Checked by  
**Christer Svemar  
Jukka-Pekka Salo  
Antti Öhberg**

Approved  
**Anders Sjöland**

No.  
**F98K**

Date  
**February 2007**

Date  
**May 2007**

Date  
**2007-07-04**

# Äspö Hard Rock Laboratory

## Cleaning and sealing of Borehole

### Report of Sub-project 4 on sealing of 200 mm boreholes at Äspö

Roland Pusch  
Geodevelopment International AB

Gunnar Ramqvist  
Eltekno AB

February 2007

**Keywords:** Plugging, Sealing, Bentonite, Borehole, Concrete

This report concerns a study which was conducted for SKB. The conclusions and viewpoints presented in the report are those of the author(s) and do not necessarily coincide with those of the client.



## Abstract

The major aim of Sub-project 4 was to work out design and prototype versions of plugs for sealing the upper part of large-diameter holes bored from the ground surface. Two plug types were developed, one made of copper, and the other of CBI concrete (low-pH, very Si-rich “silica concrete”) that was cast in three test holes.

Experiments at the ground surface comprised placement of a copper and a concrete plug in 5 and 20 m deep, 200 mm diameter holes bored vertically. They were retrieved by slot drilling and the extracted plugs were cut axially by sawing for visualising the interaction of the plugs with the rock. Examination of the dissected plugs with surrounding rock showed that both types worked as expected and that these principles of sealing wide boreholes can be used in practice. No loading for measuring the strength of the plugs was made.

Underground experiments at 450 m depth were made by casting CBI silica concrete in two 1.9 m deep boreholes with 200 mm diameter and loading them axially to determine the bearing capacity. Three different concrete materials were used, one being “reference” CBI concrete, and two with quartzite fragment mixed into the concrete to 10 and 20 % fractions by mass. The experiments showed that all the plugs could withstand a load of more than 100 tons and that the concrete without quartzite was more ductile and began to undergo plastization at lower loads than the ones with quartzite.

Plugs of copper and concrete of the tested types are concluded to be long-lasting and to fulfil the requirements of serving as effective mechanical seals in boreholes with different diameters.



## Summary

The major aim of Sub-project 4 was to work out design and prototype versions of plugs for sealing the upper part of large-diameter holes bored from the ground surface. The criteria for such plugs are that they do not have to be particularly tight but must serve as “mechanical locks” for at least 100 000 years and behave like rock, i.e. have a compressive strength of at least 20 MPa. They have to be keyed in the rock to take this axial pressure without yielding or being extruded. Two plug types were developed, one made of copper and consisting of a conical central part surrounded by coarse lamellae that are pressed out into a recess reamed out in the rock, and the other being made of CBI concrete (low-pH, very Si-rich “silica concrete”) that is cast in the hole equipped with the same type of recess as the copper plug.

Two sets of experiments have been made, one at the ground surface and the other at a few hundred meter depth at the Äspö URL. The first mentioned experiments comprised placement of a copper and a concrete plug in 5 and 20 m deep, 200 mm diameter holes bored vertically from the ground surface for investigating their function. This was made by retrieving them by slot drilling after prestressing the copper plug to make it expand, and after letting the concrete mature for one month. The extracted plugs were cut axially by sawing for visualising the interaction of the plugs with the rock. Examination of the dissected plugs with surrounding rock showed that both types worked as expected and that these principles of sealing wide boreholes can be used in practice. No loading for measuring the strength of the plugs was made.

The other set of experiments was conducted at 450 m depth using concrete cast in 1.9 m deep boreholes with 200 mm diameter that were equipped with recesses by application of a special reaming tool. These plugs were loaded axially to determine the bearing capacity. Three different concrete materials were used, one being “reference” CBI concrete, and two with quartzite fragment mixed into the concrete to 10 and 20 % fractions by mass. Loading was made by use of a steel beam that was anchored to the rock so that loads of a few hundred tons could be applied and strain gauges were used for recording the displacement of the plugs as a function of the applied load. The experiments showed that all the plugs could withstand a load of more than 100 tons corresponding to actual pressures of more than 3 MPa and that the concrete without quartzite was more ductile and began to undergo plastization at lower loads than the ones with quartzite. The stiffest and strongest concrete plug was the one with 20 % quartzite fragments. The recorded loads corresponding to plastization and initiation of failure were in good agreement with predicted values based on preceding laboratory tests. A separate shearing test in the lab for determining the creep behaviour of the CBI concrete showed that it performs as natural and artificial materials exhibiting primary, secondary and tertiary creep.





# Sammanfattning

Huvudsyftet med Sub-project 4 var att utarbeta design och prototyper av plugversioner för försegling av övre delen av hål med stor diameter borrade från markytan. Kriterierna för sådana pluggar är att de inte behöver vara särskilt täta men måste under minst 100 000 år fungera som ”mekaniska lås” och som berg, dvs. ha en tryckhållfasthet av minst 20 MPa. De måste fällas in i berget för att ta upp detta axiella tryck utan att brista eller tryckas ut. Två pluggtyper valdes, en metallisk av koppar och bestående av en central konisk del omgiven av grova lameller som pressas ut i en förtagning utfräst i berget med ett särskilt rymningsverktyg, och den andra gjord av CBI-betong (”kiselbetong”) som gjuts i hål som försetts med samma typ av förtagningar som kopparpluggen.

Två omgångar experiment har genomförts, en på markytan och den andra på några hundra meters djup i Äspös underjordslaboratorium. De förstnämnda experimenten omfattade inplacering av en kopparplugg och en betongplugg i 5-20 m djupa vertikala hål med 200 mm diameter borrade från markytan med syfte att undersöka deras funktion. Det gjordes genom att frilägga pluggarna genom slitsborrning och såga upp dem axiellt efter att ha expanderat kopparpluggen och låtit betongpluggen mogna i en månad. De uttagna pluggarna sågades upp axiellt för att undersöka deras samverkan med berget som visade sig vara mycket tätt och man kunde dra slutsatsen att de båda pluggtyperna kan användas praktiskt. Ingen belastning påfördes för att bestämmas pluggarnas hållfasthet.

Den andra omgången experiment genomfördes på 450 m djup med användning av betong gjuten i 1.9 m djupa borrhål med 200 mm diameter som försågs med förtagningar genom tillämpa det utvecklade rymningsverktyget. Dessa pluggar belastades axiellt för att bestämma bärigheten. Tre olika betongmaterial användes, ”referenstypen” CBI-betong, och två med samma betong men med inblandning av kvartsitfragment till 10 and 20 % halt. Belastningen åstadkoms via en stålbalk som förankrades i berget för att kunna påföra belastningar av flera hundra ton. Elektroniska lägesgivare användes för mätning av förskjutningen av pluggarna. Experimenten visade att alla pluggarna motstod mer än 100 ton vilket motsvarar mer än 30 MPa axiellt tryck och att betongen utan kvartsittillskott var mer duktil och började undergå plasticering vid lägre last än pluggarna med kvartsit. Den styvaste och mest hållfasta pluggen var den med 20 % kvartsitfragment. De uppmätta belastningarna motsvarande plasticering och begynnande brott var i god överensstämmelse med predikterade värden baserade på förberedande laborietester. Ett separatat skjuvförsök för bestämning av krypegenskaperna hos CBI-betongen visade att det beter sig som naturliga och artificiella material med primär, sekundär och tertiär krypning.



# Contents

<b>1</b>	<b>Scope of tests</b>	<b>11</b>
<b>2</b>	<b>Test arrangements</b>	<b>13</b>
2.1	Plugs at the ground surface	13
2.1.1	Metal plug	14
2.1.2	Concrete plug	15
2.2	Tests at 450 m depth	15
2.2.1	Principle of testing	15
2.2.2	Test site	16
2.2.3	Construction of plugs	18
<b>3</b>	<b>Experimental</b>	<b>21</b>
3.1	Plugs at ground surface	21
3.2	Plugs at 450 m depth	22
3.2.1	Loading arrangement	22
3.2.2	Test program	23
<b>4</b>	<b>Discussion and conclusions</b>	<b>25</b>
<b>5</b>	<b>References</b>	<b>27</b>
<b>1</b>	<b>Purpose and planning</b>	<b>33</b>
<b>2</b>	<b>Tests</b>	<b>35</b>
2.1	Planning	35
2.2	Equipments	35
<b>3</b>	<b>Test performance</b>	<b>37</b>
3.1	Punching tests	37
3.2	Compression tests	37
3.3	Creep tests	37
<b>4</b>	<b>Test results</b>	<b>39</b>
4.1	Punching tests	39
4.2	Compression tests	40
4.3	Creep tests	40
<b>5</b>	<b>Conclusions</b>	<b>43</b>
<b>6</b>	<b>References</b>	<b>45</b>
	<b>Appendix I</b>	<b>31</b>
	<b>Appendix II</b>	<b>47</b>



# 1 Scope of tests

The aim of this sub-project of the Borehole Plugging Project [1] was to test the feasibility of two candidate techniques intended for mechanical securing of the tight clay-based seals placed lower down in deep boreholes as outlined in the main Borehole Plugging Report. The criteria for such plugs are as follows:

- The plugs need to serve as “mechanical locks” and must behave like rock, i.e. have a compressive strength of at least 20 MPa and be keyed in the rock to take this axial pressure without yielding or being extruded. Their tightness does not necessarily have to be very high.
- The sealing function must be sufficient even in a 100 000 year perspective.
- The plugs must be placeable in inclined holes.

The experiments in Sub-project 4 comprised determination of the bearing capacity of concrete plugs keyed into the rock and demonstration of the placeability of a metal plug with at least the same bearing capacity as that of the concrete plugs.

Two sets of experiments have been made, one at the ground surface near the adit to the ramp at Äspö URL and the other at 450 m depth in the URL. They have the following form:

- Metal and concrete plugs placed in 200 mm diameter holes at a depth of a few meters from the ground surface; testing of technique for reaming holes, constructing the plugs, and extracting and examining them.
- Concrete plugs at 450 m depth in 1.9 m deep cored boreholes with 200 mm diameter; application of the reaming technique and testing of the force required to extrude the concrete plugs.

The plugs constructed at the ground surface were not tested with respect to their ability to resist axial forces. The major objective was to test the constructability of these types of plugs, the main purpose of which is to serve as strong, mechanical seals. This was achieved by extracting and sectioning the plugs for visual examination.

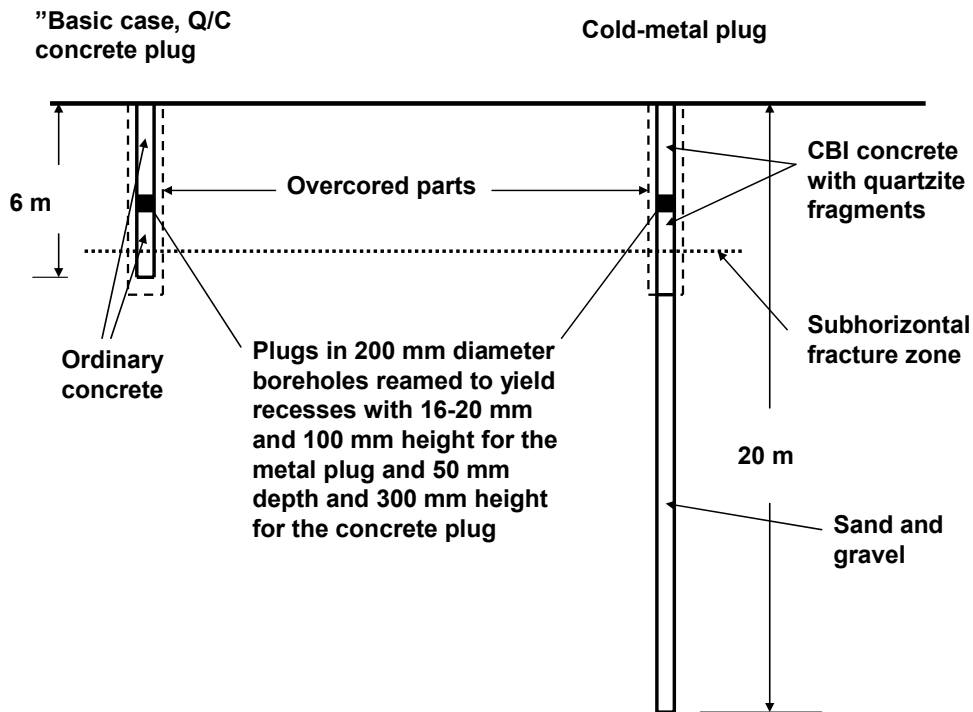


## 2 Test arrangements

### 2.1 Plugs at the ground surface

Figure 2-1 illustrates schematically the test arrangements. The experiments have demonstrated how reaming of 300 mm high recesses could be made in the 200 mm percussion-drilled holes to be plugged with a suitable concrete, and with a copper plug, respectively. No testing of the mechanical strength was made of the plugs in these holes.

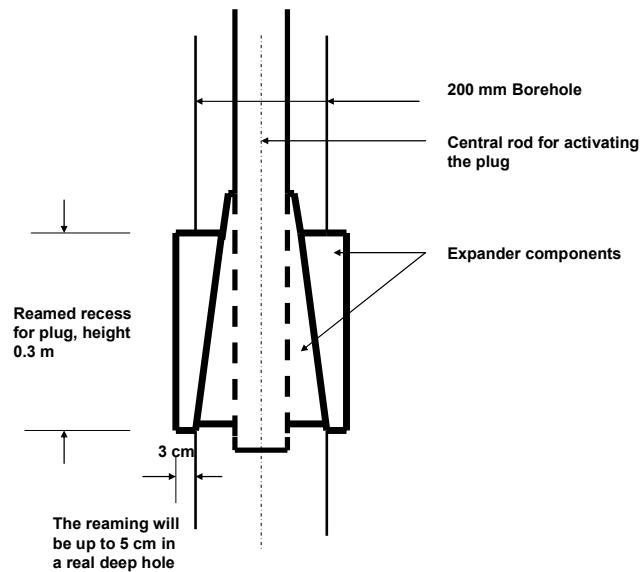
BIPS have been taken and they show that subhorizontal fractures intersect the holes at about 5 m from the surface. The plugs are located above these fractures for making it possible to release the rock columns by slot drilling containing the plugs for subsequent division in two halves.



*Figure 2-1. Schematic picture of the 200 mm diameter holes at the ground surface plugged by concrete and copper plugs ("Overcoring" was made by slot drilling).*

### 2.1.1 Metal plug

The hole was filled with cement-stabilized sand and gravel to a few dm depth below the intended position of the metal plug (Figure 2-2). The plug was then lowered into the hole and expanded by applying a pulling force of about 20 t to establish a very intimate contact between rock and metal. The plug was then maintained in this position by letting it hang in the drill rig when casting CBI concrete in the hole to form a base for placing the plug. Concrete was also cast on top of the metal plug for forming a coherent system of plug and rock that could be extracted by slot-drilling. Figure 2-2 illustrates the general features and function of the metal plug. Copper was used since it will resist major corrosion like the canisters of HLW in a KBS-3 repository.



**Figure 2-2.** The copper “expander” plug. Upper: Function principle. Lower: The copper plug turned upside down below the drill rig before lowering it into the 200 mm hole. The O-rings kept the lamellae in contact with the conical body, which moved them outwards into the recess when applying the pulling force.



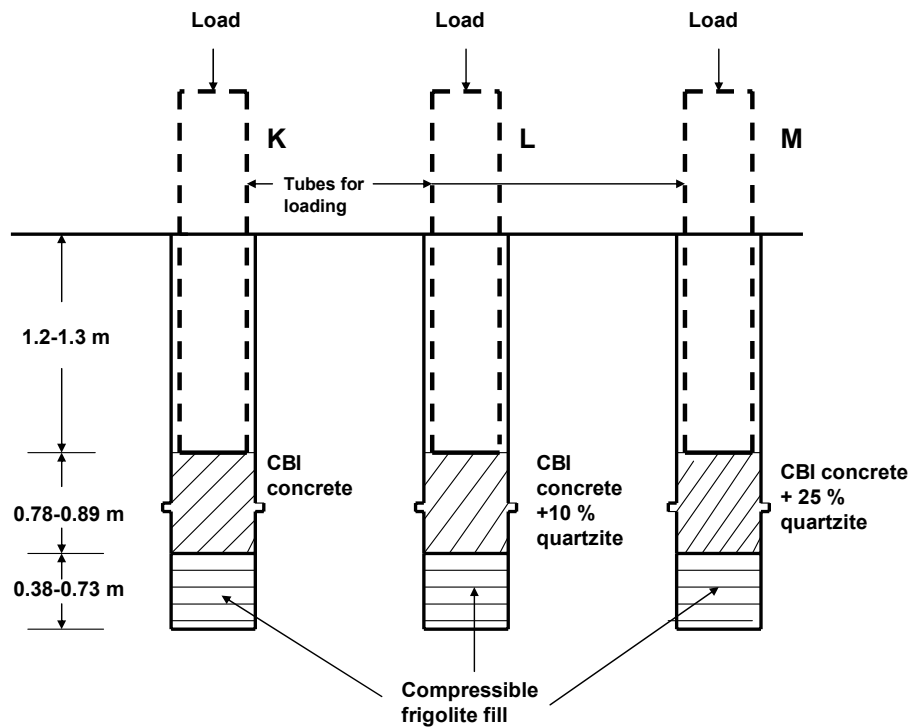
### 2.1.2 Concrete plug

The concrete was prepared according to the CBI recipe (cf. Subprojects 1 and 3) using a 300 l mixer, starting by preparing CBI concrete for Hole K (KA3378G02) and adding 10 and 25 % quartzite with a normal grain size distribution ranging between 0.1 and 10 mm. The concrete had high fluidity and “self-compacted” without vibration or puddling.

## 2.2 Tests at 450 m depth

### 2.2.1 Principle of testing

Figure 2-3 illustrates the three 200 mm cored boreholes at 450 m depth in the Äspö URL. They were plugged with concrete of different types and loaded for determining the axial force required to expell them.

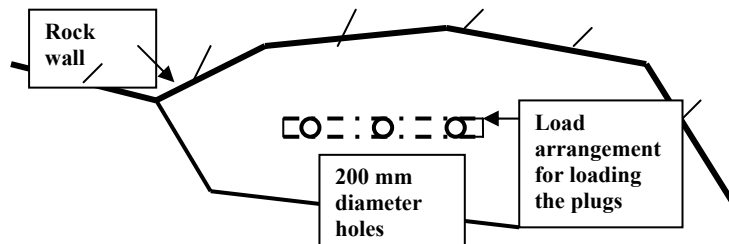


**Figure 2-3.** The three 200 mm diameter plugs loaded 4 weeks of maturation for determining the resistance to punching. Shearing took place at the 30 mm deep and 50 mm high recesses.

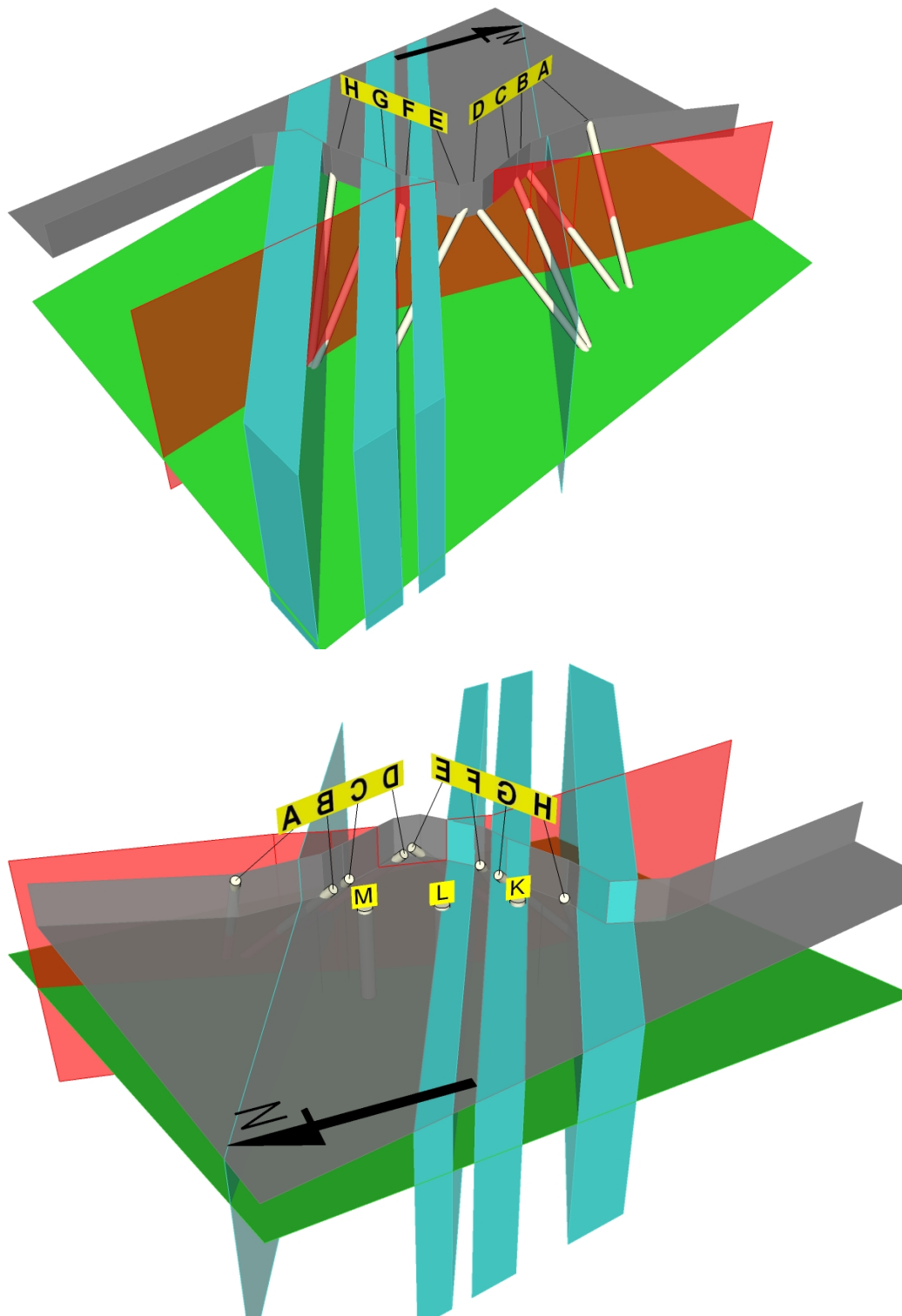
### 2.2.2 Test site

The holes were bored in summer 2006 and reaming to yield recesses with 5 cm height was made by adjusting the reaming tool developed and used by Livinstone AB in November 2006. The holes are located within the same area as the 5 m long holes at AEspoe (cf. Sub-project 2).

Figure 2-4 shows a generalized plan view of the niche with the test area and Figure 2-5 perspective views of the test area and its rock structure. The holes are termed K, L and M, the first mentioned two being located in fracture zones while M is in fracture-poor rock. The co-ordinates of the centres of the holes are given in Table 2-1.



*Figure 2-4. Plan view of the niche where the 200 mm diameter holes are located. They are placed at some distance from the rock wall for making room for the loading equipment. The holes are termed K, L and M from right to left.*



**Figure 2-5.** Boreholes in the rock structure model viewed from east and west, respectively, holes K, L, and M are seen in the latter, lower picture. Holes A-H are 5 m long and were used in Sub-project 2. The light-blue colour indicates presumable hydraulically very active fractures and fracture zones, red is a moderately active steep fracture or fracture zone, and green a moderately active sub horizontal fracture or thin zone.

**Table 2-1. Co-ordinates of the centres of the 200 mm diameter holes.**

Center	x	y	z
<b>KA3378G02 K</b>	7267,269	2087,326	-447,121
<b>KA3377G01 L</b>	7268,558	2088,064	-447,154
<b>KA3375G04 M</b>	7269,859	2088,817	-447,152

Boring of the holes was completed in September 2006 and reaming was made in early November to yield 300 mm high and 30 mm deep recesses in all the holes. This was followed by constructing the plugs, which is described as follows.

### **2.2.3 Construction of plugs**

The concrete was prepared according to the CBI recipe (cf. Subprojects 1 and 3) using a 300 l mixer, starting with preparing CBI concrete for Hole K (KA3378G02) and adding 10 % quartzite with a normal grain size distribution ranging between 0.1 and 10 mm for the plug in Hole L (KA3377G01). For the plug in Hole M (KA3375G04) the amount of quartzite grains was 20 %. The concrete mixtures had high fluidity and “self-compacted” without vibration or puddling.

Pilot laboratory tests had demonstrated that recesses cut in the walls should be filled. These tests, which are reported in APPENDIX I, gave valuable information on the shear strength of the concrete for designing the load arrangement of the field experiments.

The concrete was cast on the compressive fill that was inserted at the bottom of the holes (Figure 2-6).



*Figure 2-6. Compressible column of porous polystyrene.*

The design of the test arrangements was based on a pilot study in the laboratory in which the shear and compressive strength of quartzite-reinforced concrete was investigated (cf. APPENDIX I). The estimated loads for extruding the plugs in the field are given in Table 2-2.

**Table 2-2. Concrete types used for the field experiments. Components in 30 l plugs.**

Plug in hole	K	L	M
Cement (Portland)	1800 g	1800 g	1800 g
Water	4500 g	4500 g	4500 g
Silica fume	1800 g	1800 g	1800 g
$\alpha$ -quartz	6000 g	6000 g	6000 g
Cristobalite	4500 g	4500 g	4500 g
PLasticizer	130 g	130 g	130 g
Ballast (Aggregate), 0-8 mm	50370 g	50370 g	50370 g
Quartzite fragments added	0	6900 g	17270 g

Tap water was used for preparing the concrete, which would therefore undergo hardening in the same way as in constructions above ground. Since the groundwater is saline, the average total salt content can be taken as 1 % with Na as major cation and Cl as dominant anion, diffusion of salt into the maturing concrete could possibly affect the strength. Cube samples were therefore prepared for compressive testing after 28 days, i.e. the time selected for maturation of the big plugs. The results from these tests gave practically the same values for the tap water sample and for the one exposed to Äspö water (MPa and MPa respectively).



### 3 Experimental

#### 3.1 Plugs at ground surface

The plugs were released by slot drilling and split into two halves by sawing them axially for examination of the homogeneity and interaction with the rock. The concrete plug had not been exposed any external force while the metal plug had been pulled by an axial force of about 12 tons for activation of the expander component. Figure 3-1 shows the sectioned plugs. The examination verified that the concrete had filled the reamed slot completely and that the copper plug had been fully expanded and undergone some plastization.



**Figure 3-1.** Sectioned plugs released from the rock in the shallow plugging experiments. Upper: The concrete plug with porphyry-like appearance, fully occupying the hole and recess. Lower: The shiny copper plug with the lamellae extruded into the recess.





### 3.2.2 Test program

#### Pilot laboratory tests

Pilot load tests were made with the various concrete experiments on laboratory scale (See APPENDIX I). These tests gave information on the shear strength of the concrete that had matured for about a month and these data were used for predicting the required force to push out the plugs in the 200 mm holes (Table 3-1).

**Table 3-1. Predicted axial forces for extruding the concrete plugs. The shear strength data emanate from laboratory tests. Forces in tons, multiplication by 10 gives the values in kN.**

Plug type	Sheared section, m <sup>2</sup>	Shear strength, MPa	Theoretical extrusion force, tons	Estimated span of extrusion force, tons
CBI	0.03	20	60	40-60
CBI + 10 % quartzite	0.03	37	111	80-110
CBI + 25 % quartzite	0.03	50*	150*	110-175*

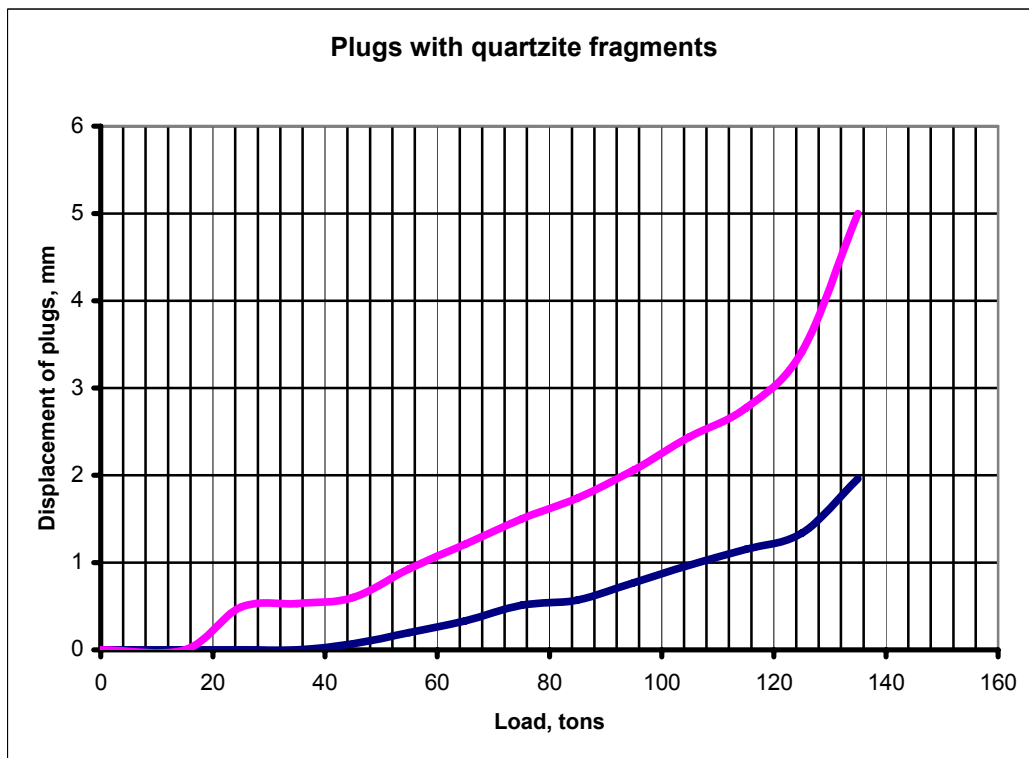
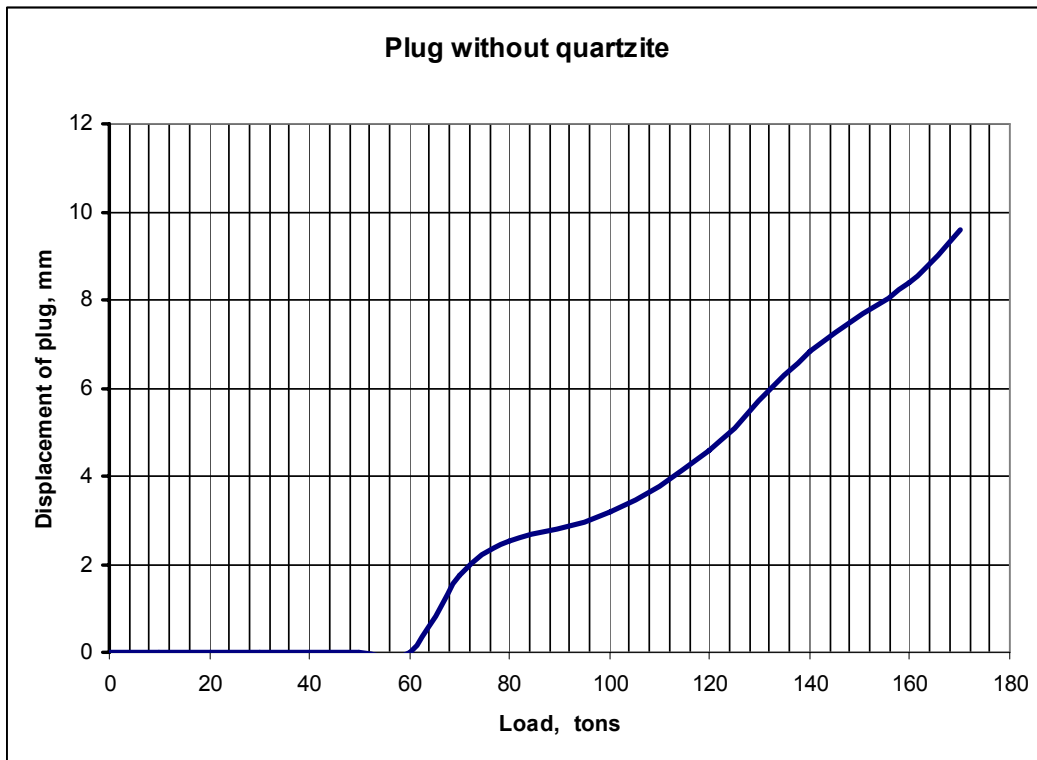
\* Assumed

#### Field experiments

The field tests were planned to be made by stepwise increasing the load until failure occurred. Suitable load steps were taken to be 2-10 tons depending on the rate of strain. Each load should be maintained constant for 2 minutes recording the displacement of the upper end of the plugs and movements of the various components. The recorded displacement versus load is illustrated by the diagrams in Figure 3-3. They demonstrate that the plugs behaved in a similar fashion and resisted loads well over 100 tons, corresponding to axial pressures of more than 30 MPa. For the test with no quartzite the load arrangement was found to need stabilization when the load had reached about 70 tons and the adjustments can have had some impact on the displacement for loads lower than this value in the repeated load series. The expansion of the piston of the jack was limited for all the loadings, which required several interruptions and unloadings. The graphs show the final loading sequence for the respective plugs (cf. APPENDIX II).

The most important conclusions of the tests are:

- The plug without quartzite fragments behaved in a more ductile manner than those with this additive. The plug with 20 % quartzite was the stiffest one.
- The plug without quartz fragments started to plasticize at around 60 tons while those with fragments at about 115 tons for the one with 10 % quartzite and about 125 tons for the one with 20 % quartzite. This verifies that addition of quartzite increases the shear strength and deformation modulus of the CBI concrete significantly.
- The predicted failure loads in Table 3-1 agree well with those recorded in the field experiments.



**Figure 3-3.** Recorded strain in the loading tests. Upper: Plug without quartzite. Lower: Plugs with 10 % quartzite (upper curve, the hump at 25 tons is an artefact caused by inadequate function of the gauges) and 20 % quartzite (lower curve).

## 4 Discussion and conclusions

### General conclusions

The major conclusions from the tests in Sub-project 4 can be summarized as follows:

- Plugging of large-diameter holes can be made by use of copper plugs and CBI silica concrete plugs, which can both take axial pressures of more than 30 MPa.
- The plugs need to be keyed in the rock for which a reaming tool is available.
- The shear strength and deformation moduli of concrete plugs of silica concrete can be significantly improved by mixing in centimetre-sized quartzite fragment.
- The function of plugs of the investigated type has been fully demonstrated. For the concrete plugs the recorded strength in full-scale tests has been found to agree well with predicted values derived from laboratory experiments.
- The long-term performance of plugs of the investigated type has not been assessed.



## 5 References

**Pusch R, Ramqvist G, 2004.** Borehole sealing, preparative steps, design and function of plugs – basic concept. SKB Int. Progr. Rep. IPR-04-57.



# Appendices

I	Report on shear testing of CBI Q/C concrete	31
II	Data sheets from field loading of concrete plugs installed in the Sicada database.	47





# Appendix I<sup>1</sup>

## Report on shear testing of CBI Q/C concrete

---

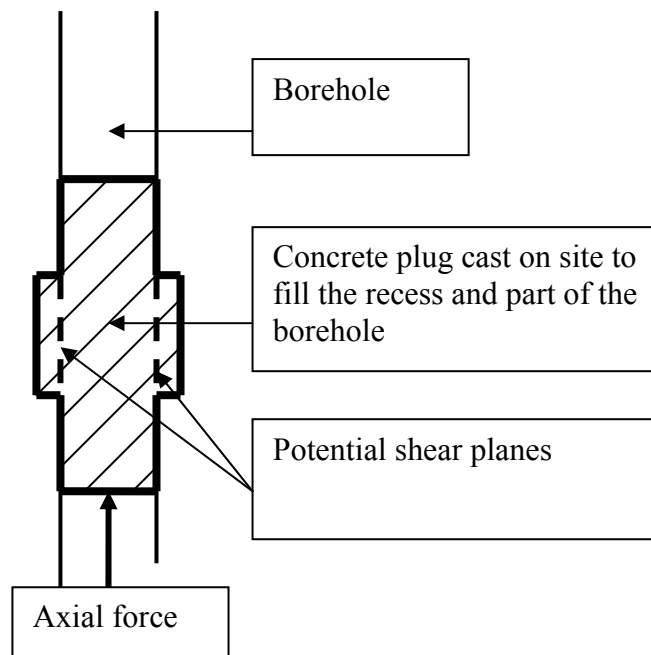
<sup>1</sup> Report by Geodevelopment International AB to SKB



# 1 Purpose and planning

Boreholes in a HLW repository, primarily deep boreholes extending from the ground surface, can preferably be sealed by long-lasting concrete for providing support of underlying clay plugs that make the holes tight. For anchoring concrete plugs a recess has to be cut by reaming technique (Figure 1) so that axial forces caused by the swelling pressure of the clay plugs or unilateral water pressure can be transferred to the rock without yield. The plugs will be exposed to shear stresses that can lead to shear failure along the broken lines in the figure. Such failure can be instantaneous or develop after a long time when a critical shear strain has been reached by creep processes.

The present document reports a study on the strength and locking potentials of concrete plugs in steel tubes with 60 mm diameter simulating larger boreholes. The experiments comprised punching tests for determining the shear strength and a creep test for determining the character of long-term strain under constant load. The punching tests were made as pilot experiments in preparing field experiments in 200 mm diameter holes at Äspö.



**Figure 1.** Principle of sealing a borehole by use of a concrete plug.

The concrete used was prepared according to the recipe formulated by CBI (Table 1). In two of the punching tests additional ballast material was mixed in for increasing the shear strength (cf. Figure 2). Three separate tests were made as well for estimating the impact of incorrect amounts of water, the reason being that extra water from the rock may enter the concrete in the casting process and soften it or making it inhomogeneous.

**Table 1. CBI's recipe for cement-poor concrete.**

Components	Kilograms per m <sup>3</sup> of concrete
White cement (Aalborg Portland)	60
Water	150
Silica Fume (Elkem)	60
Fine ground $\alpha$ -quartz (Sibelco)	200
Fine ground cristobalite quartz (Sibelco)	150
Superplasticizer (Glenium 51 - Modern Betong)	4,38 (dry weight)
Aggregate 0-4 mm (Underås, Jehanders Grus)	1679



**Figure 2.** Crushed quartzite as extra aggregate material. Left: Elongated fragments with the long diameter 5-20 mm. Right: Isodiametric fragments with the long diameter 1-10 mm.

## 2 Tests

### 2.1 Planning

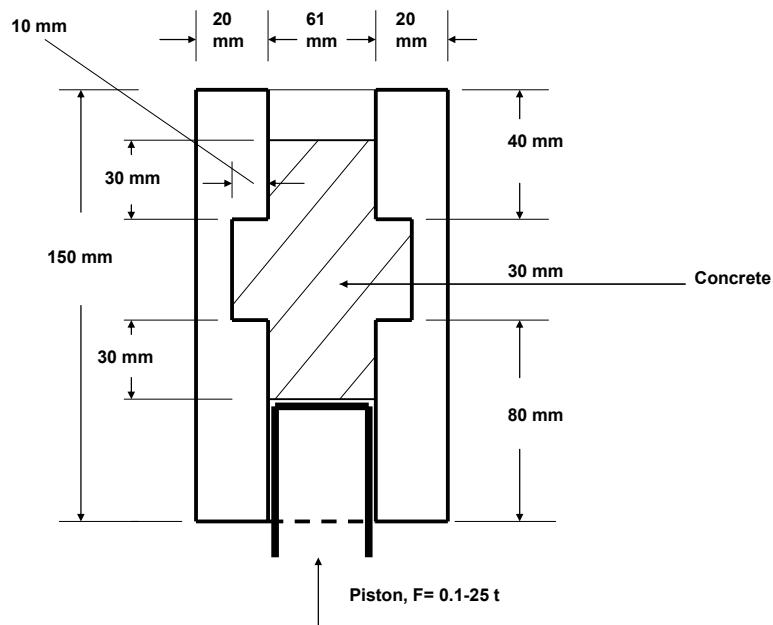
The study comprised three types of experiments:

- Punching tests for determining the shear strength of concrete cast in steel tubes with recesses for simulating the conditions in the corresponding tests at 450 m depth at Äspö (Sub-project 4).
- Creep test for determining the shear strain rate under constant load.
- Determination of the compressive strength of CBI concrete with higher water contents than specified by the recipe.

### 2.2 Equipments

#### Punching tests

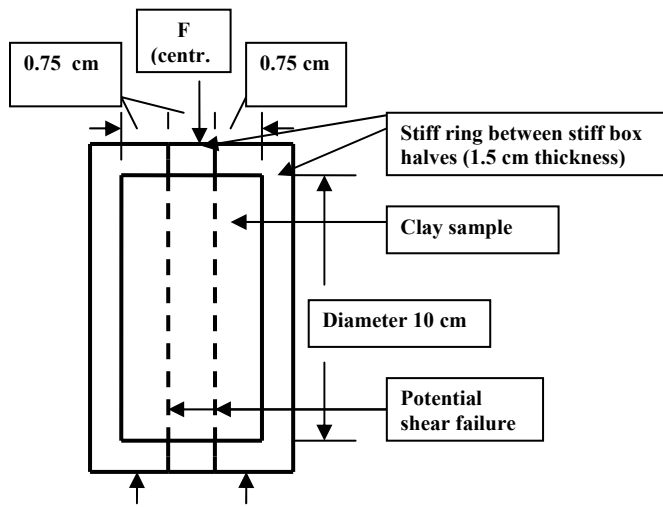
The punching experiments were made using steel tubes for simulating boreholes with recesses (Figure 3).



**Figure 3.** *Punching apparatus for determining the shear strength of concrete.*

#### Creep test

The creep test was made by using a ring shear apparatus with 100 kg maximum load and recording of the strain with an accuracy of  $\pm 0.5 \mu\text{m}$  (Figure 4).



**Figure 4.** The shear apparatus consists of two cylindrical box halves and a central, movable ring in which the concrete was cast. After 3 weeks the shear box was placed in the apparatus and sheared by applying a load  $F$  that acts centrally on the ring.

## **3 Test performance**

### **3.1 Punching tests**

Concrete was cast in steel tubes of the type shown in Figure 3. Three blends were used: 1) CBI concrete according the recipe, 2) CBI concrete with quartzite (1-10 mm long diameter), corresponding to 20 % of the concrete mass added, and 3) CBI concrete with 35 % quartzite added (5-20 mm long diameter). The tubes were filled with tap water so that the concrete matured under wet conditions. After 4 weeks the force required to squeeze them out was determined by axial loading.

### **3.2 Compression tests**

Three specimens with 30 mm diameter and 50 mm height were prepared: 1) Concrete prepared according to the CBI recipe (water/solid ratio 7 %), 2) CBI concrete with water/solid ratio 9 %, and 3) water/solid ratio 21 %. The samples were prepared in small oedometers and left for 2 days under (tap) water and were then extruded and kept under water for 3 weeks. The compressive strength was then determined by axial loading.

### **3.3 Creep tests**

Concrete according to the CBI recipe was prepared and placed in the shear box halves, which were connected to tap water burettes for maturing in 3 weeks. The box was then placed in the shear apparatus and the ring loaded by 100 kg, giving an average shear stress of the sample of about 70 kPa. The low stress level, which had to be selected for practical reasons, would still be sufficient to reveal the nature of the creep behaviour of this concrete type.





## 4 Test results

### 4.1 Punching tests

The results of the tests are summarized in Table 2.

**Table 2. Results of punching tests.**

Material	Maximum load, kg	Shear strength, MPa	Notes
CBI concrete	12000	20	-
CBI concrete + 20 % quartzite	22000	37	Quartzite grains sheared off
CBI concrete + 35 % quartzite	9000	15	Inhomogeneous, poor cohesion

Figure 5 illustrates the appearance of the sheared concrete containing 10 % quartzite fragments



**Figure 5.** Top view of the form of steel with the sheared concrete with 10 % quartzite fragments seen as a bright band. The broken quartzite fragments that served as reinforcement are seen as white grains in the band.

## 4.2 Compression tests

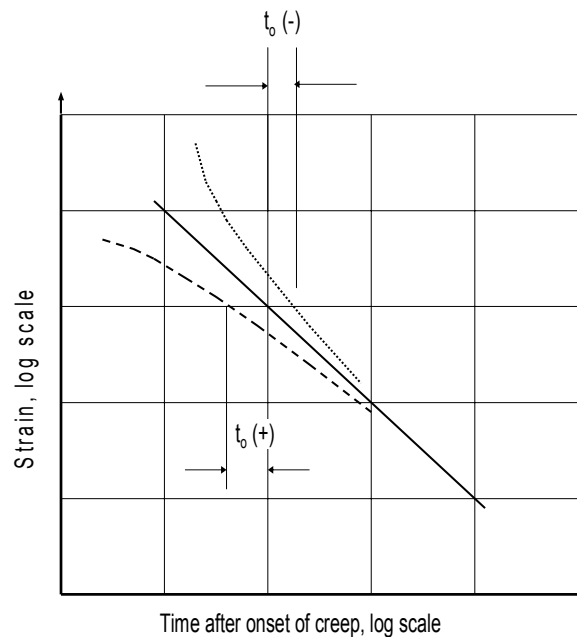
The results of the tests are collected in Table 3.

**Table 3. Compressive strength of CBI concrete with different water/solid (w/s) ratios.**

w/s ratio	Axial load at failure, kg	Compressive strength, MPa	Notes
7 %	4000	57.1	Axial cleavage
9 %	2000	28.0	Axial cleavage
21 %	1000	14.0	Disintegration

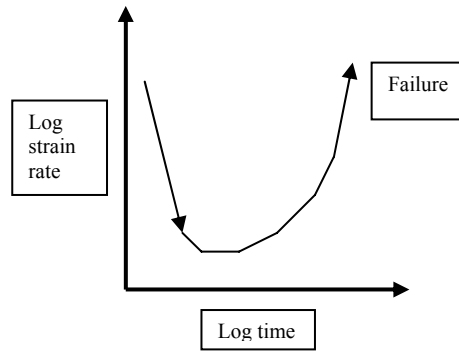
## 4.3 Creep tests

A currently used creep model [1] implies that, for moderate deviator stresses that allow for microstructural recovery, the creep strain is as illustrated in Figure 6. If there is successive retardation of the creep rate according to the logarithmic time law it is expected that failure will not be caused even after very long period of time.

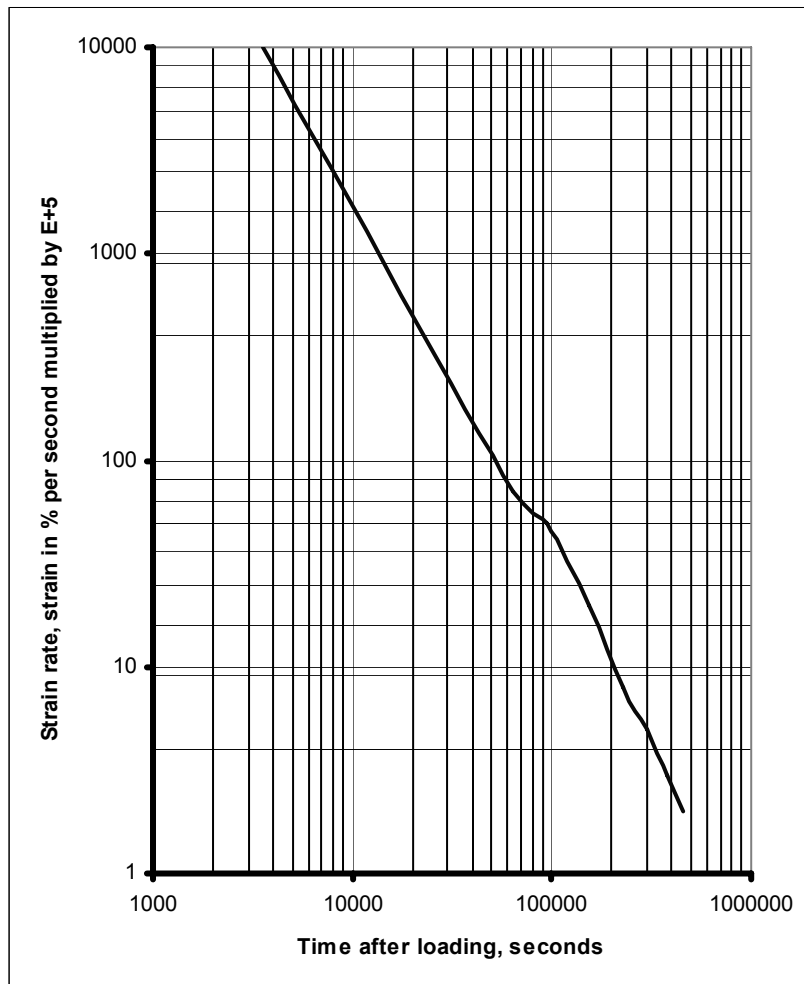


**Figure 6.** Generalization of creep curves of log time type.

Further increase in deviator stress leads to what is conventionally termed “secondary creep” in which the creep rate tends to be constant and giving a creep strain that is proportional to time. In contrast to what is typical for the lower stress cases one can imagine that creep of critically high rate makes it impossible for microstructural self-repair: comprehensive slip changes the structure without allowing reorganization takes place and this ultimately lead to failure (Figure 7). Figure 8 shows the recorded strain curve demonstrating that only primary creep occurred with no risk of ultimate failure for the applied stress.



**Figure 7.** General appearance of the creep behaviour of clays. One identifies the initial primary creep of log time type followed by secondary strain, i.e. a period of constant rate strain, ultimately ending up in tertiary creep that leads to failure.



**Figure 8.** Strain rate of the CBI concrete with constant shear stress 70 kPa for about one week. The strain rate dropped somewhat quicker than implied by the log time rule and indicates that primary creep prevailed with no risk of delayed failure.



## 5 Conclusions

The following major conclusions were drawn from the experiments:

- The CBI concrete matures relatively slowly but reaches the predicted compressive strength (>30 MPa) in about 3 weeks. Tests with more water mixed in, i.e. up to 21% w/c ratio, gives lower but not dramatically reduced strength, which makes the casting operation only moderately sensitive to some unexpected inflow of water from the rock.
- The punching tests show that the shear strength of CBI concrete is about 20 MPa after about 3 weeks. This stress was caused by an axial force of 12 t in the experiments with 60 mm diameter steel tubes, corresponding to an axial pressure of 40 MPa. With 20 % quartzite added to the concrete the axial force and pressure required for extruding the plug were almost doubled, while for 35 % coarser quartzite added the force and pressure were slightly lowered. The resistance to extrusion of the concrete plugs is very much higher than the pressures that can be built up in deep boreholes; the maximum swelling pressure of underlying clay plugs can in fact not exceed a few MPa and water and gas pressures acting on concrete plugs constructed at a 100 m depth will be even lower. The strength of the plugs will even resist an overburden pressure of a 3 km glacier.
- The addition of 20 % quartzite appeared to be optimal for giving the concrete a very high strength, which was largely caused by the shear resistance of quartzite fragments that extended into the recess of the simulated boreholes. The lower punching resistance of the 35 % quartzite mixture is believed to be due to insufficient filling of the space between the coarse grains by the finer CBI matrix. For further increase in strength it is believed that use of 25 % of somewhat larger grains is suitable. This mixture is hence recommended for use in the 200 mm holes at 450 m depth.
- Portland-cement concrete is known to yield considerable time-dependent strain, which may lead to critically large deformation and failure. The nature of creep of such concrete is dominated by secondary creep even at moderate mechanical stresses. The creep tests performed in the present study corresponded to an axial pressure in the simulated holes of about 1.5 MPa, i.e. less than what gave shear failure in the punching tests but on the same order of magnitude that can be expected in real boreholes. The fact that the strain rate dropped continuously in a way implying primary creep suggests that the strain would be successively retarded and die out.



## 6 References

- 1. Pusch R, Yong R N, 2006.** Microstructure of smectite clays and engineering performance. Taylor & Francis, London and New York.
- 2. Pusch R, Feltham P, 1980.** A stochastic model of the creep of soils. *Géotechnique*, Vol. 30, No 4 (pp.497-506).
- 3. Feltham P, 1976.** A simple stochastic model of low-temperature creep and stress-relaxation in solids. Proc. VII Int. Congr. Rheology, Gothenburg, Sweden (pp.166-167).
- 4. Feltham P, 1979.** The inter-relationship: earth science-material sciences. Mechanisms of deformation and fracture. Pergamon Press, London, Vol.29, No 42.
- 5. Buckle A, Feltham P, 1975.** Logarithmic creep of copper and aluminium. *Metal Sci.* Vol. 9 (pp. 541-546).





## **Appendix II**

**Data sheets from field loading of concrete plugs  
installed in the Sicada database**



Projektnummer

2422900

Projekt

Provtryckning av betongplugg i borrhål

Kontroll datum:

2007-01-31

Kontrollerad av:

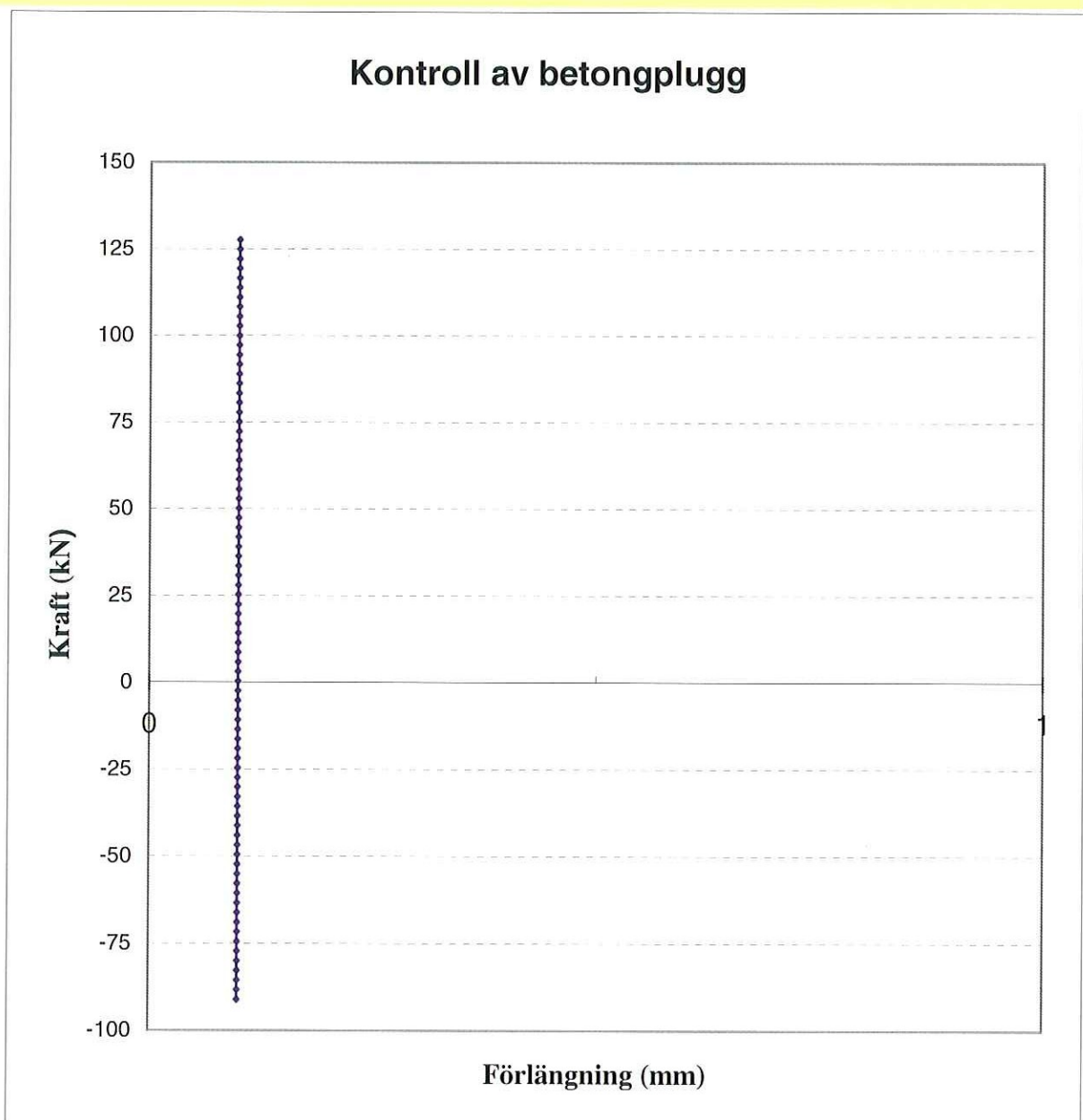
Stig Rydelius

Plugg:

K

Kommentar:

20 ton enl dig.manometer 59 bar. Uppmätt värde enl. skala 12,7 ton. Provbalken pressades upp 2,80 mm



Projektnummer

2422900

Projekt

Provtryckning av betongplugg i borrhål

Kontroll datum:

2007-01-31

Kontrollerad av:

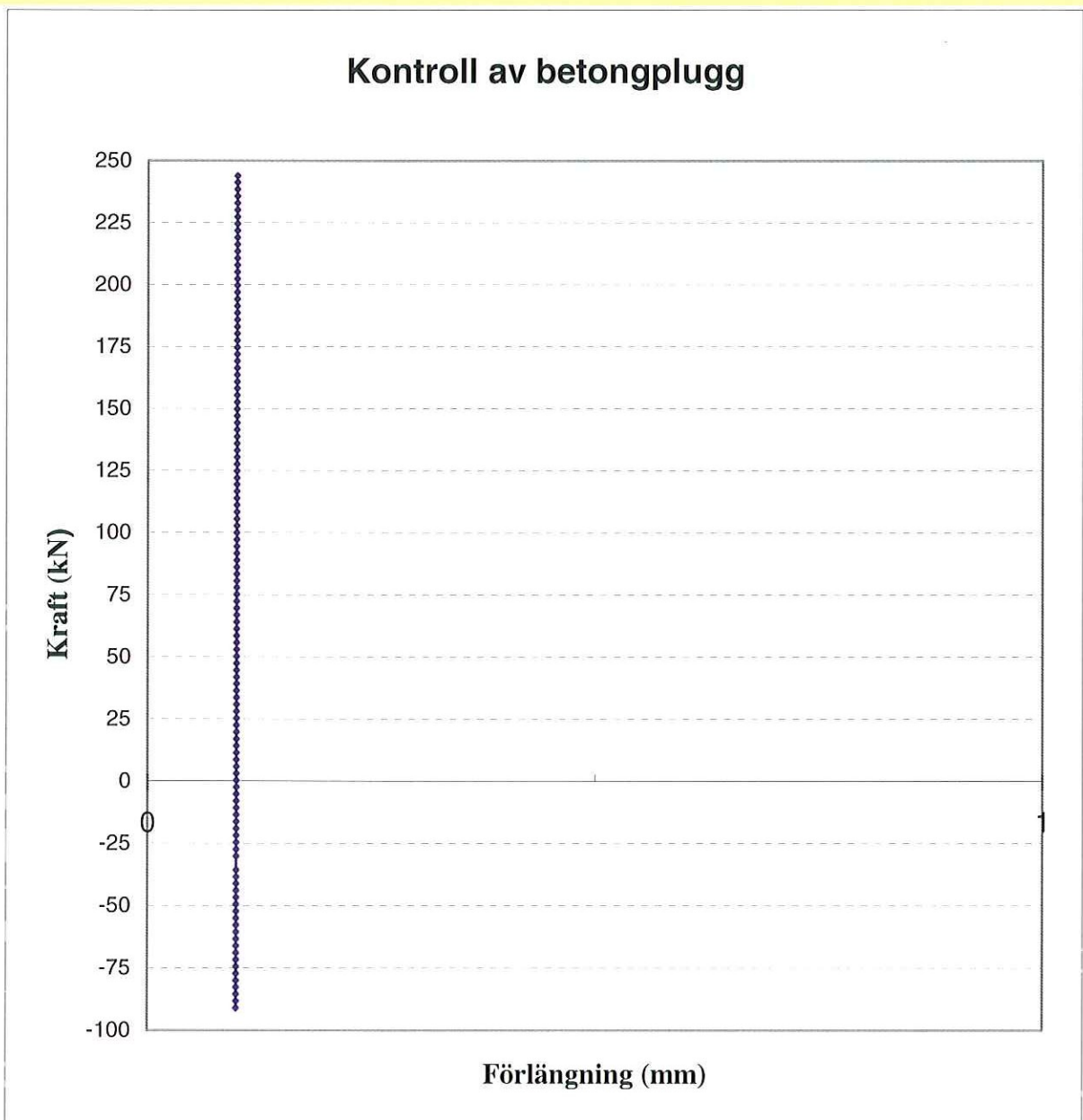
Stig Rydelius

Plugg:

K

Kommentar:

30 ton enl dig.manometer 86 bar. Uppmätt värde enl. skala 24,1 ton. Provbalken pressades upp 2,96 mm



Projektnummer

2422900

Projekt

Provtryckning av betongplugg i borrhål

Kontroll datum:

2007-01-31

Kontrollerad av:

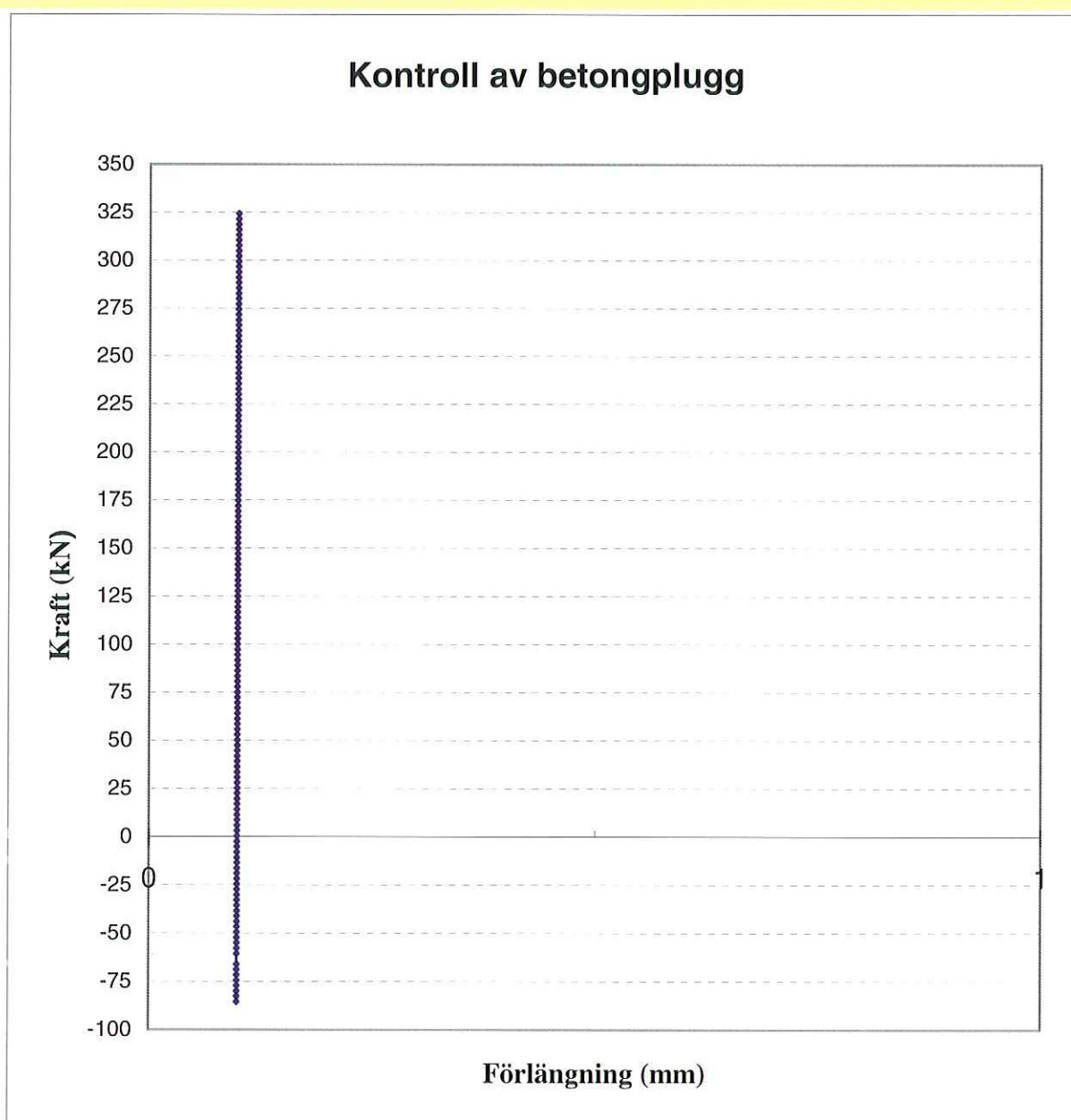
Stig Rydelius

Plugg:

K

Kommentar:

40 ton enl dig.manometer 114 bar. Uppmätt värde enl. skala 32,4 ton.  
Provbalken pressades upp 3,10 mm



Projektnummer

Projekt

2422900

Provtryckning av betongplugg i borrhål

Kontroll datum:

Kontrollerad av:

2007-01-31

Stig Rydelius

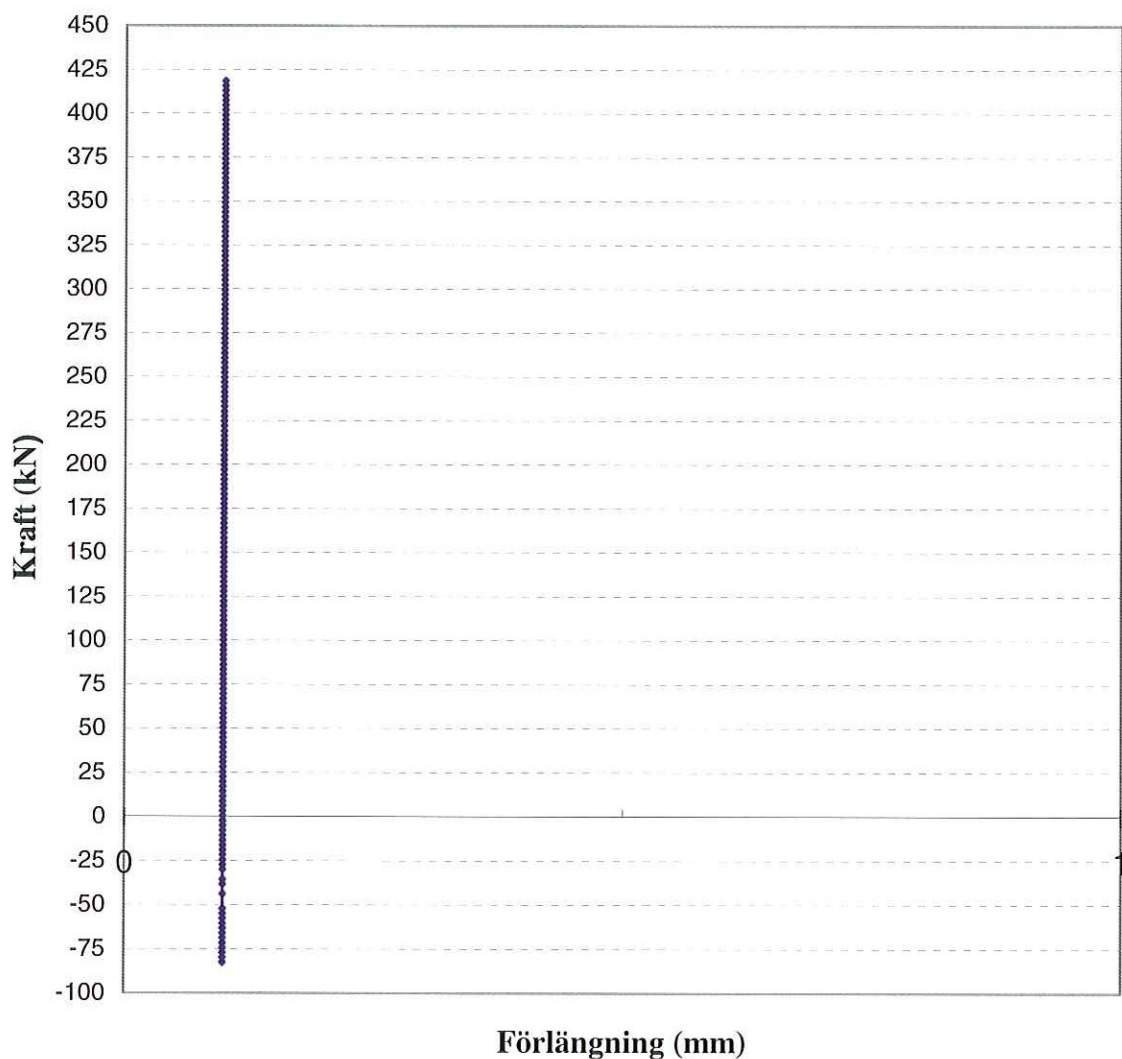
Plugg:

K

Kommentar:

50 ton enl dig.manometer 143 bar. Uppmätt värde enl. skala 41,8 ton Provbalken pressades upp 3,28 mm

### Kontroll av betongplugg





Projektnummer

Projekt

2422900

Provtryckning av betongplugg i borrhål

Kontroll datum:

Kontrollerad av:

2007-01-31

Stig Rydelius

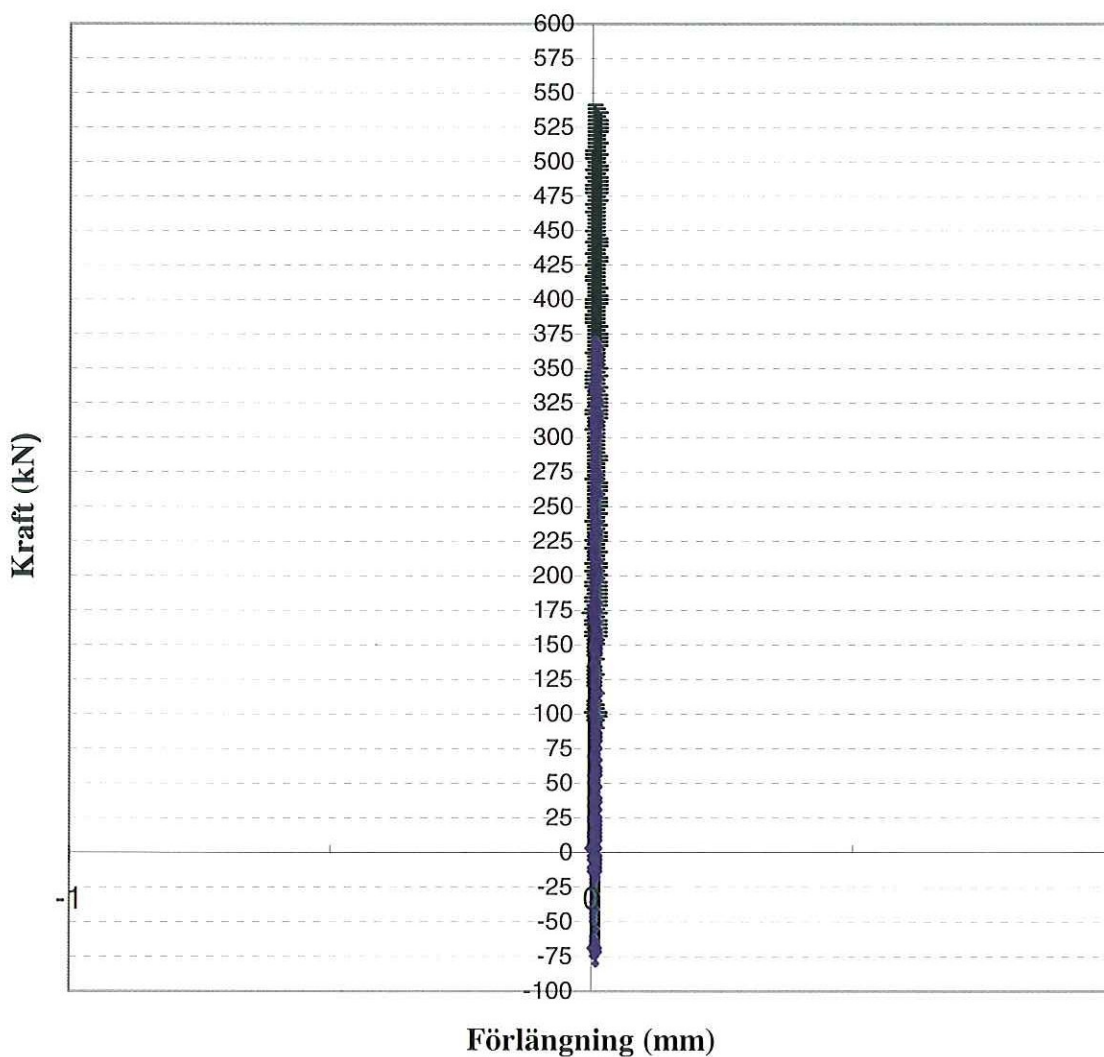
Plugg:

K

Kommentar:

60 ton enl dig.manometer 171 bar. Uppmätt värde enl. skala 53,8 ton Provbalken pressades upp 3,74 mm. Röret pressades ned 0,0 mm

### Kontroll av betongplugg



Projektnummer

2422900

Projekt

Provtryckning av betongplugg i borrhål

Kontroll datum:

2007-01-31

Kontrollerad av:

Stig Rydelius

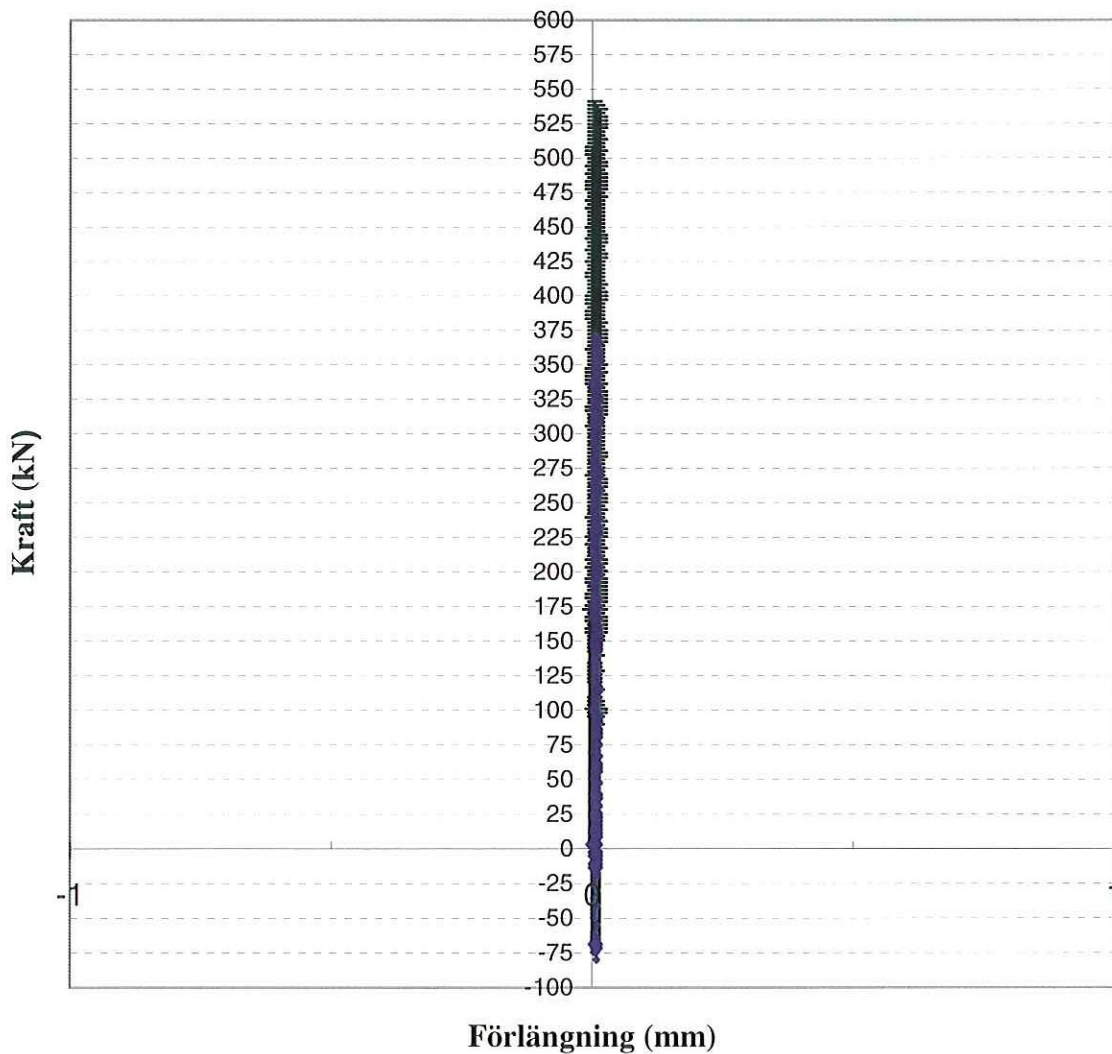
Plugg:

K

Kommentar:

60 ton enl dig.manometer 171 bar. Uppmätt värde enl. skala 53,5 ton Provbalken pressades upp 3,74 mm. Röret pressades ned 0,0 mm

### Kontroll av betongplugg





Projektnummer

Projekt

2422900

Provtryckning av betongplugg i borrhål

Kontroll datum:

Kontrollerad av:

2007-01-31

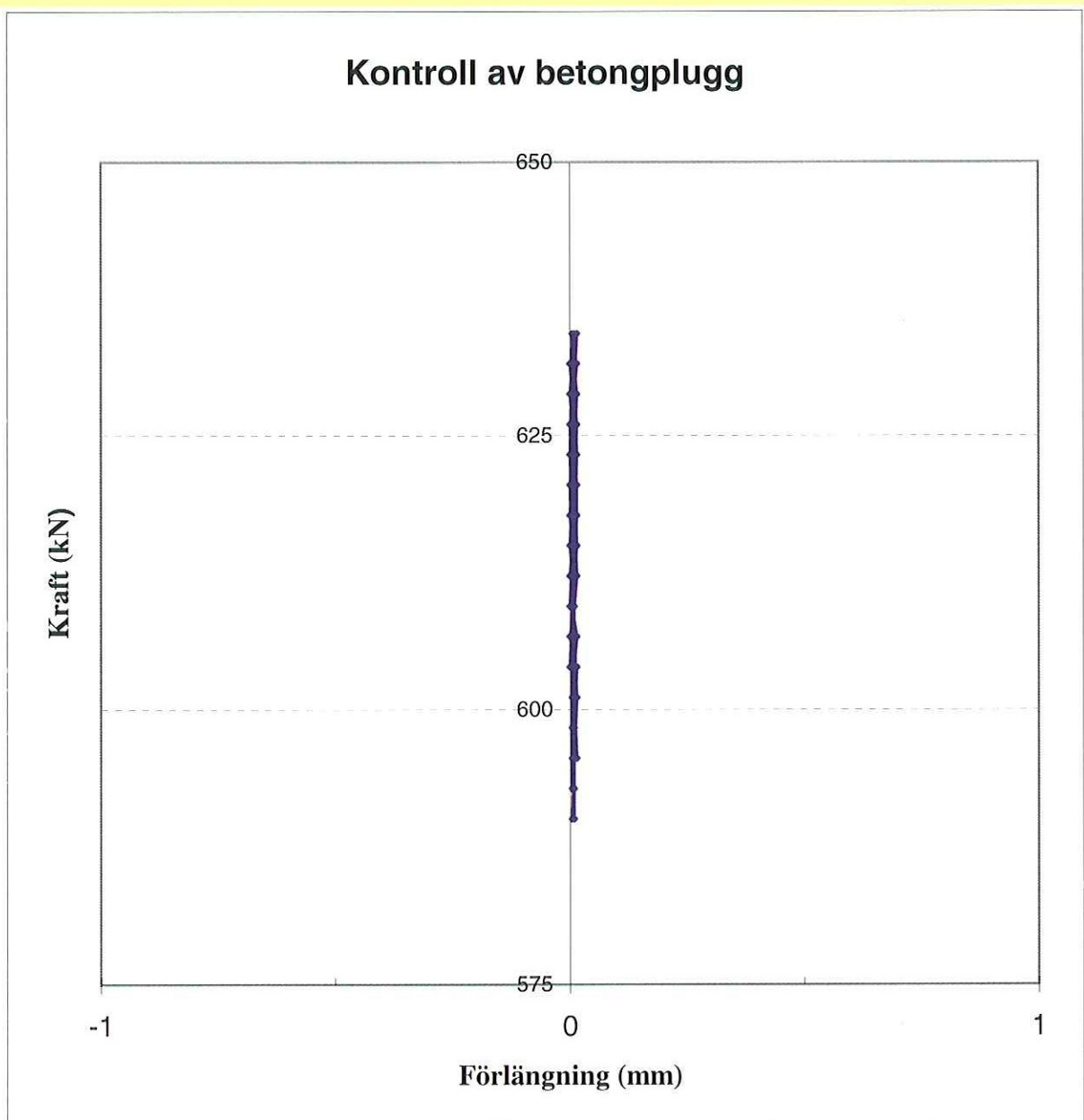
Stig Rydelius

Plugg:

K

Kommentar:

70 ton enl dig.manometer 199 bar. Uppmätt värde enl. skala 63,4 ton Provbalken pressades upp 3,42 mm. Röret pressades ned 1,0 mm



Projektnummer

2422900

Projekt

Provtryckning av betongplugg i borrhål

Kontroll datum:

2007-01-31

Kontrollerad av:

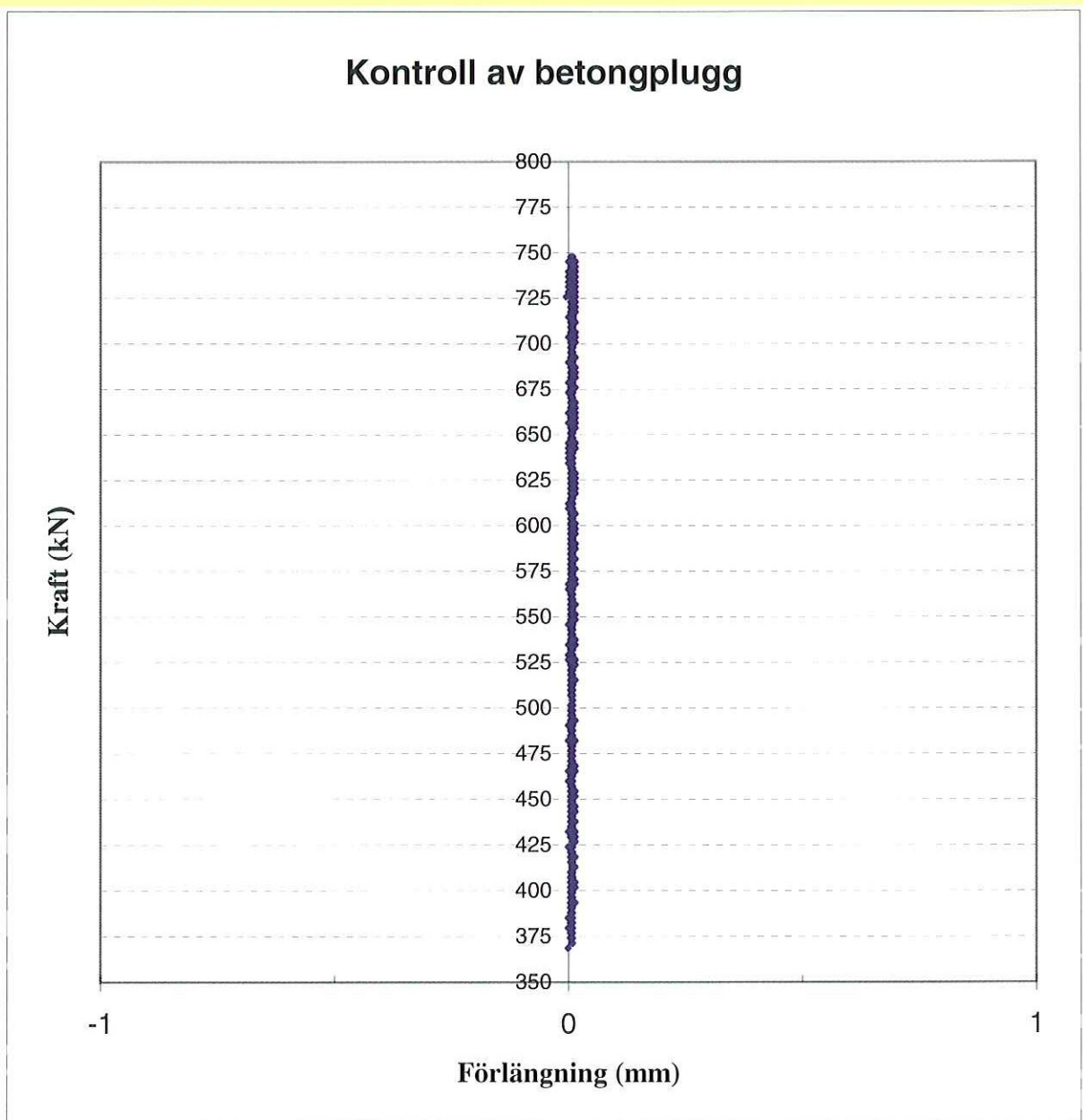
Stig Rydelius

Plugg:

K

Kommentar:

80 ton enl dig.manometer 229 bar. Uppmätt värde enl. skala 74,7 ton Provbalken pressades upp 4,12 mm. Röret pressades ned 1,75 mm



Projektnummer

2422900

Projekt

Provtryckning av betongplugg i borrhål

Kontroll datum:

2007-01-31

Kontrollerad av:

Stig Rydelius

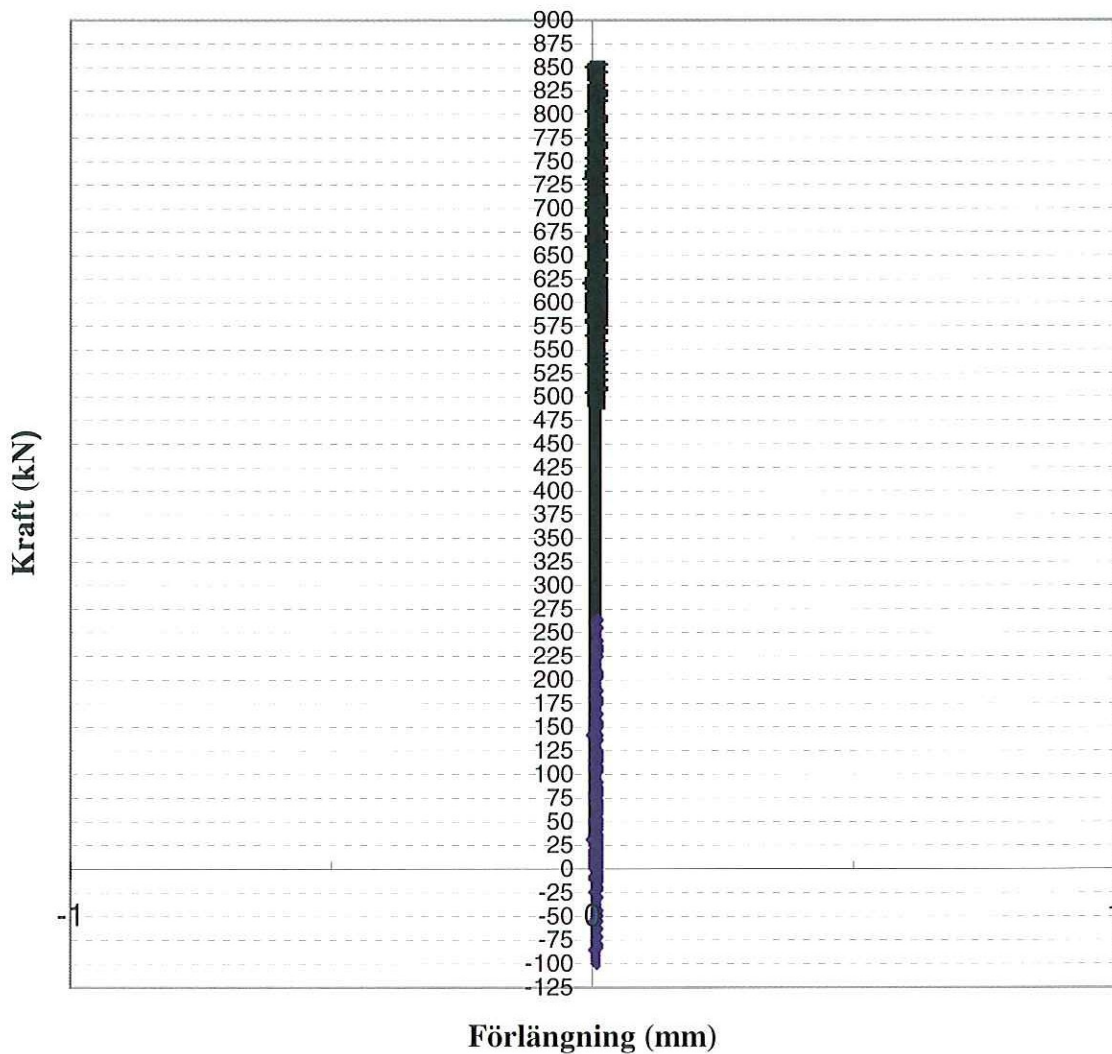
Plugg:

K

Kommentar:

90 ton enl dig.manometer 257 bar. Uppmätt värde enl. skala 84,4 ton Provbalken pressades upp 4,45 mm. Röret pressades ned 2,52 mm

### Kontroll av betongplugg



Projektnummer

2422900

Projekt

Provtryckning av betongplugg i borrhål

Kontroll datum:

2007-01-31

Kontrollerad av:

Stig Rydelius

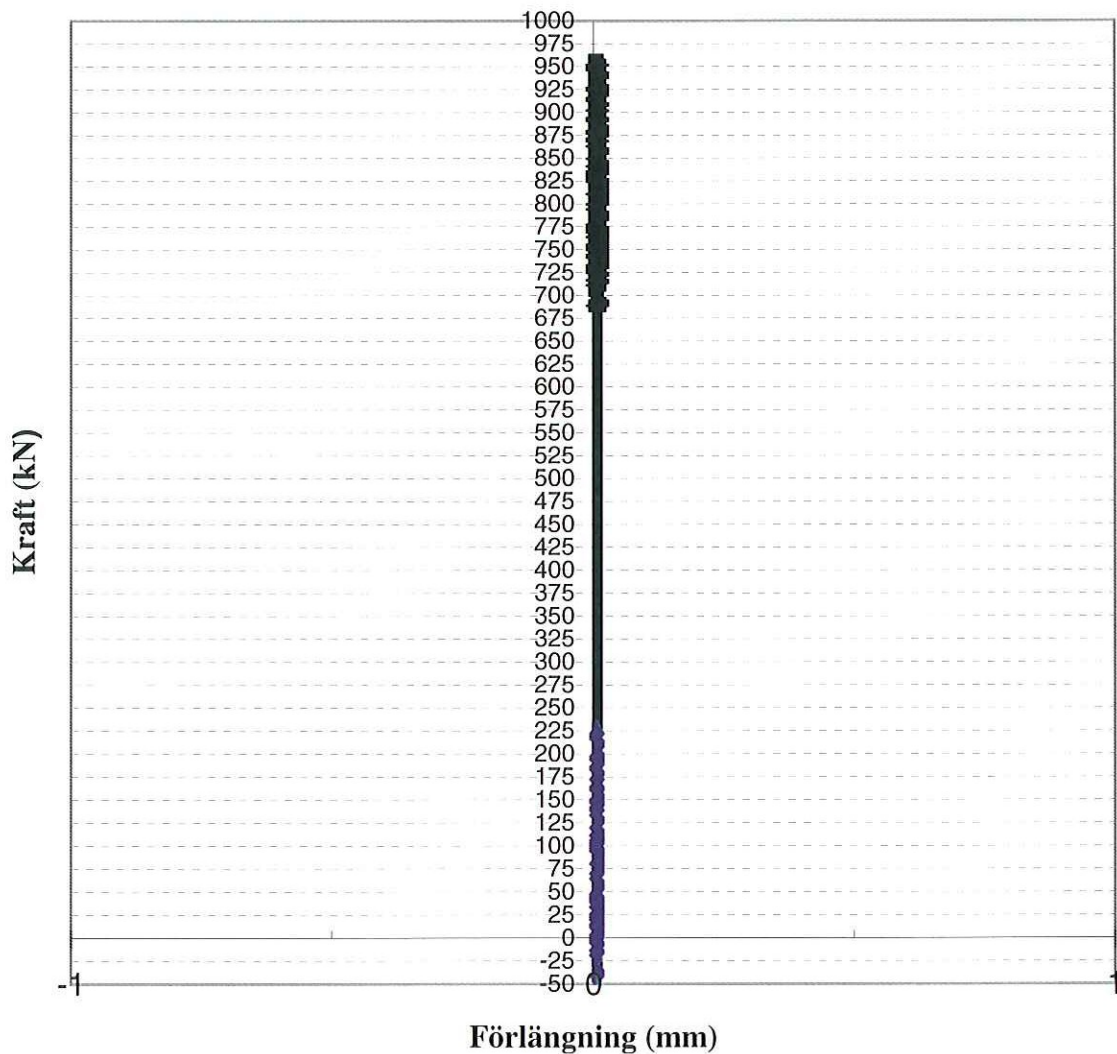
Plugg:

K

Kommentar:

100 ton enl dig.manometer 286 bar. Uppmätt värde enl. skala 95,5 ton  
Provbalken pressades upp 4,62 mm. Röret pressades ned 3,10 mm

### Kontroll av betongplugg





Projektnummer

2422900

Projekt

Provtryckning av betongplugg i borrhål

Kontroll datum:

2007-01-31

Kontrollerad av:

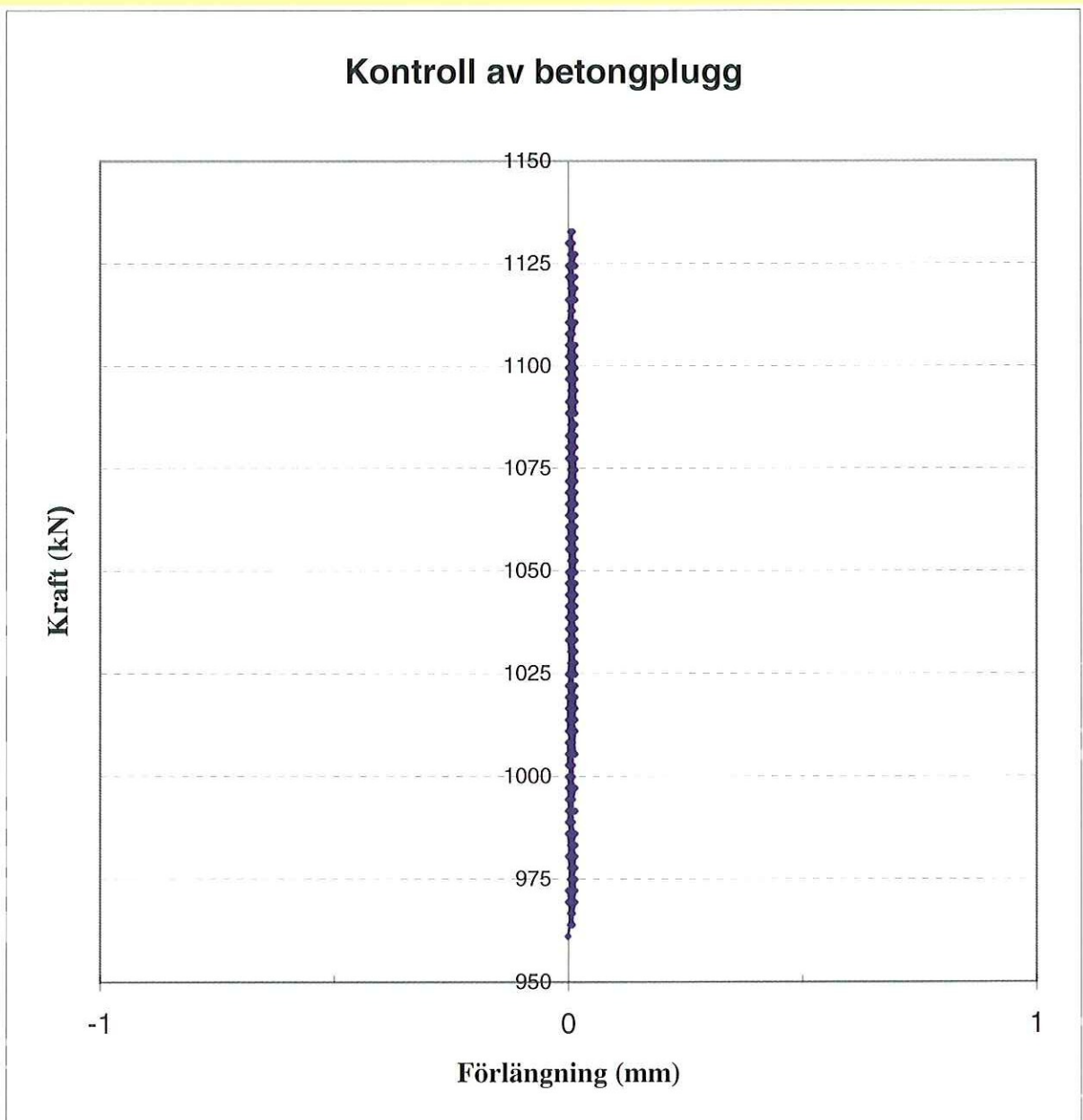
Stig Rydelius

Plugg:

K

Kommentar:

120 ton enl dig.manometer 342 bar. Uppmätt värde enl. skala 113,2 ton  
Provbalken pressades upp 5,42 mm. Röret pressades ned 4,6 mm



Projektnummer

2422900

Projekt

Provtryckning av betongplugg i borrhål

Kontroll datum:

2007-01-31

Kontrollerad av:

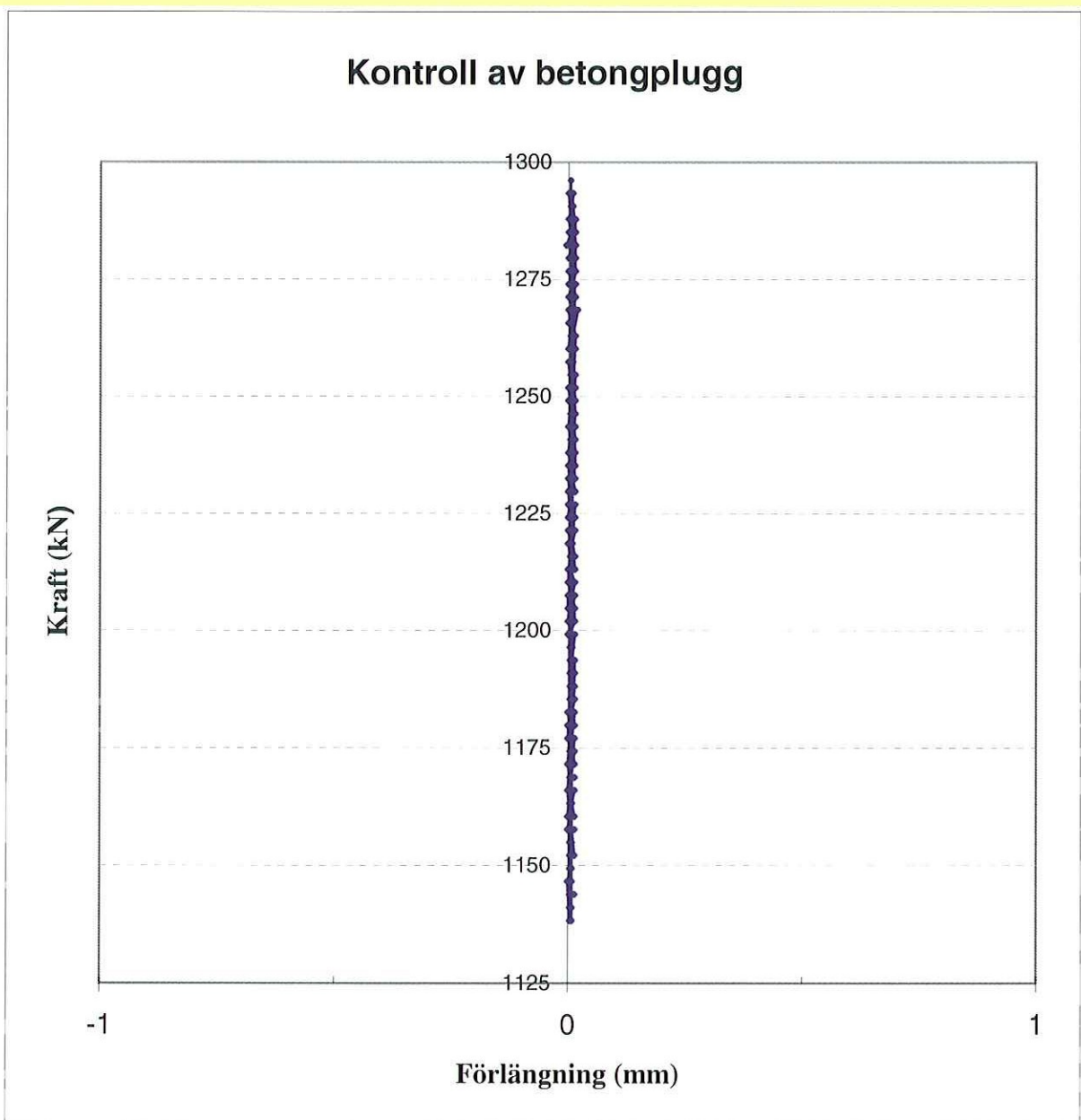
Stig Rydelius

Plugg:

K

Kommentar:

140 ton enl dig.manometer 400 bar. Uppmätt värde enl. skala 129,6 ton  
Provbalken pressades upp 5,97 mm. Röret pressades ned 6,85 mm



Projektnummer

Projekt

2422900

Provtryckning av betongplugg i borrhål

Kontroll datum:

Kontrollerad av:

2007-01-31

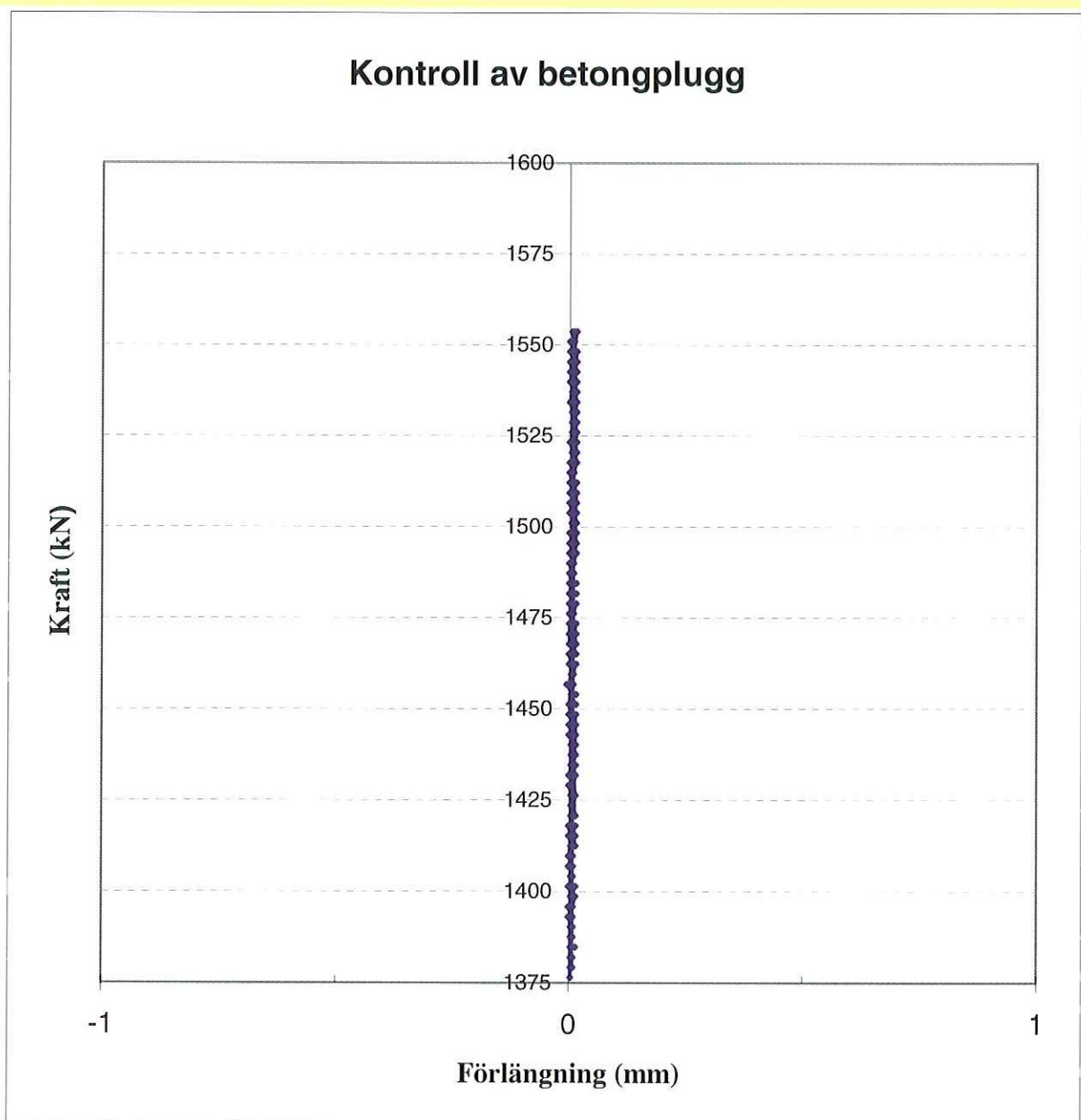
Stig Rydelius

Plugg:

K

Kommentar:

160 ton enl dig.manometer 455 bar. Uppmätt värde enl. skala 155,3 ton  
Provbalken pressades upp 6,65 mm. Röret pressades ned 8,4 mm



Projektnummer

2422900

Projekt

Provtryckning av betongplugg i borrhål

Kontroll datum:

2007-01-31

Kontrollerad av:

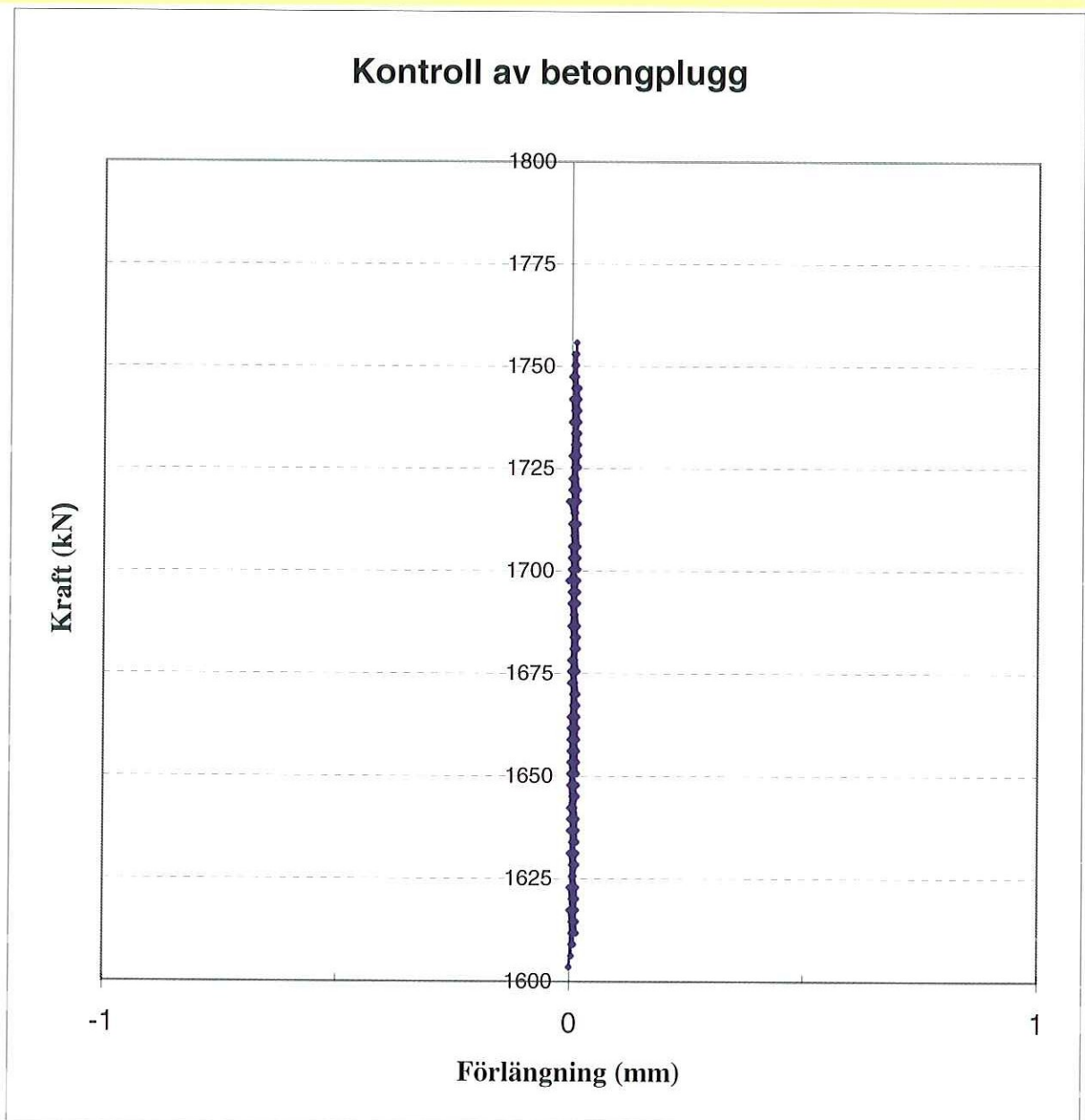
Stig Rydelius

Plugg:

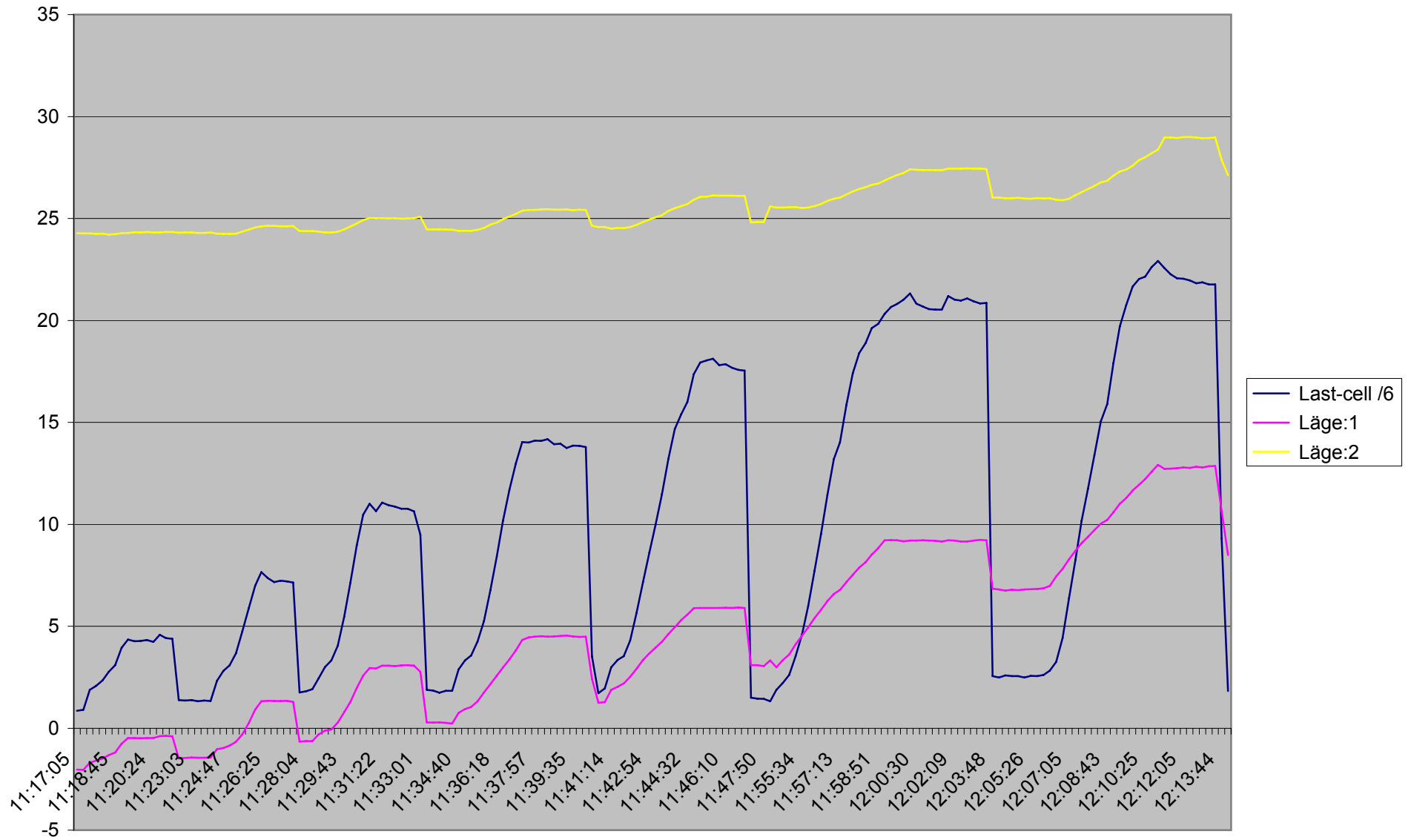
K

Kommentar:

180 ton enl dig.manometer 510 bar. Uppmätt värde enl. skala 175,5 ton  
Provbalken pressades upp 8,7 mm. Röret pressades ned 9,6 mm







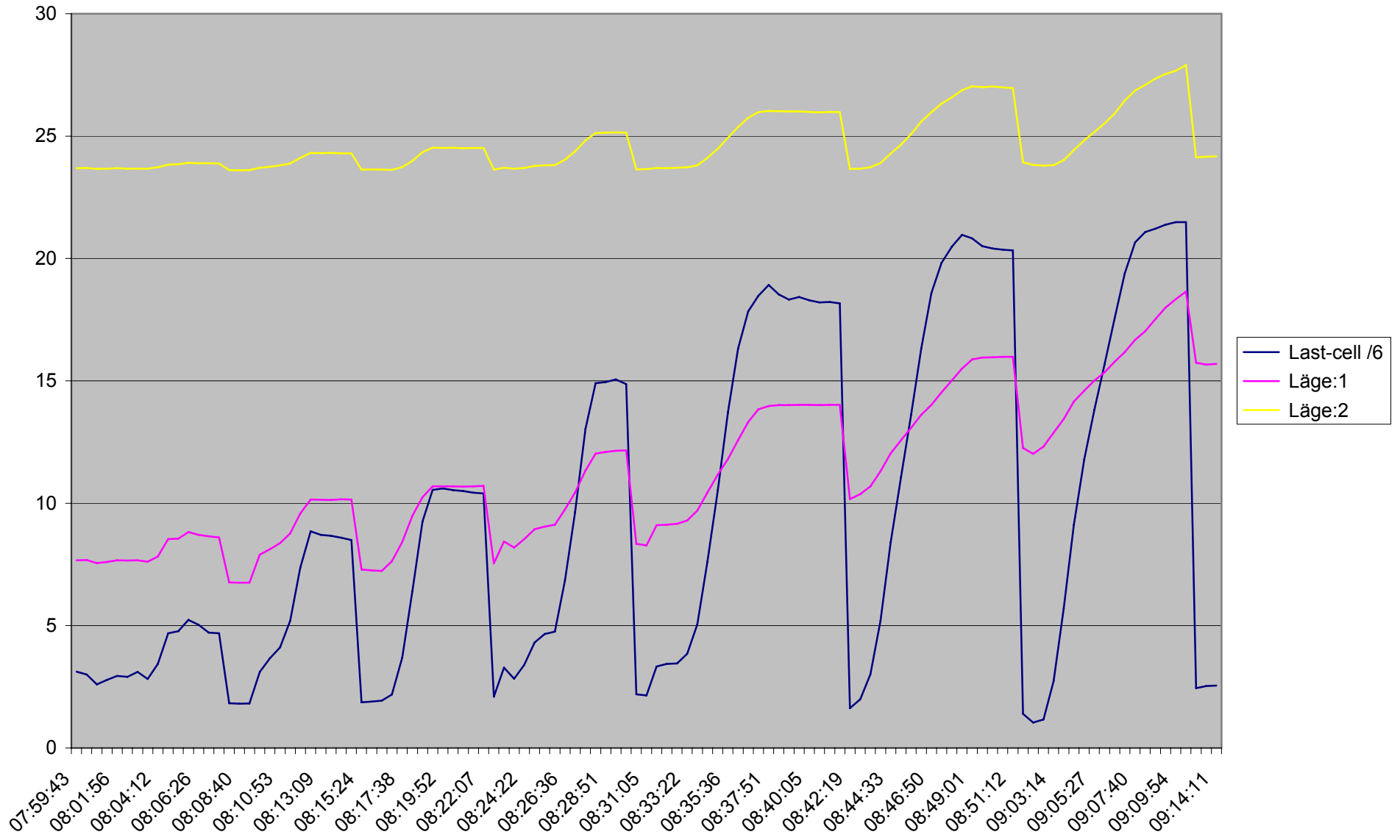


Date	Time	Last-cell /6	Läge:1	Läge:2	extra	Last-cell r
2007-02-06	11:17:05	0,85	-2,03	24,28		5,1
2007-02-06	11:17:22	0,905	-2,04	24,27		5,43
2007-02-06	11:17:38	1,878333333	-1,69	24,27		11,27
2007-02-06	11:17:55	2,078333333	-1,59	24,24		12,47
2007-02-06	11:18:12	2,345	-1,49	24,26		14,07
2007-02-06	11:18:28	2,763333333	-1,32	24,21		16,58
2007-02-06	11:18:45	3,091666667	-1,19	24,23		18,55
2007-02-06	11:19:01	3,935	-0,76	24,28		23,61
2007-02-06	11:19:18	4,353333333	-0,48	24,29		26,12
2007-02-06	11:19:34	4,271666667	-0,48	24,32		25,63
2007-02-06	11:19:51	4,278333333	-0,5	24,31		25,67
2007-02-06	11:20:07	4,325	-0,48	24,34		25,95
2007-02-06	11:20:24	4,23	-0,48	24,31		25,38
2007-02-06	11:20:40	4,586666667	-0,39	24,31		27,52
2007-02-06	11:20:57	4,415	-0,38	24,34		26,49
2007-02-06	11:21:15	4,38	-0,4	24,34		26,28
2007-02-06	11:21:31	1,378333333	-1,48	24,3		8,27
2007-02-06	11:21:47	1,351666667	-1,46	24,31		8,11
2007-02-06	11:23:03	1,378333333	-1,44	24,31		8,27
2007-02-06	11:23:21	1,323333333	-1,45	24,29		7,94
2007-02-06	11:23:39	1,351666667	-1,45	24,29		8,11
2007-02-06	11:23:57	1,33	-1,44	24,31		7,98
2007-02-06	11:24:14	2,325	-1,03	24,26		13,95
2007-02-06	11:24:30	2,811666667	-0,97	24,24		16,87
2007-02-06	11:24:47	3,078333333	-0,85	24,24		18,47
2007-02-06	11:25:03	3,668333333	-0,67	24,26		22,01
2007-02-06	11:25:19	4,756666667	-0,3	24,36		28,54
2007-02-06	11:25:36	5,888333333	0,25	24,45		35,33
2007-02-06	11:25:52	6,991666667	0,91	24,56		41,95
2007-02-06	11:26:09	7,65	1,32	24,62		45,9
2007-02-06	11:26:25	7,361666667	1,34	24,64		44,17
2007-02-06	11:26:42	7,17	1,33	24,64		43,02
2007-02-06	11:26:58	7,231666667	1,33	24,62		43,39
2007-02-06	11:27:15	7,205	1,35	24,62		43,23
2007-02-06	11:27:31	7,143333333	1,29	24,63		42,86
2007-02-06	11:27:48	1,755	-0,66	24,38		10,53
2007-02-06	11:28:04	1,81	-0,64	24,38		10,86
2007-02-06	11:28:21	1,913333333	-0,63	24,38		11,48
2007-02-06	11:28:38	2,44	-0,31	24,36		14,64
2007-02-06	11:28:54	3,003333333	-0,12	24,31		18,02
2007-02-06	11:29:10	3,318333333	-0,06	24,31		19,91
2007-02-06	11:29:27	4,045	0,27	24,35		24,27
2007-02-06	11:29:43	5,47	0,78	24,47		32,82
2007-02-06	11:29:59	7,128333333	1,29	24,61		42,77
2007-02-06	11:30:16	8,973333333	1,97	24,76		53,84
2007-02-06	11:30:32	10,473333333	2,58	24,92		62,84
2007-02-06	11:30:49	11,001666667	2,95	25,02		66,01
2007-02-06	11:31:05	10,651666667	2,93	25,01		63,91
2007-02-06	11:31:22	11,063333333	3,07	25,01		66,38
2007-02-06	11:31:38	10,94	3,07	25		65,64
2007-02-06	11:31:55	10,871666667	3,04	25,01		65,23
2007-02-06	11:32:12	10,768333333	3,08	24,99		64,61
2007-02-06	11:32:28	10,768333333	3,09	25		64,61
2007-02-06	11:32:44	10,638333333	3,07	25,01		63,83
2007-02-06	11:33:01	9,493333333	2,76	25,09		56,96

2007-02-06	11:33:18	1,885	0,29	24,46	11,31
2007-02-06	11:33:34	1,845	0,27	24,47	11,07
2007-02-06	11:33:51	1,735	0,28	24,46	10,41
2007-02-06	11:34:07	1,838333333	0,26	24,45	11,03
2007-02-06	11:34:23	1,838333333	0,23	24,45	11,03
2007-02-06	11:34:40	2,88	0,75	24,4	17,28
2007-02-06	11:34:56	3,318333333	0,94	24,39	19,91
2007-02-06	11:35:12	3,571666667	1,04	24,39	21,43
2007-02-06	11:35:29	4,25	1,32	24,44	25,5
2007-02-06	11:35:45	5,251666667	1,75	24,53	31,51
2007-02-06	11:36:01	6,773333333	2,16	24,7	40,64
2007-02-06	11:36:18	8,425	2,58	24,8	50,55
2007-02-06	11:36:35	10,17166667	2,97	24,96	61,03
2007-02-06	11:36:51	11,68666667	3,37	25,09	70,12
2007-02-06	11:37:08	12,975	3,81	25,22	77,85
2007-02-06	11:37:24	14,03833333	4,32	25,38	84,23
2007-02-06	11:37:40	14,01	4,45	25,42	84,06
2007-02-06	11:37:57	14,10666667	4,49	25,42	84,64
2007-02-06	11:38:13	14,09333333	4,51	25,44	84,56
2007-02-06	11:38:29	14,16833333	4,49	25,45	85,01
2007-02-06	11:38:46	13,92833333	4,5	25,43	83,57
2007-02-06	11:39:02	13,955	4,52	25,43	83,73
2007-02-06	11:39:19	13,74333333	4,55	25,44	82,46
2007-02-06	11:39:35	13,86	4,5	25,41	83,16
2007-02-06	11:39:52	13,84666667	4,48	25,43	83,08
2007-02-06	11:40:08	13,785	4,49	25,42	82,71
2007-02-06	11:40:24	3,516666667	2,43	24,64	21,1
2007-02-06	11:40:41	1,721666667	1,25	24,58	10,33
2007-02-06	11:40:58	1,955	1,27	24,58	11,73
2007-02-06	11:41:14	2,988333333	1,88	24,5	17,93
2007-02-06	11:41:31	3,345	2,03	24,53	20,07
2007-02-06	11:41:47	3,536666667	2,19	24,52	21,22
2007-02-06	11:42:05	4,298333333	2,52	24,58	25,79
2007-02-06	11:42:21	5,668333333	2,92	24,68	34,01
2007-02-06	11:42:38	7,17	3,35	24,82	43,02
2007-02-06	11:42:54	8,616666667	3,67	24,95	51,7
2007-02-06	11:43:10	9,98	3,95	25,06	59,88
2007-02-06	11:43:27	11,48833333	4,24	25,16	68,93
2007-02-06	11:43:43	13,20166667	4,62	25,37	79,21
2007-02-06	11:44:00	14,66833333	4,95	25,5	88,01
2007-02-06	11:44:16	15,395	5,3	25,6	92,37
2007-02-06	11:44:32	16,005	5,57	25,71	96,03
2007-02-06	11:44:49	17,36166667	5,89	25,92	104,17
2007-02-06	11:45:05	17,93166667	5,9	26,06	107,59
2007-02-06	11:45:21	18,03333333	5,9	26,07	108,2
2007-02-06	11:45:38	18,12333333	5,9	26,13	108,74
2007-02-06	11:45:54	17,8	5,9	26,12	106,8
2007-02-06	11:46:10	17,855	5,91	26,12	107,13
2007-02-06	11:46:27	17,68333333	5,9	26,12	106,1
2007-02-06	11:46:44	17,56833333	5,92	26,11	105,41
2007-02-06	11:47:00	17,53333333	5,9	26,11	105,2
2007-02-06	11:47:17	1,495	3,09	24,8	8,97
2007-02-06	11:47:33	1,446666667	3,09	24,83	8,68
2007-02-06	11:47:50	1,44	3,05	24,82	8,64
2007-02-06	11:54:12	1,316666667	3,32	25,59	7,9
2007-02-06	11:54:28	1,885	2,99	25,54	11,31

2007-02-06	11:54:44	2,221666667	3,33	25,54	13,33
2007-02-06	11:55:01	2,618333333	3,61	25,55	15,71
2007-02-06	11:55:17	3,53	4,12	25,56	21,18
2007-02-06	11:55:34	4,593333333	4,53	25,51	27,56
2007-02-06	11:55:50	5,991666667	4,94	25,53	35,95
2007-02-06	11:56:07	7,731666667	5,41	25,6	46,39
2007-02-06	11:56:23	9,521666667	5,8	25,71	57,13
2007-02-06	11:56:40	11,433333333	6,23	25,86	68,6
2007-02-06	11:56:56	13,195	6,58	25,97	79,17
2007-02-06	11:57:13	14,023333333	6,78	26,03	84,14
2007-02-06	11:57:29	15,846666667	7,16	26,18	95,08
2007-02-06	11:57:45	17,41	7,53	26,33	104,46
2007-02-06	11:58:02	18,396666667	7,87	26,44	110,38
2007-02-06	11:58:18	18,883333333	8,14	26,54	113,3
2007-02-06	11:58:34	19,616666667	8,51	26,65	117,7
2007-02-06	11:58:51	19,83	8,83	26,71	118,98
2007-02-06	11:59:07	20,316666667	9,21	26,86	121,9
2007-02-06	11:59:23	20,658333333	9,23	27	123,95
2007-02-06	11:59:39	20,803333333	9,21	27,13	124,82
2007-02-06	11:59:56	21,021666667	9,17	27,23	126,13
2007-02-06	12:00:14	21,323333333	9,2	27,41	127,94
2007-02-06	12:00:30	20,816666667	9,2	27,39	124,9
2007-02-06	12:00:46	20,68	9,21	27,37	124,08
2007-02-06	12:01:03	20,548333333	9,2	27,37	123,29
2007-02-06	12:01:19	20,528333333	9,19	27,37	123,17
2007-02-06	12:01:35	20,528333333	9,16	27,36	123,17
2007-02-06	12:01:52	21,193333333	9,21	27,45	127,16
2007-02-06	12:02:09	21,015	9,2	27,45	126,09
2007-02-06	12:02:25	20,966666667	9,16	27,45	125,8
2007-02-06	12:02:42	21,076666667	9,16	27,46	126,46
2007-02-06	12:02:58	20,94	9,2	27,44	125,64
2007-02-06	12:03:15	20,836666667	9,24	27,44	125,02
2007-02-06	12:03:31	20,85	9,22	27,42	125,1
2007-02-06	12:03:48	2,55	6,84	26,03	15,3
2007-02-06	12:04:04	2,481666667	6,81	26,02	14,89
2007-02-06	12:04:21	2,591666667	6,75	25,99	15,55
2007-02-06	12:04:37	2,556666667	6,79	25,99	15,34
2007-02-06	12:04:53	2,55	6,77	26,01	15,3
2007-02-06	12:05:10	2,488333333	6,8	25,98	14,93
2007-02-06	12:05:26	2,571666667	6,82	25,97	15,43
2007-02-06	12:05:42	2,556666667	6,83	26	15,34
2007-02-06	12:05:59	2,618333333	6,86	25,98	15,71
2007-02-06	12:06:15	2,818333333	6,98	25,99	16,91
2007-02-06	12:06:32	3,25	7,44	25,92	19,5
2007-02-06	12:06:48	4,435	7,82	25,9	26,61
2007-02-06	12:07:05	6,375	8,28	25,97	38,25
2007-02-06	12:07:21	8,253333333	8,7	26,14	49,52
2007-02-06	12:07:38	10,165	9,08	26,29	60,99
2007-02-06	12:07:54	11,755	9,39	26,44	70,53
2007-02-06	12:08:10	13,393333333	9,72	26,59	80,36
2007-02-06	12:08:27	15,045	10,03	26,77	90,27
2007-02-06	12:08:43	15,901666667	10,22	26,85	95,41
2007-02-06	12:09:00	17,896666667	10,59	27,09	107,38
2007-02-06	12:09:17	19,706666667	11,01	27,3	118,24
2007-02-06	12:09:33	20,755	11,29	27,4	124,53
2007-02-06	12:09:50	21,66	11,66	27,59	129,96

2007-02-06	12:10:08	22,03	11,94	27,86	132,18
2007-02-06	12:10:25	22,15333333	12,22	28	132,92
2007-02-06	12:10:42	22,61166667	12,58	28,2	135,67
2007-02-06	12:10:58	22,91333333	12,92	28,38	137,48
2007-02-06	12:11:15	22,565	12,72	28,97	135,39
2007-02-06	12:11:31	22,27	12,73	28,97	133,62
2007-02-06	12:11:48	22,07	12,75	28,95	132,42
2007-02-06	12:12:05	22,04333333	12,79	28,99	132,26
2007-02-06	12:12:22	21,96166667	12,77	28,99	131,77
2007-02-06	12:12:38	21,81666667	12,82	28,97	130,9
2007-02-06	12:12:54	21,87166667	12,79	28,94	131,23
2007-02-06	12:13:11	21,76166667	12,85	28,95	130,57
2007-02-06	12:13:27	21,76833333	12,86	28,97	130,61
2007-02-06	12:13:44	9,30166667	10,67	27,87	55,81
2007-02-06	12:14:01	1,82333333	8,49	27,12	10,94







Date	Time	Last-cell /6	Läge:1	Läge:2	Last-cell råvärde
2007-02-06	07:59:43	3,12	7,67	23,69	18,72
2007-02-06	08:00:16	3,003333333	7,68	23,7	18,02
2007-02-06	08:00:49	2,598333333	7,55	23,66	15,59
2007-02-06	08:01:22	2,776666667	7,6	23,67	16,66
2007-02-06	08:01:56	2,948333333	7,67	23,69	17,69
2007-02-06	08:02:29	2,906666667	7,66	23,67	17,44
2007-02-06	08:03:05	3,105	7,67	23,67	18,63
2007-02-06	08:03:39	2,818333333	7,61	23,67	16,91
2007-02-06	08:04:12	3,435	7,82	23,73	20,61
2007-02-06	08:04:46	4,688333333	8,53	23,83	28,13
2007-02-06	08:05:19	4,771666667	8,55	23,85	28,63
2007-02-06	08:05:52	5,236666667	8,82	23,91	31,42
2007-02-06	08:06:26	5,031666667	8,71	23,89	30,19
2007-02-06	08:06:59	4,716666667	8,65	23,89	28,3
2007-02-06	08:07:33	4,688333333	8,6	23,88	28,13
2007-02-06	08:08:06	1,823333333	6,76	23,61	10,94
2007-02-06	08:08:40	1,81	6,75	23,6	10,86
2007-02-06	08:09:13	1,816666667	6,75	23,61	10,9
2007-02-06	08:09:47	3,105	7,9	23,71	18,63
2007-02-06	08:10:20	3,668333333	8,12	23,75	22,01
2007-02-06	08:10:53	4,106666667	8,37	23,8	24,64
2007-02-06	08:11:28	5,196666667	8,77	23,88	31,18
2007-02-06	08:12:01	7,368333333	9,58	24,11	44,21
2007-02-06	08:12:35	8,85	10,15	24,31	53,1
2007-02-06	08:13:09	8,705	10,14	24,3	52,23
2007-02-06	08:13:42	8,671666667	10,13	24,31	52,03
2007-02-06	08:14:15	8,595	10,16	24,29	51,57
2007-02-06	08:14:49	8,5	10,15	24,29	51
2007-02-06	08:15:24	1,865	7,29	23,63	11,19
2007-02-06	08:15:57	1,9	7,25	23,64	11,4
2007-02-06	08:16:31	1,933333333	7,24	23,63	11,6
2007-02-06	08:17:04	2,186666667	7,63	23,62	13,12
2007-02-06	08:17:38	3,695	8,42	23,74	22,17
2007-02-06	08:18:12	6,41	9,49	23,99	38,46
2007-02-06	08:18:46	9,26	10,25	24,34	55,56
2007-02-06	08:19:19	10,548333333	10,69	24,53	63,29
2007-02-06	08:19:52	10,603333333	10,69	24,52	63,62
2007-02-06	08:20:26	10,535	10,69	24,53	63,21
2007-02-06	08:20:59	10,495	10,68	24,51	62,97
2007-02-06	08:21:33	10,425	10,69	24,52	62,55
2007-02-06	08:22:07	10,398333333	10,71	24,52	62,39
2007-02-06	08:22:40	2,098333333	7,54	23,63	12,59
2007-02-06	08:23:15	3,283333333	8,44	23,71	19,7
2007-02-06	08:23:48	2,825	8,19	23,67	16,95
2007-02-06	08:24:22	3,393333333	8,53	23,7	20,36
2007-02-06	08:24:56	4,311666667	8,94	23,78	25,87
2007-02-06	08:25:29	4,655	9,04	23,8	27,93
2007-02-06	08:26:03	4,75	9,12	23,81	28,5
2007-02-06	08:26:36	6,855	9,75	24,03	41,13
2007-02-06	08:27:10	9,638333333	10,44	24,38	57,83
2007-02-06	08:27:44	13,036666667	11,33	24,82	78,22
2007-02-06	08:28:17	14,901666667	12,03	25,12	89,41
2007-02-06	08:28:51	14,95	12,09	25,14	89,7
2007-02-06	08:29:24	15,058333333	12,14	25,15	90,35
2007-02-06	08:29:58	14,866666667	12,16	25,14	89,2
2007-02-06	08:30:32	2,193333333	8,34	23,64	13,16

2007-02-06	08:31:05	2,146666667	8,27	23,65	12,88
2007-02-06	08:31:39	3,325	9,1	23,7	19,95
2007-02-06	08:32:14	3,435	9,12	23,69	20,61
2007-02-06	08:32:48	3,455	9,16	23,71	20,73
2007-02-06	08:33:22	3,846666667	9,29	23,73	23,08
2007-02-06	08:33:56	5,051666667	9,7	23,8	30,31
2007-02-06	08:34:29	7,621666667	10,44	24,11	45,73
2007-02-06	08:35:03	10,521666667	11,17	24,49	63,13
2007-02-06	08:35:36	13,715	11,81	24,93	82,29
2007-02-06	08:36:10	16,32	12,58	25,37	97,92
2007-02-06	08:36:43	17,835	13,32	25,75	107,01
2007-02-06	08:37:17	18,471666667	13,84	25,98	110,83
2007-02-06	08:37:51	18,918333333	13,97	26,03	113,51
2007-02-06	08:38:24	18,526666667	14,01	26,02	111,16
2007-02-06	08:38:58	18,315	14,01	26,01	109,89
2007-02-06	08:39:32	18,425	14,02	26,01	110,55
2007-02-06	08:40:05	18,293333333	14,02	25,99	109,76
2007-02-06	08:40:39	18,205	14,01	25,97	109,23
2007-02-06	08:41:12	18,225	14,02	25,99	109,35
2007-02-06	08:41:46	18,163333333	14,02	25,98	108,98
2007-02-06	08:42:19	1,625	10,17	23,66	9,75
2007-02-06	08:42:53	1,995	10,37	23,67	11,97
2007-02-06	08:43:26	3,01	10,69	23,73	18,06
2007-02-06	08:44:00	5,21	11,31	23,9	31,26
2007-02-06	08:44:33	8,403333333	12,04	24,28	50,42
2007-02-06	08:45:10	11,063333333	12,58	24,65	66,38
2007-02-06	08:45:43	13,626666667	13,09	25,08	81,76
2007-02-06	08:46:17	16,326666667	13,61	25,59	97,96
2007-02-06	08:46:50	18,588333333	14,02	25,98	111,53
2007-02-06	08:47:23	19,823333333	14,53	26,32	118,94
2007-02-06	08:47:56	20,486666667	15,02	26,58	122,92
2007-02-06	08:48:29	20,966666667	15,5	26,87	125,8
2007-02-06	08:49:01	20,816666667	15,88	27,04	124,9
2007-02-06	08:49:34	20,508333333	15,95	27	123,05
2007-02-06	08:50:07	20,411666667	15,96	27,03	122,47
2007-02-06	08:50:40	20,356666667	15,98	26,99	122,14
2007-02-06	08:51:12	20,33	15,98	26,96	121,98
2007-02-06	08:51:45	1,391666667	12,26	23,93	8,35
2007-02-06	09:02:06	1,035	12,02	23,82	6,21
2007-02-06	09:02:41	1,166666667	12,32	23,79	7
2007-02-06	09:03:14	2,735	12,88	23,81	16,41
2007-02-06	09:03:48	5,703333333	13,44	24,02	34,22
2007-02-06	09:04:21	9,123333333	14,15	24,43	54,74
2007-02-06	09:04:55	11,79	14,6	24,82	70,74
2007-02-06	09:05:27	13,818333333	15,01	25,17	82,91
2007-02-06	09:06:01	15,661666667	15,35	25,52	93,97
2007-02-06	09:06:34	17,553333333	15,78	25,92	105,32
2007-02-06	09:07:07	19,39	16,17	26,45	116,34
2007-02-06	09:07:40	20,658333333	16,67	26,86	123,95
2007-02-06	09:08:14	21,083333333	17,03	27,09	126,5
2007-02-06	09:08:47	21,213333333	17,52	27,34	127,28
2007-02-06	09:09:21	21,378333333	17,99	27,54	128,27
2007-02-06	09:09:54	21,481666667	18,34	27,67	128,89
2007-02-06	09:10:28	21,488333333	18,65	27,9	128,93
2007-02-06	09:13:04	2,44	15,74	24,13	14,64
2007-02-06	09:13:38	2,53	15,66	24,16	15,18
2007-02-06	09:14:11	2,55	15,69	24,17	15,3