

P-05-69

Oskarshamn site investigation

Overcoring rock stress measurements in borehole KLX04

Jonny Sjöberg, Fredrik Perman
SwedPower AB

December 2006

Svensk Kärnbränslehantering AB

Swedish Nuclear Fuel
and Waste Management Co
Box 5864

SE-102 40 Stockholm Sweden

Tel 08-459 84 00

+46 8 459 84 00

Fax 08-661 57 19

+46 8 661 57 19



ISSN 1651-4416

SKB P-05-69

Oskarshamn site investigation

Overcoring rock stress measurements in borehole KLX04

Jonny Sjöberg, Fredrik Perman
SwedPower AB

December 2006

Keywords: Stress measurement, Three-dimensional overcoring, Borre probe, Stress state.

This report concerns a study which was conducted for SKB. The conclusions and viewpoints presented in the report are those of the authors and do not necessarily coincide with those of the client.

A pdf version of this document can be downloaded from www.skb.se

Summary

Overcoring stress measurements were conducted in borehole KLX04 at the Oskarshamn site. The equipment used for the measurements was the three-dimensional *Borre* probe. Measurements were planned to be conducted at three measurement levels in borehole KLX04, but only two measurement levels could be said to be completed successfully. Level 1 included measurements between 233 and 245 m borehole length. For Level 2, measurements were attempted between 374 and 451 m borehole lengths. This large depth interval was required to obtain a complete test series due to problems associated with the presence of rock fragments (due to borehole instabilities) and drill cuttings in the borehole, thus inhibiting correct installation of the measurement probe. After completed measurement at this level, SKB decided to terminate the measurement campaign.

The stress state near borehole KLX04 is characterized by low stresses at Level 1 (approximately 250 m depth) and a ENE-WSW orientation of the major principal stress. The three deepest measurements at Level 2 (approximately 450 m depth) pointed at relatively high stresses, and a nearly N-S stress orientation. The consistency between different measurements was also relatively good for these three tests, thus indicating that they reflect the actual stress state near the borehole. For Level 2, the vertical stress was not reliably determined from the overcoring measurements due to probable tensile core damage, as indicated by conducted transient strain analysis. Since the results indicate a steeply dipping major principal stress with a trend that is different than the regional stress orientation, and since large variations were found over short vertical distances (for the upper test locations at Level 2), additional interpretations are required. It cannot be ruled out that the stresses at these depths are lower, as indicated by some of the other measurements at Level 2. The obtained stress data should be analysed and correlated to geological data (lithology, structures, fracture zones, etc) at the site, as well as compared to measurements in nearby areas.

Sammanfattning

Bergspänningsmätningar med överborrningsmetoden har genomförts i borrhål KLX04 i Oskarshamn. Vid mätningarna användes *Borre*-cellen, vilken är en tredimensionell mätmetod. Mätningarna avsågs att utföras på tre mätnivåer i borrhålet, men endast två nivåer kunde slutföras i sin helhet. Den första nivån omfattade mätforsök på mellan 233 och 245 m borrhåls-längd. Mätningar på den andra nivån utfördes mellan 374 och 451 m hållängd. Det krävdes hela denna sträcka för att erhålla en komplett mätserie, beroende på problem med bergfragment (på grund av borrhålsinstabiliteter) och borrhålskax i hålet, vilket omöjliggjorde korrekt installation av mätsonden. Efter slutförd mätning på denna nivå, beslutade SKB att avsluta mätkampanjen.

Spänningstillståndet i borrhål KLX04 karakteriseras av låga spänningar på mätnivå 1 (ca 250 m djup) och en ÖNÖ-VSV orientering av största huvudspänningen. De tre djupast belägna mätningarna på mätnivå 2 indikerade relativt höga spänningar och en nästan N-S riktning på största huvudspänningen. Överensstämmelsen mellan enskilda mätpunkter är relativt god för dessa mätningar, vilket tyder på att de erhållna spänningsdata motsvarar det verkliga spänningsfältet nära borrhålet. Vertikalspänningen för mätnivå 2 är dock ej bestämd med tillförlitlighet på grund av troliga skador på överborrningskärnorna till följd av höga dragspänningar. Det senare indikerades via transient töjningsanalys. Eftersom resultaten också visar på en starkt stupande största huvudspänning med en orientering som avviker från den regionala spänningsriktningen, samt att variationerna är stora över korta vertikala avstånd (för de övre mätningarna på mätnivå 2) krävs ytterligare tolkningar. Erhållna spänningsdata bör analyseras och korreleras mot geologiska data (litologi, strukturer, krosszoner, etc) i området, samt jämföras i mer detalj mot mätresultat från närliggande områden.

Contents

1	Introduction	7
2	Objective and scope	9
3	Equipment	11
3.1	The overcoring method	11
3.2	Description of field equipment	11
4	Execution	15
4.1	General	15
4.2	Preparations	15
4.3	Execution of measurements	15
4.3.1	Pilot hole drilling	15
4.3.2	Preparation and installation	17
4.3.3	Overcoring	17
4.3.4	Biaxial testing	17
4.4	Data handling	18
4.5	Data analyses	18
4.5.1	Classical overcoring analysis and stress calculation	18
4.5.2	Transient strain analysis	20
5	Results	23
5.1	Overview	23
5.2	Overcoring test data	26
5.2.1	Measurement level 1	26
5.2.2	Measurement level 2	27
5.3	Biaxial test data	27
5.4	In situ stress state	28
5.5	Transient strain analysis	31
5.5.1	Transient strain response	31
5.5.2	Inverse solution stress estimate	32
5.6	Summary results and discussion	35
6	References	39
Appendix A	Key measurement data	41
Appendix B	Overcoring strain data and graphs	51
Appendix C	Biaxial test data	71
Appendix D	Stress calculation input data and results	81
Appendix E	Transient strain analysis results	83
Appendix F	Overcore logging sheets	85
Appendix G	Photos of core samples	95
Appendix H	Confidence intervals for measured stresses	99
Appendix I	Quality operating procedures for overcoring measurements	103

1 Introduction

This document reports the data gained from three-dimensional overcoring rock stress measurements in borehole KLX04, which is one of the activities within the site investigation at Oskarshamn. The borehole is located in the Laxemar sub-area as shown in Figure 1-1, together with other investigation holes in the area.

The borehole was drilled subvertically (at approximately 85° dip) from the ground surface and is of “telescope” type with the upper 100 m of larger diameter (250 mm), which subsequently is cased. The rest of the borehole is drilled with 76 mm diameter down to a depth of 1,000 m. Overcoring rock stress measurements were planned to be conducted at approximately 250, 400 and 500 m depth, during drilling of the hole, according to the activity plan AP PS 400-04-007 (SKB internal controlling document). All results are stored in the SKB database SICADA.

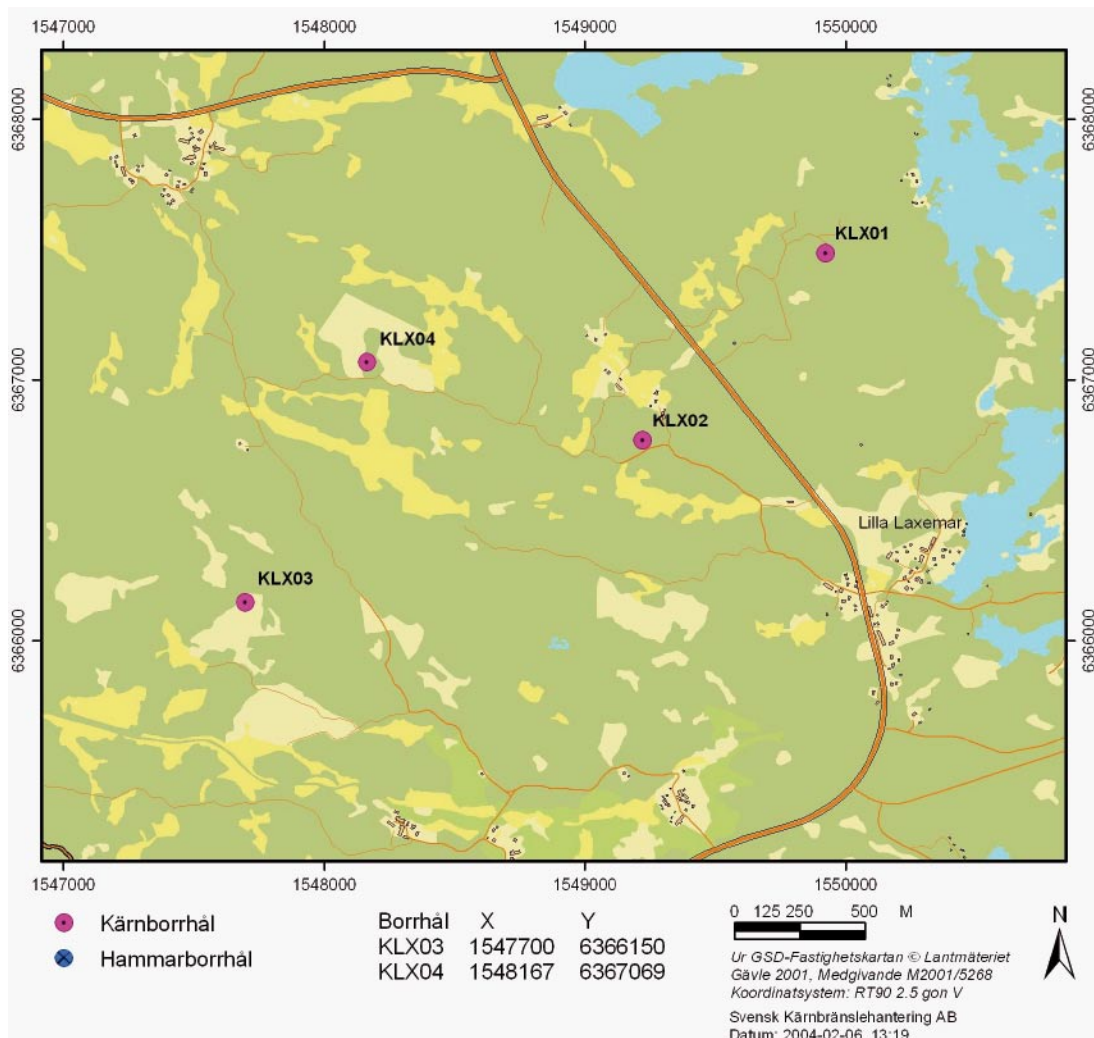

Figure 1-1. Location of core holes (initial “K”) within the Laxemar area, as of February, 2004.

2 Objective and scope

The objective of the overcoring rock stress measurements was to determine the complete in situ stress field in the undisturbed rock mass at three measurement levels: 250, 400, and 500 m borehole length (corresponding to slightly less vertical depth since the borehole is inclined). This was to be achieved by 3–4 successful test results from each level.

All measurements were conducted using the three-dimensional *Borre* probe for overcoring (developed and used by SwedPower AB). The method is described in detail in Chapter 3 of this report. Field measurements were done in two periods during 2004. The first period started March 24 and was completed April 7. The second field period commenced April 19 and was completed May 21.

Execution of field measurements and data analysis is presented in Chapter 4 of this report. In addition to conventional analysis of overcoring data, transient strain analysis was conducted, following the methodology developed by /Hakala et al. 2003/. The objective of this analysis was to aid in: (i) quality control of the overcoring data, (ii) judgment of reliability of single measurements, and (iii) possibly establishing bounds on the measured stresses. Transient strain analysis was conducted for all successful measurements from the two measurement levels. All measurement results are presented in Chapter 5, along with a brief discussion of the test results. Measurement and analysis data from the tests are reported in Appendices A through H.

All stresses presented in this report are denoted using a geomechanical sign convention with compressive stresses taken as positive. Compressive strains are, however, defined as negative. All stress orientations are given with respect to geographic north (based on borehole orientation measurements), using a right-hand rule notation. Measurement positions are given as the hole length at the gauge position of the measurement probe.

The presentation of this report is restricted to the work done and the results obtained, as such. It is neither attempted to put the data into a geological/tectonic context, nor to discuss the implications of the results for future work.

3 Equipment

3.1 The overcoring method

Three-dimensional overcoring rock stress measurements are based on measuring strains when a sample of rock is released from the rock mass and the stresses acting upon it. The in situ stresses can be calculated from the measured strains and with knowledge of the elastic properties of the rock. The complete, three-dimensional, stress tensor is determined from a single measurement, under the assumption of continuous, homogeneous, isotropic and linear-elastic rock behaviour /Leeman and Hayes 1966, Leeman 1968/.

3.2 Description of field equipment

The *Borre* probe /Sjöberg and Klasson 2003/ is owned and used by SwedPower AB for stress measurements in deep, water-filled boreholes. The equipment for overcoring rock stress measurements using the *Borre* probe comprises:

- pilot hole drilling equipment for wireline core drilling, including planing tool,
- inspection tool (test probe) with built-in borehole cleaning brush,
- *Borre* probe with built-in data logger,
- set of strain gauges (to be mounted on the *Borre* probe),
- glue (for bonding strain gauges to the borehole wall),
- cell adapter (installation tool),
- biaxial test equipment including load cell, pressure gauge, hydraulic pump and strain indicator and,
- portable computer.

A new pilot hole wireline drilling equipment was recently developed for use with two of the major wireline systems utilized in Sweden – the Hagby WL76 Metric Thinwall Wireline System, and the Atlas Copco CORAC N3/50 System. Both these systems produce a 76 mm overall hole diameter (albeit with slight differences in drill bit diameter for the two systems), whereas the obtained pilot hole diameter is 36 mm using the developed pilot hole equipment. In this project, the Atlas Copco CORAC N3/50 equipment was used for drilling.

The developed wireline pilot hole equipment is fitted to the wireline drill string. Thrusting of the pilot hole drill is controlled through water pressure in the drill string, whereas rotation is transferred through the drill string itself. The unique design of the equipment ensures that the pilot hole is always drilled for a length of 75 cm. The pilot core is recovered through the wireline drill string in the normal fashion for wireline systems. The drilling equipment also includes a planing tool attached to the wireline equipment, which is used to grind the base of the borehole to ensure that it is planar. Overcoring equipment includes a specially manufactured, thinwall, core barrel and coring bit producing a nominal core diameter of 61.7 mm, i.e. equal to that produced by using conventional Craelius T2-76 equipment. The latter is a requirement for being able to fit overcored samples into the biaxial test cell.

The most vital part of the equipment is the *Borre* probe, which is shown in Figure 3-1. The instrument carries nine electrical resistance strain gauges mounted in three rosettes. Each rosette comprises three strain gauges oriented (i) parallel (axial or longitudinal gauges), (ii) perpendicular (circumferential or tangential gauges), and (iii) at a 45° angle, to the borehole axis, respectively, see Figure 3-2. The strain-gauge rosettes are bonded to three plastic cantilever



Figure 3-1. The Borre probe.

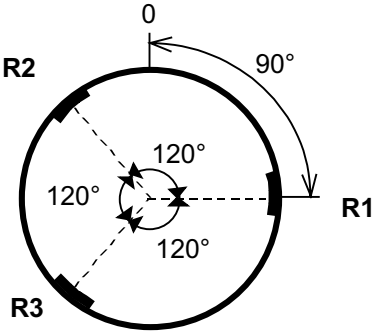

Strain gauge rosette seen from center of borehole

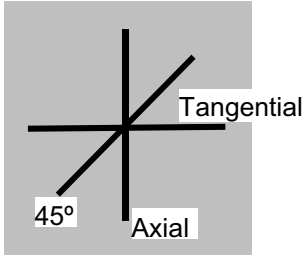

Hole axis

Figure 3-2. Strain gauge configuration of the Borre probe. Axial strain gauges are denoted L1, L2, and L3 (gauge nos. 1, 4, 7), tangential gauges are denoted T1, T2, and T3 (gauge nos. 2, 5, 8), and inclined gauges are denoted 45-1, 45-2, and 45-3 (gauge nos. 3, 6, 9).

arms at the lower end of the probe, which is the only part of the instrument that enters into the pilot hole. The arms are located 120° apart with a known orientation to the main body of the instrument. Thus, the nine strain gauges of the *Borre* probe form an array representing seven spatially different directions. All strain gauges are mounted at a depth of 160 mm in the pilot hole.

The strain gauges are connected to a data logger inside the probe. The probe also measures the temperature in the borehole to assess the temperature effects on the readings during the overcoring phase. An extra wire is used, which is wired directly into the wheatstone measuring bridge, thus providing automatic temperature compensation for wire resistance during actual strain recording.

The present version of the logger is termed *Borre III* and has two recording modes – sparse and dense recording. Sparse recording – every 15 minutes – is conducted from the time of activation to a selected start time for dense recording. The sparse recording provides a quality check of glue hardening and possible disturbances prior to overcoring. Dense recording is done in user-specified intervals of between 3 and 60 seconds, from the pre-set start time (set to just before anticipated start of actual overcoring) until the core is recovered and logging terminated. The data logger is programmed through connection to a portable computer before installation of the probe in the borehole. No further connection to the ground surface is required after this programming.

Description of the details of the *Borre* probe and other components of the equipment is further presented in /Sjöberg and Klasson 2003/ and in SKB MD 181.001 (SKB internal controlling document).

4 Execution

4.1 General

In the following, the execution of overcoring measurements is briefly described. Measurements were conducted in accordance with extensive quality operating procedures for the method used. A list of the constituent procedures is given in Appendix I, see also SKB MD 181.001 (SKB internal controlling document).

4.2 Preparations

Preparations before measurement start include (according to the method description):

- functional checks of strain gauges and data logger in the probe,
- calibration of biaxial test equipment,
- glue test on every new glue purchase and,
- functional checks of drilling and installation equipment.

4.3 Execution of measurements

Overcoring stress measurement using the *Borre* probe involves:

1. Pilot hole drilling and examination.
2. Preparation and installation of the *Borre* probe.
3. Overcoring and recovery of the probe.
4. Biaxial testing of the overcore sample.

The procedure for stress measurement using the *Borre* probe is briefly summarized in Figure 4-1. Each stage is succinctly described below.

4.3.1 Pilot hole drilling

The 76 mm borehole is advanced to the target test depth, specified in advance. Once at this depth, a decision as to whether attempt pilot hole drilling is made. The main criterion for attempting a pilot hole is that the 76 mm drill core shall carry homogeneous rock close to the hole bottom. Discrete fractures may be accepted if the overall fracture frequency and/or orientation of discontinuities indicate that the pilot hole core shall be homogeneous and free of open fractures. If these requirements are not met, the 76 mm borehole is extended another 1–3 m.

Once a decision on pilot hole drilling is taken, the bottom of the 76 mm hole is grinded to ensure that it is planar. Using wireline pilot hole drilling, a 0.75 m long pilot hole is drilled. The borehole is flushed and the return water checked for cleanness (free of debris). The retrieved pilot core is inspected to determine whether the hole location is suitable for testing. The criteria on the pilot hole core for the decision to go on with the test are the following:

- **3–25 cm (length):** Continuous core, mechanical fractures accepted. No healed fracture that can be extrapolated to cross close to the gauge position at 16 cm during the subsequent overcoring process.

- **15–17 cm (length):** No larger and/or different mineral crystals than elsewhere on the core shall be present around 16 cm. Pegmatite shall be avoided if possible.
- Any direct or indirect information on core damage (core discing, microcracking, etc) on the pilot core surface is an evidence of non-linear and inelastic behaviour, which render the core unacceptable.

As the hollow overcored core is more vulnerable to core damage, there is no reason to proceed with measurement if there is any core damage or any features present as described above.

If these criteria are not met, but conditions appear to be better at a slightly deeper location in the pilot hole, planing and grinding of the bottom of the 76 mm hole may be performed to reach a more suitable location for the strain gauges (always installed 16 cm from the bottom of the 76 mm hole). Planing of up to 10 cm can normally be achieved in practice. If planing is not possible within the above limits, a new pilot hole is instead drilled.

If the pilot hole is judged acceptable for installation, a test probe is lowered down the borehole to check that the pilot hole is open and free from debris.

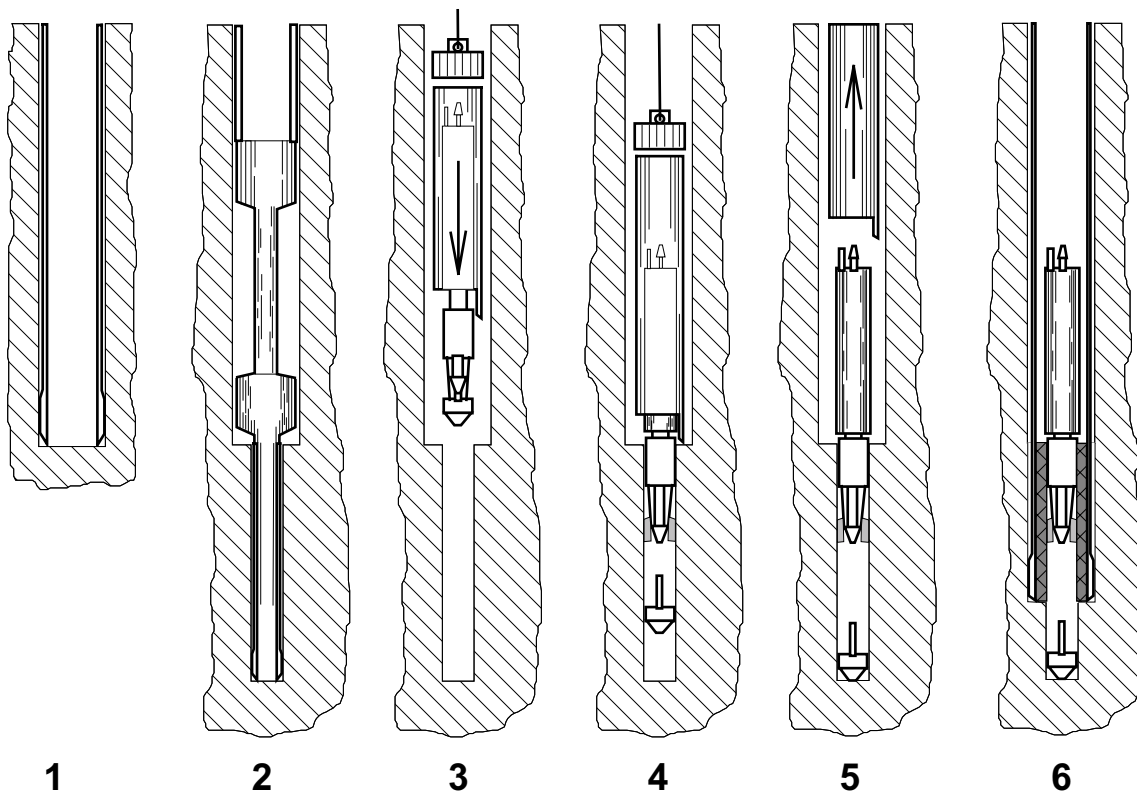

Figure 4-1. Installation and measurement procedure with the Borre probe:

1. Advance 76 mm-diameter main borehole to measurement depth. Grind the hole bottom using the planing tool.
2. Drill 36 mm-diameter pilot hole and recover core for appraisal. Flush the borehole to remove drill cuttings.
3. Prepare the Borre probe for measurement and apply glue to strain gauges. Insert the probe in installation tool into hole.
4. Tip of probe with strain gauges enters the pilot hole. Probe releases from installation tool through a latch, which also fixes the compass, thus recording the installed probe orientation. Gauges bonded to pilot hole wall under pressure from the nose cone.
5. Allow glue to harden (usually overnight). Pull out installation tool and retrieve to surface. The probe is bonded in place.
6. Overcore the Borre probe and record strain data using the built-in data logger. Break the core after completed overcoring and recover in core barrel to surface.

4.3.2 Preparation and installation

If the conditions for a suitable pilot hole are satisfied, and the pilot hole is open and free from debris, the *Borre* probe is prepared for installation into the pilot borehole. The preparations include:

- attaching strain gauges to the probe and connecting them to the logger,
- programming of the data logger with start time and sampling interval,
- attaching the probe and the compass to the installation tool and,
- mixing and applying glue to the strain gauges.

The probe is then installed into the pilot hole, as shown in Figure 4-1. The probe is left in the hole for a minimum of 8 hours (usually overnight) for proper bonding of strain gauges to the pilot hole wall.

4.3.3 Overcoring

Overcoring of the probe involves flushing before and after overcoring, to stabilize temperatures. A checklist is followed to control drilling rate, rotational speeds, flushing, etc (according to the method description). Coring advance is done at a specified constant rate (normally 3 cm/min). In practice, it is difficult for the drilling contractor to maintain a constant rate throughout the overcoring process; hence, variations are almost always present. The coring advance was registered manually using a watch and markers on the drill string for every 4th cm up to 32 cm overcoring length, after as well as for completed overcoring (normally 100 cm length).

The borehole is left with no on-going activity for approximately 15 minutes after completed overcoring but before the core is broken loose from the hole. This procedure ensures that sufficient strain data are recorded to assess temperature effects, possible non-ideal rock behaviour, etc, which may affect strain readings and measurement results adversely.

After overcoring, the probe is recovered with the overcore sample inside the core barrel. Strain data are transferred from the data logger to a portable computer. The overcore sample is then mapped with respect to length, concentricity, gauge positions, lithology, structures, microcracks and other possible defects.

4.3.4 Biaxial testing

Biaxial testing of the overcored specimens is conducted to determine the elastic constants of the rock at the measurement position. Testing is carried out on-site as soon as possible after overcoring, using the equipment shown in Figure 4-2. The overcore sample must be at least 24 cm long, without fractures, for biaxial testing to be possible.

The test sequence comprises both loading and unloading in order to study possible inelastic behaviour of the rock. The sample is loaded to a maximum radial pressure of 10 MPa, in increments of 1 MPa, and then unloaded in the same manner. The strains induced in the overcore sample are monitored by the strain gauges installed by the *Borre* probe, using the built-in data logger of the probe. After completed test sequence, the *Borre* probe is disconnected from the overcore sample. Supplementary logging of the core is performed to check for potential new fractures. Inner and outer core diameter, as well as the annular thickness of the overcore sample, is also measured.

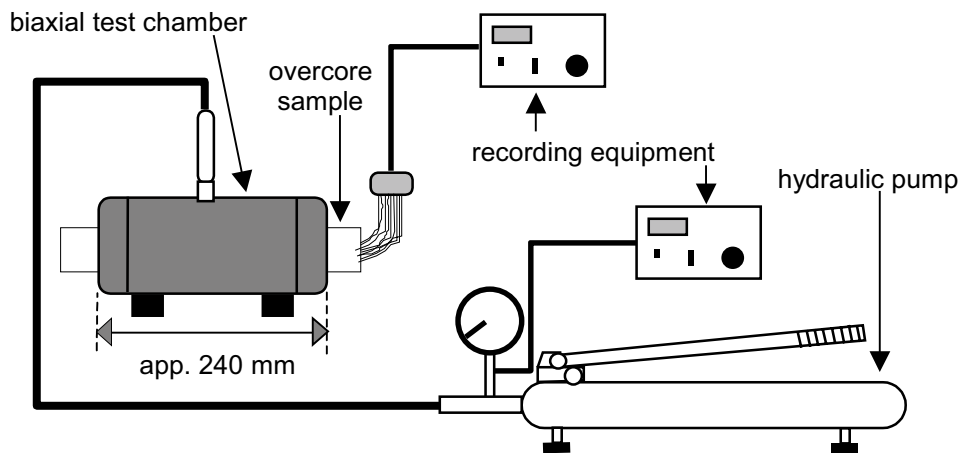

Figure 4-2. Schematic drawing of the biaxial load cell with pressure generator and recording equipment.

4.4 Data handling

The raw data include overcoring strain data files, biaxial strain data files, and completed check-lists and QA Report Forms from measurements. Routine data processing of measurement data involves importing the strain data file from overcoring into an in-house developed *Microsoft Excel* application for presenting overcoring strain response. Graphing of the strain response is performed automatically by the software application, and strain differences calculated based on input start- and stop-times for the overcoring process.

Similarly, the strain data file from biaxial testing is imported into the corresponding *Excel* application for presentation of biaxial test response and automatic calculation of elastic constants (Young's modulus and Poisson's ratio).

Calculation of stresses is carried out using another in-house developed *Microsoft Excel* application, with input in the form of strain differences, values on elastic constants, and borehole and recorded strain gauge orientation from the probe installation. The stress calculations are based on the theory presented by /Leeman 1968/. Calculation is performed for a single measurement, or for several successive measurements on one or several test levels, with automatic calculation of average stresses for each level.

The primary data reported from the overcoring stress measurements are:

- magnitudes of the three principal stresses,
- orientations of the three principal stresses (bearing and dip),
- magnitudes and orientations of the stresses acting in the horizontal and vertical planes and,
- values on elastic constants from biaxial testing.

4.5 Data analyses

4.5.1 Classical overcoring analysis and stress calculation

The *Borre* probe is a "soft" stress cell, which means that the stiffness of the strain gauges is negligible in comparison to the stiffness of the rock. Thus, only the strains induced by overcoring and the elastic constants of the rock, in addition to the orientation of the probe in the borehole (including borehole orientation), are required to determine the complete stress tensor. Calculation of stresses from strain is done under the assumption of continuous, homogeneous,

isotropic, and linear-elastic rock behaviour /Leeman 1968/. The stress relief is identical in magnitude to that produced by the in situ stress field but opposite in sign.

The analysis of obtained test data comprise (i) analysis of overcoring strain data, (ii) analysis of biaxial test data, and (iii) stress calculation, using data from the first two tasks. For each task, quality control checks and data assessments are included. Detailed descriptions of each step are given in SKB MD 181.001 (SKB internal controlling document), and are briefly summarized below.

The recorded strain gauge response and temperature are plotted vs. recorded time, and the strain differences due to overcoring and stress relief are calculated for each strain gauge for later use as input to the stress calculation. The overcoring strain change is normally determined as the difference between (i) recorded strain after completed overcoring with flushing on, and (ii) recorded strain at the start of overcoring with flushing on. It is important that all conditions, except the overcoring stress relief itself, are as similar as possible for these two instances (e.g. flushing, water pressures, temperatures, etc). Furthermore, the strain values should be stable (little or negligible strain drift) at these instances. In some cases, stable and ideal strain response can be observed during the first portion (typically 20–30 cm) of the overcoring process, whereas significant strain drifts occurs during the rest of the overcoring. In theory, practically all of the strain relief takes place during the first 24 cm of overcoring (with gauge positions at 16 cm), see e.g. /Hakala et al. 2003/. For such cases, strain differences may be determined from stable values of this portion of the strain response curve (corresponding to approximately 20–30 cm drill bit position or more). It should also be noted that small changes in strains (a few μ strains), which may arise from choosing slightly different start- and stop-times for the overcoring, have very small influence on the calculated magnitudes and orientations of the in situ stress state.

Recorded strain and pressure data from biaxial testing are plotted and examined. Elastic constants are determined from recorded strain and pressure data from the biaxial testing. For this, the theory for an infinitely long, thick-walled circular cylinder subjected to uniform external pressure is employed (see e.g. KTH, 1990). Since the *Borre* probe incorporates three pairs of circumferential and axial strain gauges, three pairs of elastic property-values are obtained from each biaxial test. The aim is to obtain rock parameters that apply to the relaxation experienced by the rock during overcoring. Therefore, the values of E (Young's modulus) and ν (Poisson's ratio) are taken to be secant values, calculated from strain data obtained during unloading of the core specimen. Usually, the secant values between the pressures of 8 and 3 MPa are calculated and averaged for the three strain rosettes. However, elastic constants may be calculated for other pressure intervals, if recorded strain readings are significantly unstable and/or display notable non-linearity for certain pressures.

Calculation of stresses from measured strains is based on the classical theory by /Leeman 1968/. The details of the formulation can also be found in e.g. /Amadei and Stephansson 1997/ and are not repeated here. Strain measurements from at least six independent directions are required to determine the stress tensor (which has six components). When all nine gauges of the *Borre* probe function properly during a measurement, redundant strain data are obtained. A least square regression procedure is used to find the solution best fitting all the strain data, from which the stress tensor components are calculated. For each test, one tangential or inclined gauge and/or two axial gauges may be rejected or recalculated without impairing the determination of the stress tensor. Recalculation is only performed if evidence of malfunctioning gauges exists, see also /Sjöberg and Klasson 2003/ and SKB MD 181.001 (SKB internal controlling document). Subsequently, the magnitude and orientation vector of each of the three principal stresses are calculated, as well as the stresses acting in the horizontal and vertical planes.

For the case of several measurements on one test level, the average stress state is calculated. This is conducted by first taking the stress tensor components for each of the measurements (defined in a common coordinate system, e.g. the site coordinate system), and averaging each of the stress tensor components. From these average values, the average principal stresses, as well as the average horizontal and vertical stresses, are determined.

4.5.2 Transient strain analysis

A methodology for transient strain analysis of overcoring data was presented by /Hakala et al. 2003/. The methodology involves calculating the theoretical strains corresponding to a given stress field (by using pre-calculations from a three-dimensional numerical model). The theoretical strain response is calculated for the entire overcoring process and can thus subsequently be compared to the actual recorded strain response from the overcoring measurement.

The analysis can be used to assess whether the measured strain differences and calculated stresses are compatible. Larger deviations in terms of measured vs. calculated (theoretical) strains are indications of imperfect conditions at the time of measurements, e.g. debonding, microcracking, heterogeneities, anisotropy, etc. The analysis cannot, however, be used to detect systematic measurement errors.

Transient strain analysis was carried out using the computer code and methodology developed by /Hakala et al. 2003/. For each test (measurement point), the reported stress state and accompanying field parameters were input to the transient strain analysis program. Transient and final strains were calculated and the final strains compared with the measured final strains. The strain differences (measured vs. calculated strains) were evaluated and the maximum difference calculated for each strain gauge as follows:

$$M_diff_i = \frac{|\epsilon_i - \epsilon_calc_i|}{\epsilon_amp_i},$$

$$\epsilon_amp_i = \epsilon_{i,max} - \epsilon_{i,min},$$

where

M_diff_i = maximum strain difference for one of the strain gauges ($i=1, 2, \dots, 9$) (%),

ϵ_i = measured strain for one of strain gauges ($i=1, 2, \dots, 9$),

ϵ_calc_i = back-calculated strain from the calculated stress state for one of the strain gauges ($i=1, 2, \dots, 9$),

ϵ_amp_i = amplitude for the calculated transient strain curve for one of strain gauges ($i=1, 2, \dots, 9$),

$\epsilon_{i,max}$ = maximum recorded strain value for one of strain gauges ($i=1, 2, \dots, 9$),

$\epsilon_{i,min}$ = minimum recorded strain value for one of strain gauges ($i=1, 2, \dots, 9$).

In addition, the amount of unexplained strain was calculated using the program. Initially, the strain differences from the measurement are used to calculate stresses, using the least-square regression procedure described in Section 4.4.1. The resulting stresses were then used to back-calculate the corresponding strains for each of the strain gauges of the probe. The amount of unexplained strain was defined as the sum of absolute differences between measured and calculated strains divided by sum of calculated strains, i.e. /Hakala et al. 2003/

$$AUS = \frac{\sum_{i=1}^9 |\epsilon_i - \epsilon_calc_i|}{\sum_{i=1}^9 \epsilon_calc_i},$$

where

AUS = amount of unexplained strain (%),

ϵ_i = measured strain for each of the strain gauges ($i=1, 2, \dots, 9$), and

ϵ_calc_i = back-calculated strain from the calculated stress state for each of the strain gauges ($i=1, 2, \dots, 9$).

A higher value on AUS indicates larger difference between measured and theoretical strain values. This value can thus be used to estimate the heterogeneity, anisotropy, reliability, or successfulness of measurements.

The stress path developing during the overcoring process was also calculated, including the maximum tensile stress acting on the overcore sample. A high value on the tensile stress is an indicator of high possibility of tensile damage of the rock during overcoring. At this stage, strength values are not known for this site. For illustrative purposes, a uniaxial compressive strength of 200 MPa and a uniaxial tensile strength of 20 MPa were assumed to define a failure criterion. It should be noted that only linear-elastic analysis is conducted; hence, very high tensile stresses can develop, which, in reality, would be limited as the strength of the rock is exceeded. The post-peak process and associated stresses and strains can, obviously, not be studied with this computer program.

Finally, the developed code has the capability to solve for the in situ state of stress based on the measured transient or final strains /Hakala et al. 2003/, following the method presented by /Fouial et al. 1998/. This inverse solution enables, in theory, stresses to be determined from the early, pre-overcoring, strain response. The inverse solution is exact if calculated strain values and coring advance are exact. In reality, there are always errors associated with the measurements. /Hakala et al. 2003/ stated that for the inverse solution to be useful, coring advance must be measured with an accuracy of ± 1 mm, or better. This is clearly difficult to achieve in practice. During overcoring measurements in borehole KLX04, overcoring was attempted at a constant rate for the different measurements. Manual registration of the coring advance was conducted for every 4th cm up to 32 cm overcoring length. However, the coring rate often proved to be varying due to practical constraints (variations in rock type, drill string extension, etc), thus resulting in varying error in the determination of coring advance. Consequently, in most cases, the local maxima and minima of the measured and theoretical strains, respectively, did not match perfectly. For such cases, the measured strain response curves were corrected to match the theoretical strains with respect to position/core advance, thus resulting in an improved inverse solution. The inverse solution was applied to selected measurements in KLX04, as described in the following.

5 Results

5.1 Overview

Measurements were planned to be conducted at three measurement levels in borehole KLX04. However, only two measurement levels could be said to be completed successfully. Level 1 included measurements between 233 and 245 m borehole length. For Level 2, measurements were attempted between 374 and 451 m borehole lengths. This large depth interval was required to obtain a complete test series due to problems associated with the presence of rock fragments (due to borehole instabilities) and drill cuttings in the borehole, thus inhibiting correct installation of the measurement probe. Extended periods of flushing as well as attempts at cleaning the hole mechanically helped improving borehole conditions periodically. However, after completed measurement at this level, SKB decided to terminate the measurement campaign.

A brief summary of conducted measurements is given in Table 5-1. All tests have been numbered as follows: *measurement level : test no. : pilot hole no.*. Thus, e.g. test 2:1:3 denotes measurement level 2, test (or measurement) no. 1 at that level, and pilot hole no. 3 (to reach an acceptable measurement location for this test). Each test is presented with a rating reflecting successfulness and reliability of that particular measurement. Ratings were assigned per the following criteria:

Rating	Description and criteria
a	Successful test <ul style="list-style-type: none">• Geometrical conditions achieved (strain gauges at correct position, etc).• Stable strain response prior to, and during, overcoring with minimal strain drift (strain change less than 10 μstrain per 15 min for undisturbed conditions).• No fractures and/or core discing observed in the overcore sample (at least 24 cm intact core).• Linear and isotropic (20–30% deviation acceptable) strain response during biaxial testing. Minor hysteresis (< 100 μstrain) accepted.• Stress calculation possible with classical analysis (Section 4.4.1). Values on elastic constants may be assumed from nearby tests if biaxial test data are lacking, and all other criteria above are satisfied.
b	Partly successful test <ul style="list-style-type: none">• Signs of debonding but fairly stable strain response up until peak value (typically at 24–30 cm drill bit position).• Stress calculation possible with classical analysis (Section 4.4.1) but results judged uncertain and/or less reliable.• Additional stress determination may be conducted using inverse solution of transient strain analysis (Section 4.4.2).
c	Failed test <ul style="list-style-type: none">• Installation failed or incomplete.• Debonding of strain gauges and/or large strain drift.• Fractures/joints detected in overcore sample.

Table 5-1. General test data from measurements in borehole KLX04, Oskarshamn.

Test no. (pilot hole no.*)	Hole length [m]	Vertical depth [m]**)	Overcoring	Biaxial testing	Transient strain analysis	Rating	Comments
1:1:3	232.96	231.77	No	No	No	c	Installation failed, probably due to borehole cuttings and/or debris in the borehole. Strain gauges were debonded from the borehole wall.
1:2:3	235.91	234.71	Yes	Yes	Yes	b	Installation partly failed. One strain gauge rosette deformed and debonded, probably due to remnants of drill cuttings in the pilot hole.
1:3:2	242.38	241.14	Yes	Yes	Yes	b	Partly successful installation of the probe. Strain gauges were not at the exactly correct position in the pilot hole (approximately 4 cm higher up).
1:4:2	244.25	243.01	No	No	No	c	Installation failed, probably due to borehole cuttings and/or debris in the borehole. Strain gauges debonded from borehole wall.
1:5:1	245.44	244.19	Yes	Yes	Yes	a	Installation was successful with good bonding of the strain gauges. Due to drilling equipment problems, the overcored sample was of smaller diameter for the first 10 cm length.
2:1:3	374.68	372.84	Yes	Yes	Yes	a	Successful test.
2:2:1	376.86	375.01	Yes	Yes	Yes	a	Fairly stable strain response. Fair biaxial test.
2:3:1	378.06	376.20	No	No	No	c	Installation failed as the probe did not enter the pilot hole completely. This is most likely due to debris (rock fragments) hindering the probe at the hole collar.
2:4:1	379.10	377.24	No	No	No	c	Installation failed as the probe did not enter the pilot hole, and the adapter had not released the probe. Large amount of sand particles were found in the adapter and compass, indicating debris (rock fragments and drill cuttings) in the borehole.

*) Numbering scheme: (measurement level : test no. : *pilot hole no.*).

***) Vertical depth (below ground surface) interpolated from borehole orientation measurements (every three metre).

Table 5-2. (concluded).

Test no. (pilot hole no*)	Hole length [m]	Vertical depth [m]**)	Overcoring	Biaxial testing	Transient strain analysis	Rating	Comments
2:5:2	386.77	384.87	No	No	No	c	Unsuccessful test. Installation not completely successful; debonding of gauges caused by debris, sand, and borehole cuttings present in the pilot hole.
2:6:1	388.30	386.40	No	No	No	c	Unsuccessful test as the probe did not enter the pilot hole correctly and gauges exhibited poor bonding.
2:7:5	393.81	391.88	No	No	No	c	Installation failed as the probe did not enter the pilot hole, and the adapter had not released the probe, due to the presence of rock fragments in the borehole.
2:8:1	439.51	437.38	Yes	Yes	Yes	a	Stable strain response. Good biaxial test.
2:9:1	440.57	438.44	No	No	No	c	Installation failed as the probe did not enter the pilot hole completely. The adapter had not released the probe completely, probably due to the presence of rock fragments in the borehole.
2:10:2	445.98	443.83	No	No	No	c	Installation was unsuccessful, probably due to rock fragments being jammed between the probe and the borehole wall.
2:11:1	447.44	445.29	Yes	Yes	Yes	a	Fair strain response for two rosettes; debonding of one rosette. Fair biaxial test.
2:12:1	448.49	446.33	No	No	No	c	Unsuccessful test due to incomplete installation. Probe was not in the correct position and several rock fragments of 5–10 mm size were found near the pilot hole collar.
2:13:1	449.56	447.39	Yes	Yes	Yes	a	Relatively stable strain response. Good biaxial test.
2:14:1	450.66	448.49	Yes	Yes	Yes	a	Stable strain response. Fair biaxial test.

*) Numbering scheme: (*measurement level : test no. : pilot hole no.*).

***) Vertical depth (below ground surface) interpolated from borehole orientation measurements (every three metre).

Borehole orientations for the measurement depths in question are shown in Table 5-3, as measured after completed drilling of the hole. These orientation data were used in the stress calculations described below, together with the recorded orientations of the installed *Borre* probe.

Table 5-3. Borehole orientation for overcoring measurement points in borehole KLX04. Orientations taken from nearest (3 metre) measured section.

Level no.	Test no. (pilot hole no.*)	Hole length [m]	Borehole bearing [°]**)	Borehole dip [°]***)
1	1:1:3	232.96	10.16	84.18
1	1:2:3	235.91	10.45	84.20
1	1:3:2	242.38	11.13	84.22
1	1:4:2	244.25	11.31	84.22
1	1:5:1	245.44	11.45	84.23
2	2:1:3	374.68	23.19	84.53
2	2:2:1	376.86	23.29	84.52
2	2:3:1	378.06	23.35	84.51
2	2:4:1	379.10	23.51	84.51
2	2:5:2	386.77	24.21	84.57
2	2:6:1	388.30	24.47	84.57
2	2:7:5	393.81	25.01	84.59
2	2:8:1	439.51	27.98	84.72
2	2:9:1	440.57	27.99	84.73
2	2:10:2	445.98	28.29	84.71
2	2:11:1	447.44	28.38	84.71
2	2:12:1	448.49	28.48	84.71
2	2:13:1	449.56	28.59	84.72
2	2:14:1	450.66	28.67	84.72

*) Numbering scheme: (*measurement level : test no. : pilot hole no.*).

***) Clockwise from geographic north.

***) Positive downward from the horizontal.

5.2 Overcoring test data

Results from all tests with rating *a* and *b* in Table 5-1 are presented in the following and in Appendices A through G. Key measurement data (recorded times for borehole activities) are presented in Appendix A. Furthermore, core logs and photos are presented in Appendices F and G. The core logs (conducted during the field campaign) were complemented afterwards using the overview lithological mapping conducted by the site geologist, in order to be consistent with the geological terminology at the site.

The strain response for each test is shown in Appendix B. Each test is presented with two plots showing (i) the complete strain record (from activation of probe to core recovery), and (ii) the strain response from overcoring start to overcoring stop. The latter was used to define strain differences for later input to stress calculation. The times for which the strain differences have been determined (“OC Start” and “OC Stop”) are shown in the figures, as well as in Appendix A.

In the following, a short description is presented for each of the measurement attempts at the two levels. All original data are stored in the SKB database SICADA, field note no. Simpevarp 232.

5.2.1 Measurement level 1

A total of five installations were attempted at the first measurement level in borehole KLX04. Out of these, one successful tests (1:5:1) and two partially successful tests (1:2:3 and 1:3:2) were obtained. Installation failed for the two other tests, probably due to presence of borehole cuttings and/or debris in the borehole leading to debonding of strain gauges.

Debonding also occurred in test no. 1:2:3, but constrained to one strain gauge rosette (rosette no. 1, which only responded when overcoring was completed). However, this makes stress determination using classical analysis impossible (only five independent strain gauge directions left). The other two rosettes showed good bonding and stable strain response; hence, this test could be further evaluated using transient strain analysis (cf. Section 5.5 below).

During overcoring of test no. 1:3:2, the overcoring drilling rate was higher than normally used, due to a misunderstanding by the drilling crew. The drilling rate also varied somewhat during the overcoring process. In addition, strain gauges had not bonded at the exactly correct position in the pilot hole, but approximately 4 cm higher up. The strain response was very stable during overcoring of this test but secondary stresses (due to the gauges being closer to the borehole bottom) may affect the results.

For test no. 1:5:1, the strain response was stable prior to, and during, overcoring, with the exception of a malfunctioning gauge (no. 1). However, the overcored sample proved to be of smaller diameter for the first 10 cm. This was probably caused by the inner tube of the pilot hole equipment not being securely fixed (due to wear). The strain gauge positions were not affected, nor the strain readings during overcoring (outer core diameter has no effect on magnitude of strain relief at the pilot hole wall). Temperature increase during overcoring was moderate for all tests at this level, ranging between 1.5 and 3°C. However, a clear temperature effect was noted for test no. 1:2:3, with elevated strains during overcoring.

5.2.2 Measurement level 2

In total, 14 measurements were attempted at this level, with 6 measurements judged experimentally successful (test nos. 2:1:3, 2:2:1, 2:8:1, 2:11:1, 2:13:1, and 2:14:1). The majority of the unsuccessful tests failed due to the presence of rock fragments and/or drill cuttings in the borehole, inhibiting correct installation of the probe. In some cases, installation was correct but gauges poorly bonded to the borehole wall, thus resulting in unrealistic strain response. These tests were also discarded.

The overcoring strain response was stable to very stable for most of the successful tests. However, signs of debonding of one strain gauge rosette were evident for test no. 2:11:1. Borehole temperatures were slightly higher at this Level – approximately 13°C initial temperature, but the recorded temperature increase during overcoring was moderate for all tests (between 2 and 3°C). Nevertheless, several tests displayed an increased strain response during overcoring, with strains slowly decaying to stable values after completed drilling and during flushing. This phenomenon (but much more pronounced) was also observed during overcoring measurements in borehole KAV04 /Sjöberg 2004/. The strain increase and decay is interpreted as a temperature effect; hence, final strains should be determined at the end of the flushing period to compensate for this. Consequently, strain differences were determined from either (i) completed overcoring (test nos. 2:1:3 and 2:11:1), or (ii) the end of the flushing period (test nos. 2:2:1, 2:8:1, 2:13:1, and 2:14:1), depending on which of these instances produced the most stable strain values for a particular test.

Depth correlations were slightly more uncertain at this Level, as the exact position of the drill bit is more difficult to determine (for the drilling contractor) at larger depths. Test nos. 2:1:3 and 2:13:1 were mostly affected by this and corrections were applied to these tests afterwards based on transient strain analysis (only absolute positions affected; relative positioning data were correct).

5.3 Biaxial test data

All suitable overcore rock samples were tested in the biaxial cell to determine the elastic properties. For Level 1, three successful tests were conducted, although rosette no. 1 had to be excluded (due to malfunctioning gauges) in both test nos. 1:2:3 and 1:5:1. The strain response for the remaining strain gauge rosettes displayed good linearity and isotropic

behaviour. Some hysteresis was observed in test 1:2:3, but the resulting values on the elastic constants were realistic for all tests. For test 1:5:1, the smaller diameter of the upper portion of the overcore sample (caused by drilling equipment problems) may have impacted the biaxial test results. Although the “thick” portion of the sample (which included the strain gauges) was tested, the fact that the strain gauges are not centered in the biaxial cell may lead to slightly lower strains being recorded (boundary effect). The biaxial test response was, however, very good with linear and isotropic response and yielding a very realistic value on Young’s modulus. Hence, this test was included in the evaluation below.

Biaxial tests on overcored samples from Level 2 showed, in general, good strain response. Very good linearity and isotropic behaviour was found for test nos. 2:1:3, 2:8:1, and 2:14:1. For test 2:14:1, strain rosette no. 3 had to be excluded due to signs of debonding. Also, bonding was not optimal for test 2:8:1, despite the good strain response. The strain gauges were very easily removed after completed testing and significant amounts of drill cuttings were found in the glue. For the other tests, some hysteresis and non-linearity was observed for test nos. 2:2:1 and 2:13:1, whereas test 2:11:1 also displayed signs of anisotropic behaviour. The latter may be due to debonding of some of the strain gauges, as was indicated from the overcoring strain response. The resulting value on Poisson’s ratio was suspiciously high for this test, which also may be due to core damage. Nevertheless, this test was also included in the evaluation, as the property values probably reflect actual conditions during overcoring.

The results from the successful biaxial tests are presented in Table 5-4. The gauge response-curves from these tests are shown in Appendix C. All original data are stored in the SKB database SICADA.

5.4 In situ stress state

The in situ stress state was calculated using (i) the measured strain response (difference between strain gauge readings after and prior to overcoring), (ii) recorded orientation of strain gauge rosettes in the borehole, and (iii) values on elastic constants determined from biaxial testing. Strain differences were determined from stable strain values before overcoring vs. stable values after completed overcoring. For tests with very stable post-overcoring response, the final strain values were taken at the end of the flushing period (just before core break) to minimize the possible influence on temperature on the strain readings (cf. Appendices A and B in which the times for which strain differences were calculated are marked “OC Start” and “OC Stop”, respectively).

Table 5-4. Results from biaxial testing on overcore samples from borehole KLX04.

Level no.	Measurement no. (pilot hole no.)*	Hole length [m]	Young’s modulus, E [GPa]	Poisson’s ratio, ν
1	1:2:3	235.91	72.1	0.30
1	1:3:2	242.38	57.0	0.30
1	1:5:1	245.44	63.1	0.30
2	2:1:3	374.68	70.0	0.27
2	2:2:1	376.86	78.8	0.29
2	2:8:1	439.51	59.2	0.22
2	2:11:1	447.44	56.2	0.43
2	2:13:1	449.56	46.3	0.31
2	2:14:1	450.66	47.8	0.18

*) Numbering scheme: (measurement level : test no. : pilot hole no.).

Average stresses were calculated from all successful (rating *a*) measurements. For test no. 1:3:2, secondary stresses (due to the gauges being closer to the borehole bottom) may affect the results; hence, this test was not judged reliable and was excluded from average for Level 1.

For test no. 2:11:1 at Level 2, the choice of strain differences is not without ambiguity. It may be argued that, due to possible debonding, final strain values should be determined for an earlier instant (before the notable strain drop, cf. Figure B14). However, these values are relatively unstable with the resulting stresses being very insensitive to which particular instant is chosen. Also, the resulting stresses are clearly unrealistic (vertical stresses above 50 MPa). Consequently, final strain values corresponding to completed overcoring were used.

Since measurements at Level 2 were taken at varying depth and in apparently varying geology, they cannot, without consideration, be included in the averaging process for Level 2. Both stress orientations and stress magnitudes vary significantly from test to test thus making it difficult to justify any averaging of all tests. This is true even for tests that are located close to each other, e.g. test nos. 2:1:3 and 2:2:1. Also, the large difference in measurement depth from the first tests (374–377 m) compared to the last three tests (447–450 m) precludes realistic averaging. However, by averaging the last three successful measurements (2:11:1, 2:13:1, 2:14:1), a fairly consistent stress state is obtained, which is that presented below. This issue is discussed further in Sections 5.5 and 5.6, with alternative interpretations offered.

The resulting stresses for each test, as well as the averages for each Level are shown in Appendix D, and in Table 5-5, Table 5-6, and Table 5-7. All orientations are given relative to geographic north. Orientations of the principal stresses are also shown in Figure 5-1 and Figure 5-2, for Levels 1 and 2, respectively. All original data are stored in the SKB database SICADA.

Table 5-5. Magnitudes of principal stress as determined by overcoring in borehole KLX04.

Level no.	Measurement no. (pilot hole no.*)	Hole length [m]	σ_1 [MPa]	σ_2 [MPa]	σ_3 [MPa]
1	1:3:2**)	242.38	4.6	3.8	1.9
1	1:5:1	245.44	4.1	2.4	0.3
1	Average	–	4.1	2.4	0.3
2	2:1:3***)	374.68	26.2	4.2	–1.5
2	2:2:1***)	376.86	38.2	10.8	6.4
2	2:8:1***)	439.51	13.6	10.2	2.2
2	2:11:1	447.44	37.0	18.3	4.9
2	2:13:1	449.56	28.2	10.1	4.5
2	2:14:1	450.66	36.1	19.7	4.8
2	Average	–	27.4	21.6	5.5

*) Numbering scheme: (*measurement level : test no. : pilot hole no.*).

***) Not included in calculation of average stress for Level 1.

****) Not included in calculation of average stress for Level 2.

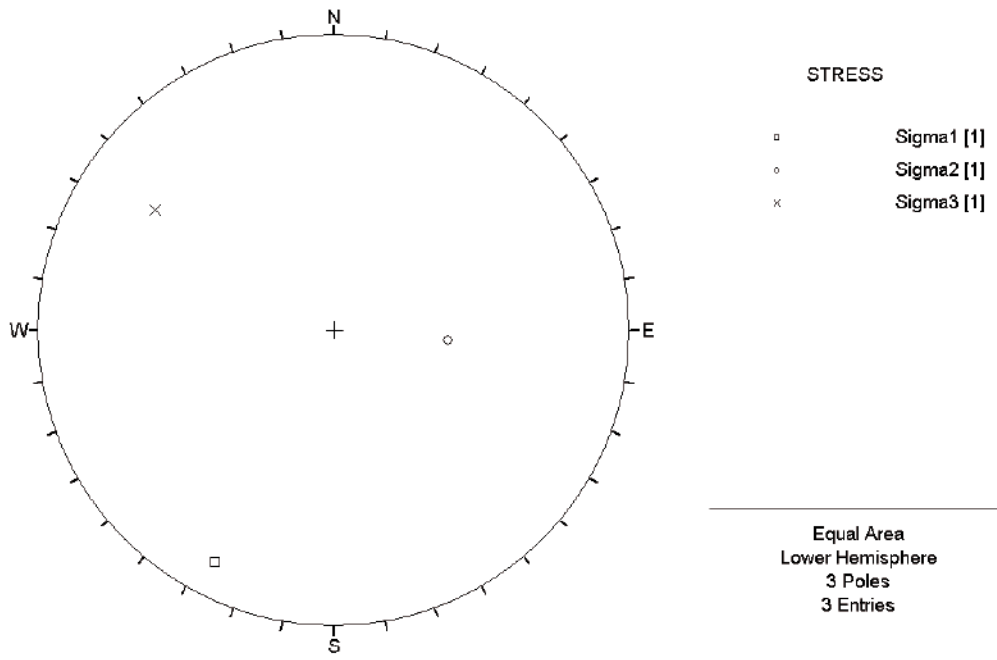

Figure 5-1. Orientations of measured principal stresses in borehole KLX04, Level 1, shown in a lower hemisphere projection (only one successful measurement; 1:5:1).

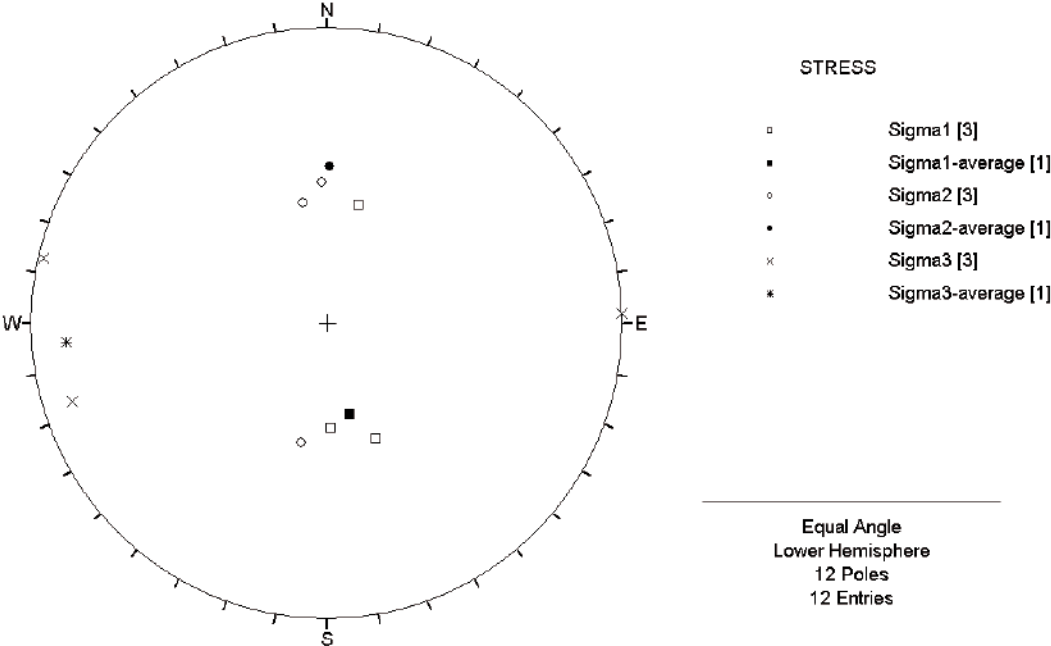

Figure 5-2. Orientations of measured principal stresses in borehole KLX04, Level 2, shown in a lower hemisphere projection (test nos. 2:11:1, 2:13:1, and 2:14:1).

Table 5-6. Orientations of principal stress as determined by overcoring in borehole KLX04.

Level no.	Measurement no. (pilot hole no. *)	Hole length [m]	σ_1 Trend/Plunge [°]	σ_2 Trend/Plunge [°]	σ_3 Trend/Plunge [°]
1	1:3:2**)	242.38	333/25	132/64	239/08
1	1:5:1	245.44	207/13	095/58	304/28
1	Average	–	207/13	095/58	304/28
2	2:1:3***)	374.68	160/42	272/22	021/40
2	2:2:1***)	376.86	225/48	001/32	107/23
2	2:8:1***)	439.51	323/38	079/29	195/38
2	2:11:1	447.44	157/44	349/45	253/06
2	2:13:1	449.56	015/45	192/45	283/01
2	2:14:1	450.66	178/51	358/39	088/00
2	Average	–	166/55	001/34	266/07

*) Numbering scheme: (measurement level : test no. : pilot hole no.).

**) Not included in calculation of average stress for Level 1.

***) Not included in calculation of average stress for Level 2.

Table 5-7. Horizontal and vertical stress components calculated from measured principal stresses in borehole KLX04.

Level no.	Measurement no. (pilot hole no. *)	Hole length [m]	σ_h [MPa]	σ_h [MPa]	σ_v [MPa]	Trend σ_h [°]
1	1:3:2 **)	242.38	4.5	2.0	3.9	150
1	1:5:1	245.44	4.0	0.8	2.0	030
1	Average	–	4.0	0.8	2.0	030
2	2:1:3***)	374.68	14.6	2.5	11.9	152
2	2:2:1***)	376.86	22.2	7.8	25.4	039
2	2:8:1***)	439.51	11.7	5.9	8.4	116
2	2:11:1	447.44	27.8	5.0	27.3	160
2	2:13:1	449.56	19.2	4.5	19.1	014
2	2:14:1	450.66	26.3	4.8	29.5	178
2	Average	–	23.4	5.8	25.3	175

*) Numbering scheme: (measurement level : test no. : pilot hole no.)

**) Not included in calculation of average stress for Level 1.

***) Not included in calculation of average stress for Level 2.

5.5 Transient strain analysis

5.5.1 Transient strain response

Transient strain analysis was conducted for all tests with rating *a* and *b* from Levels 1 and 2 (see Table 5-1). The resulting calculated strain differences (compared to measured strains), amount of unexplained strain, and maximum tensile stress are shown in Appendix E.

For Level 1, the agreement between measured and theoretical strains is poor, in particular for test no. 1:5:1. This can partly be attributed to the low strains recorded during overcoring of these tests (maximum of 150–200 μ strain for test nos. 1:3:2 and 1:5:1). The amount of unexplained strain for final strain values is also large for these tests. The calculated value on the maximum tensile stress, on the other hand, is low for all tests at Level 1 (< 7 MPa), indicating a low potential for core damage/microcracking.

For Level 2, the calculated transient strain response is, in general, in poor agreement with the measured strain response. This is partly due to the way strain differences (for stress calculation) were determined for Level 2, with final strains taken at the end of the flushing period to minimize temperature effects. Hence, these strains are not included in the transient strain analysis, which only covers the elastic strain response due to stress relief. The high values on the unexplained strain for test nos. 2:11:1 and 2:13:1 are not representative of the calculated stress state for these tests. It is, however, interesting to note that test no. 2:8:1 give low values on the amount of unexplained strain, together with test no. 2:1:3.

The maximum elastic tensile stress that can develop during overcoring is very high for test nos. 2:1:3, 2:2:1, 2:11:1, 2:13:1 and 2:14:1 (around 20 MPa or more). These values are most likely high enough to cause damage and/or microcracking in the overcore samples. The axial strain response, which is most susceptible to core damage in a sub-vertical borehole, is also generally in poor agreement with the theoretical strain response. The calculated vertical stress component (cf. Table 5-7) is clearly exaggerated (compared to the overburden pressure) for test nos. 2:2:1, 2:11:1, 2:13:1, and 2:14:1. Taken together, these are strong indicators that the overcore samples have been subjected to core damage during overcoring for nearly all tests at Level 2, with the exception of test no. 2:8:1 and, possibly, 2:1:3.

5.5.2 Inverse solution stress estimate

The inverse solution was used to complement the stress determination from classical analysis. For test no. 1:2:3, classical analysis was not possible since one strain gauge rosette malfunctioned. Using the inverse solution, this could be overcome, and stresses were calculated for the final strain values (end of overcoring; stable strains and temperatures) and excluding rosette no. 1. Water pressure was not included in the analysis. The results are presented in Table 5-8 through Table 5-10.

Table 5-8. Magnitudes of principal stress as determined from transient strain analysis (inverse solution). Results from classical analysis shown for comparison.

Measurement no. (pilot hole no. *)	Coring advance [mm]	σ_1 [MPa]	σ_2 [MPa]	σ_3 [MPa]
1:2:3 (inverse)	+60	8.2	3.6	2.4
2:1:3 (inverse)	-60	39.3	21.2	-5.6
2:1:3 (classical)		26.2	4.2	-1.5
2:2:1 (inverse)	-13	30.8	18.7	-1.9
	-10	32.8	17.1	-1.6
	-7	35.9	16.7	-1.8
2:2:1 (classical)		38.2	10.8	6.4
2:8:1 (inverse)	-11	4.6	2.9	1.0
	-7	12.7	2.1	1.6
2:8:1 (classical)		13.6	10.2	2.2

*) Numbering scheme: (measurement level : test no. : pilot hole no.).

Table 5-9. Orientations of principal stress as determined from transient strain analysis (inverse solution). Results from classical analysis shown for comparison.

Measurement no. (pilot hole no. *)	Coring advance [mm]	σ_1 Trend/Plunge [°]	σ_2 Trend/Plunge [°]	σ_3 Trend/Plunge [°]
1:2:3 (inverse)	+160	078/14	245/76	348/03
2:1:3 (inverse)	-60	187/25	096/002	001/64
2:1:3 (classical)		160/42	272/22	021/40
2:2:1 (inverse)	-13	303/35	202/16	091/51
	-10	317/22	212/34	074/48
	-7	303/17	205/26	063/59
2:2:1 (classical)		225/48	001/32	107/23
2:8:1 (inverse)	-11	267/17	109/71	359/07
	-7	256/06	161/39	353/51
2:8:1 (classical)		323/38	079/29	195/38

*) Numbering scheme: (measurement level : test no. : pilot hole no.).

Table 5-10. Horizontal and vertical stress components as determined from transient strain analysis (inverse solution). Results from classical analysis shown for comparison.

Measurement no. (pilot hole no. *)	Coring advance [mm]	σ_H [MPa]	σ_h [MPa]	σ_v [MPa]	Trend σ_H [°]
1:2:3 (inverse)		7.9	2.4	3.8	078
2:1:3 (inverse)	-60	31.0	21.1	2.8	010
2:1:3 (classical)		14.6	2.5	11.9	152
2:2:1 (inverse)	-13	23.0	14.3	10.3	153
	-10	29.4	9.8	9.0	147
	-7	33.3	12.7	4.8	129
2:2:1 (classical)		22.2	7.8	25.4	039
2:8:1 (inverse)	-11	4.5	1.0	3.0	088
	-7	12.6	1.9	1.9	076
2:8:1 (classical)		11.7	5.9	8.4	116

*) Numbering scheme: (measurement level : test no. : pilot hole no.).

For the other tests, the inverse solution was attempted using the early (transient) strain response from overcoring. Generally, the stresses calculated with the inverse solution vary significantly with coring advance. To obtain a reliable stress estimate, the calculated stresses must be relatively constant over some distance during the early overcoring phase. This requires that the overcoring response during the first few minutes (before passing the strain gauges at 16 cm position) is stable and that the coring advance is accurate. Unfortunately, these two conditions are seldom satisfied simultaneously.

In this particular case, the scatter in the data and the low strain magnitudes precluded any stress determinations for Level 1 (except test 1:2:3 described above).

For Level 2, the transient stresses varied dramatically with coring advance, making it very difficult to find any consistent values. In addition, determined stresses were often unrealistic (negative or extremely high). This is very evident for test nos. 2:11:1, 2:13:1, and 2:14:1. A typical example is shown in Figure 5-3. Since the stress state could not be determined unambiguously for these tests, they were not included in the Tables below.

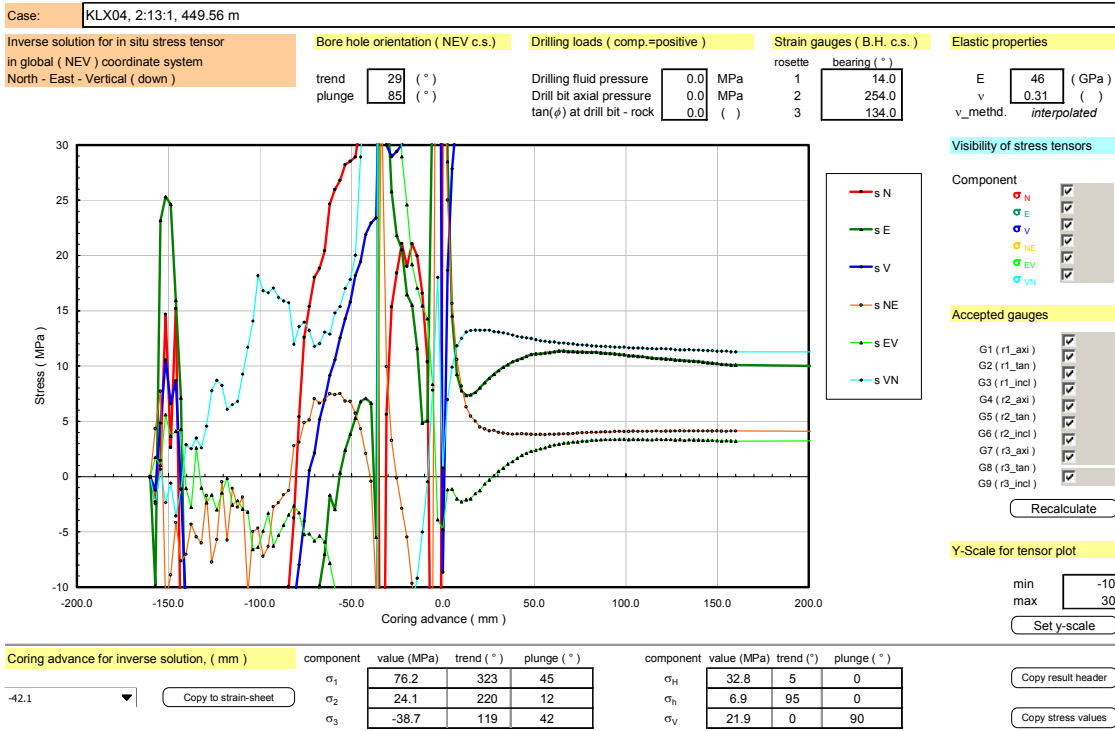

Figure 5-3. Inverse stress solution for test no. 2:13:1 (no stable pre-overcoring values found).

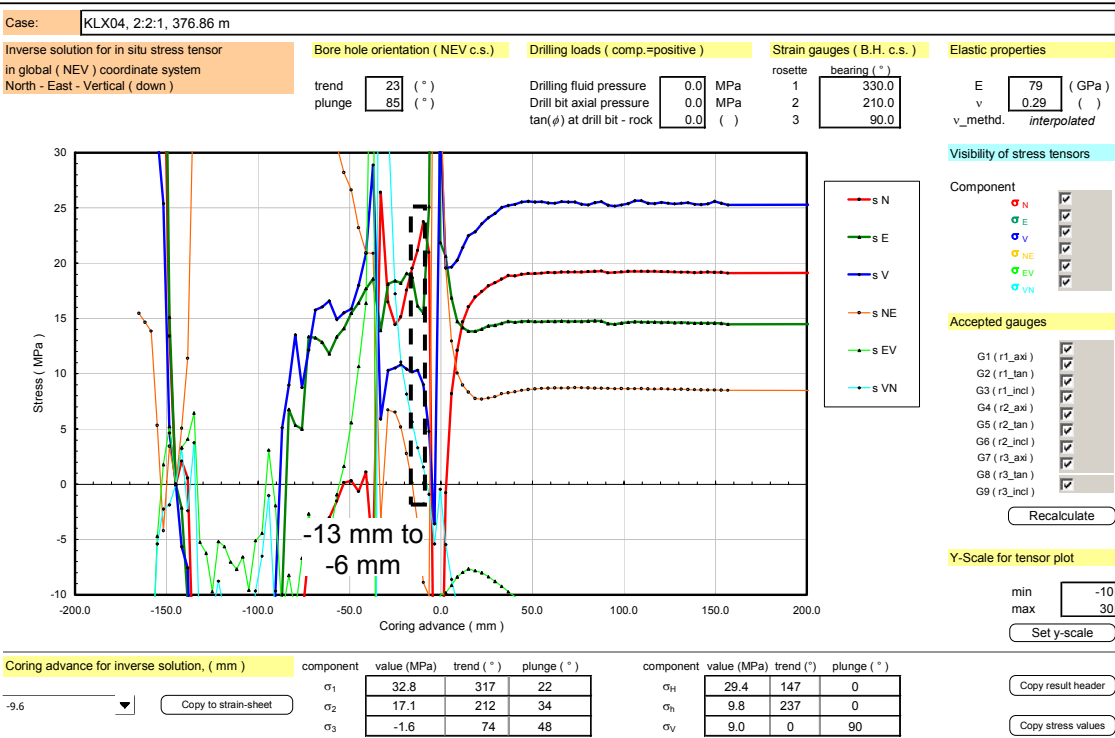

Figure 5-4. Inverse stress solution for test no. 2:2:1 (semi-stable pre-overcoring values found).

For test nos. 2:1:3, 2:2:1 and 2:8:1, some preliminary stress estimates could be obtained but only for short intervals of coring advance. For test no. 2:1:3, coring advances around –60 to –50 mm produced relatively stable stresses; however, large tensile values were found for the minor principal stress. For test no. 2:2:1, fairly consistent and realistic values were found for coring advances of between –13 to –6 mm, whereas for test no. 2:8:1, coring advances between –11 and –7 mm were used in the stress determination. The resulting stresses are presented in Table 5-8 through Table 5-10. The obtained stress state from classical analysis is shown for comparison for each test. Note that for the inverse solution, stresses are calculated for each sampled strain value (every 5 s, corresponding to between 1 and 3 mm of coring advance) – hence, the values in the Tables below are only excerpts of the complete results.

Comparing these values with those of the classical analysis, it is found that the inverse solution from early overcoring strains indicates, in general, a lower vertical stress component. This is in line with the high probability of tensile failure in the axial (vertical) direction of the overcore samples, thus resulting in overestimated vertical stresses.

The horizontal stress components in the inverse solution are not consistently larger or smaller than those of the classical analysis. Rather, a significant variation is found for individual tests, as well as when comparing different tests. The stress orientations from the inverse solution are more consistent (for different coring advances) but drastically different than those from classical analysis.

In summary, the variation between the results for the presented coring advances in the pre-overcoring phase is significant – thus, stresses cannot be said to be unequivocally determined through this analysis. The large variation also makes averaging futile, and possibly misleading. With the exception of test no. 1:2:3, none of the inverse solution results are considered confident enough to be used in place those from the classical analysis. The inverse solutions confirm, however, that the vertical stress is probably overestimated for measurements at Level 2.

5.6 Summary results and discussion

Based on the results and findings presented above, a revised stress determination was obtained by including test no. 1:2:3 into the average for Level 1. For Level 2, however, no additional tests were included in the stress averaging. A summary of the obtained stress state in borehole KLX04 is presented in Table 5-11 and Table 5-12. Also, confidence intervals were calculated for the measurements results using the methodology proposed by /Walker et al. 1990/ and a newly developed computer code described in /Perman et al. 2005/. Confidence intervals were determined for both the magnitudes and the orientations of the principal stresses at each measurement level, as well as for the horizontal and vertical stress components. In this report, only the 90%-confidence intervals are presented (Appendix H).

Table 5-11. Magnitudes and orientations of principal stresses as determined from overcoring and transient strain analysis (marked * and in italic) in borehole KLX04.

Test no.	Hole length [m]	Magnitude and Trend/Plunge of principal stresses					
		σ_1		σ_2		σ_3	
		[MPa]	[°]	[MPa]	[°]	[MPa]	[°]
1:2:3*)	235.91	8.2	<i>078/14</i>	3.6	<i>245/76</i>	2.4	<i>348/03</i>
1:5:1	245.44	4.1	207/13	2.4	095/58	0.3	304/28
Average Level 1		5.4	065/13	3.2	174/54	1.8	327/33
2:11:1	447.44	37.0	157/44	18.3	349/45	4.9	253/06
2:13:1	449.56	28.2	015/45	10.1	192/45	4.5	283/01
2:14:1	450.66	36.1	178/51	19.7	358/39	4.8	088/00
Average Level 2		27.4	166/55	21.6	001/34	5.5	266/07

*) Data from transient strain analysis (inverse solution).

Table 5-12. Horizontal and vertical stress components calculated from principal stresses from overcoring and transient strain analysis (marked * and in italic) in borehole KLX04.

Test no.	Hole length [m]	σ_H [MPa]	σ_h [MPa]	σ_v [MPa]	Trend σ_H [°]
1:2:3*)	235.91	7.9	2.4	3.8	078
1:5:1	245.44	4.0	0.8	2.0	030
Average Level 1		5.3	2.2	2.9	063
2:11:1	447.44	27.8	5.0	27.3	160
2:13:1	449.56	19.2	4.5	19.1	014
2:14:1	450.66	26.3	4.8	29.5	178
Average Level 2		23.4	5.8	25.3	175

*) Data from transient strain analysis (inverse solution).

The stress state for Level 1 is characterised by low stresses, with the magnitudes being close to the achievable precision of the measurement method as such. The transient strain analysis indicated a low potential for core damage for these tests, as could be expected. The average major principal stress is subhorizontal and oriented ENE-WSW. The vertical stress component is, on average, 2.9 MPa, which is about half of the theoretical value corresponding to the overburden pressure. The fact that the stress components are relatively similar in magnitude makes it difficult to determine orientations of the principal stresses (as they may “switch place”). Consequently, variations between the individual measurements are quite large, with respect to both orientation and magnitude, as manifested by the calculated confidence intervals, which are large (Appendix H). A 90%-confidence interval for the principal stress orientations does not encompass all single measurements (cf. Figure H1).

For Level 2, significantly higher stresses are inferred from the measurements, with maximum stresses exceeding 30 MPa for some of the tests. Common for all conducted measurements at Level 2 is that the major principal stress is not sub-horizontal. Rather, a fairly consistent dip of around 45° was found from all tests. The trend of σ_1 varies more, but with an average orientation (for all tests) in the N-S direction.

The difficulties of calculating a representative average were briefly discussed earlier. The average presented here are for the last three successful measurements (2:11:1, 2:13:1, 2:14:1), indicating a major principal stress of 27 MPa magnitude, trending SSE and dipping 55°. The maximum horizontal and the vertical stress components are of similar magnitude (25 MPa), whereas the minimum horizontal stress is only around 5 MPa (essentially equal to σ_3). The vertical stress is clearly overestimated in all measurements, when compared with the overburden pressure at these depths. It should be noted that the scatter for these three tests is well within the typical variation found from overcoring measurements. In particular test nos. 2:11:1 and 2:14:1 show very consistent results (within ± 1 MPa in magnitude and $\pm 12^\circ$ in orientation). The calculated confidence intervals for all three tests are very large in terms of magnitude variation. However, the confidence intervals for the principal stress orientations are relatively well defined from these measurements (see Appendix H).

The inverse solution of transient strain analysis did not provide any additional reliable stress determinations. However, transient strain analysis pointed out the high potential of core damage and/or microcracking due to large tensile stresses developing during overcoring. This was evident for all tests at Level 2, with the notable exception of test no. 2:8:1. Consequently, the high vertical stresses may be an effect of large axial strains due to core damage thus leading to greatly exaggerated vertical stress components. The inverse solution confirmed this finding, although reliable estimates of the vertical stress could not be extracted.

Test no. 2:8:1 is an important exception as the measured vertical stress is only 8 MPa (which is less than the overburden pressure) and the potential for tensile damage low. The measured stresses are also more in line with those of Level 1, than the other measurements at Level 2, as

shown in Figure 5-5 (see also Table 5-5 through Table 5-7), despite their close proximity in vertical direction. Test nos. 2:1:3 and 2:2:1 showed, however, much higher stresses (more similar to the rest of Level 2). From an experimental standpoint, there were no significant differences between these groups of measurements, as all of them exhibited stable strain responses (cf. Table 5-1).

In conclusion, the stress state near borehole KLX04 is characterized by low stresses at Level 1 (approximately 250 m depth) and a ENE-WSW orientation of the major principal stress. The three deepest measurements at Level 2 (approximately 450 m depth) pointed at relatively high stresses, and a nearly N-S stress orientation. The consistency between different measurements was also relatively good for these three tests, thus indicating that they reflect the actual stress state near the borehole. However, the vertical stress was not reliably determined from the overcoring measurements due to probable tensile core damage for tests at Level 2. Since the results indicate a steeply dipping major principal stress with a trend that is different than the regional stress orientation, and since large variations were found over short vertical distances (for the upper test locations at Level 2), additional interpretations are required. It cannot be ruled out that the stresses at these depths are lower, as indicated by some of the other measurements at Level 2 (most notably test no. 2:8:1). The obtained stress data should be analysed and correlated to geological data (lithology, structures, fracture zones, etc) at the site, as well as compared to measurements in nearby areas.

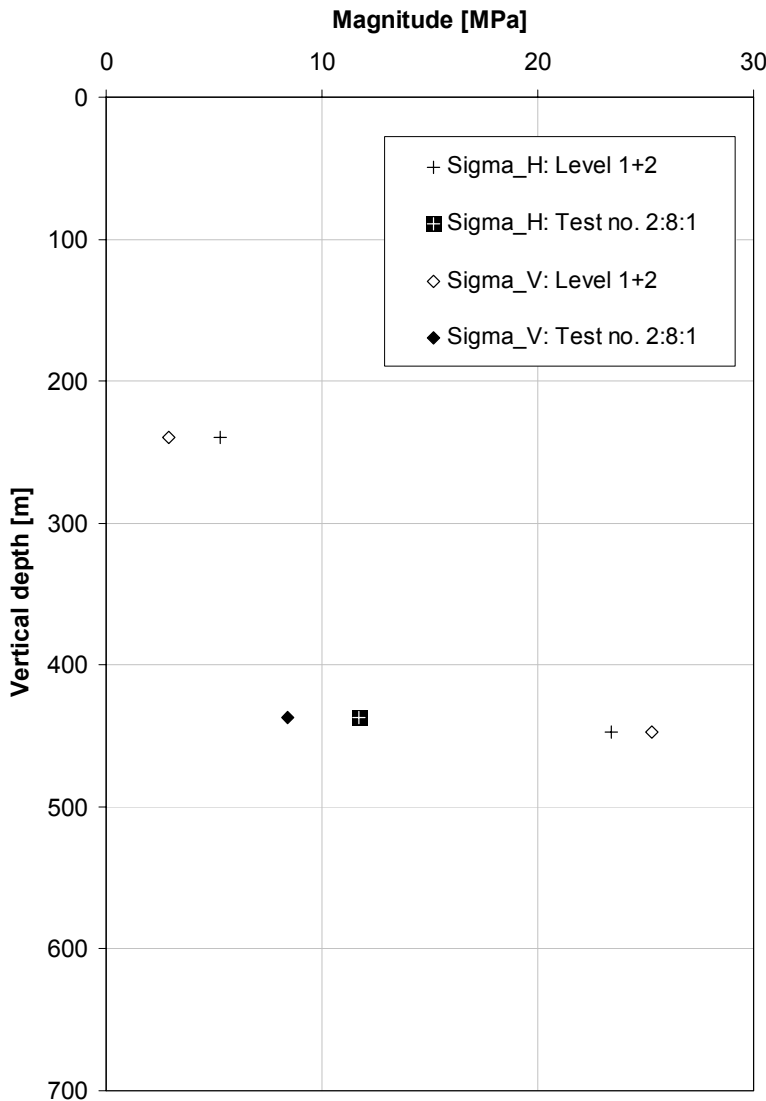

Figure 5-5. Measured maximum horizontal stress and vertical stress in borehole KLX04 – average values for Levels 1 and 2, compared to values for test no. 2:8:1.

6 References

- Amadei B, Stephansson O, 1997.** Rock stress and its measurement. London: Chapman & Hall, 490 pp.
- Fouial K, Alheib M, Baroudi H, Trentsaux C, 1998.** Improvement in the interpretation of stress measurements by use of the overcoring method: development of a new approach. *Engineering Geology*, 49, pp. 239–252.
- Hakala M, Hudson J A, Christiansson R, 2003.** Quality control of overcoring stress measurement data. *Int. J. Rock Mech. Min. Sci.*, 40, No. 7–8, pp. 1141–1159.
- KTH, 1990.** Formelsamling i hållfasthetslära. Publikation nr 104, Institutionen för hållfasthetslära, Kungliga Tekniska Högskolan, Stockholm (in Swedish).
- Leeman E R, 1968.** The determination of the complete state of stress in rock using a single borehole–laboratory and underground measurements. *Int. J. Rock Mech. & Min. Sci.*, 5, 31–56.
- Leeman E R, Hayes D I, 1966.** A technique for determining the complete state of stress in rock using a single borehole. In *Proceedings of the 1st International Congress on Rock Mechanics (Lisboa, 1966)*, Vol. 2, pp. 17–24.
- Perman et al. 2005.** Evaluation of the overcoring results from borehole KFM01B. SKB P-05-66, Svensk Kärnbränslehantering AB.
- Sjöberg, J, 2004.** Overcoring rock stress measurements in borehole KAV04. SKB P-04-84, Svensk Kärnbränslehantering AB.
- Sjöberg J, Klasson H, 2003.** Stress measurements in deep boreholes using the *Borre* (SSPB) probe. *Int. J. Rock Mech. Min. Sci.*, 40, No. 7–8, pp. 1205–1233.
- Walker J R, Martin C D, Dzik E J, 1990.** Technical Note: Confidence intervals for in situ stress measurements. *Int. J. Rock Mech. Min. Sci. & Geomech. Abstr.*, 27, No. 2, pp. 139–141.

Key measurement data

Table A1. Key measurement data for test no. 1:2:3, 235.91 m borehole length.

Activity	Date [yy-mm-dd]	Time [hh:mm:ss]
Activation time	04-03-29	16:58:00
Mixing of glue	04-03-29	17:16:00
Application of glue to gauges	04-03-29	17:24:00
Probe installation in pilot hole	04-03-29	17:38:50
Start time for dense sampling (5 s interval)	04-03-30	07:00:00
Adapter retrieved	04-03-30	07:54:00
Adapter on surface	04-03-30	08:04:00
Drill string fed down the hole	04-03-30	08:23:00
Drill string in place	04-03-30	08:59:00
Flushing start	04-03-30	09:09:00
Rotation start	04-03-30	09:31:00
Overcoring start	04-03-30	09:33:40
Overcoring 4 cm	04-03-30	09:34:30
Overcoring 8 cm	04-03-30	09:35:30
Overcoring 12 cm	04-03-30	09:36:20
Overcoring 16 cm	04-03-30	09:37:20
Overcoring 20 cm	04-03-30	09:38:10
Overcoring 24 cm	04-03-30	09:39:00
Overcoring 28 cm	04-03-30	09:40:00
Overcoring 32 cm	04-03-30	09:41:05
Overcoring stop (100 cm)	04-03-30	09:46:20
Flushing off	04-03-30	10:02:55
Core break	04-03-30	10:19:25
Core retrieval start	04-03-30	10:37:50
Core and probe on surface	04-03-30	11:12:00
End of strain registration	04-03-30	12:39:10
Calculation of strain difference: OC Start	04-03-30	–
Calculation of strain difference: OC Stop	04-03-30	–
Overcoring advance	Overcoring rate [cm/min]	
0–6 cm	4.4	
16–32 cm	4.3	
32 cm – overcoring stop	13	

Table A2. Key measurement data for test no. 1:3:2, 242.38 m borehole length.

Activity	Date [yy-mm-dd]	Time [hh:mm:ss]
Activation time	04-04-01	12:58:00
Mixing of glue	04-04-01	13:18:00
Application of glue to gauges	04-04-01	13:26:00
Probe installation in pilot hole	04-04-01	13:38:00
Start time for dense sampling (5 s interval)	04-04-02	07:00:00
Adapter retrieved	04-04-02	08:08:00
Adapter on surface	04-04-02	08:18:00
Drill string fed down the hole	04-04-02	08:32:00
Drill string in place	04-04-02	09:08:00
Flushing start	04-04-02	10:57:00
Rotation start	04-04-02	11:14:45
Overcoring start	04-04-02	11:15:40
Overcoring 4 cm	04-04-02	11:17:00
Overcoring 8 cm	04-04-02	11:18:05
Overcoring 12 cm	04-04-02	11:18:45
Overcoring 16 cm	04-04-02	11:19:10
Overcoring 20 cm	04-04-02	11:19:35
Overcoring 24 cm	04-04-02	11:20:00
Overcoring 28 cm	04-04-02	11:20:30
Overcoring 32 cm	04-04-02	11:20:50
Overcoring stop (100 cm)	04-04-02	11:27:35
Flushing off	04-04-02	11:42:50
Core break	04-04-02	12:46:00
Core retrieval start	04-04-02	13:01:30
Core and probe on surface	04-04-02	13:40:00
End of strain registration	04-04-02	14:06:15
Calculation of strain difference: OC Start	04-04-02	11:13:40
Calculation of strain difference: OC Stop	04-04-02	11:27:35
Overcoring advance	Overcoring rate [cm/min]	
0–16 cm	≈ 5 (varying)	
16–32 cm	≈ 10 (varying)	
32 cm – overcoring stop	10	

Table A3. Key measurement data for test no. 1:5:1, 245.44 m borehole length.

Activity	Date [yy-mm-dd]	Time [hh:mm:ss]
Activation time	04-04-04	18:45:00
Mixing of glue	04-04-04	18:57:00
Application of glue to gauges	04-04-04	19:05:00
Probe installation in pilot hole	04-04-04	19:13:00
Start time for dense sampling (5 s interval)	04-04-05	07:00:00
Adapter retrieved	04-04-05	07:48:25
Adapter on surface	04-04-05	07:57:00
Drill string fed down the hole	04-04-05	08:04:30
Drill string in place	04-04-05	08:37:00
Flushing start	04-04-05	08:41:55
Rotation start	04-04-05	09:00:00
Overcoring start	04-04-05	09:00:00
Overcoring 4 cm	04-04-05	09:01:00
Overcoring 8 cm	04-04-05	09:01:55
Overcoring 12 cm	04-04-05	09:02:45
Overcoring 16 cm	04-04-05	09:03:45
Overcoring 20 cm	04-04-05	09:04:35
Overcoring 24 cm	04-04-05	09:05:20
Overcoring 28 cm	04-04-05	09:06:05
Overcoring 32 cm	04-04-05	09:06:55
Overcoring 40 cm – increasing speed to 10cm/min	04-04-05	09:08:30
Overcoring stop (100 cm)	04-04-05	09:15:45
Flushing off	04-04-05	09:40:00
Core break	04-04-05	10:01:55
Core retrieval start	04-04-05	10:19:00
Core and probe on surface	04-04-05	10:50:00
End of strain registration	04-04-05	11:15:20
Calculation of strain difference: OC Start	04-04-05	09:00:00
Calculation of strain difference: OC Stop	04-04-05	09:15:45
Overcoring advance	Overcoring rate [cm/min]	
0 – 16 cm	4.3	
16 – 40cm	5.0	
40 cm – overcoring stop	8.3	

Table A4. Key measurement data for test no. 2:1:3, 374.68 m borehole length.

Activity	Date [yy-mm-dd]	Time [hh:mm:ss]
Activation time	04-04-24	16:15:00
Mixing of glue	04-04-24	16:37:00
Application of glue to gauges	04-04-24	16:43:00:
Probe installation in pilot hole	04-04-24	16:50:00
Start time for dense sampling (5 s interval)	04-04-25	07:00:00
Adapter retrieved	04-04-25	07:51:30
Adapter on surface	04-04-25	07:56:00
Drill string fed down the hole	04-04-25	08:03:00
Drill string in place	04-04-25	09:01:00
Flushing start	04-04-25	09:01:00
Rotation start	04-04-25	09:29:05
Overcoring start	04-04-25	09:30:10
Overcoring 4 cm	04-04-25	09:30:35
Overcoring 8 cm	04-04-25	09:31:45
Overcoring 12 cm	04-04-25	09:32:45
Overcoring 16 cm	04-04-25	09:33:45 ^{*)}
Overcoring 20 cm	04-04-25	09:34:45
Overcoring 24 cm	04-04-25	09:35:45
Overcoring 28 cm	04-04-25	09:36:45
Overcoring 32 cm	04-04-25	09:37:55
Overcoring stop (100 cm)	04-04-25	09:46:15
Flushing off	04-04-25	10:02:00
Core break	04-04-25	10:17:05
Core retrieval start	04-04-25	10:33:00
Core and probe on surface	04-04-25	11:25:05
End of strain registration	04-04-25	11:52:35
Calculation of strain difference: OC Start	04-04-25	09:30:10
Calculation of strain difference: OC Stop	04-04-25	09:46:15
Overcoring advance	Overcoring rate [cm/min]	
0 – 16 cm	4.5	
16 – 32 cm	3.8	
32 cm – overcoring stop	10.7	

^{*)} Corrected to 09:35:45 based on transient strain analysis (cf. Figure B8).

Table A5. Key measurement data for test no. 2:2:1, 376.86 m borehole length.

Activity	Date [yy-mm-dd]	Time [hh:mm:ss]
Activation time	04-04-25	19:02:00
Mixing of glue	04-04-25	19:11:00
Application of glue to gauges	04-04-25	19:14:00
Probe installation in pilot hole	04-04-25	19:25:00
Start time for dense sampling (5 s interval)	04-04-26	07:00:00
Adapter retrieved	04-04-26	07:44:10
Adapter on surface	04-04-26	07:49:35
Drill string fed down the hole	04-04-26	07:56:00
Drill string in place	04-04-26	08:45:00
Flushing start	04-04-26	08:40:00
Rotation start	04-04-26	08:45:00
Overcoring start	04-04-26	08:54:45
Overcoring 4 cm	04-04-26	08:55:45
Overcoring 8 cm	04-04-26	08:56:40
Overcoring 12 cm	04-04-26	08:57:30
Overcoring 16 cm	04-04-26	08:58:35
Overcoring 20 cm	04-04-26	08:59:30
Overcoring 24 cm	04-04-26	09:00:25
Overcoring 28 cm	04-04-26	09:01:20
Overcoring 32 cm	04-04-26	09:02:15
Overcoring stop (110 cm)	04-04-26	09:11:25
Flushing off	04-04-26	09:26:00
Core break	04-04-26	09:42:00
Core retrieval start	04-04-26	09:58:00
Core and probe on surface	04-04-26	11:13:00
End of strain registration	04-04-26	11:17:45
Calculation of strain difference: OC Start	04-04-26	08:54:45
Calculation of strain difference: OC Stop	04-04-26	09:25:30
Overcoring advance	Overcoring rate [cm/min]	
0–16 cm	4.2	
16–32 cm	4.4	
32 cm – overcoring stop	6.1	

Table A6. Key measurement data for test no. 2:8:1, 439.51 m borehole length.

Activity	Date [yy-mm-dd]	Time [hh:mm:ss]
Activation time	04-05-11	03:56:00
Mixing of glue	04-05-11	04:05:00
Application of glue to gauges	04-05-11	04:14:00
Probe installation in pilot hole	04-05-11	04:27:00
Start time for dense sampling (5 s interval)	04-05-11	18:00:00
Adapter retrieved	04-05-11	18:40:00
Adapter on surface	04-05-11	18:50:00
Drill string fed down the hole	04-05-11	19:10:00
Drill string in place	04-05-11	20:41:00
Flushing start	04-05-11	20:43:00
Rotation start	04-05-11	21:02:00
Overcoring start	04-05-11	21:04:10
Overcoring 4 cm	04-05-11	21:05:10
Overcoring 8 cm	04-05-11	21:06:30
Overcoring 12 cm	04-05-11	21:07:40
Overcoring 16 cm	04-05-11	21:08:50
Overcoring 20 cm	04-05-11	21:10:10
Overcoring 24 cm	04-05-11	21:11:30
Overcoring 28 cm	04-05-11	21:12:20
Overcoring 32 cm	04-05-11	21:13:35
Overcoring stop (100 cm)	04-05-11	21:23:00
Flushing off	04-05-11	21:39:00
Core break	04-05-11	21:55:00
Core retrieval start	04-05-11	22:13:00
Core and probe on surface	04-05-11	23:25:00
End of strain registration	04-05-11	23:56:05
Calculation of strain difference: OC Start	04-05-11	20:58:00
Calculation of strain difference: OC Stop	04-05-11	21:39:00
Overcoring advance	Overcoring rate [cm/min]	
0 – 16 cm	3.4	
16 – 32 cm	3.4	
32 cm – overcoring stop	7.1	

Table A7. Key measurement data for test no. 2:11:1, 447.44 m borehole length.

Activity	Date [yy-mm-dd]	Time [hh:mm:ss]
Activation time	04-05-16	12:14:00
Mixing of glue	04-05-16	13:03:00
Application of glue to gauges	04-05-16	13:06:00
Probe installation in pilot hole	04-05-16	13:18:00
Start time for dense sampling (5 s interval)	04-05-17	07:00:00
Adapter retrieved	04-05-17	07:35:00
Adapter on surface	04-05-17	07:42:00
Drill string fed down the hole	04-05-17	07:55:00
Drill string in place	04-05-17	09:05:00
Flushing start	04-05-17	09:06:00
Rotation start	04-05-17	09:19:00
Overcoring start	04-05-17	09:21:00
Overcoring 4 cm	04-05-17	09:22:00
Overcoring 8 cm	04-05-17	09:23:00
Overcoring 12 cm	04-05-17	09:24:00
Overcoring 16 cm	04-05-17	09:25:00
Overcoring 20 cm	04-05-17	09:26:00
Overcoring 24 cm	04-05-17	09:27:30
Overcoring 28 cm	04-05-17	09:28:30
Overcoring 32 cm	04-05-17	09:30:00
Overcoring stop (100 cm)	04-05-17	09:40:00
Flushing off	04-05-17	09:55:00
Core break	04-05-17	10:11:00
Core retrieval start	04-05-17	10:26:00
Core and probe on surface	04-05-17	11:35:00
End of strain registration	04-05-17	11:57:15
Calculation of strain difference: OC Start	04-05-17	09:18:00
Calculation of strain difference: OC Stop	04-05-17	09:40:00
Overcoring advance	Overcoring rate [cm/min]	
0 – 16 cm	4.0	
16 – 32 cm	3.2	
32 cm – overcoring stop	6.8	

Table A8. Key measurement data for test no. 2:13:1, 449.56 m borehole length.

Activity	Date [yy-mm-dd]	Time [hh:mm:ss]
Activation time	04-05-19	20:45:00
Mixing of glue	04-05-19	21:13:00
Application of glue to gauges	04-05-19	21:24:00
Probe installation in pilot hole	04-05-19	21:39:00
Start time for dense sampling (5 s interval)	04-05-20	07:00:00
Adapter retrieved	04-05-20	08:00:00
Adapter on surface	04-05-20	08:08:00
Drill string fed down the hole	04-05-20	08:15:00
Drill string in place	04-05-20	09:12:00
Flushing start	04-05-20	09:21:30
Rotation start	04-05-20	09:38:00
Overcoring start	04-05-20	09:46:30
Overcoring 4 cm	04-05-20	09:47:30
Overcoring 8 cm	04-05-20	09:48:40
Overcoring 12 cm	04-05-20	09:50:00
Overcoring 16 cm	04-05-20	09:51:15 ^{*)}
Overcoring 20 cm	04-05-20	09:52:30
Overcoring 24 cm	04-05-20	09:53:30
Overcoring 28 cm	04-05-20	09:55:00
Overcoring 32 cm	04-05-20	09:56:30
Overcoring stop (100 cm)	04-05-20	10:03:40
Flushing off	04-05-20	10:19:00
Core break	04-05-20	10:34:00
Core retrieval start	04-05-20	10:49:00
Core and probe on surface	04-05-20	11:45:00
End of strain registration	04-05-20	11:59:45
Calculation of strain difference: OC Start	04-05-20	09:44:30
Calculation of strain difference: OC Stop	04-05-20	10:18:30
Overcoring advance	Overcoring rate [cm/min]	
0–16 cm	3.4	
16–32 cm	3.1	
32 cm – overcoring stop	9.5	

^{*)} Corrected to 09:49:15 based on transient strain analysis (cf. Figure B16).

Table A9. Key measurement data for test no. 2:14:1, 450.66 m borehole length.

Activity	Date [yy-mm-dd]	Time [hh:mm:ss]
Activation time	04-05-20	20:30:00
Mixing of glue	04-05-20	20:48:00
Application of glue to gauges	04-05-20	20:54:00
Probe installation in pilot hole	04-05-20	21:11:00
Start time for dense sampling (5 s interval)	04-05-21	07:00:00
Adapter retrieved	04-05-21	07:53:00
Adapter on surface	04-05-21	08:01:30
Drill string fed down the hole	04-05-21	08:17:00
Drill string in place	04-05-21	09:10:00
Flushing start	04-05-21	09:12:30
Rotation start	04-05-21	09:29:00
Overcoring start	04-05-21	09:31:45
Overcoring 4 cm	04-05-21	09:32:50
Overcoring 8 cm	04-05-21	09:33:40
Overcoring 12 cm	04-05-21	09:34:40
Overcoring 16 cm	04-05-21	09:35:40
Overcoring 20 cm	04-05-21	09:36:55
Overcoring 24 cm	04-05-21	09:38:10
Overcoring 28 cm	04-05-21	09:39:15
Overcoring 32 cm	04-05-21	09:40:35
Overcoring stop (100 cm)	04-05-21	09:48:00
Flushing off	04-05-21	10:01:00
Core break	04-05-21	10:16:00
Core retrieval start	04-05-21	10:33:00
Core and probe on surface	04-05-21	11:30:00
End of strain registration	04-05-21	11:42:15
Calculation of strain difference: OC Start	04-05-21	09:29:00
Calculation of strain difference: OC Stop	04-05-21	10:00:00
Overcoring advance	Overcoring rate [cm/min]	
0–16 cm	3.3	
16–32 cm	3.3	
32 cm – overcoring stop	9.2	

Overcoring strain data and graphs

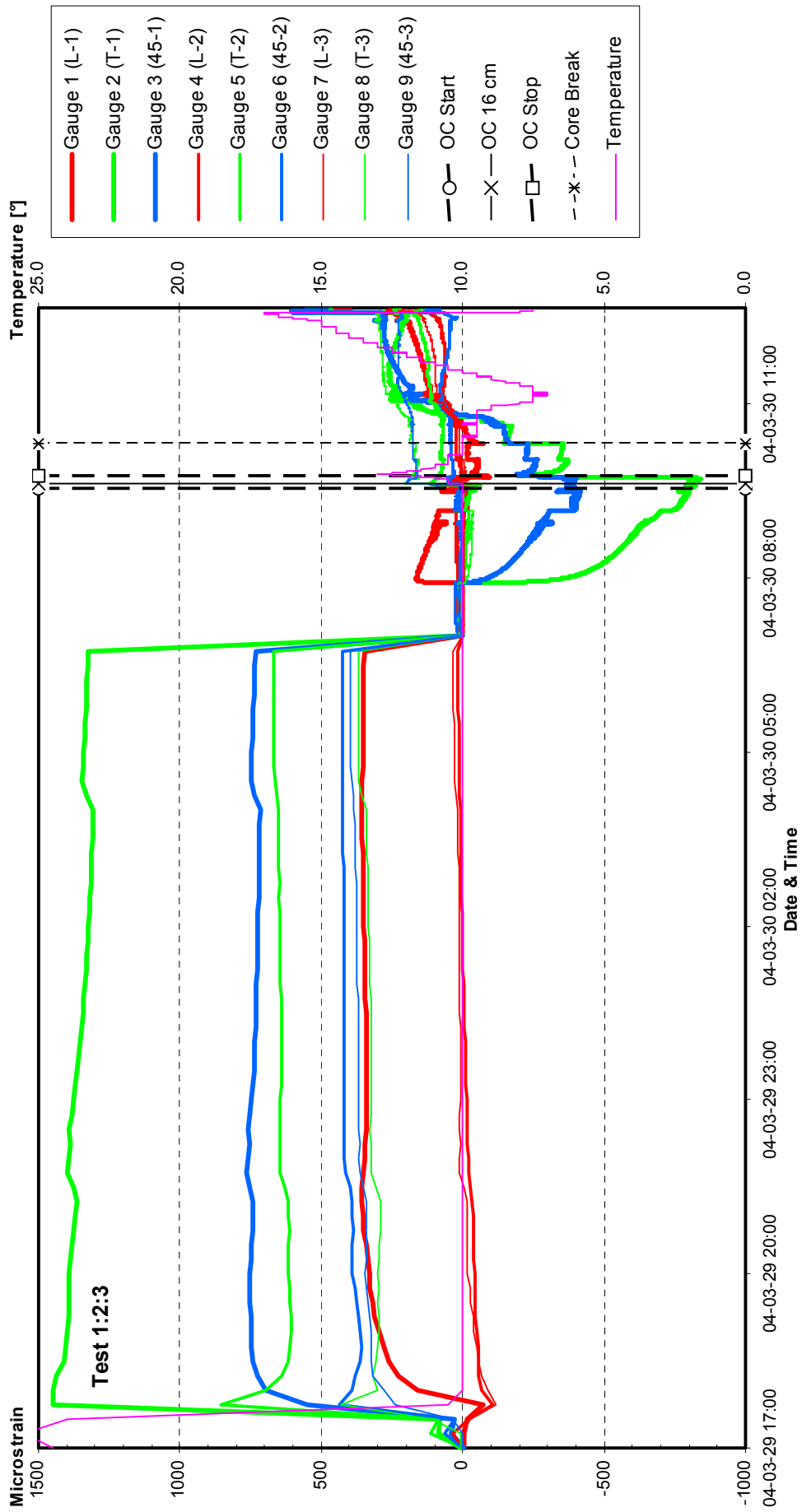

Figure B1. All recorded strain data and temperature from activation of probe to recovery from borehole for test no. 1:2:3, 235.91 m borehole length.

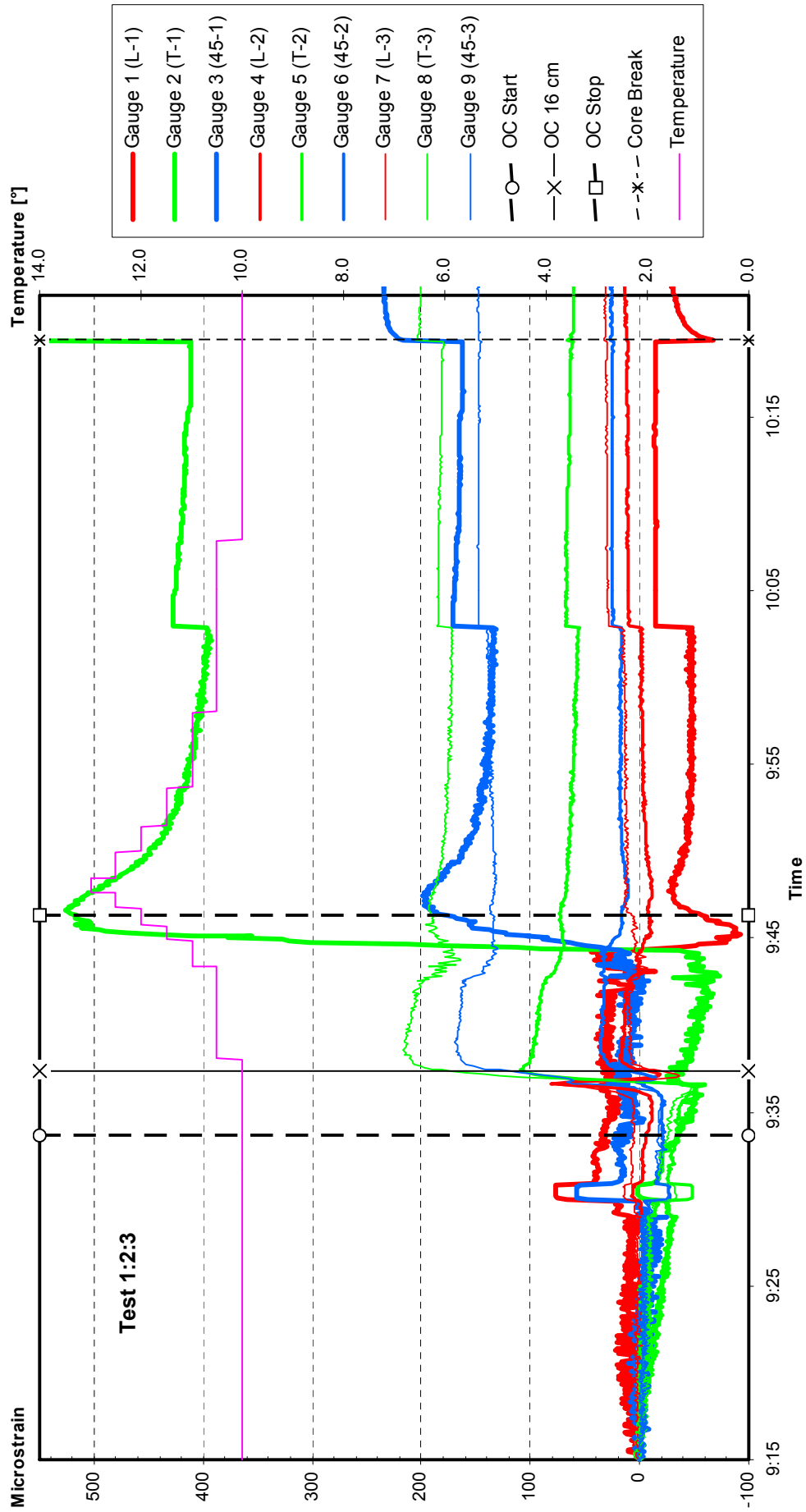

Figure B2. Recorded strain data and temperature during overcoring (from start to stop) for test no. 1-2:3, 235.91 m borehole length. Strain values reset to zero at 09:15.

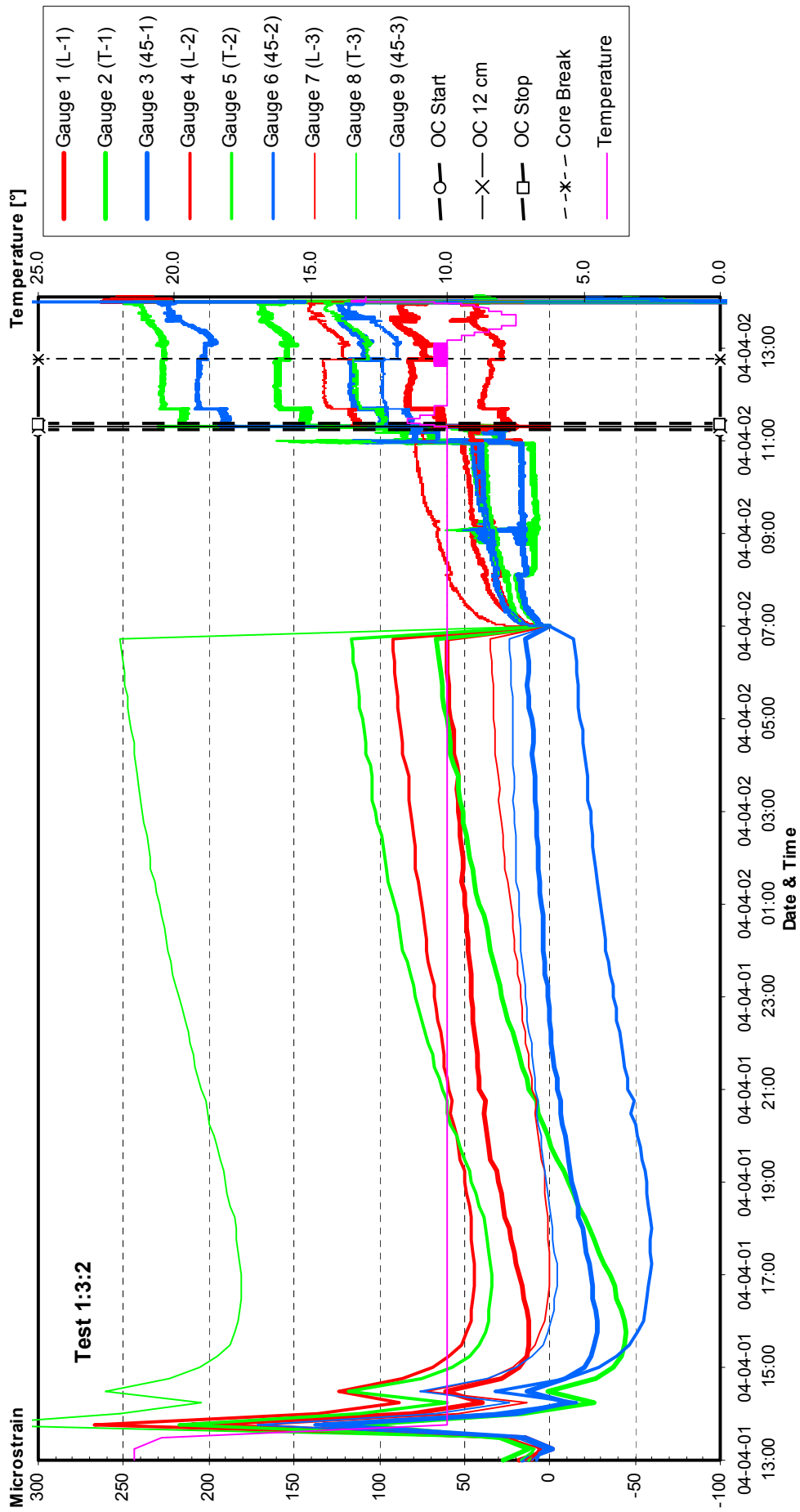

Figure B3. All recorded strain data and temperature from activation of probe to recovery from borehole for test no. 1:3:2, 242.38 m borehole length. Note that strain gauges were at 12 cm position in this test (OC 12 cm marked).

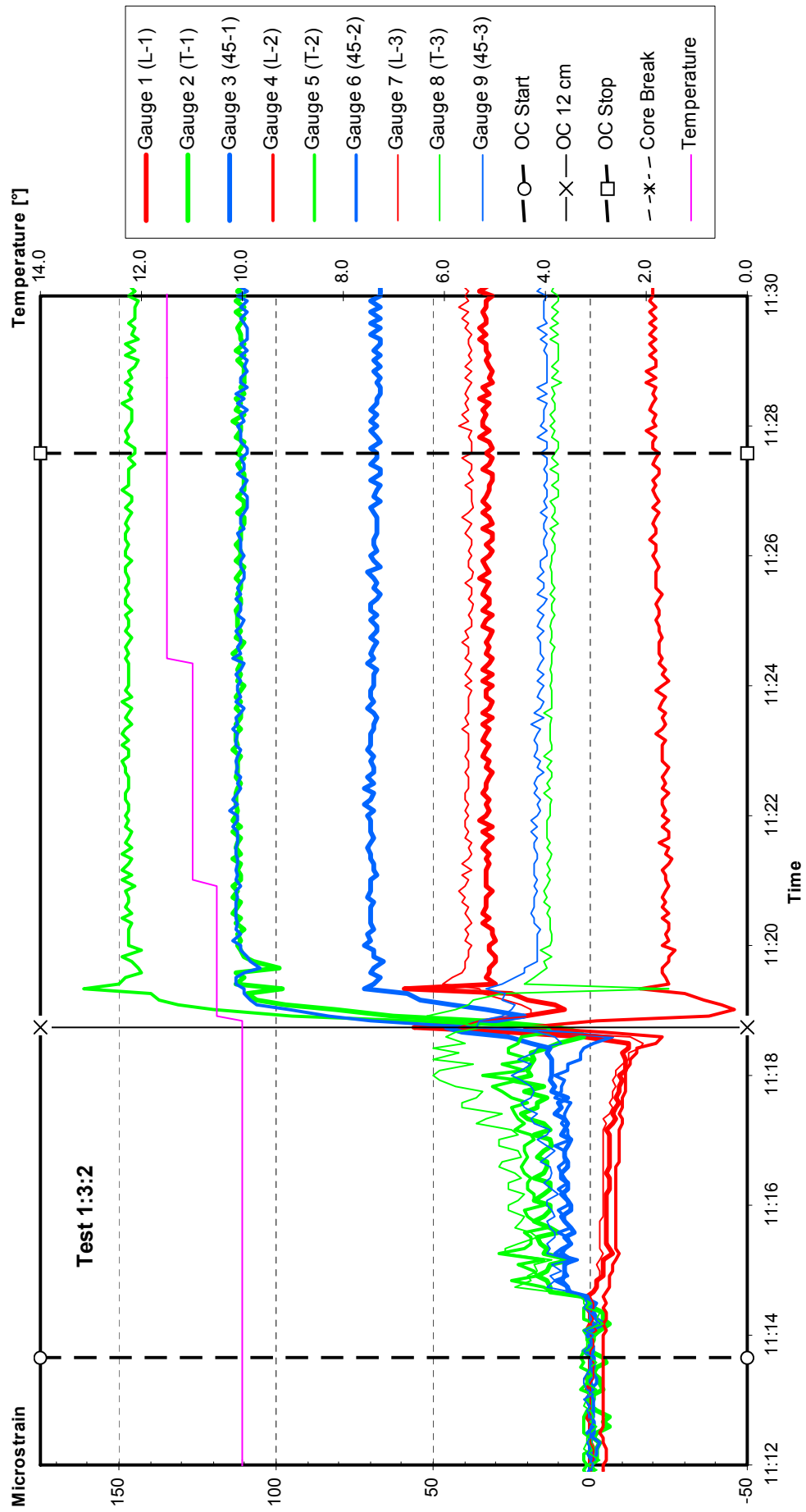

Figure B4. Recorded strain data and temperature during overcoring (from start to stop) for test no. 1:3:2, 242.38 m borehole length. Strain values reset to zero at 11.05. Note that strain gauges were at 12 cm position in this test (OC 12 cm marked).

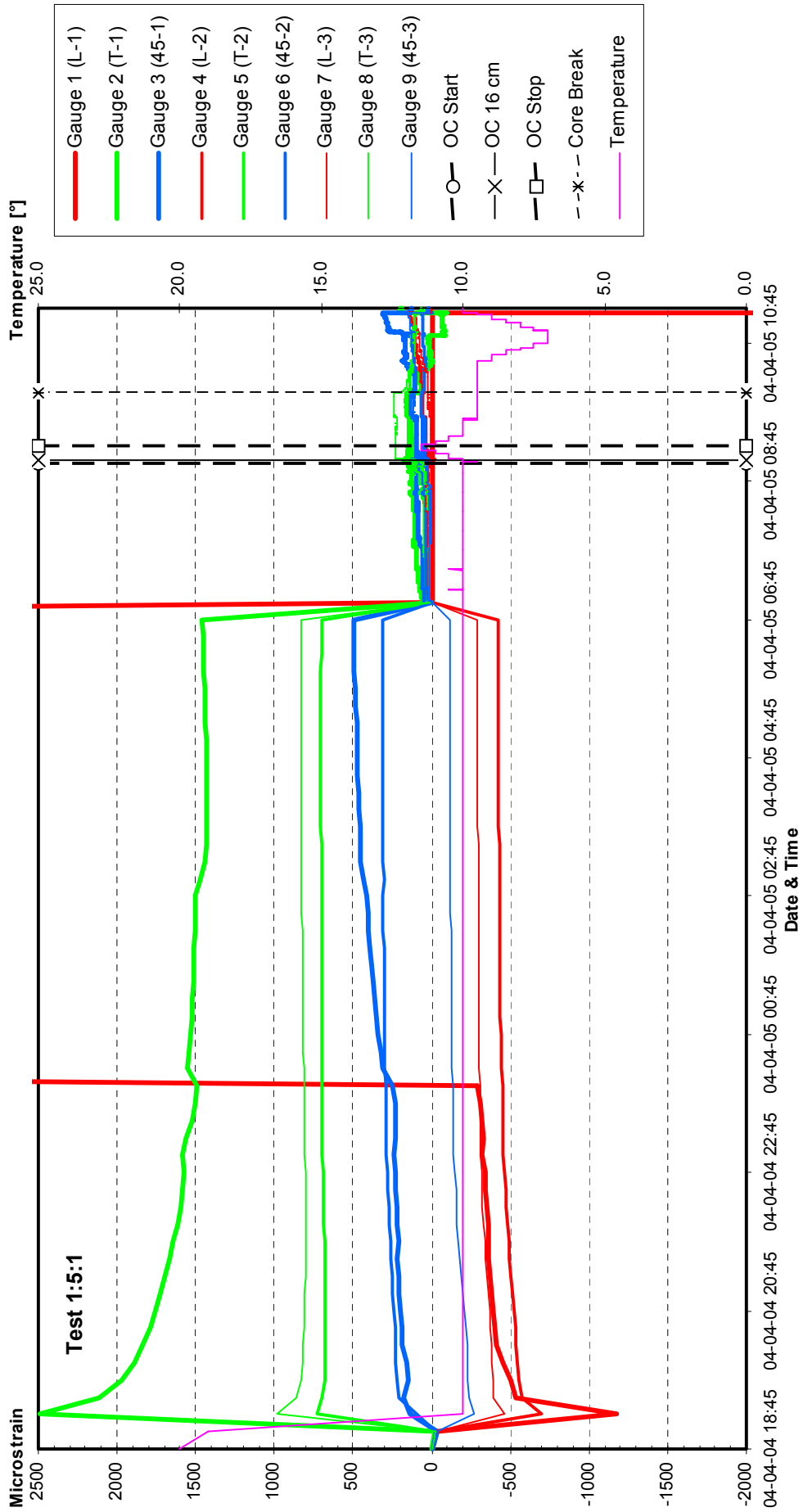

Figure B5. All recorded strain data and temperature from activation of probe to recovery from borehole for test no. 1:5:1, 245.44 m borehole length.

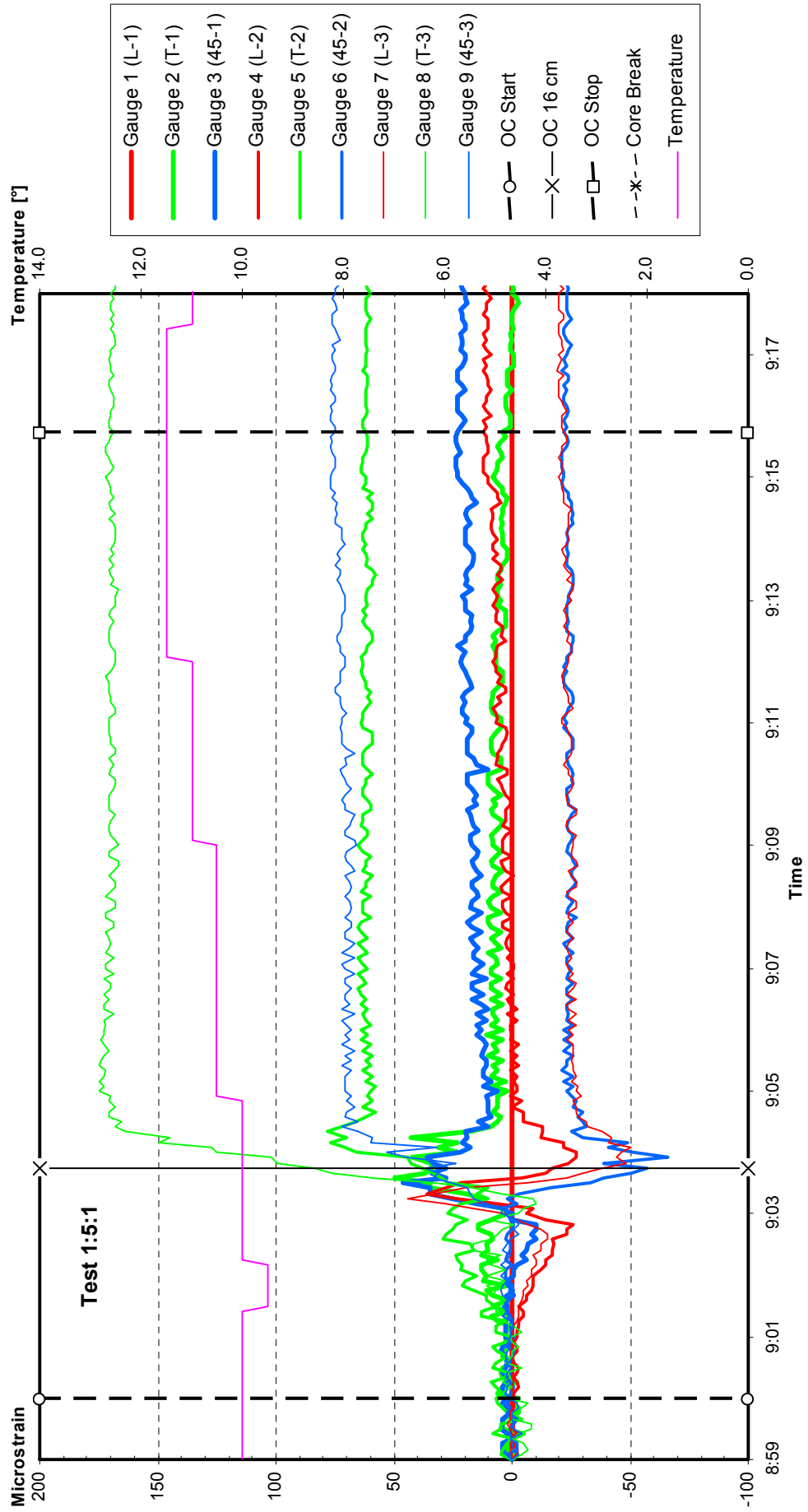

Figure B6. Recorded strain data and temperature during overcoring (from start to stop) for test no. 1:5:1, 245.44 m borehole length. Strain values reset to zero at 08:59.

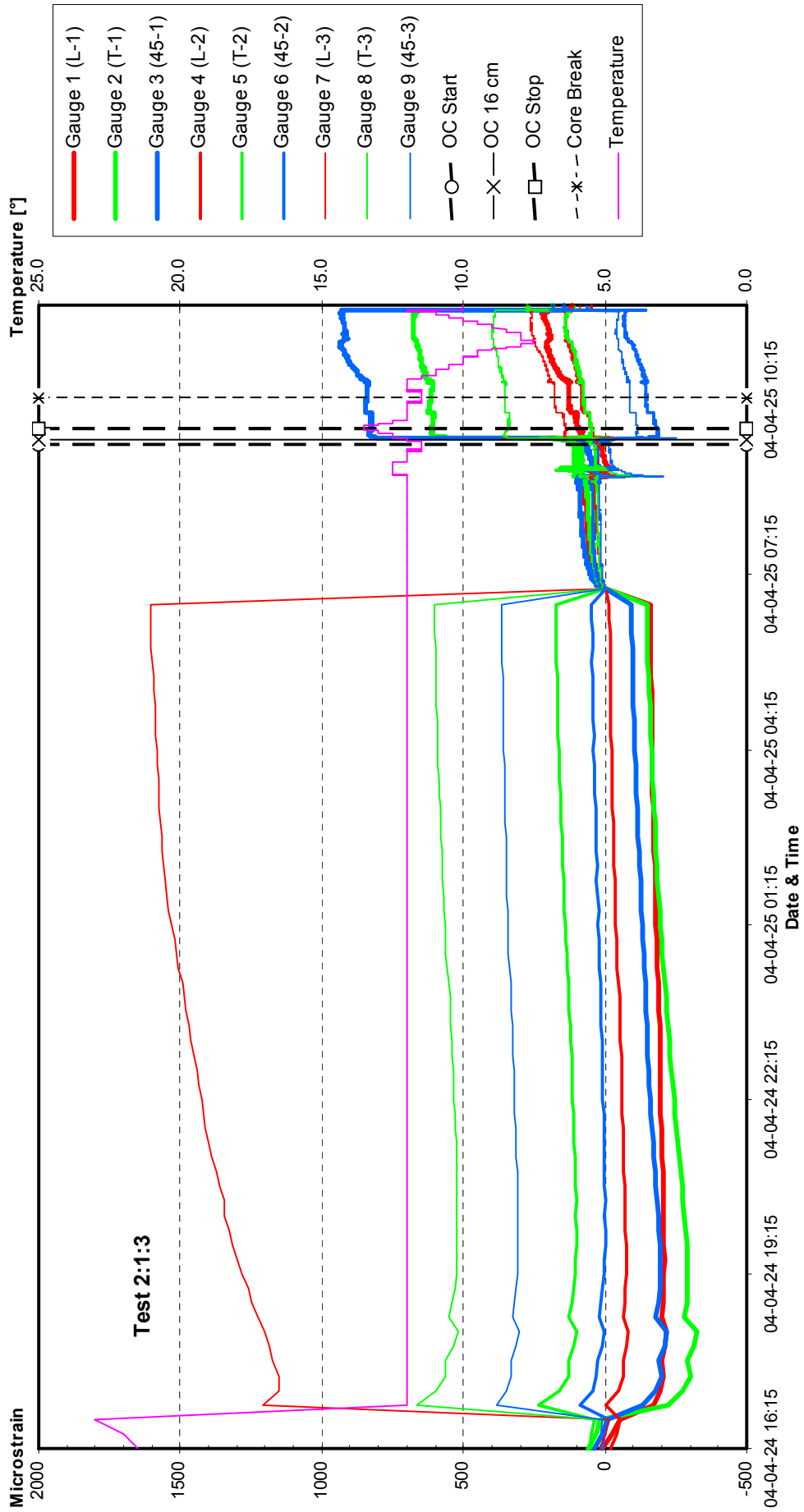

Figure B7. All recorded strain data and temperature from activation of probe to recovery from borehole for test no. 2:1:3, 374.68 m borehole length.

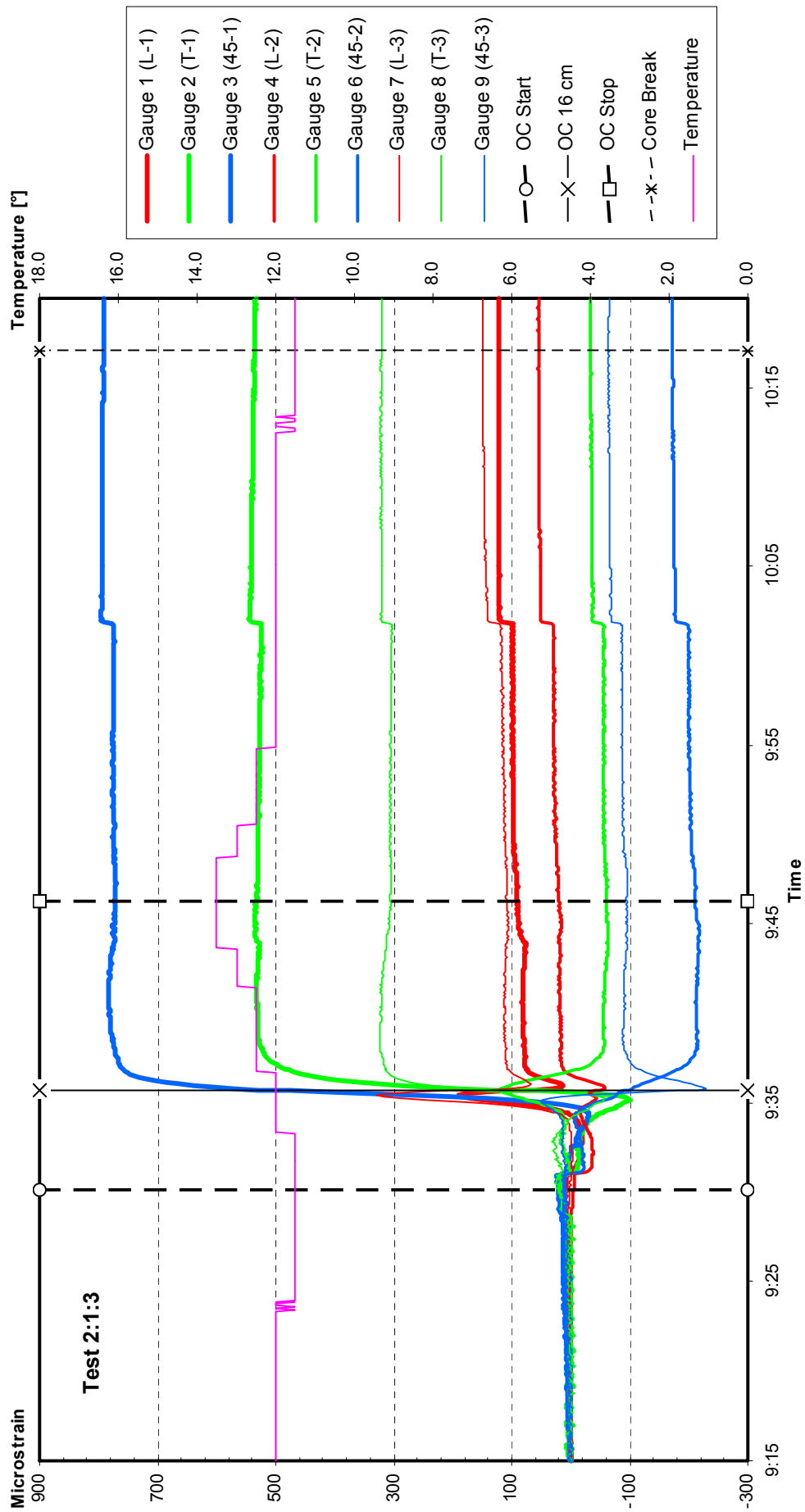

Figure B8. Recorded strain data and temperature during overcoring (from start to stop) for test no. 2:1:3, 374.68 m borehole length. Strain values reset to zero at 09:15.

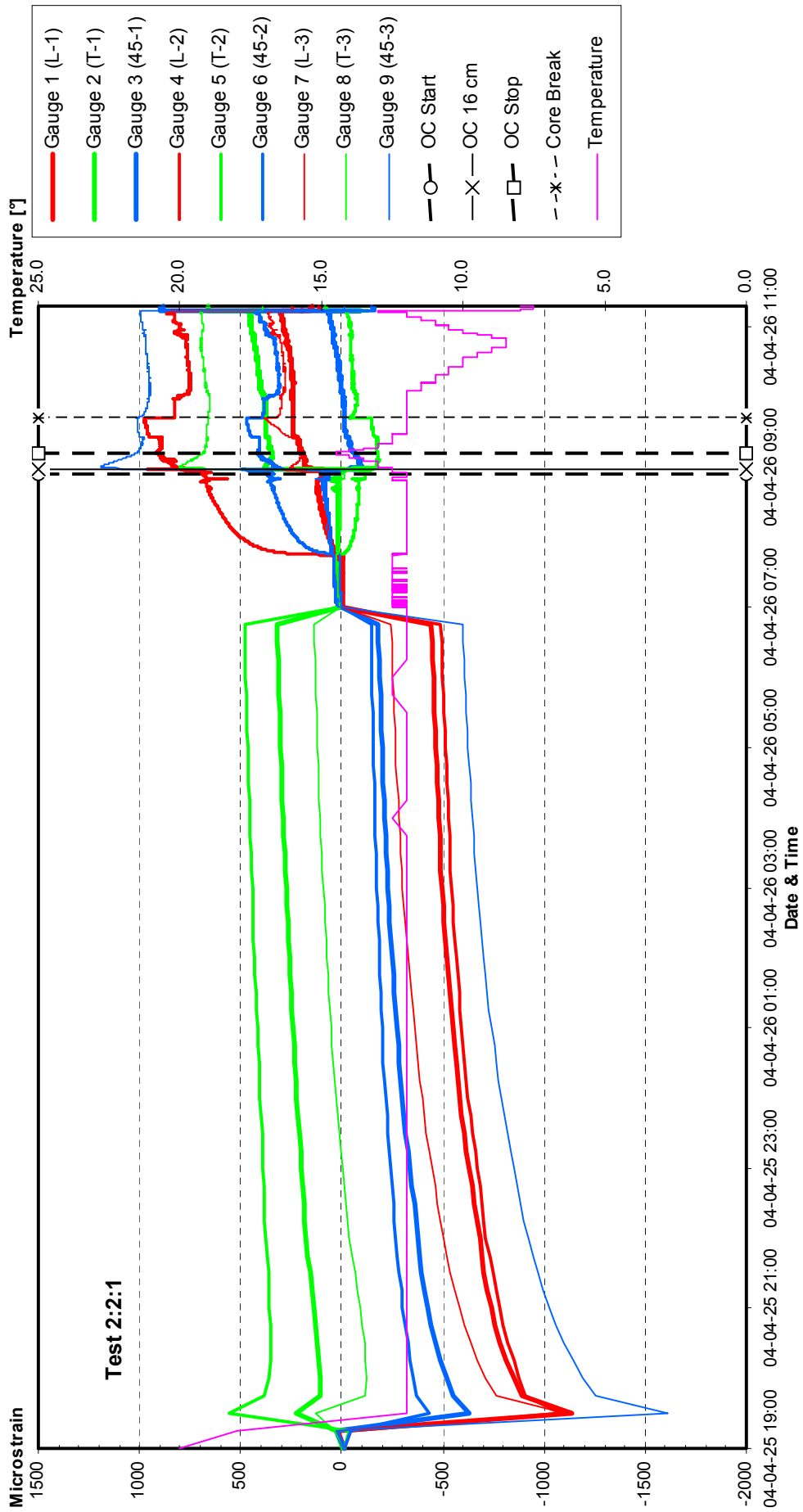

Figure B9. All recorded strain data and temperature from activation of probe to recovery from borehole for test no. 2:2:1, 376.86 m borehole length.

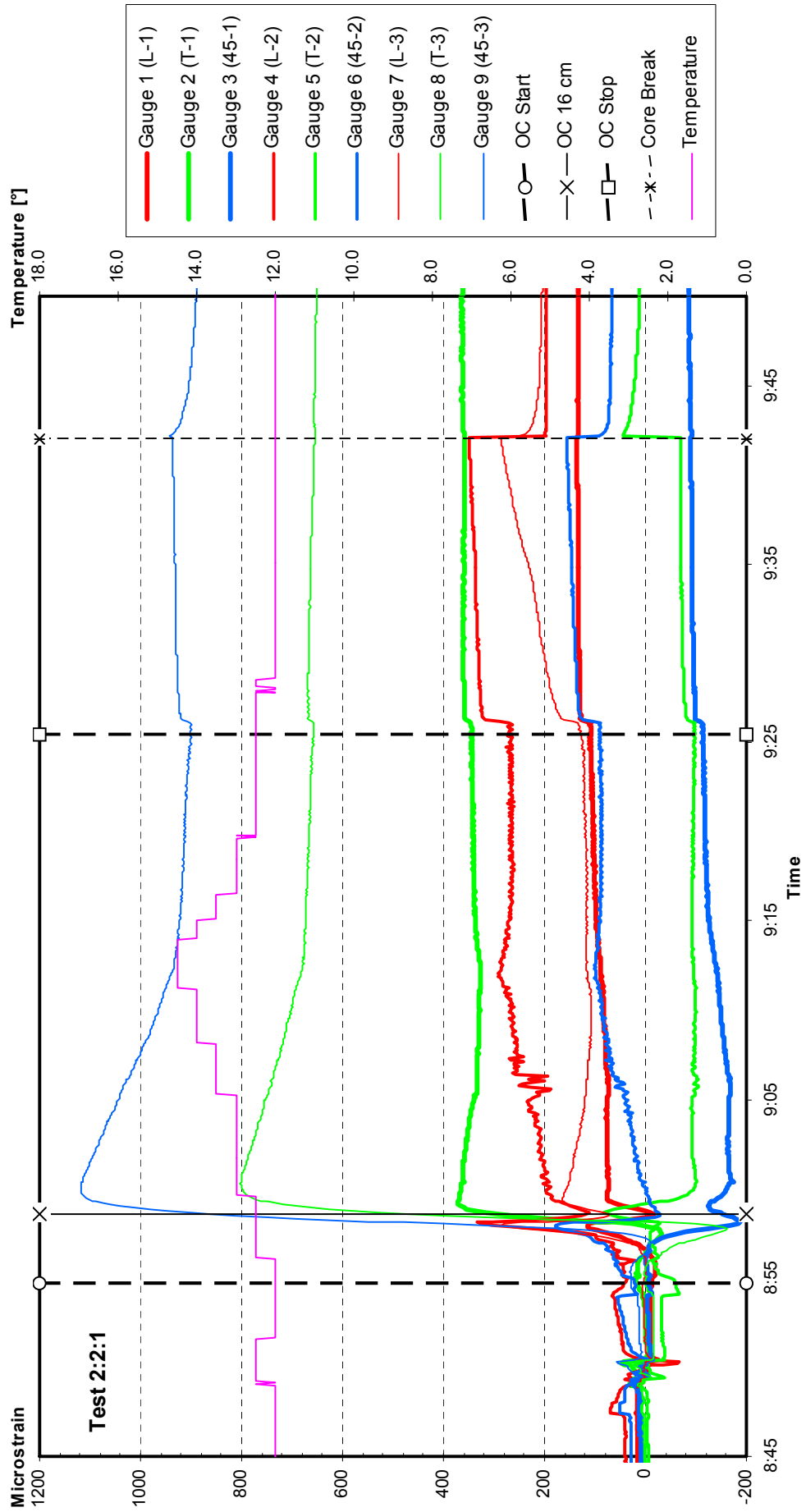

Figure B10. Recorded strain data and temperature during overcoring (from start to stop) for test no. 2:2:1, 376.86 m borehole length. Strain values reset to zero at 08:30.

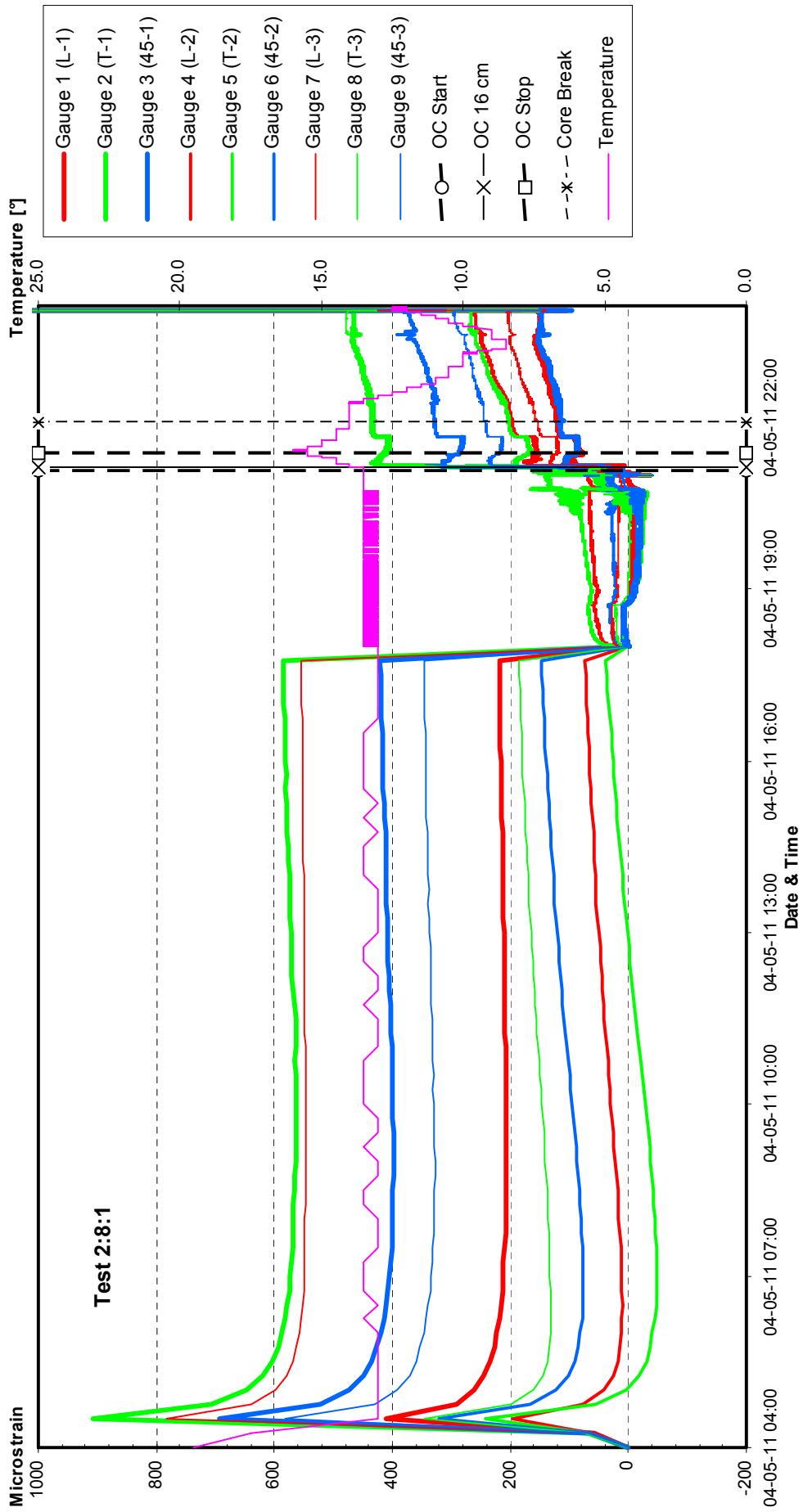

Figure B11. All recorded strain data and temperature from activation of probe to recovery from borehole for test no. 2-8:1, 439.51 m borehole length.

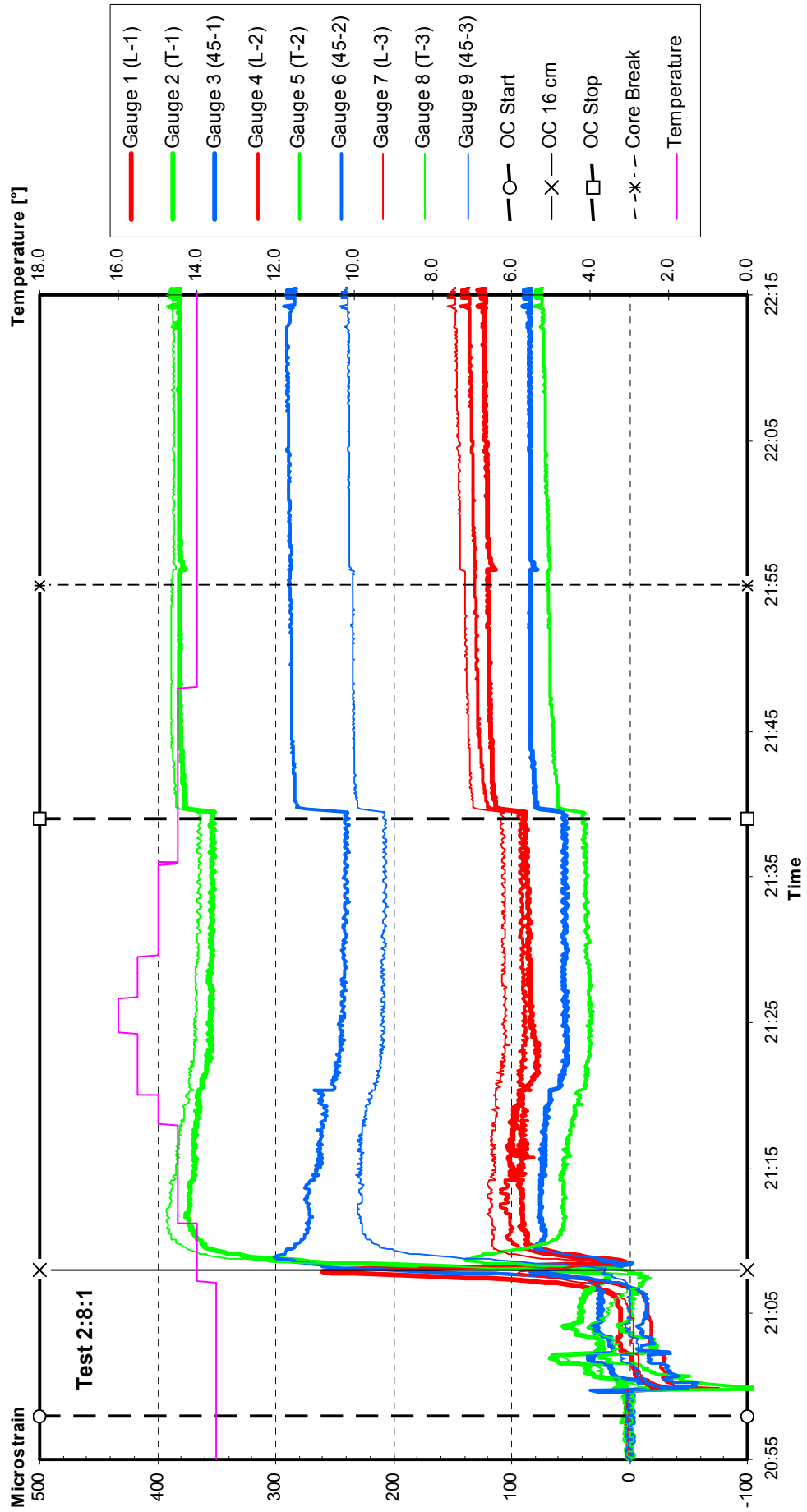

Figure B12. Recorded strain data and temperature during overcoring (from start to stop) for test no. 2:8:1, 439.51 m borehole length. Strain values reset to zero at 20:55.

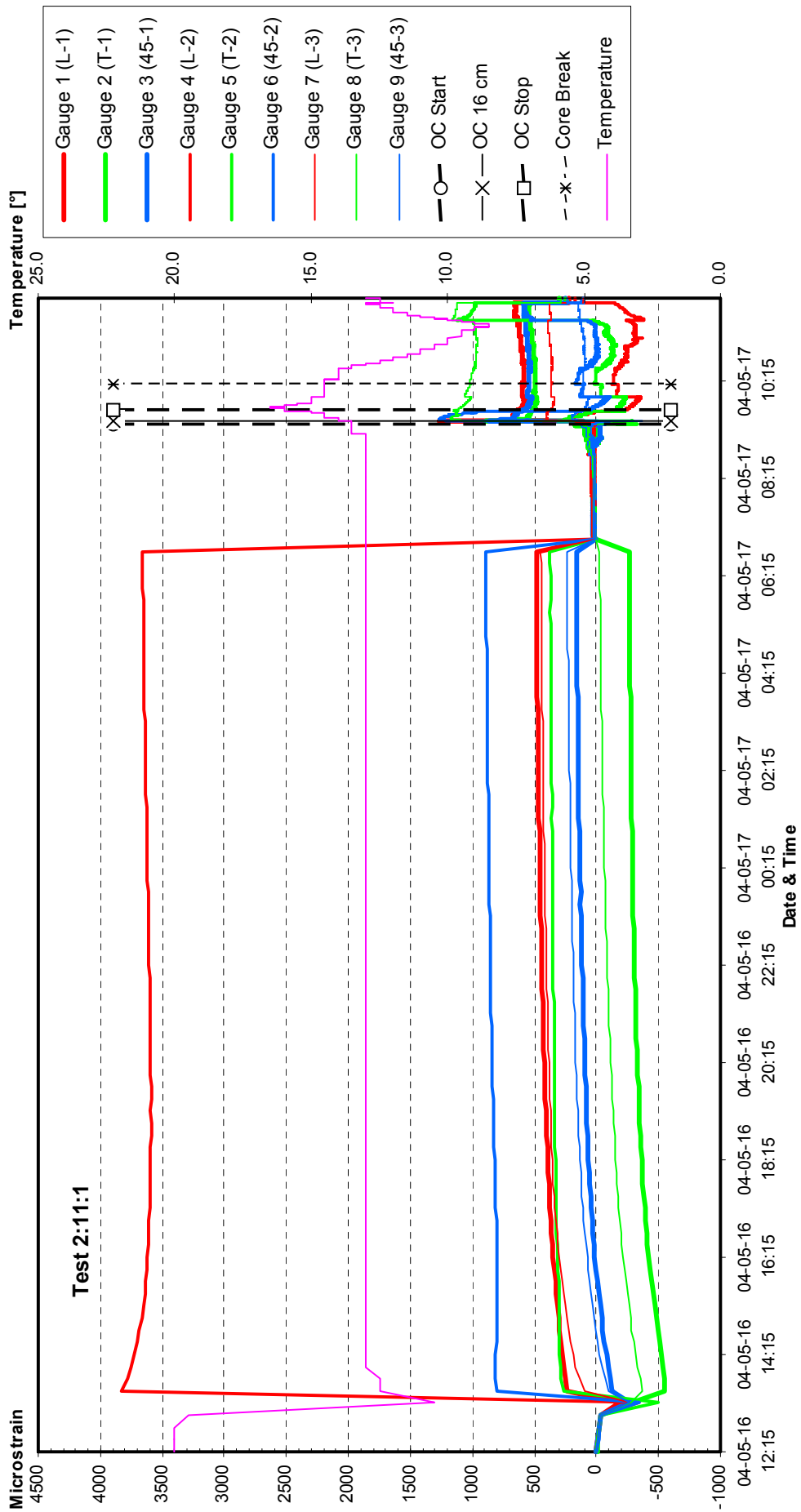

Figure B13. All recorded strain data and temperature from activation of probe to recovery from borehole for test no. 2:11:1, 447.44 m borehole length.

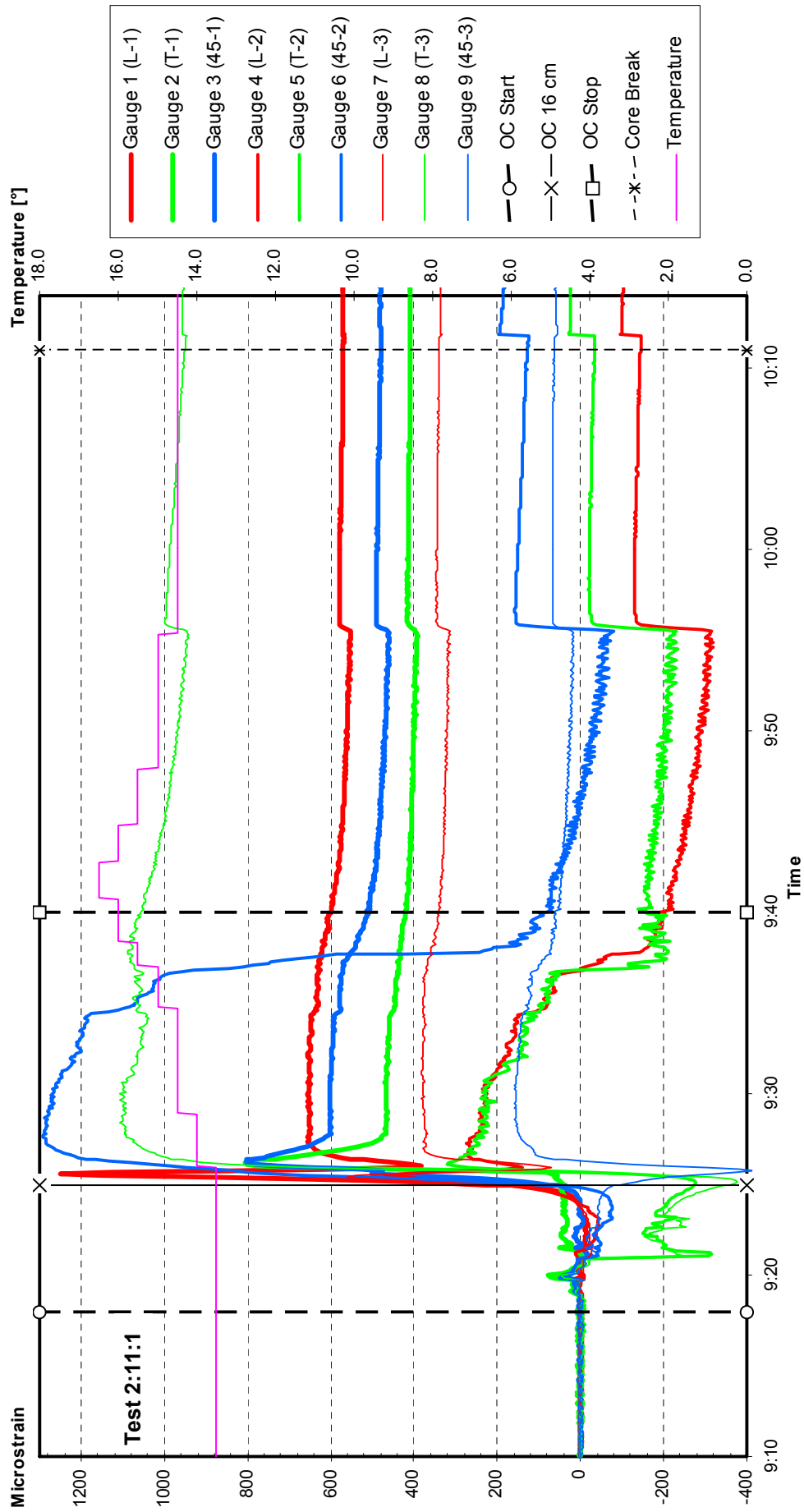

Figure B14. Recorded strain data and temperature during overcoring (from start to stop) for test no. 2:11:1, 447.44 m borehole length. Strain values reset to zero at 09:10.

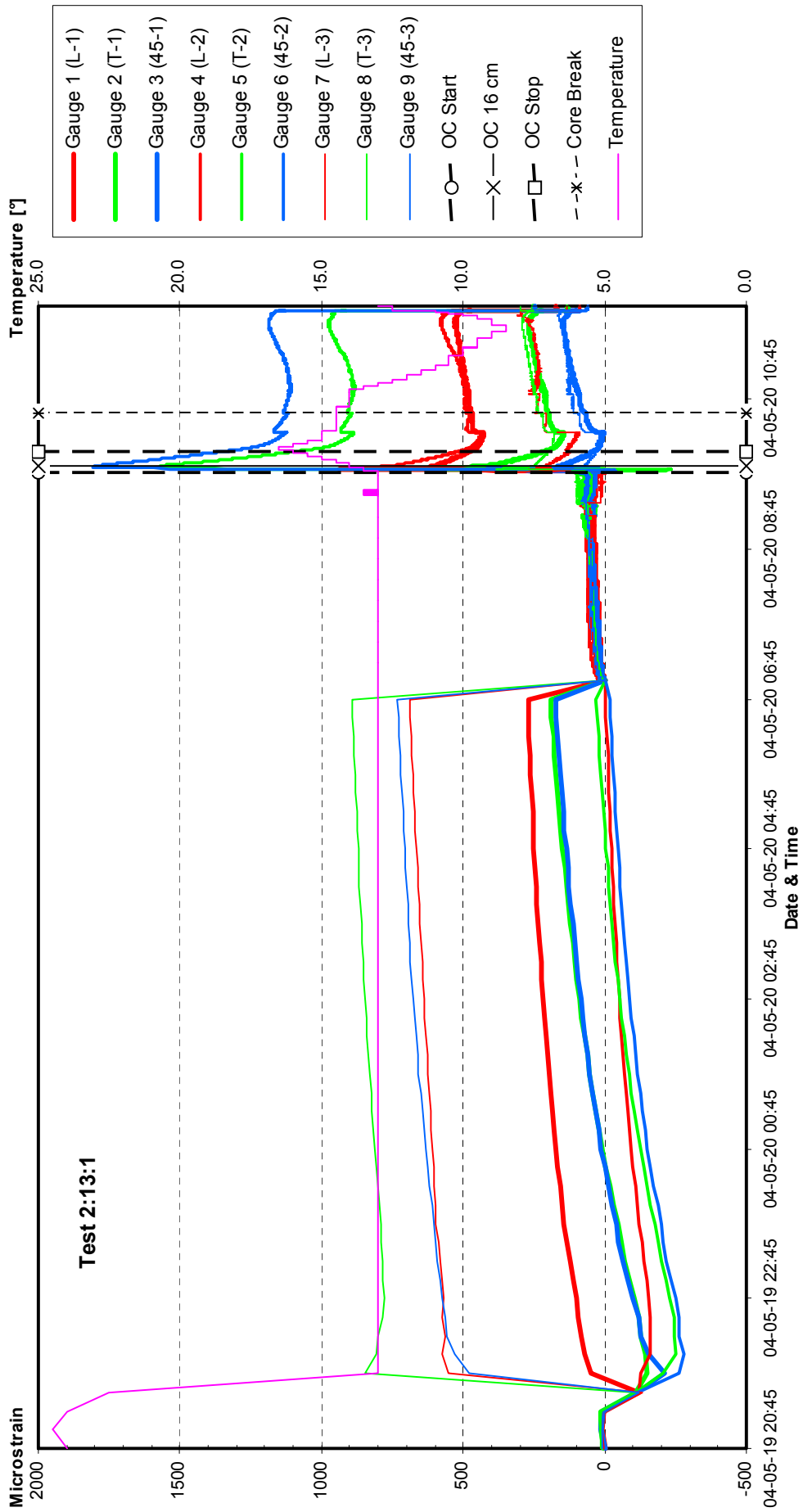

Figure B15. All recorded strain data and temperature from activation of probe to recovery from borehole for test no. 2.13:1, 449.56 m borehole length.

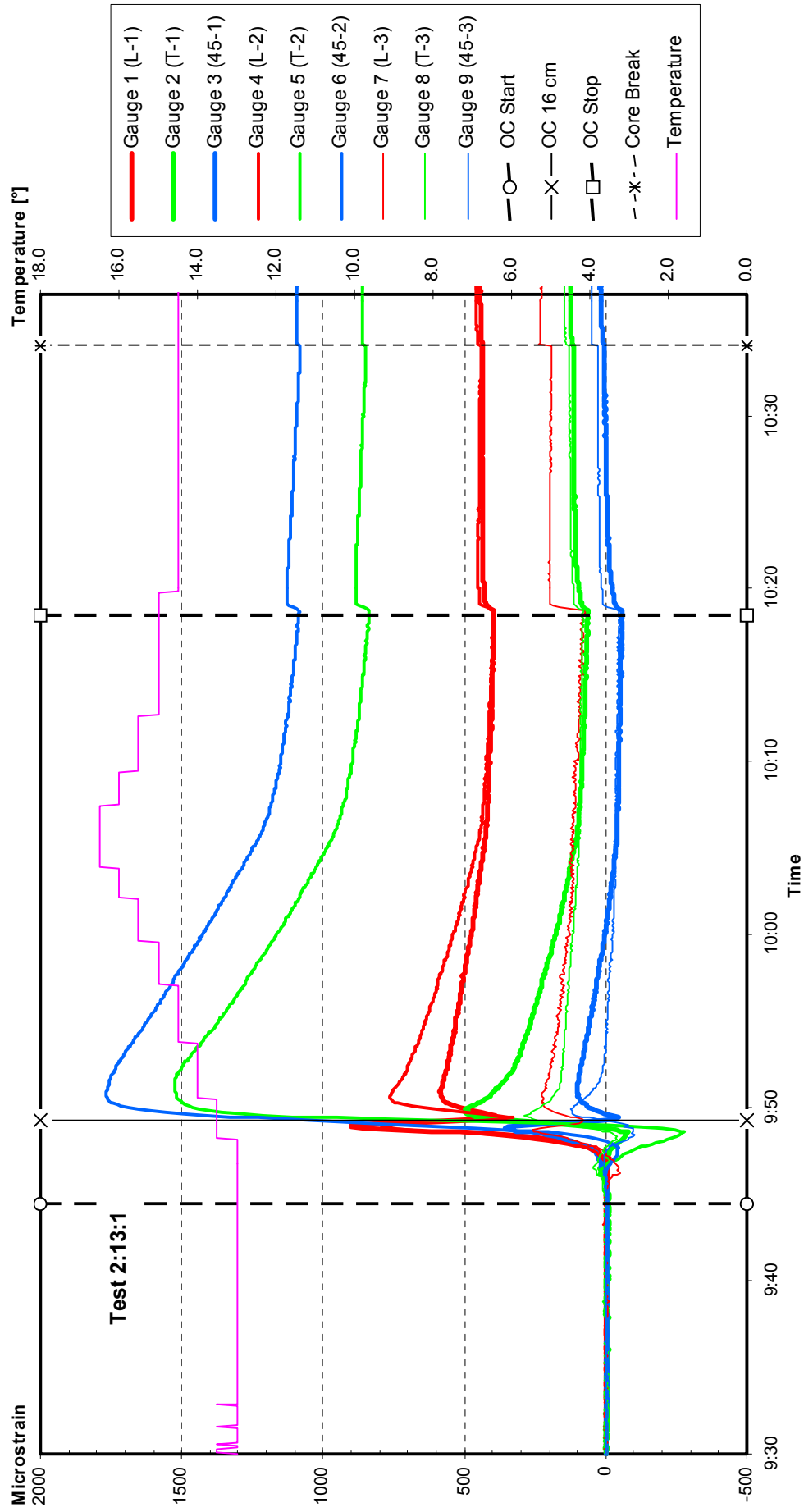

Figure B16. Recorded strain data and temperature during overcoring (from start to stop) for test no. 2:13:1, 449.56 m borehole length. Strain values reset to zero at 09:30.

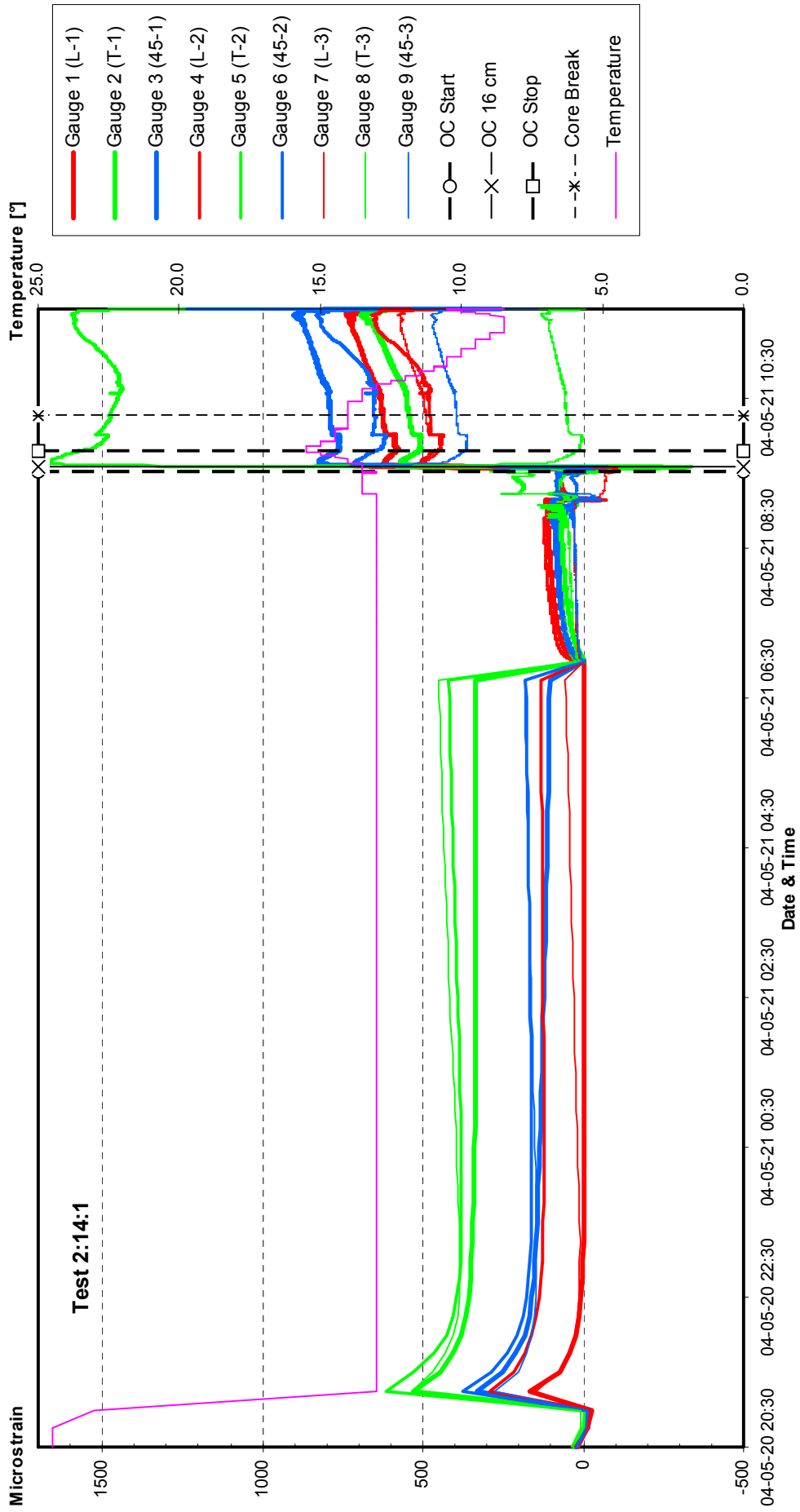

Figure B17. All recorded strain data and temperature from activation of probe to recovery from borehole for test no. 2:14:1, 450.66 m borehole length.

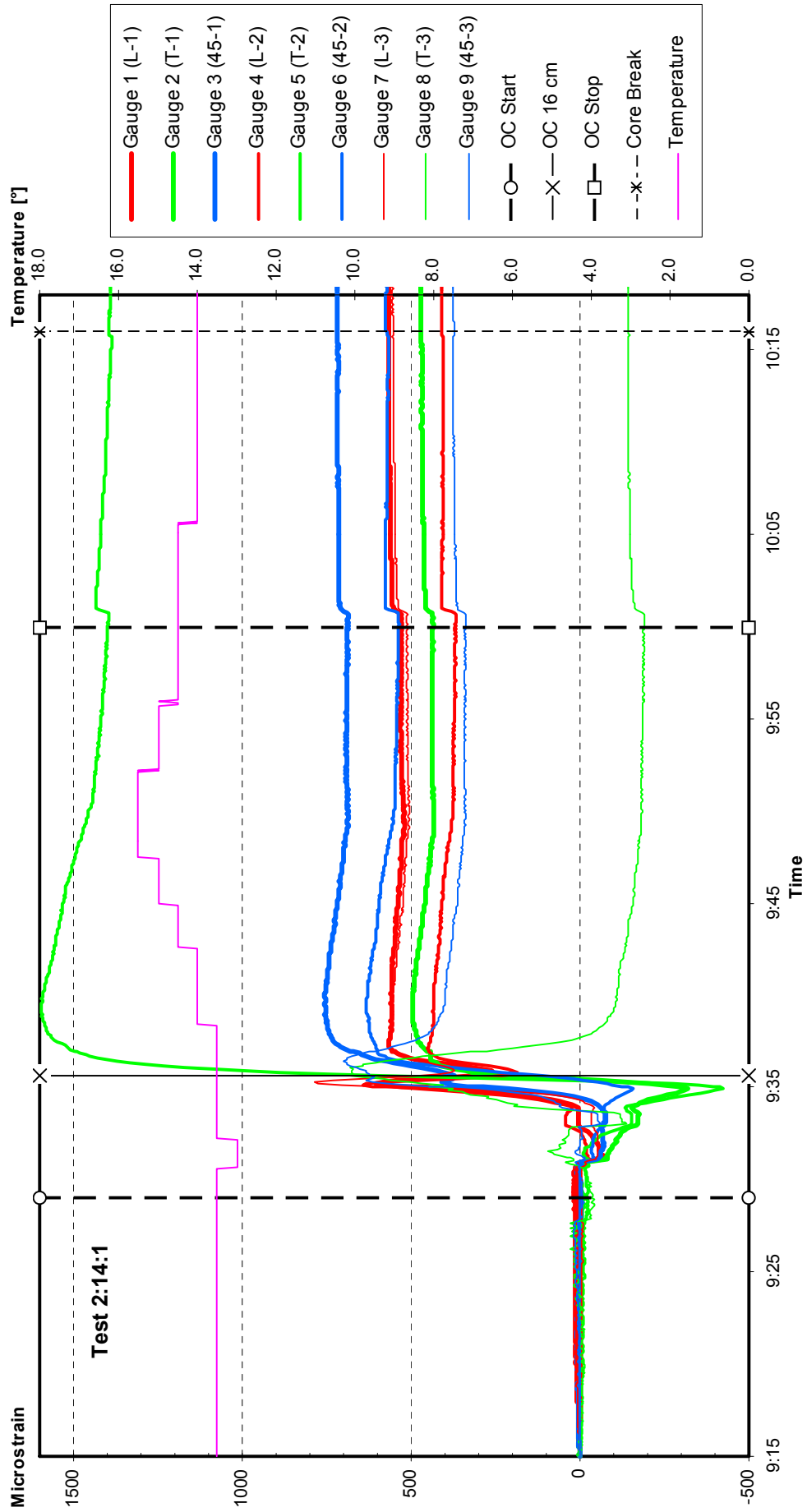

Figure B18. Recorded strain data and temperature during overcoring (from start to stop) for test no. 2:14:1, 450.66 m borehole length. Strain values reset to zero at 09:15.

Appendix C

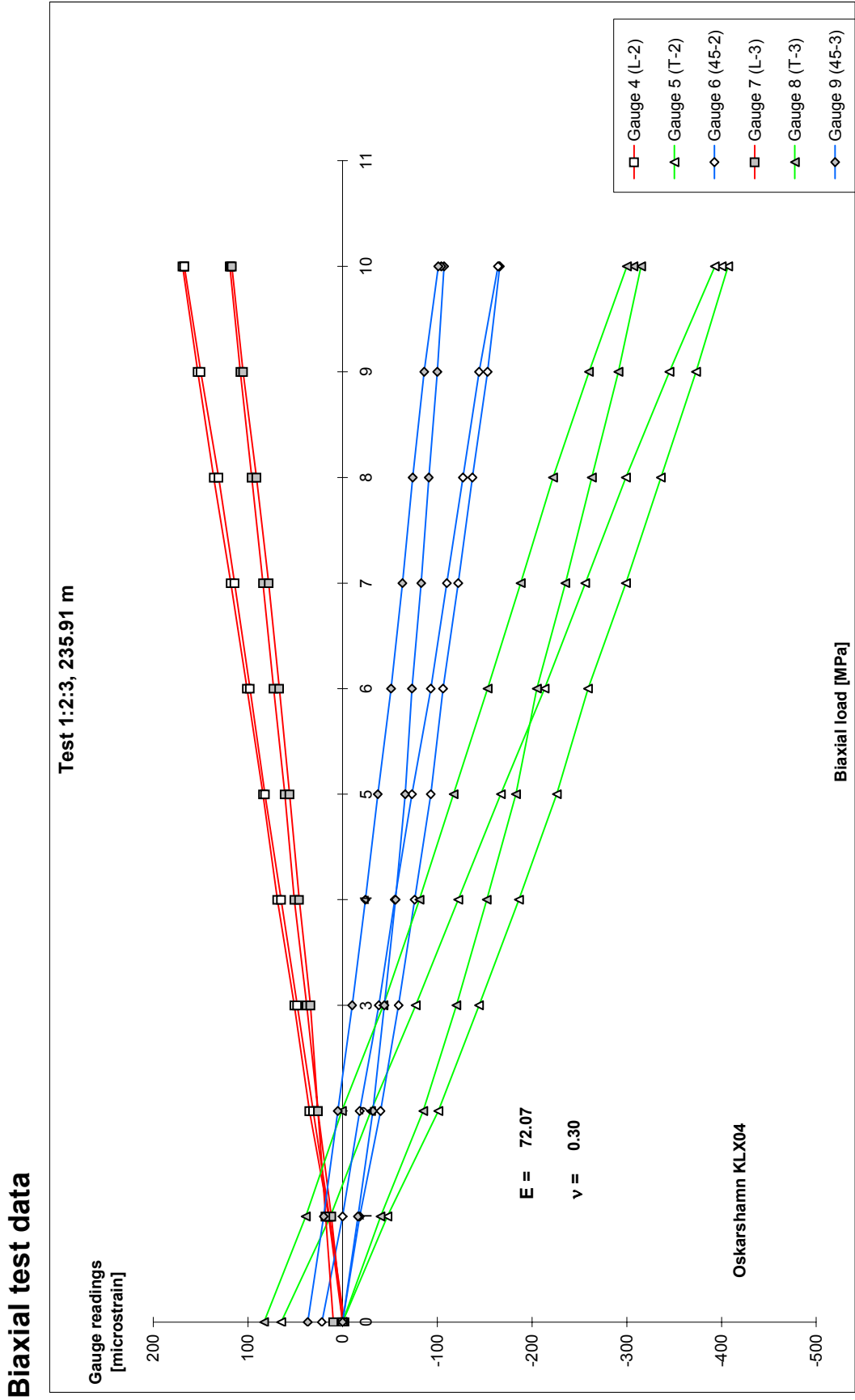

Figure C1. Results from biaxial testing of test no. 1:2:3, 235.91 m borehole length. Rosette no. 1 excluded.

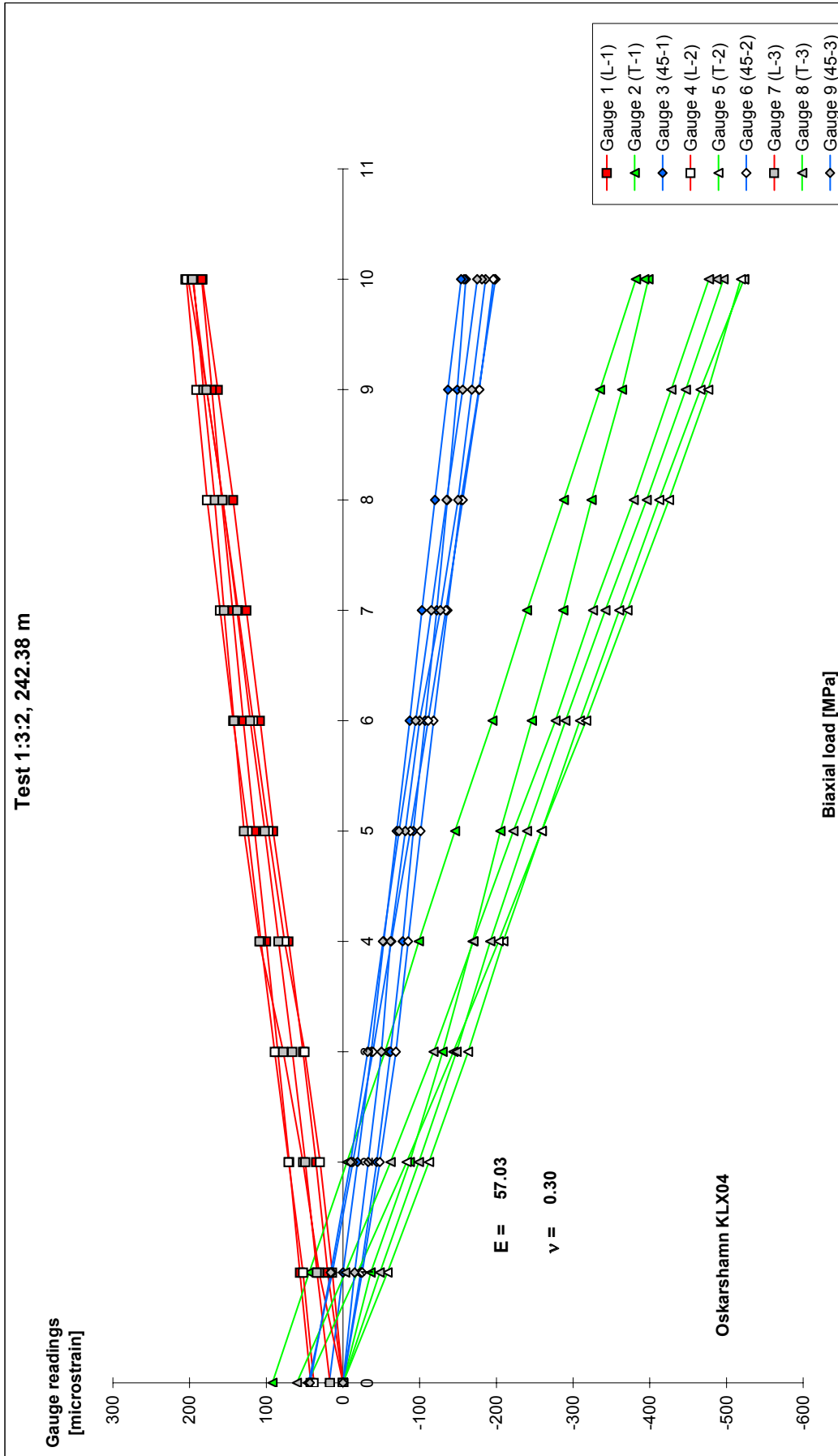

Figure C2. Results from biaxial testing of test no. 1:3:2, 242.38 m borehole length.

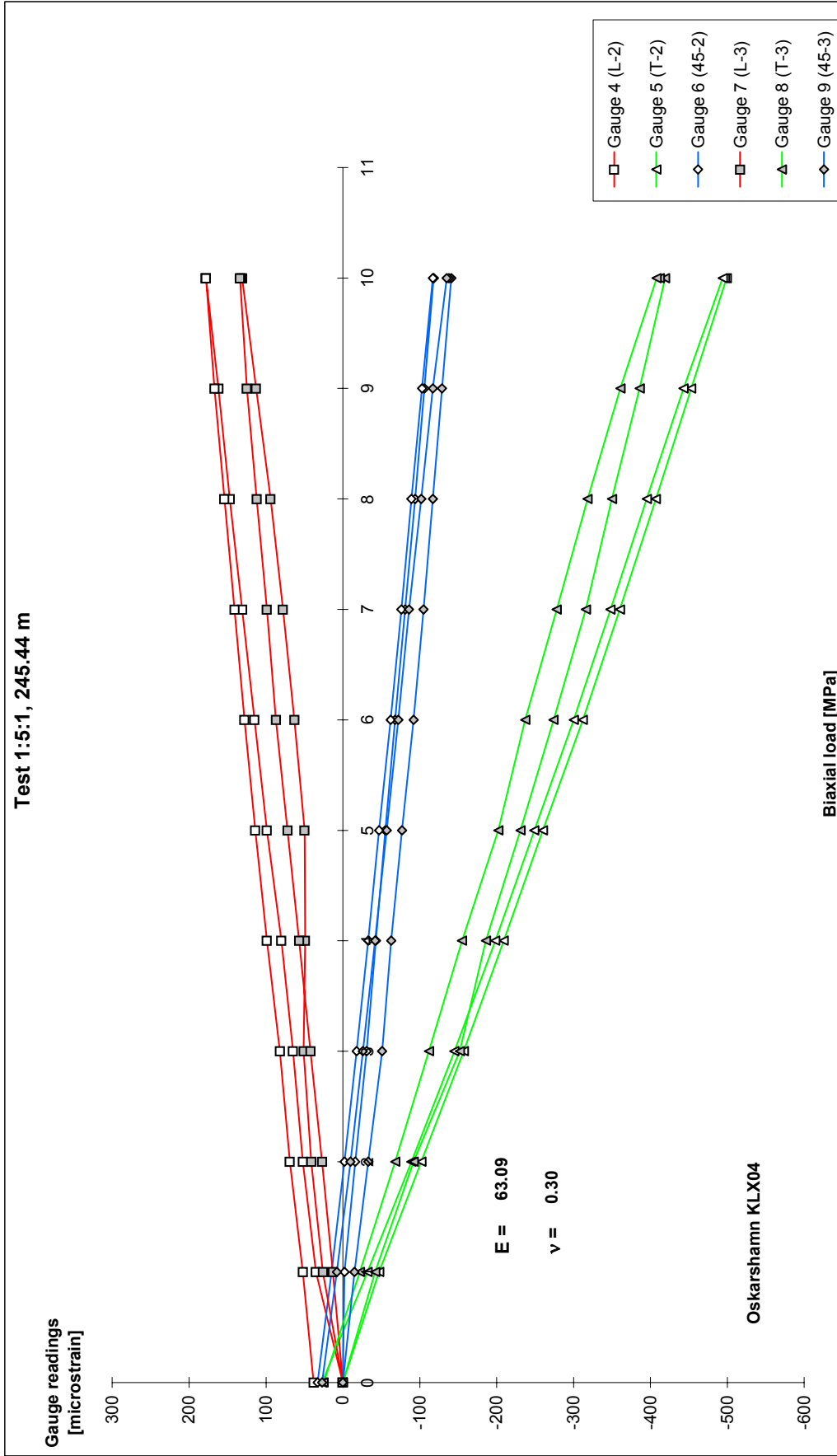

Figure C3. Results from biaxial testing of test no. 1:5:1, 245.44 m borehole length. Rosette no. 1 excluded.

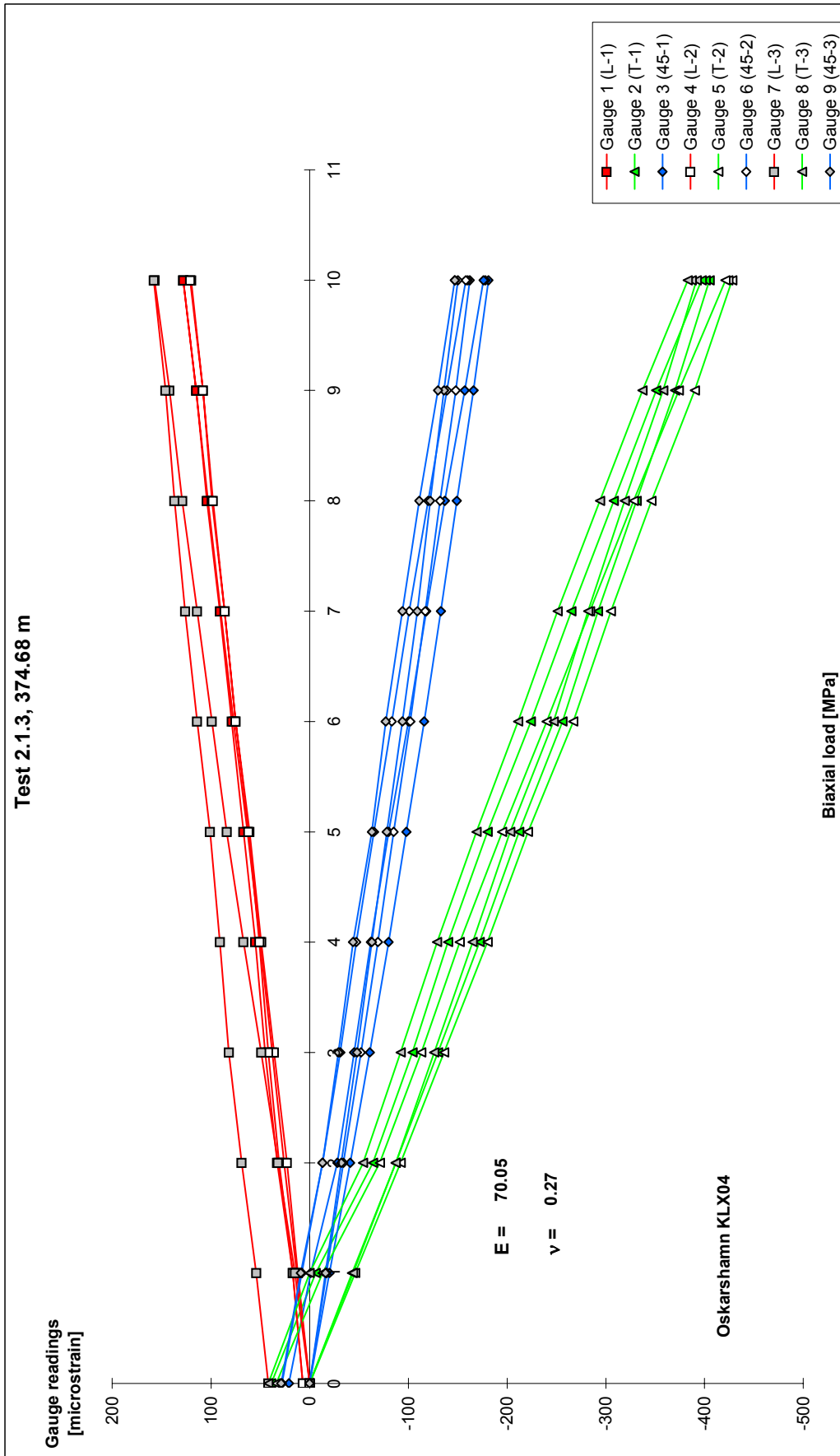

Figure C4. Results from biaxial testing of test no. 2:1:3, 374.68 m borehole length.

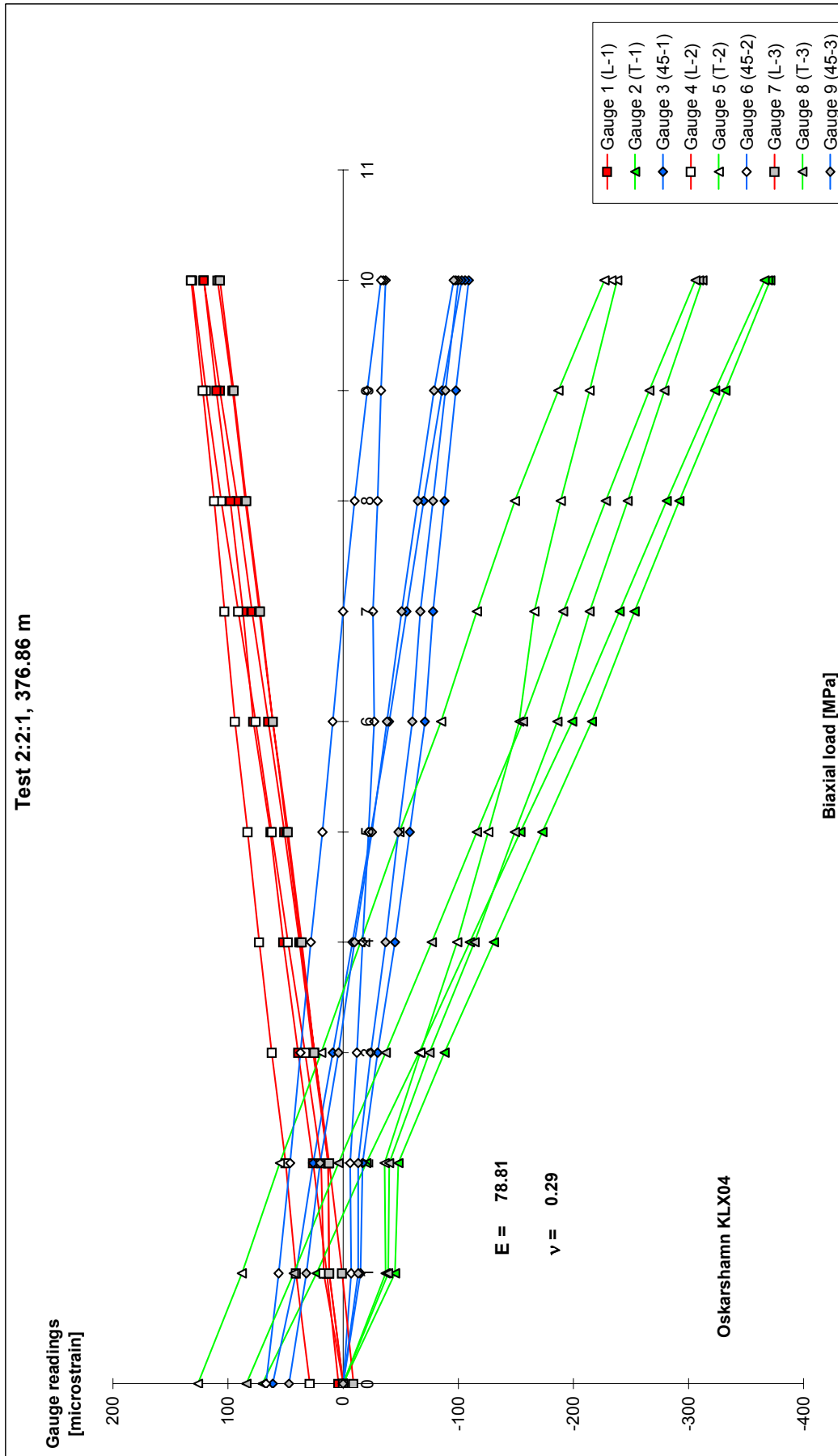

Figure C5. Results from biaxial testing of test no. 2:2:1, 376.86 m borehole length.

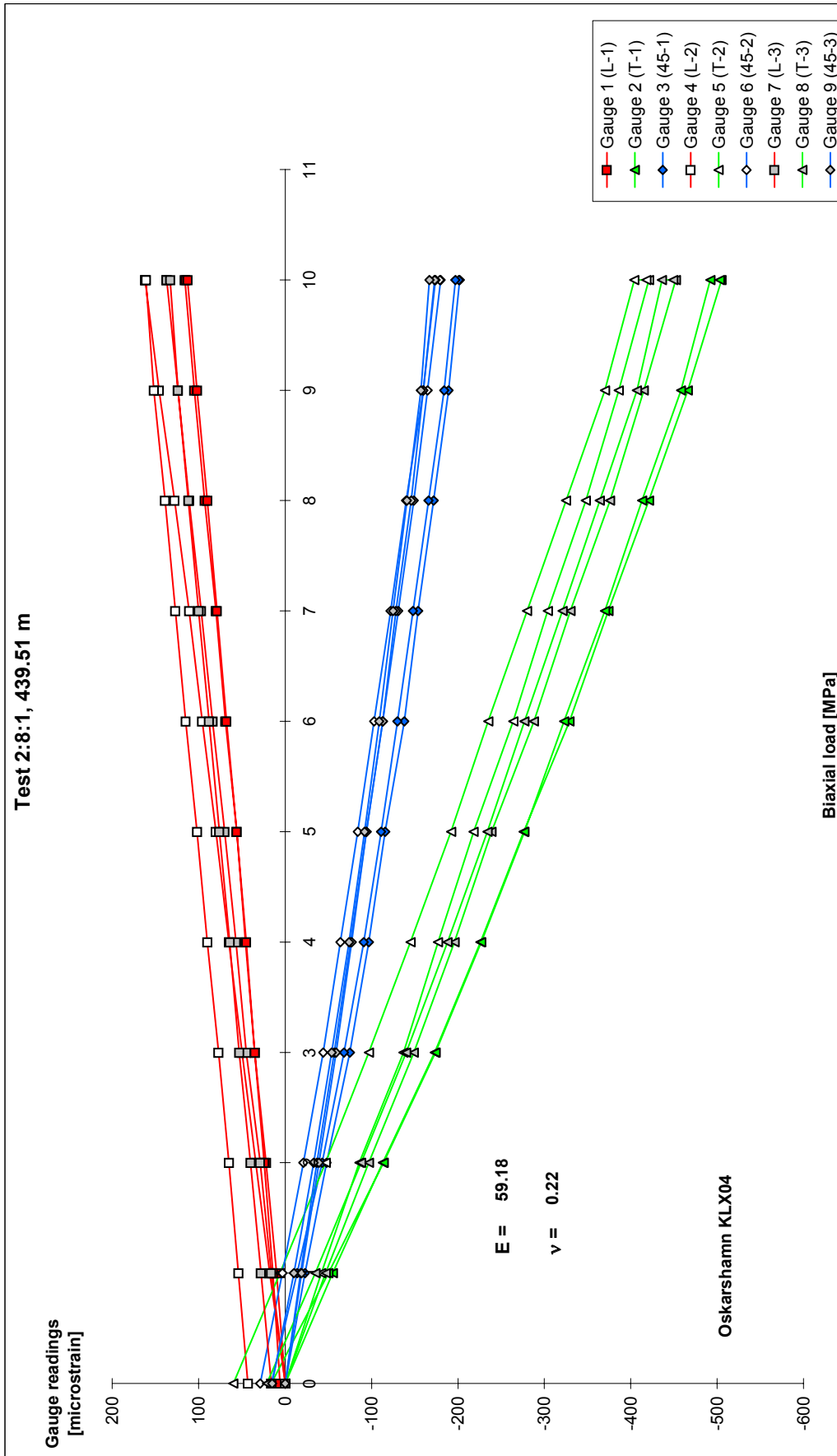

Figure C6. Results from biaxial testing of test no. 2-8:1, 439.51 m borehole length.

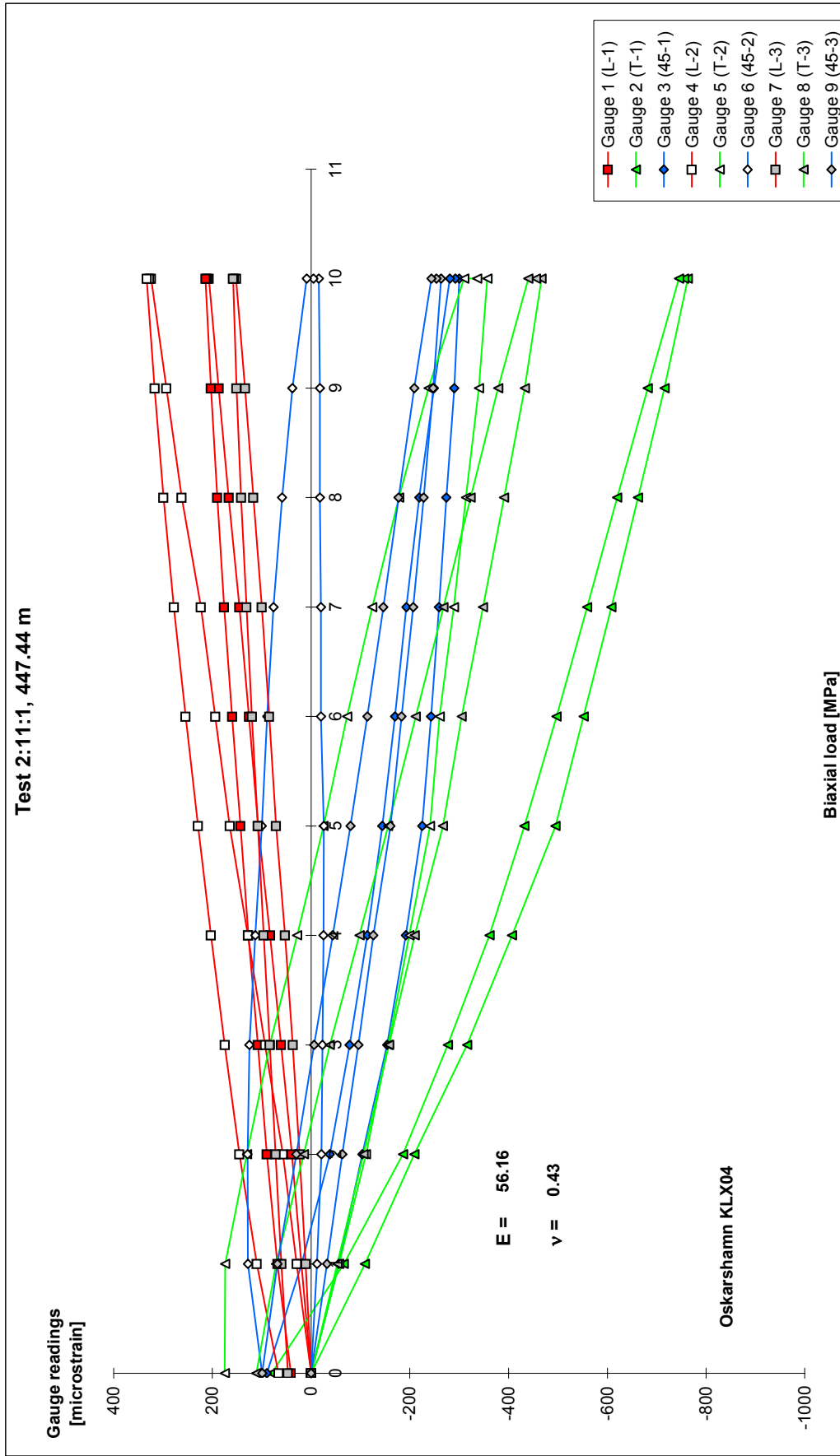

Figure C7. Results from biaxial testing of test no. 2:11:1, 447.44 m borehole length.

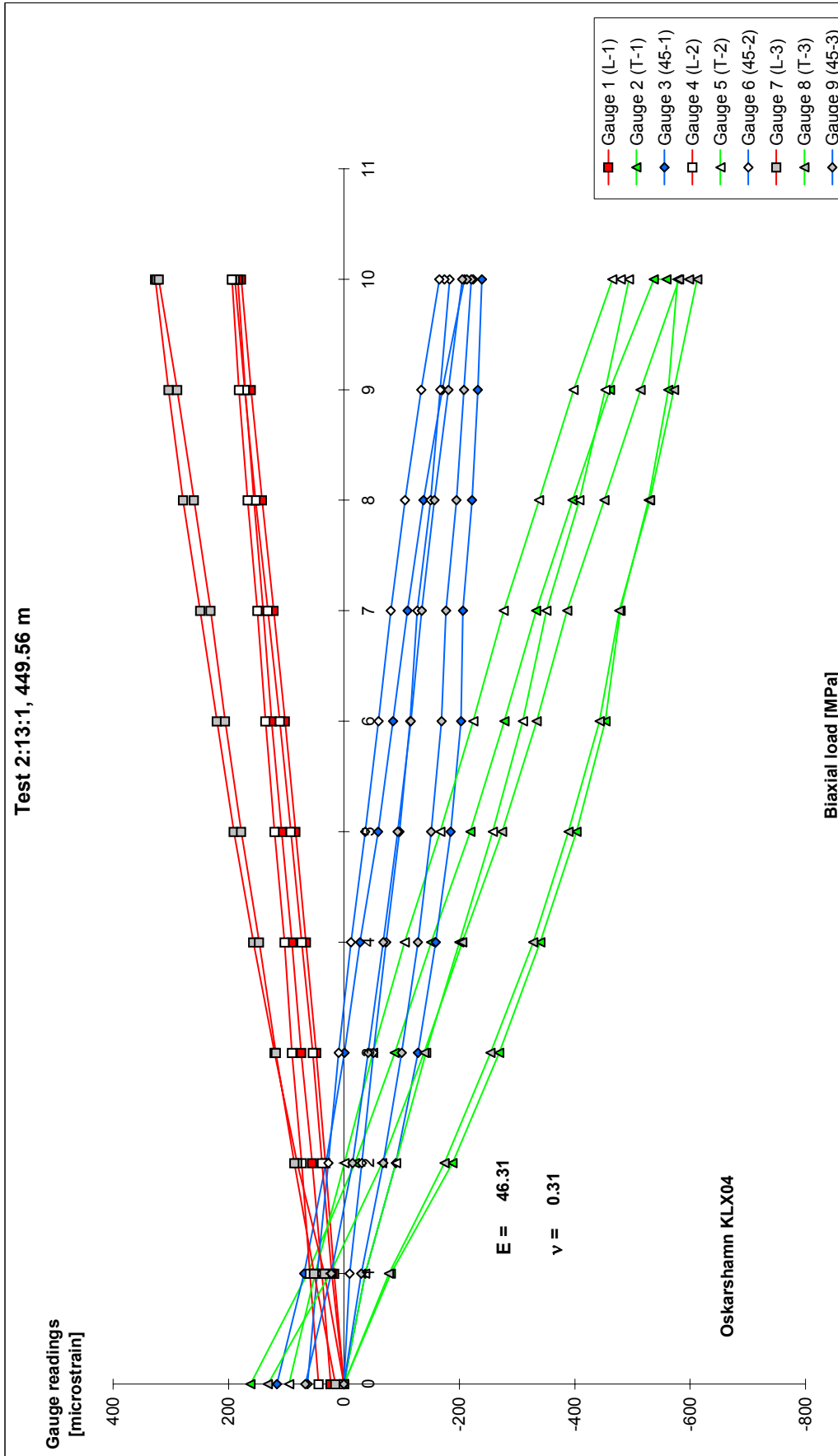

Figure C8. Results from biaxial testing of test no. 2:13:1, 449.56 m borehole length.

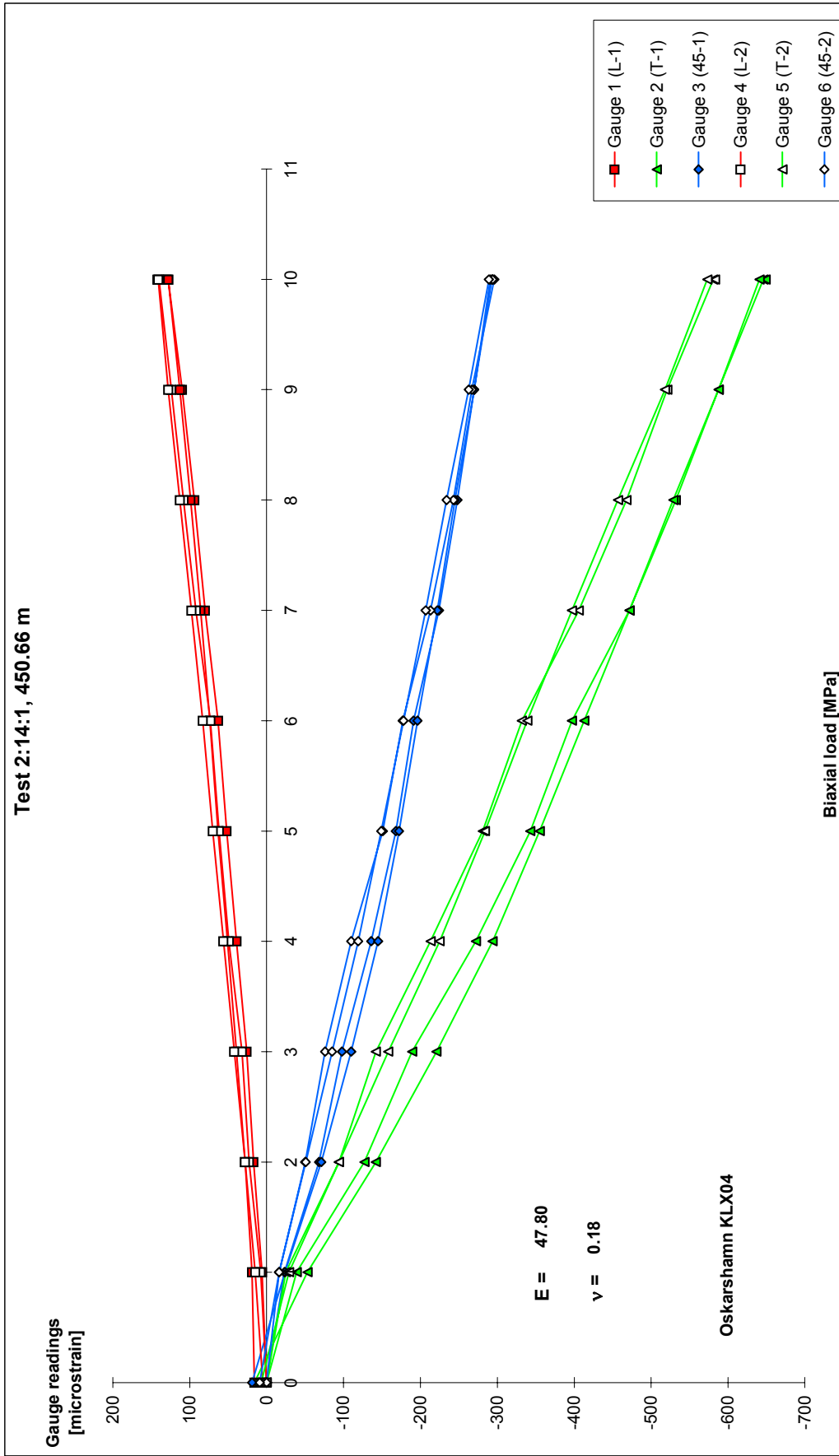

Figure C9. Results from biaxial testing of test no. 2:14:1, 450.66 m borehole length, excluding rosette no. 3.

Stress calculation input data and results

Table D1. Measured and average in situ stresses for borehole KLX04, Level 1, test no. 1:5:1 (only one successful measurement).



Project Description : Oskarshamn KLX04
 Date : 2004-09-09
 Borehole Dip : 84.2
 Borehole Bearing : 11.4
 Measurement Depth : 245.44 m

Input Data	Bearing (ball) - X [°]	Young's modulus [GPa]	Poisson's ratio	Needle bearing [°]	Overcoring Time					
					(values for gauge and resistance factor are always 2 and 1, respectively)	[hh:mm:ss]	[hh:mm:ss]			
	266	63.1	0.30	277	Start=09:00:00	Stop=09:15:45				
Strains	ϵ_{L1} (gauge no. 1) [μ strain]	ϵ_{T1} (gauge no. 2) [μ strain]	ϵ_{45_1} (gauge no. 3) [μ strain]	ϵ_{L2} (gauge no. 4) [μ strain]	ϵ_{T2} (gauge no. 5) [μ strain]	ϵ_{45_2} (gauge no. 6) [μ strain]	ϵ_{L3} (gauge no. 7) [μ strain]	ϵ_{T3} (gauge no. 8) [μ strain]	ϵ_{45_3} (gauge no. 9) [μ strain]	
	13	7	20	13	55	-23	13	167	74	
	Principal Stresses									
	σ_1 [MPa]	σ_1 - Dip [°]	σ_1 - Bearing [°]	σ_2 [MPa]	σ_2 - Dip [°]	σ_2 - Bearing [°]	σ_3 [MPa]	σ_3 - Dip [°]	σ_3 - Bearing [°]	
	4.1	12.8	206.8	2.4	58.4	95.0	0.3	28.3	303.8	
Horizontal and Vertical Stresses										
Major stress			Minor stress			Vertical stress				
σ_A [MPa]	σ_A - Bearing [°]	σ_B [MPa]	σ_B - Bearing [°]	σ_z [MPa]						
4.0	30.2	0.8	120.2	2.0						
						Error (sum of squares)	Strains re-calculated?			
						882.0	Yes			

Table D2. Measured and average in situ stresses for borehole KLX04, Level 2, test nos.. 2:11:1,2:13:1, and 2:14:1.



OVERCORING STRESS MEASUREMENTS

Project Description : Oskarshamn KLX04
 Measurement Level : 2
 Date : 2004-09-14

(values for gauge and resistance factor are always 2 and 1, respectively)

Input Data		Hole dip	Hole bearing	Bearing (ball) - X	Young's modulus	Poisson's ratio	Needle bearing	Overcoring Time		
Depth	[m]	[°]	[°]	[°]	[GPa]		[°]	[h:mm:ss]		
								Start=09:18:00		
								Stop=09:40:00		
								Start=09:44:30		
								Stop=10:18:30		
								Start=09:29:00		
								Stop=10:00:00		
447.44		84.7	28.4	360	56.2	0.43	28			
449.56		84.7	28.6	284	46.3	0.31	313			
450.66		84.7	28.7	281	47.8	0.18	310			
Strains										
Depth	[m]	ϵ_{L1} (gauge no. 1)	ϵ_{T1} (gauge no. 2)	$\epsilon_{45,1}$ (gauge no. 3)	ϵ_{L2} (gauge no. 4)	ϵ_{T2} (gauge no. 5)	$\epsilon_{45,2}$ (gauge no. 6)	ϵ_{L3} (gauge no. 7)	ϵ_{T3} (gauge no. 8)	$\epsilon_{45,3}$ (gauge no. 9)
		[μ strain]	[μ strain]	[μ strain]	[μ strain]	[μ strain]	[μ strain]	[μ strain]	[μ strain]	[μ strain]
447.44		602	416	512	-192	-148	85	343	1061	66
449.56		399	71	-53	396	844	1094	85	79	-47
450.66		512	440	687	361	1423	544	517	-156	342
Calculated Principal Stresses										
Depth	[m]	σ_1	σ_1 - Dip	σ_1 - Bearing	σ_2	σ_2 - Dip	σ_2 - Bearing	σ_3	σ_3 - Dip	σ_3 - Bearing
		[MPa]	[°]	[°]	[MPa]	[°]	[°]	[MPa]	[°]	[°]
447.44		37.0	44.4	157.3	18.3	45.1	348.6	4.9	5.7	252.9
449.56		28.2	44.8	14.6	10.1	45.2	192.5	4.5	1.0	283.5
450.66		36.1	50.6	178.1	19.7	39.4	357.7	4.8	0.2	87.9
Average		27.4	55.4	166.4	21.6	33.7	0.7	5.5	6.7	266.2
Calculated Horizontal and Vertical Stresses										
Major stress		Minor stress		Vertical stress						
Depth	[m]	σ_A	σ_A - Bearing	σ_B	σ_B - Bearing	σ_z				
		[MPa]	[°]	[MPa]	[°]	[MPa]				
447.44		27.8	160.5	5.0	70.5	27.3				
449.56		19.2	14.2	4.5	104.2	19.1				
450.66		26.3	177.9	4.8	87.9	29.5				
Average		23.4	175.2	5.8	85.2	25.3				
						Error (sum of squares)	Strains re-calculated?			
						359666.0	No			
						65830.7	No			
						15854.1	No			

Transient strain analysis results

Table E1. Results from transient strain analysis of selected overcoring measurements in borehole KLX04, Level 1.

Test no.	Hole length [m]	G1 ϵ_{L1}	G2 ϵ_{T1}	G3 ϵ_{45_1}	G4 ϵ_{L2}	G5 ϵ_{T2}	G6 ϵ_{45_2}	G7 ϵ_{L3}	G8 ϵ_{T3}	G9 ϵ_{45_3}	Unex- plained strain [%]	Max tensile stress [MPa]	Comments
1:2:3	235.91	102	51	53	77	154	58	91	271	177	13 [*] 7 ^{**}	7	Large deviation for some gauges, but generally good fit for tangential and inclined gauges in rosette nos. 2 and 3. Rosette no. 1 excluded in inverse stress estimate.
			112	90	30	25	56	57	14	14			
1:3:2	242.38	74	140	81	79	170	114	83	51	44	15	3	Poor agreement for all axial gauges, as well as all tangential gauges. Fair agreement for some of the inclined gauges.
		92	56	29	147	64	49	88	140	41			
1:5:1	245.44	54	28	47	53	63	17	42	175	89	37	4	Extremely large relative difference between calculated and measured strains (due to low absolute strain values). Absolute differences are moderate but still of concern.
		93	137	71	76	44	420	110	15	39			

*) Value with all strain rosettes included.

**) Value with strain rosette no. 1 excluded from the inverse solution.

Table E2. Results from transient strain analysis of selected overcoring measurements in borehole KLX04, Level 2.

Test no.	Hole length [m]	G1 ϵ_{L1}	G2 ϵ_{T1}	G3 $\epsilon_{45,1}$	G4 ϵ_{L2}	G5 ϵ_{T2}	G6 $\epsilon_{45,2}$	G7 ϵ_{L3}	G8 ϵ_{T3}	G9 $\epsilon_{45,3}$	Unexplained strain [%]	Max tensile stress [MPa]	Comments
2:1:3	374.68	162	573	785	343	118	290	97	324	126	8	25	Calculated and measured strains are in good agreement for most gauges, in particular in rosette no. 1. Large deviation observed for axial gauges (nos. 4 and 7)
2:2:1	376.86	391	408	340	174	190	119	378	772	877	21	30	Fairly small strain differences for the tangential gauges, but large deviations for most of the axial and of the inclined gauges.
2:8:1	439.51	151	396	128	155	137	269	260	418	222	10	10	Good agreement for tangential gauges no. 2 and 3, but larger deviations for the other gauges. Total amount of unexplained strain is acceptable though.
2:11:1	447.44	285	473	605	557	262	434	415	1,180	267	77	37	Very poor agreement between theoretical and measured strains (with the exception of gauge nos. 4 and 8). Very large total unexplained strain
2:13:1	449.56	297	275	123	416	989	1,114	554	248	317	73	19	Very large deviations between calculated and measured strains for all strain gauges. Very large total unexplained strain
2:14:1	450.66	711	593	827	614	1,620	542	470	385	408	15	26	Fair agreement for strain rosettes 1 and 2 (gauge nos. 1–6), but larger deviations for gauge nos. 7–9.

Overcore logging sheets

OVERCORE SAMPLE LOG

Borehole no., test no., depth :

KLX04, Test no. 1:2:3, 235.91 m depth

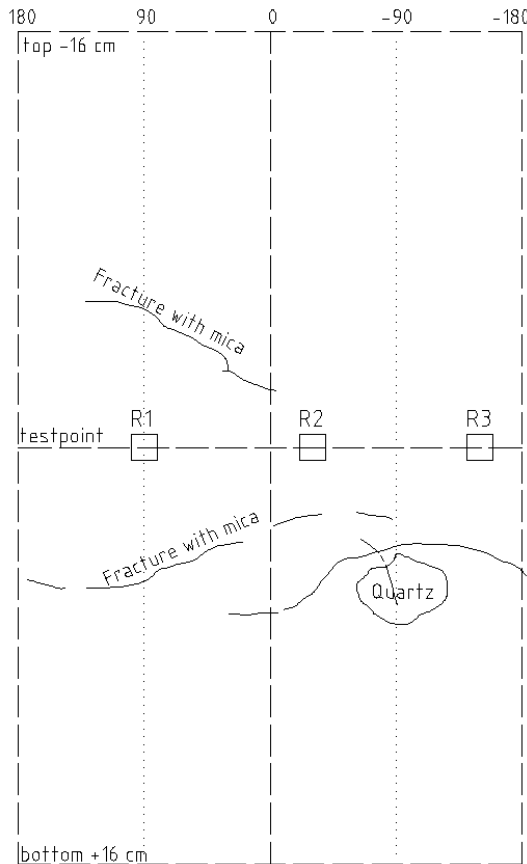

Angle clockwise in borehole direction

rosette 1 =+90 degrees

rosette 2 =-30 degrees

rosette 3 =-150 degrees

GEOLOGY

Granite, uniform

Ävrö granite /Kisiel 2004/.

STRUCTURES (JOINTS)

Mica-filled fractures.

Mark any observed fractures

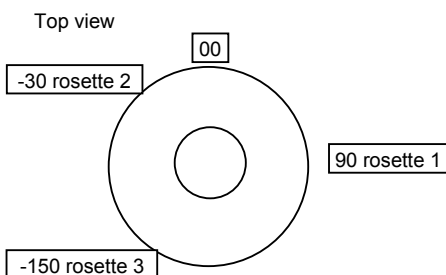

COMMENTS

Strain gauge orientation OK.

Control of strain gauge orientation

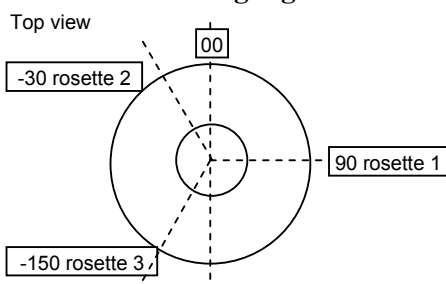

Use special tool to check that strain gauges are 120 degrees apart. Mark any deviations in the figure.

OVERCORE SAMPLE LOG

Borehole no., test no., depth :

KLX04, Test no. 1:3:2, 242.38 m depth

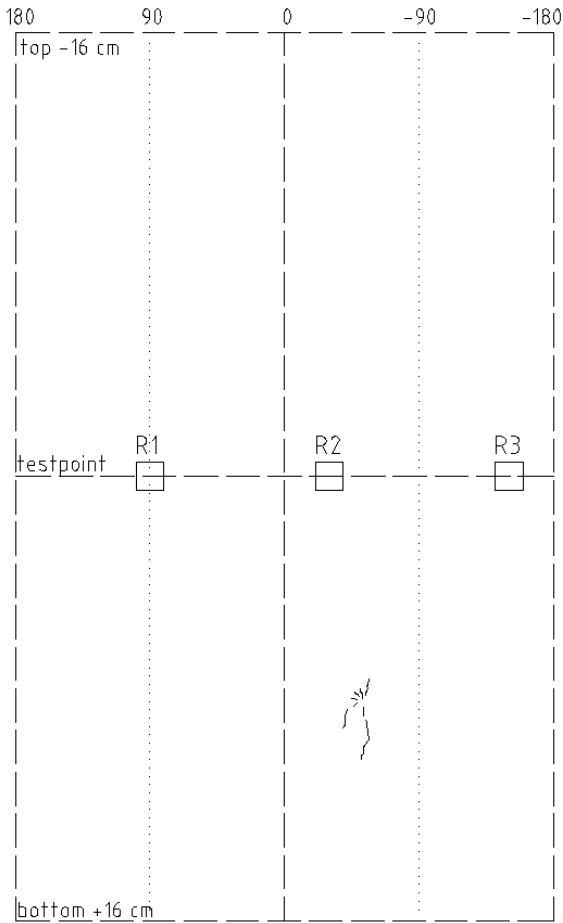

Angle clockwise in borehole direction
 rosette 1 = +90 degrees
 rosette 2 = -30 degrees
 rosette 3 = -150 degrees

GEOLOGY

-
Ävrö granite /Kisiel 2004/.

STRUCTURES (JOINTS)

No fractures before or after biaxial testing.

Mark any observed fractures

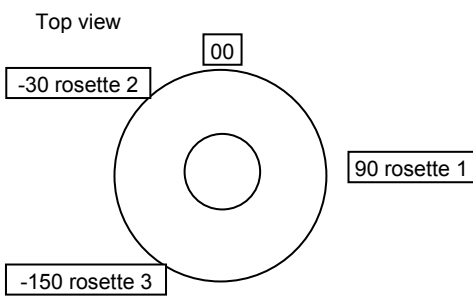

COMMENTS

Strain gauge orientation OK but 4 cm higher up in pilot hole.

Control of strain gauge orientation

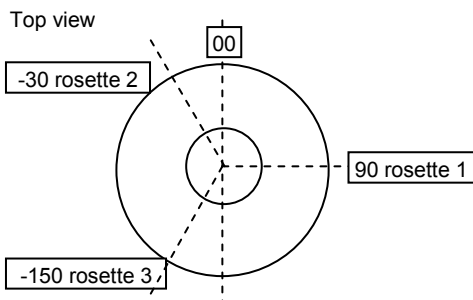

Use special tool to check that strain gauges are 120 degrees apart. Mark any deviations in the figure.

OVERCORE SAMPLE LOG

Borehole no., test no., depth :

KLX04, Test no. 1:5:1, 245.44 m depth

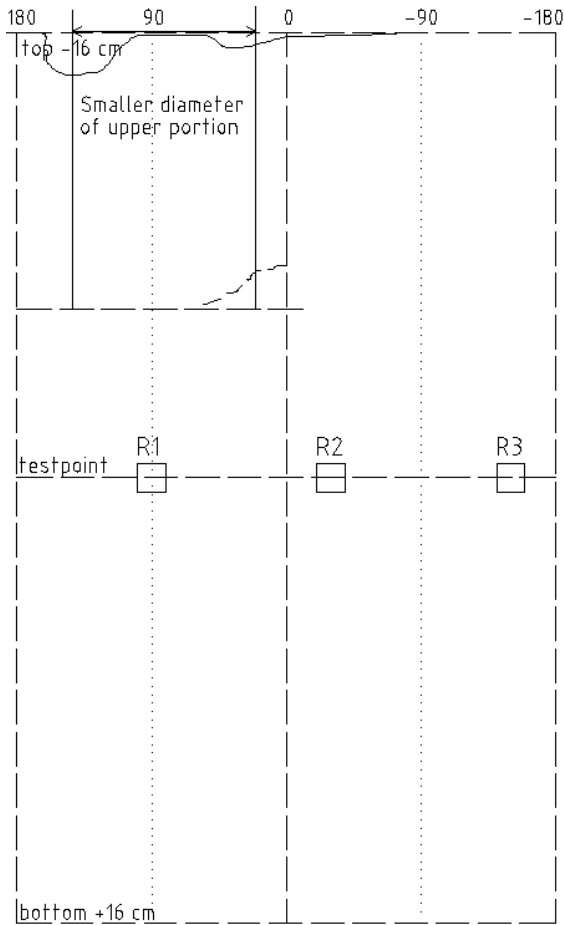

Angle clockwise in borehole direction
 rosette 1 =+90 degrees
 rosette 2 =-30 degrees
 rosette 3 =-150 degrees

GEOLOGY

Granite
Ävrö granite /Kisiel 2004/.

STRUCTURES (JOINTS)

No fractures before or after biaxial testing.

Mark any observed fractures

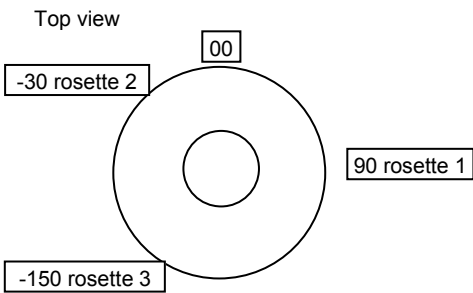

COMMENTS

Strain gauge orientation OK.
 Upper part (10.8 cm length) of sample had a smaller diameter (50.2 mm) caused by the inner tube of the pilot hole equipment not being securely fixed during overcoring.

Control of strain gauge orientation

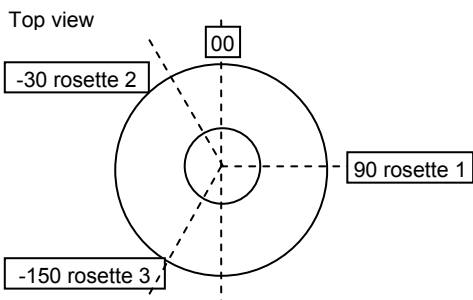

Use special tool to check that strain gauges are 120 degrees apart. Mark any deviations in the figure.

OVERCORE SAMPLE LOG

Borehole no., test no., depth :

KLX04, Test no. 2:1:3, 374.68 m depth

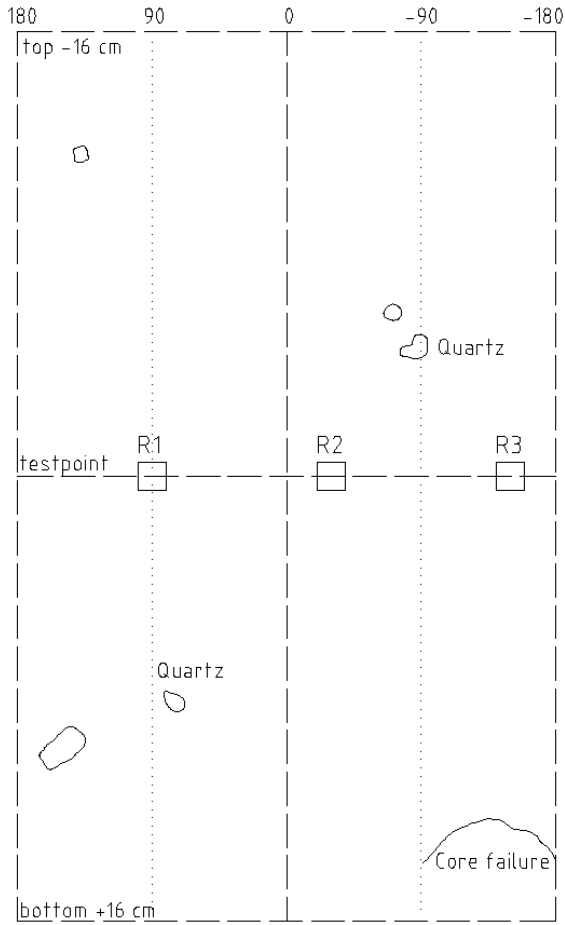

Angle clockwise in borehole direction

rosette 1 = +90 degrees

rosette 2 = -30 degrees

rosette 3 = -150 degrees

GEOLOGY

Granite

Ävrö granite /Kisiel 2004/.

STRUCTURES (JOINTS)

No joints observed before or after biaxial testing.

Mark any observed fractures

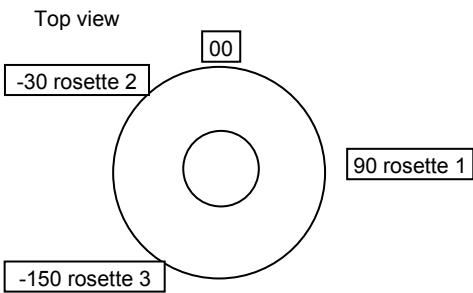

COMMENTS

Strain gauge orientation OK.

Control of strain gauge orientation

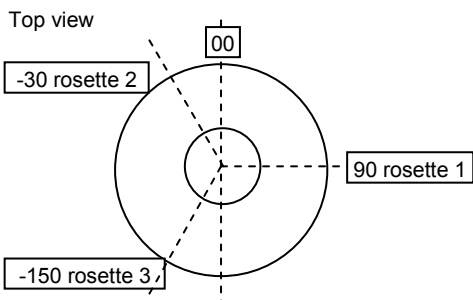

Use special tool to check that strain gauges are 120 degrees apart. Mark any deviations in the figure.

OVERCORE SAMPLE LOG

Borehole no., test no., depth :

KLX04, Test no. 2:2:1, 376.86 m depth

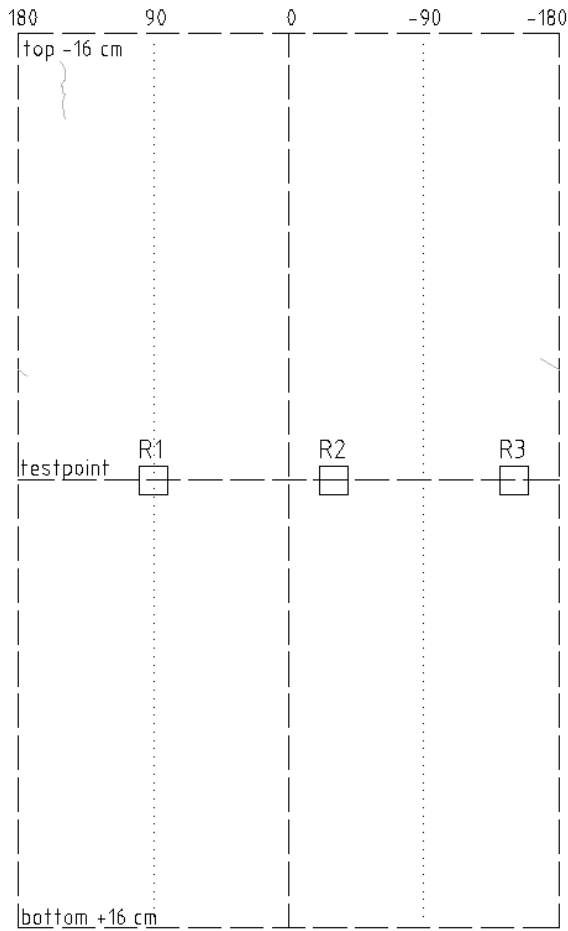

Angle clockwise in borehole direction

rosette 1 =+90 degrees

rosette 2 =-30 degrees

rosette 3 =-150 degrees

GEOLOGY

Granite

Ävrö granite /Kisiel 2004/.

STRUCTURES (JOINTS)

No fractures before or after biaxial testing.

Mark any observed fractures

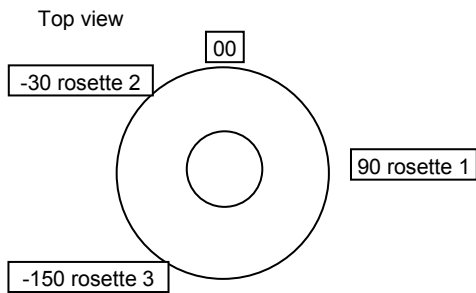

COMMENTS

Strain gauge orientation OK.

Control of strain gauge orientation

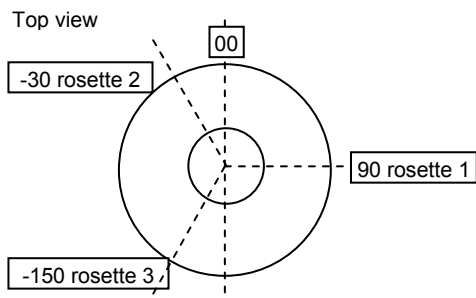

Use special tool to check that strain gauges are 120 degrees apart. Mark any deviations in the figure.

OVERCORE SAMPLE LOG

Borehole no., test no., depth :

KLX04, Test no. 2:8:1, 439.51 m depth

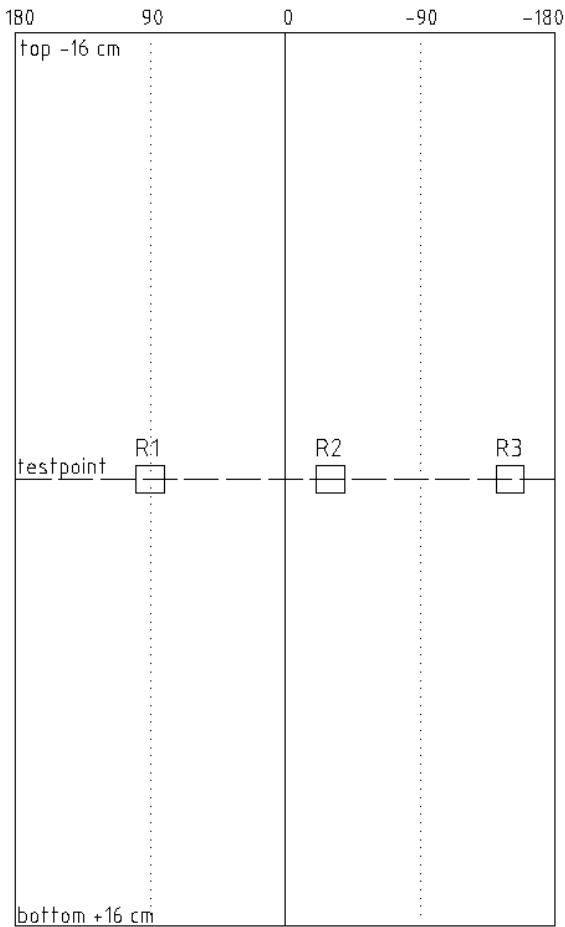

Angle clockwise in borehole direction

rosette 1 = +90 degrees

rosette 2 = -30 degrees

rosette 3 = -150 degrees

GEOLOGY

Granite

Ävrö granite /Kisiel 2004/.

STRUCTURES (JOINTS)

No fractures before or after biaxial testing.

Mark any observed fractures

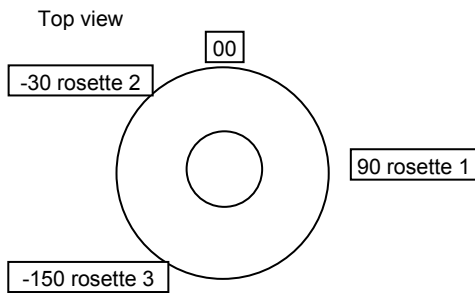

COMMENTS

Strain gauge orientation OK.

Control of strain gauge orientation

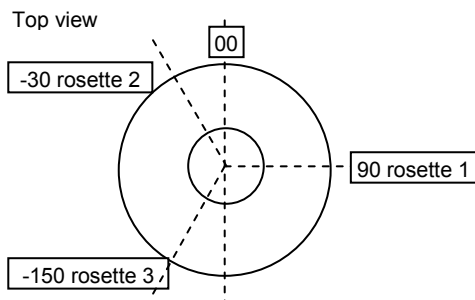

Use special tool to check that strain gauges are 120 degrees apart. Mark any deviations in the figure.

OVERCORE SAMPLE LOG

Borehole no., test no., depth :

KLX04, Test no. 2:11:1, 447.44 m depth

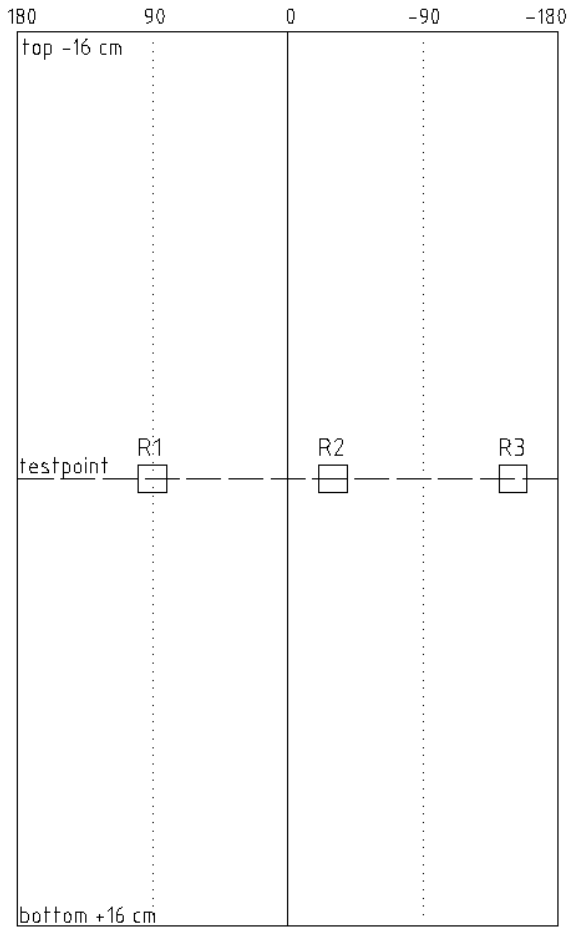

Angle clockwise in borehole direction

rosette 1 =+90 degrees

rosette 2 =-30 degrees

rosette 3 =-150 degrees

GEOLOGY

-
Ävrö granite /Kisiel 2004/.

STRUCTURES (JOINTS)

No fractures before or after biaxial testing.

Mark any observed fractures

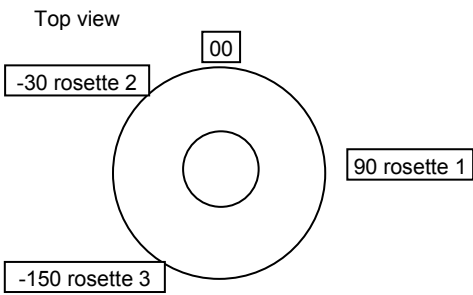

COMMENTS

Strain gauge orientation OK.

Control of strain gauge orientation

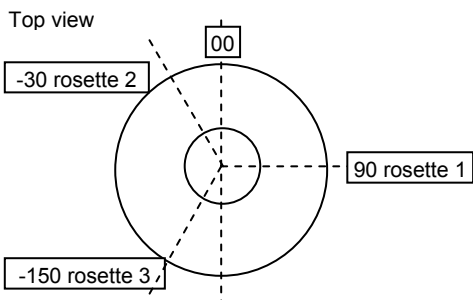

Use special tool to check that strain gauges are 120 degrees apart. Mark any deviations in the figure.

OVERCORE SAMPLE LOG

Borehole no., test no., depth :

KLX04, Test no. 2:13:1, 449.56 m depth

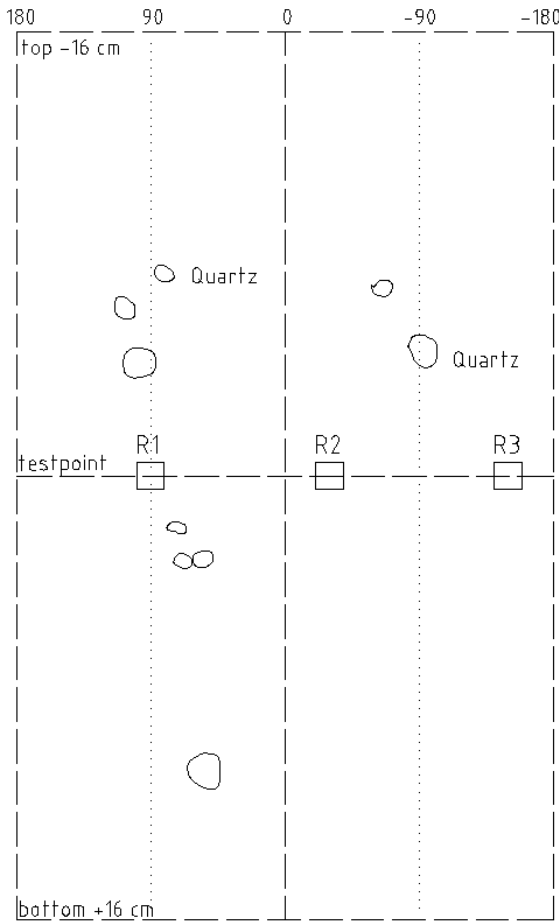

Angle clockwise in borehole direction
 rosette 1 =+90 degrees
 rosette 2 =-30 degrees
 rosette 3 =-150 degrees

GEOLOGY

Diorite
Ävrö granite /Kisiel 2004/.

STRUCTURES (JOINTS)

No fractures before or after biaxial testing.

Mark any observed fractures

COMMENTS

Strain gauge orientation OK.

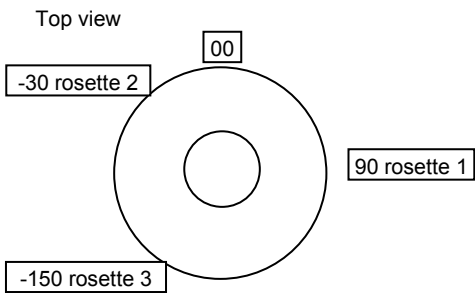

Control of strain gauge orientation

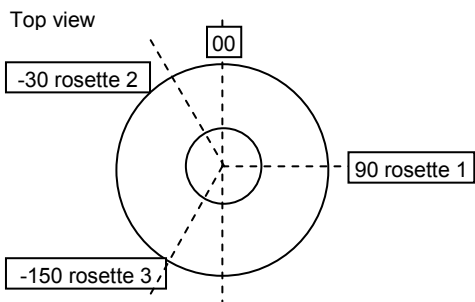

Use special tool to check that strain gauges are 120 degrees apart. Mark any deviations in the figure.

OVERCORE SAMPLE LOG

Borehole no., test no., depth :

KLX04, Test no. 2:14:1, 450.66 m depth

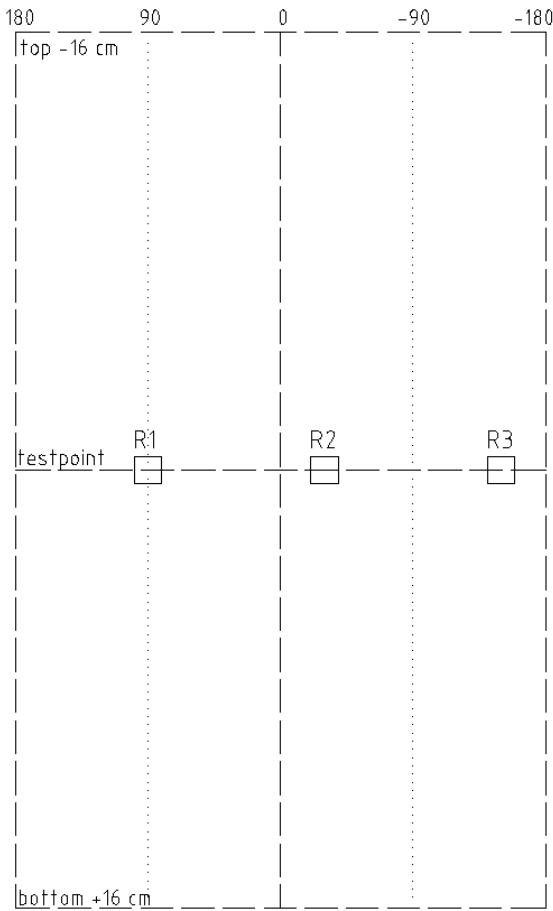

Angle clockwise in borehole direction

- rosette 1 =+90 degrees
- rosette 2 =-30 degrees
- rosette 3 =-150 degrees

GEOLOGY

Diorite

Ävrö granite /Kisiel 2004/.

STRUCTURES (JOINTS)

No fractures before or after biaxial testing.

Mark any observed fractures

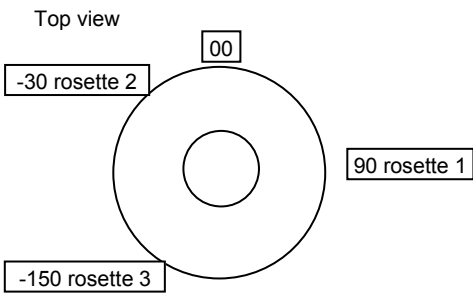

COMMENTS

Strain gauge orientation OK.

Control of strain gauge orientation

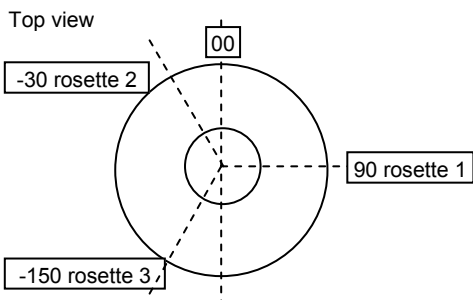

Use special tool to check that strain gauges are 120 degrees apart. Mark any deviations in the figure.

Photos of core samples

1:2:3, 235.91 m — pilot core

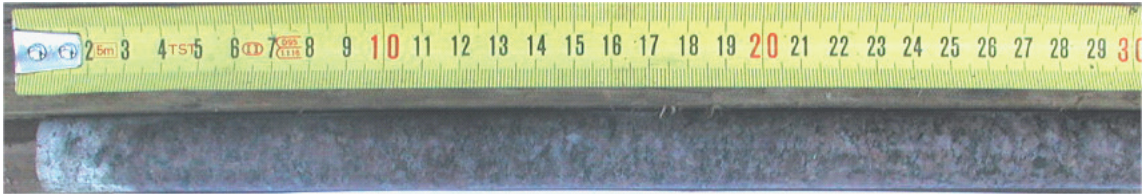

1:2:3, 235.91 m — overcore sample (30 cm)



1:3:2, 242.38 m — pilot core (30 cm)

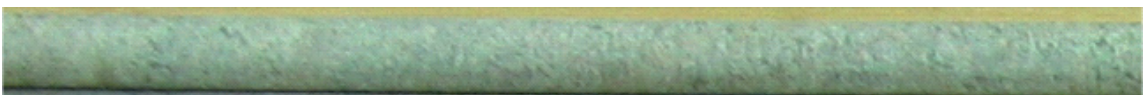

1:3:2, 242.38 m — overcore sample (30 cm)



1:5:1, 245.44 m — pilot core (30 cm)



1:5:1, 245.44 m — overcore sample (30 cm)



Figure G1. Photos of pilot core and overcore sample for borehole KLX04, Level 1.

Photos of core samples

1:2:3, 235.91 m — pilot core



1:2:3, 235.91 m — overcore sample (30 cm)



1:3:2, 242.38 m — pilot core (30 cm)

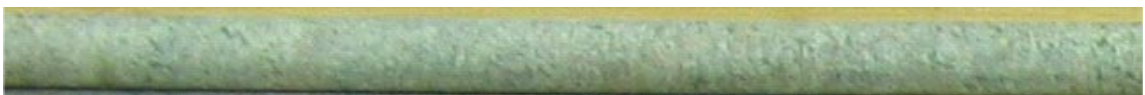

1:3:2, 242.38 m — overcore sample (30 cm)



1:5:1, 245.44 m — pilot core (30 cm)



1:5:1, 245.44 m — overcore sample (30 cm)



Figure G1. Photos of pilot core and overcore sample for borehole KLX04, Level 1.

2:1:3, 374.68 m — pilot core



2:1:3, 374.68 m — overcore sample (30 cm)



2:2:1, 376.86 m — pilot core



2:2:1, 376.86 m — overcore sample (30 cm)



2:8:1, 439.51 m — pilot core (fractures occurred during core handling)



2:8:1, 439.51 m — overcore sample (30 cm)

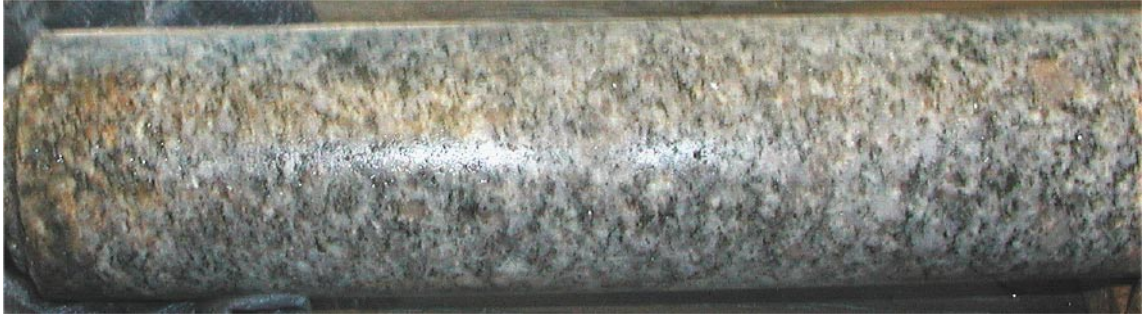

Figure G2. Photos of pilot core and overcore sample for borehole KLX04, Level 2.

2:11:1, 447.44 m — pilot core



2:11:1, 447.44 m — overcore sample (30 cm)



2:13:1, 449.56 m — pilot core (30 cm)



2:13:1, 449.56 m — overcore sample (30 cm)



2:14:1, 450.66 m — pilot core



2:14:1, 450.66 m — overcore sample (30 cm)



Figure G3. (concluded.)

Confidence intervals for measured stresses

Table H1. 90%-confidence intervals for the principal stresses as determined from overcoring measurements in borehole KLX04.

Level		Magnitude and Trend/Plunge of principal stresses					
		σ_1		σ_2		σ_3	
		[MPa]	[°]	[MPa]	[°]	[MPa]	[°]
Level 1	Average	5.4	065/13	3.2	174/54	1.8	327/33
	90% lower	3.3	*)	1.0	*)	-2.7	*)
	90% upper	12.6		4.5		3.0	
Level 2	Average	27.4	166/55	21.6	001/34	5.5	266/07
	90% lower	18.0	*)	5.7	*)	-3.8	*)
	90% upper	56.6		28.5		5.9	

*) All orientation data presented in Figure H1 and Figure H2.

Table H2. 90%-confidence intervals for the horizontal and vertical stress components as determined from overcoring measurements in borehole KLX04.

Level		σ_H [MPa]	σ_h [MPa]	σ_v [MPa]	Trend σ_H [°]
Level 1	Average	5.3	2.2	2.9	063
	90% lower	1.8	-2.0	1.2	*)
	90% upper	12.0	4.0	4.7	
Level 2	Average	23.4	5.8	25.3	175
	90% lower	12.0	1.8	4.9	*)
	90% upper	36.6	7.3	46.1	

*) All orientation data presented in Figure H5.

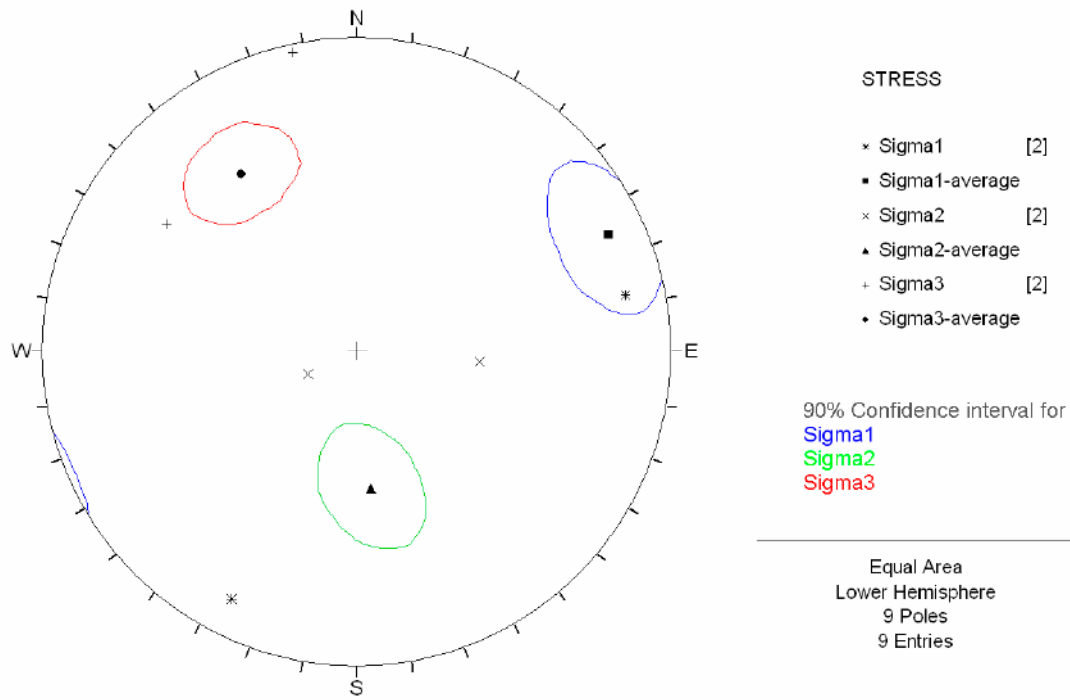

Figure H1. 90%-confidence interval for the orientation of the principal stresses in borehole KLX04, Level 1, shown in a lower hemisphere projection.

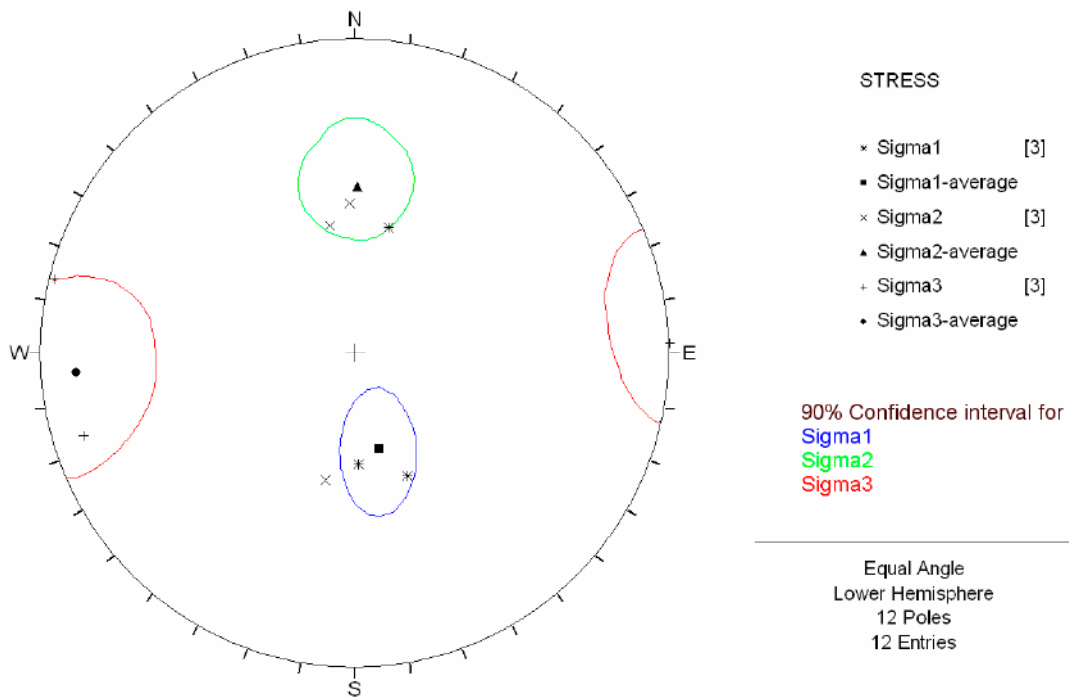

Figure H2. 90%-confidence interval for the orientation of the principal stresses in borehole KLX04, Level 2, shown in a lower hemisphere projection.

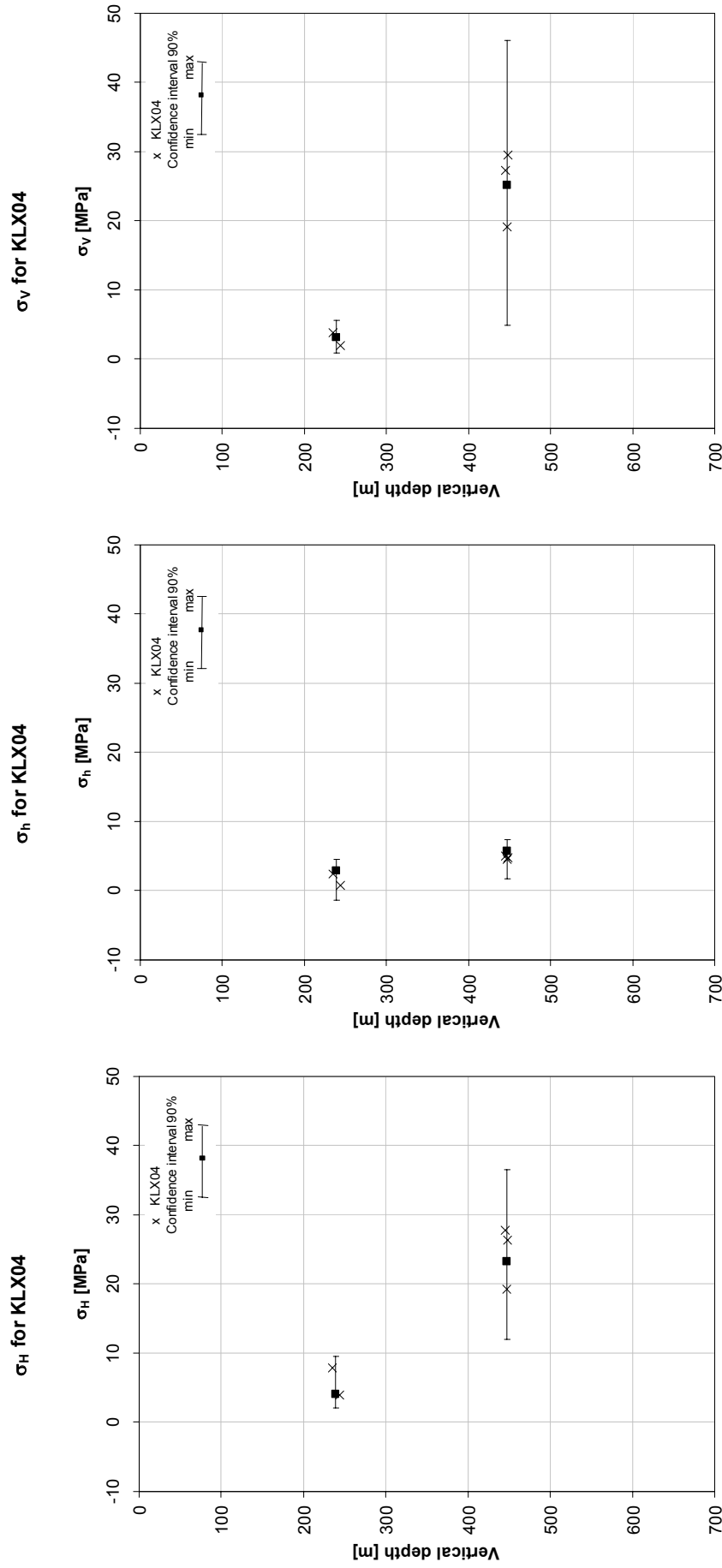

Figure H3. Average values (■-markers) and 90%-confidence intervals (|---|) for the horizontal and vertical stress components, shown together with measured values for each measurement level (x-markers) in borehole KLX04.

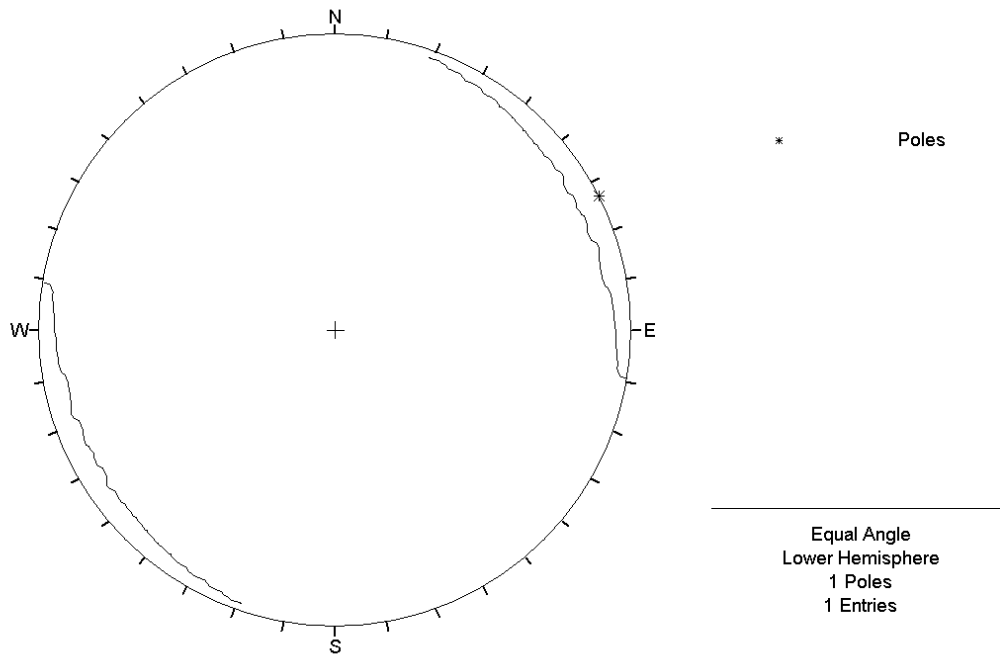

Figure H4. 90%-confidence interval for the orientation of the maximum horizontal stress for Level 1 in borehole KLX04, shown in a lower hemisphere projection.

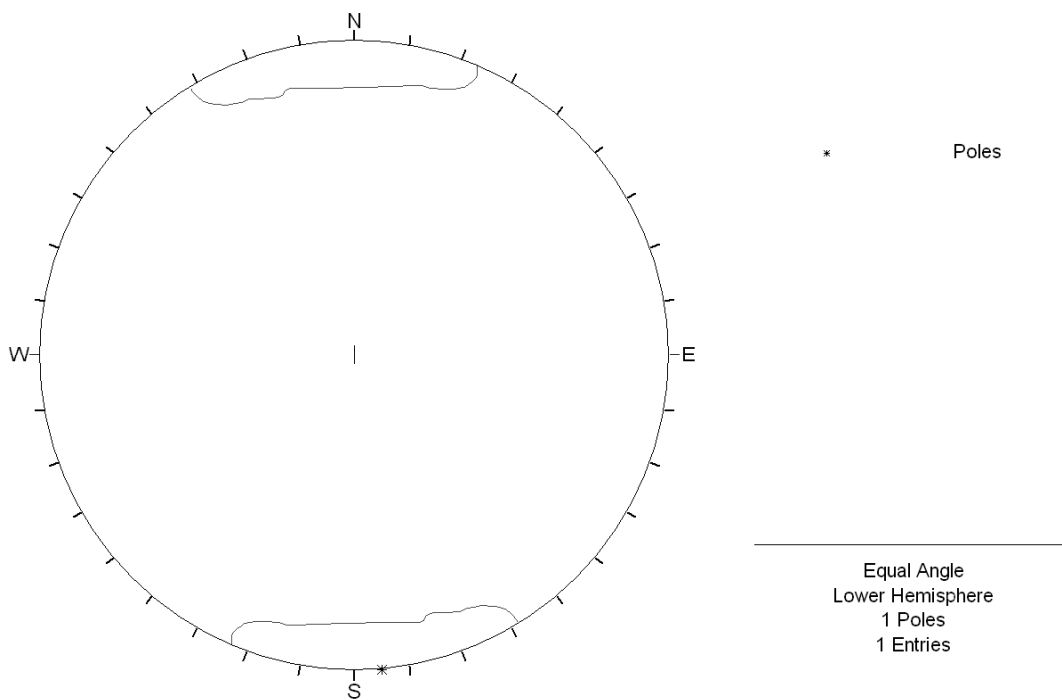

Figure H5. 90%-confidence interval for the orientation of the maximum horizontal stress for Level 2 in borehole KLX04, shown in a lower hemisphere projection.

Quality operating procedures for overcoring measurements

The following quality operating procedures are adhered to when conducting overcoring rock stress measurements using the *Borre* probe. A complete description of each procedure with adjoining checklists, can be obtained (on request) from the measurement contractor.

Pre-mobilization equipment assembly and checking

- Strain gauges assembly,
 - Visual check of geometry,
 - Check of glued parts,
 - Visual check of wires and resistance measurement.
- Glue test on new batches.
- Computer and software.
- Packing and transport.
 - Equipment.
 - Consumable supplies.

Mobilization

- Mobilization on site.
- Drilling contractor contacts, instructions for operation, etc.
- Function test of the *Borre* probe.
- Function test of biaxial load cell and pump.
- Function test of installation tool (adapter).
- Function test of computer and computer programs.
- Glue test (if required by the client).
- Function test and control of drilling equipment.

Overcoring stress measurement procedure

- Pilot hole drilling and examination.
 - Planing and drilling of pilot hole.
 - Examination of pilot core and decision on installation (or not).
 - Flushing and checking the pilot hole with dummy probe.
- Preparation of the *Borre*-cell.
 - Attaching strain gauges, including resistance check and geometry check.
 - Function test of *Borre* probe with attached gauges.
- Installation of *Borre* probe.
 - Function test of installation tool (adapter).
 - Glue application including thickness and application check.
- Overcoring.
 - Check glue hardening time.
 - Check that no activity is on-going in the borehole.
 - Retrieval of adapter.
 - Drill string in place and marked every 4 cm (0–32 cm).

- Flushing and overcoring activities according to specification list.
- Retrieval of drill string and *Borre* probe.
- Recovery of the *Borre* probe.
 - Orientation of probe installation recorded.
 - Data collection (transfer to computer from logger).
- Logging and photography of overcore sample.
- Biaxial testing of the overcore sample.
 - Test setup and programming of logger (*Borre* probe).
 - Biaxial testing
 - Data collection (transfer to computer from logger).
 - Logging of overcore sample after biaxial testing.

Evaluation and analysis

- Plotting of overcoring and biaxial test data on computer.
- Data assessment (reliability, sources of error, rating).
- Stress calculation for successful measurements; average stresses calculated for each measurement level.
- Continuous reporting to client.

Demobilization

- Packing and transport.

Final reporting

- Complementary data assessment and rating of tests.
- Final stress calculation.
- Transient strain analysis on selected tests.
- Calculation of final stress averages.
- Final reporting to client.