

SKB

**TECHNICAL
REPORT**

95-21

**Conceptual model for concrete long
time degradation in a deep nuclear
waste repository**

Björn Lagerblad, Jan Trägårdh

Swedish Cement and Concrete Research Institute

February 1994

SVENSK KÄRNBRÄNSLEHANTERING AB

SWEDISH NUCLEAR FUEL AND WASTE MANAGEMENT CO

P.O.BOX 5864 S-102 40 STOCKHOLM SWEDEN

PHONE +46 8 665 28 00 TELEX 13108 SKB

FAX +46 8 661 57 19

CONCEPTUAL MODEL FOR CONCRETE LONG TIME DEGRADATION IN A DEEP NUCLEAR WASTE REPOSITORY

Björn Lagerblad, Jan Trägårdh

Swedish Cement and Concrete Research Institute

February 1994

This report concerns a study which was conducted for SKB. The conclusions and viewpoints presented in the report are those of the author(s) and do not necessarily coincide with those of the client.

Information on SKB technical reports from 1977-1978 (TR 121), 1979 (TR 79-28), 1980 (TR 80-26), 1981 (TR 81-17), 1982 (TR 82-28), 1983 (TR 83-77), 1984 (TR 85-01), 1985 (TR 85-20), 1986 (TR 86-31), 1987 (TR 87-33), 1988 (TR 88-32), 1989 (TR 89-40), 1990 (TR 90-46), 1991 (TR 91-64), 1992 (TR 92-46), 1993 (TR 93-34) and 1994 (TR 94-33) is available through SKB.

Conceptual model for concrete long time degradation in a deep nuclear waste repository

Björn Lagerblad and Jan Trägårdh

**Swedish Cement and Concrete Research Institute
100 44 Stockholm, Sweden.**

February 1994

Keywords: Nuclear waste repository, concrete degradation, alkali-silica reactions, sulphate attack, chloride diffusion, carbonation, cement chemistry, groundwater chemistry

Abstract

This report is mainly a state-of-the-art report of concrete long time durability in the environment expected in a deep site underground nuclear waste repository in Swedish crystalline bedrock. Some of the results referred to have been produced during research at CBI, Stockholm.

The report treats how the concrete and the surrounding groundwater will interact and how they will be affected by cement chemistry, type of aggregate etc. The different mechanisms for concrete alteration treated in the report include sulphate attack, carbonation, chloride attack, alkali-silica reaction and leaching phenomena.

In a long time perspective, the chemical alterations in concrete is mainly goverened by the surrounding groundwater composition. After closure the composition of the groundwater will change character from a modified meteoric to a saline composition. Therefore two different simulated groundwater compositions (ALLARD and NASK water) have been used in modelling the chemical interaction between concrete and groundwater.

The report also includes a study of old and historical concrete which show observations concerning recrystallization phenomena in concrete.

A conceptual model for concrete degradation in a KBS-3 repository is presented.

Sammanfattning

Denna rapport behandlar betongs beständighet sett i ett långt tidsperspektiv och i den miljö som kan förväntas existera i ett bergrum för djupförvar av kärnbränsleavfall i svensk berggrund. Undersökningen är huvudsakligen baserad på data från litteraturen, men innehåller även forskningsresultat från CBI.

Betongen och cementpastans sammansättning kommer att påverkas av det omgivande grundvattnet. Eftersom det kommer att ske en utjämning mellan betongens porlösningar och grundvattnet kommer även grundvattnets sammansättning att påverkas. De olika typer av omvandlingsmekanismer som behandlas i rapporten är sulfatattack, karbonatisering, kloridattack, alkalisilikareaktioner och urlakningseffekter.

I ett långt tidsperspektiv styrs de kemiska omvandlingarna i cementpastan huvudsakligen av det omgivande grundvattnets sammansättning. Omvandlingar i cementpastan inkluderar bildning av nya faser, omkristallisering av gamla faser och urlakning. Grundvattnets sammansättning kommer att ändra karaktär från en något modifierad ytvattensammansättning till saltvatten. I arbetet med att ta fram en modell för hur betongen och grundvattnet påverkar varandra har därför två olika simulerade grundvattensammansättningar använts (ALLARD-och NASK-vatten).

Rapporten innefattar även en studie av omkristalliserings och urlakningsfenomen i gammal och historisk betong.

En modell för hur betong omvandlas och bryts ner i ett KBS-3 förvar presenteras.

TABLE OF CONTENTS

Abstract	i
Sammanfattning	ii
Summary	vi
Chapter 1: <i>Introduction</i>	
1.1 Orientation	1
1.2 General assumptions about the type of concrete	1
1.3 The geochemical environment of the repository	2
1.4 Different applications of concrete and the environments	4
1.4.1 Structural concrete	4
1.4.2 Shotcrete	5
1.4.3 Grouted cement mortar	5
1.5 Degradation processes in general	6
Chapter 2: <i>Structure of hardened cement paste</i>	
2.1 Cement composition	7
2.2 Structure of cement paste	8
2.3 Hydration products of cement	9
Chapter 3: <i>Carbon dioxide attack, carbonation</i>	
3.1 Orientation	14
3.2 Consequences for degradation in the repository	15
Chapter 4: <i>Sulphate attack, stability of the sulphate phases</i>	
4.1 Orientation	17
4.2 Consequences for degradation in the repository	19

Chapter 5: Chloride attack, stability of the chloride phases

5.1	Introduction	21
5.2	Consequences for degradation in the repository	22

Chapter 6: Stability of the cement phase in aqueous fluids

6.1	Introduction	27
6.2	Permeability and leaching of Ca(OH)_2 and C-S-H phases	28
6.2.1	Permeability and porosity	28
6.2.2	Leaching of Ca(OH)_2 and calcium silicate phases	31
6.3	Consequences for degradation in the repository	38

Chapter 7: Stability of the aggregate phase: Cement - aggregate reactions

7.1	Introduction	43
7.2	Factors controlling the alkali silica reaction (ASR) in the waste repository	44
7.3	Mechanisms of the alkali silica reaction	46
7.4	Composition of the reaction product	49
7.5	Rate of reaction and the dependence of pH and temperature	51
7.6	Effect of alkali silica reaction on porosity and water absorption	56
7.7	Scenario at the waste disposal site and discussion	58
7.8	Conclusions	61

Chapter 8: Evidence for degradation mechanisms from historical concrete

8.1	Introduction	73
8.2	Old "modern" concrete	73
8.2.1	Porjus tunnel	73
8.2.2	Water tank	74
8.2.3	Martin Dam	75

8.3	Ancient mortar and concrete	76
8.4	Medieval mortar and concrete	77
8.5	Conclusions	77

**Chapter 9: *Conceptual model for concrete degradation in a
KBS-3 repository***

9.1	Initial period	80
9.2	Sealing period	82
9.3	Post-closure period	83

Chapter 10: *Discussion and summary of conclusions*

10.1	Cement type	85
10.1.1	Standard Portland cement	85
10.1.2	Additions of pozzolans	86
10.1.3	Calcium aluminate cement	86
10.2	Concrete type	87
10.3	Influence of the environment	87
10.4	Summary of conclusions	88

References	97
-------------------	----

Specific abbreviations in cement terminology	104
---	-----

Summary

Concrete is being used for waste packages and conditioning of low-level waste and for repository constructions containing low-level waste. The underground facility SFR in Forsmark is an example of that. The high-level waste repository for spent fuel may in principle be constructed with only minor use of concrete. However, it may from a construction point of view be an advantage to be able to use such material in the repository. This report discusses what will happen with the concrete in a repository and in particular in a spent fuel repository. The subjects being treated are the interactions between groundwater and concrete and the consequences of concrete alteration.

The report is mainly a state-of-the-art report of concrete durability in the environment expected in the repository. Some of the results referred to have been produced during research carried out at CBI, Stockholm.

Cement-based materials are fundamentally unstable in a long time perspective. With time the concrete will change properties both as a consequence of recrystallisation and chemical interaction with the environment. The hydration products are stabilized by the high pH within the concrete. Thus, when the cement paste has equilibrated with the environment new phases will form. Not only reactions inside the cement paste are of interest in this context. It is also important to consider reactions with the aggregate phase and in particular reactions with the silica component in the aggregate phase due to the high pH from alkali hydroxides and subsequent reactions of the alkali silica hydrate phases. This has been a special subject of research at CBI. The rate of the chemical reactions in concrete in general is governed by a combination of dissolution mechanisms, diffusion and permeability/porosity. The main controlling factor is the dissolution of calcium hydroxide (portlandite) which buffers and controls the pH in the cement paste. Another important factor is the permeability of the concrete. During the first period the permeability will decrease as a consequence of continued hydration and recrystallization of the cement paste.

One of the main difficulties with a conceptual model for concrete degradation is the change in the geochemical environment with time. The degradation process must be treated as a sequence of different degradation mechanisms. During the first period the concrete will alter as a result of contact with atmospheric gases especially carbon dioxide which will carbonate the surface. Later the degradation will mainly be governed by the

composition of the groundwater with which it will try to equilibrate. Thus the composition of both the groundwater and the concrete will change. Considering the groundwater chemical conditions at repository depths (500 m), it is possible that with time the groundwater will change composition from normal to saline. This may in fact be an advantage because the solubility of the cement paste components decreases. However, the concrete itself will influence the groundwater composition and create an aureole with increased pH around it. Most of the components in both the fresh and saline water will not be harmful to concrete. One of the problems may be the chlorine anions, as this anion may substitute for sulphate in some of the cement phases. This will not degrade the concrete but the sulphates in the cement may be released to the groundwater. The end product of the concrete, after leaching and after the pH buffer capacity has been lost, will be a mix of metastable calcium silicate hydrates, zeolite and clay minerals.

1 Introduction

1.1 Orientation

The Swedish law requires that the nuclear waste produced in the country must be taken care of in such a way that it will not harm the present or coming generations of human beings. At present time the favoured concept is closely related to that which has been treated in reports from the Swedish Nuclear Fuel and Waste Management CO (SKB). Examples of such reports are SKB-FUD from 1992 and KBS-3 from 1983. According to this, the spent fuel shall after a period of about 40 years interim storage, be finally disposed of in Swedish crystalline bedrock at a depth of about 500 meters. The spent fuel shall be encapsulated in copper-enclosed canisters which will be deposited in holes in the floor of tunnels. Compacted bentonite clay will fill up the gap between the canisters and the rock. The tunnels will be filled with a mixture of sand and bentonite clay. The repository will be sealed and the groundwater level restored. This will result in expansion of the bentonite and a decrease in its permeability.

The aim of the concept is to isolate the radionuclides from the biosphere for such a length of time that the waste is no more harmful to man. For a long period of time, preferably more than 100 000 years, the chemical conditions in the rock and repository could be such that the bentonite and copper do not lose their integrity. Moreover, if a failure happens the radionuclides shall not easily be transported to the biosphere.

The advantage of using cement-based products in the repository may be envisaged in several applications and in several places. The aim of this report is to investigate the stability of suitable cement-based products and the influence they will have on the groundwater chemistry.

1.2 General assumptions about the type of concrete

Cement-based materials are fundamentally unstable. When cement is mixed with water a sequence of very fine grained hydration products are formed. They will with time dissolve or recrystallize. The timescale for this and the final products depend on such

variables as type of cement, type of aggregate, amount of mixing water, processing technique, application technique and the environment in which the cement-based material is placed. Moreover, different admixtures and additions, that are commonly used in modern concrete, influence the cement paste structure and the chemical systems. To fully reveal the degradation processes all these variables should be considered.

To simplify the investigation we only consider a concrete with pure Portland cement mixed with ordinary tap water and normal granitoid Swedish aggregates without any additives.

The degradation is also dependant on the structure and porosity/permeability of the hardened concrete. This is very much dependant on the water-cement ratio (W/C) of the concrete mix. We assume a W/C of around 0.4 to 0.5 like in a normal quality concrete. Lower W/C requires either a very high content of cement or additives.

As a reference cement we will use Degerhamn Std. Portland cement produced by Cementa (see Tab. 2:1).

The conceptual model for concrete degradation will thus be based on the chemistry and mineralogy of the cement paste, the aggregate, the permeability of the concrete, the type of cement-based product and the environment in which the concrete is placed.

In Chapter 9 we discuss the effect of changing the different variables.

1.3 The geochemical environment of the repository

The environment does not only interact with the surface of the concrete. A concrete is always more or less permeable. The chemical communication mainly take place through the pore solutions of the concrete. The composition of the pore fluids in turn regulates the crystalline and semi-crystalline phases of the cement paste. Moreover, temperature and pressure influence the speed of the reactions and the recrystallization processes.

Different environments give different mechanisms for degradation. In the repository the environment will change from the time of casting to the final sealing and thereafter. The degradation given by one environment is the starting point for the next. Thus the conceptual degradation must be treated as a sequential process of different degradation mechanisms.

During the first period the concrete will at least partly be in contact with air. Presumably the RH (relative humidity) will be high. After sealing, the tunnels will be filled with groundwater. One can assume that this water during the first period will penetrate from the surface and will thus have a modified meteoric character. We assume a composition similar to the Allard water. The Allard water is a simulated groundwater which is frequently used in laboratory experiments. The composition is typical for many groundwater samples taken between 100-500 m in Swedish bedrock. The composition of this water is shown in Tab. 1:1. Water with this composition will during a transitional period react and be buffered by chemical reactions with oxidised rocks and bentonite. After a period, presumably a couple of thousand years, this water will change composition due to mixing and replacement with deep groundwater. Samples of deep groundwater from the crystalline bedrock of the Baltic Shield shows that it is saline at 500 m depth and gets even more saline at greater depth (Nurmi et al 1988, Nilsson 1989). For the discussion we assume a composition close to that of the NASK water, which is similar to groundwater found at 500 m depth below Äspö (data in Nilsson 1989). The composition of the NASK water is shown in Tab. 1:1. At greater depth, the contents of chlorine and calcium increase while that of sodium decreases (Laaksoharju 1990). Similar relationships can be found in the old Canadian bedrock (Gascogné et al 1987).

Table 1:1

Model groundwater compositions simulating shallow groundwater compositions in granitic terraines (Allard water) and deep saline groundwater compositions (NASK water). mg/l (mM/l).

	Allard water		NASK water	
Na	65	(2.8)	3220	(140)
K	3.9	(0.1)	80	(2.1)
Ca	18	(0.5)	800	(19.9)
Mg	4.3	(0.2)	10	(0.4)
Cl	70	(2.0)	6390	(180)
HCO ₃	123	(2.0)	120	(2.0)
SO ₄	9.6	(0.1)	380	(4.0)
SiO ₂	12	(0.2)	-	
pH	8.2		7.7	

In this report the degradation of the concrete will be based on the scenarios described above. However, the influence of the environment will also depend on the local environment and the application technique. There are several places where concrete or cement-based material may be used. Each of these will have different environments and thus different degradation sequences.

The degradation is not only dependant on the chemical composition of the groundwater but also on the physical conditions. Two situations will be considered, stagnant and penetrative flowing groundwater. Furthermore, one can expect the temperature to vary. At 500 m depth the temperature is commonly in the range from 10 to 15 °C. During the first period of storage the radioactivity will be high which in turn will heat the surrounding. Thus at least during the first period after sealing one can assume higher temperatures. The concrete will, however, be a bit away from the copper canisters and the radioactive waste. According to Pusch and Börjesson (1992) the temperature for the tunnel backfill is estimated to be in the interval 45-55 °C for the first couple of thousand years. A similar assumption can probably be made for concrete in the tunnels.

1.4 Different applications of concrete and the environments

1.4.1 Structural concrete

Cast concrete may be used in several places. It can be used to seal or cover different things, or it may be used for a structural purpose. After curing some surfaces of the concrete will be subjected to the atmospheric conditions in the repository until sealing. The degradation will depend on the gas composition and humidity of the air. In the model we will assume a high humidity and a gas composition as in normal air. The content of carbon dioxide may, however, be slightly higher than in normal air due to human activity, diesel engines and emissions from the bedrock. The content of carbon dioxide and the humidity is important as this controls the rate of carbonation. An input of sulphates is also feasible if fossil fuel engines are used.

According to experience from sampling and analysis of groundwater down to 500 m and deeper at the SKB study sites (Laaksoharju, 1990) and also according to general experience from water investigations in the mining industry, it is likely that water in the

repository will be of meteoric origin. Especially during the open period of repository operation the drainage pumping will tend to draw down water from levels above the vaults. Some mixing due to upcoming of water is also possible. However, in general a freshwater origin is expected at 500 m during the operational period if the repository is situated in the inland. Of course an entirely different situation may occur if the repository is close to the seashore, where hydraulic influx of seawater may have an influence on groundwater composition. After sealing of the repository normal geochemical conditions will slowly be restored. If the repository is situated at levels with deep saline groundwater (Ca-Na-Cl dominated) this water may slowly replace a lighter fresh water due to the differences in density. Therefore, in order to cover distinctly different geochemical environment conditions for the concrete, it is assumed in this study that the concrete is first subjected to water of meteoric origin (ALLARD-type) during the period of repository operation. After sealing, it is further assumed that the meteoric water progressively is replaced by water of NASK-type (i.e. saline groundwater).

1.4.2 Shotcrete

Shotcrete lining may be used in the tunnels. This concrete will during the first period be subjected to the atmosphere on one side and the rocks and groundwater on the other side. Thus on one side effects of carbonation must be considered while the other side may be effected by unilateral water pressure and penetrating groundwater. The degradation during this first period will depend on the permeability of the concrete. After sealing this process will be less prominent when the water pressure will be equal on both sides. If shotcrete is used, the contact area against the expanded bentonite in the tunnels will be large. Thus one can expect interaction between the pore fluids of the two materials. The shotcrete will presumably be thinner than normal concrete. Thus it will degrade faster than massive concrete.

1.4.3 Grouted cement mortar

Cement-based products are frequently used in underground construction drillholes and as injection material in cracks. It may be difficult to avoid this application in a repository due to the advantages gained by these methods. The environment for injection grout is different from that of the normal concrete or shotcrete, especially during the first period.

The injection grout will not, as for the other applications of concrete, have access to components from the atmosphere. Instead it will during the whole period be in contact with groundwater. The important degradation processes will be the consequence of interaction with groundwater. The dominant geochemical processes will be dissolution, precipitation, recrystallisation and chemical interaction with the rocks. An important parameter is the permeability due to connected porosity (capillary porosity) which controls penetration of water. During the first period one can assume a hydraulic head of mainly meteoric water with a comparatively low content of salt. After sealing of the repository the hydraulic head will disappear assuming a tight seal, the groundwater will interact with the interior of the grout by diffusion. However, during later stages of degradation, dissolution of the grout may be an important mechanism. Degradation of grouted cement mortar is treated by Alcorn et. al (1992) and Onofrei et. al (1992)

1.5 Degradation processes in general

Portland cement-based concrete degrades in several ways. A number of intrinsic and environmental factors affect the performance of the concrete. The major system that will be treated in this report is the reactions between cement paste, aggregate and water. These reactions are governed by the principles of thermodynamics and kinetics and can be exceedingly complex. In this report all the degradation mechanisms will be treated individually. At the end they will be put together and a conceptual model will be presented.

The degradation processes relevant for the repository are reviewed in the following sections:

3. Carbon dioxide attack, carbonation
4. Sulphate attack, stability of the sulphate phases
5. Chloride attack, stability of the chloride phases
6. Stability of the cement phases in aqueous fluids
7. Stability of the aggregate phase: Cement-aggregate reactions
8. Evidence of degradation mechanisms from historical concrete

2 Structure of hardened cement paste

2.1 Cement composition

The for cement chemistry typical nomenclature is:

C = CaO	S = SiO ₂	A = Al ₂ O ₃	F = Fe ₂ O ₃
M = MgO	K = K ₂ O	\bar{S} = SO ₃	N = Na ₂ O
T = TiO ₂	P = P ₂ O ₅	H = H ₂ O, OH	\bar{C} = CO ₂

There are many types of both normal Portland cement and blended cement available on the market. By using different cements and mineral admixtures it is possible to design special cement pastes for special purposes. In this report for simplicity only concrete consisting of pure Portland cement is considered.

A Portland cement is a hydraulic cement produced by pulverised clinker, essentially of calcium silicates, usually containing one or more of the forms of calcium sulphates as an interground addition. The calcium silicates are of two types, tricalcium (C₃S, alite) and dicalcium (C₂S, belite) silicate. The alite, together with water, reacts much faster than belite and produces larger amounts of calcium hydroxide (CH, Portlandite). Apart from alite and belite the Portland cement contains substantial amounts of tricalcium aluminate (C₃A) and tetracalcium alumino ferrite (C₄AF). Another important component, although in small amounts, is alkalis. The cement is also normally contaminated by small amounts of MgO (periclase) and trace elements from the natural rocks used for producing the cement.

By changing the raw materials the proportions between the different clinker minerals can be changed. The distribution of clinker minerals and the grade of grinding will change the hydration process and the relative amounts of hydrated products.

In the conceptual model only a normally ground cement with low contents of aluminium and alkalis is considered. The chemical composition of Degerhamn Std Portland cement, which is such a type of cement, is presented below.

Table 2:1

Chemical composition of Degerhamn Std Portland cement (weight % oxide).

CaO	64.5 %	Mineral components
SiO ₂	22.2 %	C ₃ S 51 %
Al ₂ O ₃	3.5 %	C ₂ S 25 %
Fe ₂ O ₃	4.7 %	C ₃ A 1.2%
K ₂ O	0.6 %*	C ₄ AF 14 %
Na ₂ O	0.1 %*	Specific surface: 300 m ² /kg
MgO	1.0 %	Density: 3200 kg/m ³
SO ₃	2.0 %	
Cl	<0.01 %	
Free lime	0.8 %	
*Total alkalis		
(Na ₂ Oekv.)	0.5 %	

2.2 Structure of cement paste

The structure of a cement paste is very much a function of the water-cement ratio (W/C). Theoretically a cement paste with a W/C ratio of around 0.38 is completely hydrated (Taylor 1990). However, also in concretes with a higher W/C unhydrated cement minerals can be found. This is due to the hydration kinetics when a hydration product on the surface of the clinker minerals protect the inner part from hydrating. With time, however, one can presume that all the cement minerals become hydrated. In the concrete from 1905 (Chapter 8) unhydrated clinker grains still remain although the W/C ratio is above 0.38. Thus we presume that some unreacted cement grains will remain to a late stage of cement paste alteration.

A hardened cement paste has the properties of a rigid gel. It is a relatively strong solid of high porosity and large internal surface area. This is a consequence of the way it is produced and applied.

During the early period of hydration, products start to grow on the surface of the clinker grains. The produced "cement gel" is a very fine grained mass of poorly crystallized products. In between these products so called gel-pores are formed. Measurements

indicate that the hydrated cement paste generally have a fixed volume fraction, around 0.28, of gel pores.

The hydrated product occupies more space than the cement but less space than the cement and water. This forms capillary pores that can be regarded as remnants of initially water-filled space. A higher W/C ratio gives more capillary pores due to the larger amount of initial water. Theoretically there would be no capillary pores at a W/C ratio of 0.38. This is, however, not true in a real concrete as the overall structure is inhomogeneous and some clinker grain remain unhydrated. Water can presumably also move in microcracks formed during the early stages of the cement hydration. The extension of these cracks is to some degree an effect of the treatment of the concrete after casting.

In general water is able to flow through the capillary pores but not the gel pores. It is through the capillary pores that liquid and ion exchange mainly occur, which means that the transport will be much more efficient in concretes with high W/C ratios. Thus, to get a durable concrete, surface active chemical agents like superplasticizers are mixed into the concrete in order to be able to cast it with a low W/C ratio. The relationships can be seen in Fig. 6:3 in Chapter 6. The porosity and especially the capillary porosity is important as it determines the rate of exchange with the environment and controls the degradation rate.

Apart from the capillary and gel pores a normal concrete contains 2-3 per cent entrapped air. Moreover, different chemical reactions both in fresh and old concrete, lead to volume changes that creates a microcrack system which may increase the permeability.

2.3 Hydration products of cement

Which phases of hydration products and in what sequence they form, is partly a function of the temperature and the curing conditions. In this report we presume casting at normal temperature of slightly less than 20 °C and water curing. The hydration products are also controlled by the relative humidity in the concrete. In the presentation below we only consider a temperature interval between 10 and 50 °C and a humidity interval between 50 and 100 % RH.

The main hydration products being formed are;

1 Calcium-silica-hydrate, C-S-H

This is the main component of the cement paste. It is an amorphous to semi-crystalline product with very diffuse and broad X-ray diffraction peaks. It has a Ca/Si ratio (molar ratio) from around 0.8 to 3 with variable content of water. In our reference concrete the Ca/Si ratio will be around 1.7. The closest natural crystalline minerals are **tobermanite** ($C_5S_6H_9$ approx.) and **jenneite** ($C_9S_6H_{11}$ approx.). There is some substitution of Si for Al^{3+} , Fe^{3+} . The C-S-H can also contain some alkalis, sulphate and chlorine ions presumably built into the disordered layer structure. A recent review article can be found in Taylor 1993.

2 Calcium dihydroxide, CH

This is a common crystalline product in concrete named **Portlandite**. Compared to the other components the crystals are relatively large with distinct X-ray peaks.

3 Aluminium-Iron-mono, AFm

AFm phases have the general formula $(Ca_2(Al,Fe)(OH)_6) \times X \times yH_2O$, where X denotes one formula unit of a single charged anion, or half a formula unit of a double charged anion. The term "mono" relates to the single formula unit of CaX_2 . Many different anions or anion complexes can serve as X, of which the most important are OH^- , SO_4^{2-} , Cl^- and CO_3^{2-} (from Taylor 1990). The AFm phases are crystalline with often, due to small grain size and solid solutions, somewhat blurred X-ray peaks.

The most common AFm (alumina, A can be substituted by iron, F) phases relevant for concrete in the repository are;



At high humidity and at temperatures up to 50 °C $x=19$. At high temperature or low humidity $x=13$

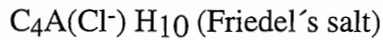
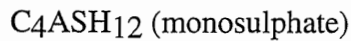
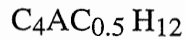

The closest natural products are C_2AS_8 , **strätlingite** and C_4AH_{12} with some Cl^- and CO_3^{2-} (hydrocalcium aluminate)

4 Aluminium-Iron-tri, AFt

AFt phases have the general constitutional formula $(Ca_3(Al,Fe)(OH)_6 \times 12 H_2O)_2 \times X_3 \times yH_2O$, where $y < 2$ and X represents one formula unit of a double charged ion, or with reservations, two formula units of a single charged anion. Examples of such ions are SO_4^{2-} , $H_2SO_4^{2-}$ and CO_3^{2-} . Alumina (A) can be substituted by Fe (F). The AFt phases are crystalline with somewhat blurred X-ray peaks due to small grain size and solid solution.

The most important AFt phase are:

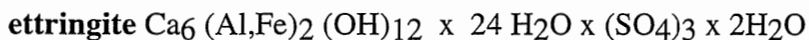

Two other minerals which closely resemble the ettringite structure which can be found in concrete are;

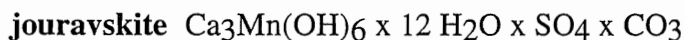
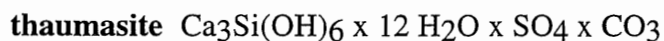

With high contents of chloride anions and low to moderate temperatures, a chloride AFt phase is stable:



5 Sulphates and other relevant phases

Most of the sulphate from the gypsum in the cement is bound in ettringite (see above). However, some gypsum may remain. Another phase that under certain conditions can precipitate is **syngenite** $K_2Ca(SO_4)_2 \times H_2O$.

Other relevant hydrated phases are:

hydrogarnet. These phases have structures related to that of natural grossular-garnet ($Ca_3Al_2Si_3O_{12}$). In the hydrogarnet, this structure is modified by omission of some or all of the silicon atoms, the charge being balanced by replacing each of the oxygen atoms to which the Si atom was attached with a hydroxyl group. The Al (III) may be replaced by Fe (III).

brucite ($Mg(OH)_2$). This is the product of hydration of the small amount of MgO which always occur in cement. Mg can also be bound in a hydrotalcite phase.

6 Distribution of the different phases in Portland cement paste.

In the conceptual model we assume a high quality concrete with a W/C ratio between 0.4 and 0.5. Table 2:2 shows the calculated composition and distribution of hydration phases in a cement paste with a cement close in composition to Degerhamn Std Portland. In the calculation it is assumed that the Ca/Si ratio is 1.7 and that the AFm and AFt phases each have a Si/Ca ratio of 0.05. The method of calculation is described in Taylor (1990).

Table 2:2

Volume percentage of solid phases and the porosity of 14 months old hardened cement paste at 11% RH. The cement is in composition similar to Degerhamn Std Portland cement. W/C ratio = 0.50. From Taylor (1990).

Alite (C ₃ S)	1.0 (remaining cement clinker)
Belite (C ₂ S)	0.6 (remaining cement clinker)
Calcium aluminate (C ₃ A)	0.0 (remaining cement clinker)
Calcium aluminate ferrite (C ₄ AF)	1.0 (remaining cement clinker)
C-S-H	33.4
CH	13.2
AFm	12.7
AFt	6.2
FeHP	1.8 (Hydrogarnet-type phase)
MgHP	1.7 (Hydrotalcite-type phase)
CaCO ₃	0.7
Other	0.6
Bound water	31.2
Non-evaporable water	21.9
Total pores	27.0
(Capillary pores)	15.5
(Gel pores)	11.5

Table 2:2 shows that the major phases are C-S-H, CH, AFm and AFt. The sulphate is equally distributed in the AFm and AFt. The main AFt phase containing sulphate is ettringite. The alkalis mainly reside in the pore solutions. The relative amount of the different phases will change according to the composition of the cement.

3 Carbon dioxide attack, carbonation

3.1 Orientation

During the first period, before sealing, the concrete in the tunnels will be exposed to atmospheric conditions. The air in the tunnels may, due to human activities and engines, be enriched in carbon dioxide. This will increase the carbonation of the concrete. Carbonation occurs when carbon dioxide from the atmosphere dissolves in the pore solution of cement paste, producing CO_3^{2-} , which will react with Ca^{2+} and produce CaCO_3 (calcite). This reaction will consume CH.

The carbonation reaction can be written as follows:

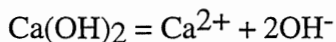
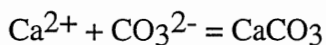
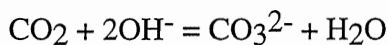
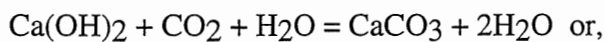

Later, when the CH is consumed, C-S-H is first decalcified and later decomposed. The AFm and AFt phases react with the carbonate anion and form special carbonate species. If pH is lowered even further by additions of more carbon dioxide, these initially formed carbonate species will decompose. The residues from complete carbonation are calcite, amorphous silica, hydrocarboaluminates and different Al- and Fe-hydroxides. The pH value of the carbonated cement paste first drops to around 10 when all the CH is consumed and later to a pH around 8 when the other phases are decomposed.

The rate of carbonation depends to a large extent on the open porosity (permeability, W/C ratio) and the relative humidity of the atmosphere. The capillary porosity controls how fast carbon dioxide from the atmosphere can diffuse into the concrete. It also depends on the curing conditions of the concrete, cement type and temperature.

The carbonated concrete retains most of its strength. The problem with carbonation is mainly that of reinforcement corrosion. When the pH value drops the iron can oxidise and corrosion will follow.

Carbonate ions in small content can also alter the normal cement paste as the carbonate anion can substitute in some of the hydration phases. The system was investigated by Barret et al (1983). A well known phase is Thaumasite which is a carbonated form of ettringite. If the aggregate contains carbonate rocks these may with time react with the cement paste and form different hydrocarboaluminates. At a late stage calcite in the carbonated layer may react with underlying concrete and form hydrocarboaluminates in this.

3.2 Consequences for degradation in the repository

As stated above, the rate of carbonation is mainly governed by the humidity and the permeability (W/C ratio). The relationship has been investigated by Tuutti (1982) and is illustrated in Fig.3:1. In the tunnels of the repository the humidity will presumably be high. Thus with a good concrete (W/C around 0.40 - 0.50) the carbonation depth will be around 5 mm with an exposure time of 50 years. In this case we assume a content of carbon dioxide as in the atmosphere. With a higher amount the carbonation will go deeper. The carbonation will stop when the repository is sealed. Both ALLARD and NASK water contain bicarbonate anions that due to the high pH will transform to carbonate ions. These carbonate anions may react/substitute with AFt/AFm phases and thus stabilize them. In the AFt/AFm phases there will be a competition between carbon, sulphate and chlorine ions. In a long time perspective calcite from the aggregate and the carbonated layer may form carboaluminates.

Presumably the high pH and Ca cation concentration in the close surroundings of the concrete will regulate the bicarbonate concentration in the deep groundwater. The solubility of calcite decreases with increasing pH. Thus, calcite will presumably start to precipitate already in the high pH aureole around the concrete. The remaining bicarbonate/carbonate ions will be consumed by the concrete.

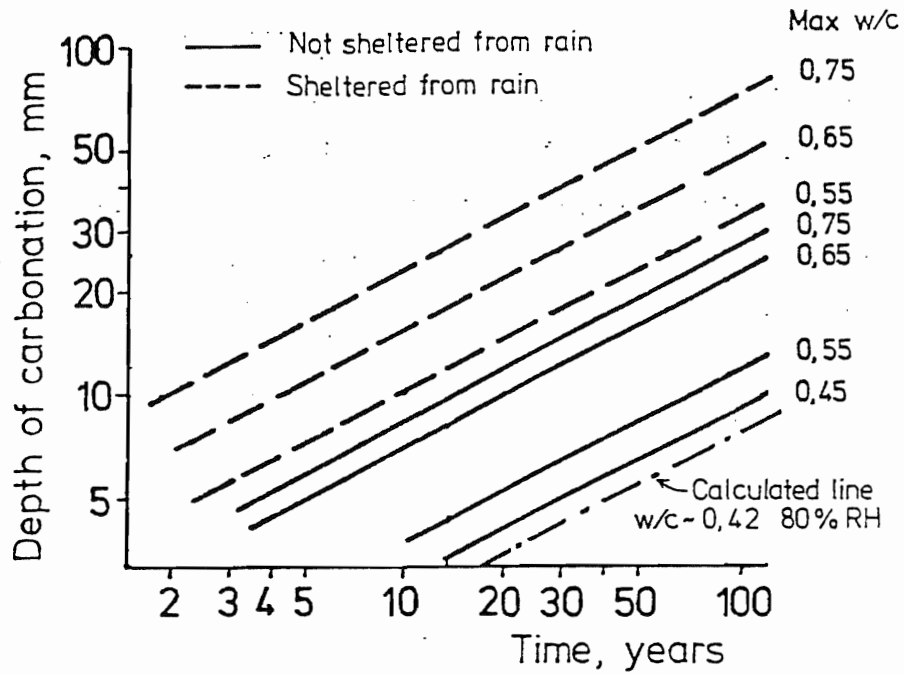

Fig. 3:1 Upper bounding lines for measured mean carbonation depth in Portland cement concrete with varying W/C ratios and the theoretical line for W/C = 0.42, 80% RH. From Tutti, 1982.

4 Sulphate attack, stability of the sulphate phases

4.1 Orientation

Modern Portland cements always contain a few % calcium sulphate (gypsum) to control the setting time. During the hydration process, the sulphate anions are bound to the aluminium and ferrite rich phases AFm (monosulphate) and AFt (ettringite). Minor amounts of sulphate ions can, if carbonate ions are available, bind to thaumasite. For the composition of thaumasite, see Chapter 2.

Ettringite forms as very minute crystals during the first stages of cement hydration. The cement contains more aluminium and ferrite than sulphate. Thus when the pore solutions are depleted in sulphates the early ettringite reacts with the remaining aluminate and forms monosulphate. The relative amount of these phases is dependant on the cement chemistry and reaction kinetics. The role of the ferrite phase is not fully clear. Some of it is bound in AFm and AFt but much of it is also bound to iron oxide/hydroxide gels and hydrogarnet. Relative to Al the Fe cation is less mobile in a cement paste which results in that the Fe phases are formed as fine grained aggregates close to the C₄AF mineral phase while the Al phases form their own relatively large hydration crystals. Thus, at least in a short perspective, the Al component is the most important.

From analyses of the composition of pore fluids from cement pastes it is known that ettringite is destabilised when the sulphate concentration becomes very low. If the sulphate concentration increases new ettringite is formed. With very high contents of sulphate anions gypsum is stabilised. The formation of both ettringite and gypsum involves an expansion which may lead to volumetric increase eventually leading to fracture formation. As the formation of ettringite requires aluminium, cement with low contents of this element is required in sulphate rich environments. The reference cement, Degerhamn Std Portland, is regarded to be a sulphate resistant cement due to its relatively low contents of Al.

The ettringite stability field was most recently investigated by Höglund (1992) and Damidot et al (1992).

The stability domain of AFt (ettringite) is defined by four boundary curves AH₃-AFt, C₃AH₆-AFt, CH-AFt and gypsum-AFt (Fig.4:1). Moreover, AFt is sensible to the alkali content and the temperature. A high alkali content requires more sulphate in the pore solution in order to maintain the stability of the AFt phase.

The stability of both ettringite and monosulphate is controlled by pH. When the concrete is carbonated, or if the CH is leached, they break down. Gabrisová et al 1991 studied the stability of both phases in water solutions at various pH intervals with the potentiometric method. Measurements performed at non-equilibrium conditions showed that the boundary for the disappearance of ettringite is pH = 10.7 and for monosulphate 11.6. At lower values of pH, only gypsum and aluminium sulphate were present. In a real concrete, however, there will presumably remain minerals of the ettringite group as this is a natural mineral in rocks (Taylor 1973).

The content of sulphate in the pore solution controls the stability of both the ettringite and monosulphate phases. The stability of ettringite and monosulphate is, however, also controlled by the alkali content and the temperature. Higher temperatures (and more alkalis) increase the content of sulphates in the pore solution (Herr & Wieker 1992). It is controlled by the reaction;

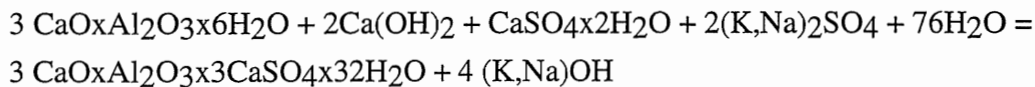

At lower temperatures (20 °C) ettringite is the stable phase, but with temperatures increasing to more than 50 °C the reaction starts running to the left. At high temperatures syngenite (alkalisulphate) can start to precipitate. According to experience with heat treatment of concrete there seems to be a critical limit of 70 to 80 °C above which ettringite is unstable (Brown & Bothe 1993). The role of Fe instead of Al in ettringite is uncertain but it is known that a concrete with a cement rich in Fe (C₄AF), like Degerhamn Std P, is less sensible to heat curing than Slite Std P which is richer in Al (Lagerblad & Utkin, 1993).

In old concrete the air voids are normally filled by relatively large ettringite crystals and sometimes CH crystals (see Chapter 8) This indicates that these mineral phases are relatively easily recrystallized.

4.2 Consequences for degradation in the repository

With time the groundwater and concrete pore solutions will equilibrate. With the given values in Table 1 both the ALLARD and NASK water have higher contents of sulphate anions than the pore water in a Degerhamn Std P. cement paste. This will result in the formation of new ettringite as there is a relative excess of aluminate. Higher temperatures may, however, reverse this and lead to sulphates being leached from the concrete. When the CH has been leached from the cement paste and the pH drops, the sulphates will enter solution due to the greater solubility of the resulting gypsum and aluminium sulphates.

It will, however, take some time for the pore solution to equilibrate with the external water when CH is leached out. Especially in the NASK water, the high content of chloride anions influences the stability because these anions may enter the AFm and AFt phases (see Chapter 5).

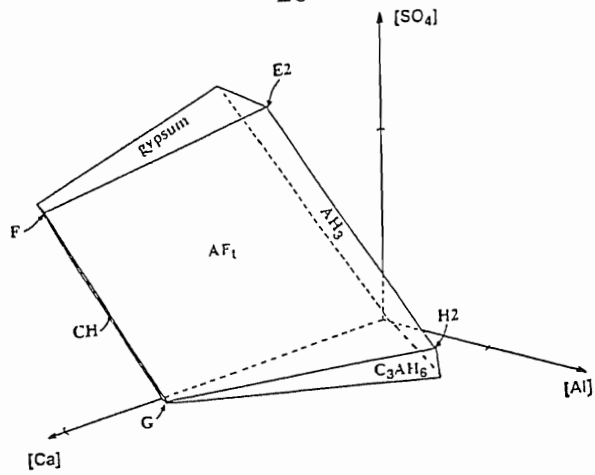

Figure 4:1. CaO-Al₂O₃-CaSO₄-H₂O phase diagram drawn from the data of Jones

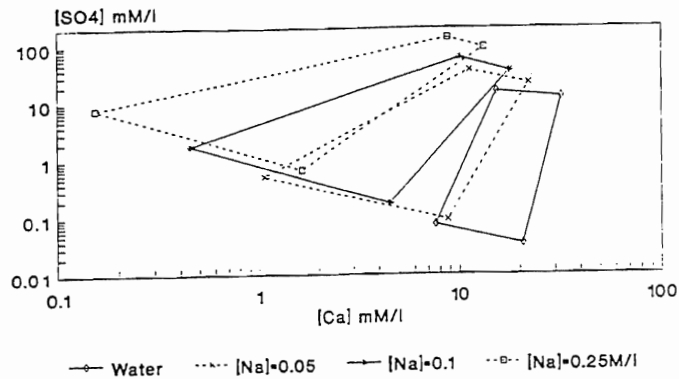

Figure 4:2. Projection of AF_t equilibrium surface on the calcium-sulphate axis for different sodium concentrations at 25° C.

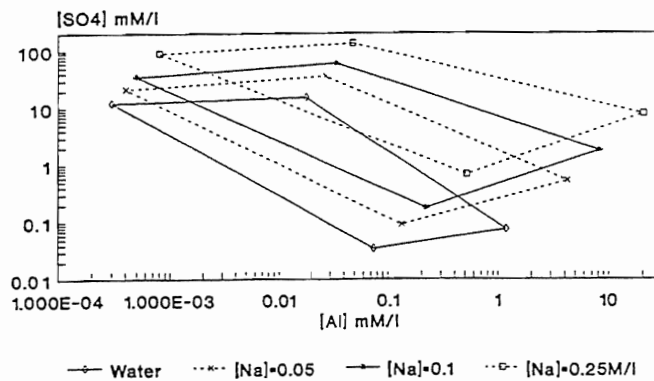

Figure 4:3. Projection of AF_t equilibrium surface on the aluminate-sulphate axis for different sodium concentrations at 25° C.

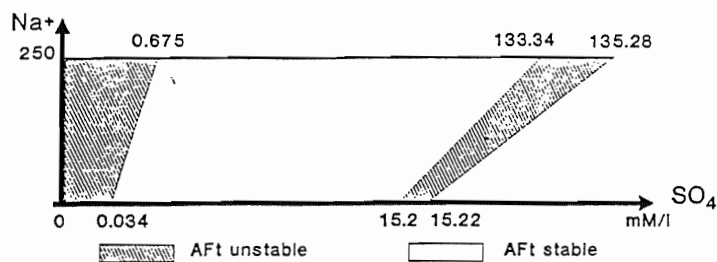

Figure 4:4. Evolution of the AF_t domains of stability and instability when sodium is added.

5 Chloride attack, stability of the chloride phases

5.1 Introduction

Normal cements have a very low chloride content. There are restrictions on the amount of chlorides in cements for reinforced concrete, because the resulting chloride anion lowers the threshold value for reinforcement corrosion. Especially the NASK water contains high amounts of chloride ions. Reinforcement corrosion will not be considered.

In the cement paste chloride ions concentrate in the pore solution enter the C-S-H gel and bind to the AFm phase. The diffusion of chloride ions into the concrete depends mainly on the W/C ratio and cement type. According to tests at CBI with concrete in seawater the diffusion coefficient of a concrete with Degerhamn Std P. cement is 2.7, 4.2 and 4.8 x 10⁻¹² m²/s at W/C ratios of 0.35, 0.40 and 0.50 respectively (data from Karin Pettersson CBI, personal communication). With Slite Std Portland cement, which is richer in aluminate, the diffusion coefficient is lower. About 40% of the chloride ions are dissolved in the pore water while 60% is bound to the cement paste. This is data from one year of exposure. The bound chlorine ions will affect the structure of the cement paste. Thus it is important to evaluate the possible consequences.

The main AFm phase has the formula C₃A x CaCl₂ x 10 H₂O. The Al can be replaced by Fe(III). The compound is called Friedel's salt. At very high contents of chloride anions and at low temperatures (Figs. 5:1, 2, 3) the AFt product called trichloride is stable (Richartz 1969). How much chlorine ions a cement paste can bind is a function of the concentration of OH⁻, Cl⁻ and SO₄²⁻ as these three ions compete for the same positions in the AFm mineral structure. This relationship is shown in Fig. 5:5 from the work of Byfors (1990). In these experiments chloride ions are mixed into the fresh cement paste and the results of the equilibrium reactions are shown in Fig 5:5. If chloride ions have to diffuse into the concrete it will probably take a long time before this stage is reached. The data in Byfors (1990) also indicate that Degerhamn Std P binds more chloride ions than Slite Std P although this cement contains more C₃A (Fig. 5:4). It is uncertain whether this is an effect of physical binding (sorption) and not chemical binding as when chlorides are mixed into the concrete during the laboratory experiments. Data from Richartz (Fig. 5:2) show that the C-S-H phase can physically bind substantial amounts of chloride

anions. Evidence from field concrete indicates that Degerhamn Std P and Slite Std P cement chemically bind approximately the same amount of chloride anions (Pettersson, CBI, personal communication).

Worthington et al (1988) exposed cement pastes to chloride solutions and analysed the different resulting crystals. They found that when exposed to chloride solutions the monosulphates changed to Friedel's salt which in turn liberated sulphates which bound to newly formed ettringite. As a result of a chloride attack all aluminate phases (C_4AH_9 , C_2AH_8) will be consumed and become part of a sulphate or chloride complex.

The different reactions are dependant on both the chloride concentration and the temperature. The relationships are indicated in Figs 5: 1, 2, 3 from Richartz (1969). At temperatures of 40 °C and above and with a chloride content of above 10 000 mg/l the ettringite will decompose to Friedel's salt and gypsum. At temperatures below 20 °C trichloride forms instead of Friedel's salt.

5.2 Consequences for degradation in the repository

The Allard water has a relatively low content of chloride ions. The NASK water has a high content of chloride (6390 mg/l). This will influence the cement paste structure. We have not found any data on the exact stability fields. The NASK water is more complex than the experimental solutions. However, we assume that due to the high content of chloride in the NASK water the remaining aluminate phases will transform to Friedel's salt. Some of the ettringite may break down especially if temperatures of more than 50 °C is considered. With higher contents of chloride, like in the super-deep groundwaters, the ettringite may decompose and release sulphates. The data indicate that there is a critical limit around 10 000 mg/l. Some chloride ions will also enter the C-S-H phases. The chemical system is extremely complex and not investigated in detail as regard the consequence of the competition between sulphate and chloride anions in the aluminate phase.

When the CH is dissolved, or if the concrete is carbonated, the chloride ions will be released. It is a well known phenomena that the amount of chloride ions always is larger just inside the carbonation front in a concrete structure.

Seawater contains similar amount of chloride anions as the NASK water but it contains considerably higher concentrations of sulphate and magnesium ions. The calcium sodium ratio is also very different. A strict comparison is impossible but experiments with seawater give some information. X-ray diffraction data (Helmy 1991) show that with cement paste in seawater (19 000 mg/l chloride), the amount of Friedel's salt increases while that of monosulphate and ettringite decreases. The kinetics of this reaction is not fully understood. With time the NASK water may release sulphates to the surroundings.

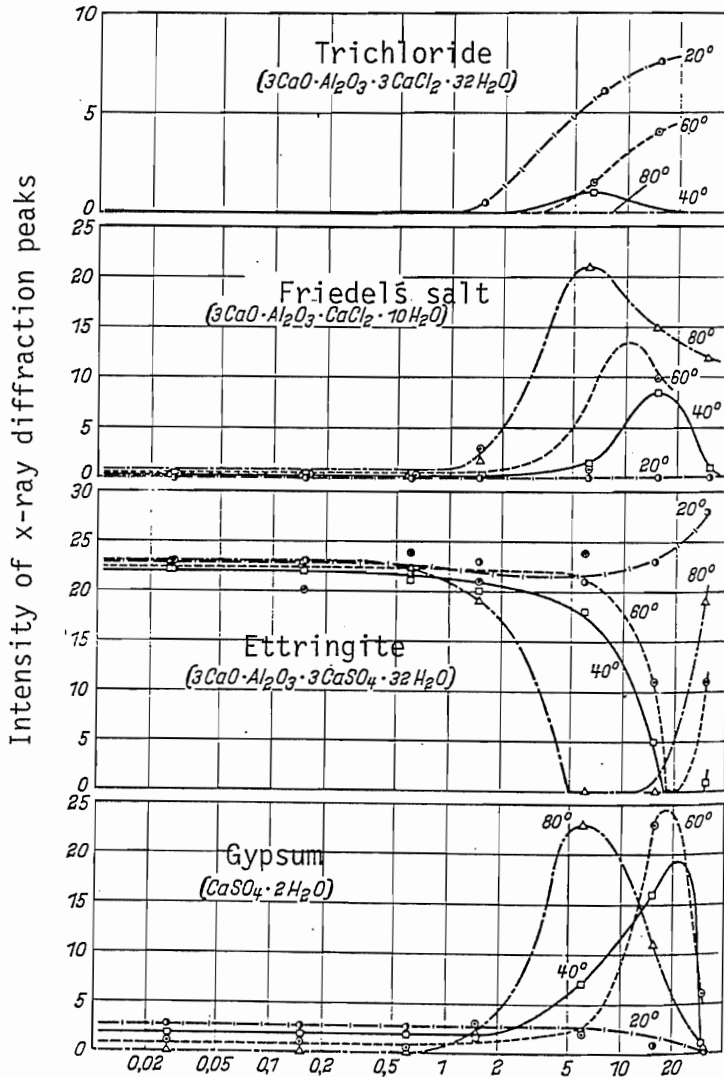

Fig. 5:1. Formation of phases during hydration of Portland cement paste mixed with calcium chloride solutions at different temperatures. From Richartz, 1969.

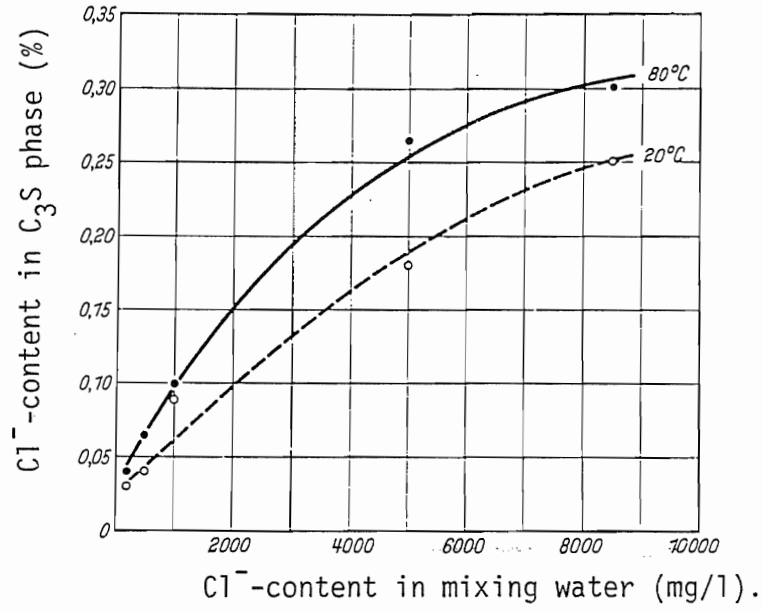

Fig. 5:2. The dependence of the chloride content in mixing water with bound chloride amount in different hydration products. From Richartz, 1969.

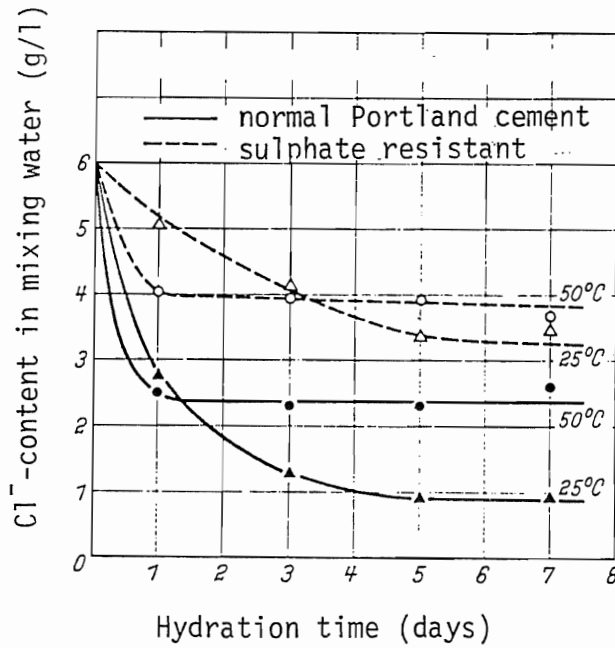

Fig. 5:3. The binding of chlorides in Portland cement at different temperatures. From Richartz, 1969.

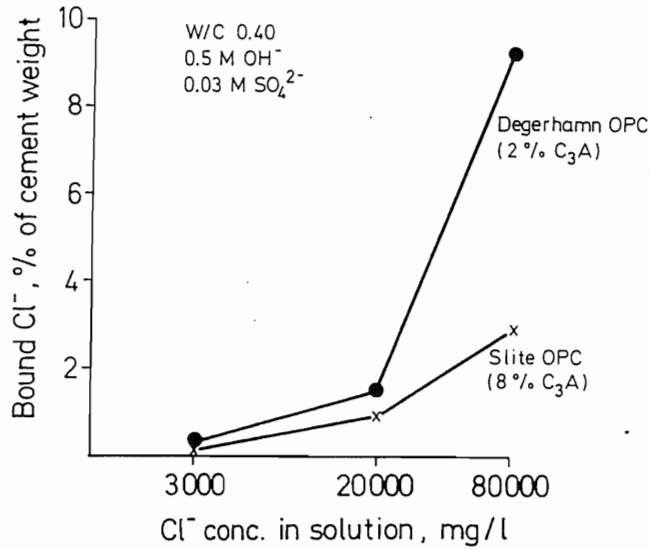

Fig.5:4. Quantity of bound chloride for mixes with different cements as a function of the Cl⁻ concentration of the initial solution. Initial solution: 0.5 M OH⁻, 0.03 M SO₄²⁻, 3 000, 20 000 and 80 000 mg Cl⁻/l. From Byfors, 1990.

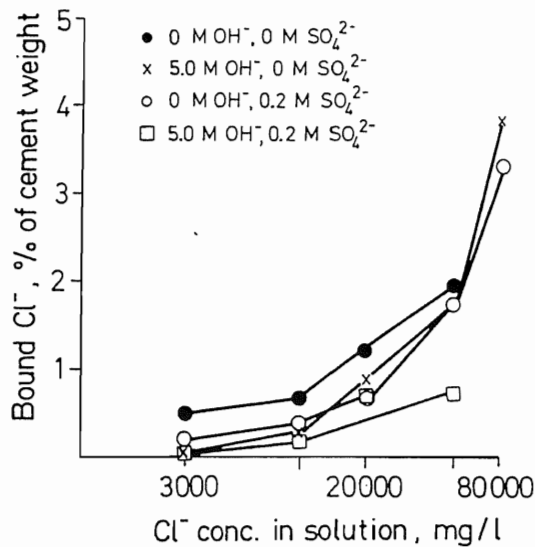

Fig.5:5. Quantity of bound Cl⁻ expressed as a percentage of the cement weight as a function of the Cl⁻ concentration of the initial solution. Slite OPC W/C 0.40. Eight months storage in plastic bag. Equilibrium method. From Byfors, 1990.

6 Stability of the cement phase in aqueous fluids

6.1 Introduction

The stability of concrete and in particular the cement phase is influenced by its ability to resist penetration of aqueous species in solution. This penetration depends on the permeability of the cement paste. For example, the permeability influences the dissolution rate and the leaching out of calcium hydroxide from the cement paste. Permeability becomes relevant and obeys Darcy's law (equation 2), when concrete is exposed to a pressure gradient (head of water) and if laminar flow is assumed. Movement of water or aqueous species in solution through a wall of concrete can be caused not only by pressure gradients but also by a humidity differential on the two sides of concrete or by concentration gradients between soluble species in pore water and water surrounding the concrete (osmotic effects). The latter is a diffusion mechanism and obeys Fick's laws. Principally two cases of concrete exposure of importance in a waste repository can be modelled:

- 1) Injection grout in rock fissures and cracks and shotcrete on bedrock walls in order to prevent flow of groundwater into the repository during the pre-closure period (0-40 years). The permeability of concrete and dissolution rates of calcium hydroxide is important. Groundwater is modelled to have Allard water composition (see Table 1, Stability of the aggregate phase)
- 2) Structural concrete during post-closure period (after approx. 40 years and onwards). The waste repository is assumed to be filled with groundwater having NASK water composition. The mechanism will be a diffusion-controlled exchange between aqueous species in pore water and the surrounding groundwater. To some extent laminar flow of groundwater around concrete bodies will remove aqueous species diffusing out from the concrete. Hydroxyl-neutralisation and outward diffusion of OH^- and K^+ ions as well as intrusion of sulphate and chloride ions will be significant. To a minor extent, and when long time scales are considered, calcium hydroxide dissolution and Ca diffusion out from the concrete will occur. This will, however, proceed at a slow rate compared to case 1), because of the much lower gradient for water flow.

6.2 Permeability and leaching of $\text{Ca}(\text{OH})_2$ and C-S-H phases

6.2.1 Permeability and porosity

The flow of water through concrete is fundamentally similar to flow through any porous body. The cement paste is composed of particles connected over only a small fraction of their total surface and separated by gel pores. A fraction of the water is within the force field surface of the solid phase and a thin layer of water molecules is adsorbed. The fraction of the water that is adsorbed has a high viscosity but is, nevertheless, mobile and takes part in the flow (Powers et al., 1959).

The permeability of concrete is not a simple function of its porosity, but depends also on the size, distribution, and connectivity of the pores. This in turn is dependent on the W/C ratio of the concrete and the degree of hydration of the cement paste. Permeability as a function of W/C ratio in cement pastes is shown in Fig. 6:1 (from Neville, 1981). The hardened cement paste has a porosity of about 30% by volume at a W/C ratio of 0.5 and the permeability range from 10^{-14} to 10^{-10} m/s depending on the W/C ratio and maturity which influence the pore structure. The cement paste as a whole consists of both crystalline phases (CH, AFm, AFt) and gel phases (C-S-H) and the porosity is divided into larger capillary pores (diameter about 1000 nm) and much smaller gel pores (about 150 nm). At a W/C ratio of 0.5 the capillary porosity is about 18% by volume and the gel porosity is about 13%. Water can flow much more easily through the capillary pores than through the smaller gel pores and the cement paste as a whole (capillary + gel pores) is up to 100 times more permeable than the cement gel itself which only contains gel pores. From this follows that the permeability of the cement paste is controlled by its capillary porosity. A high proportion of water flow through hardened cement paste appears to be through pores wider than 100 nm (Taylor, 1990). The relation between permeability and capillary porosity is shown in Fig. 6:2 and 6:3. The coefficient of permeability increases with temperature. The capillary pores vary in shape but, as demonstrated by measurements of permeability, form an interconnected system randomly distributed throughout the cement paste. These interconnected capillary pores are mainly responsible for the permeability of hardened cement paste. A high degree of hydration increases the solid content of the paste, and in mature and dense pastes the capillary pores may become blocked by gel phases and segmented so that they turn into pores interconnected only by

gel pores. The segmented capillary pores make the cement paste less permeable. The shift from discontinuous to continuous capillary pores is due to a combination of maturity and a suitable W/C ratio. At a W/C ratio of 0.50 it takes about fourteen days to reach maturity and the stage where a certain amount of the capillary pores have been segmented. At a W/C ratio above 0.70 the cement paste never reaches this stage and a large portion of the capillary pores are continuous.

The permeability of cement paste or any porous medium is a general coefficient which characterises the flow of a fluid caused by a pressure gradient. Assuming laminar flow, permeability can be calculated using Darcy's law:

$$Q = dq/dt = K/\mu \times A \times dP/dZ \quad (2)$$

$Q, dq/dt$ = Volume of fluid flowing in unit time, m^3/s

K = Permeability coefficient of the medium, m/s

μ = Viscosity of the fluid phase

dP/dZ = Pressure gradient

A = Cross-sectional area of the porous body, m^2

For practical reasons the following expression can be used when water is the fluid phase:

$$dq/dt = K \times A \times \Delta h/l \quad \text{where,}$$

Δh = Head of water in metres

l = Thickness of the porous medium (concrete body) in metres

The depth of water penetration (d) into concrete, which is under pressure from a head of water, will follow the expression:

$$d = \sqrt{(2Kht)} \quad \text{where,}$$

K = coefficient of permeability

h = head of water

t = time

Typical depths of penetration of water for North Sea concretes which has a permeability coefficient of 10^{-11} m/s and a W/C ratio of 0.42 is 100 mm after one year and 600 mm

after 30 years at a head of water of about 200 metres. The same figures would be about 30 mm and 200 mm at 25 metres head of water.

Permeability coefficients of hardened cement paste and concrete at various W/C ratios are given in Table 6:1 and 6:2. Because of the many possible deviations from the ideal conditions, which should be obtained when experimental determinations of the permeability are carried out and when Darcy's law is assumed, two sources of permeability coefficients are given in Table 6:1. Examples of such errors and deviations from Darcy's law are deviations from steady state flow and complete saturation of the concrete body, poorly compacted areas and capillary forces.

Applications of results from permeability tests obtained from cement pastes to concrete are further complicated by the presence of cracks and other inhomogenities in concrete. The permeability of concrete is, however, to a large extent controlled by the permeability of the cement paste.

It has also been shown that the temperature of the hardened cement paste influences the permeability (Table 6:1). At higher temperatures the cement paste is coarsened probably due to recrystallization. The temperature also influence the viscosity of water which in turn has an effect on the permeability. This is due to the fact that the viscosity of water is decreased when the temperature is increased. The viscosity of water at 60 °C is approximately half of the viscosity at 20 °C (1.0×10^{-2} P at 20 °C compared to 0.5×10^{-2} P at 60 °C).

Table 6:1

Permeability coefficients for mature hardened cement pastes at various temperatures and W/C ratios from Tang and Nilsson (1993) and Neville (1981) in m/s.

Tang and Nilsson				Neville (20°C)		
W/C	T(°C)	K(m/s)	age	W/C	K(m/s)	age
0.30	20	0.1×10^{-12}	28d	0.38	2.5×10^{-14}	>1yr.
0.40	20	0.2×10^{-12}	28d	0.42	8.2×10^{-14}	>1yr.
0.50	20	0.3×10^{-12}	28d	0.48	2.4×10^{-13}	>1yr.
0.60	20	2.3×10^{-12}	28d	0.66	5.8×10^{-12}	>1yr.
0.70	20	22×10^{-12}	28d	0.70	1.0×10^{-12}	24d
0.70	20	1.4×10^{-12}	>1yr.	0.71	1.5×10^{-10}	>1yr.
0.40	27	0.7×10^{-12}	28d			
0.40	60	5.3×10^{-12}	28d			

Table 6:2

Typical values of permeability of concrete used in dams and off-shore constructions (Neville, 1981). Age > 1 year.

W/C ratio	K(m/s)
0.46	2.8×10^{-12}
0.69	8×10^{-12}
0.74	24×10^{-12}
0.75	35×10^{-12}

Another phenomenon that must be regarded concerning permeability is recrystallization of the cement phases. When the cement phases with time forms larger crystals this will probably enlarge the gel pores, while the capillary pores become more discontinuous. Moreover, the continued hydration of remaining cement clinker minerals will densify the structure in the matured paste. These phenomenon will result in a decrease in the porosity. This can often be observed in old concrete like that in the water tank (see Chapter 8).

6.2.2 Leaching of $\text{Ca}(\text{OH})_2$ and calcium silicate phases

Leaching of concrete by percolating or flowing water has caused severe damage to constructions such as dams and pipes. Pure water at neutral pH may be expected to remove alkali hydroxides, dissolve calcium hydroxide and eventually decompose the hydrated calcium silicate and aluminate phases. The final residue will consist of hydrous forms of silica, alumina and iron oxide and all the CaO will be lost. By this stage the cement paste will have disintegrated totally.

Calcium hydroxide is the first phase to dissolve when pH in the pore solution decrease or when concrete is subjected to acid attack. Dissolution of $\text{Ca}(\text{OH})_2$ buffers the pore solution to pH 12.4. As long as $\text{Ca}(\text{OH})_2$ is left in the cement paste the buffered pore solution to a large extent prevents the calcium silicate and aluminate phases to dissolve. Equilibrium for calcium hydroxide and the hydrated calcium silicate and aluminate phases suggest that calcium hydroxide will be dissolved before the calcium silicate and calcium aluminate phases are attacked, but in practice the attack is likely to be simultaneous

because of the greater specific areas of the latter phases. Calcium hydroxide will, however, be dissolved at a faster rate. When all the calcium hydroxide has been dissolved severe attack on calcium silicate hydrate phases will start and pH will drop to slightly above 10. The hydrated aluminate phases are the last solids to dissolve in the cement gel.

The rate at which the calcium phases are dissolved depends on the permeability of the concrete (i.e. the rate at which water percolates through or flows over the concrete body) and consequently the quality of the concrete. It also depends on temperature and parameters included in the rate equation (see equation 3) such as specific surface area and concentration of soluble species in the water. Dissolution and solubility of calcium hydroxide and hydrated calcium silicate phases are most rapid and severe with soft "aggressive water" containing dissolved CO₂ and low concentrations of calcium carbonate or bicarbonate ions. Hard water, which is water saturated with calcium carbonate at alkaline pH levels, containing no dissolved CO₂ has no or very limited dissolving capacity on concrete. To some extent, and if longer time scales are considered, concrete is soluble in pure neutral water free of any CO₂ due to low concentrations of carbonate and bicarbonate ions. In aggressive waters with pH about 5.7 and CO₂ concentration of about 0.012 mM cement paste has a solubility of about 130 mg/l (James, 1992). Waters with even higher contents of dissolved CO₂, which is not unusual for groundwaters, will increase the solubility of concrete considerably. Natural waters containing dissolved "free" CO₂ can dissolve calcium hydroxide with formation of bicarbonate, HCO₃⁻, according to:

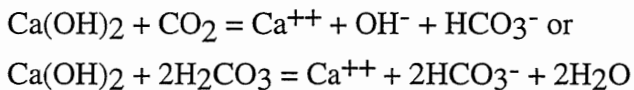

Similarly the same water solution is capable of dissolving Ca⁺⁺ and OH⁻ ions from calcium silicate hydrate (C-S-H) in the cement gel. C-S-H holds the cement gel together and it is reasonable to assume that, when C-S-H dissolves the cement paste it loses its strength. The molecular structure of C-S-H has been described as repeating units consisting of three layers of C-S-H, which are associated with one layer of calcium hydroxide (CH). It is the CH layer that starts to dissolve and subsequently dissolution and total decomposition of the C-S-H complex follows. The calcium silicate hydrates in the cement gel have varying ratios of calcium oxide to silica (C/S ratio) ranging from 0.85 to 1.75. C-S-H phases with lower C/S ratios are characterized as C-S-H(1) and C-S-H with higher ratios as C-S-H(2). They form incongruent solid solutions where C-S-H(1) has to dissolve before C-S-H(2) due to the fact that C-S-H(1) envelopes C-S-H(2) in the cement gel structure. The phase C-S-H(2) has the higher solubility. Dissolution rates of

C-S-H appear to fit second order kinetics, which means that it dissolves relatively quickly initially, but takes a long time to produce fully saturated solutions. Estimates of dissolution rates for cement pastes require three parameters: solubility, kinetic order of the dissolution process (which appears to be of second order for C-S-H, see also Fig.6:6), and a value of the rate constant (K) at an appropriate flow velocity which is determined by the permeability. The solubility rate constant is defined by the relationship:

$$dM/dt = KA (C_s - C)^\phi \quad (3)$$

or

$$dc/dt = KA/V(C_s - C)^2 \quad \text{which integrated gives,}$$

$$\frac{C}{C_s(C_s - C)} = KA t/V \quad \text{where,}$$

dM/dt = rate of mass dissolution from a solid, kg/s

A = specific surface area of solid, m^2

C = concentration of dissolved substance in water adjacent to the dissolving surface, kg/m^3

C_s = solution potential of the water, kg/m^3

ϕ = kinetic order of the dissolution equation

K = solubility rate constant, m/s or $m^4/kg \times s$

V = volume of solution, m^3

t = elapsed time, s

Results from dissolution experiments with concrete from a 100 year old dam (James, 1989) indicate that equilibrium concentrations of a water solution in contact with C-S-H(1) solid are 0.93 mM ($M=mol/l$) for calcium and 0.32 mM for silica. The water solution contained dissolved CO_2 and the pH was 5.70. These values are in accordance with earlier experimental results from dissolution of C-S-H(1) in pure water (Taylor, 1950). It is therefore reasonable to assume that the equilibrium concentrations determined by James (1989) and Taylor (1950) are roughly consistent with dissolution of C-S-H(1) compounds. Undersaturated solutions, with calcium and silica contents below these values, are potentially capable of dissolving C-S-H(1) from the cement gel. Groundwater which has Allard water composition is slightly undersaturated with respect to Ca and Si

and is capable of dissolving C-S-H(1) and C-S-H(2) phases. Calcium concentrations in pore solutions, which are in equilibrium with C-S-H phases at various C/S ratios, are shown in Fig. 7:5 in Chapter 7. C-S-H(2) phases have a higher solubility than C-S-H(1), but C-S-H(1) has to dissolve before C-S-H(2) because of the structure of the C-S-H gel, which consists of an outer layer of C-S-H(1) protecting internal layers of C-S-H(2). It follows that once C-S-H(1) phases have been stripped away, rapid disintegration of the cement gel will take place. The attack starts with dissolution of the CH layer in the C-S-H phases and subsequently the calcium silicate hydrate layers are dissolved. By then the silica content in the pore solution has started to increase and the calcium content decreased (Fig. 6:6).

The stages by which cement paste disintegrates can be summarised as follows:

1) Reduction of the alkali level in pore solution by removal of alkali ions (dilution) and subsequent lowering of pH.

2) Dissolution of CH (Ca(OH)_2) which buffers the pH in the pore solution to 12.4. Possible reactions with respect to pH and dissolved CO_2 :

- a) $\text{Ca(OH)}_2 + \text{CO}_2 = \text{Ca}^{++} + \text{HCO}_3^- + \text{OH}^-$
- b) $\text{Ca(OH)}_2 + 2\text{H}_2\text{CO}_3 = \text{Ca}^{++} + 2\text{HCO}_3^- + 2\text{H}_2\text{O}$
- c) $\text{Ca(OH)}_2 + \text{H}^+ = \text{Ca}^{++} + \text{OH}^- + \text{H}_2\text{O}$

3) Dissolution of C-S-H(1)

4) Dissolution of C-S-H(2). Equilibrium between C-S-H phases and pore waters can be expressed as follows:

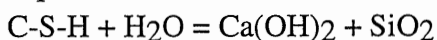

pH in the pore solution stays slightly above 10 during dissolution of C-S-H compounds.

5) Dissolution of hydrated calcium aluminate phases and a drop in pH below 10. The equilibrium is:

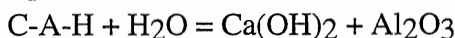

6) Dissolution of calcium aluminate ferro hydrate phases. The equilibrium is:



The decomposition of the calciumaluminateferro hydrate phases will also result in metastable phases like hydrogarnets and different zeolites.

Dissolution of the calcium containing phases CH and C-S-H can be considered to be the key point. It is reasonable to assume that when C-S-H is dissolved, the whole cement paste has disintegrated. Therefore, the solubility of cement pastes consisting of ordinary Portland cement, can be considered to be a function of the solubility/dissolution of primarily C-S-H phases in the cement gel. When CH has been removed, solubility of a cement paste is represented by the calcium or silica concentration in pore solution. It follows that concentrations of calcium and silica brought into solution at equilibrium with C-S-H phases in the hardened cement paste are equivalent to the amount of solid material, which has been dissolved. If the solubility of hardened cement paste is approximated to be the same as the solubility of C-S-H phases, a steady state has to be established between the cement paste (concrete structure) and water from the outside. Steady state is established when alkali and calcium ions present as solutes in the original pore water have been removed. Thus the capability of groundwater with ALLARD or NASK water composition to dissolve hardened cement paste will depend on the calcium and silica concentrations and the amount of dissolved CO₂. Ordinary Portland cement with a composition of Degerhamn Std P cement, have a phase composition of the cement gel as shown in Table 1. It is noticeable that C-S-H compounds and CH stand for almost 50% by volume of the cement paste. By weight the C-S-H and CH compounds constitute almost 65 %.

The release of calcium ions from concrete either in the form of Ca(OH)₂, C-S-H or CaCO₃ (in case of carbonated concrete) involves several steps encountered below (Davies and deWiest, 1966):

	Equilibrium const.(log K)
1) CO ₂ (gas) = CO ₂ , pressure and temperature sensitive	-1.42
2) CO ₂ + H ₂ O = H ₂ CO ₃ (carbonic acid)	-2.8
3) H ₂ CO ₃ = H ⁺ + HCO ₃ ⁻ (bicarbonate)	-3.5
4) HCO ₃ ⁻ = H ⁺ + CO ₃ ⁻⁻ (carbonate)	-10.25
5) CaCO ₃ = Ca ⁺⁺ + CO ₃ ⁻⁻	-8.35

CaCO₃ can react with H⁺, after dissociation of carbonic acid has taken place, producing bicarbonate according to: CaCO₃ + H⁺ = Ca⁺⁺ + HCO₃⁻. Similarly Ca(OH)₂ reacts with H⁺ (see above). Carbonic acid is stable in both fresh and saline waters at pH below 5.7 and dissociates rapidly to bicarbonate above this pH. Bicarbonate in a solution is stable up to pH about 9 in fresh water and about 8.2-8.5 in saline waters. Above this pH bicarbonate is converted to carbonate and the ratio of carbonate to bicarbonate ions

increases to more than 100 to 1 at pH 12 (Davis and deWiest, 1966). Concentrations of solute species in the carbonate system at various pH values for fresh and saline waters, are shown in Fig. 6:4 and 6:5 (from Stumm and Morgan, 1981). Much of the carbonate and bicarbonate ions in groundwater are derived from the carbon dioxide in the atmosphere. A substantial amount can, however, also be derived from dissolution of carbonate rocks and organic matter in soils. Groundwater generally contains more than 10 mM but less than 800 mM bicarbonate (Davis and de Wiest, 1966). Only rarely groundwaters have pH values outside the range where bicarbonate is stable (5.7-8.5). Concentrations of calcium ions in "normal" groundwater generally range between 10 and 100 mM.

Allard water has a pH value close to values where bicarbonate ions become unstable. It is, nevertheless, most probable that the bicarbonate ion is stable and that the carbonate content is very low in both ALLARD and NASK water. It is also assumed that the amount of dissolved CO₂ is low. Both ALLARD and NASK water (see Table 1:1, Chapter 1) have anomalously low contents of bicarbonate ions (about 2.0 mM) compared to "normal" groundwaters and must be considered as evolved, fossil groundwaters. Similarly calcium concentrations in Allard water is anomalously low (0.5 mM).

As mentioned above the potential for a water solution to dissolve and remove calcium ions from solid phases in the cement paste depends not only on the amount of dissolved CO₂ but also on the concentration of calcium ions or calcium bicarbonate-carbonate (carbonate hardness) as well as the silica content. For example, pure water at 23 °C, with no dissolved CO₂, can dissolve about 13 mM calcium carbonate and about 22 mM calcium hydroxide. A water solution is considered to be very soft if the calcium concentration is in the range between 0-0.37 mM (0-15 mg/l), soft between 0.37-0.88 mM (15-35 mg/l), and hard above 0.88 mM. Allard water contains about 0.5 mM calcium and is characterized as soft water, whereas NASK water is a very hard water. It should be mentioned, that water having a calcium content below 0.54 mM is regarded as potentially harmful to concrete constructions (Fagerlund and Rombén, 1982). However, if concrete is designed as water proof, with a permeability coefficient less than 10⁻¹⁰ m/s, dissolution of calcium phases preferentially take place on surfaces which are in contact with the water solution. The deterioration is slow and in most cases not harmful to concrete during its service life (50-100 years). Rating of the solubility potential for waters with various contents of Ca and dissolved H₂CO₃ is listed in Table 6:4 (Based on: Vatten och avloppsföreningen, 1975 and from investigations by Granholm et al., 1934).

Table 6:4

Rating of the aggressivity of a water solution on concrete with respect to its service life (about 100 years) and solubility potential of cement paste for different waters at approx. 20 °C, mM. Based on Granholm et al (1934).

Calcium content (mM)	Amount of carbonic acid (mM)	dissolved CO ₂ (mM)	Solubility potential
> 0.37	< 0.24	<0.34	insignificant
> 0.37	0.24-0.65	0.34-0.68	very small
0.037-0.37	< 0.24		very small
> 0.37	0.65-1.45	0.68-1.36	significant
0.037-0.37	0.24-0.65		significant
< 0.037	< 0.24		significant
> 0.37	> 1.45	> 1.36	strong
0.037-0.37	> 0.65		strong
< 0.037	> 0.24		strong
0.37-0.88	0.34-0.68	85-130 mg/l	
<0.037	small	small	1600 mg/l Ca(OH) ₂
0.90-1.0			concentration in eq. with C-S-H(1)
20			concentration in eq. with C-S-H(2)

The dissolution of cement-based grout materials is treated in the reports Stripa Project 92-23 (Alcorn et al, Theoretical investigations of grout seal longevity - final report) and Stripa Project 92-28 (Onofrei et al, Sealing properties of cement-based grout materials). The dissolution mechanisms are not identical for a grout and a concrete. Concrete contains aggregates, and will be exposed to different environments in the tunnels. Concrete is also more massive than sealing grout. Moreover, in the investigated grout superplasticizers and pozzolans were used. The pozzolans will increase the amount of C-S-H at the expense of CH. In the leaching experiments reported in Stripa Project 92-28 by Alcorn et.al (1992), three types of leaching water were used: deionized water, a Canadian groundwater similar in composition to NASK, and a super saline deep groundwater. The Canadian groundwater has, however, higher contents of sulphate and

magnesium ions which will make a difference (see below). The results show that with static conditions the dissolution of calcium is very fast in the beginning and drops rapidly. This is due to saturation of the solution and precipitation of Portlandite and calcite. The precipitation indicates access to atmospheric carbon dioxide which would not be the case during later stages in the repository. The test also shows that the dissolution rate increases significantly with increasing temperatures. As expected the leach rate was much smaller in the Canadian NASK-type of water. Actually there was an initial decrease in calcium concentrations in the solution due to precipitation of Portlandite and calcite as the pH increased. Moreover, due to reactions a protective layer of brucite formed on the surface of the grout. This is a well known phenomenon from concrete in sea-water (Massazza, 1985) where the brucite protects the interior from dissolution. The NASK water is too low in Mg to give this protection. Dynamic leaching increased the leach rate especially for grout with a high W/C ratio.

The results show the important influence of groundwater composition on precipitation and the formation of other phases on the concrete surface. Thus one must carefully consider all the different ions in the groundwater and evaluate the dissolution rate on the basis of what phases these ions can form inside and on the surface of the concrete. Actually the dissolution rate was higher in the extremely saline water.

In Alcorn et al (1992), a theoretical model for the dissolution/precipitation of different cement pastes and reaction phases is presented. In this work interaction with the rock is included. This is also relevant for conditions within concrete (cement-aggregate reactions) as it contains up to 75 % rocks as aggregates. According to the calculations a grout seal will remain intact for very long times of hundreds and even thousands of years. However, it will not be the same for construction concrete as the flow will be larger and the penetration distance smaller. Concerning concrete the data, which include information about the formation of new minerals, are interesting. These minerals will clog the cracks and hinder the flow. However, the precipitation of new minerals will depend on the flow rate. A slow flow will be clogged while a fast flow will tend to keep itself open. The slow flow will provide time enough for precipitation and new phases to form, while a fast flow will be more efficient in removing mass by dissolution and transport.

6.3 Consequences for degradation in the repository

If long time scales are considered, concrete in contact with flowing groundwater which has Allard water composition will suffer leaching of CH. Eventually dissolution of C-S-H phases and disintegration of the cement paste will occur. This is due to the fact that both the calcium and silica contents of Allard water are less than in a cement pore water which is in equilibrium with the calcium phases of the cement paste. However, Allard water has a very low content of bicarbonate and carbon dioxide, which makes it non-aggressive towards concrete. The dissolution rate will be slow and if the concrete has a permeability coefficient less than about 10^{-10} m/s, the concrete is assumed to be water tight for all practical purposes. Water tight structural concrete according to ACI standards should have a W/C ratio of not more than 0.48 (fresh water) or 0.44 (saline water). Dissolution and removal of calcium phases will be slow and deterioration concentrated to the surface of the concrete. Furthermore, CH near the surface will carbonate relatively fast which will delay calcium removal. In practice, it is unlikely that any deterioration will occur with Allard water if normal concrete service life time spans are considered (50-100 years).

When the composition of the groundwater changes to a NASK composition the dissolution rate will go down as a consequence of the high ionic strength of the NASK-water. In particular a high content of Ca cations will slow down the dissolution. On the other hand, the content of magnesium and sulphate is very low and consequently no protective layer will form due to brucite precipitation. The dissolution rate will depend on the water flow and the permeability of the concrete. With low water flow there will be an aureole of high pH and elevated calcium content around the concrete. The dissolution rate will depend on how fast the water flows around the concrete, or in other words the resetting of the aureole. Other important factors are the bentonite and rock water interactions, which could lead to the formation of new minerals precipitating due to ionic diffusion out from the concrete.

The permeability of the concrete will increase due to decreasing viscosity of water solutions at higher temperatures. The permeability of the cement paste may increase as much as twenty to thirty times if the temperature rises from 15-20 °C (operating period) to about 45-50 °C (post-closure period). This is indicated in Table 6:1.

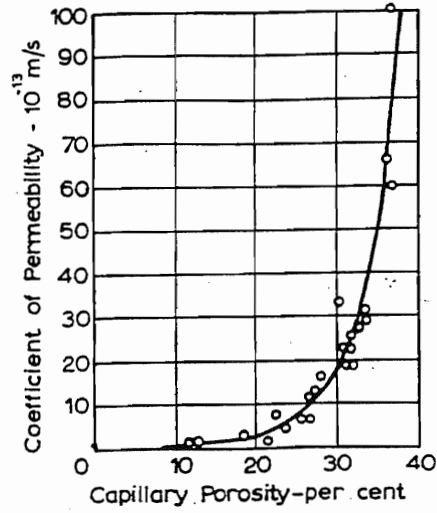

Fig. 6:1 Relation between permeability and capillary porosity of cement pastes (Neville, 1981).

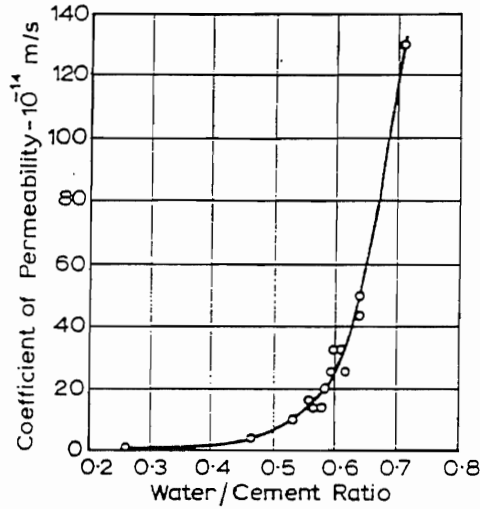

Fig. 6:2. Permeability as a function of water - cement ratio for mature cement pastes (93% of cement hydrated). From Neville, 1981.

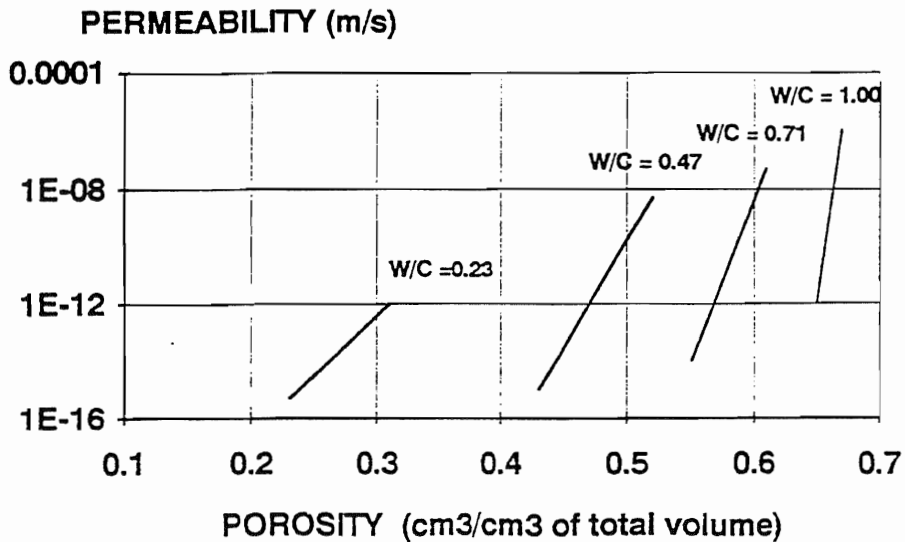

Fig. 6:3 Relationship between permeability, porosity and W/C ratio for various hardened cement pastes. From Olliver and Massat, 1992 and Nyame and Illston, 1981.

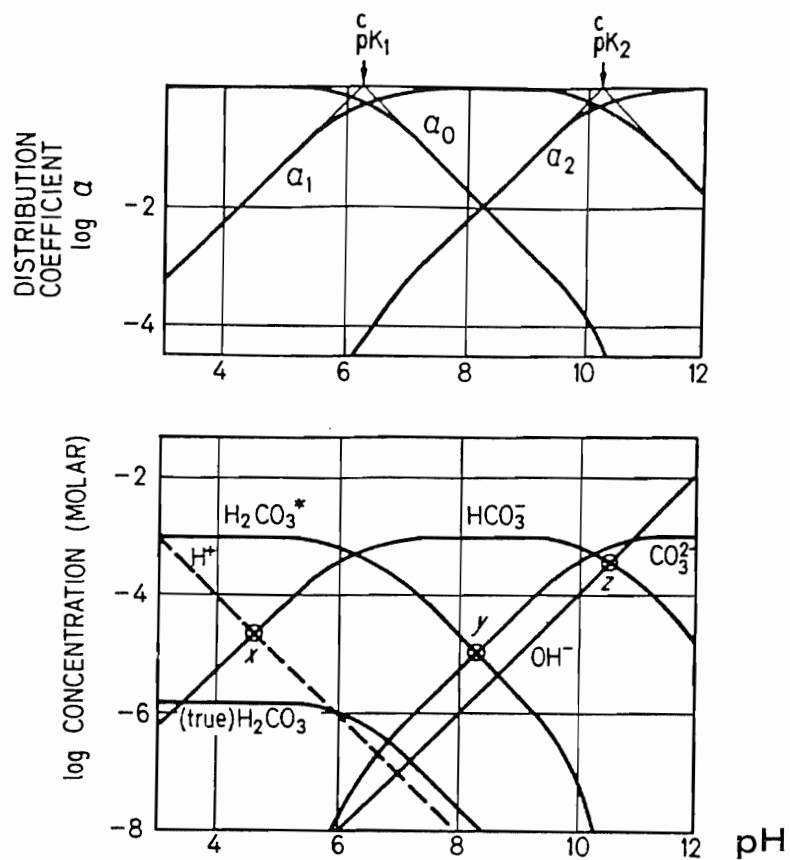

Fig 6:4. Logarithmic diagram showing distribution of solute species in aqueous carbonate system for fresh water. From Stumm and Morgan, 1981.

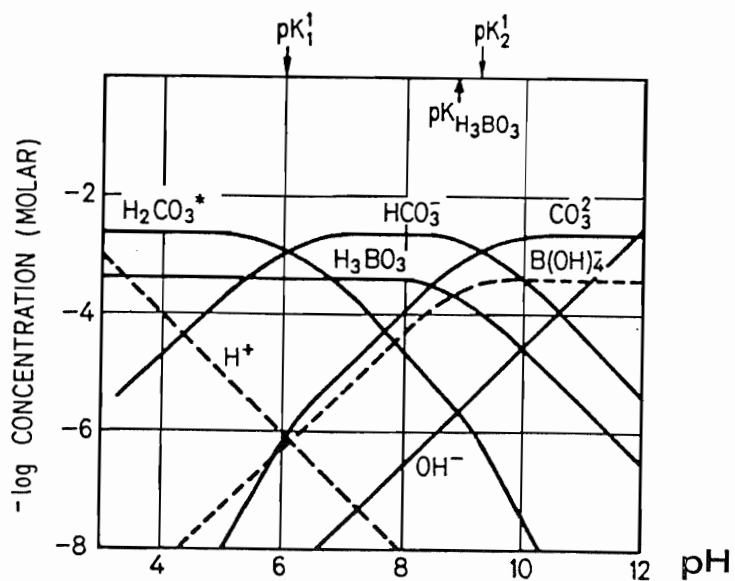

Fig. 6:5. Logarithmic equilibrium diagram for aqueous species in the carbonate system for sea water. From Stumm and Morgan, 1981.

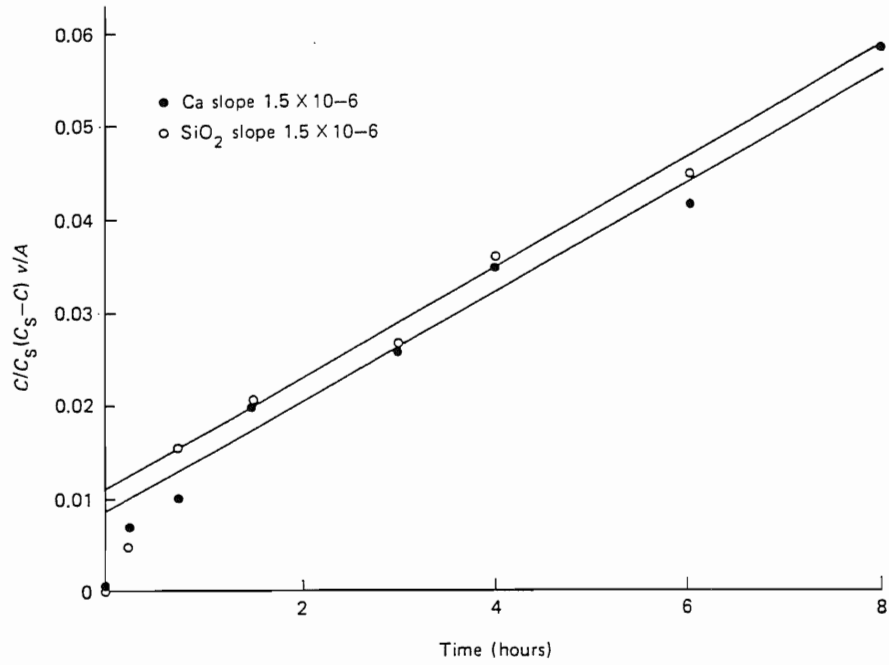

Fig.6:6. Cement dissolution kinetics indicating second order dissolution mechanism. Slope, $\text{m}^4 \text{kg} \times \text{s}$. From James, 1992 and James, 1989.

7 Stability of the aggregate phase: Cement - aggregate reactions

7.1 Introduction

Quartz and other rock forming silicates (e.g. feldspars, micas etc.) are essentially thermodynamically unstable under conditions existing in concrete containing ordinary Portland cement. Quartz is a primary rock forming mineral abundant in common rocks such as granite, gneiss, volcanites and rocks of sedimentary origin. A knowledge of the dissolution mechanism of quartz minerals is required to understand and predict the interaction between aggregates and cement pore fluids and the alteration of concrete during longer timescales. Chemical and physical processes interact in the formation of an alkali-silica gel which is able to take up water, to expand and to crack concrete. The driving force of the reaction is the migration of ions by diffusion and osmosis from the pore solution to the reaction sites.

The alkali-silica reaction and the dissolution rate of silica in concrete is controlled by several factors such as: moisture level, alkali concentration in the pore solution, amount of calcium hydroxide, amount and reactivity of the siliceous component in the aggregate, pH of the pore solution and temperature.

The alkali concentration of the pore solution depends on the alkali content of the cement and on alkali migration into the concrete from the environment. The reactivity of the aggregates depends on the grain size (surface free energy) and the crystalline structure of the silica component. For example, opaline silica which is amorphous is much more reactive than quartz which has a well defined crystal lattice and chalcedony, which is a crypto- to microcrystalline quartz mineral, is more reactive than macrocrystalline quartz. Another example is mylonitic aggregates containing recrystallized quartz which is reactive due to deformations in the crystal lattice.

If shorter time-scales are considered (up to 100 years), no deleterious alkali-silica reaction will occur if the alkali concentration in the cement is below 0.6 weight % Na_2O equivalent and if there is no alkali migration into the concrete from the environment. In order to initiate the alkali-silica reaction it is also required that the moisture level in the concrete is above about 85 % RH.

7.2 Factors controlling the alkali-silica reaction (ASR) in the repository

Two different phases of geochemical conditions have been considered for the repository in this study. During the first period of time (0-40 years, pre-closure period) the groundwater is modelled to have an Allard water composition (see Table 7:1) and the temperature will be approximately 15 °C. During the second time period (40 years-, post-closure period) the groundwater is modelled to have a NASK water composition (see Table 7:2) and the temperature will be approximately 50 °C. These chemical conditions are likely and the two different groundwaters cover two important possibilities: carbonate dominated waters and chloride dominated waters.

The alkali content of the Portland cement considered to be used in the repository (Degerhamn Std) is low, about 0.6 weight % Na₂O equivalent, as well as the calcium hydroxide content (0.8 weight % free lime). The chemical composition of Degerhamn Std cement is given in Table 1:1. The combination of Degerhamn Std P cement with aggregates containing rather coarse grained well-crystallized silica (quartz) makes the alkali-silica reaction slow and the dissolution rate of silica low. During the pre-closure period the model groundwater (Allard water) has a similar composition as groundwater in a granitic terrain. This water has a low alkali content compared to pore solutions in cement-based materials, which makes the influx of alkalis from the surrounding groundwater negligible during the pre-closure period. It has been shown that a threshold pH value of approximately 13.5 in cement pore solutions exists, below which little or no expansion takes place due to the alkali-silica reaction (Struble, 1987). However, alkali-silica gel can still be produced, which may densify the cement structure (Chapter 6). Representative analysis of pore solution from Degerhamn Std P cement show a pH value of about 13.0 (see Table 7:1). Possible mixing between pore solution and groundwater of ALLARD-composition will also lead to reduction of pH. The factors above indicate that expansion due to the alkali-silica reaction is going to have little effect on concrete during the pre-closure period. The alkali-silica reaction is therefore treated in the long term perspective after the nuclear waste repository has been sealed (post-closure period).

When the nuclear waste repository has been sealed, it will be naturally filled with groundwater. This groundwater is modelled to have an Allard water composition and it is further assumed that mixing with fossil saline groundwater will occur and eventually change the modelled composition to a NASK water composition.

Concrete in contact with surrounding groundwater will be subjected to a constant transport of pore water components by diffusion. The diffusion will eventually change the pore water composition and depletion/enrichment of initially dissolved components such as alkali ions, hydroxyl ions, calcium ions etc. will follow. This will change the conditions for the alkali-silica reaction and the dissolution of silica components in the aggregate phase, as well as lead to dissolution of solid components in the cement phase. It should be pointed out that diffusion of aqueous species between cement pore water and surrounding groundwater, treated in Chapter 7, will be somewhat different if high alkali cement (e.g. Slite Std) instead of Degerhamn std P cement is used.

Representative analysis of pore water composition for Degerhamn Std cement is given in Table 7:1. Some elements from analysis of pore solution from Slite Std P cement have been included for comparison.

Table 7:1

Representative pore water composition for Degerhamn Std P cement, mM (mg/l). Some elements from pore solution from Slite Std P cement and ALLARD and NASK water compositions are included for comparison. The analysis are made on pore-pressed solutions obtained at CBI.

Degerhamn std P cement		Slite std P cement	ALLARD	NASK
Age	3 months	3 months		
W/C	0.40	0.40		
Na	28 (644)	63 (1449)	2.8 (65)	140 (3220)
K	83 (3245)	28 (11026)	0.1 (3.9)	2.1 (80)
Ca	0.9 (36)		0.5 (18)	19.9 (800)
Si	0.8 (22)		0.2 (12)	-
Al	0.04 (1,1)		-	-
OH	114 (1938)	380 (6460)	0.0016	0.0005
SO ₄	0.04 (3,8)		0.1 (9.6)	-
Mg	-	-	0.2 (4.3)	0.4 (10)
Cl	(<2.0)	(2-5)	2.0 (70)	180 (6390)
HCO ₃		-	2.0 (123)	2.0 (120)
pH	13.06	13.6	8.2	7.7

7.3 Mechanisms of the alkali-silica reaction

Physical and chemical processes are responsible for the alkali-silica reaction in concrete. Physical processes include: 1) Migration of hydroxyl and alkali ions to the reaction site. The reaction site can be either in the interior of the aggregate or at the aggregate surface. The migration to the aggregate surface is diffusion controlled. In case the interior of an aggregate is dissolved, the migration is to a larger extent controlled by osmotic effects, 2) swelling by water uptake of the alkali-silica gel produced, 3) development of cracks. In alkaline solutions chemical processes involve: 1) neutralisation of acidic silanol groups and attack of siloxane bridges by hydroxyl ions, 2) formation of an alkali-silica gel. These reactions result in a breakdown of the silica structure in the aggregate phase and impregnation of capillary pores by the dissolved silicate.

The formation of alkali-silica gels in the cement paste produces a lower pH locally, which induces dissolution of calcium ions from previously stable $\text{Ca}(\text{OH})_2$. The role of $\text{Ca}(\text{OH})_2$ and the participation of calcium ions in the formation of alkali-silica gels have been investigated by Wang and Gillott (1991a, 1991b). From experiments, they concluded that $\text{Ca}(\text{OH})_2$ has two major functions: firstly acting as a buffer to maintain a high pH (>12.4) and thereby maintaining a high concentration of hydroxyl ions in pore solutions, and secondly, calcium ions may exchange for alkali ions on silica gels leading to further production of a swelling alkali-silica complex.

Wang and Gillott (1991a) proposed a reaction mechanism in four steps illustrated in Fig. 7:1. The reaction mechanism assumes an alkaline solution ($\text{pH} > 12.4$) and surface attack on highly reactive aggregate (opal).

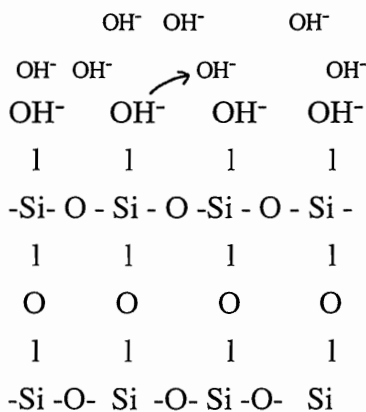

Fig.7:1. a) Original surface structure of opal (amorphous silica). The silanol groups are attacked by hydroxyl ions (acid-base reaction).

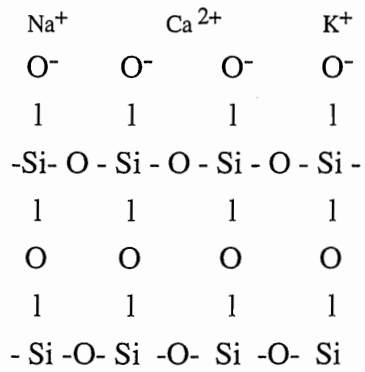

Fig 7:1. b) Exchange of alkali and/or calcium ions for protons on the surface of silanol groups.

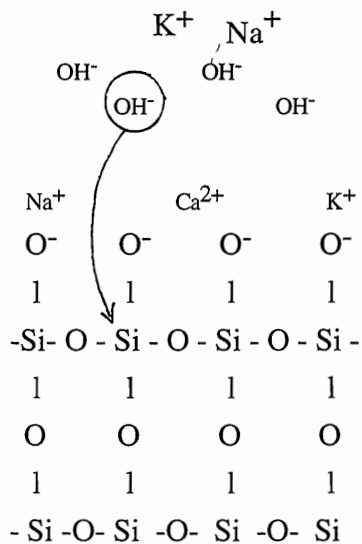

Fig 7:1. c) Alkali attack on internal Si-O-Si bonds of OH⁻. Formation of internal silanol groups.

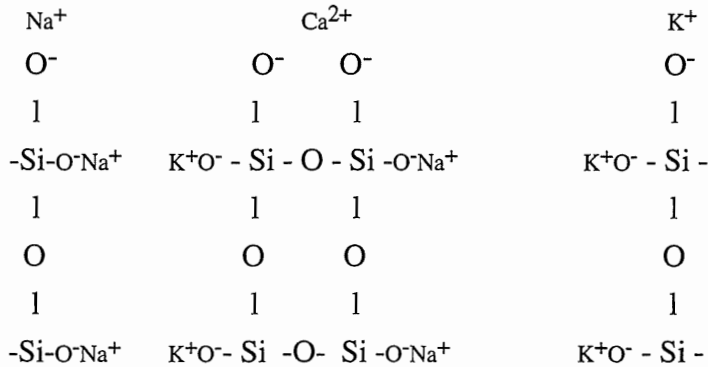

Fig 7.1. d) Exchange of alkali ions for protons on internal silanol groups (formation of swelling alkali-silica complex)

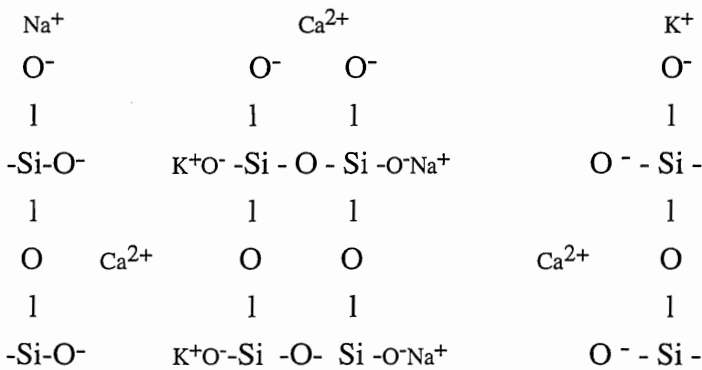
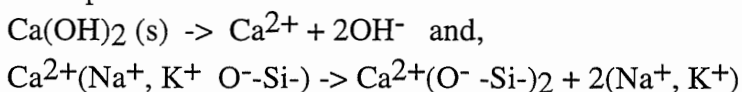
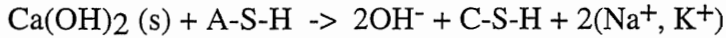

Fig 7:1. e) Exchange of calcium ions for alkali ions (formation of non-swelling calcium-alkali-silica complex in the cement paste)

The loosening of the silica structure is accomplished when the internal Si-O-Si bridges are broken down and Na-silicates are formed (N_2SiO_4 , stage c). In Fig 7:1 the substitution between alkali and Ca ions takes place in the cement paste, where the already formed alkali-silica gel is in contact with pore solutions containing Ca^{++} ions. The substitution takes place because Ca-O bonds have a higher electrostatic energy than Na (K)-O bonds. The incorporation of Ca^{2+} in the alkali-silica gel structure induces the dissolution of Portlandite which generates more hydroxide ions. This maintains a high pH level (>12.4) in the pore solution. The reactions are:



or,



where A-S-H is the alkali-silica gel and C-S-H the calcium silica gel. The solubility of Portlandite Ca(OH)_2 as a function of dissolved NaOH (or KOH) is presented in Fig. 7:4.

The substituted alkali ions enter the pore solution and potentially, are free to participate in new reactions with silica. However, it should also be noted that even if the reactions described tend to keep pH above that of Portlandite in equilibrium with water there is at the same time a net consumption of OH^- ions by the formation of C-S-H phases. This OH^- consumption is balanced by the induced dissolution of Portlandite.

Alkali ions diffuse to the reaction sites before calcium ions because the solubility of NaOH and KOH is much higher than that of Ca(OH)_2 and therefore are more readily available for the exchange reaction. The solubility of NaOH, KOH and Ca(OH)_2 in water at various temperatures is shown in Fig.7:2 and 7:3.

7.4 Composition of the reaction product

In accordance with the facts reviewed above (Wang and Gillott, 1991 a,b) and investigations carried out at CBI (Lagerblad and Trägårdh, 1992; Lagerblad and Utkin, 1993) the final product is a calcium silica gel (C-S-H-complex) which eventually attains crystalline order. The C-S-H product forms a solid solution between the approximate limits 0.85-1.70 mole ratio (Ca/Si) and the stability/solubility of the C-S-H-gel in alkaline solution is dependent on the calcium content and the Ca/Si ratio of the precipitated C-S-H complex. Bennet et al. (1992) calculated the predicted solubility of C-S-H in the system $\text{CaO-SiO}_2\text{-H}_2\text{O}$ and compared it with experimental data from the literature (Fig.7:5). The diagram shows that the C-S-H-gel complex is stable in alkaline solution when the Ca/Si ratio is 1.0 or less. Savage et al. (1992) conducted experiments with quartz and synthetic cement pore solution containing NaOH, KOH and Ca(OH)_2 (mixed alkali hydroxide solution) and biotite/feldspars and calcium hydroxide solution at 70 °C. They found that the Ca/Si ratio of the secondary C-S-H products ranged from 0.5 (mixed alkali hydroxide solution) to 1.5 (calcium hydroxide solution) and that the fluid phase lost calcium and gained silica. This demonstrates that the solid and fluid compositions try to equilibrate with time. Savage et al. also concluded that the Ca/Si ratio of the C-S-H products also reflect the rate of dissolution of the primary mineral phase, the ratio decreasing as the rate of dissolution increases.

Chemical compositions of C-S-H products from quartz-synthetic cement pore fluid experiments at 70 °C (Savage et al., 1992) and from a concrete construction damaged by alkali-silica reaction (Lagerblad and Trägårdh, 1992), are presented in Table 7:2.

Table 7:2

1,2= quartz-mixed alkali hydroxide solution (Savage et al.). 3= gel product inside reactive aggregate, 4= gel product in cement paste (Lagerblad and Trägårdh, 1992). Weight % oxide.

	1	2	3	4
SiO ₂	64.50	53.10	67	50
Al ₂ O ₃	0.70	-	-	-
CaO	21.00	23.00	13	48
Na ₂ O	4.70	11.40	10	1
K ₂ O	9.10	12.20	10	-

3 and 4, SEM-EDX analysis normalised to 100%. SEM=Scanning electron microscopy, EDX=Energy dispersive X-ray analysis.

1 and 2, ATEM analysis. ATEM=Analytical transmission electron microscopy

Reaction between cement pore solution and other primary silicates than quartz, such as micas or feldspars, may lead to reaction products with slightly different compositions. Experimental results from Savage et al. (1992) with feldspars (microcline, albite) and a calcium-rich solution at 70 °C indicate that precipitates with tacharanite (Ca₁₂Al₂Si₁₈O₅₁(OH)₂ x 18H₂O) and hydrogrossular (Ca₃Al₂Si₂O₈(OH)₄) composition may form. Biotite interaction with Ca(OH)₂-rich cement pore fluid gave hydrogarnet as a product.

However, at the deep repository other conditions than those which governed the laboratory experiments will prevail. Mixing between groundwater and cement pore fluids will eventually alter the initially formed C-S-H product. After calculations of groundwater residence times (duration in excess of 3 years in 1 m³ of rock) and thermodynamic modelling, Savage et al. (1992) suggested that the initial C-S-H product may be replaced by zeolites and/or feldspars.

Examination of samples from construction concrete affected by ASR has shown that the gel product attains crystalline order and eventually reach zeolite (heulandite-clinoptilolite) composition (Marfil and Maiza, 1993).

7.5 Rate of reaction and the dependence of pH and temperature

Examples of recent studies of the reaction of silicates with alkaline fluids are: Chou and Wollast (1984,1985), Knauss and Wolery (1986,1988,1989), Carroll-Webb and Walther (1988), Brady and Walther (1990) and Savage et al. (1992). These studies include the determination of mineral dissolution rates and kinetic reaction mechanisms.

Experiments from Knauss and Wolery (1986,1988,1989) and Savage et al. (1992), indicate that the dissolution is not diffusion-limited. The dissolution rate of quartz, albite and muscovite is highly dependent on pH, especially in the alkaline regime. The rate of dissolution of silicates has been found to be 3-4 orders of magnitude greater at pH values about 12 than at neutral pH (Figs 7:6, 7:7 and 7:8). The solubility of quartz versus pH is given in Fig. 7:9 (Krauskopf, 1956).

Reaction between quartz and alkaline solution (Savage et al. 1992) indicates a linear increase of Si in the fluid phase (after the removal of Ca from the solution and precipitation of C-S-H). A diffusion-limited dissolution would give Si concentrations proportional to the square root of time. The rate of growth of the reaction product is limited by the supply of silica from the dissolving mineral phase.

In alkaline solutions, the initial surface-attack on the silanol groups and the dissolution rate of the reactive particles (see Fig. 7:1), is dependent on the activity of the hydroxyl ion (acid-base reaction). The attack will be surface controlled, if the reactive particles have a low porosity and the surface area (particle size) will have a strong effect on the reaction rate. In this case, the reaction product will precipitate on the surface of the primary silicate. If the porosity of the mineral particles or aggregates is high, the reaction products will be found also within the reactive particles. Dissolution will take place along grain boundaries, cleavage planes and microcracks and the rate of dissolution will depend on particle volume. The latter is often the case with Swedish aggregates, flint aggregates from Scania being the exceptions (Lagerblad and Trägårdh, 1992).

In unsaturated solutions far from equilibrium with respect to primary silicates and reaction products, the dissolution rate can be expressed as follows (Helgeson et al., 1984, Lasaga, 1984):

$$r = \frac{dC_i}{dt} = \frac{A}{V} v_i \times k (H^+)^{-\pi} \quad (1)$$

r = rate at which reactant mineral is dissolved

C_i = aqueous concentration of component i (e.g. Si) in the pore solution (not incorporated into reaction products), released by the dissolution of a specific mineral

t = time

A = Surface area of the mineral (low porosity)

V = volume of fluid (porosity approx. 30 % by volume of concrete at W/C = 0.40-0.50, see Table 6:6)

v_i = Stoichiometric content of component i in the mineral (e.g. Si)

k = rate constant of the mineral

H^+ = activity of hydrogen ion. The participation of OH^- can be represented by the activity of the hydrogen ion if acid-base dissociation of water is assumed.

π_{H^+} = Exponent of hydrogen ion in solution. π_{H^+} take positive, negative or zero value depending on the pH interval (Figs. 7:6, 7:7, 7:8). In alkaline solutions, quartz has a π_{H^+} value of +0.5.

The specific surface area (A) as a function of grain size is shown in Fig. 7:14 and grain size distribution (0-8 mm) for concrete is shown in Fig. 7:15. The pore volume (capillary + gel pores) as a function of W/C ratio is shown in Fig. 7:16.

Note that in the rate equation a surface attack of the mineral is assumed. This is correct only if the reactive particles have a low porosity. In case the reactive mineral particles have high porosity, the particle volume must be taken into account. The equation is valid if only the hydrogen/hydroxyl ion is involved in forming an activated complex. Activity terms would need to be included for other participating species such as Na^+ , K^+ , and Ca^{++} . However, for the initial dissolution process in alkaline solutions, the hydroxyl ion is the most active ion when the activated complex is formed (break of internal Si-O-Si bonds). Therefore, it is believed that the equation and rate constants derived from it, can be used for estimating the dissolution rates for silicates. Average dissolution rates (limiting rates, estimated after steady state has been reached) for quartz, albite and muscovite at various pH and at 70 °C have been measured by Knauss and Wolery (1986, 1988 and 1989) and are given in Table 7:3. Rate constants and π_{H^+} values at 70 °C are given in Table 7:4 (see also Figs. 7:6, 7:7 and 7:8).

Table 7:3

Average dissolution rates (limiting rates) as a function of pH at 70 °C for quartz, albite and muscovite. mol/cm² x s

pH	Quartz	Albite	Muscovite
6.2	1.5 x 10E-15	7.9 x 10E-16	2.8 x 10E-17
7.8	2.2 x 10E-14	7.9 x 10E-16	4.1 x 10E-17
8.8			1.1 x 10E-16
9.6	2.6 x 10E-13		1.2 x 10E-16
10.2	3.0 x 10E-13		
10.8	6.6 x 10E-13	6.6 x 10E-15	1.6 x 10E-16
11.3*	1.0 x 10E-12	2.5 x 10E-14	
11.8	1.1 x 10E-12	2.8 x 10E-14	4.5 x 10E-16
12.2*	5.0 x 10E-12	1.3 x 10E-13	

* From Savage et al.(1992)

Table 7:4

Rate constants (k) in mol/cm² x s and π_{H^+} values for quartz, albite and muscovite at various pH intervals and at 70 °C (Knauss and Wolery, 1986, 1988, 1989)

pH	Quartz	π_{H^+}	Albite	π_{H^+}	Muscovite	π_{H^+}
1-6	10E-15.3	0				
1-3			10E-12.2	-1.0		
3-8			10E-15.1	0		
1-5					10E-14.7	-0.37
5-7					10E-16.6	0
6-12	10E-17.8	0.5				
8-12			10E-19.5	0.5		
7-12					10E-18.1	0.22

The π_{H^+} value corresponds to the slope of the line in rate versus pH diagrams (see Figs. 7:6, 7:7 and 7:8). When $\pi_{H^+} = 0$, the dissolution rate (r) is equal to the rate constant (k) which suggests that only water is involved in breaking the Si-O bonds to form an activated complex at the surface of the dissolving crystal. When π_{H^+} takes a negative value, as in the acidic region for albite and muscovite, the hydrogen ion is active and the dissolution rate varies positively with the hydrogen ion activity. When π_{H^+} takes a positive value the hydroxyl ion is active and the dissolution rate varies positively with the hydroxyl ion activity (alkaline solutions). In the alkaline regime, the order of the dissolution rate constants is quartz > albite > muscovite, which indicates that quartz is more soluble than feldspar and muscovite in alkaline solution. In near neutral solutions the order of the rate constants is albite > quartz > muscovite, which is not entirely in accordance with the weathering sequence found in nature (feldspar > muscovite > quartz). In nature, feldspars are altered to clay minerals (e.g. kaolin/montmorillonite) faster than quartz is dissolved. The formation of kaolin is favoured by acidic solutions while alteration to montmorillonite is favoured by alkaline solutions or if an excess of magnesium ions exist. If feldspars are in contact with solutions containing an excess of potassium ions, the clay mineral illite may form. In the same way muscovite is often altered to illite.

Dissolution rate and solubility of silicates are also dependent on temperature. Both increase with temperature. The solubility of quartz and amorphous silica as a function of temperature is given in Fig. 7:10 (Blatt et al., 1972). Dissolution rate constants at 25 °C for quartz and albite are given in Table 7:5 (from Knauss and Wolery, 1986,1988).

Table 7:5

Rate constants (k) for quartz and albite at 25 °C, mol/cm² x s. The π_{H^+} values are the same as in Table 7:4.

pH	Quartz	Albite
1-6	10E-17.4	
1-3		10E-15.0
3-8		10E-16.4
8-12		10E-20.3
6-12	10E-20.3	

Note that the dissolution rate constants for quartz and albite (feldspars) are the same in alkaline solutions at 25 °C.

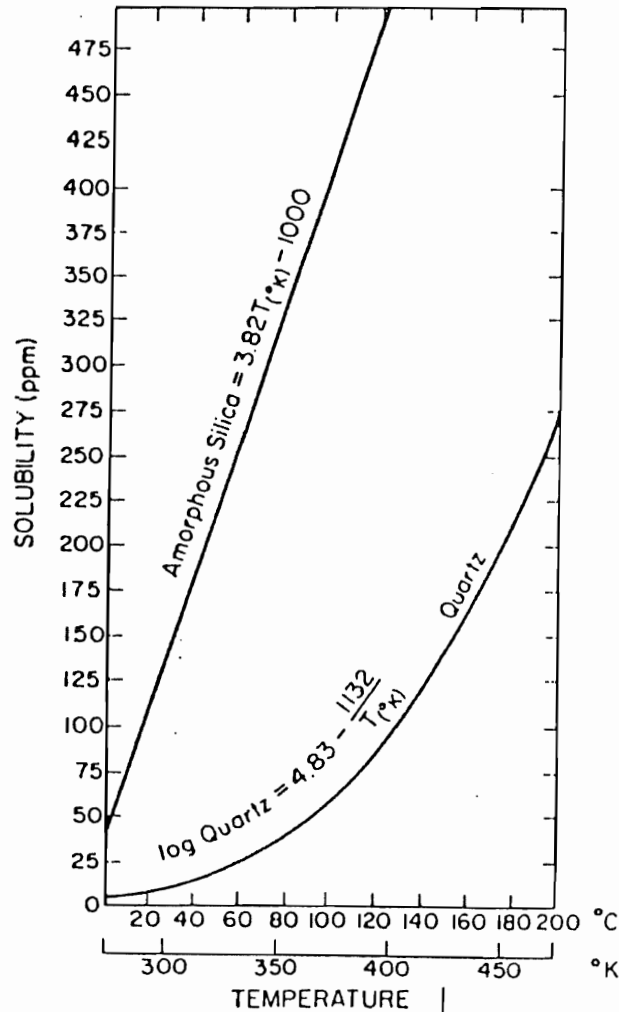

Fig. 7:10. Solubilities of amorphous silica and quartz as a function of temperature (Blatt et al., 1972).

However, from laboratory experiments with concrete containing reactive quartz aggregates, contradictory results exist concerning the temperature influence on expansion behaviour. The expansion of concrete prisms indicate the rate and amount of secondary solids produced by the reaction between primary silicates and cement pore solution. Hobbs (1993) tested concrete prisms containing opal (surface-reactive amorphous silica) and christobalite (crystalline quartz variety) at various temperatures. The expansion with opal aggregate at 10 °C was greater than at 50 °C and by far the greatest expansion where measured at 20 °C (Fig. 7:11). The expansion with christobalite showed reverse results, the 50 °C expansion greater than the 10 °C and 20 °C expansion (Fig.7:12). Present knowledge cannot explain this behaviour.

7.6 Effect of the alkali-silica reaction on porosity and water absorption

At CBI, measurements of water absorption on samples both affected and unaffected by alkali-silica reaction have been carried out (Trägårdh and Lagerblad, in prep. 1995). The amount of water taken up during the water absorption test is an indication of the capillary porosity. Two groups of samples with W/C ratios of 0.50 and 0.60 were measured. Slite Std P cement with both reactive and unreactive flint aggregates were used. The samples have been stored about four years in a climatic chamber with 100% RH (20 °C), prior to the water absorption test. Measured capillary porosity is shown in Figs. 7:17, 7:18 and results from the water absorption test are shown in Figs. 7:19 a, b, 7:20 a, b.

Measured capillary porosity from water absorption test demonstrates that samples affected by the alkali-silica reaction (ASR) have reduced capillary porosity compared to samples unaffected by ASR (Figs.7:17,7:18). The water uptake in capillary pores occurs before the "nick-point time" is reached (Figs. 7:19 a and 7:20 a). The "nick-point time" is reached when a sudden decrease in water absorption takes place. The slope of the curve before "nick-point time" in Figs. 7:19 a and 7:20 a indicates the absorption rate in the capillary pores. The content of smaller air voids has probably also been reduced in the ASR affected samples, which is indicated by the slope of the water absorption curve after "nick-point time". As a consequence of the reduced porosity the absorption rate and the volume of pores filled are lower in the ASR affected samples (Figs. 7:19 a and 7:20 a). This is due to the "sealing effect" when large capillary pores and small air voids are filled with ASR-gel, which densifies the cement matrix.

The "sealing effect" is enhanced when crack widths due to ASR expansion are small. This is shown in Figs. 7:19 b and 7:20 b where samples with crack widths below 0.2-0.3 mm have a lower absorption rate than samples with crack widths above 0.3 mm.

The reduced porosity for samples affected by ASR after the test period is about the same indicating a 25% decrease for samples with W/C ratio 0.50 and a 50% decrease for samples with W/C ratio 0.60 (Figs.7:17, and 7:18).

As a comparison a densification of the cement structure is observed in concrete containing silica fume or blast furnace slag. However, the C-S-H gel produced does not lead to cracking (non-expansive) and the water absorption curve is similar to samples with small crack widths. Concretes with a very low water cement ratio (< 0.35) also

show a similar absorption curve. This is due to a discontinuous (segmented) capillary pore system.

The degree of saturation (moisture level) will be higher in field concrete affected by ASR (Putterill and Oberholster, 1985). However, after a certain time period the moisture level will be the same (fully saturated) in concrete situated under water, regardless if the concrete is subjected to ASR or not. This is the case in the deep repository where the concrete eventually will reach a fully saturated state. ASR will reduce porosity and densify the cement structure for a long time period after the fully saturated state has been reached.

Petrographic examination of samples taken from constructions affected by ASR, often show ASR-gel in air voids and as impregnation in the cement paste. The gel product is often associated with secondary ettringite.

Experiments on concrete beams exposed to natural environmental conditions in South Africa confirm the results given above (Putterill and Oberholster, 1985). The authors found that in concrete cast with high alkali cement the reaction product (ASR-gel) tends to seal the pores in the cement matrix and thus reduces the capacity for water absorption. The ASR-gel is also hygroscopic and incorporates water which reduces the drying rate of the concrete leading to a high moisture level. When cracks occurred, the water absorption increased because large amounts of moisture was taken up by the cracks, which further increased the moisture level in the concrete. The investigation also found that concrete beams cast with a low alkali cement has a higher capacity of water absorption due to the fact that small diameter pores do not become filled with reaction product if short time scales are considered. However, when the degree of hydration increases with time the finer pores become closed and the low alkali concretes capacity to absorb water is reduced. This is shown in Table 7:6 where the decrease in porosity with time (degree of hydration) has been calculated by CBI for Degerhamn Std P and Slite Std P cement. The calculations follow a norm developed by the Strategic Highway Research Program (SHRP) in USA.

In concrete made of cement with a low alkali content (Degerhamn Std) and containing low-reactive aggregates, there would only be a small amount of reaction product, if short time scales are considered. However, for the deep repository long time scales have to be considered. In this case, there will always be a certain amount of ASR-gel formed, even though the reaction will be slow. Moreover, concrete surrounded by

groundwater having a NASK water composition, will not have its pore water depleted of alkali ions.

The ASR-gel eventually formed, will reduce the porosity and densify the cement structure. This will occur in addition to the effect of reduction in porosity due to increasing degree of hydration with time (Table 7:6). The formation of ASR-gel under these conditions will probably not induce cracking because of the slow reaction rate. The slower the reaction rate and the formation of ASR-gel the more likely there is time for the gel to attain a non-expansive calcium-silica composition before enough pressure has been built up to induce cracking.

Table 7:6

Change of total porosity (volume %) with time at various water cement ratios for Degerhamn Std P and Slite Std P cement. Porosities calculated at CBI according to guidelines from Strategic Highway Research Program (SHRP).

Degerhamn Std					
Time (days)	3.0	7.0	28.0	∞	W/C
Porosity (volume%)	36	30	26	3.3	0.40
"	45	39	36	16	0.50
"	51	46	43	26	0.60

Slite Std					
Time (days)	3.0	7.0	28.0	∞	W/C
Porosity (volume%)	35	29	27	11.6	0.40
"	44	39	37	23	0.50
"	50	46	44	32	0.60

7.7 Scenario at the waste disposal site and discussion

Although dissolution is diffusion-limited and highly depend on pH of the pore solution, the migration of cations (Na^+ , K^+ , Ca^{++}) to the reaction sites is diffusion

controlled. Mixing between groundwater and cement pore solution will lead to chemical changes of both the pore water and the surrounding water. Pore water and groundwater compositions will eventually equilibrate and the driving force is the difference in ion concentration (Fick's law). Chemical compositions of initial reaction products and pore solution will change when longer time scales are considered. From laboratory experiments (Savage et al., 1992) and analysis from damaged concrete structures (Table 7:2), it can be concluded that the initial reaction product is a C-S-H complex. The initial chemical changes of the pore solution are dominated by calcium loss. Savage et al. (1992) used reaction path - solubility computer programmes (EQ3/6) in order to extrapolate the experimental data from albite dissolution to longer time scales (Fig. 7:13). The results suggest a rapid increase of silica concentration in the fluid phase and that the precipitation of zeolites/feldspars eventually will take place.

The loss of Ca^{++} (and Na^+ , K^+ when zeolites/feldspars are formed) from the pore solution, will lead to local reduction of pH between 11.3 and 12.1 around secondary solids. Decreasing pH will locally dissolve $\text{Ca}(\text{OH})_2$. Mixing between groundwater and pore solution will also reduce pH, which initiates further dissolution of $\text{Ca}(\text{OH})_2$ from the cement phase. Calcium hydroxide buffers the pore solution to pH 12.4.

After closure of the repository, infilling of groundwater will take place. It is assumed that the groundwater will have Allard water composition (Table 7:1) during the first period of time. With time, this water is assumed to be successively replaced by deep saline groundwater with NASK water composition. Concrete in contact with surrounding groundwater will be subjected to transport of pore water components by diffusion. Aqueous species in pore water and groundwater will try to equilibrate and the rate of diffusion will depend on factors such as porosity, pore structure and concentration gradients of aqueous species (e.g. Ca^{++} , Na^+ , K^+ , OH^-).

The deductions below consider two cases: 1) Concretes in contact with groundwater which has Allard water composition, 2) Concretes in contact with groundwater which has NASK water composition. It is assumed that the concretes consist of Degerhamn Std P cement and have pore water compositions as shown in Table 7:1.

Concrete in contact with groundwater which has Allard water composition will have its pore water depleted in alkali and hydroxyl ions. Alkali and hydroxyl ions are the first species to diffuse out into the groundwater. It has been estimated that the main alkalinity will be depleted after about 100 years (Rasmuson et al., 1987). Depletion of alkali ions will increase the solubility of $\text{Ca}(\text{OH})_2$ in the pore solution (see Fig. 7:4). From this

follows a reduction of pH and the dissolution rates of common rock forming silicates will decrease (see Table 7:5). In fact, formation of secondary solids due to cement-aggregate reactions in concrete surrounded by groundwater with Allard water composition will probably be insignificant. Instead, the reduction of pH and depletion of alkalis will lead to dissolution of $\text{Ca}(\text{OH})_2$, and degradation of the cement phase will dominate. Dissolution of $\text{Ca}(\text{OH})_2$ will also lead to diffusion of calcium ions from concrete to groundwater. When all the $\text{Ca}(\text{OH})_2$ has been dissolved, the pH will drop below 12.4 and dissolution of silicate phases in the cement gel will follow. During this stage the pH will be maintained slightly above 10.

Concrete in contact with groundwater which has NASK water composition will also have its pore water depleted in hydroxyl and potassium ions. But contrary to the case with Allard water, Ca^{++} , Na^+ , SO_4^{--} and Cl^- ions will diffuse into the concrete from surrounding groundwater with NASK water composition. After mixing with groundwater, the net balance of the total alkali content in the pore water will, however, be fairly stable or slightly increased (110 - 140 mM, Table 7:1). The stable alkali and increasing calcium content of the pore water will eventually decrease the solubility and probably suppress the amounts of $\text{Ca}(\text{OH})_2$ in solution. However, initially the dissolution rate of $\text{Ca}(\text{OH})_2$ will increase with temperature (Onofrei et al., 1992).

The rise in temperature in the repository during post-closure time (maximum about 50 °C in concrete), will further reduce the potential solubility of $\text{Ca}(\text{OH})_2$ because of the decrease in $\text{Ca}(\text{OH})_2$ and increase in alkali hydroxide solubility at higher temperatures (see Figs. 7:2 and 7:3).

The decreasing pH will slow down the dissolution rates of common rock forming minerals (e.g. quartz, feldspars, muscovite) but dissolution will still continue. There will be no lack of alkali (Na^+) and calcium ions. The pH of the groundwater is slightly alkaline (pH=8.2) which will ensure that hydroxide ions are available at the reaction sites. If a long time scale is considered, secondary precipitates due to dissolution of primary silicates will form. The reaction will corrode small quartz grains at the surface and dissolve silica from the inside of large porous aggregates. The reaction product will be a C-S-H complex which will precipitate and fill the capillary and gel pores in the cement matrix. To some extent also the air voids will be filled. The result is a cement phase with higher density and decreasing porosity. It is unlikely that cracking of concrete due to volume increase of the reaction product will occur. Slow reaction rates and the availability of Ca^{++} ions in the pore water (which can substitute for alkali ions in the newly formed

silica gel), make it probable that a non-swelling Ca-rich silica gel will dominate. With time, the C-S-H complex might be replaced by zeolites and/or feldspars.

It has commonly been observed (Jones and Poole, 1986, Soers and Meyskens, 1989, Oberholster et al., 1992, Lagerblad and Trägårdh, 1992) that silica-rich ettringite (thaumasite) is formed as a secondary reaction product in concrete suffering from alkali aggregate reactions. Ettringite is formed when sulphate ions are remobilised from the cement gel due to moist migration and crystallizes along aggregate borders, in cracks and air voids. There has been doubt whether this type of ettringite formation can cause additional expansion and cracking in concrete, but it is now believed that this is not the case (Idorn, 1992). The ettringite crystallizes where space is available and preferentially in the vicinity of silica gel. Ettringite can also crystallize within the cement gel itself like a "cancer growth" if an excess of sulphate ions exists in the pore water (sulphate attack from an external source), or if sulphate containing phases in the cement gel become unstable due to temperature changes (e.g. heat curing). Delayed ettringite formation of this type can cause expansion and cracking of concrete due to volume increase when ettringite crystallizes. This in turn, leads to faster degradation of the cement paste.

In the case of concrete surrounded by groundwater having NASK water composition chloride ions will diffuse into the concrete and the pore water will be enriched in chloride ions. This might lead to alterations in the cement gel and formation of Friedel's salt at the expense of monosulphate and ettringite which will release sulphate ions to the pore solutions. Gypsum is the stable sulphate phase at a pH of 10 and less dissolution of gypsum will increase the concentration of sulphate ions in the groundwater.

7.8 Conclusions

Concrete in contact with groundwater of Allard water composition will mainly be influenced by dissolution and degradation of the cement phase. Diffusion of Na^{++} , K^{+} , Ca^{++} and OH^{-} ions out from the concrete will eventually enrich groundwater in alkali ions and increase the pH. Dissolution of the aggregate phase and precipitation of secondary reaction products will be subordinate.

Concrete in contact with groundwater of NASK water composition will be subjected to alkali aggregate reactions if long time scales are considered. Secondary reaction products will precipitate in the cement paste and decrease its porosity. Decreasing porosity will

slow down diffusion rates and thereby the chemical exchange between pore water and groundwater. The dissolution rates will however be limited and the availability of Ca^{++} ions will make it probable that a non-swelling C-S-H-complex will form initially. This will densify the cement structure, but cracking will probably not occur if the aggregates used have a low reactivity. The C-S-H complex may be replaced by zeolites and/or feldspars with time. Degradation of the cement phase will be slower than with water of Allard water composition.

It should be pointed out that a scenario with a combination of the two modelled groundwater compositions, where groundwater with Allard water composition is successively replaced by groundwater with NASK water composition, is not discussed.

The high sulphate and chloride gradient between groundwater with NASK water composition and pore water makes it probable that these ions will diffuse into the concrete. The effect of this is treated separately in the report.

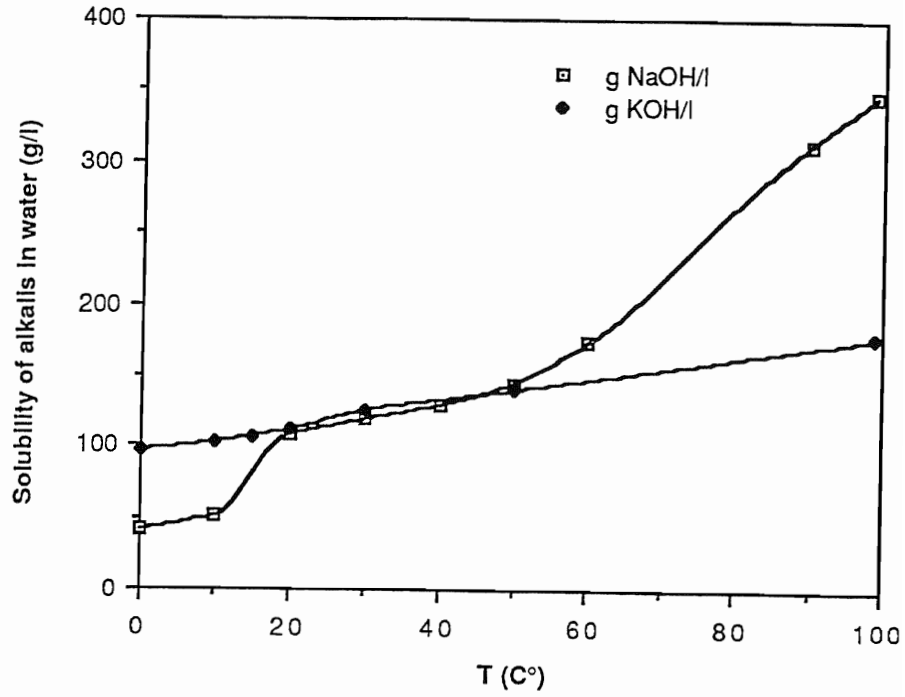

Fig. 7:2. Solubility of NaOH and KOH in water versus temperature (g/l).

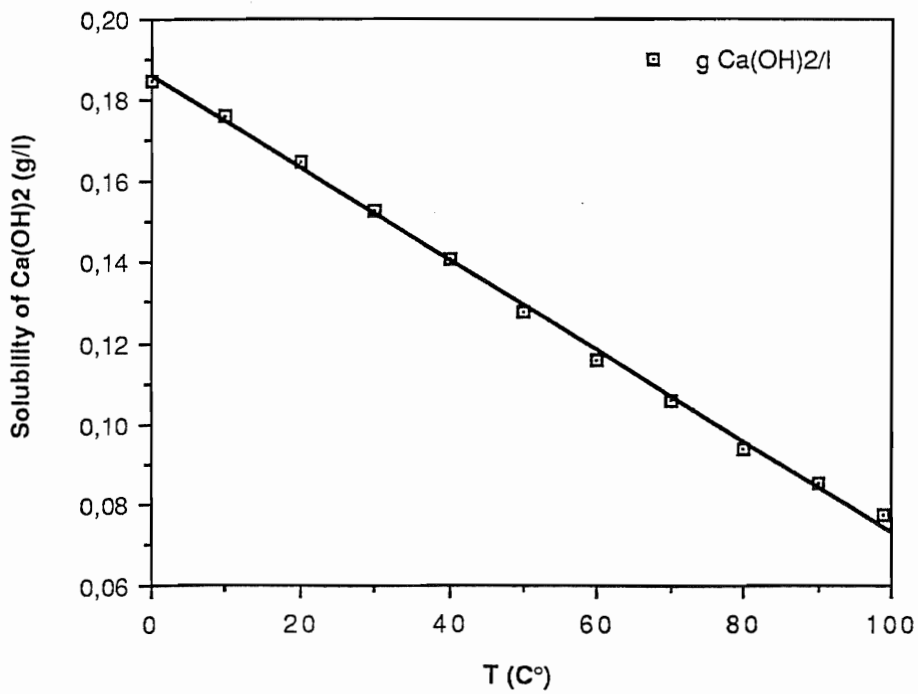

Fig. 7:3. Solubility of $\text{Ca}(\text{OH})_2$ in water versus temperature (g/l).

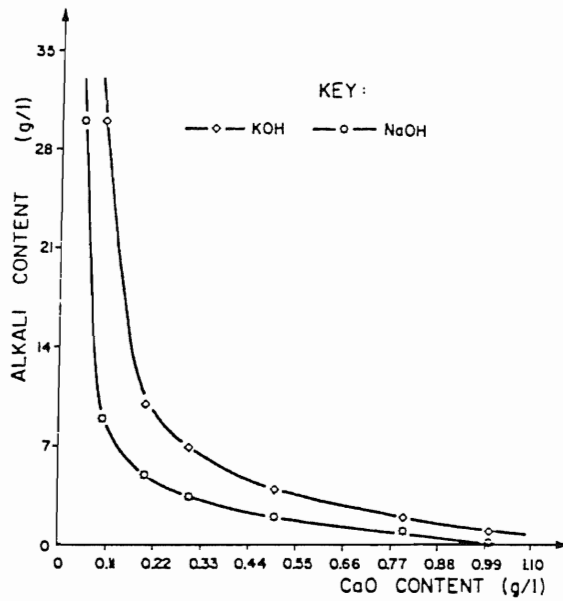

Fig. 7:4. Solubility of CaO in alkaline solution (from Wang and Gillott, 1991a and Xu, 1986).

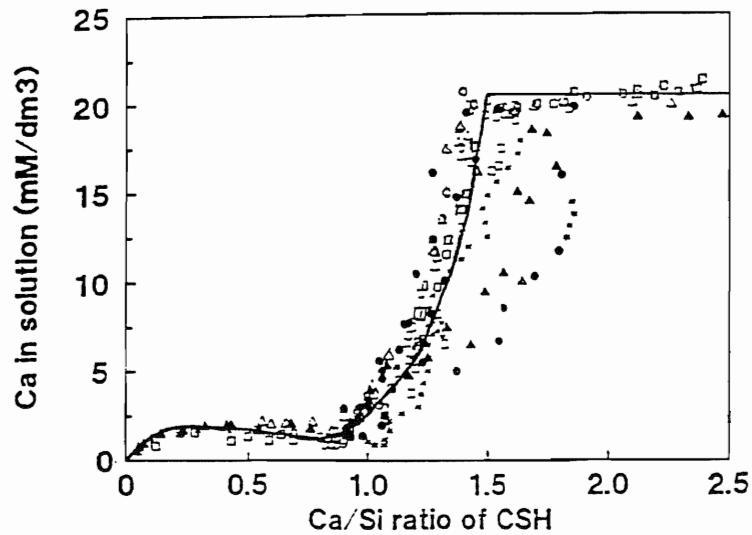

Fig.7:5. The predicted solubility of C-S-H in the CaO-SiO₂-H₂O system compared with available experimental data (from Bennet et al., 1992)

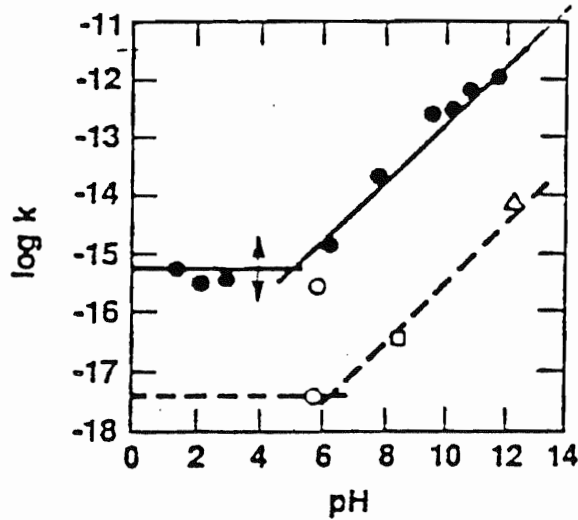

Fig.7:6. Plot of the quartz dissolution limiting rates ($\text{mol}/\text{cm}^2 \times \text{s}$) as a function of pH and temperature. \bullet = 70°C data from Knauss and Wolery (1988). \circ = rates calculated for 70°C and 25°C using Rimstidt and Barnes (1980) temperature function for quartz dissolution rates in distilled (neutral pH) water. Square = quartz dissolution limiting rate at 25°C and pH 8.4 from Stober (1967). Δ = Limiting rate at 25°C and pH 12.3 from Van Lier et al. (1960). Based on determination of Si concentration in solution at steady-state condition (limiting rates). The solution was kept far from saturation and equilibrium with quartz. Taken from Knauss and Wolery (1988).

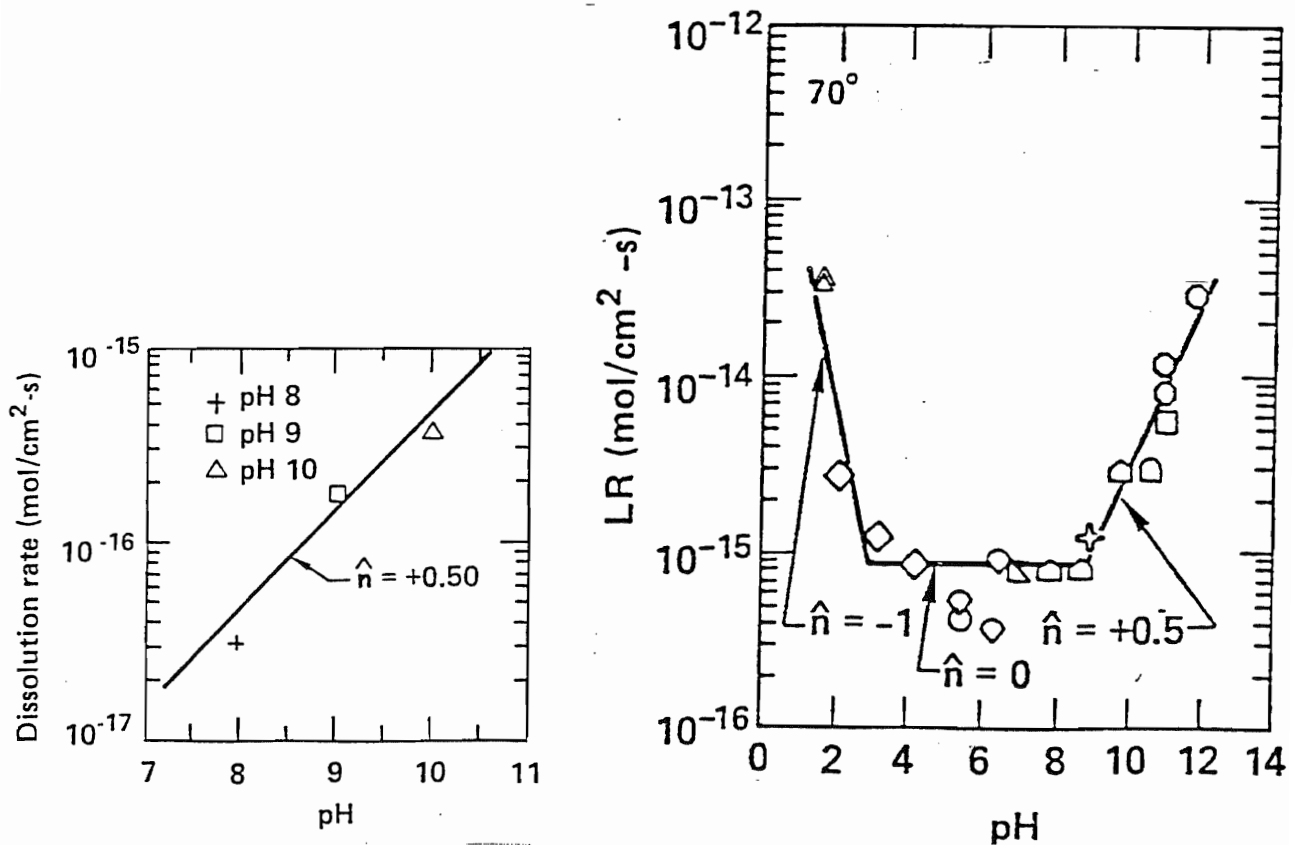

Fig.7:7 a and b. a) Plot of albite dissolution limiting rates at 25°C as a function of pH from Knauss and Wolery (1986). b) Albite dissolution limiting rates as a function of pH at 70°C from Knauss and Wolery (1986). \hat{n} (πH^+ in the text) = Exponent of the hydrogen ion activity term.

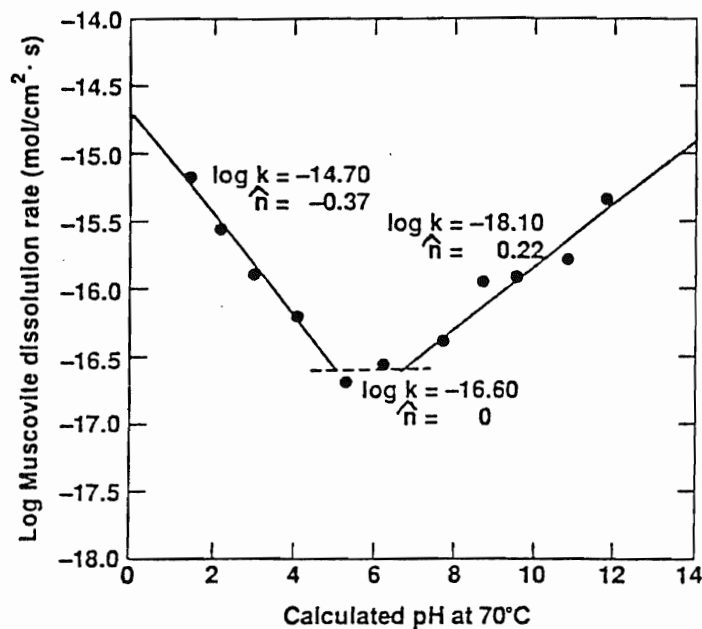

Fig. 7:8. Muscovite dissolution limiting rates at 70 °C as a function of pH from Knauss and Wolery (1989). \hat{n} = Exponent of the hydrogen ion activity term. k = Rate constants.

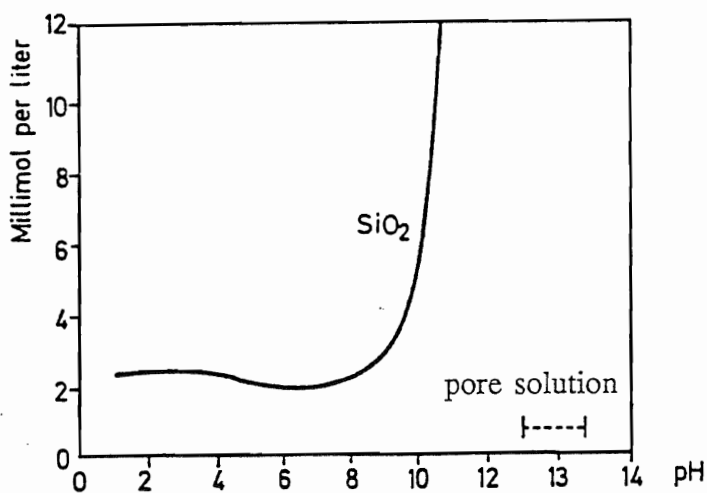

Fig. 7:9. Solubility of amorphous silica as a function of pH at 25 °C from Krauskopf (1956). At a pH above 8, the solubility increases dramatically, which results in the pore solution in the concrete being capable of dissolving amorphous silica and other forms of unstable silica. The dissolution rates of quartz start to increase at a pH slightly above 6 (see Fig. 6).

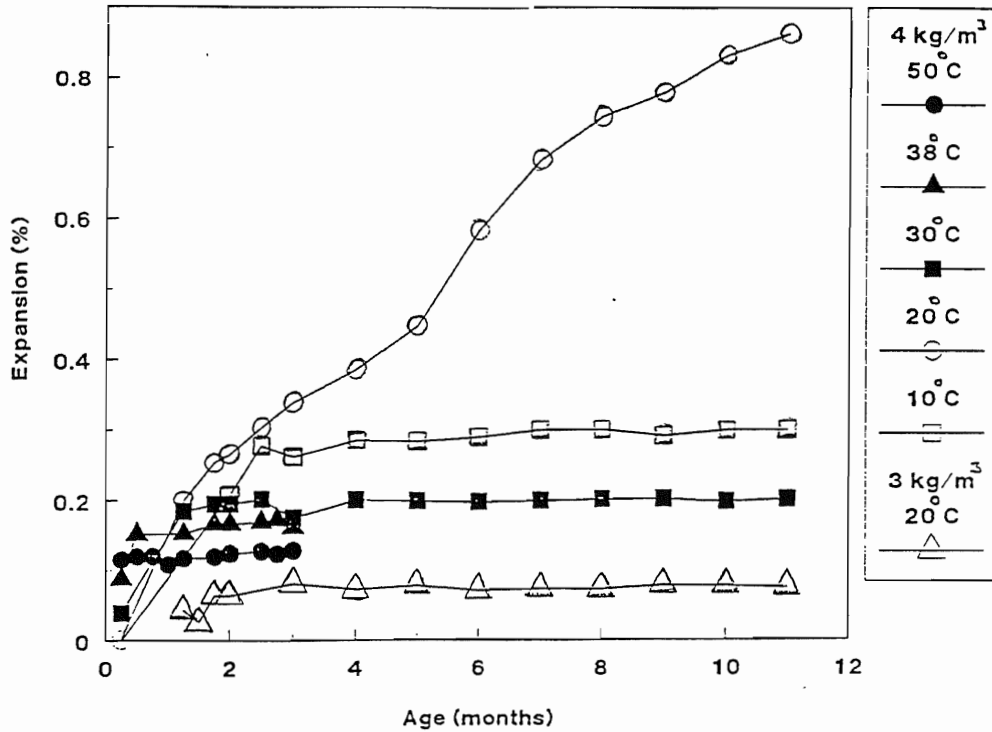

Fig.7:11. Influence of temperature upon expansion behaviour in concrete (Hobbs, 1993). Reactive aggregate = opal. Alkali content of concrete = 4 kg/m^3 based on concrete mix with 400 kg/m^3 OPC. For Degerhamn Std cement the alkali content would be 2.4 kg/m^3 and for Slite Std cement 4.8 kg/m^3 and W/C ratio = 0.47.

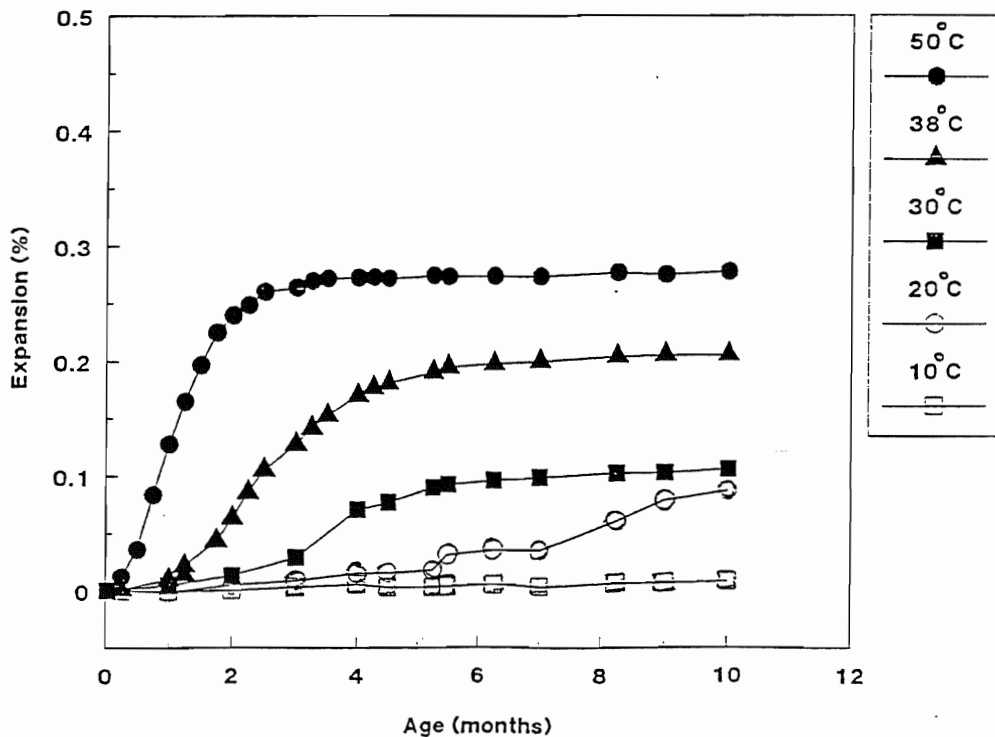

Fig.7:12. Influence of temperature upon expansion behaviour in concrete containing cristobalite, from Hobbs (1993). Alkali content 4 kg/m^3 based on concrete mix with 400 kg/m^3 OPC and W/C ratio = 0.47.

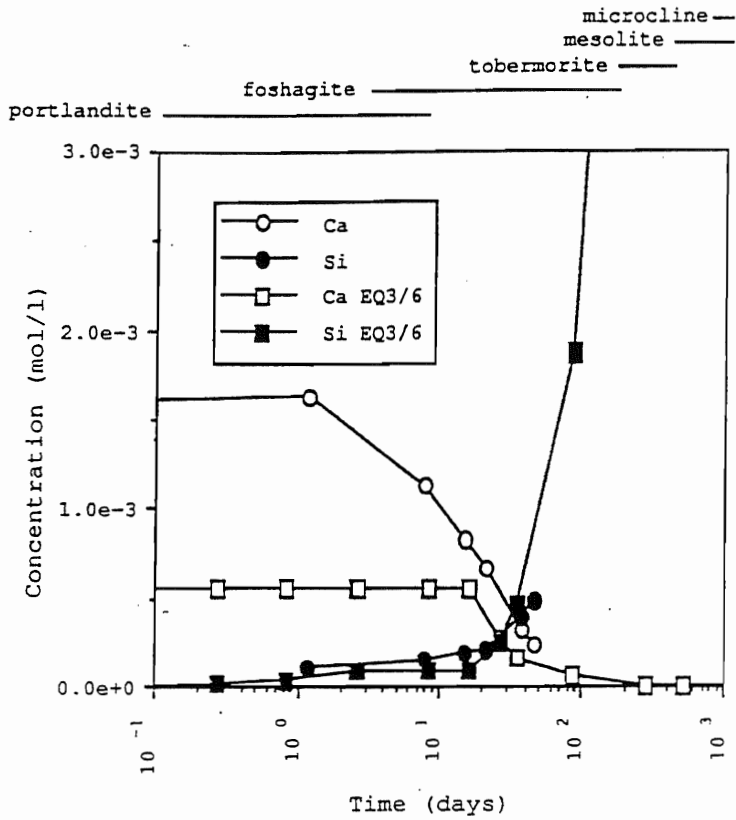

Fig. 7:13. Concentration-time data from Savage et al. (1992), for aqueous calcium and silicon from their experiment (circles) and EQ3/6 simulation (squares) of the reaction of albite with mixed alkali hydroxide-calcium hydroxide fluid. Minerals predicted by the EQ3/6 computation code is indicated on top of diagram.

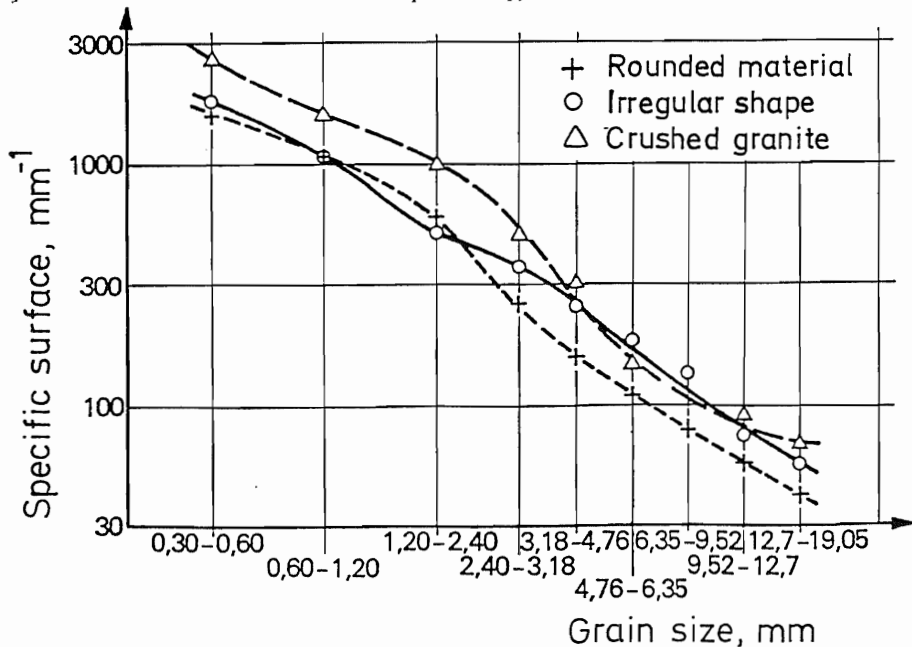

Fig. 7:14. Specific surface area for aggregates as a function of grain size (Shacklock and Walker, 1958, Betonghandbok, material, 1982)

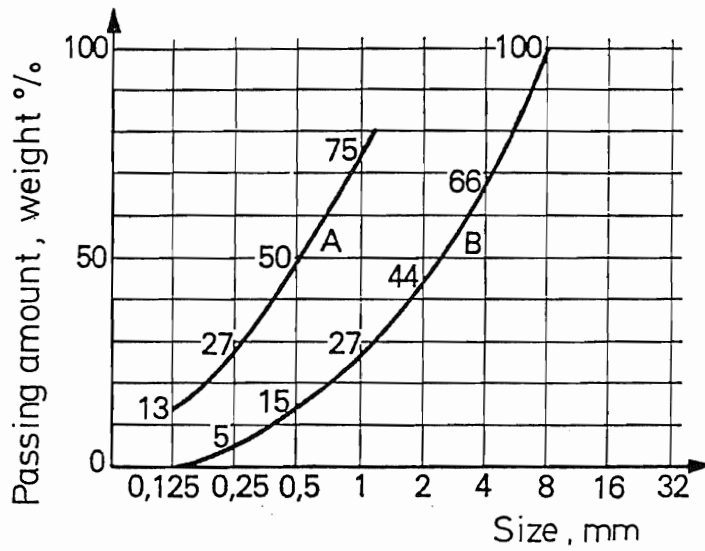

Fig. 7:15. Limiting curves for aggregate grain size distribution in concrete (0-8 mm), Betonghandbok, material, 1982.

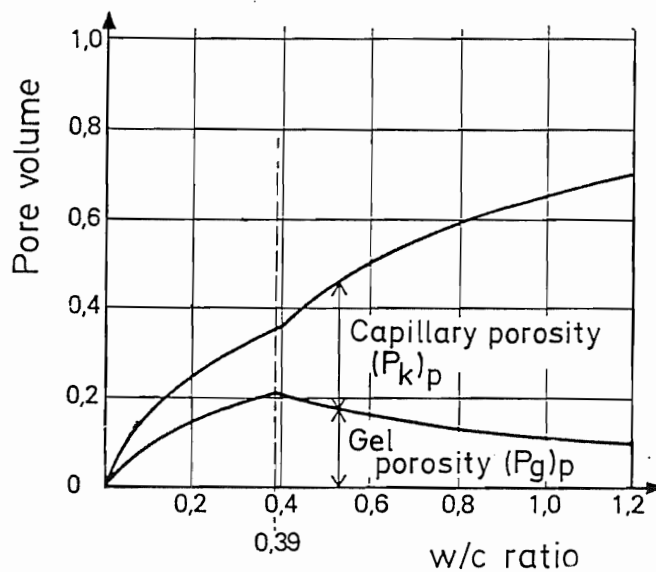

Fig. 7:16. Pore volume as a function of W/C ratio at 75% of maximal degree of hydration (Betonghandbok, material, 1982).

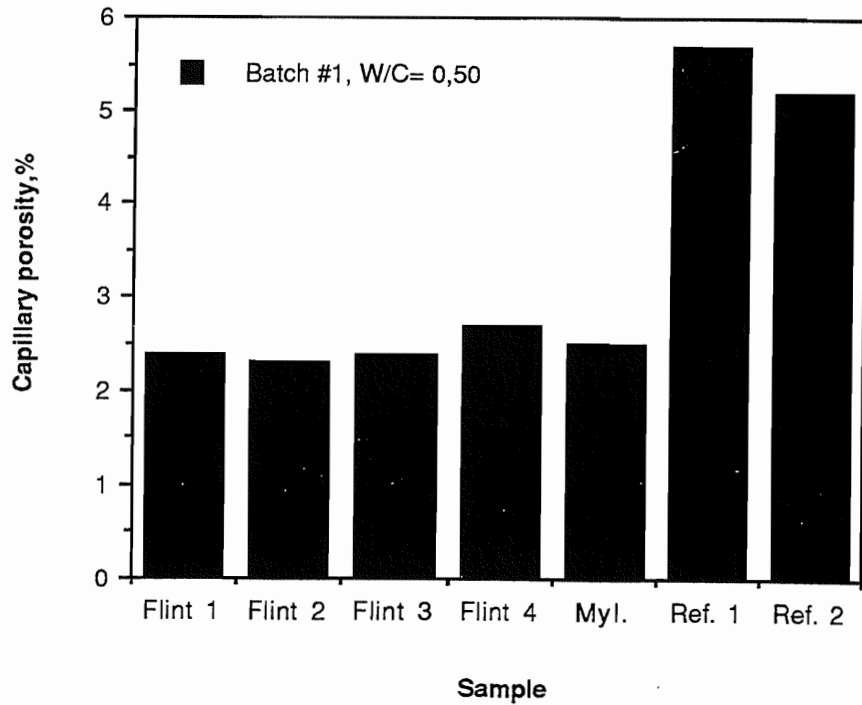

Fig. 7:17. Measured capillary porosity of ASR affected (flint 1-4, mylonite) and ASR unaffected (ref 1-2) samples. W/C ratio 0.45-0.50. Slite Std cement.

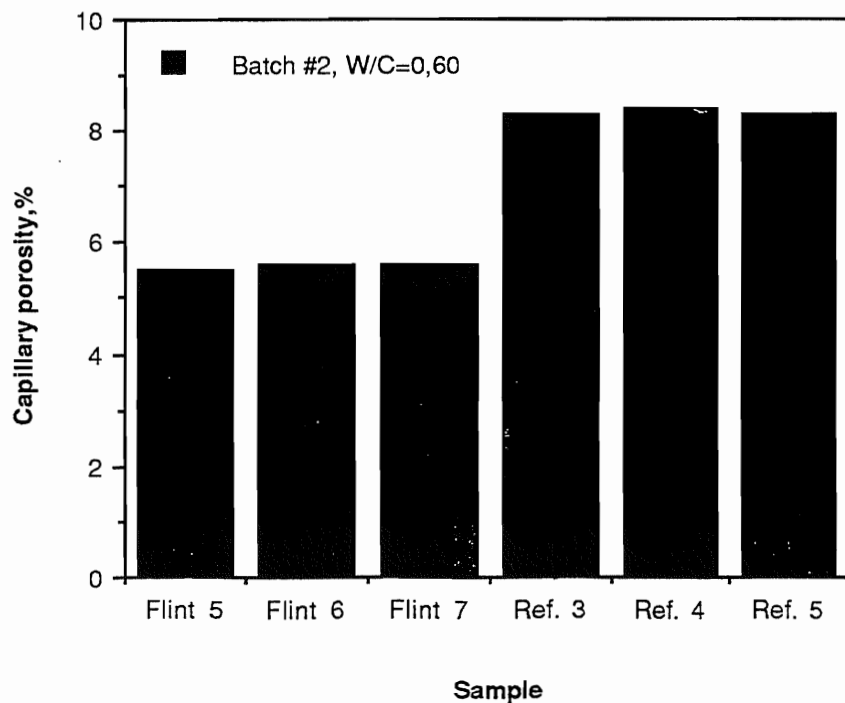

Fig 7:18. Same as Fig.17 for samples with W/C ratio 0.60. ASR affected samples; flint 5-7. Unaffected samples; ref 3-5.

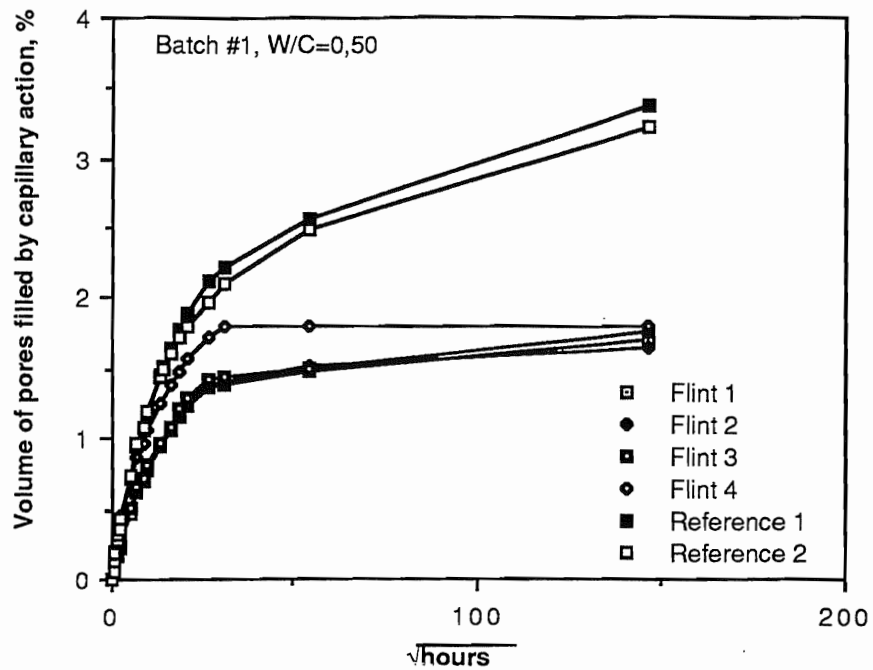

Fig. 7:19 a. Results from water absorption test showing reduced water uptake for samples affected by ASR ("sealing effect"). W/C ratio 0.45-0.50. Slite Std cement.

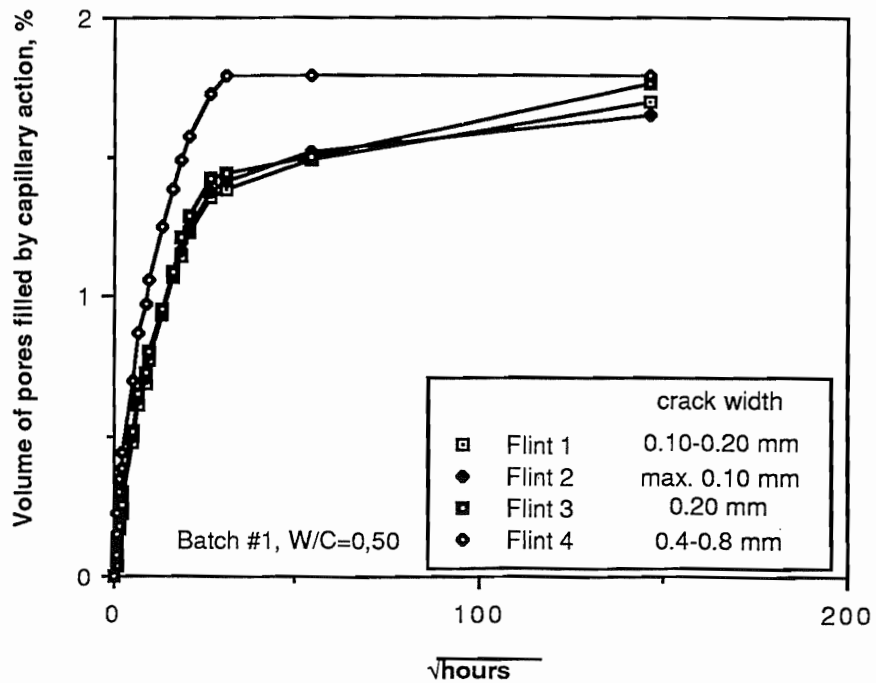

Fig. 7:19 b. Same as Fig.19 a showing reduced absorption rates for samples with crack widths < 0.3 mm, compared to sample with crack width > 0.3 mm.

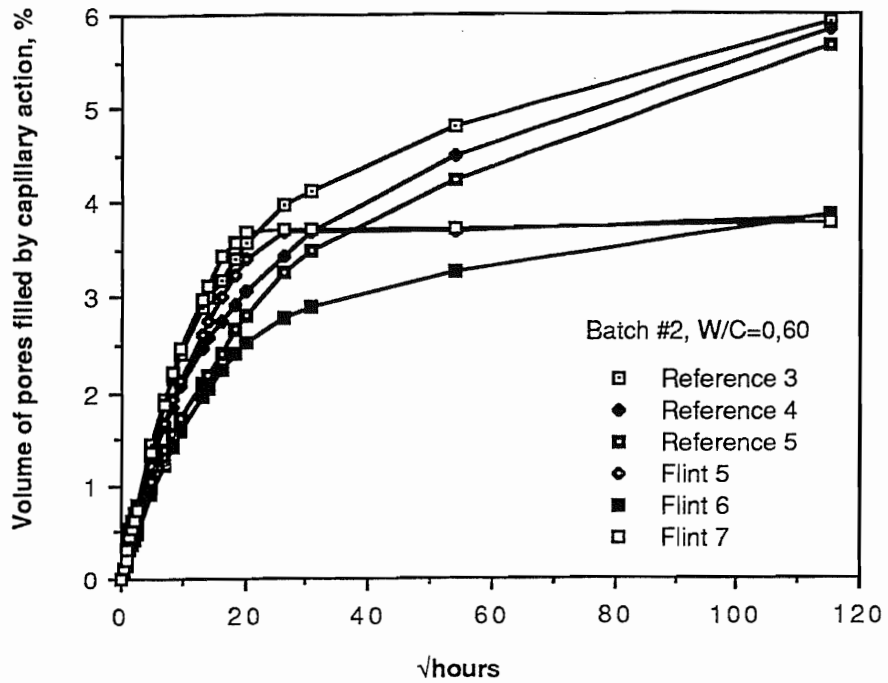

Fig.7:20 a. Results from water absorption test showing reduced water uptake for samples affected by ASR. W/C ratio 0.60. Slite Std cement.

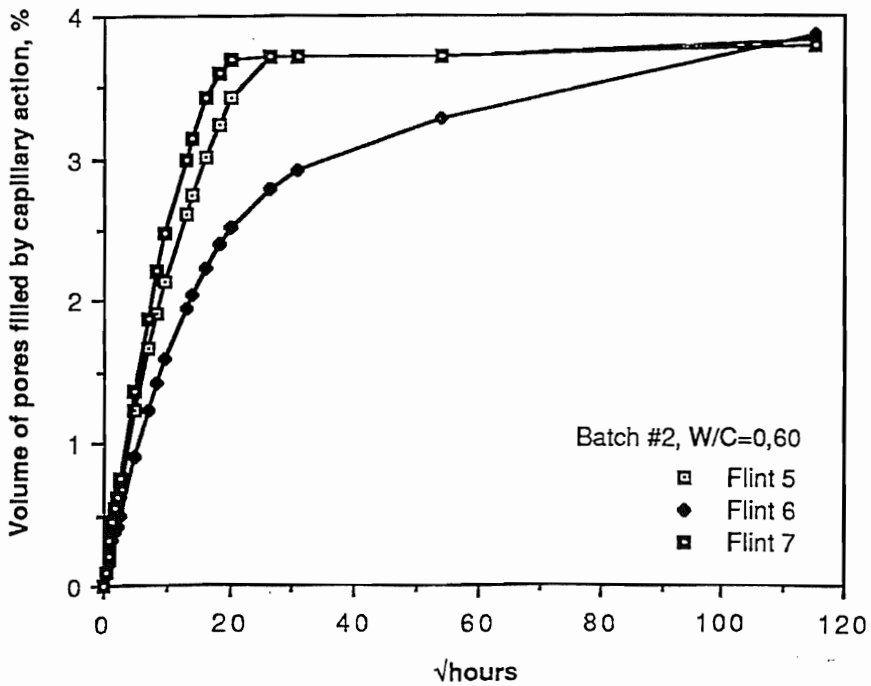

Fig.7:20 b. Same as Fig.20 a, showing reduced absorption rate for sample with crack width < 0.3 mm, compared to samples with crack widths > 0.3 mm. W/C ratio 0.60.

8 Evidence for degradation mechanisms from historical concrete

8.1 Introduction

Regarding the first time period much information can be gained from old and ancient concrete. An examination of historical concretes is presented in two reports to the Commission of the European Communities, Mallinson & Davies (1977) and Jull and Lees (1990).

Old concrete can be divided into three groups, ancient, medieval and "modern" concrete, where the latter is Portland cement from last century. However, even the cement from last century differs from that of today. It was much more coarse grained and had a higher content of C_2S . Thus it was much slower and does still today, in some cases, contain unhydrated cement clinker.

8.2 Old "modern" Concrete

Portland cement, with burnt limestone and clay at high temperature, was invented in the first half of the 19th century and fairly common in the beginning of the 20th century. There are, however, distinct differences between this cement and the cement used today. It generally contained more C_2S and less C_3S and was coarser. Thus it was much slower which results in a different cement paste structure.

Of the different cases studied with modern techniques there are two that we regard as relevant for this study, a water tunnel from Porjus (1914) and a old water dam in USA (1926). For this report we have also made a thin section of an old mortar from 1906. The mortar has been applied as corrosion protection on the inside of a water tank.

8.2.1 Porjus tunnel.

The investigated material for this study (Grudemo 1982) was taken from a concrete wall in a tunnel for water at the Porjus hydroelectric power plant. The wall was cast 1914,

about 200 mm thick directly against the rock and covered on the inside by a cement mortar layer, then in contact with flowing water until a few years ago (1982). Thus one can presume a high humidity and fairly moderate carbonation. The strength and quality of the concrete is still good. Inspection in the microscope of cut and finely ground surfaces of the mortar did not reveal any internal corrosion or cracking. On the contrary, the cohesive strength in the matrix-to-sand interfaces seemed remarkably high. In our opinion this could be a result of ASR-corrosion (see below) of the quartz grains. This phenomenon was not well known in Sweden at that time and the techniques used could not reveal this. In the investigation Grudemo (1982) looked very carefully for signs of polymerisation or recrystallization of hydration products, but he could not find any clear signs of this. The conclusion is that with due reservation for the inconclusive evidence, it can be stated that if a process of polymerisation of this nature cannot be detected until after several decades, the time required for reaching some kind of equilibrium ought to be considerably longer, and the effect of the structural changes associated with this conversion cannot be surveyed or predicted (Grudemo, 1982 p 11). If these results are applied to the deposition tunnels the structural changes during the open time will be insignificant.

8.2.2 Water tank

This water tank was built in 1906. It is made of steel protected on the inside by mortar. The mortar has a thickness of between 10 and 20 mm. The maximum aggregate grain size is 2-3 mm. During most of the nearly 90 years the tank has been filled with drinking water.

A thin section impregnated with a fluorescent fluid was made from this mortar and studied in a polarising microscope.

The carbonation of the mortar has only reached 5 mm presumably as a result of protection from atmospheric carbon dioxide by the water. Inside the carbonation front, the mortar is remarkably well preserved. One can still observe unhydrated relatively large cement klinker minerals. No significant leaching of CH (calciumhydroxide) can be observed although the mortar has been in contact with relatively soft water for almost 90 years. The porosity of the mortar is the same as a modern concrete with a W/C ratio of around 0.4. In the cement paste it is possible to observe recrystallisation. Most of the former smaller air voids are filled with secondary ettringite and CH. Ettringite and Portlandite crystals larger than in normal "young" concrete can also be observed. Small quantities of alkali-silica gel (probably altered to Ca silica gel) can be observed in the cement paste and

around some quartzite aggregate grains. Secondary ettringite crystals grow in or together with the alkali-silica gel. The mortar in contact to the steel is richer in CH crystals.

The cement in this mortar was coarser ground than normal modern cement. The relicts of cement minerals, however, shows that the full hydration of a cement takes very long time. The cement is of Portland type. Presumably it was like most cement of that time richer in the relatively slow C₂S than a modern cement. This together with the coarser cement makes it slow. At the time of casting, with this type of cement, it was not possible to make a mortar with such a low permeability as it has today. The low permeability is probably a result of continued hydration of cement minerals, recrystallization of hydration products and the ASR reactions. They fill up the voids and the expansion blockades the capillary pores. It is a commonly observed phenomenon that concrete gains strength for a very long time. The amount of leaching seems to be very small. However, this is in part a result of the fact that the mortar is protected on one side by steel which means that no water can flow through the concrete layer and that the attack only could occur from the surface.

This sample probably illustrates what happens to a concrete that has been subjected to water of ALLARD-type for a very long time.

8.2.3 Martin Dam.

Like in the Porjus tunnels, the concrete in the Martin Dam has presumably been subjected to a high relative humidity. In this construction several types of cement were used. Most of the cement were mixed with about 25 % fine grained blast furnace slag. The slag will change some of the chemical properties but the information and observations are still valid for normal pure Portland cement concretes. The coarse aggregate consisted largely of quartzite and quartz particles. The fine aggregate was a natural siliceous sand.

The material analyses performed by microscope analysis of thin sections, X-ray diffraction and chemical analyses reveal substantial alterations, which is in contrast to the observations from the Porjus tunnels. The most obvious feature is an extensive development of alkali-silica gel filling cracks and voids. Freshly broken surfaces showed that quartz and quartzite particles had reacted with the alkalis and hydroxyl in the paste resulting in the development of reaction rims on the periphery of the particles and white reaction gel filling nearby voids. Slag or silica fume admixture hinders or delays the

formation of an alkali-silica gel. This is due to pozzolan reactions where slag or silica fume reacts with Portlandite which results in the formation of a C-S-H gel product in the same way as alkali-silica reaction products are formed. The consumption of Portlandite and the subsequent decrease in pH level during pozzolan reactions prevent alkali-silica reactions. Thus one can presume the alkali-silica gel to be more abundant if a pure Portland cement had been used. This demonstrates that the alkali-silica reaction will become important as a degradation or densification mechanism with time. The reaction and the consequences of the alkali-silica reaction are treated in Chapter 7.

In addition to alkali-silica gel, small clusters of needle-like ettringite (AFm phase, see above) crystals were found in the voids and other openings in the concrete. This is normal in old concrete. It can be a consequence of either recrystallisation of the early micro-crystals from the young concrete or reactions with sulphates entering from the outside. Ettringite formation and stability are treated in Chapter 4.

Another observed phenomena is the formation of elongated plates of monosulphate. This is a normal but fine grained product in cement paste. This demonstrates the tendency of the fine grained early products to recrystallize with time. A phenomena that has to be recognised when very long times are considered.

Despite all the alterations the Martin Dam concrete, like the mortar from the water tank, still has a good physical strength.

8.3 Ancient mortar and concrete

Portland cement concrete is only one hundred years old. However, already several hundreds of years B.C the romans produced a similar product from lime (CaO), water and pozzolans. Pozzolans is a very fine grained volcanic ash where glassy silica is the most active component. The result is a product which resembles Portland cement. In the investigation of ancient concrete Jull & Lees (1990) found the samples poorly compacted, of low strength and density and with a high porosity. However, many of the structures produced by this material are still in a good shape like Pantheon and Coliseum in Rome and a number of Roman aqueducts. The material today mainly consists of calcium carbonate and only a small amount of calcium silicates, presumably a product from reactions between CH and the silica from the pozzolan. Mchedlov-Petrosyan et al (1968) have done X-ray diffraction analysis of mortar taken from ancient structures. These

structures have been exposed to several types of environments. The results show (Bergström et al 1977) that the old mortars, apart from calcium carbonate and amorphous silica, contain several of the phases common in modern cementpaste; C-S-H, AFm and AFt. However, the data in Mchedlov-Petrosyan et al (1968) have been criticised by Grudemo (1982) who pointed out that some of the C-S-H minerals only occur in hydrothermal precipitations formed at temperatures above 150 °C and that it is remarkable, that so many phases should appear simultaneously in the same mortar.

In general the ancient mortars and concrete are heavily carbonated, occasionally with some remnants of C-S-H, CH, AFm and AFt (Mallinson & Davies 1987, Jull & Lees 1990). The ancient concrete is in principle a porous marly limestone.

The concrete in the repository will be of much better quality in addition to that it will after the sealing be protected by water saturated conditions. Thus, the presented investigations of ancient concrete gives us very little relevant information. Maybe more information would be obtained by a deep drillcore of an ancient harbour, or something that has been protected from the atmosphere.

Corrosion of the siliceous aggregates as found in the Martin Dam is a frequently encountered phenomenon, which again shows that quartz is unstable in alkaline solutions.

8.4 Medieval mortar and concrete

In common with ancient mortars and concrete, medieval structures are also heavily carbonated, with only remnants of CH and C-S-H and other products. Much of the remaining C-S-H is probably the result of ASR and pozzolanic reactions (see Chapter 7).

8.5 Conclusions

The ancient and medieval concrete and mortars do not give much information. In general they are heavily carbonated due to the contact with the atmosphere. However, the data indicate that if the concrete is protected and not subjected to the atmosphere, C-S-H and the other cement products may remain for at least a couple of thousand years. To gain

better information concerning concrete in the repository, one may consider to take drill cores from submerged Roman structures.

The samples from the early 20th century demonstrate that when concrete is kept wet it remains durable and strong for a very long time. The concrete will at least to some extent reequilibrate and form secondary larger crystals. Moreover, the cement paste will react with some components from the aggregate. If the water can not penetrate the cement paste, this will strengthen the concrete and make it more impermeable. The sample from the water tank indicates that the rate of dissolution of calcium hydroxide is small. With water penetration the rate of dissolution will probably increase.

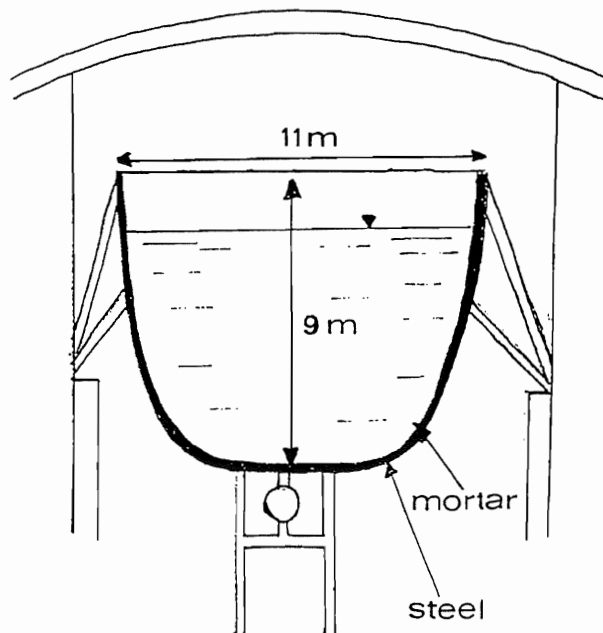

Fig 8.1. Sketch of water tank built 1906. The water tank is covered inside with 20 mm thick mortar.

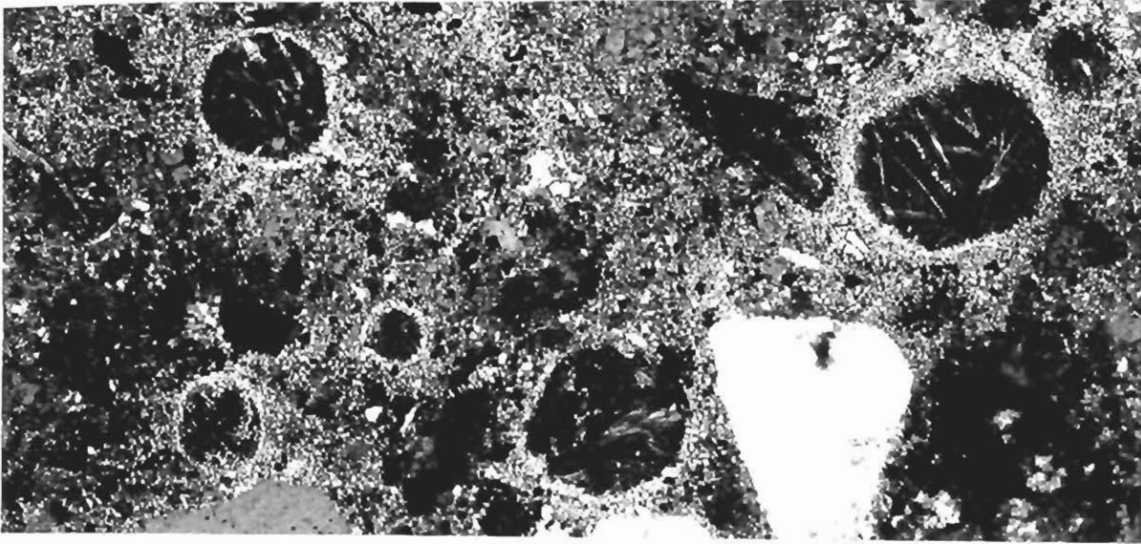

Fig.8:2. Photomicrograph of thin section from mortar specimen from water tank. Dark circular areas are air voids filled with portlandite and ettringite.

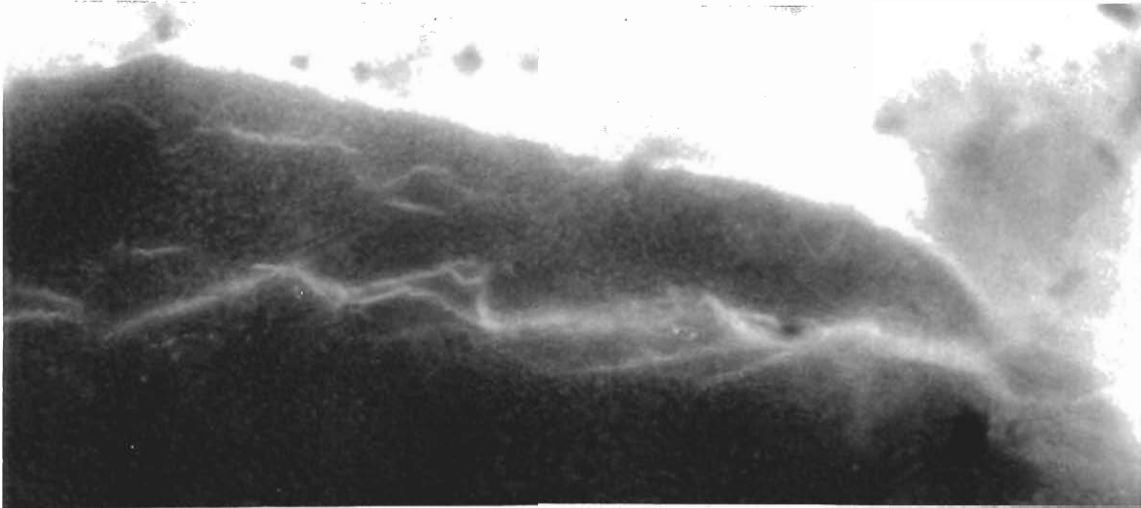

Fig. 8:3. Thin section from water tank specimen. Thin cracks in aggregate showing dissolution of silica due to alkali silica reactions (magn. 100 x).

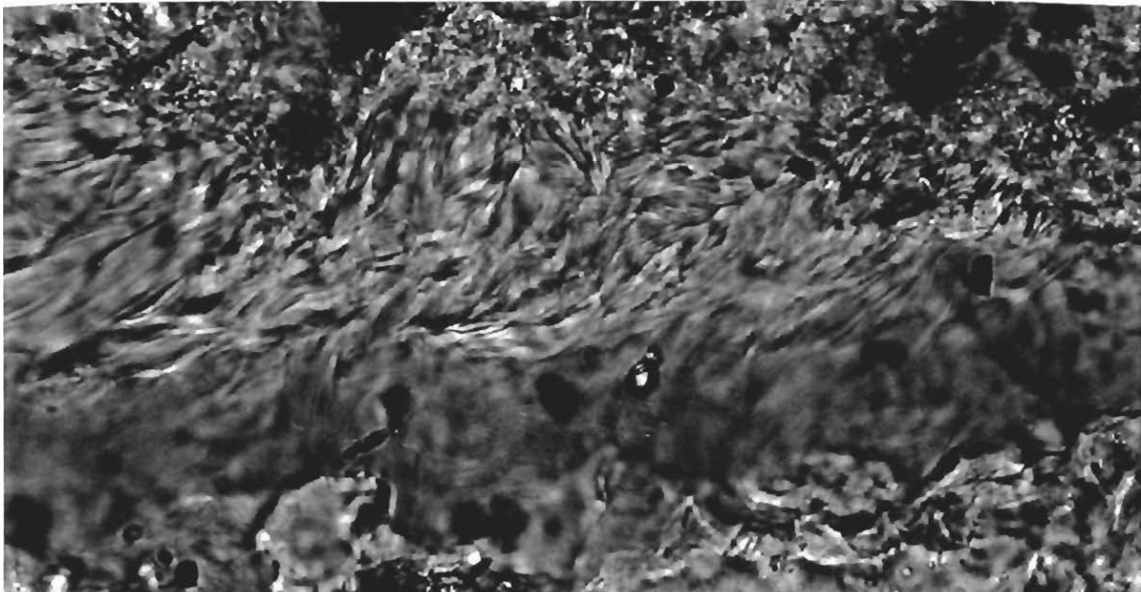

Fig.8:4. SEM photograph from water tank specimen showing corrosion of quartz aggregate in the interface zone between cement paste and aggregate.

9 Conceptual model for concrete degradation in a KBS-3 repository

9.1 Initial period

During the initial operational period of the repository some of the concrete will also be exposed to groundwater with a composition presumably close to Allard water. Other construction details will be in contact with the atmosphere and carbon dioxide due to the fact that the repository is still open and air is ventilated through tunnels and shafts.

The concrete will carbonate on the surfaces in contact with carbon dioxide (Chapter 3). The carbonation depth for a good concrete will be around 5 mm at the fairly humid conditions presumed to prevail in the repository. The resulting calcite is a stable product in the deep bedrock. Thus, this carbonated concrete will presumably remain stable and not take part in the other processes discussed below. The carbonated concrete will serve as a protection for the uncarbonated concrete because it is an established fact that carbonation reduces the permeability for water. The permeability in the uncarbonated concrete will also eventually decrease due to recrystallization phenomena.

Groundwater with an Allard water composition will equilibrate with the pore solutions of the concrete. Initially it has a much lower content of alkalis and calcium than the pore fluids. This will in a first stage result in a depletion of alkalis in the pore solution and an equivalent enrichment in the groundwater. At the same time dissolution of CH will start. In a time perspective of between 50 and 100 years and a good quality concrete without cracks, the concrete will just reach the stage where the CH starts to dissolve.

At a pH of 8.2 the Allard water contains some bicarbonate. However, the pH will rise due to the release of alkali hydroxides from the concrete and increases the carbonate concentration due to the reaction: $\text{HCO}_3^- + \text{OH}^- \rightarrow \text{CO}_3^{2-}$. The increase in carbonate concentration and input of calcium from the concrete will cause calcite to precipitate. The concentration of Mg ions in the Allard water and in the NASK water is low and will not affect the cement paste in any significant way. In groundwater with higher concentrations of Mg the Mg ions will substitute for Ca in Portlandite and form brucite. This would not have any serious effect on the strength or permeability of concrete due to the negligible

volume change when brucite is formed at the expense of Portlandite. Brucite is however insoluble compared to Portlandite which eventually will result in a decrease in pH of the pore solution due to the lost buffer capacity of Portlandite. Experience from concrete in marine environments show that the concrete surface is sealed by a colloidal, gel-like substance due to the dissolution of C-S-H phases ($\text{pH} < 12.4$) near the surface of the concrete. Brucite is a component of this protective layer on concrete in seawater. The sealing of the concrete surface decreases the permeability and hinders chloride intrusion.

Compared to the NASK water, the Allard water has low content of chloride anions and thus will not be harmful to concrete if the chloride content is regarded. In the case of NASK water, chloride anions will primarily enter the AFm phases and secondly the AFt phases as the concentration of the chloride anion (6500 mg/l) is considerably higher than in the pore solution (5 mg/l). The AFm phases will be converted to Friedel's salt and release some sulphate anions to the pore solution. This will stabilize the AFt phase. However, at very high concentrations of chloride anions in the groundwater (approx. 20 000 mg/l) the chloride anions will enter the AFt phases and release sulphate anions to the pore solution. Little is known about which effect this has on the strength of the cement paste. The sulphate anions will diffuse out from the concrete and eventually enter the surrounding groundwater. The water will obtain a different composition and it will have a higher pH, be richer in alkalis, calcium and sulphate but lower in magnesium and bicarbonate. Compared to seawater, NASK water is low in magnesium and consequently no protective brucite layer should be expected. Deep saline water may therefore be more aggressive than seawater concerning chloride reactions.

Calcite will precipitate in the tunnels. This may add to the protection of concrete. The examples from both the Porjus tunnel and the water tank indicates that concrete in contact with Allard water will remain intact for at least 100 and presumably several hundred years.

With stagnant water this will be a slow process ruled by diffusion (Chapter 6). With flowing water the dissolution will be faster. In some situations in the repository a pressure gradient may develop over the concrete structure (Chapter 6). For example, this is the case during the operational period when the tunnels and shafts are drained and water flows from the rock towards the excavated area. Then, if water can penetrate through the concrete, this will enhance the dissolution of concrete phases. However, with high quality concrete and low gradients for water flow the concrete will, during this fairly short time, remain intact.

During the relatively short time with open tunnels the alkali-silica reaction and ettringite formation will presumably have a rather small effect, presuming good aggregates, a low alkali and low aluminium cement (Degerhamn Std P).

The siliceous aggregates will start to corrode as a consequence of ASR. This will, however, not cause any significant volume changes if good aggregates and a low alkali cement is used. We presume that the aggregates are tested. The effect will mainly be formation of more C-S-H at the expense of Portlandite which will enhance the strength and make the concrete more durable. It will also densify the cement structure and reduce the porosity (see Chapter 6).

9.2 Sealing period

After the repository have been sealed, the groundwater will presumably be similar to the Allard water used in laboratory experiments. Successively it is assumed that new water with a composition closer to the more saline NASK water will replace it. The new water will presumably originate from deeper levels and not from the surface. The carbonated concrete will remain stable. The following processes are foreseen during the restoration of groundwater saturation after sealing.

- a) The salinity will increase the ionic strength of the groundwater, which will reduce the dissolution rates.
- b) Radioactive decay in the spent fuel will generate heat and thereby rise the temperature in the repository. This will increase the dissolution rate of many cement paste components. However, the solubility of CH decreases (Chapter 7). If the temperatures rise above 50 °C sulphates may be released from the concrete which will increase the sulphate concentration in the near field groundwater. This is due to the instability of monosulphate (AFm) and ettringite (AFt) at temperatures above 50 °C.
- c) The flow rate will be slower after the repository has been sealed and the original (low) gradient has been restored. This will decrease the concrete dissolution rate.
- d) The water will no longer have access to atmospheric carbon dioxide after repository sealing. Thus the precipitation of calcite can only be induced by the alkalinity of the water and will consequently be low.

The result will be an initial increase in pH to around 12.4 in an aureole around the concrete. This period will last as long as there remains any CH. The pH will eventually drop to lower values when all the CH is gone. The high pH will lead to mineral alterations in the surrounding bedrock (Fritz et al 1988).

9.3 Post-closure period

We have assumed that with time the composition of the water will be like NASK. Compared to pore water of concrete the NASK water has higher contents of alkalis, calcium, magnesium, chlorine, bicarbonate, and sulphate ions. The pore water, on the other hand, has higher contents of potassium and hydroxide ions. We presume a temperature of around 50 °C at the beginning. Later this temperature will decline.

The NASK water composition and the initial temperature of about 50 °C will have some consequences for the stability of the cement paste. If we assume that the groundwater and pore solutions will equilibrate, we foresee the following consequences:

- a) The temperature and ingress of alkalis will decrease the stability of ettringite (Chapter 4). This will cause a depletion of sulphate in the concrete. Some of the ettringite will presumably react with the chloride ions and form Friedel's salt. However, if this happens there will be no large volume changes.
- b) The magnesium ions will react with the CH and form insoluble brucite. However, the amount of Mg is very low in the NASK water. Thus the amount of brucite ($Mg(OH)_2$) formed will be low but, it should be noticed that the concrete will consume magnesium ions in the groundwater which comes in contact with the concrete.
- c) The bicarbonate from the groundwater will precipitate as calcite. Like the brucite the precipitation will lower the permeability of the concrete. The concrete will consume bicarbonate in the groundwater which comes in contact with the concrete.
- e) The potassium ions will diffuse out of the concrete and bind to the clay minerals in the rock and bentonite.

f) Sodium ions will diffuse into the concrete. This will depress the solubility of CH due to the common ion effect. Higher temperatures will similarly decrease the solubility of CH (Fig. 7:3). As a result the dissolution rate of the concrete will drop.

g) The hydroxide ions will diffuse out from the pore solutions of the concrete. This will result in dissolution of CH and an increase of the contents of Ca in the pore solutions. The rate of the dissolution must be calculated as this is hampered by the alkalis and the relatively high temperature. In the beginning, before the pore solution and groundwater is equilibrated, CH will precipitate in the groundwater (see Alcorn et al 1992). However, for a time until all the CH has been dissolved there will be an aureole around the concrete with a pH of around 12.4. Presumably it will be closer to 13 due to the high contents of alkalis. The volume of the aureole will depend on the groundwater flow and the rate of the aggregate reactions. When the CH has disappeared the pH will successively drop to around 10. In the first part of the sequence the C-S-H will adjust the pH. The Ca/Si ratio will drop from around 1.7 to 0.9 and a 14 Å tobermanite will be the stable phase. This will release CH which keeps the pH stable. The dissolution of tobermanite will presumably be very slow and tobermanite will remain in the repository for hundreds of thousands years.

h) The pH and the content of CH will be regulated by aggregate reactions. The alkali-silica reaction will transform quartz and CH into C-S-H (Chapter 7). Also the other rock minerals in the aggregates will participate in reactions that eliminate hydroxide ions. One can also presume that the released hydroxide ions will react with the rock which will result in a drop of the pH.

i) Chloride ions will diffuse into the concrete and release sulphate ions from AFm phases and at very high concentrations (20 000 mg/l) also from AFt phases. The sulphate ions will enter the groundwater.

Thus after a long time we presume that the concrete in contact with granitoid rocks will degrade towards a mixture of tobermanite (C-S-H), ettringite, Friedel's salt, hydrogarnet, different clays and different zeolites/feldspars.

10 Discussion and summary of conclusions

The conceptual model for concrete degradation in a KBS-3 repository described above is based on certain assumptions regarding type of cement, concrete and environmental conditions. It is possible to change both the type of cement and concrete. This will change the properties and thus influence the degradation mechanism. This in turn will affect the groundwater chemistry. Furthermore, the groundwater composition may be different to what have been postulated. This discussion will briefly treat these aspects.

10.1 Cement type

10.1.1 Standard Portland cement

A standard Portland cement can have different compositions within certain limits. The common and important constituents are C_3S , C_2S , C_3A and C_4AF and alkalis (nomenclature in Chapter 2). All changes in the relative amounts of these elements will have an effect on the durability and dissolution rates of the cement phases. An increase in the contents of C_2S relative to C_3S will result in lower contents of CH and a lower C/S ratio in C-S-H. Thus a cement rich in C_2S , like Degerhamn Std P, will in a long time perspective release less hydroxides to the surroundings. Higher contents of C_3A will make the concrete more susceptible to chloride and sulphate attack as these components bind to the aluminat phase. A concrete with high contents of C_3A is susceptible to sulphates from the environment as these will bind to ettringite, which in turn, induces an expansion that may crack the concrete. Probably high contents of C_4AF also will effect the chloride and sulphate systems. This has not been investigated in detail because it does not have any serious consequence in normal concrete structures. There are indications that the ferrite is less mobile and thus more stable.

The properties of the concrete also relate to the fineness (grinding) of the clinker. With a more fine grained cement the hydration process will be faster and the initial strength higher. The long time gain of strength will, however, be smaller when less clinker grains remain. A coarser grained cement will probably be better in a long time perspective as a large proportion of remaining clinker is a residual reserve which may help to seal cracks in the concrete.

10.1.2 Addition of pozzolans

The composition of the cement paste can also be changed by adding different pozzolans to the cement. A pozzolan is in principle a highly reactive silica. The silica reacts with the calcium hydroxide and forms C-S-H-gel. In principle the pozzolan reaction is a very fast alkali-silica reaction (see Chapter 7). The most reactive silica is condensed silica fume (CSF), a by-product of silica or silica alloys. It is sold commercially and its behaviour in concrete is well known. Mixed into concrete CSF decreases the permeability and gives the concrete better rheological properties. CSF like most other pozzolans slows down the alkali-silica reaction by binding alkalis and lower the pH of the pore fluids. These alkalis will, however, later be released again. With about 25 % replacement of the cement with pozzolan all the calcium hydroxide will be consumed. As a result the pH of the pore solution will drop and be regulated by the dissolution of C-S-H gel. This will, in turn, have an effect on the stability of the AFt and AFm phases. In normal concrete it is recommended not to use more than 10 % CSF as replacement for cement. Other but less effective pozzolans are fly ash, ground volcanic rocks and granulated blast furnace slag.

With higher contents of C₃A and/or C₄AF the amount of AFm and AFt will increase. This will influence the sulphate-chloride system discussed in Chapter 4. It is also possible to modify the amount of gypsum in the cement which will influence this system.

10.1.3 Calcium aluminate cement

The other common type of cement-based Portland cement is calcium aluminate cement . This cement is mainly based on calcium and aluminium components. It also contains a variable amount of ferrous iron. When hydrated, the resulting cement paste is dominated by different hydrated calcium aluminate and aluminate phases. In contrast to Portland cement the major hydration products are crystalline. This cement is found to have excellent resistance to sulphate attack and many other forms of chemical attack. The setting time is normal but it hardens very rapidly. Concrete can also be produced which has a useful strength in 6 h and a strength at 24 h equal to that given by Portland cement in 28 days. The main problem with calcium aluminate cements is that the cement paste may under certain conditions recrystallize, which results in a rapid degradation of the concrete. The general recommendation to avoid this is to have a low water cement ratio in the concrete mix.

In a repository, a concrete with this cement will have the advantage of giving a lower pH and releasing less hydroxides. This cement can also absorb sulphate ions. As a residual of complete dissolution there will be a mixture of gibbsite and different clays that may sorb radionuclides. Much more solid materials will remain after degradation and dissolution.

10.2 Concrete type

The cement paste and concrete properties is mainly given by the water cement ratio. When water reducers and superplasticisers are added, it is possible to reduce the amount of water significantly without changing the rheological properties of the concrete. It is possible to get a concrete with a W/C ratio of no more than 0.20. Concrete with a W/C ratio between 0.25 and 0.30 can be commercially produced. This concrete is practically impermeable. This will hinder water to penetrate the concrete and will thus delay the dissolution. It will also delay carbonation. However, a low W/C ratio can cause problems if a glide form is used when the concrete is placed. Such problems occurred when the SFR repository was constructed.

By changing the gradation of the aggregates especially in the finer fractions the permeability can be changed. Different aggregates will also give different properties. It is possible to make concrete with calcinated bauxite as aggregate. The calcinated aggregate will react with the cement paste and give a very strong and impermeable concrete.

10.3 Influence of the environment

If the tunnels are kept dry or the contents of carbon dioxide in the air is high, the depth of carbonation will increase. This will decrease the amount of calcium hydroxide in the concrete which in turn will decrease the amount of hydroxides released by the concrete degradation. A totally carbonated concrete will have very little effect on the groundwater composition, as the products are similar to those found in cracks in the rock (calcite, zeolites and different clays).

A groundwater rich in sulphates may cause problems, if the cement is rich in C₃A. The sulphates may crack the concrete by expansion (ettringite formation). Acid water or very

soft water is also unfavourable for concrete, because it will increase the rate of dissolution.

One critical factor that may influence the concrete properties is the amount of chlorides. The super deep water is often extremely rich in chlorides (Lagerblad 1994). The consequences of this for concrete in a repository is not well known especially regarding the chemical exchange. Presumably sulphates will be released. However, the strength of the concrete will probably remain. In a test program for ASR at CBI we have stored concrete prisms in concentrated NaCl solutions at 50 °C for several years without noticing any degradation except from ASR.

If the groundwater contains magnesium, this element will bind to the cement paste by forming brucite. With high contents hydrotalcite will form. Knowledge about the effect of Mg comes from concrete in seawater. Magnesium ions causes a small swelling that tightens the concrete and protects the interior.

10.4 Summary of conclusions

The conclusions from the preceding Chapters have been summarised below by paragraphs - one for each Chapter.

Chapter 3. Carbon dioxide attack, carbonation

-The carbonated concrete retains most of its strength. The problem with carbonation is mainly that of reinforcement corrosion. When the pH value drops the iron can oxidise and corrosion will follow.

-If the aggregate contains carbonate rocks these may with time react with the cement paste and form different hydrocarbon aluminates. At a late stage calcite in the carbonated layer may react with the underlying concrete and form hydrocarbon aluminates in there.

-With a good concrete (W/C around 0.45 - 0.50) the carbonation depth will be around 5 mm with an exposure time of 50 years. In this case we assume a normal atmosphere with normal carbon dioxide concentration. With a higher concentration the carbonation will go deeper.

-The carbonate anions may react/substitute with AFt/AFm phases and thus stabilize them. In the AFt/AFm phases there will be a competition between carbon, sulphate and chloride ions. In a long time perspective calcite from the aggregates and the carbonated layer may form crab aluminates.

-Calcite will presumably start to precipitate already in the high pH aureole around the concrete. The remaining bicarbonate/carbonate ions will be consumed by the concrete.

Chapter 4. Sulphate attack, stability of the sulphate phases

- From analyses of the composition of pore fluids from cement pastes, it is known that ettringite is destabilised when the sulphate concentration becomes very low. If the sulphate concentration increases new ettringite is formed. With very high contents of sulphate anions, gypsum is stabilised. The formation of both ettringite and gypsum involves an expansion which may lead to volumetric increase eventually leading to fracture formation. As the formation of ettringite requires aluminium, cement with low contents of this element is required in sulphate rich environments. The reference cement, Degerhamn Std P, is regarded to be a sulphate resistant cement due to its relatively low contents of Al.

- AFt is sensible to the alkali content and the temperature. A high alkali content requires more sulphate in the pore solution in order to maintain the stability of the AFt phase.

- The stability of both ettringite and monosulphate is controlled by pH. When the concrete is carbonated, or if the CH is leached, they break down. Gabrisová et al 1991 studied the stability of both phases in water solutions at various pH intervals with the potentiometric method.

- The role of Fe instead of Al in ettringite is uncertain but it is known that a concrete with a cement rich in Fe (C_4AF), like Degerhamn Std P, is less sensible to heat curing than Slite Std P which is richer in Al (Lagerblad & Utkin, 1995).

- In old concrete the air voids are normally filled by relatively large ettringite crystals and sometimes CH crystals (see Chapter 8). This indicates that these mineral phases are relatively easily recrystallized.

- When the CH has been leached from the cement paste and the pH drops, the sulphates will enter solution due to the greater solubility of the resulting gypsum and aluminium sulphates. In the unhydrated state, Standard P cement contains about 2 weight % gypsum. Eventually, all the sulphate ions will enter the groundwater due to the low concentration of sulphate ions in the NASK water.

Chapter 5. Chloride attack, stability of the chloride phases

- The diffusion of chloride ions into the concrete depends mainly on the W/C ratio and cement type. According to tests at CBI with concrete in seawater the diffusion coefficient of a concrete with Degerhamn Std P. cement is 2.7, 4.2 and 4.8×10^{-12} m²/s at a W/C ratio of 0.35, 0.40 and 0.50, respectively (data from Karin Pettersson CBI, personal communication). With Slite Std P cement, which is richer in aluminate, the diffusion coefficient is lower. About 40% of the chloride ions are dissolved in the pore water while 60% are bound to the cement paste.

- Data from Richartz (Fig. 5:2) show that the C-S-H phase can physically bind a substantial amount of chloride anions. Evidence from field concrete indicate that Degerhamn Std P and Slite Std P cement chemically bind approximately the same amount of chloride anions (Pettersson, CBI, personal communication).

- At temperatures of 40 °C and above and with a chloride content of above 10 000 mg/l the ettringite will decompose to Friedel's salt and gypsum. At temperatures below 20 °C trichloride forms instead of Friedel's salt.

Chapter 6. Stability of the cement phase in aqueous fluids

- When the cement phases with time forms larger crystals, this will probably enlarge the gel pores, while the capillary pores become more discontinuous. Moreover, the continued hydration of remaining cement clinker minerals will densify the structure in the mature paste. These phenomena will result in a decrease in the porosity.

- Undersaturated solutions, with respect to calcium and silica concentrations, are potentially capable of dissolving C-S-H(1) from the cement gel. Groundwater which has

Allard water composition are slightly undersaturated with respect to Ca and Si and are capable of dissolving C-S-H(1) and C-S-H(2) phases. C-S-H(2) phases have a higher solubility than C-S-H(1), but C-S-H(1) has to dissolve before C-S-H(2) because of the structure of the C-S-H gel, which consists of an outer layer of C-S-H(1) protecting internal layers of C-S-H(2). It follows that once C-S-H(1) phases have been stripped away, rapid disintegration of the cement gel will take place. The attack starts with dissolution of the CH layer in the C-S-H phases and subsequently the calcium silicate hydrate layers are dissolved. By then, the silica content in the pore solution has started to increase and the calcium content decreased (Fig. 6:6).

- The stages by which cement paste disintegrates can be summarised as follows:

1) Reduction of the alkali level in pore solution by removal of alkali ions (dilution) and subsequent lowering of pH.

2) Dissolution of CH ($\text{Ca}(\text{OH})_2$) which buffers the pH in the pore solution to 12.4. Possible reactions with respect to pH and dissolved CO_2 :

- a) $\text{Ca}(\text{OH})_2 + \text{CO}_2 = \text{Ca}^{++} + \text{HCO}_3^- + \text{OH}^-$
- b) $\text{Ca}(\text{OH})_2 + \text{H}_2\text{CO}_3 = \text{Ca}^{++} + 2\text{HCO}_3^- + 2\text{H}_2\text{O}$
- c) $\text{Ca}(\text{OH})_2 + \text{H}^+ = \text{Ca}^{++} + \text{OH}^- + \text{H}_2\text{O}$

3) Dissolution of C-S-H(1)

4) Dissolution of C-S-H(2). Equilibrium between C-S-H phases and pore waters can be expressed as follows:

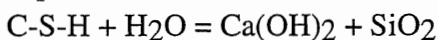

pH in the pore solution stays slightly above 10 during dissolution of C-S-H compounds.

5) Dissolution of hydrated calcium aluminate phases and a drop in pH below 10. The equilibrium is:

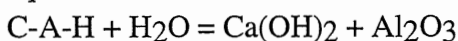

6) Dissolution of calcium aluminate ferro hydrate phases. The equilibrium is:

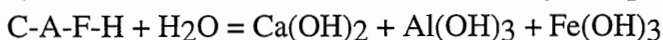

The decomposition of the calcium aluminate ferro hydrate phases will also result in metastable phases like hydrogarnets and different zeolites.

- The capability of groundwater with ALLARD or NASK water composition to dissolve hardened cement paste will depend on the calcium and silica concentrations and the amount of dissolved CO₂. It is noticeable that C-S-H compounds and CH stands for almost 50% by volume of the cement paste. By weight the C-S-H and CH compounds constitute almost 65 %.

- If long time scales are considered, concrete in contact with flowing groundwater which has Allard water composition will suffer leaching of CH. Eventually dissolution of C-S-H phases and disintegration of the cement paste will occur. This is due to the fact that both the calcium and silica contents of Allard water are less than in a cement pore water which is in equilibrium with the calcium phases of the cement paste. However, Allard water has a very low content of bicarbonate and carbon dioxide which makes it non-aggressive towards concrete. The dissolution rate will be slow and if the concrete has a permeability coefficient less than about 10^{-10} m/s, the concrete is assumed to be water tight for all practical purposes. Water tight structural concrete according to ACI standards should have a W/C ratio not more than 0.48 (fresh water) or 0.44 (saline water). Dissolution and removal of calcium phases will be slow and deterioration concentrated to the surface of the concrete. Furthermore, CH near the surface will carbonate relatively fast which will delay calcium removal. In practice, it is unlikely that any deterioration will occur with Allard water if normal concrete service life time spans are considered (50-100 years).

- When the composition of the groundwater changes to a NASK composition, the dissolution rate will go down as a consequence of the high ionic strength of the NASK-water. In particular a high content of Ca cations will slow down the dissolution. On the other hand, the content of magnesium and sulphate is very low and consequently no protective layer will form due to brucite precipitation. The dissolution rate will depend on the water flow and the permeability of the concrete. With low water flow there will be an aureole of high pH and elevated calcium content around the concrete. The dissolution rate will depend on how fast the water flows around the concrete, or in other words the resetting of the aureole. Other important factors are the bentonite- and rock-water interactions, which could lead to the formation of new minerals precipitating due to ionic diffusion out from the concrete. Bentonite can also influence the cation composition of groundwater by ion-exchange e.g. exchange calcium for sodium which may also influence the concrete.

Chapter 7. Stability of the aggregate phase: cement-aggregate reactions

- The alkali content of the Portland cement considered to be used in the deep repository (Degerhamn Std P) is low, about 0.6 weight % Na_2O equivalent. Compared to Slite std P cement, the calcium hydroxide content in the hardened cement paste is low.

- It has been shown that a threshold pH value of approximately 13.5 in cement pore solutions exists, below which little or no expansion takes place due to alkali-silica reactions (Struble, 1987). However, alkali-silica gel can still be produced, which may densify the cement structure (see Chapter 6). Representative analysis of pore solution from Degerhamn Std P cement show a pH value of about 13.0 (see Table 7:1). Possible mixing between pore solution and groundwater of ALLARD-composition will also lead to reduction of pH. The factors above indicate that expansion due to alkali-silica reactions is going to have little effect on concrete during the pre-closure period. The alkali-silica reaction is therefore treated in the long term perspective after the nuclear waste repository has been sealed (post-closure period).

- Petrographic examination of samples taken from constructions affected by ASR, often show ASR-gel in air voids and as impregnation in the cement paste. The gel product is often associated with secondary ettringite.

- The ASR-gel eventually formed, will reduce the porosity and densify the cement structure. This will occur in addition to the effect of reduction in porosity due to increasing degree of hydration with time (Table 7:6). The formation of ASR-gel under these conditions will probably not induce cracking because of the slow reaction rate. The slower the reaction rate and the formation of ASR-gel, the more likely there is time for the gel to attain a non-expansive calcium-silica composition before enough pressure has been built up to induce cracking.

- The decrease of pH in the concrete pore solution due to equilibration with groundwater, will slow down the dissolution rates of common rock forming minerals (e.g. quartz, feldspars, muscovite) but dissolution will still continue. There will be no lack of alkali (Na^+) and calcium ions. The abundance of Portlandite in concrete will ensure that hydroxide ions are available at the reaction sites. If a long time scale is considered, secondary precipitates due to dissolution of primary silicates will form. The reaction will corrode small quartz grains at the surface and dissolve silica from the inside of large porous aggregates. The reaction product will be a C-S-H complex which will precipitate

and fill the capillary and gel pores in the cement matrix. To some extent also the air voids will be filled. The result is a cement phase with higher density and decreasing porosity. It is unlikely that cracking of concrete due to volume increase of the reaction product will occur. Slow reaction rates and the availability of Ca^{++} ions in the pore water (which can substitute for alkali ions in the newly formed silica gel), make it probable that a non-swelling Ca-rich silica gel will dominate. With time, the C-S-H complex might be replaced by zeolites and/or feldspars.

- Concrete in contact with groundwater of Allard water composition will be dominated by dissolution and degradation of the cement phase. Diffusion of Na^+ , K^+ , Ca^{++} and OH^- ions out from the concrete will eventually enrich groundwater in alkali ions and increase the pH. Dissolution of the aggregate phase and precipitation of secondary reaction products will be subordinate.

- Concrete in contact with groundwater of NASK water composition will be subjected to alkali aggregate reactions if long time scales are considered. Secondary reaction products will precipitate in the cement paste and decrease its porosity. Decreasing porosity will slow down diffusion rates and thereby the chemical exchange between pore water and groundwater. The dissolution rates will, however, be limited and the availability of Ca^{++} ions will make it probable that a non-swelling C-S-H-complex will form initially. This will densify the cement structure, but cracking will probably not occur if the aggregates used have a low reactivity. The C-S-H complex may be replaced by zeolites and/or feldspars with time. Degradation of the cement phase will be slower than with water of the Allard water composition.

Chapter 8. Evidence for degradation mechanisms from historical concrete

- A common phenomenon observed in old concrete is the formation of elongated plates of monosulphate. This is a normal but fine grained product in cement paste. This demonstrates the tendency of the fine grained early products to recrystallize with time. A phenomenon that has to be recognised, when very long times are considered.

- Despite all the alterations observed from petrographic studies of old concrete, like the mortar from the water tank, it still has a good physical strength.

- The ancient or medieval concretes and mortars do not give much information. In general they are heavily carbonated due to the contact with the atmosphere. However, the data indicate that if the concrete is protected and not subjected to the atmosphere, C-S-H and the other cement product may remain for at least a couple of thousand years. To gain better information concerning concrete in the repository, one may consider to take drill cores from submerged Roman structures.

- The samples from the early 20th century show, that when a concrete is kept wet, it remains durable and strong for a very long time. The concrete will at least to some extent reequilibrate and form secondary larger crystals. Moreover, the cement paste will react with some components from the aggregate. If the water can not flow through the cement paste, this will strengthen the concrete and make it more impermeable. The sample from the water tank indicates that the rate of dissolution of calcium hydroxide is small. With water flowing through the concrete the rate of dissolution will increase substantially.

Chapter 10. Discussion (Concrete type, cement type and additives)

- The properties of the concrete relate to the fineness (grinding) of the clinker. With a more fine grained cement the hydration process will be faster and the initial strength larger. The long time strength gain will, however, be smaller as less clinker grains will remain. A coarser grained cement will probably be better in a long time perspective as a large proportion of remaining clinker is a residual reserve which may help to seal cracks in the concrete.

- Condensed silica fume (CSF) like most other pozzolans slow down the alkali-silica reaction by binding alkalis and lower the pH of the pore fluids. These alkalis will, however, later be released again. At about 25 % replacement of the cement with CSF all the calcium hydroxide will be consumed. As a result the pH of the pore solution will drop and be regulated by the dissolution of C-S-H gel. This will, in turn, have an effect on the stability of the AFt and AFm phases. In normal concrete it is recommended not to use more than 10 wt % CSF as replacement for cement. The main reasons for this caution are effects on the rheology (workability), cracking due to shrinkage (desiccation) and effects on the frost resistance. In Iceland, they have found that when about 7 % replacement with CSF is used, deleterious alkali-silica reactions and shrinkage cracks are avoided. Other but less effective pozzolans are fly ash, ground volcanic rocks, granulated blast furnace slag and calcinated kaolin.

- By changing the gradation of the aggregates especially in the finer fractions the permeability can be changed. Different aggregates will also give different properties. It is possible to make concrete with calcinated bauxite as aggregate. The calcinated aggregate will react with the cement paste and give a very strong and impermeable concrete.

Chapter 10. Discussion (Influence of the environment)

- If the tunnels are kept dry or the contents of carbon dioxide in the air is high the depth of carbonation will increase. This will decrease the amount of calcium hydroxide in the concrete which in turn will decrease the amount of hydroxides released by the concrete degradation. A totally carbonated concrete will give very little effect on the groundwater composition as the products are similar to those found in cracks in the rock (calcite, zeolites and different clays).

- A groundwater rich in sulphates may cause problems if the cement is rich in C₃A. The sulphates may crack the concrete by expansion (ettringite formation). Acidic water or very soft water is also unfavourable for concrete because it will increase the rate of dissolution.

- A critical factor that will influence the concrete properties is the amount of chlorides. The concentration of chloride ions may under certain conditions become very high. The super deep water is often extremely rich in chlorides (Lagerblad 1994). The consequences of this for concrete are not well known especially regarding the chemical exchange. Presumably sulphate ions will be released to the groundwater. However, observations and experimental investigations made so far indicate that the strength of the concrete will probably remain.

- If the groundwater contains magnesium this element will bind to the cement paste by forming brucite. At high concentrations of magnesium hydrotalcite will form. Knowledge about the effect of Mg comes from observations on concrete in seawater. Magnesium ions causes a small swelling that tightens the concrete and protects the interior.

11 References

- Alcorn, S., Coons, W., Christian-Frear, T. and Wallace, M., Theoretical investigations of grout seal longevity - Final report. SKB Technical Report, 92-23. Stripa project.
- Barret, P., Bertrandie, D. & Beau, D., Calcium hydrocarboaluminate, carbonate, alumina gel and hydrated aluminates. Solubility diagrams calculated in equilibrium with CO₂(g) and Na⁺ (aq) ions. Cement and concrete research. Vol. 13, pp. 789-800, 1983.
- Bennet, D. G., Read, D., Atkins, M., and Glasser, F. P., A thermodynamic model for blended cements 2: Cement hydrate phases; thermodynamic values and modelling. Journal of Nuclear Materials, 190, pp 315-325, 1992.
- Bergström, S. G., Fagerlund, G. & Rombén, L., Bedömning av egenskaper och funktion hos betong i samband med slutlig förvaring av kärnbränsleavfall i berg, CBI-rapport nr 7739 och KBS Technical Report no 12, 1977. (in Swedish)
- Blatt, H., Middleton, G, Murray, R., Origin of sedimentary rocks, Prentice-Hall. 1972.
- Brady, P.V. and Walther, J.V., Kinetics of quartz dissolution at low temperatures. Chemical geology, Vol. 82, pp 253-264. 1990.
- Brown, P. W. and Bothe Jr, J. V., The stability of ettringite, Advances in cement Research, 5, No 18, Apr., pp 47-63, 1993.
- Byfors, K., Chloride-initiated reinforcement corrosion (chloride binding). CBI-report nr. 1:1990, 109 pp.
- Charoll-Webb, S.A and Walther, J.V., A surface complex reaction model for the pH-dependence of corundum and kaolinite dissolution rates. Geochim. Cosmochim. Acta. Vol. 52, pp 2609-2623. 1988.
- Chou, L. and Wollast, R., Study of the weathering of albite at room temperature and pressure with a fluidized bed reactor. Geochim. Cosmochim. Acta, 48, pp 2205-2217. 1984.
- Chou, L. and Wollast, R., Steady-state kinetics and dissolution mechanism of albite. American Journal of Science. 285. pp 963-993. 1985.

- Damimot, D., Atcins, M., Kindness, A. and Glasser, F. P., Sulphate attack on concrete: limits of the AFt stability domain. *Cement and Concrete Research*, Vol 22, pp 229-234, 1992.
- Davis, S. N., DeWiest, R. J. M., *Hydrogeology*. Wiley and Sons. pp 1-463. 1966.
- Fritz, B., Madé, B. and Tardy, Y., Geochemical modelling of the evolution of a granite-concrete-water system around a repository for spent nuclear fuel. SKB Technical Report 88-18, 1988.
- Gabrisová, A., Havlica, J. and Sahu, S., Stability of calcium sulphoaluminate hydrates in water solutions with various pH values. *Cement & Concrete Res.*, Vol. 21, 1023-1027, 1991.
- Gascogne, M., Davidson, C. C., Ross, J. D. and Pearson, J., Saline groundwaters and brines in plutons in the Canadian Shield. *Geological Association of Canada Special Paper* 33, p 53-68, 1987.
- Granhölm, H., Werner, D. and Gietz-Hedström, S., Utredning angående lämpligheten av betongrör till vägtrummor. *Betong* 1934:1.
- Grudemo, Å., X-ray diffractometric investigation of the state of crystallization in the cement matrix phase of a very old concrete, *Nordic Concrete Res.*, No 1, p 1-22, 1982.
- Helgeson, H.C, Murphy, W.M and Aagaard, P., Thermodynamic and kinetic constraints on reaction rates among minerals and aqueous solutions. II. Rate constants, effective surface area and the hydrolysis of feldspar. *geochim. cosmochim. Acta*. Vol. 48, pp 2405-2432. 1984
- Helmy, L. M., Chemical attack on hardened pastes of blended cements Part II: Attack of Sea water, *Zement-Kalk-Gips*, Heft 3, 1991, pp 139-144.
- Helmy, L. M., Amer, A. A. and El-Didamony, H., Chemical attack on hardened pastes of blended cements; Part I: Attack of chloride solutions. *Zement-Kalk-Gips*, Heft 1 1991, pp 46-50.

Herr, R. & Wieker, W., The hydroxide-sulphate ion equilibrium in cement paste pore solutions and its significance to the theory of AAR (alkali aggregate reactions) in concrete, The 9th int. conf. on AAR in conc., Vol. 1 p 440-450, London 1992.

Hobbs, D. W., Aggressivity of environment: Influence of temperature upon expansion due to the alkali-silica reaction. British Cement Association, Brite report. 1993.

Höglund, L. O., Some notes on ettringite formation in cementitious materials; Influence of hydration and thermodynamic constraints for durability. Cement and Concrete Research, Vol 22, pp 217-228, 1992.

Idorn, G. M., Expansive mechanisms in concrete. Cement and Concrete Research, Vol. 22, pp 1039-1046. 1992.

James, A. N., Soluble Materials in Civil Engineering. Ellis Horwood Publ. LTD. pp 1-434. 1992.

James, A. N., Preliminary field studies of rates of dissolution of hydrated cement. Magazine of Concrete Research, v 41, pp 155-162. 1989

Jones, T. N. and Poole, A. B., Alkali- silica reaction in several UK concretes. The effect of temperature and humidity on expansion and the significance of ettringite development. proceedings of 7th International Conference on Alkali-aggregate reactions in concrete. pp 446-450. 1986.

Jull, S. P and Lees, T. P., Studies of historic concrete, final report, in nuclear science and technology, Published by Commission of the European Communities, Report EUR12972 EN, Luxembourg 1990.

Knauss, K. G. and Wolery, T. J., Dependence of albite dissolution kinetics on pH and time at 25 °C and 70 °C. Geochim. Cosmochim. Acta. Vol. 50, pp 2481-2497. 1986

Knauss, K. G and Wolery, T. J., The dissolution kinetics of quartz as a function of pH and time at 70 °C. Geochim. Cosmochim. Acta. Vol. 52, pp 43-53. 1988

Knauss, K. G. and Wolery, T. J., Muscovite dissolution kinetics as a function of pH and time at 70 °C. Geochim. Cosmochim. Acta. Vol. 53, pp 1493-1501. 1989

Krauskopf, K. B., Dissolution and precipitation of silica at low temperatures. *Geochim. Cosmochim. Acta*. Vol. 10, pp 1-26. 1956.

Laaksoharju, M., Measured and predicted groundwater chemistry at Äspö. SKP, PR 25-90-13, 1990.

Lagerblad, B., Kemi och genes av djupa grundvatten i kristallint berg. SKI rapport, 1994.

Lagerblad, B. and Trägårdh, J., Slowly reacting aggregates in Sweden: Mechanism and conditions for reactivity in concrete. *Proceedings of 9th International Conference on alkali-aggregate reaction*, pp 570-578. London, 1992.

Lagerblad, B. and Trägårdh, J., Alkali-silica reaction in high strength concrete. *Proceedings of the International RILEM Workshop on Durability of High Performance Concrete* (editor: H. Sommer). p 143-153, 1995.

Lagerblad, B. and Utkin, P., Silica granulates in concrete - dispersion and durability problems. CBI-report 3:93, 1993.

Lasaga, A. C., Chemical kinetics of water-rock interactions. *J. Geophys. Res.* Vol. 89, pp 4009-4025. 1984.

Mather, K., Conditions of concrete in Martin Dam after 50 years of service. *Cement, Concrete and aggregates*, Vol 3, No 1, pp 53-62. 1972.

Malinowski, R: Einige Baustoffprobleme der antiken Aquädukten. *Chalmers Tekniska Högskola, avd för byggnadsmaterial*, Publ. 77:2. 1977.

Malinowski, R., Concretes and Mortars in Ancient Aqueducts, *Concrete International*, January 1979, pp 66-77.

Mallinson, L. G. and Davies, I. LI., A historical examination of concrete, in nuclear science and technology. Published by Commission of the European Communities, Report EUR10937 EN, Luxembourg 1987.

Marfil, S. A. and Maiza, P. J., Zeolite crystallization in Portland cement concrete due to alkali-aggregate reaction. *Cement and Concrete Research*, Vol. 23, pp 1283-1288, 1993.

Massazza, F., Concrete resistance to seawater and marine environment. *Il Cemento*, 1985, pp 3-27.

Mchedlov-Petrosyan, O. P., Vyrodov, I. P. and Papkova, L. P., Written discussion, *Proc. Symp. Chemistry of Cement*, Tokyo 1968, II, p. 32.

Neville, A. M., *Properties of concrete*. Pitman publ. LTD. pp 1-779. 1981.

Nilsson, A-Ch., Chemical characterization of deep groundwater on ÄSPÖ. SKB PR 25-89-14., 1989.

Nurmi, P.A., Kukkonen, I.T. and Lahermo, P.W., *Geochemistry and origin of saline groundwaters, Fennoscandian Shield.*, *Applied geochemistry*, Vol. 3 nr 2. 1988.

Oberholster, R.E, Maree, H, and Brand, J.H.B. Cracked prestressed concrete railway sleepers: Alkali-silica reaction or delayed ettringite formation. *Proceedings 9th International Conference on alkali-aggregate reaction*. London, 1992.

Onofrei, M., Gray, M., Pusch, R., Börjesson, L., Karnland, O., Shenton, B. and Walker, B., Sealing properties of cement grout materials. SKB Technical Report, 92-28. Stripa project. 1992.

Olliver, J. P and Massat, M., Permeability and microstructure of concrete: a review of modelling. *Cement and Concrete Research*, Vol. 22, pp 503-514. 1992.

Powers, T. C, Copeland, L. E., Mann, H. M., *Capillary continuity or discontinuity in cement pastes*, *J. Portl. Cem. Assoc. Research and Development Laboratories*, 1, No 2, pp 38-48, 1959.

Putterill, K., E. and Oberholster, R., E., Investigation of different variables that influence the expansion of concrete caused by alkali-aggregate reaction under natural environmental conditions., *National building Res. Inst. Council for scientific and industrial research*, CSIR res. Rep. BRR 626, 31 pp, 1985.

Pusch, R. and Börjesson, L., Project on alternative systems study. Performance assessment of bentonite clay barrier in three repository concepts: VDH, KBS-3 and VLH. SKB Technical Report 92-40, 1992.

Rasmuson, A., Neretnieks, I., and Zhu, M., Calculations of the degradation of concrete in a final repository for nuclear waste. Proceedings NEA workshop: Near Field Assessment of Repository for low and medium Nuclear Waste, pp 159-171, 1987.

Richart, W., Die Bindung von Chlorid bei Zement erhärtung, Zement-Kalk-Gips, Heft 10 1969, pp 447-456.

Savage, D, Bateman, K, Hill, P, Hughes, C, Milodowski, A, Pearce, J, Rae, E and Rochelle, C., Rate and mechanism of the reaction of silicates with cement pore fluids. Applied Clay Science, Vol. 7, pp 33-45. 1992.

Soers, E and Meyskens, M. Petrographical research on alkali-aggregate reactions in concrete structures in Belgium. Proceedings 8th International Conference on alkali-aggregate reaction, Kyoto, Japan. pp 457-468. 1989.

Struble, L.J., The influence of cement pore solution on alkali-silica reaction. PhD thesis, Purdue University, pp 281. 1987.

Stumm and Morgan., Aquatic chemistry. Wiley and Sons, pp 1-780. 1981.

Tang, L and Nilsson, N-O., A study of the quantitative relationship between permeability and pore size distribution of hardened cement pastes. Cement and Concrete Research, Vol. 22, pp 541-550. 1992.

Taylor, H. F. W., Hydrated calcium silicates, Part 1, Compound formation at ordinary temperatures, J. Chem, Soc, 3682-3690, 1950.

Taylor, H. F. W., Crystal structures of some double hydroxide minerals, Mineralogical Magazine, Vol. 39, nr 304, 1973.

Taylor, H.F.W., Cement Chemistry. Academic press. pp 1-475. 1990.

Taylor, H. F. W., Nanostructure of C-S-H: current status. Advn. Cem. Bas. Mat. No 1, pp 22-37, 1993.

Trägårdh, J. and Lagerblad, B., Influence of ASR expansion on the frost resistance of concrete. CBI-report, 1995 (in press). Submitted to The 10th International Conference on Alkali-Aggregate reaction in Concrete, august 1996, Melbourne, Australia.

Tuutti, K., Corrosion of steel in concrete, CBI research 4-82. 469 p. 1982.

van Aardt, J. H. P. and Visser, S., Calcium hydroxide attack on feldspars and clays: possible relevance to cement-aggregate reactions. Cement and Concrete Research. Vol. 7, pp 643-648. 1977.

Wang and Gillott., Effect of $\text{Ca}(\text{OH})_2$ on alkali-silica reaction. Magazine of Concrete Research, Vol. 43, No 156, pp 215-218. 1991.

Wang and Gillott., Mechanism of alkali-silica reaction and the significance of calcium hydroxide. Cement and Concrete Research. Vol. 21, pp 647-654. 1991.

Worthington J. C., Bonner, D. G. and Nowell D. V., Influence of cement chemistry on chloride attack of concrete. Materials Science and Technology, Vol. 4, 305-313, 1988.

Specific abbreviations in cement terminology

C = CaO

S = SiO₂ $\overline{\text{A}}$ = Al₂O₃F = Fe₂O₃

M = MgO

K = K₂O $\overline{\text{S}}$ = SO₃ $\overline{\text{N}}$ = Na₂OT = TiO₂P = P₂O₅H = H₂O, OH $\overline{\text{C}}$ = CO₂CementC₃S = Tricalcium silicateC₂S = Dicalcium silicateC₃A = Tricalcium aluminateC₄AF = Tetracalcium alumino ferrite

Std P = Standard Portland cement

Cement hydration phases

AFm = Alumina-Iron-Mono

AFt = Alumina-Iron-Tri

CH = Calcium dihydroxide

C-S-H = Calcium silicate-hydrate

ASR alkali-silica reaction

RH relative humidity

W/C Water cement ratio

CSF Condensed Silica Fume

OPC Ordinary Portland Cement

List of SKB reports

Annual Reports

1977-78

TR 121

KBS Technical Reports 1 – 120

Summaries

Stockholm, May 1979

1979

TR 79-28

The KBS Annual Report 1979

KBS Technical Reports 79-01 – 79-27

Summaries

Stockholm, March 1980

1980

TR 80-26

The KBS Annual Report 1980

KBS Technical Reports 80-01 – 80-25

Summaries

Stockholm, March 1981

1981

TR 81-17

The KBS Annual Report 1981

KBS Technical Reports 81-01 – 81-16

Summaries

Stockholm, April 1982

1982

TR 82-28

The KBS Annual Report 1982

KBS Technical Reports 82-01 – 82-27

Summaries

Stockholm, July 1983

1983

TR 83-77

The KBS Annual Report 1983

KBS Technical Reports 83-01 – 83-76

Summaries

Stockholm, June 1984

1984

TR 85-01

Annual Research and Development Report 1984

Including Summaries of Technical Reports Issued during 1984. (Technical Reports 84-01 – 84-19)

Stockholm, June 1985

1985

TR 85-20

Annual Research and Development Report 1985

Including Summaries of Technical Reports Issued during 1985. (Technical Reports 85-01 – 85-19)

Stockholm, May 1986

1986

TR 86-31

SKB Annual Report 1986

Including Summaries of Technical Reports Issued during 1986

Stockholm, May 1987

1987

TR 87-33

SKB Annual Report 1987

Including Summaries of Technical Reports Issued during 1987

Stockholm, May 1988

1988

TR 88-32

SKB Annual Report 1988

Including Summaries of Technical Reports Issued during 1988

Stockholm, May 1989

1989

TR 89-40

SKB Annual Report 1989

Including Summaries of Technical Reports Issued during 1989

Stockholm, May 1990

1990

TR 90-46

SKB Annual Report 1990

Including Summaries of Technical Reports Issued during 1990

Stockholm, May 1991

1991

TR 91-64

SKB Annual Report 1991

Including Summaries of Technical Reports Issued during 1991

Stockholm, April 1992

1992

TR 92-46

SKB Annual Report 1992

Including Summaries of Technical Reports Issued during 1992

Stockholm, May 1993

1993

TR 93-34

SKB Annual Report 1993

Including Summaries of Technical Reports Issued during 1993

Stockholm, May 1994

1994

TR 94-33

SKB Annual Report 1994

Including Summaries of Technical Reports Issued during 1994.

Stockholm, May 1995

List of SKB Technical Reports 1995

TR 95-01

Biotite and chlorite weathering at 25°C. The dependence of pH and (bi) carbonate on weathering kinetics, dissolution stoichiometry, and solubility; and the relation to redox conditions in granitic aquifers

Maria Malmström¹, Steven Banwart¹, Lara Duro², Paul Wersin³, Jordi Bruno³

¹ Royal Institute of Technology, Department of Inorganic Chemistry, Stockholm, Sweden

² Universidad Politécnica de Cataluña, Departamento de Ingeniería Química, Barcelona, Spain

³ MBT Tecnología Ambiental, Cerdanyola, Spain
January 1995

TR 95-02

Copper canister with cast inner component. Amendment to project on Alternative Systems Study (PASS), SKB TR 93-04

Lars Werme, Joachim Eriksson
Swedish Nuclear Fuel and Waste Management Co,
Stockholm, Sweden
March 1995

TR 95-03

Prestudy of final disposal of long-lived low and intermediate level waste

Marie Wiborgh (ed.)

Kemakta Konsult AB, Stockholm, Sweden
January 1995

TR 95-04

Spent nuclear fuel corrosion: The application of ICP-MS to direct actinide analysis

R S Forsyth¹, U-B Eklund²

¹ Caledon-Consult AB, Nyköping, Sweden

² Studsvik Nuclear AB, Nyköping, Sweden
March 1995

TR 95-06

Palaeohydrological implications in the Baltic area and its relation to the groundwater at Äspö, south-eastern Sweden – A literature study

Bill Wallin

Geokema AB, Lidingö, Sweden

March, 1995

TR 95-07

Äspö Hard Rock Laboratory Annual Report 1994

SKB

April 1995

TR 95-08

Feasibility study for siting of a deep repository within the Storuman municipality

Swedish Nuclear Fuel and Waste

Management Co., Stockholm

January 1995

TR 95-09

A thermodynamic data base for Tc to calculate equilibrium solubilities at temperatures up to 300°C

Ignasi Puigdomènech¹, Jordi Bruno²

¹ Studsvik AB, Nyköping, Sweden

² Intera Information Technologies SL,
Cerdanyola, Spain

April 1995

TR 95-10

Investigations of subterranean microorganisms.

Their importance for performance assessment of radioactive waste disposal

Karsten Pedersen¹, Fred Karlsson²

¹ Göteborg University, General and Marine Microbiology, The Lundberg Institute, Göteborg, Sweden

² Swedish Nuclear Fuel and Waste Management Co., Stockholm, Sweden

June 1995

TR 95-11

Solute transport in fractured media – The important mechanisms for performance assessment

Luis Moreno, Björn Gylling, Ivars Neretnieks

Department of Chemical Engineering and Technology, Royal Institute of Technology, Stockholm, Sweden

June 1995

TR 95-12

Literature survey of matrix diffusion theory and of experiments and data including natural analogues

Yvonne Ohlsson, Ivars Neretnieks
Department of Chemical Engineering and Technology, Royal Institute of Technology, Stockholm, Sweden
August 1995

TR 95-13

Interactions of trace elements with fracture filling minerals from the Äspö Hard Rock Laboratory

Ove Landström¹, Eva-Lena Tullborg²
¹ Studsvik Eco & Safety AB
² Terralogica AB
June 1995

TR 95-14

Consequences of using crushed crystalline rock as ballast in KBS-3 tunnels instead of rounded quartz particles

Roland Pusch
Clay Technology AB
February 1995

TR 95-15

Estimation of effective block conductivities based on discrete network analyses using data from the Äspö site

Paul R La Pointe¹, Peter Wallmann¹, Sven Follin²
¹ Golder Associates Inc., Seattle, WA, USA
² Golder Associates AB, Lund, Sweden
September 1995

TR 95-16

Temperature conditions in the SKB study sites

Kaj Ahlbom¹, Olle Olsson¹, Stefan Sehlstedt²
¹ Conterra AB
² MRM Konsult AB
June 1995

TR 95-17

Measurements of colloid concentrations in the fracture zone, Äspö Hard Rock Laboratory, Sweden

Anna Ledin, Anders Düker, Stefan Karlsson, Bert Allard
Department of Water and Environmental Studies, Linköping University, Linköping, Sweden
June 1995

TR 95-18

Thermal evidence of caledonide foreland, molasse sedimentation in Fennoscandia

Eva-Lena Tullborg¹, Sven Åke Larsson¹, Lennart Björklund¹, Lennart Samuelsson², Jimmy Stigh¹
¹ Department of Geology, Earth Sciences Centre, Göteborg University, Göteborg, Sweden
² Geological Survey of Sweden, Earth Sciences Centre, Göteborg, Sweden
November 1995

TR 95-19

Compaction of bentonite blocks. Development of technique for industrial production of blocks which are manageable by man

Lars-Erik Johannesson, Lennart Börgesson, Torbjörn Sandén
Clay Technology AB, Lund, Sweden
April 1995

TR 95-20

Modelling of the physical behaviour of water saturated clay barriers. Laboratory tests, material models and finite element application

Lennart Börgesson¹, Lars-Erik Johannesson¹, Torbjörn Sandén¹, Jan Hernelind²
¹ Clay Technology AB, Lund, Sweden
² FEM-Tech AB, Västerås, Sweden
September 1995