

Forsmark site investigation

Hydrochemical characterisation in borehole KFM08A

Results from the investigated section at 683.5–690.6 (690.8) m

Cecilia Berg, Anette Bergelin, Pia Wacker
ÅF Process AB/Geosigma AB

Ann-Chatrin Nilsson, Geosigma AB

June 2006

Svensk Kärnbränslehantering AB

Swedish Nuclear Fuel
and Waste Management Co
Box 5864

SE-102 40 Stockholm Sweden

Tel 08-459 84 00

+46 8 459 84 00

Fax 08-661 57 19

+46 8 661 57 19



Forsmark site investigation

Hydrochemical characterisation in borehole KFM08A

Results from the investigated section at 683.5–690.6 (690.8) m

Cecilia Berg, Anette Bergelin, Pia Wacker
ÅF Process AB/Geosigma AB

Ann-Chatrin Nilsson, Geosigma AB

June 2006

Keywords: Groundwater, Measurements on-line, In situ sampling, Measurements in situ, Redox potential, Dissolved gas, Humic and fulvic acids, Colloids, Laser-induced breakdown colloid detection, Microbes, Chemical analyses, Isotope determinations, AP PF 400-05-063.

This report concerns a study which was conducted for SKB. The conclusions and viewpoints presented in the report are those of the authors and do not necessarily coincide with those of the client.

A pdf version of this document can be downloaded from www.skb.se

Abstract

Complete chemical characterisation is the most extensive chemical investigation method performed in core drilled boreholes. The method entails pumping, measurements on-line and regular water sampling for chemical analyses in isolated borehole sections during approximately three weeks per section at a flow rate of between 50 and 200 mL/min.

The method has been used in a section from borehole KFM08A at 683.5–690.6 (690.8) m borehole length (vertical depth 543.9–549.0 m). The results include on-line measurements of redox potential, pH, dissolved oxygen, electrical conductivity and water temperature in the borehole section, together with chemical analyses of major constituents, trace metals and isotopes as well as gas content and composition. Furthermore, inorganic and organic colloids (humic and fulvic acids) were investigated both by fractionation and laser-induced breakdown colloid detection (LIBD).

The water composition was stable during the pumping and sampling periods and the chloride concentration amounted to 6,200 mg/L. However, the iron, aluminium and DOC concentrations varied more than usual and the field-pH (on-line) was rather high (8.0). Only one redox electrode (the carbon electrode in the borehole) measured reasonable and stable values but just for a short time (~ 24 hours). The Eh value (–210 mV) for the groundwater from the borehole section is therefore uncertain. The content of colloids was low (6–7 µg/L) and the organic constituents were present mainly as fulvic acids or other low molecular weight acids (citric acid, oxalic acids, etc). A summary of results from colloid filtration and LIBD in groundwaters from KFM08A and previously investigated boreholes is given in this report.

Sammanfattning

Fullständig kemikaraktisering är den mest omfattande kemiska undersökningsmetoden för kärnborrhål. Metoden innebär pumpning, mätning on-line och regelbunden vattenprovtagning för kemiska analyser i avgränsade borrhålssektioner under cirka tre veckor per sektion med ett pumpflöde på mellan 50 och 200 mL/min.

Metoden har utförts i en sektion av borrhålet KFM08A vid 683,5–690,6 (690,8) m borrhålslängd (vertikalt djup 543,9–549,0 m). Resultaten omfattar mätningar on-line av redoxpotential, pH, löst syre, elektrisk konduktivitet och vattentemperatur i borrhålssektionen liksom kemiska analyser av huvudkomponenter, spårelement, isotoper samt bestämning av gasinnehåll och sammansättning. Vidare undersöktes oorganiska och organiska colloider (humus och fulvosyror) med fraktioneringsteknik och detektering genom laserinducerad nedbrytning (LIBD).

Vattensammansättningen var stabil under pump/provtagningsperioden och kloridkoncentrationen uppgick till 6 200 mg/L. Järn-, aluminium- och DOC-koncentrationerna varierade mer än vad som vanligtvis är fallet och fält-pH (on-line) var ganska högt (8,0). Endast en redoxelektrod (kolelektroden i borrhålet) mätte rimliga och stabila värden, dock endast för en kort tidsperiod (~ 24 timmar). Eh-värdet (–210 mV) för grundvattnet från borrhålssektionen är därför osäkert. Innehållet av kolloider var lågt (6–7 µg/L) och de organiska komponenterna förelåg huvudsakligen som fulvosyror eller andra lågmolekylära syror (citronsyra, oxalsyra etc). En sammanställning av resultat från kolloidfiltrering och LIBD i grundvatten från KFM08A och tidigare undersökta borrhål presenteras i denna rapport.

Contents

1	Introduction	7
2	Objectives and scope	9
3	Background	11
3.1	Flushing water history	11
3.2	Previous events and activities in the borehole	12
3.3	Choice of borehole sections	14
4	Equipment	15
4.1	The mobile field laboratory	15
4.2	Equipment for enrichment of humic and fulvic acids	17
4.3	Equipment for fractionation of humic and fulvic acids	18
5	Performance	19
5.1	General	19
5.2	Overview of field work procedure	20
5.3	Performance in section 683.5–690.6 and 683.5–690.8 m	21
5.4	Water sampling, sample treatment and analyses	23
5.5	Collection of in situ water samples	23
5.6	Enrichment of humic and fulvic acids	24
5.7	Fractionation of organic and inorganic species	24
6	Nonconformities	25
7	Data handling and interpretation	27
7.1	Chemmac measurement data	27
7.1.1	Data file types and calculation software	27
7.1.2	Calculations and evaluation of redox potential and pH	28
7.2	Water analysis data	29
7.3	Data from special sampling methods	30
7.3.1	Dissolved gases	30
7.3.2	Enrichment of humic and fulvic acids	31
7.3.3	Fractionation of organic and inorganic species	31
8	Results	33
8.1	Chemmac measurements	33
8.2	Water analyses	33
8.2.1	Basic water analyses	33
8.2.2	Trace elements (rare earth metals and others)	37
8.2.3	Stable and radioactive isotopes	37
8.3	Dissolved gas	38
8.4	Colloids	38
8.4.1	Inorganic colloids – fractionation	40
8.4.2	Humic and fulvic acids – fractionation	41
9	Summary and discussion	43
10	References	45

Appendix 1	Design of cored borehole KFM08A	47
Appendix 2	Selected results from differential flow logging, KFM08A	49
Appendix 3	Selected BIPS logging image, KFM08A	51
Appendix 4	Measurement information, KFM08A	53
Appendix 5	Flow and pressure measurements, KFM08A	55
Appendix 6	Sampling and analytical methods	57
Appendix 7	Laser-Induced Breakdown Colloid Detection in Natural Ground Water from Forsmark Borehole KFM08A, Section 683.5–690.6 m	65
Appendix 8	Chemmac measurements in KFM08A, section 683.5–690.6 (690.8) m	73
Appendix 9	Compilation of chemical data, June 2006	77

1 Introduction

This document reports performance and results of the activity Complete Chemical Characterisation in borehole KFM08A within the site investigation programme at Forsmark /1/. The work was conducted according to the activity plan AP PF 400-05-063. The report presents hydrogeochemical data from fieldwork carried out during June to November 2005. The borehole sections at 683.5–690.6 and 683.5–690.8 m are denoted as 683.5–690.6 (690.8) in the report. The two somewhat different section lengths are due to the borehole pump being exchanged twice and the two pumps that were used had variable lengths.

The controlling documents for the activity are listed in Table 1-1. The activity plan, the method description and the measurement system descriptions constitute SKB's internal controlling documents. The obtained data from the activity are reported to the SICADA database and traceable by the activity plan number. Sampling for microbe studies, based on the activity plan AP PF 400-05-66, was also performed within the present activity. The microbe investigations will be reported in a separate primary data report /2/.

Borehole KFM08A is a telescopic borehole /3/ and its location together with other current deep telescopic boreholes within the investigation area are shown in Figure 1-1. Figure 1-2 presents a detailed map of drill site DS8 with KFM08A and nearby situated percussion drilled boreholes all indicated. KFM08A is inclined at 60°, dipping northwest. The borehole section between 0–100 m is percussion drilled and has a stainless steel casing with an internal diameter of 200 mm, whereas the 102.26–1,001.19 m interval is core drilled with a diameter of 77.3 mm. The design of the borehole is presented in Appendix 1. The borehole is one of the so-called SKB chemical-type; see the SKB method descriptions MD 620.003 (Method description for drilling cored boreholes) and MD 610.003 (Method description for percussion drilling). An SKB chemical-type borehole requires cleaning procedures to be carried out on all equipment used in the borehole, both during and after drilling, according to level 2 in the cleaning instructions outlined in MD 600.004 (Instruktion för rengöring av borrhålsutrustning och viss markbaserad utrustning).

Table 1-1. Controlling documents for performance of the activity.

Activity plan	Number	Version
Fullständig kemikaraktärisering med mobilt fältlaboratorium i KFM08A.	AP PF 400-05-063	1.0
Method descriptions	Number	Version
Metodbeskrivning för fullständig kemikaraktärisering med mobilt fältlaboratorium.	SKB MD 430.017	2.0
Measurement system descriptions	Number	Version
Instruktion för rengöring av borrutrustning och viss markbaserad utrustning.	SKB MD 600.004	1.0
Mätsystembeskrivningar för mobil kemienhet allmän del, slangvagn, borrhålsutrustning, mobil ytChemmac och dataapplikation.	SKB MD 434.004 SKB MD 434.005 SKB MD 434.006 SKB MD 434.007 SKB MD 433.018	1.0 1.0 1.0 1.0 1.0
Mätsystembeskrivning för fraktionering av humus- och fulvosyror.	SKB MD 431.043	1.0
Mätsystembeskrivning för uppkoncentrering av humus- och fulvosyror.	SKB MD 431.044	
Instructions		
Provtagning och analys-kemilaboratorium.	SKB MD 452.001-019	–

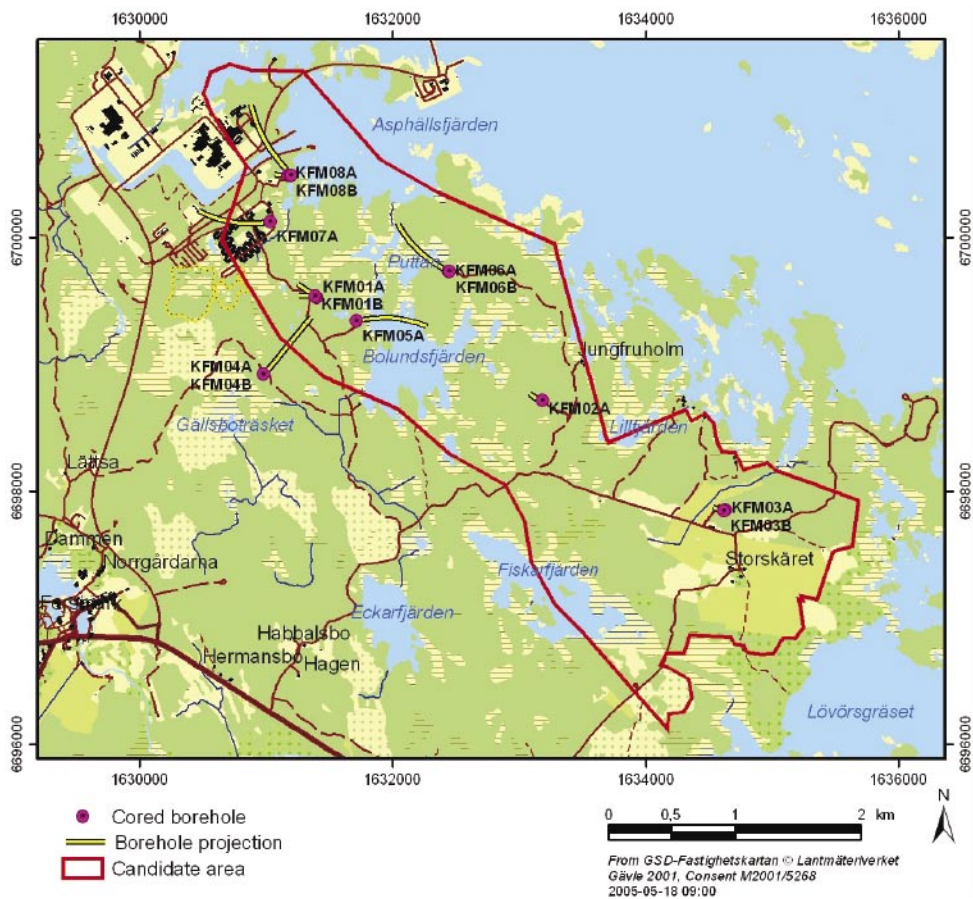

Figure 1-1. The investigation area at Forsmark (approximately the area shown) with the candidate area selected for more detailed investigations. The cored boreholes, including KFM01A to KFM08B, are marked with pink infilled circles.

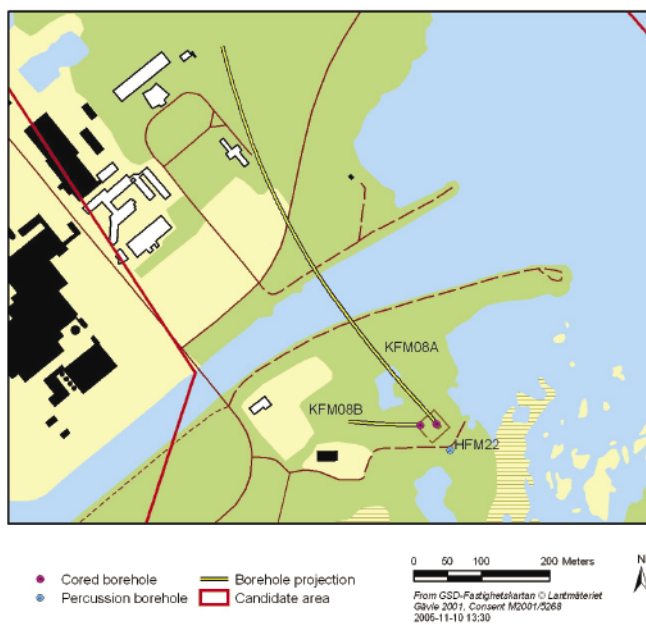

Figure 1-2. Location of the cored boreholes KFM08A, KFM08B and the percussion borehole HFM22 at drill site DS8.

2 Objectives and scope

Complete chemical characterisation is the most extensive chemical investigation method performed in core drilled boreholes. The method is carried out in order to achieve as much information as possible about the chemical conditions in the groundwater from individual water-bearing fractures or fracture zones. Considerable effort is put into obtaining representative samples from a limited rock volume. Careful pumping and continuous control of the pressure in the sampled borehole section, as well as above the section, is maintained in order to minimise the risk of mixing with groundwaters from other fracture systems.

A decision has been made to prioritise the north-western part of the Forsmark candidate area for the continuing investigations /4/. So far, representative chemical data from borehole sections at depths greater than 200 m are scarce from this part of the area. The only deeper sections investigated are at vertical depths 302 m and 645 m in KFM06A and at 790 m in KFM07A. Further, there are reasons to believe that there will be very few water-yielding fractures at depth also in the forthcoming boreholes. Therefore, every opportunity to conduct chemical investigations at depth, in this part of the candidate area, needs to be taken.

The analytical programme was carried out according to SKB chemistry class 4 and class 5 including all options /1/. Furthermore, pH, redox potential (Eh) and water temperature were measured in flow-through cells downhole as well as at the ground surface. The flow-through cell at the surface also measured electrical conductivity and dissolved oxygen. Samples were collected in situ in the borehole section for determination of gas content and composition, microbe content and their characterisation as well as for determination of colloid content by the LIBD technique. Fractionation of organic acids and inorganic species were performed in order to investigate size distribution (DOC and ICP analyses) and enrichment of organic acids was conducted in order to determine $\delta^{13}\text{C}$ and pmC in organic constituents.

3 Background

3.1 Flushing water history

The percussion drilled borehole HFM22 served as a supply well for the flushing water used to drill borehole KFM08A /5/. The chemical composition of the flushing water was checked before and during use /6/. The core drilling of the 1,001.19 m long borehole consumed 1,196 m³ of flushing water and the volume of returned water pumped from the borehole by air-lift pumping during drilling was 1,210 m³. The difference in volume is unusually small and the reason for this is that the borehole itself yields very little water. After the drilling, nitrogen flushing was carried out five times from the hole bottom which exchanged an additional volume of 29 m³ borehole water.

Automatic dosing equipment to introduce Uranine was installed in the water line which supplies flushing water to the drilling head. The Uranine concentration in the flushing water and returned water was checked regularly and a total of 114 samples of each sample type were analysed. The average concentration in the flushing water amounted to 0.200 ± 0.014 mg/L. The Uranine concentrations in the flushing water and in the returned water are presented in Figure 3-1. The diagram displays that the returned water is more or less similar to the water added to the borehole except for the final volume close to the bottom of the borehole where the water yielding fracture is located. A water budget, presenting the amount of Uranine added to the borehole via the flushing water and the estimated amount recovered in the return water, is given in Table 3-1.

The Uranine budget in Table 3-1 suggests that only about 60–86 m³ of the flushing water was lost to the borehole and the adjacent host bedrock during the drilling. Additional cleaning was also obtained by nitrogen flushing after the drilling. However, no Uranine analyses were performed on these exchanged water volumes.

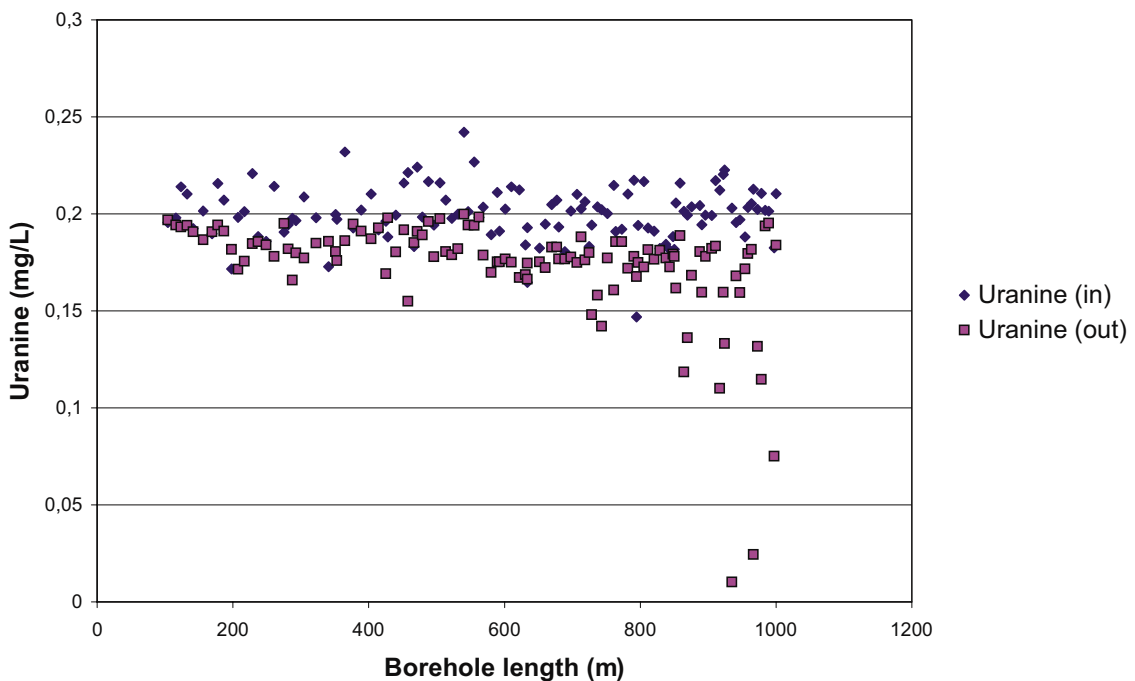

Figure 3-1. Uranine concentrations in the flushing water and in the recovered water versus borehole length.

Table 3-1. Amount of Uranine added to KFM08A via the flushing water during core drilling and the amount recovered from the contemporary air-lift pumping.

Uranine	(g)
Added, according to the log book.	234
Added, calculated from the average Uranine concentration and the total volume of flushing water.	240
Recovered, estimated from the average Uranine concentration and the total volume of returned water.	223

As borehole KFM08A is of SKB chemical-type, the following special precautions were taken in order to minimise contamination via the flushing water:

- The supply well was also of SKB chemical-type.
- Borehole HFM22 was selected to supply flushing water because of the low concentration of total organic carbon (TOC). The concentration should preferably be below 5 mg/L and the concentration in the samples collected in HFM22 was in the range of 3.1–3.3 mg/L.
- Dosing equipment for Uranine was installed, thereby removing the need for an in-line flushing water storage tank placed after the UV-system.
- In order to minimise air contamination, nitrogen gas blowing is conducted in the water storage tank placed before the UV-system in the flushing water line.

The microbe content in the flushing water was not determined during drilling of this borehole. The results from the preceding borehole KFM06A /7/ showed convincingly that the cleaning procedure works well and it was concluded that to check for microbes at all drilling occasions was no longer necessary.

3.2 Previous events and activities in the borehole

KFM08A is an SKB chemical-type core borehole and thus specially intended for complete hydrochemical characterisation. Only those borehole activities that are necessary in order to select borehole sections are carried out in the borehole prior to the chemistry campaign. The more downhole equipment used in the borehole, the greater is the risk of contamination and effects, for example on the in situ microbiological conditions. The activities/investigations performed in KFM08A prior to the chemistry campaign are listed in Table 3-2 below.

Table 3-2. Activities performed in KFM08A in connection to the chemical characterisation.

Activities performed	Date of completion	Length or section (m)	Comment
Percussion drilling	2004-09-27	0–100.6	
Core drilling	2005-03-31	100.6–1,001.2	HFM22 was the source of flushing water for drilling the cored part of KFM08A. HFM22 is a SKB chemical-type borehole /3, 5, 6/. Flushing water volume = 1,196 m ³ . Return water volume 1,210 m ³ .
Flushing water treatment	–	–	Automatic dosing of Uranine was used during drilling of KFM08A. In this way there was no need for an in-line storage tank placed after the UV-system /3/.
Water sampling	2005-02-02	100–203.5	SKB class 3, Sample no. 8786.
Pressure measurements, wire-line	2005-04-04	472.7–589.3 590.7–718.8 717.2–794.4 900.7–1,001.2	/3/
Nitrogen lifting of water column	2005-04-21	0–1,001.2	Five separate liftings were performed and a total volume of 29 m ³ was exchanged.
Geophysical logging	2005-04-29	100–1,000	/8/
BIPS-logging	2005-05-09	102–980	/9/
Radar logging	2005-05-11	102–990	/9/
Differential flow logging	2005-05-20	102–920	/10/
Groundwater recovery	2005-05-30		Groundwater recovery after pumping 2005-05-20–2005-05-30 /10/
Hydrochemical logging	2005-05-30	10–910	Sample nos. 8895 to 8910 /11/.
Clean-up pumping			Pumped volume ~ 200 + 187 m ³ 2005-06-20–2005-07-04 2005-08-10–2005-09-05
Hydrochemical characterisation	2005-11-02	683.5–690.6 (690.8)	Presented in this report.
Microbe investigation	2005-11-01	683.5–690.8	/2/

3.3 Choice of borehole sections

The differential flow logging /10/ prior to the chemical investigation revealed several water-bearing zones in the shallow part of the borehole between 110 and 250 m. Furthermore, one deep zone was identified close to 700 m borehole length and a probable zone was indicated below 912 m borehole length. The interesting fracture zones with a water yield large enough to allow water sampling are listed in Table 3-2. Due to lack of data at great depth in this part of the candidate area, selection of the zone at 687 m was obvious. It was considered worthwhile to test also the deep zone at 912 m even if there was a risk that the water yield was too small. The more shallow depths, already well characterised from other boreholes, were regarded as less important to investigate and could therefore be excluded.

Section limits and the corresponding hydraulic transmissivity values for the selected borehole sections are given in Table 3-4.

The differential flow log for the relevant part of the borehole is given in Appendix 2 and the corresponding picture from BIPS-logging (Borehole Image Processing System) is presented in Appendix 3.

Table 3-3. Water-yielding fractures/fracture zones and approximate flow rates (approximately 10 m drawdown) identified from differential flow logging of KFM08A. The selected fractures are given in bold text.

Borehole length (m)	Flow (L/h)	Comments
184–197	9–100	Several fractures
274	60	
480	3	
687	90	
> 912	uncertain	

Table 3-4. Selected borehole sections for hydrochemical characterisation and hydraulic transmissivity calculated from difference flow logging (T_D).

Section (m)	T_D (m^2/s) /10/	Comments
683.5–690.6 (690.8)	1.9×10^{-6}	One dominating fracture within the section between 685.5–690.5.
912	Uncertain	No logging was performed below approximately 916 m.

4 Equipment

4.1 The mobile field laboratory

The mobile field laboratories used by SKB for water sampling and downhole measurements consist of a laboratory unit, a separate computer unit (MYC), a hose unit with downhole equipment and a Chemmac measurement system. The equipment setup is presented in Figures 4-1 and 4-2. The different parts of the system are described in the SKB internal controlling documents SKB MD 434.004, 434.005, 434.006, 434.007 and SKB MD 433.018 (Mätssystembeskrivningar för mobil kemienhet allmän del, slangvagn, borrhålsutrustning, mobil ytChemmac och dataapplikation).

The Chemmac measurement facilities include communication systems, measurement application and flow-through cells with electrodes and sensors at the ground surface (surface Chemmac) and downhole (borehole Chemmac).

The downhole equipment comprises inflatable packers, pump, borehole Chemmac and the in situ sampling unit (PVP), allowing measurement (borehole Chemmac) and sampling *in situ* in the borehole section (PVP sampling unit). The four sampled portions of ground-water collected with the PVP sampling unit maintain the pressure from the borehole section when raised to the surface. The portions are used for colloid and gas analysis and microbe investigations.

The mobile units used for the investigation of borehole KFM08A consisted of either the hose unit S2 together with the computer unit MYC 2 including surface Chemmac or S3 combined with MYC 3. The arrangement at drill site DS8 is displayed in Figure 4-1. The units were exchanged during the investigation period due to technical problems. The laboratory unit L3 was employed for analytical work but was located close to the core mapping facility and not at drill site DS8.



Figure 4-1. The mobile field laboratory units at KFM08A; from the left a computer unit (MYC 2), container for collecting the water from the borehole, hose unit with downhole equipment (S2) and a spare unit for computer work (MYC3), November 2005.

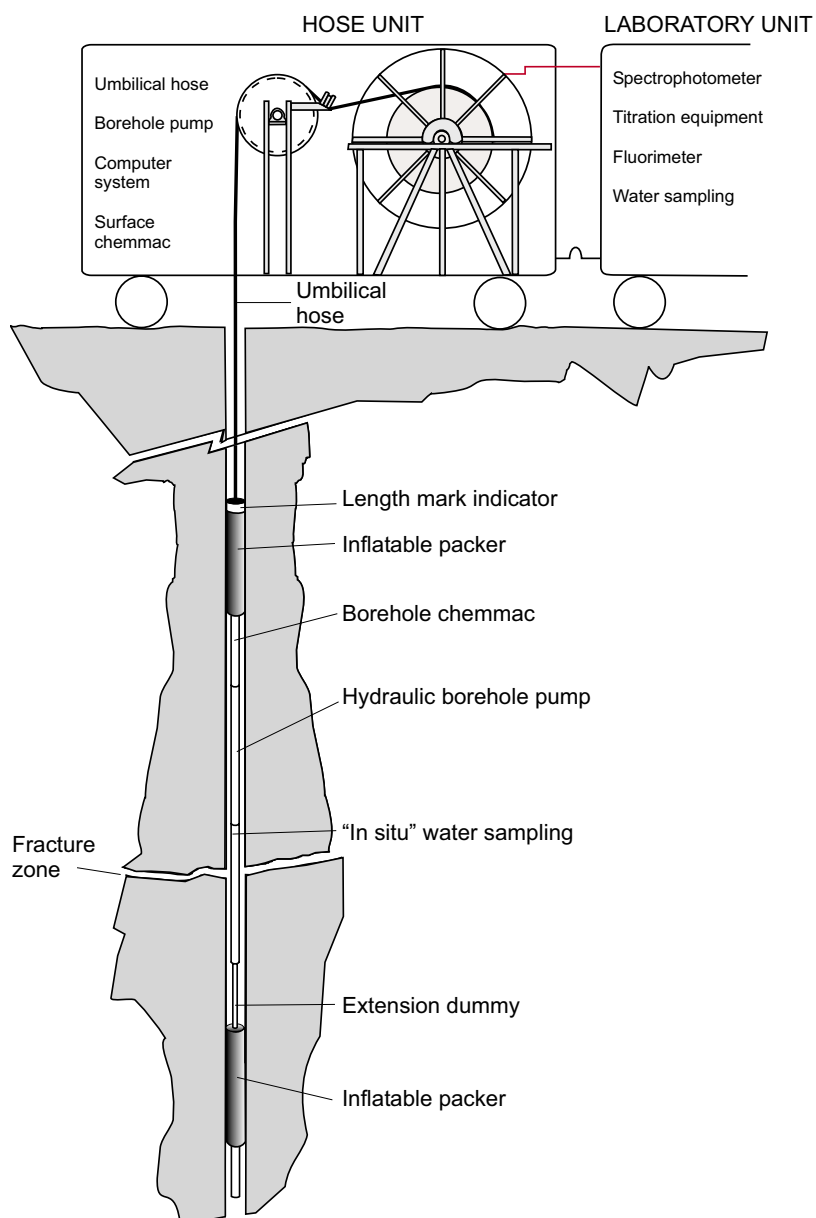

Figure 4-2. The mobile laboratory including laboratory unit, hose unit and downhole equipment. The configuration of the downhole units in the borehole can be varied depending on desired section length. However, the *in situ* water sampler must always be positioned first in the sample water path.

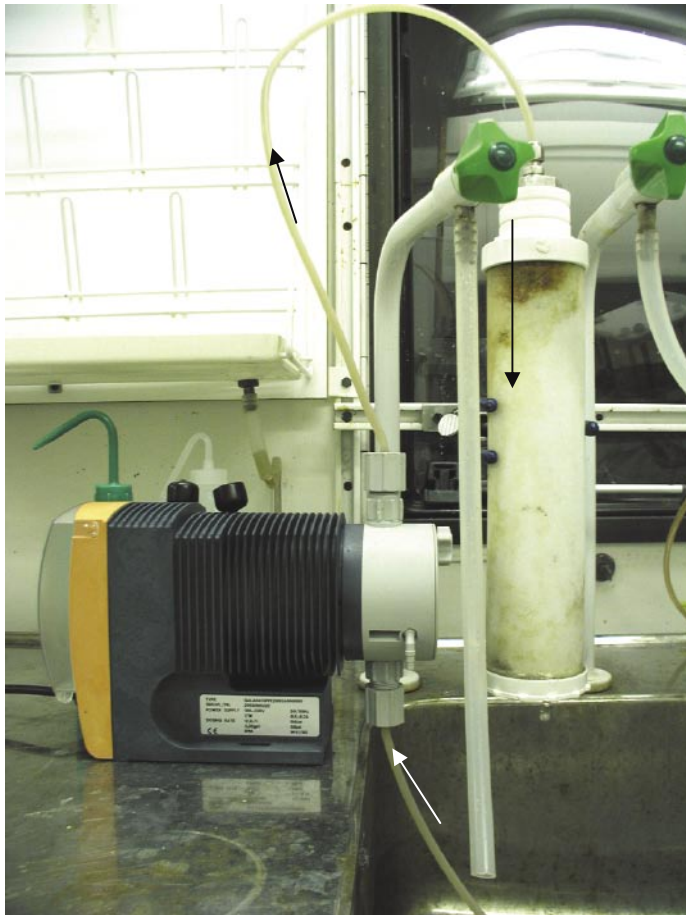

Figure 4-3. The ion exchange column. The arrows show the water flow direction.

4.2 Equipment for enrichment of humic and fulvic acids

Enrichment of humic and fulvic acids is conducted in order to collect enough material to determine $\delta^{13}\text{C}$ and pmC (percent modern carbon) on organic constituents in the groundwater. The equipment for enrichment includes a porous column filled with an anion exchanger (DEAE-cellulose) and a textile filter with a well-defined pore size. The textile filter is placed inside the column in order to prevent the ion exchange resin from diffusing through the column. The equipment and performance is described in SKB MD 431.044 (Mätsystembeskrivning för uppkoncentrering av humus- och fulvosyror). Figure 4-3 shows the equipment setup. Since the ion exchange resin in the column creates a counter-pressure, which disturbs the water flow through the surface Chemmac, a pump was used for pumping a portion of the outlet water through the column (approximately 1.8 L/hour).

4.3 Equipment for fractionation of humic and fulvic acids

The equipment consists of membrane filters with a defined cut-off (pore size), a membrane pump, flexible tubing and vessels. Generally, two sample portions from each section are filtered through filters with cut offs of 1,000 D and 5,000 D, respectively (D=Dalton, 1D=1 g/mol). The equipment and performance are described in SKB MD 431.043 (Mätssystembeskrivning för fraktionering av humus- och fulvosyror). Figure 4-4 describes schematically the function of a membrane filter and Figure 4-5 shows the equipment setup.

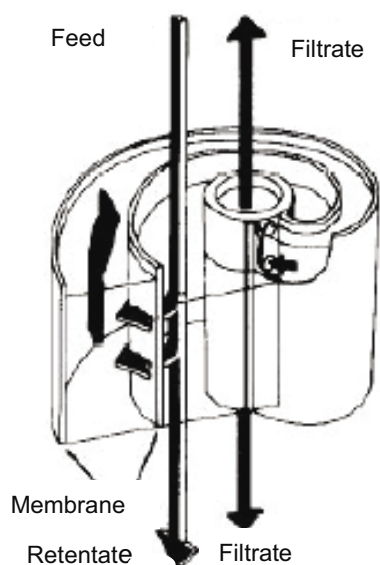

Figure 4-4. Outline of membrane filter with water flow directions.

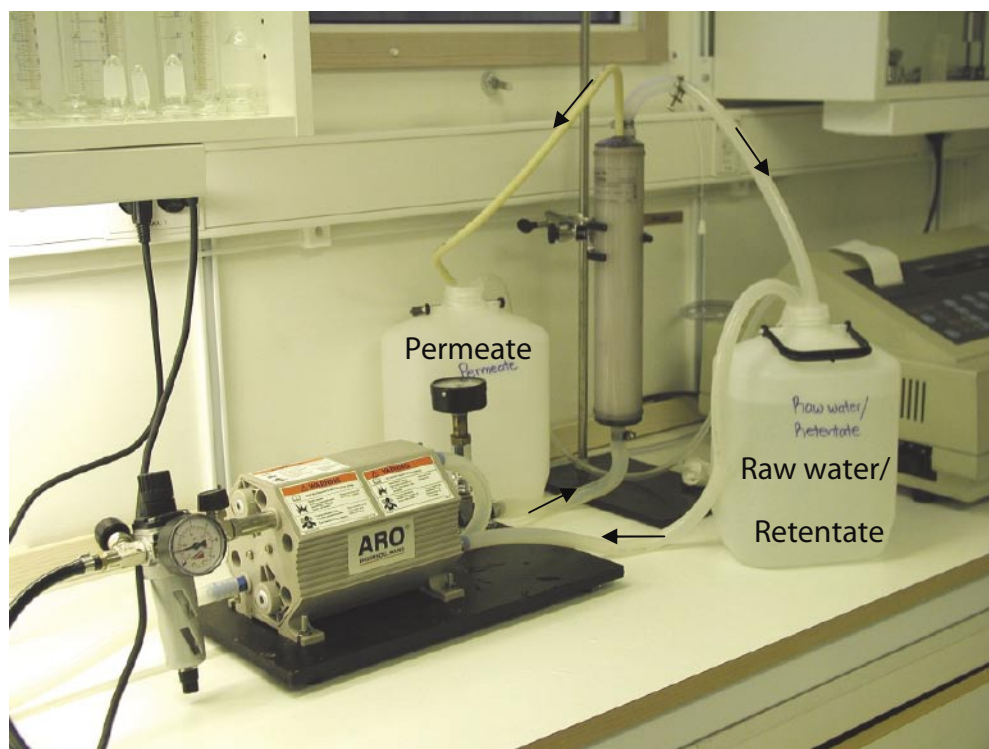

Figure 4-5. Equipment for fractionation of humic and fulvic acids.

5 Performance

5.1 General

Chemical characterisation of the section in borehole KFM08A was conducted according to activity plan AP PF 400-05-063 following the method described in SKB MD 430.017 (Metodbeskrivning för fullständig kemikaraktisering med mobilt fältlaboratorium). Initially, the investigation started in the section at 683.5–690.6 m, but due to high flushing water content (40%) the pumping was interrupted and the deep section at 912.0–1,001.2 m was tested. However, the water yield was found to be too low for chemical sampling. In order to allow chemical investigations in the borehole, further pumping was necessary. Clean-up pumping was therefore performed from the upper part of the borehole at the highest possible drawdown (about 20 m). Because of the continuing high flushing water content the pump was used a second time during 2005-08-10 to 2005-09-05. Altogether, a water volume of approx. 387 m³ was pumped from the borehole during the two clean-up campaigns, see Table 5-1. The section at 683.5–690.6 (690.8) was investigated in periods from 2005-06-02 to 2005-11-01, according to Table 5-1, with a total pumped volume of 23.1 m³.

Table 5-1. Investigation sequence in KFM08A.

Start date/Stop date	Investigation	Section	Comment
2005-06-02/2005-06-20	Interrupted investigation.	683.5–690.6	High flushing water content. Pumped volume = 3.2 m ³ . Flow rate approx. 190 mL/min.
2005-06-09/2005-06-10	Interrupted investigation.	912.0–1,001.2	The water yield was too small.
2005-06-20/2005-07-04	“Clean up” pumping.	923.5–1,001.2	Technical problems.
2005-06-20/2005-07-04	“Clean up” pumping.	Lowering of pump to approximately 95–96 m	Pumped volume ~ 200 m ³ .
2005-07-05/2005-08-10	Interrupted investigation.	683.5–690.6	High flushing water content. Pumped volume = 6,8 m ³ . Flow rate approx. 100–200 mL/min.
2005-08-10/2005-09-05	“Clean up” pumping.	Lowering of pump to approximately 95–96 m.	Pumped volume = 187 m ³ .
2005-09-05/2005-09-13	Interrupted investigation.	683.5–690.6	Loss of communication with borehole sond, S3 is exchanged to S2. Pumped volume = 1.6 m ³ . Flow rate approx, 170–190 mL/min.
2005-09-16/2005-11-01	Complete chemical characterisation.	683.5–690.6 (690.8)	The borehole pump was changed twice causing different section lengths. Pumped volume = 11,5 m ³ . Flow rate approx. 160–250 mL/min.

5.2 Overview of field work procedure

A short chronological summary of the different steps that constitute chemical characterisation of groundwater in one borehole section is given below.

The preparations conducted before the downhole equipment is lowered in the borehole include:

- Cleaning of the inside of the umbilical hose (the sample water channel) with de-ionised and de-oxygenated water. Finally, the sample water channel is filled with de-ionised and de-oxygenated water prior to lowering.
- Cleaning and preparation of the four sample containers (PVB) belonging to the in situ water sampling unit (PVP). The containers/vessels are cleaned on the outside using 70% denatured ethanol and on the inside using chlorine dioxide. One of the containers is used for microbe sampling and sterile conditions are desirable. The containers are purged with nitrogen gas and a small nitrogen gas pressure is maintained in the containers. The magnitude of the pressure depends on the depth of the section to be sampled and in this case an overpressure of 5 bars was used.
- Calibration of the pH and redox electrodes in the downhole Chemmac equipment.

The different downhole units are assembled during lowering of the equipment down the borehole and the following steps are taken:

- The outside of the umbilical hose is cleaned with 70% denatured ethanol (SKB MD 600.004).
- Calibration of the umbilical hose length is conducted at least once for each borehole. For this purpose, a length mark detector unit (caliper) is mounted together with the ordinary downhole equipment. The length mark detector indicates length calibration marks milled into the borehole wall at almost every 50 m along the borehole /3/. At each indication, a reading is made of the corresponding length mark on the umbilical hose. The correct distance to each length mark is obtained from the SICADA database.

When the pump is started and the packers are inflated at the desired positions in the borehole, a pumping and measurement period begins. Typical measures taken and activities carried out during this period are:

- Calibration of the pH and redox electrodes as well as the electrical conductivity and oxygen sensors in the surface Chemmac is conducted when the pumped water from the borehole section has reached the surface.
- Careful attention is paid in order to ensure that the packed-off section is well isolated from the rest of the borehole. A significant drawdown in the section during pumping is one indication that the section is properly sealed off. Leakage would cause pumping of water from the borehole column above and/or below the packers and not only from the fracture zone of interest. However, the drawdown in the borehole section must not be too large, because the greater the drawdown, the larger the bedrock volume affected by the pumping, and the risk of mixing with groundwater from other shallower and/or deeper fracture systems increases. The pumping flow rate is adjusted depending on the flow yield from the fracture or fracture zone (to between 50 and 200 mL/min) and maintained more or less constant during the pumping and measurement period.

- Water samples are collected regularly once or twice a week during the pumping period. Changes in water composition are monitored by conductivity measurements and by immediate analyses (pH, Uranine, chloride, alkalinity, ferrous and total iron, and ammonium) at the site.
- Enrichment of humic and fulvic acids is conducted for as long a time as possible in each section. The time needed depends on the organic carbon concentration in the water and the flow rate through the ion-exchanger. Generally, a period of at least two weeks is needed to collect the amount of carbon required to determine $\delta^{13}\text{C}$ and pmC.
- Fractionation of humic and fulvic acids, as well as inorganic species to determine the size distribution, is performed at the end of the pumping period.
- A decision when to terminate the sampling work in the section is made during a suitable stage of the pumping and measurement period. The investigation might be prolonged if the concentration of flushing water exceeds 1% or if the redox potential measurements have not reached stable values. A final SKB Class 5 sample including options is collected the day before termination.

Completion of the investigation in the section and lifting of the downhole equipment entails:

- Collection of in situ samples prior to lifting the equipment. The valves to the PVB sampling containers in the borehole section are opened from the surface in order to rinse the system and fill the containers. After some hours the valves are closed and the water sample portions for analyses of colloids, dissolved gases and microbes are secured.
- Following stopping of the borehole pump and deflation of the packers, the equipment is lifted and the different downhole units are dismantled.
- Calibration of the electrodes in the downhole Chemmac and surface Chemmac.

5.3 Performance in section 683.5–690.6 and 683.5–690.8 m

The chemical characterisation in section 683.5–690.6 (690.8) m was performed using the following configuration of the downhole equipment in the borehole. From the top: umbilical hose, length mark detector, borehole Chemmac, upper packer, borehole pump, in situ water sampler (PVP), and lower packer, see Appendix 4. The pressures above and within the section were measured by the borehole Chemmac unit and the PVP water sampling unit, respectively.

The pumping flow rate was about 160–250 mL/min and the drawdown approximately 5 m at the end of the measurement period. Diagrams showing the pressures above and within the borehole section and the flow rate during the pumping/measurement period are presented in Appendix 5. The events during the investigation are listed in Table 5-2.

Table 5-2. Events during the *complete chemical characterisation* pumping/measurement period in section 683.5–690.6 (690.8) m.

Date	Event	Sample no.
050916	Calibration of borehole Chemmac. Lowering of downhole equipment S2 (683.50–690.64 m).	
050919	Calibration of surface Chemmac. Start of Chemmac measurements.	
050920	Water sampling: SKB class 5.	8,965
050921	Humic and fulvic acids; enrichment start.	
050923	Water sampling: SKB class 4.	8,967
050926	Water sampling: SKB class 5.	8,968
050929	Water sampling: SKB class 4.	8,969
050930	Membrane in oxygen meter replaced. Repair of socket in surface Chemmac.	
051003	Water sampling: SKB class 5.	8,978
051006	Water sampling: SKB class 4.	8,985
051010	Water sampling: SKB class 5.	8,987
051013	Humic and fulvic acids; fractionation 5 kD. Water sampling: SKB class 4. No water from borehole.	8,987 8,988
051014	Raising equipment. Broken spring in borehole pump. The new borehole pump differs in length. Lowering of downhole equipment S2 (683.50–690.79 m).	
051017	Water sampling: SKB class 5.	8,989
051020	Water sampling: SKB class 4.	8,990
051026	Raising equipment. Broken spring in borehole pump. The shorter borehole pump is used again. Lowering of downhole equipment S2 (683.50–690.64 m).	
051027	Humic and fulvic acids; fractionation 5 kD. Humic and fulvic acids; fractionation 1 kD. Water sampling: SKB class 5.	12,000 12,000 8,991
051031	Water sampling: SKB class 5, all options. Humic and fulvic acids; enrichment stop. PVP-sampler: opening of valve at 16:35.	12,000
051101	PVP-sampler: closure of valve at 05:53. Sampling for colloids, microbes and dissolved gases. End of Chemmac measurements. Raising equipment. Calibration of borehole Chemmac. Humic and fulvic acids; enrichment eluation.	12,000 12,000
051102	Calibration of surface Chemmac.	

5.4 Water sampling, sample treatment and analyses

The pumped water from the borehole section is led from the hose unit into a container furnished with a sink and a tank for collecting the outlet water. Filtration of sample portions is performed on-line by connecting the filter holders directly to the water outlet. A water sample is defined as groundwater collected during one day and consists of several sample portions, labelled with the same sample number.

An overview of sample treatment and analysis methods is given in Appendix 6. The routines are applicable independently of sampling method or type of sampling object.

5.5 Collection of in situ water samples

The in situ water sampling in the borehole section was conducted successfully but was not repeated due to time constraints. For this reason the PVB-containers were too few to carry out both LIBD and colloid filtration and so the filtration was cancelled.

The PVB-containers were all quality controlled before use; this procedure includes disassembling of the container, thorough cleaning, reassembling and measurement of piston friction.

The four PVB-containers were packed together with ice packs in insulated bags and sent to the laboratories by express delivery service immediately after sampling. The purpose of each sample portion is given in Table 5-3. The microbe sample arrived at the laboratory in Gothenburg before three o'clock the same day. The gas and colloid sample portions arrived at the laboratories in Finland and Germany on the 3rd and 9th of November, respectively. Colloid determination was performed with laser-induced breakdown detection, LIBD, see Appendix 7.

Table 5-3. Collection and purpose of in situ water sample portions.

Sample portion no.	Section 683.5–690.6 m 2005-11-01
1	Microbes
2	Dissolved gas
3	Colloids (LIBD)
4	Colloids (LIBD)

5.6 Enrichment of humic and fulvic acids

Enrichment of humic and fulvic acids was conducted in order to collect enough material to determine $\delta^{13}\text{C}$ and pmC in organic constituents in the groundwater. The method is described in SKB MD 431.044 (Mätsystembeskrivning för uppkoncentrering av humus- och fulvosyror). The enrichment method entails collection of organic acids on an ion exchanger, elution of the resin and evaporation of the resulting solution. The dry residue is used for isotope determination and a minimum amount of 10 mg organic carbon is needed. In addition to organic material, the residue also contains sodium hydroxide from the elution. The sample is acidified in order to prevent the formation of carbon dioxide.

Estimations of total duration time and water volume through the ion exchanger are given in Table 5-4.

Table 5-4. Enrichment time and water volume through the ion exchanger.

Borehole section (m)	Duration of enrichment (days)	Volume through ion exchanger (L)
683.5–690.6 (690.8)	33.5	1,690

5.7 Fractionation of organic and inorganic species

Humic and fulvic acids were fractionated with respect to molecular weight using an ultra-filtration technique. The method is described in SKB MD 431.043 (Mätsystem-beskrivning för fraktionering av humus- och fulvosyror).

Sampled water from the investigated section was first filtered through a 0.40 μm filter and then through special membrane filters with cut-off sizes of 1,000 D and 5,000 D, respectively. The initial water volume, prior to filtration, was approximately 5 litres. The final retentate and permeate volumes following the filtration runs were approximately 1 and 4 litres, respectively, which gave an enrichment factor of five in the retentate.

Water samples were collected from the retentate and permeate as well as from the untreated groundwater. Each sample was analysed for dissolved organic carbon (DOC), major constituents, common trace metals and uranium. The analyses of metal ions should indicate if metals such as Al, Si, Mn, Fe and U exist as colloidal species.

6 Nonconformities

The hydrochemical characterisation in KFM08A has been conducted according to the SKB internal controlling documents AP PF 400-05-063 and SKB MD 430.017 with the following deviations and remarks:

- The investigations in the borehole section were delayed and prolonged, compared to the initial plan, due to high flushing water content, equipment failures and difficulties to obtain stable and agreeing Eh-readings. The equipment malfunctions are listed in Table 5-1.
- The allowed upper limit for flushing water content, 1%, was exceeded.
- Fractionation of humic and fulvic acids was repeated due to equipment malfunctions (broken borehole pump).
- The repeated in situ sampling (four extra sample containers (PVB)) was cancelled due to time constraints and therefore the colloid filtration was also cancelled.
- The investigation of section 912.0–1,001.2 m was interrupted/cancelled because of too low water yield.

7 Data handling and interpretation

7.1 Chemmac measurement data

The processing of Chemmac data is described in SKB MD 434.007-02 (Mätsystem-beskrivning för Chemmac mätsystem, SKB internal controlling document, in progress).

7.1.1 Data file types and calculation software

The on-line measurements in a borehole section produce the following types of raw data files:

- Calibration files from calibration measurements (*.CRB) and corresponding comment files (*.CI). The files are used for calculation of calibration constants (pH and Eh) and the calibration factor (electrical conductivity). For surface Chemmac ten *.CRB and ten *.CI files are produced, and for borehole Chemmac six *.CRB and six *.CI files.
- Raw data file containing the logged measurements from the borehole section and the surface (*K.MRB) as well as a corresponding comment file (*.MI). The logged voltage values need to be converted to pH and Eh values (also in mV) using the calibration constants obtained from calibration.
- Measurement file including equipment and environment parameters (*O.MRB), such as power consumption in the downhole Chemmac unit and temperature inside the hose unit.

The original raw data files listed above are stored in the SICADA file archive. Furthermore, the files are re-calculated and evaluated to obtain pH and redox potential values and to correct the electrical conductivity values using the specially designed calculation software (Hilda). The resulting files containing calculated and evaluated values as well as comments on the performance are:

- A file **constants.mio* containing all the calculated calibration constants (one constant for each electrode in each buffer solution). The file is stored in the SICADA file archive and is useful in order to follow the development of single electrodes.
- A file **measurements.mio* containing the calculated and evaluated measurement values (pH, redox potential, electrical conductivity and water temperature). The data from the file are exported to the data tables “redox” and “ph_cond” in SICADA. As the file also contains some measured parameters that are not included in the tables mentioned above (e.g. pressure registrations), the complete file is also stored in the SICADA file archive.
- A file **comments.mio* containing comments on the fieldwork and the calculation/evaluation. The comments in the file are imported as activity comments in SICADA.

7.1.2 Calculations and evaluation of redox potential and pH

The redox potential is measured by three electrodes at the surface and three in the borehole section. In addition, pH is measured by two electrodes at the surface and two downhole in the borehole section. The registrations by the redox and the pH electrodes are logged each hour during a measurement period of approximately three weeks and a calibration is performed before and after the measurement period. The treatment of the raw data includes the following steps:

- Calculation and choice of calibration constants.
- Calculation of one pH and one redox potential sequence for each electrode (i.e. three or six redox electrodes and two or four pH electrodes).
- Determination of representative pH and redox potential values as well as estimated measurement uncertainties for the investigated borehole section.

One calibration constant is selected for each electrode using one of the following alternatives:

- Case 1: Calculation of the average calibration constant value and the standard deviation. The initial and the final calibration measurements result in four constants for each redox electrode (in pH 4 and pH 7 buffer solutions) and six constants for each pH electrode (in pH 4, 7 and 10 buffer solutions).
- Case 2: The calibration constant obtained from the initial calibration measurement at pH 7 is selected since it is closest to the pH of the borehole water. This alternative is chosen if the calibration constants obtained in the different buffers show a large variation in value (generally a difference larger than 20 mV between the highest and the lowest value). The standard deviation is calculated in the same way as in Case 1.
- Case 3: If the final calibration constants turn out to be very different (more than 20 mV) from the initial constants, a linear drift correction is needed. The reason for this is most often a drift in the reference electrode. The values and standard deviations are calculated for the initial and the final calibration constants separately and a linear correction is made between the selected initial and the selected final constant. The higher of the two standard deviation values is used in the estimation of the total measurement uncertainty.

The values in the measurement raw data file are converted to pH and Eh measurement sequences for each pH and redox electrode using the calibration constant selected as stated above.

The next step is to choose a logging occasion in a stable part of the measurement period and select a representative result for each electrode. The average values are calculated for each electrode group in order to obtain one representative value of redox potential, pH (borehole Chemmac) and pH (surface Chemmac), respectively. Obviously erroneous electrodes are omitted. The corresponding total measurement uncertainties are estimated using the standard deviations of the calibration constants and the standard deviations of the Eh and the pH values obtained by the different sets of electrodes. It is useful to evaluate pH at the surface and pH in the borehole section separately, since pH in the pumped water might differ from the pH measured in the borehole section. This is due to changing gas pressure conditions and their effects on the carbonate system.

Factors considered when evaluating the measurement uncertainties in pH and redox potential (Eh) values are:

- Difference in calibration constants for each electrode and calibration/buffer solution.
- Drift in calibration constants between the initial and the final calibration.
- Stability in voltage value during the final part of the on-line measurement. A successful measurement shows no tendency of a slope.
- Agreement between the different pH and redox electrodes on the surface and in the downhole Chemmac.
- Number of electrodes showing reasonable agreement. Obviously erroneous electrodes are excluded from the calculation.

7.2 Water analysis data

The following routines for quality control and data management are generally applied for hydrogeochemical analysis data, independently of sampling method or sampling object.

Several components are determined by more than one method and/or laboratory. Moreover, duplicate analyses by an independent laboratory are performed as a standard procedure on each fifth or tenth collected sample. All analytical results are stored in the SICADA database. The applied hierarchy path “Hydrochemistry/Hydrochemical investigation/Analyses/Water in the database” contains two types of tables, raw data tables and primary data tables (final data tables).

Data on **basic water analyses** are inserted into the raw data tables for further evaluation. The evaluation results in a final reduced data set for each sample which are compiled in a primary data table named “water composition”. The evaluation is based on:

- Comparison of the results from different laboratories and/or methods. The analyses are repeated if a large disparity is noted (generally more than 10%).
- Calculation of charge balance errors according to the equation below. Relative errors within $\pm 5\%$ are considered acceptable (in surface waters $\pm 10\%$).

$$\text{Relative error (\%)} = 100 \times \frac{\sum \text{cations (equivalents)} - \sum \text{anions (equivalents)}}{\sum \text{cations (equivalents)} + \sum \text{anions (equivalents)}}$$

- General expert judgement of plausibility based on earlier results and experience.

All results from **special analyses of trace metals and isotopes** are inserted directly into primary data tables. In those cases where the analyses are repeated or performed by more than one laboratory, a “best choice” notation will indicate those results which are considered most reliable.

An overview of the data management is given in Figure 7-1.

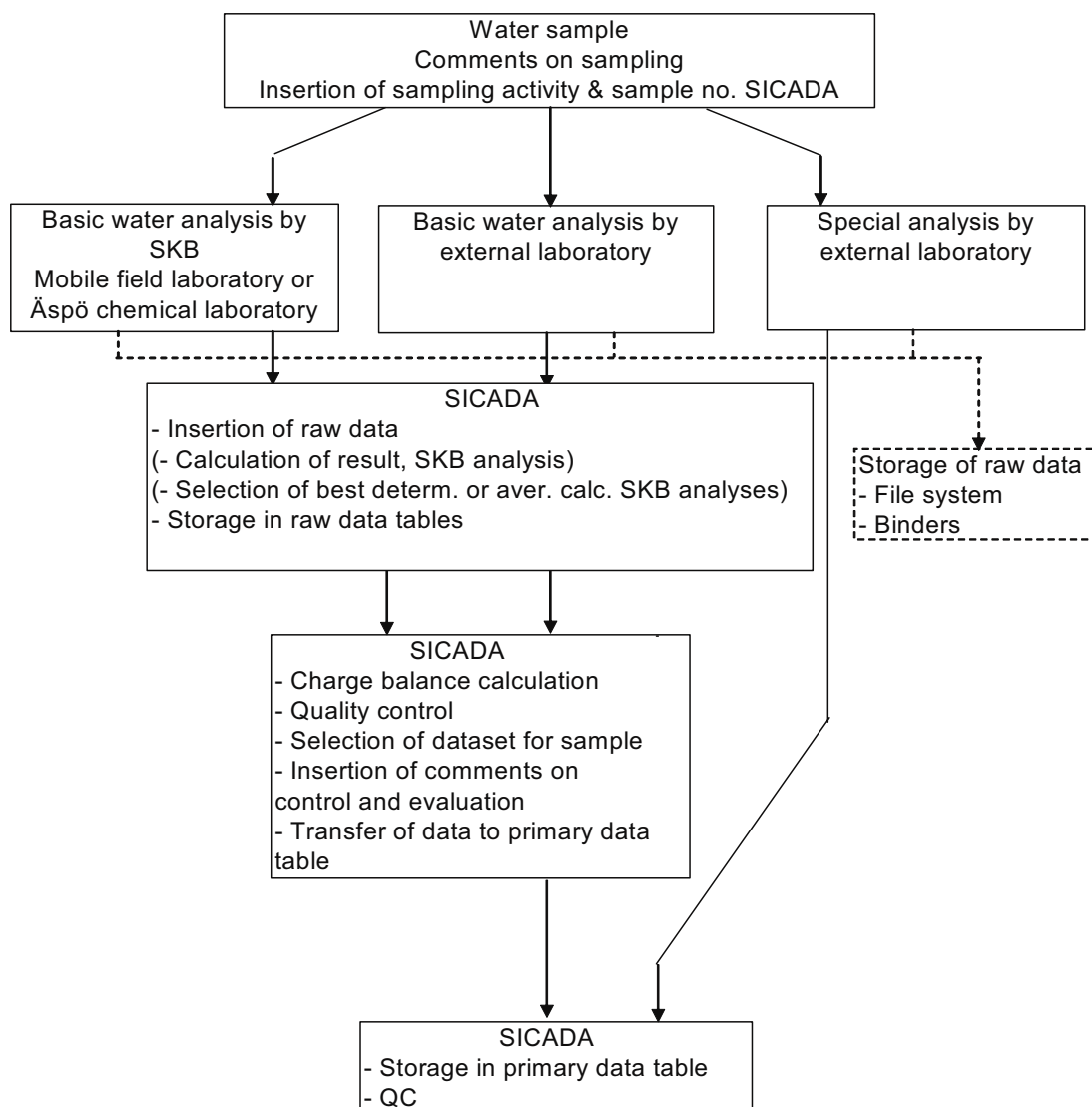

Figure 7-1. Overview of data management for hydrogeochemical data.

7.3 Data from special sampling methods

Special sampling methods include collection of in situ samples (dissolved gases and colloids) and enrichment and fractionation of humic and fulvic acids.

Separate activities, methods and sample numbers are defined in SICADA for data on dissolved gases, colloids, fractions of humic and fulvic acids as well as $\delta^{13}\text{C}$ and pmC determined on organic constituents. All data are subjected to quality control.

7.3.1 Dissolved gases

Results from gas analyses are stored in a primary data table in SICADA without post processing or interpretations.

7.3.2 Enrichment of humic and fulvic acids

The pmC and $\delta^{13}\text{C}$ values for enriched organic acids are stored in a primary data table in SICADA without post processing or interpretations.

7.3.3 Fractionation of organic and inorganic species

The concentrations of organic and inorganic constituents in the retentate and permeate are recalculated to concentrations of each fraction of carbon and metal ions with molecular weight lower or higher than the cut-off size of the filter. This is done using mass balance equations as described in SKB MD 431.043 (Mätssystembeskrivning för fraktionering av humus- och fulvosyror). Comparison of the four concentration values from the two filters results in values for three fractions, i.e. < 1,000 D, 1,000–5,000 D and > 5,000 D which are stored in a primary data table in SICADA.

8 Results

8.1 Chemmac measurements

The data sequences of pH, Eh, electrical conductivity, oxygen and temperature values from the Chemmac measurements in section 683.5–690.6 (690.8) m are plotted versus time in Appendix 8.

The carbon electrode in the borehole Chemmac was the only redox electrode that showed stable values at the end at the measurement period, but only for a short time (~ 24 hours). The Eh value is therefore highly uncertain. The carbon electrode in the surface Chemmac was erroneous and these measurements were therefore rejected.

The two pH-electrodes at the ground surface agreed completely at the end of the measurement period but varied in a regular way (day/night). This variation is caused by temperature variations in the hose unit. Also the two borehole pH-electrodes agreed nicely. The relatively high content of oxygen may be caused by intrusion of air or erroneous calibration.

The measured time series of data were evaluated in order to obtain one representative value of Eh, pH, electrical conductivity and dissolved oxygen for the borehole section as described in Section 7.1. Data were selected from the last part of the measured time series sequences (where the electrodes show stable values), marked with an arrow in the diagrams in Appendix 8. The evaluated results from the measurements in the investigated section are given in Table 8-1 together with the corresponding results from the LIBD container.

Table 8-1. Evaluated results from the Chemmac measurement in KFM08A.

Borehole section (m)	EC* (mS/m)	pH (surface Chemmac)**	pH (borehole Chemmac)**	Eh (carbon electrode in borehole Chemmac)** (mV)	Dissolved oxygen*** (mg/L)
683.50–690.79	1,720 ± 50	8.0 ± 0.2	8.0 ± 0.2	(–209 ± 15)	0.05 ± 0.01
PVB (LIBD)****	1,580	8.27–8.45	–	–26	< 0.13

*The electrical conductivity is measured between 0–10,000 mS/m with a measurement uncertainty of 3%.

** Evaluated result and measurement uncertainty calculated as described in section 7.1.

*** Measuring interval 0–15 mg/L, resolution 0.01 mg/L.

**** See Appendix 7.

8.2 Water analyses

8.2.1 Basic water analyses

The basic water analyses include the major constituents Na, K, Ca, Mg, S, Sr, SO₄²⁻, Cl⁻, Si and HCO₃⁻ as well as the minor constituents Fe, Li, Mn, DOC, Br, F, I, HS⁻ and NH₄⁺. Furthermore, batch measurements of pH (lab-pH) and electrical conductivity (lab-EC) are included. Another important parameter is the flushing water content in each sample. The basic water analysis data and relative charge balance errors are compiled in Appendix 9, Table A9-1. Existing lab-pH and lab-Eh values are compared to the corresponding on-line Chemmac measurement values in Appendix 8.

The charge balance errors give an indication of the quality and uncertainty of the analyses of major constituents. The errors do not exceed ± 5 % in any case. Furthermore, the last sample in each section was also analysed by a second laboratory. A comparison between results from different laboratories and methods shows that the agreement is acceptable in most cases. Generally, the difference in concentrations between laboratories/methods for each analysed constituent is less than 10%.

The flushing water contents in the sample series collected from the borehole sections and from the “clean-up” pumping are presented in Figure 8-1. The flushing water content should not exceed 1% in order for a sample to be considered representative for the groundwater of the sampled fracture zone. This condition was not achieved for any of the samples. The flushing water contents are calculated using the nominal Uranine concentration (0.20 mg/L) in the flushing water.

The concentration levels of chloride, calcium and sodium are presented in Figure 8-2. The concentrations of all major constituents remained practically constant during the entire pumping and sampling period.

The iron concentrations determined by ICP-AES (total Fe) and by spectrophotometry (Fe(+II) and Fe-tot) are compared in Figure 8-3. The total iron concentrations determined by ICP agree reasonably well with the results obtained by spectrophotometry. The iron concentrations show an increasing trend throughout the sampling period. This may be an artefact from the drilling (material from wear of drilling equipment) or contamination from iron hydroxide deposits in the water channel of the umbilical hose. However, the last suggestion is expected to cause an opposite trend with a high initial concentration.

Sulphate analysed by ion chromatography (IC) is compared to sulphate determined as total sulphur by ICP-AES in Figure 8-4. As shown, within the analytical error all sulphur is present as sulphate. The results from the ICP measurements are considered more reliable, by experience, since the variation in a time series often is smaller. The sulphate concentration remains constant during the sampling period.

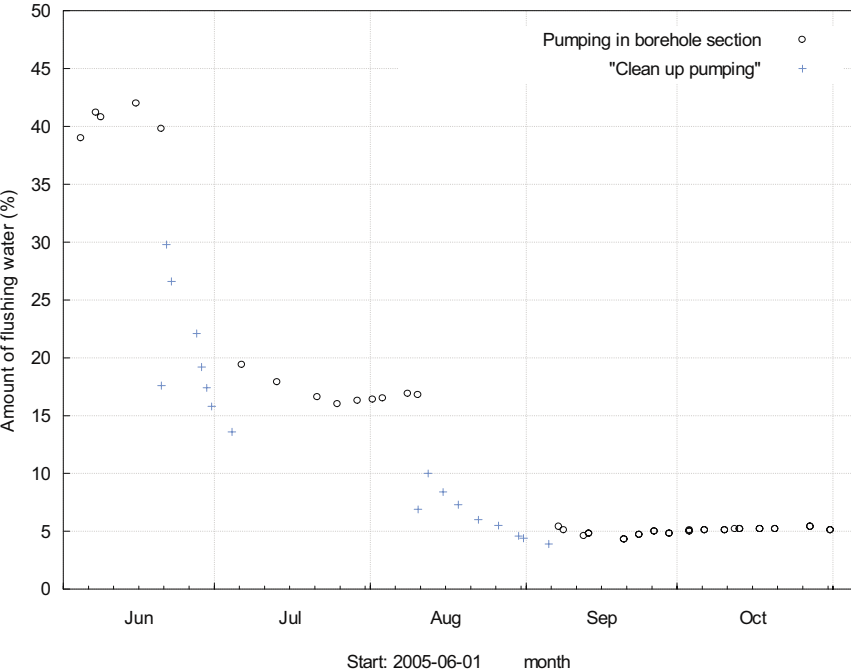

Figure 8-1. Flushing water content in samples from “clean-up pumping” and in the sample series collected during pumping in borehole section 683.5–690.6 (690.8) m.

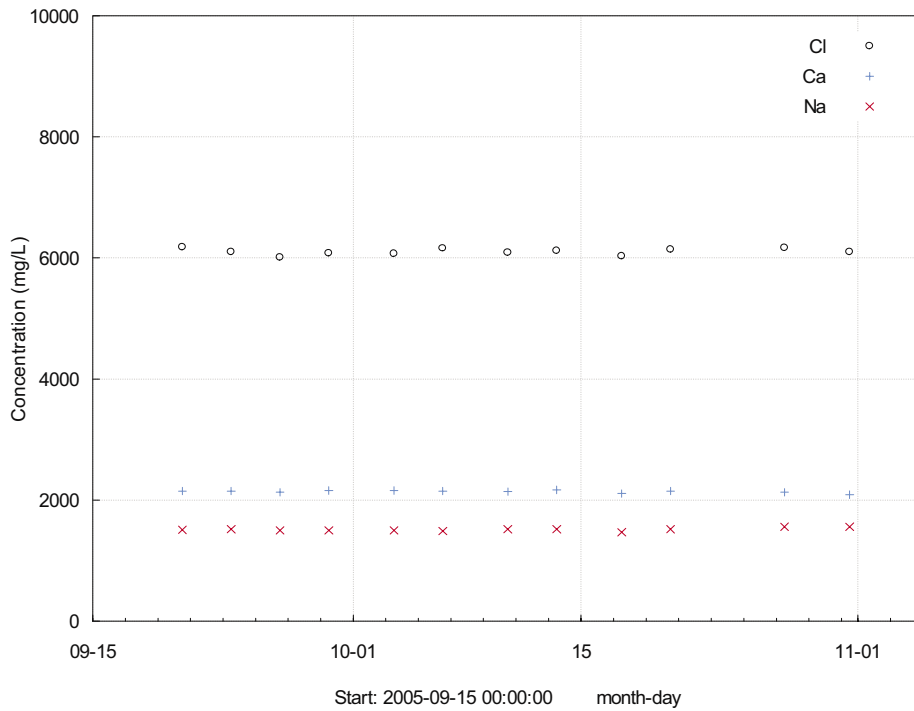

Figure 8-2. Chloride, calcium and sodium concentration from sample series at 683.5–690.6 (690.8) m

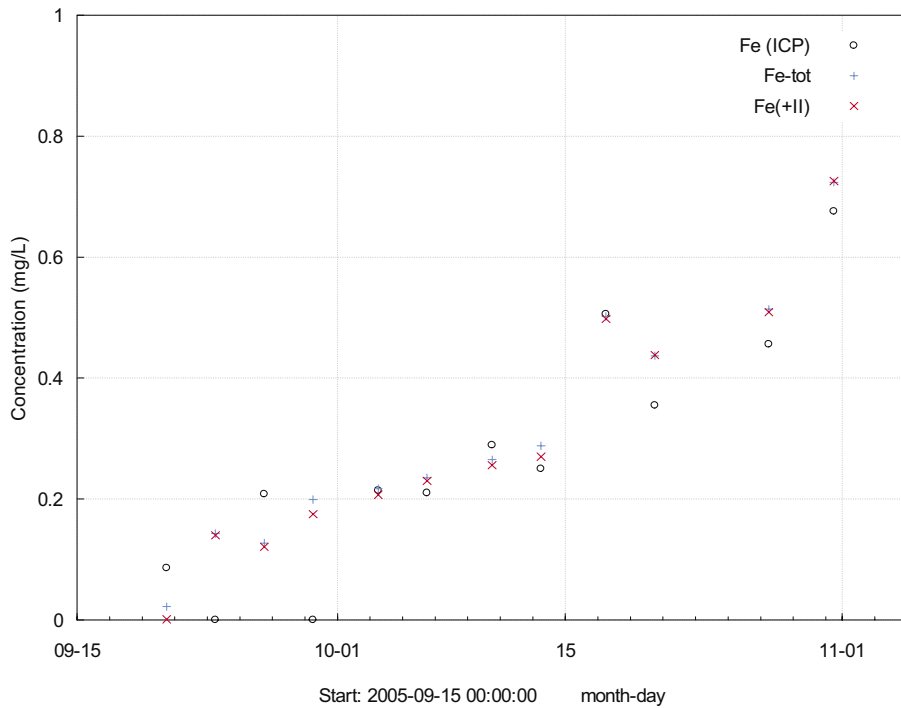

Figure 8-3. Comparison of iron concentrations obtained by ICP-AES and by spectrophotometry, borehole section 683.5–690.6 (690.8) m. Values below the detection limit are plotted as zero.

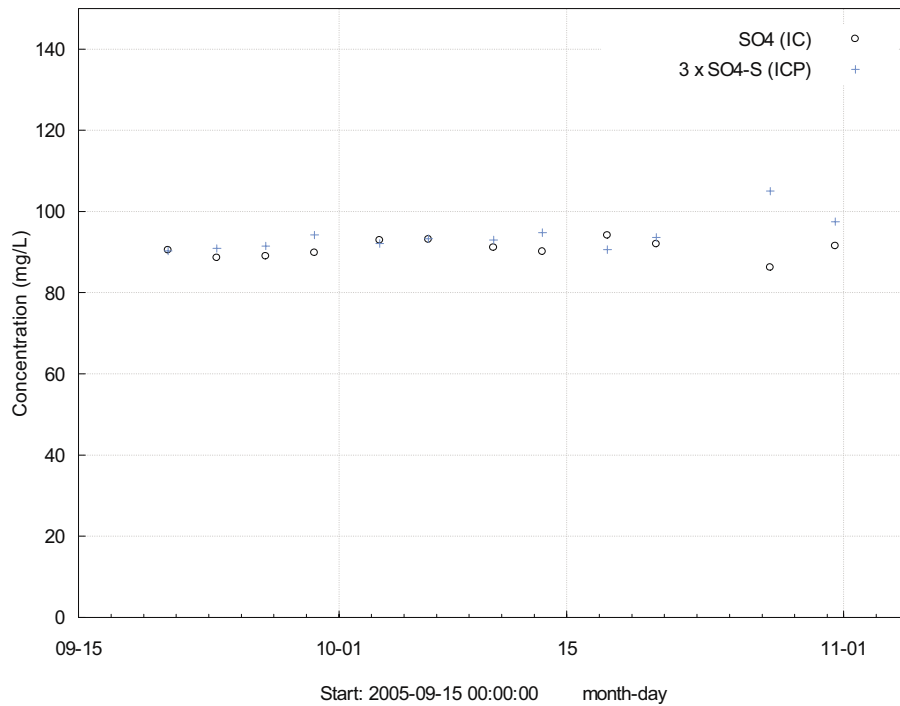

Figure 8-4. Sulphate (SO_4 by IC) to total sulphate calculated from total sulphur ($3 \times SO_4-S$ by ICP) versus date, borehole section 683.5–690.6 (690.8) m.

The chloride concentrations are plotted versus the corresponding electrical conductivity values in Figure 8-5. The plot gives a rough check of the data. As shown, the data from the borehole sections agree well with a thought regression line obtained by earlier data from the Äspö Hard Rock Laboratory.

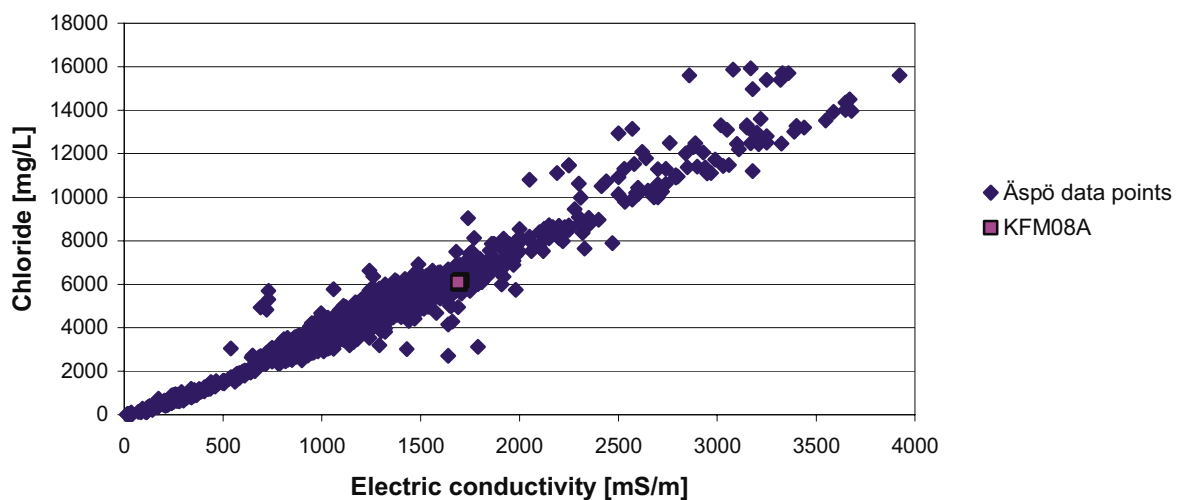

Figure 8-5. Chloride concentration versus electrical conductivity. Data from earlier investigations at the Äspö Hard Rock Laboratory are used to show the linear trend. Data from KFM08A do not deviate from a thought regression line.

8.2.2 Trace elements (rare earth metals and others)

The analyses of trace and rare earth metals include Al, B, Ba, U, Th, Sc, Rb, Y, Zr, In, Sb, Cs, La, Hf, Tl, Ce, Pr, Nd, Sm, Eu, Gd, Tb, Dy, Ho, Er, Tm, Yb and Lu. Commonly occurring metals, such as Cu, Zn, Pb and Mo, are not included in the analysis programme due to contamination considerations. The risk of contamination is large also for aluminium but the aluminium concentration is still reported due to its importance for the modelling work. The trace element data are compiled in Appendix 9, Table A9-3.

8.2.3 Stable and radioactive isotopes

The isotope determinations include the stable isotopes δD , $\delta^{18}O$, $^{10}B/^{11}B$, $\delta^{34}S$, $\delta^{13}C$, ^{37}Cl and $^{87}Sr/^{86}Sr$ as well as the radioactive isotopes Tr (TU), ^{14}C (pmC), ^{238}U , ^{235}U , ^{234}U , ^{232}Th , ^{230}Th , ^{226}Ra and ^{222}Rn . Available isotope data at the time of reporting are compiled in Appendix 9, Table A9-2 and Table A9-4.

The tritium and $\delta^{18}O$ results for section 683.5–690.6(690.8) are presented in Figure 8-6. The Tritium content was below the detection limit (0.8 Tritium Units) in all samples except for two. The sample series showed more or less constant $\delta^{18}O$ values.

The carbon isotopes ($\delta^{13}C$ and pmC) were determined both in inorganic carbon (hydrogen carbonate) and in organic constituents. Enrichment of organic carbon was conducted in order to collect enough organic material. Available isotope data at the time of reporting are compiled in Appendix 9.

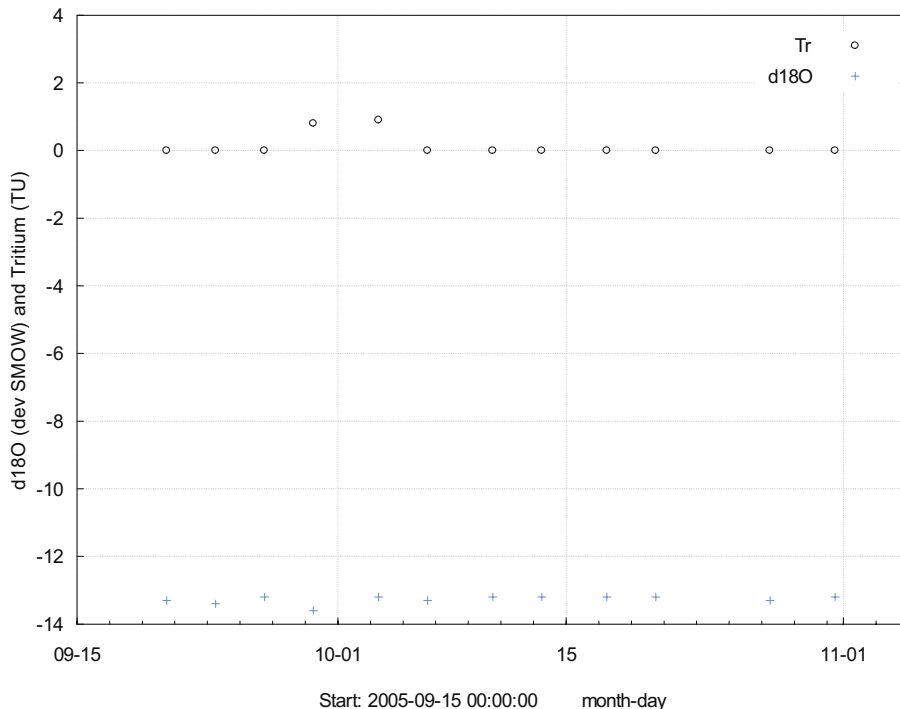

Figure 8-6. Tritium and $\delta^{18}O$ (‰ SMOW) data versus sampling date, section 683.5–690.6(690.8).

8.3 Dissolved gas

The analyses of dissolved gases include argon (Ar), helium (He), nitrogen (N₂), carbon dioxide (CO₂), methane (CH₄), oxygen (O₂), hydrogen (H₂), carbon monoxide (CO), ethane (C₂H₆), ethene (C₂H₄), ethyne (C₂H₂), propane (C₃H₈) and propene (C₃H₆). The gas data are compiled in Appendix 9, Table A9-5.

Total gas content in the groundwater as well as the detected oxygen content is given in Table 8-2. The oxygen content indicates air leakage into the purging system at the consulted laboratory. The results for oxygen, nitrogen and argon may be corrected by removing the air effect, assuming that the oxygen content in the ground water is zero.

The gas composition of the groundwater is presented in Figures 8-7 and 8-8.

8.4 Colloids

The presence of colloids was investigated by two methods, 1) fractionation/ultra filtration using two cylindrical filters with a cut-off of 1,000 D and 5,000 D as well as 2) Laser-Induced Breakdown Detection, LIBD, Appendix 7.

An overview of colloid concentrations in groundwater samples from boreholes KFM06A, KFM07A and KFM08A is presented in Table 8-3. The table includes results from all filtration experiments with a filtrate volume exceeding 300 mL and also the two LIBD tests conducted so far. The results from the filtration runs are corrected by considering the remaining water volume in each filter (indicated by the sodium content) and excluding its corresponding amounts of the different dissolved elements. Furthermore, the analysed elements are recalculated to the amounts of probable mineral phases (illite, calcite, iron hydroxide and manganese hydroxide).

The table illustrates the difficulties associated with colloid determinations. Generally, it is expected that the measured colloid concentrations turn out higher than the natural amount of background colloids in the groundwater as additional colloids are easily generated by artefacts. The sources may be:

- Oxygen intrusion and formation of iron hydroxide.
- Decrease of pressure and precipitation of calcite.
- Sampling process or equipment.

The filtration results seem to be more affected by calcite precipitation than the LIBD measurements. The calcite phase is excluded from the calculated total colloid concentration (sum column in Table 8-3) obtained by the filtration method but, if present, it is included in the LIBD results.

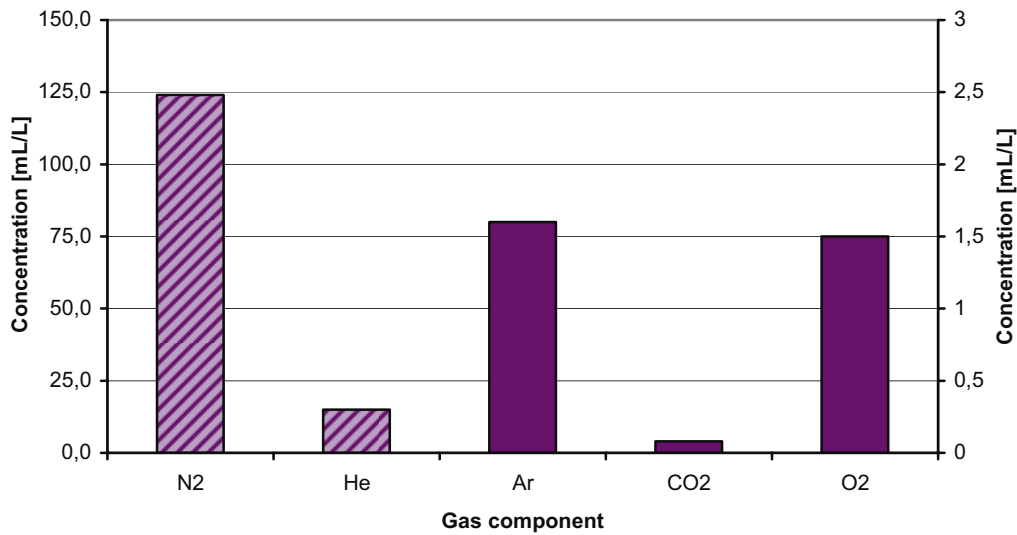

Figure 8-7. Gas components of high concentrations (N_2 , He, Ar, CO_2 , and O_2) in the sample collected in section 683.5–690.6 m using the in situ sampling equipment. Diagonally and infilled rastered columns refer to left and right axis, respectively.

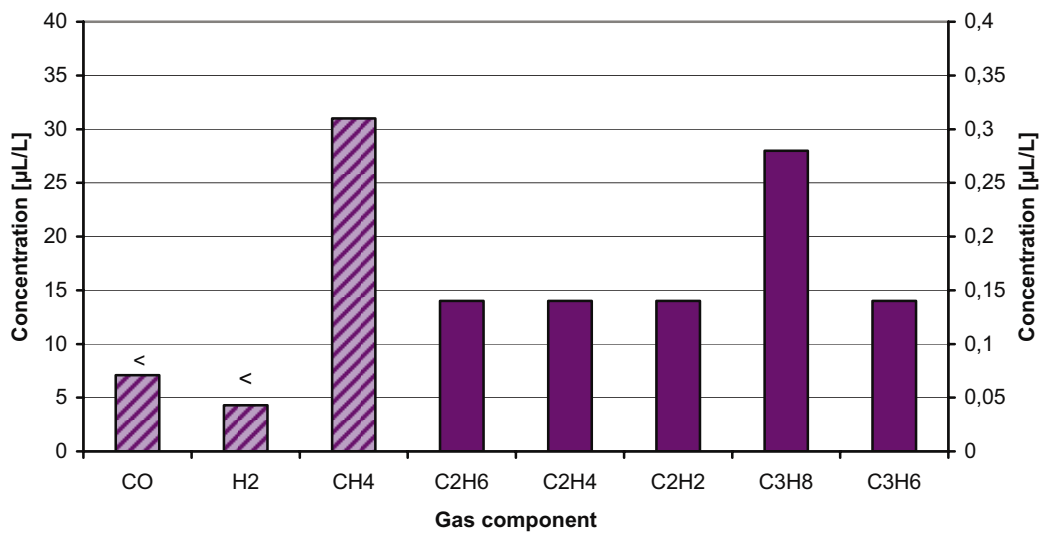

Figure 8-8. Gas components of low concentrations (CO , H_2 , CH_4 , C_2H_6 , C_2H_4 , C_2H_2 , C_3H_8 and C_3H_6), in the sample collected in section 683.5–690.6 m using the in situ sampling equipment. Diagonally and infilled rastered columns refer to left and right axis, respectively.

Table 8-2. Total content of dissolved gas.

Section 683.5–690.6 m	
Total gas content [mL/L]	142
Oxygen content [mL/L]	1.5

Table 8-3. Compilation of colloid concentrations measured in groundwater samples from boreholes KFM06A–KFM08A. Comparison of results obtained by filtration and the LIBD technique.

Filtration through series of connected filters									LIBD	
Idcode/ secup/ filter pore size (µm)	Filtrate volume (mL)	Element content on each filter per litre of water (µg/L)				Mineral phases (µg/L)			Idcode/ secup/ run no.	Content (µg/L)
		Al	Ca	Fe	Mn	Total/ filter*	Calcite/ filter	Sum**/ three filters		
KFM06A/ 354/0.2	308.5	0.178	0.0	2.188	0	5.28	0.0		KFM06A/ 354/1	1.1
KFM06A/ 354/0.05	308.5	0.522	0.0	1.448	0	5.99	0.0			
KFM06A/ 354/0.05	308.5	0.284	29.4	0.511	0.026	76.1	73.3	14.0	KFM06A/ 354/2	1.3
KFM06A/ 768/0.2	321.5	0.237	222.4	0.648	0	557.0	555.0			
KFM06A/ 768/0.05	321.5	0.284	25.7	0.580	0	66.9	64.0			
KFM06A/ 768/0.05	321.5	0.198	17.9	0.456	0	46.7	44.6	7.66		
KFM07A/ 848/0.2	336.5	0.266	0.0	1.302	0	4.13	0.0			
KFM06A/ 848/0.05	336.5	0.466	47.3	0.982	0	123.0	118.0			
KFM06A/ 848/0.05	336.5	0.686	32.0	0.921	0	85.7	79.7	14.9		
									KFM08A/ 683.5/1	17.5
									KFM08A/ 683.5/2	16.8
									KFM08A/ 683.5/3	5.9
									KFM08A/ 683.5/4	6.8

* Total content on each filter. Aluminium is calculated as 2.3 Al in K-Mg-illite (383.9 g/mol), calcium is calculated as CaCO₃ (100.0 g/mol), iron is calculated as Fe(OH)₃ (106.8 g/mol) and manganese is calculated as Mn(OH)₂ (88.9 g/mol). The sulphur and silicon contents on the filters were below detection limit and the uranium content was also below or close to the detection limit.

** Sum of content (mineral phases) on the three filters. Calcite is excluded.

8.4.1 Inorganic colloids – fractionation

Fractionations were performed at two separate sampling occasions, 2005-10-13 (5,000 D filter) and 2005-10-27 (1,000 D and 5,000 D filters). The samples from the fractionation experiment were analysed by ICP and the determined elements were; Ca, Fe, K, Mg, Na, S, Si, Al, Ba, Cd, Co, Cr, Cu, Hg, Li, Mn, Mo, Ni, P, Pb, Sr, V, Zn and U. Only iron, silicon, aluminium, calcium, sulphur, manganese and uranium were considered important as colloid species. The fractionation results, see Table 8-4, indicate that Si, Ca, S and Mn exist solely as species with a molecular weight less than 1,000 g/mol. Such species are too small to be referred to as colloids. No calcite precipitation was detected.

The result for iron is uncertain since some precipitation might have occurred during or just after the filtrations. The fraction with the molecular weight corresponding to > 5,000 D may be a colloid phase present in the groundwater but it is also possible that it is caused by intrusion of oxygen in the filtering system (pump, filter, hose etc). Uranium, on the other hand, is more soluble at oxidising conditions and the presence of a fraction larger than

5,000 D is likely. The uranium concentrations compared are, however, small and analytical errors may lead to the wrong conclusions. Furthermore, the increasing trend in iron concentration during the investigation period (0.2 and 0.5 mg/L at 2005-10-13 and 2005-10-27 respectively) causes discrepancies.

The aluminium analyses showed inconsistent results due to contamination and/or analytical errors. For example, additional aluminium was present in the system, 2005-10-27 (5,000 D) and the aluminium concentration in the de-ionised water was at detectable level (6.48 µg/L). Furthermore, the concentration in untreated groundwater varied at the different fractionation runs. Therefore, it is not possible to draw any conclusions regarding fractions of aluminium.

The blanks (de-ionised water after passing through the washed filters) showed insignificant concentrations of iron, silicon, calcium, sulphur, manganese and uranium.

Table 8-4. Inorganic fractions (< 1,000 D, 1,000 D to 5,000 D and > 5,000 D) in section 683.5–690.6 (690.8)m.

Fraction	Fe (mg/L)	Si (mg/L)	Ca (mg/L)	S (mg/L)	Mn (µg/L)	U (µg/L)
< 1,000 D (2)	0.06 ± 0.01	4.6 ± 0.7	1,970 ± 240	29 ± 3	240 ± 40	7.8 ± 0.8
< 5,000 D (1)	0.08 ± 0.01	4.9 ± 0.7	1,940 ± 230	30 ± 4	180 ± 30	4.5 ± 0.8
< 5,000 D (2)	0.42 ± 0.06	4.7 ± 0.7	1,970 ± 240	29 ± 4	230 ± 30	6.9 ± 1.0
> 1,000 D but < 5,000 D (2)	0.03 ± 0.02	–	–	–	–	–
> 5,000 D (1)	0.02 ± 0.01	< 0.3	< 120	< 2	< 12	0.9 ± 0.4
> 5,000 D (2)	0.06 ± 0.03	< 0.3	< 110	< 2	< 24	1.0 ± 0.5
Adsorption 1,000 D (2)	0.24 ± 0.06	–	–	–	–	–
Adsorption 5,000 D (1)	0.08 ± 0.03	–	–	–	–	2.6 ± 1.6
Adsorption 5,000 D (2)	–	–	–	–	–	2.4 ± 1.9

– = Not found

(1) = performed 2005-10-13, (2) = performed 2005-10-27

8.4.2 Humic and fulvic acids – fractionation

The results from fractionation of organic acids in section 683.5–690.6 (690.8) m are summarised in Table 8-5. The water in the section contains mainly organic acids with a molecular weight less than 1,000 D. This means that the organic constituents are present as low molecular weight fulvic acids and possibly other low molecular weight organic acids such as citric acid and oxalic acid. The results from the 1,000 D and 5,000 D filters 2005-10-27 were consistent. The concentration of organic acids in untreated groundwater 2005-10-27 was 2.7 ± 0.3 mg/L, and 2005-10-13 it was below the detection limit.

Table 8-5. Summary of fractionation results.

Fraction	DOC (mg/L)
< 1,000 D	2.6 ± 0.3
> 1,000 D but < 5,000 D	0.3 ± 0.1
> 5,000 D	< 0.3
Adsorption 1,000 D	–
Adsorption 5,000 D	–

– = Not found.

9 Summary and discussion

The investigation period in the only section sampled in borehole KFM08A was unusually long with several interruptions. This was due to high content of remaining flushing water (initially ~ 40 %), some equipment malfunctions and difficulties to reach stable and agreeing redox potential measurements. The data obtained are important as they add more information on groundwaters in the depth range where there commences a gradual change from mainly Littorina type to a mixture of glacial water and deeper saline groundwaters. Figure 9-1 shows chloride concentration versus depth for the single data point from KFM08A together with corresponding data from other boreholes at Forsmark.

The main conclusions from the experimental results are:

- The six redox electrodes disagree considerably and only the downhole carbon electrode reached a plausible and somewhat stable Eh value. Therefore the reported Eh (-210 mV) for this groundwater should be considered uncertain.
- Even if an unusually large portion of the flushing water was recovered in the returned water during drilling, the flushing water was still a problem. An upper limit for the allowed flushing water content in a representative water sample is set to 1%. This content was exceeded and the lowest flushing water content, reached in the end of the measurement period, was 5%.

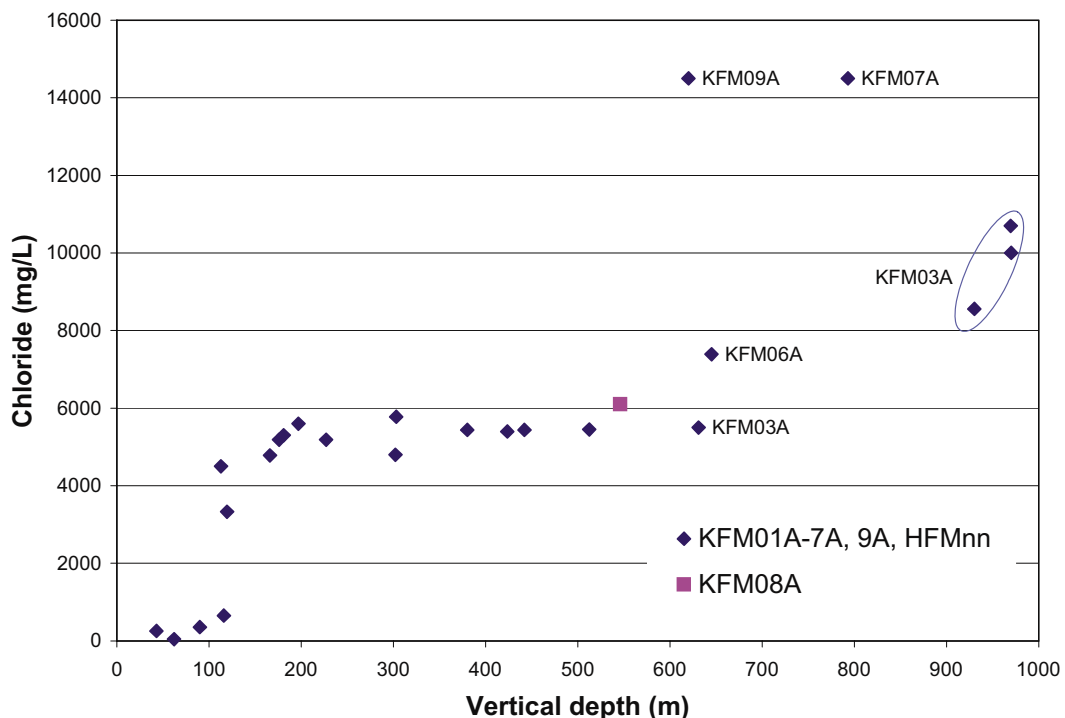

Figure 9-1. Chloride concentrations versus depth (m) at the Forsmark site. The data point from KFM08A is plotted in pink colour. The diagram presents also those available data that will be included in subsequent reports.

- The quality of the water analyses is generally high, based on comparison between results from different laboratories and methods and acceptable charge balance errors. The relative errors are all within $\pm 5\%$.
- The major constituents show stable concentrations during the pumping/sampling period which indicates that no mixing occurred with water from other fracture systems with different water compositions.
- The iron, aluminium and DOC concentrations, on the other hand, are difficult to interpret. Iron shows an increasing trend with time and the values vary between 0.08 and 0.7 mg/L. A possible explanation is contamination from iron hydroxide deposits in the water channel of the umbilical hose or a drilling artefact. The high aluminium concentrations especially in the two first samples certainly originate from contamination but the source is unknown. It is also possible that the three DOC values above the detection limit are due to contamination. One possible source is flushing water.
- The uranium concentration in the groundwater from KFM08A at 683.5–690.6 (690.8) m is relatively high (5–10 $\mu\text{g/L}$). This is still far from the concentrations reached in some of the previous borehole sections at intermediate depths in boreholes KFM02A and KFM03A (up to 90 $\mu\text{g/L}$).
- The LIBD results suggest a colloid concentration of approximately 6–7 $\mu\text{g/L}$. However, additional colloids are easily generated by artefacts and the natural concentration in the groundwater may be lower. The fractionation/ultra filtration results indicate presence of iron fractions $> 1,000 \text{ D}$ and $> 5,000 \text{ D}$. It is possible that these fractions are also due to artefacts.
- If organic constituents exist in the groundwater, they are mostly present as low molecular weight fulvic acids or other low molecular weight organic acids such as citric acid and oxalic acid with a molecular weight less than 1,000 D.

10 References

- /1/ **SKB, 2001.** Site investigations. Investigation methods and general execution programme. SKB R-01-29, Svensk Kärnbränslehantering AB.
- /2/ **Pedersen K, 2005.** Forsmark site investigation. Total numbers and metabolic diversity of microorganisms in boreholes KFM08A and KFM09A. P-report in progress. SKB P-06-NN, Svensk Kärnbränslehantering AB.
- /3/ **Claesson L-Å, Nilsson G, 2005.** Forsmark site investigation. Drilling of the telescopic borehole KFM08A and the core drilled borehole KFM08B at drill site DS8. SKB P-05-172, Svensk Kärnbränslehantering AB.
- /4/ **SKB, 2005.** Forsmark site investigation. Programme for further investigations of geosphere and biosphere. SKB R-05-14, Svensk Kärnbränslehantering AB.
- /5/ **Claesson L-Å, Nilsson G, 2004.** Forsmark site investigation. Drilling of two flushing water wells, HFM21 and HFM22, one groundwater monitoring well in solid bedrock, HFM20, and one groundwater monitoring well in soil, SFM0076. SKB P-04-245, Svensk Kärnbränslehantering AB.
- /6/ **Nilsson D, 2005.** Forsmark site investigation. Sampling and analyses of groundwater from percussion drilled boreholes. Results from the percussion drilled boreholes HFM20, HFM21 and HFM22. SKB P-05-48, Svensk Kärnbränslehantering AB.
- /7/ **Pedersen K, 2005.** Control of microorganism content in flushing water used for drilling of KFM06A. SKB P-05-81, Svensk Kärnbränslehantering AB.
- /8/ **Nielsen U T, Ringgaard J, Fries Dahl T, 2005.** Forsmark site investigation. Geophysical borehole logging in the boreholes KFM07A, KFM08A and KFM08B. SKB P-05-159. Svensk Kärnbränslehantering AB.
- /9/ **Gustafsson J, Gustafsson C, 2005.** Forsmark site investigation. RAMAC and BIPS logging in borehole KFM08A. SKB P-05-158, Svensk Kärnbränslehantering AB.
- /10/ **Rouhiainen P, Sokolnicki M, 2005.** Forsmark site investigation. Difference flow logging in borehole KFM08A. SKB P-05-43, Svensk Kärnbränslehantering AB.
- /11/ **Berg C, 2005.** Forsmark site investigation. Hydrochemical logging in KFM08A. SKB P-05-206, Svensk Kärnbränslehantering AB.

Design of cored borehole KFM08A

Technical data Borehole KFM08A

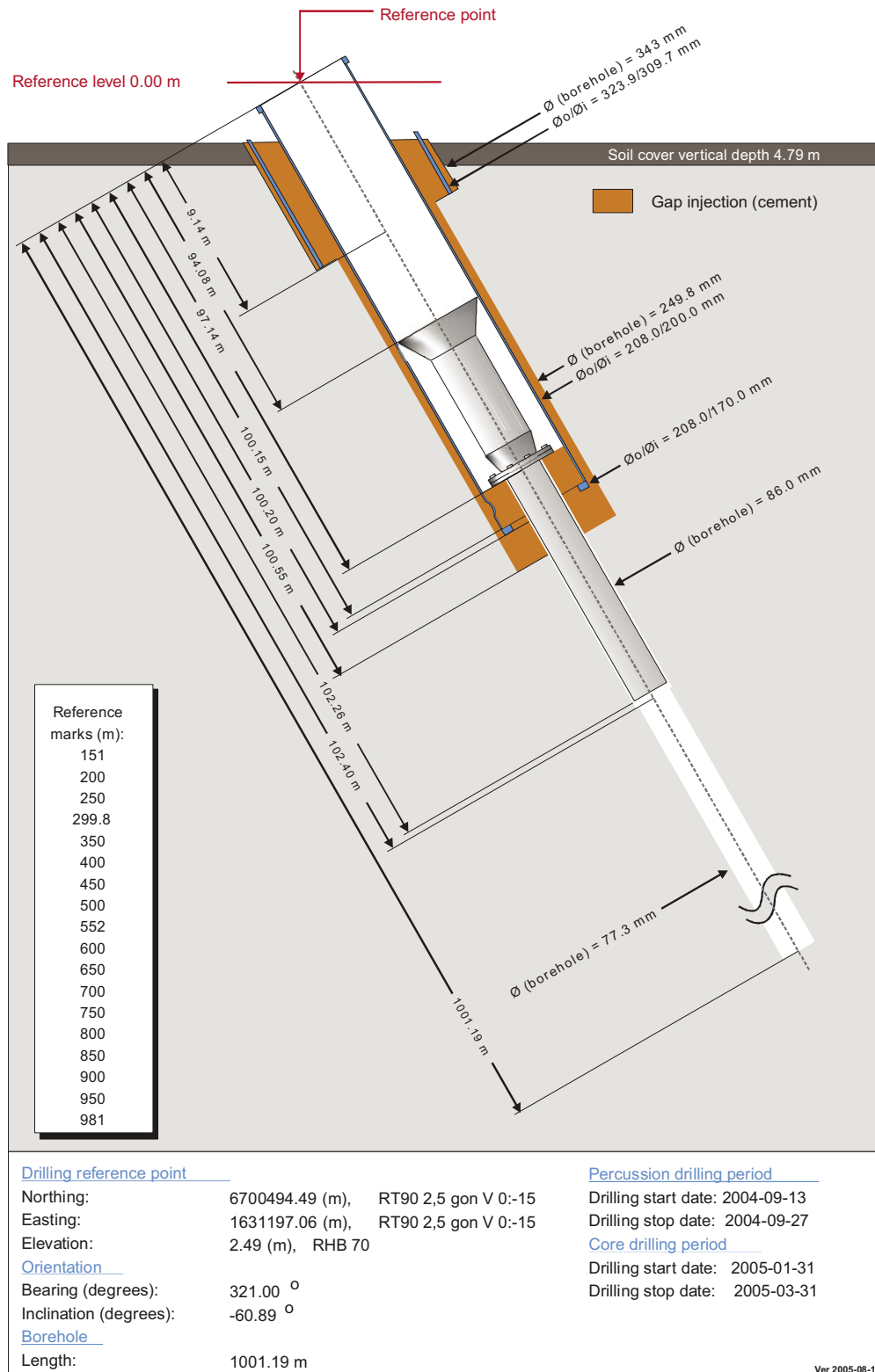

Selected results from differential flow logging, KFM08A

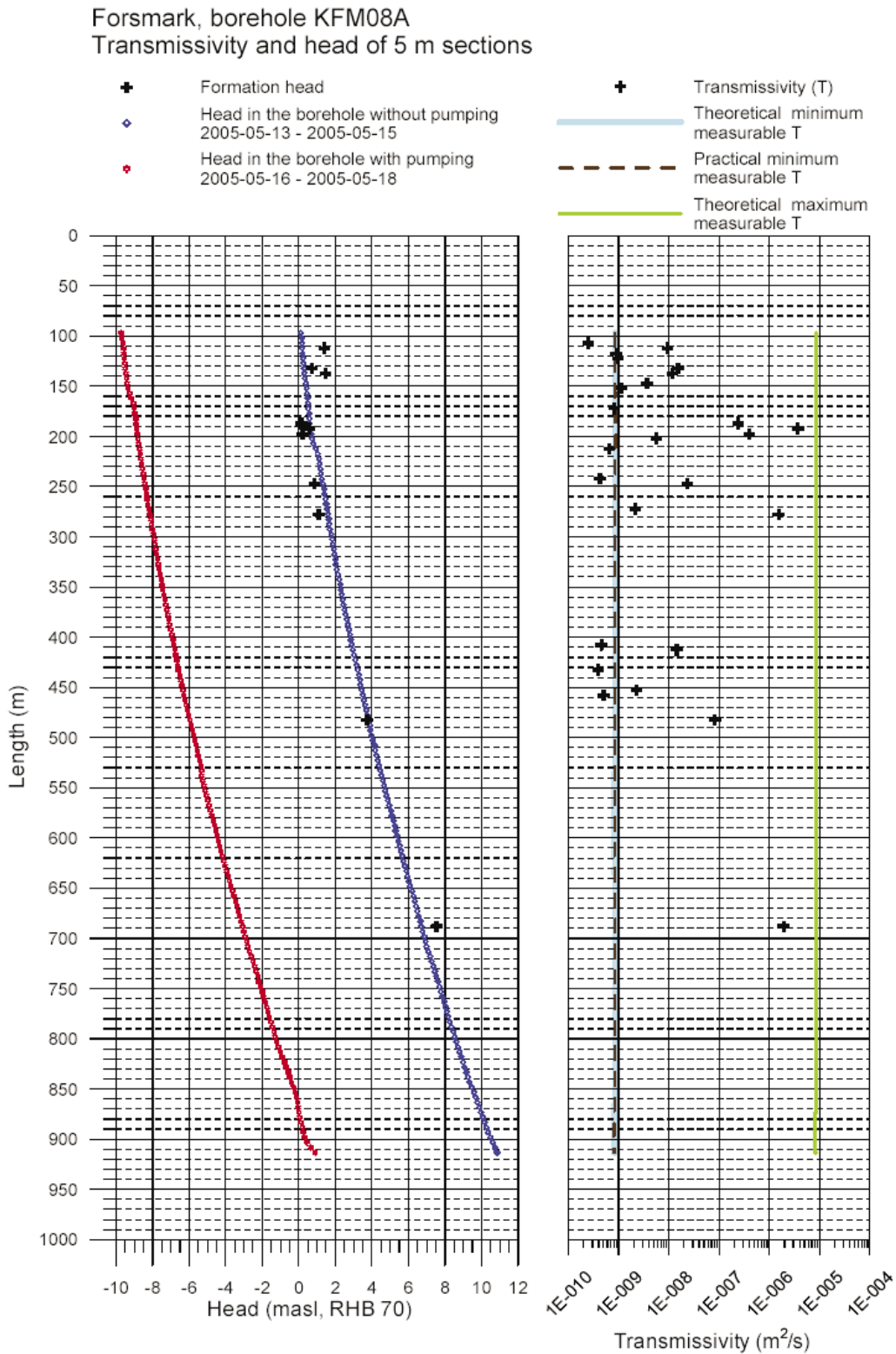

Figure A2-1. Borehole KFM08A: head of detected fractures and hydraulic transmissivity of 5 m sections /10/.

Forsmark, borehole KFM08A
Flow rate, caliper and single point resistance

- ▲ Without pumping (L=5 m, dL=5 m), (Flow direction = into the hole)
- ▼ Without pumping (L=5 m, dL=5 m), (Flow direction = into the bedrock)
- ▲ With pumping (L=5 m, dL=5 m), (Flow direction = into the hole)
- Without pumping (L=5 m, dL=0.5 m), 2005-05-13 - 2005-05-15
- With pumping (L=5 m, dL=0.5 m), 2005-05-16 - 2005-05-18
- With pumping (L=1 m, dL=0.1 m), 2005-05-18 - 2005-05-20
- Lower limit of flow rate

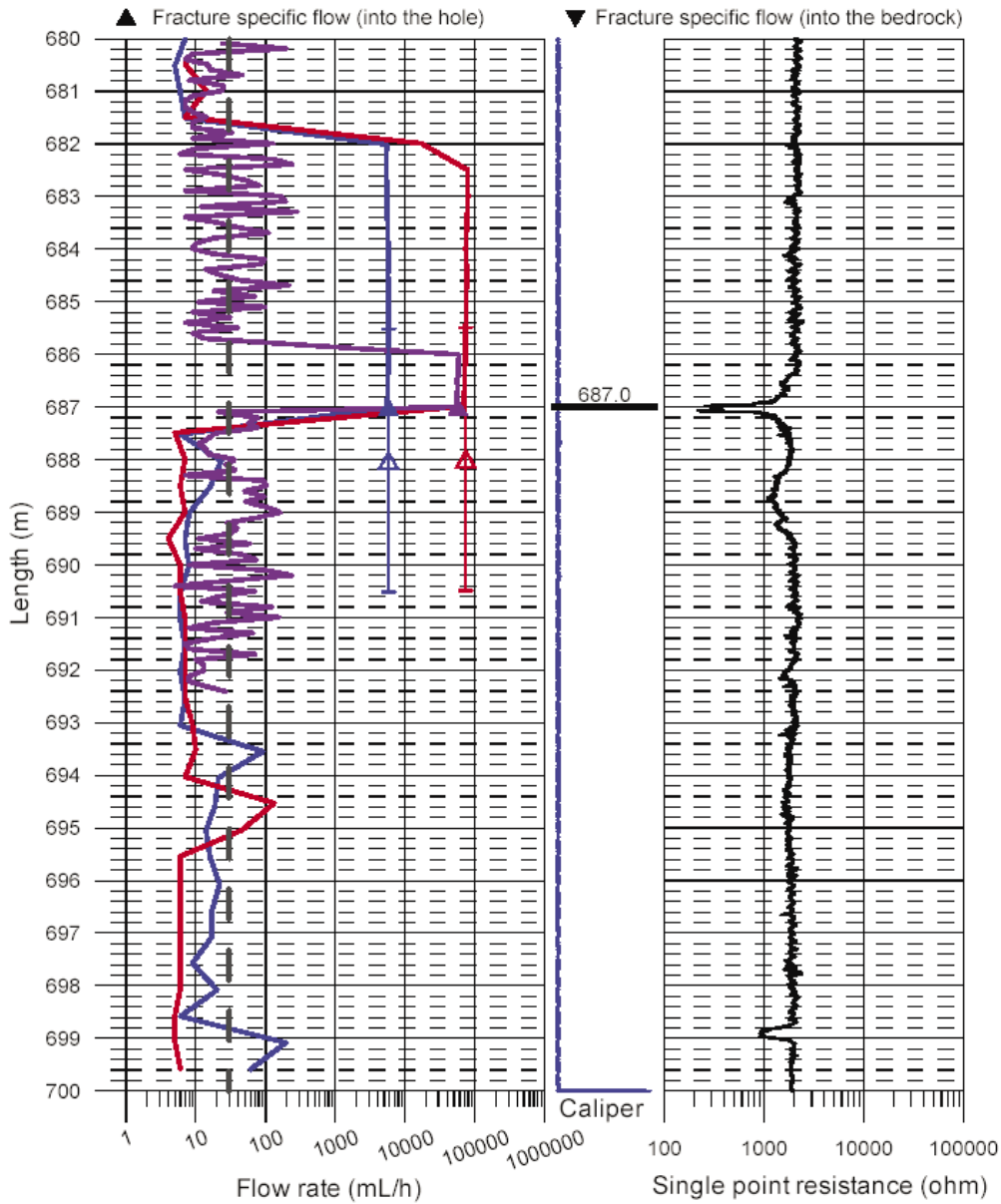

Figure A2-2. Borehole KFM08A: differential flow measurements from 680–700 m including the water bearing fracture zone at 687 m /10/.

Selected BIPS logging image, KFM08A

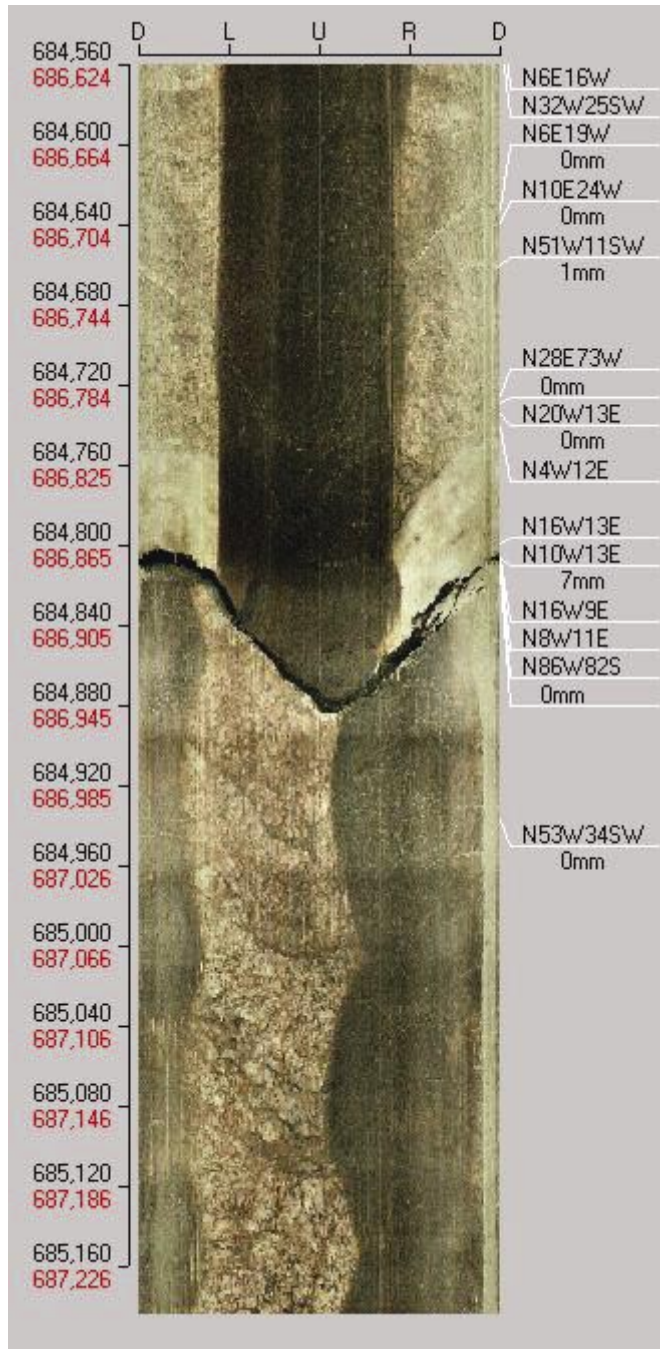

Figure A3-1. Borehole KFM08A: selected BIPS logging image from 686.6 to 687.2 m borehole length, including the water bearing fracture at 686.9 m. The non-adjusted length is marked with black and the adjusted true length is marked with red /9/.

Measurement information, KFM08A

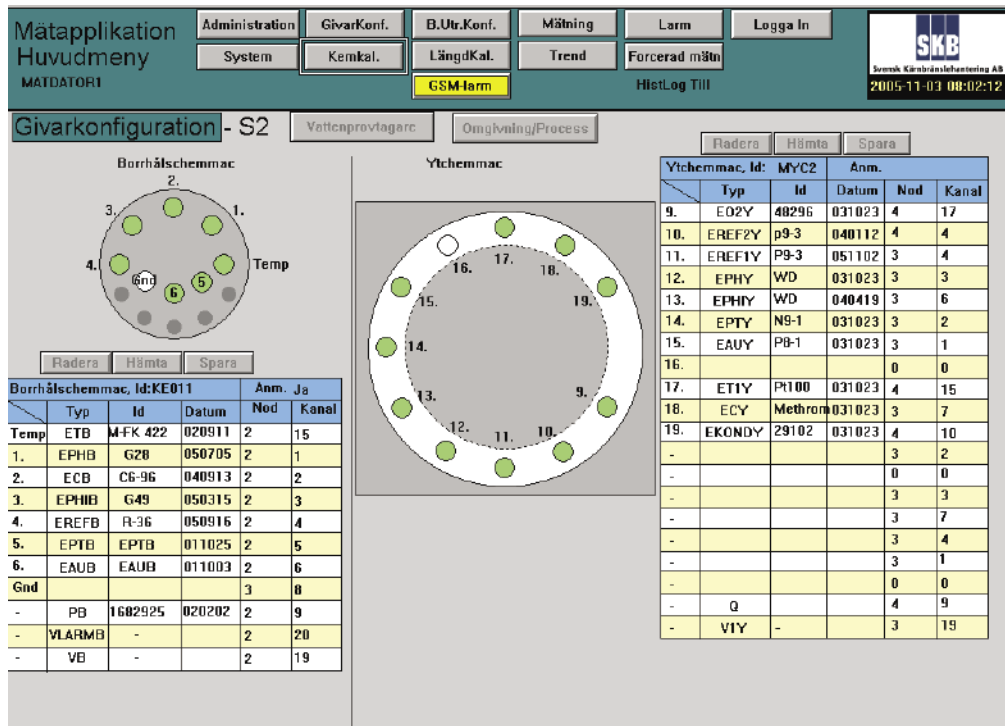

Figure A4-1. Electrode configuration, section 683.5–690.6 (690.8) m.

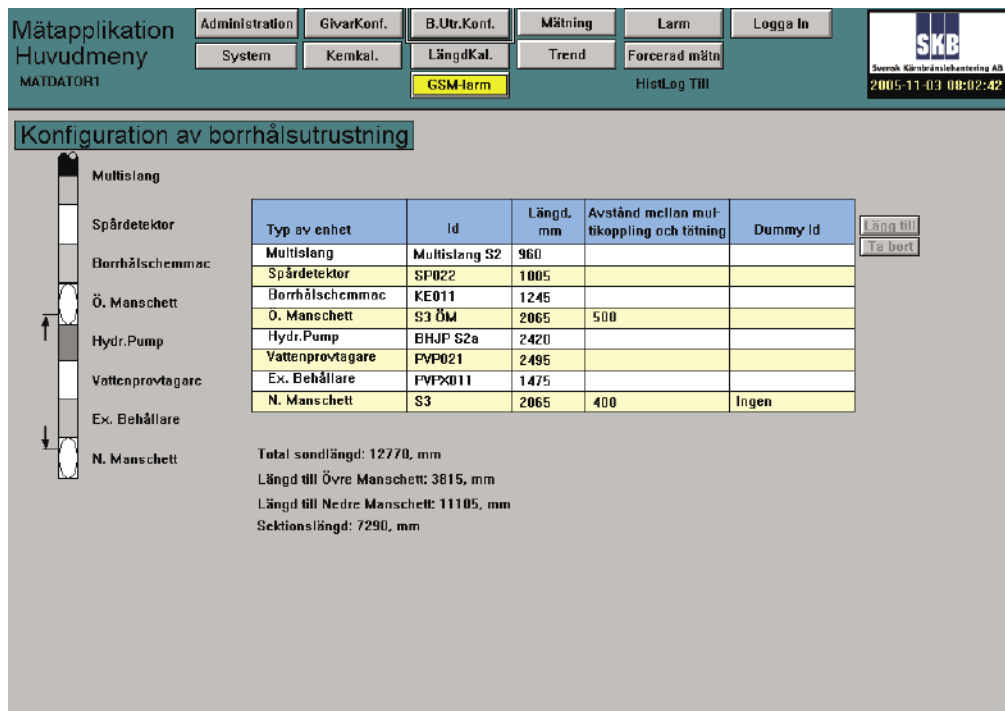

Figure A4-2. Configuration of downhole equipment, section 683.5–690.6 (690.8) m.

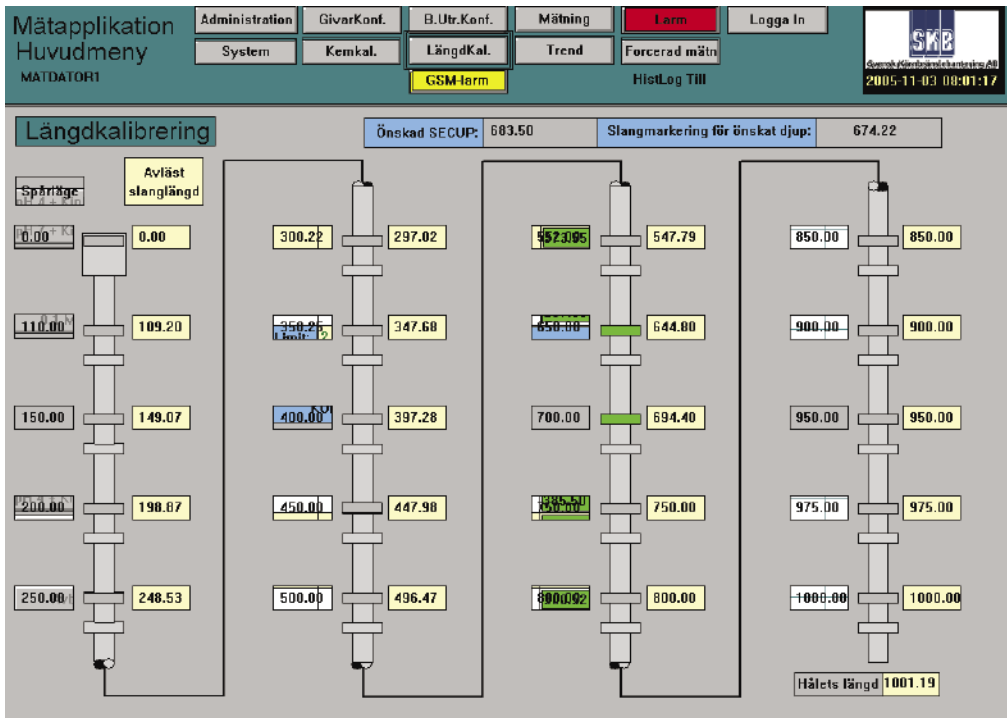

Figure A4-3. Length calibration, section 683.5–690.6 (690.8) m.

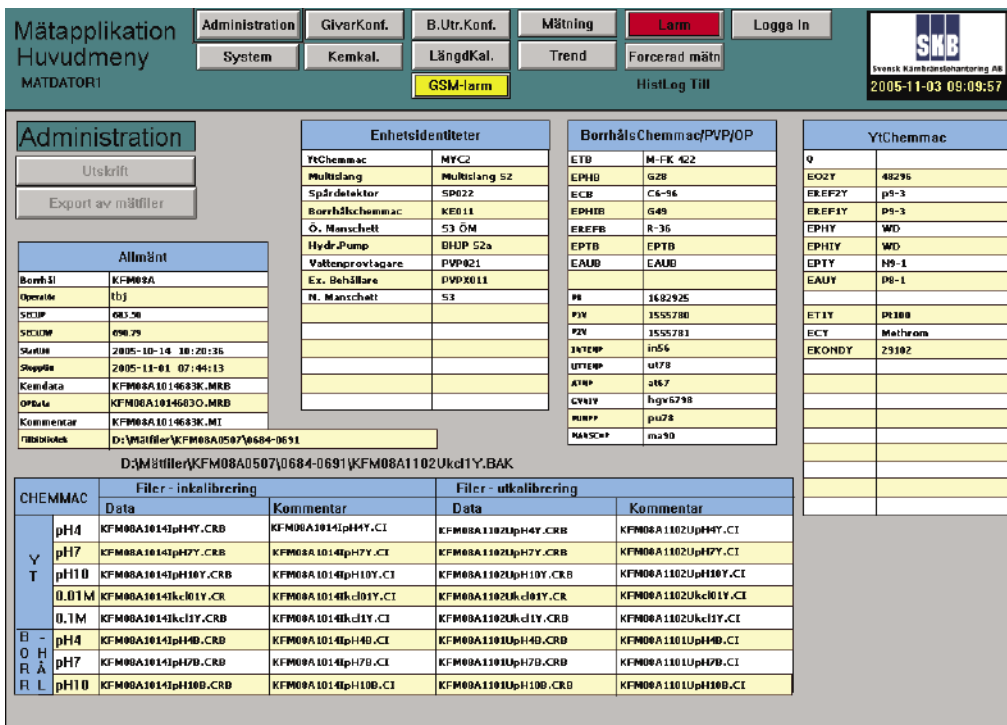

Figure A4-4. Administration, section 683.5–690.6 (690.8) m.

Flow and pressure measurements, KFM08A

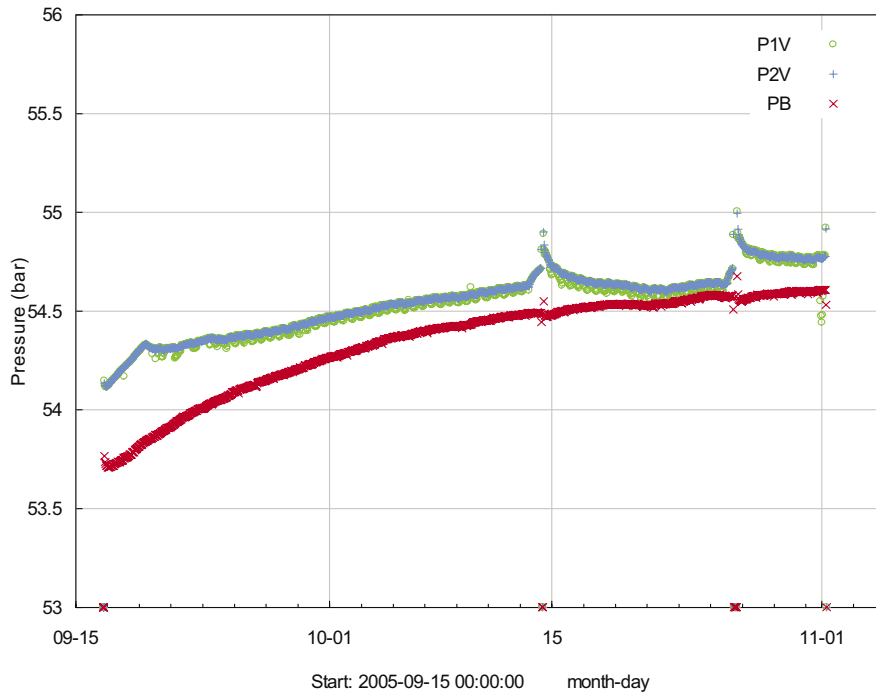

Figure A5-1. Pressure measurements (P1V, P2V and PB), section 683.5–690.6 (690.8) m. The sensors P1V and P2V measure the pressure within the section and are both placed in the in situ sampling unit. The sensor PB, placed in the borehole Chemmac, measures the pressure above the section.

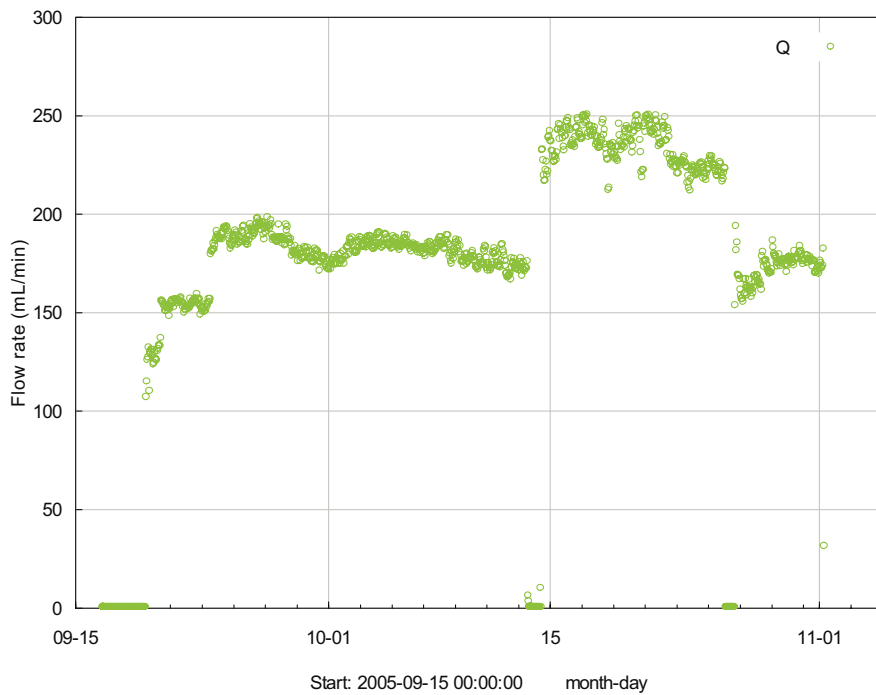

Figure A5-2. Pumping flow rate (Q), section 683.5–690.6 (690.8) m.

Sampling and analytical methods

Table A6-1. Sample handling routines and analytical methods.

Component group	Component/element	Sample container (material)	Volume (mL)	Filtering	Preparation/Conservation*	Analysis method	Analysis within – or delivery time to lab.
Anions 1.	HCO ₃ pH(lab) cond (lab)	Plastic	250	Yes (not in the field)	No	Titration Pot. meas, Cond. meas	The same day – maximum 24 hours
Anions 2	Cl, SO ₄ , Br ⁻ , F ⁻ , I ⁻	Plastic	100	Yes (not in the field)	No	Titration (Cl ⁻) IC (Cl ⁻ , SO ₄ , Br ⁻ , F ⁻) ISE (F ⁻)	Not critical (month)
	Br, I	Plastic	100	Yes (not in the field)	No	ICP MS	Not critical (month)
Cations, Si and S according to SKB class 3	Na, K, Ca, Mg, S(tot), Si(tot), Li, Sr	Plastic (at low conc. acid washed bottles)	100	Yes (not in the field)	Yes (not in the field, 1 mL HNO ₃)	ICP-AES ICP-MS	Not critical (month)
Cations, Si and S according to SKB class 4 and 5	Na, K, Ca, Mg, S(tot), Si(tot), Fe, Mn, Li, Sr	Plastic (Acid washed)	100	Yes (immediately in the field)	Yes (1 mL HNO ₃)	ICP-AES ICP-MS	Not critical (month)
Fe(II), Fe(tot)	Fe(II), Fe(tot)	Plastic (Acid washed)	500	Yes	Yes (5 mL HCl)	Spectrophotometry Ferrozine method	As soon as possible the same day
Hydrogen sulphide	HS ⁻	Glass (Winkler)	About 120×2	No	Ev 1 mL 1 M NaOH+ 1 mL 1M ZnAc	Spectrophotometry	Immediately or if conserved, a few days
Environmental metals	Al, As, Ba, B, Cd, Co, Cr, Cu, Hg, Mo, Ni, P, Pb, V, Zn	Plastic (Acid washed)	100	Yes	Yes (1 mL HNO ₃)	ICP-AES ICP-MS	Not critical (month)

Component group	Component/element	Sample container (material)	Volume (mL)	Filtering	Preparation/Conservation*	Analysis method	Analysis within – or delivery time to lab.
Lantanoids, U, Th and so on.	Sc, Rb, Y, Zr, I, Sb, Cs, La, Hf, Ti, Ce, Pr, Nd, Sm, Eu, Gd, Tb, Dy, Ho, Er, Tm, Yb, Lu, U, Th	Plastic (Acid washed)	100	Yes	Yes (1 mL HNO ₃)	ICP-AES ICP-MS	Not critical (month)
Dissolved organic Carbon, dissolved inorganic Carbon	DOC, DIC	Plastic	250 25	Yes	Frozen, transported in isolated bag	UV oxidation, IR Carbon analyser Shimadzu TOC5000	Short transportation time
Total organic Carbon	TOC	Plastic	250 25	No	Frozen, transported in isolated bag	UV oxidation, IR Carbon analyser Shimadzu TOC5000	Short transportation time
Environmental isotopes	² H, ¹⁸ O	Plastic	100	No	– –	MS	Not critical (month)
Tritium	³ H (enhanced.)	Plastic (dry bottle)	500	No	–	LSC	
Chlorine-37	³⁷ Cl	Plastic	100	No	–	ICP MS	Not critical (month)
Carbon isotopes	¹³ C, ¹⁴ C (pmC)	Plastic (HDPE)	100×2	No	–	(A)MS	A few days
Sulphur isotopes	³⁴ S	Plastic	500– 1,000	Yes	–	Combustion, ICP MS	No limit
Strontium-isotopes	⁸⁷ Sr/ ⁸⁶ Sr	Plastic	100	Yes	–	TIMS	Days or Week
Uranium and Thorium isotopes	²³⁴ U, ²³⁵ U, ²³⁸ U, ²³² Th, ²³⁰ Th	Plastic	50 1,000	Nej	–	Chemical separat. Alfa/gamma spectrometry	No limit
Boron isotopes	¹⁰ B	Plastic	100	Yes	Yes (1 mL HNO ₃)	ICP – MS	No limit
Radon and Radium isotopes	²²² Rn, ²²⁶ Ra	Plastic	500– 1,000	No	No	EDA, RD-200	Immediate transport
Dissolved gas (content and composition)	Ar, N ₂ , CO ₂ , O ₂ , CH ₄ , H ₂ , CO, C ₂ H ₂ , C ₂ H ₄ , C ₂ H ₆ , C ₃ H ₈	Cylinder of stainless steel	200	No	No	GC	Immediate transport

Component group	Component/element	Sample container (material)	Volume (mL)	Filtering	Preparation/Conservation*	Analysis method	Analysis within – or delivery time to lab.
Colloids	Filter series	Polycarbonate filter	0.4, 0.2 and 0.05 µm	–	Ar atmosphere	ICP-AES ICP-MS	Immediate transport
Fractionation; Humic and fulvic acids, inorganic constituents	< 1,000 D > 1,000 D but < 5,000 D > 5,000 D	Fractions are collected in plastic bottles	250	–	N ₂ atmosphere	UV oxidation, IR (DOC)	Immediate transport
Archive samples with acid	–	Plastic (washed in acid)	100×2**	Yes	Yes (1 mL HNO ₃)	–	Storage in freeze container
Archive samples without acid	–	Plastic	250×2**	Yes	No	–	Storage in freeze container
Carbon isotopes in humic and fulvic acids	¹³ C, ¹⁴ C (pmc)	DEAE cellulose (anion exchanger)	–	–	–	(A)MS	A few days
Nutrient salt + silicate	NO ₂ , NO ₃ , NO ₂ + NO ₃ , NH ₄ , PO ₄ , SiO ₄	Sample tubes, plastic	25×2 250	Yes (in the field)	No, frozen immediately***	Spectrophotometry	Short transportation time
Total concentrations of Nitrogen and Phosphorous	N-tot, P-tot	Plastic	100	No	No, frozen immediately***	Spectrophotometry	Short transportation time
Particulate Carbon, Nitrogen and Phosphorous	POC, PON, POP	Plastic	1,000	Yes (within 4 h) prepared filters. Blank filters	Filtering, the filters are frozen immediately 2 filters/sample	Elementar-analysator (N, C) own method 990121 (P)	Short transportation time
Chlorophyll	Chlorophyll a, c and pheopigment	Plastic	1,000–2,000	Yes (within 4 h)	Filtering, the filters are frozen immediately	Spectrophotometry Fluorometry	Short transportation time
Oxygen	Dissolved O ₂	Winkler, glass	2×ca 120	No	Mn (II) reagent iodide reagent 50 mL HNO ₃	–	Within 3 days Storage in freeze container
Archive samples for supplementary radio nuclides	–	Plastic	5,000	No	–	–	–

* Suprapur acid is used for conservation of samples.

** Minimum number. The number of archive samples can vary depending on the number of similar samples collected at the same occasion.

*** The sample is transported in frozen condition to the laboratory. It is possible that the silicate concentration can change due to polymerisation for this reason.

Abbreviations and definitions:

IC	Ion chromatograph
ISE	Ion selective electrode
ICP-AES	Inductively Coupled Plasma Atomic Emission Spectrometry
ICP-MS	Inductively Coupled Plasma Mass Spectrometry
INAA	Instrumental Neutron Activation Analysis
MS	Mass Spectrometry
TIMS	Thermal Ionization Mass Spectrometer
LSC	Liquid Scintillation Counting
(A)MS	(Accelerator) Mass Spectrometry
GC	Gas Chromatography

Table A6-2. Reporting limits and measurement uncertainties.

Component	Method	Reporting limits or range	Unit	Measurement uncertainty ²	“Total” uncertainty ³
HCO ₃	Alkalinity titration	1	mg/L	4%	< 10%
Cl ⁻	Mohr-titration	> 70	mg/L	5%	< 10%
Cl ⁻	IC	1–100		6%	10%
SO ₄	IC	1	mg/L	10%	15%
Br ⁻	IC	0.2	mg/L	9%	20%
Br ⁻	ICP	0.001		15%	
F ⁻	IC	0.1	mg/L	10%	20%
F ⁻	Potentiometric	–		–	
I ⁻	ICP	0.001	mg/L	15%	20%
Na	ICP	0.1	mg/L	4%	10%
K	ICP	0.4	mg/L	6%	15%
Ca	ICP	0.1	mg/L	4%	10%
Mg	ICP	0.09	mg/L	4%	10%
S(tot)	ICP	0.160	mg/L	21%	15%
Si(tot)	ICP	0.03	mg/L	4%	15%
Sr	ICP	0.002	mg/L	4%	15%
Li	ICP	0.2 ¹ 2	mg/L	10%	20%
Fe	ICP	0.4 ¹ 4	mg/L	6%	10%
Mn	ICP	0.03 ¹ 0.1	µg/L	8%	10%
Fe(II), Fe(tot)	Spectrophotometry	0.02 (DL=0.005 mg/L)	mg/L	15% (> 30 µg/L)	20%
HS ⁻	Spectrophotometry	SKB 0.03 (DL=0.02)	mg/L	10%	30%
NO ₂ as N	Spectrophotometry	0.1	µg/L	2%	20%
NO ₃ as N	Spectrophotometry	0.2	µg/L	5%	20%
NO ₂ + NO ₃ as N	Spectrophotometry	0.2	µg/L	0.2 (0.2–20 µg/L) 2% (> 20 µg/L)	20%
NH ₄ as N	Spectrophotometry	0.8	µg/L	0.8 (0.8–20 µg/L) 5% (> 20 µg/L)	20%
PO ₄ as P	Spectrophotometry	50 (SKB) 0.7	µg/L	0.7 (0.7–20 µg/L) 3% (> 20 µg/L)	20%

Component	Method	Reporting limits or range		Unit	Measurement uncertainty ²	"Total" uncertainty ³
SiO ₄	Spectrophotometry	1		µg/L	3% (> 200 µg/L)	–
O ₂	Jodometric titration	0.2–20		mg/L	5%	–
Chlorophyll a, c pheopigment ⁴	See Table A1-2	0.5		µg/L	5%	–
PON ⁴	See Table A1-2	0.5		µg/L	5%	–
POP ⁴	See Table A1-2	0.1		µg/L	5%	–
POC ⁴	See Table A1-2	1		µg/L	4%	–
Tot-N ⁴	See Table A1-2	10		µg/L	4%	–
Tot-P ⁴	See Table A1-2	0.5		µg/L	6%	–
Al, Zn	ICP	0.2		µg/L	12%	20% ⁴
Ba, Cr, Mo, Pb	ICP	0.01		µg/L	7–10%	20% ⁴
Cd, Hg	ICP	0.002		µg/L	9 resp 5%	20% ⁴
Co, V	ICP	0.005		µg/L	8 resp 5%	20% ⁴
Cu	ICP	0.1		µg/L	8%	20% ⁴
Ni	ICP	0.05		µg/L	8%	20% ⁴
P	ICP	1		µg/L	6%	10%
As	ICP	0.01		µg/L	20%	Correct order of size (low conc.)
La, Ce, Pr, Nd, Sm, Eu, Gd, Tb, Dy, Ho, Er, Tm, Yb	ICP	0.005 ¹	0.05	µg/L	10%	Correct order of size (low conc.)
Sc, In, Th	ICP	0.05 ¹	0.5	µg/L	10%	Correct order of size (low conc.)
Rb, Zr, Sb, Cs, Tl	ICP	0.025 ¹	0.25	µg/L	10%	Correct order of size (low conc.)
Y, Hf	ICP	0.005 ¹	0.05	µg/L	10%	Correct order of size (low conc.)
U	ICP	0.001 ¹	–	µg/L	12%	Correct order of size (low conc.)
DOC	See Table A1-1	0.5		mg/L	8%	30%
TOC	See Table A1-1	0.1		mg/L	10%	30%
δ ² H	MS	2		‰ SMOW ⁵	1‰	–
δ ¹⁸ O	MS	0.1		‰ SMOW ⁵	0.2‰	–

Component	Method	Reporting limits or range	Unit	Measurement uncertainty ²	“Total” uncertainty ³
³ H	LSC	0.8 eller 0.1	TU ⁶	0.8 eller 0.1	Correct order of size
³⁷ Cl	ICP MS	0.2‰ (20 mg/L)	‰ SMOC ⁷	–	–
δ ¹³ C	A (MS)	–	‰ PDB ⁸	–	–
¹⁴ C pmc	A (MS)	–	PMC ⁹	–	–
δ ³⁴ S	ICP MS	0.2‰	‰ CDT ¹⁰	0.3‰	–
⁸⁷ Sr/ ⁸⁶ Sr	TIMS	–	No unit (ratio) ¹¹	–	–
¹⁰ B/ ¹¹ B	ICP MS	–	No unit (ratio) ¹¹	–	–
²³⁴ U, ²³⁵ U, ²³⁸ U, ²³² Th, ²³⁰ Th	Alfa spectr.	0.0005	Bq/L ¹²	5%	–
²²² Rn, ²²⁶ Rn	LSC	0.03	Bq/L	5%	–

¹ Reporting limits at salinity ≤ 0.4% (520 mS/m) and ≤ 3.5% (3,810 mS/m) respectively.

² Measurement uncertainty reported by consulted laboratory, generally 95% confidence interval.

³ Estimated total uncertainty by experience (includes effects of sampling and sample handling).

⁴ Determined only in surface waters and near surface groundwater.

⁵ Per mille deviation¹³ from SMOW (Standard Mean Oceanic Water).

⁶ TU=Tritium Units, where one TU corresponds to a Tritium/hydrogen ratio of 10⁻¹⁸ (1 Bq/L Tritium = 8.45 TU).

⁷ Per mille deviation¹³ from SMOC (Standard Mean Oceanic Chloride).

⁸ Per mille deviation¹³ from PDB (the standard PeeDee Belemnite).

⁹ The following relation is valid between pmC (percent modern carbon) and Carbon-14 age:
pmC = 100 × e^{((1950-y-1.03t)/8274)} where y = the year of the C-14 measurement and t = C-14 age.

¹⁰ Per mille deviation¹³ from CDT (the standard Canyon Diablo Troilite).

¹¹ Isotope ratio without unit.

¹² The following expressions are applicable to convert activity to concentration, for uranium-238 and thorium-232: 1 ppm U = 12.4 Bq/kg²³⁸U, 1 ppm Th = 3.93 Bq/kg²³²Th

¹³ Isotopes are often reported as per mill deviation from a standard. The deviation is calculated as:
δ‰ = 1,000 × (K_{sample} - K_{standard}) / K_{standard}, where K = the isotope ratio and ‰ = ²H, ¹⁸O, ³⁷Cl, ¹³C or ³⁴S etc.

Laser-Induced Breakdown Colloid Detection in Natural Ground Water from Forsmark Borehole KFM08A, Section 683.5–690.6 m

W. Hauser, H. Geckeis, R. Götz

Forschungszentrum Karlsruhe GmbH, Institut für Nukleare Entsorgung (INE)
P.O. Box 3640, D-76021 Karlsruhe, Germany

Introduction

Colloid analysis has been performed in ground water samples collected during the site investigation program at Forsmark, Sweden. Two samples of the same ground water have been collected in a stainless steel cylinder each, avoiding water contact with the atmosphere. They were sent to INE for laboratory analysis. Colloid analysis was subsequently performed by the laser-induced breakdown detection (LIBD) in the laboratory using a closed flow-through detection cell again without atmosphere contact. Furthermore, a thorough chemical analysis of the water samples was performed (... not subject of this order).

It is supposed that the geological situation is similar to that found at various places in the Äspö tunnel. The aim of this study is to investigate the natural amount of background colloids in this specific borehole and to compare the data with those obtained from other sites.

Experimental

LIBD instrumentation

The principle of LIBD is based on the generation of a dielectric breakdown in the focus region of a pulsed laser beam. As the threshold energy (irradiance) to induce a breakdown is lower for solids than for liquids or gas, the breakdown can be generated selectively in particles dispersed in solution at a suitable pulse energy.

A schematic diagram of the mobile LIBD set-up used in the present work is shown Figure A7-1. A pulsed laser beam with a frequency of 15 Hz at 532 nm wavelength from a small Nd:YAG-laser (Continuum Minilite I) is focused (15 mm focal length) into the center of a flow-through detection cell, after passing through a variable attenuator and a beam splitter. The plasma generated at a breakdown event is monitored by a microscope equipped with a CCD monochrome camera triggered by the incident laser pulse and recorded by a PC controlled image processing system. A breakdown shock wave propagated in the sample solution is detected simultaneously by an acoustic sensor (piezoelectric transducer) that is connected to the surface of the cell. Both, the energy and the acoustic signal are recorded by an analog-digital converter interface in a PC. Colloid concentrations are derived from the respective breakdown probability, represented by the number of breakdown events per number of laser shots, and the range of breakdown events within the laser beam axis determined by optical inspection of the laser focus area within the flow through cell. Colloid number concentrations (Pt/L) are given relative to a calibration with polystyrene reference colloids. Mass concentrations are calculated by assuming an average colloid density of 2.7 g/ml and spherical particle shape. A more detailed description of data evaluation is given in /1/.

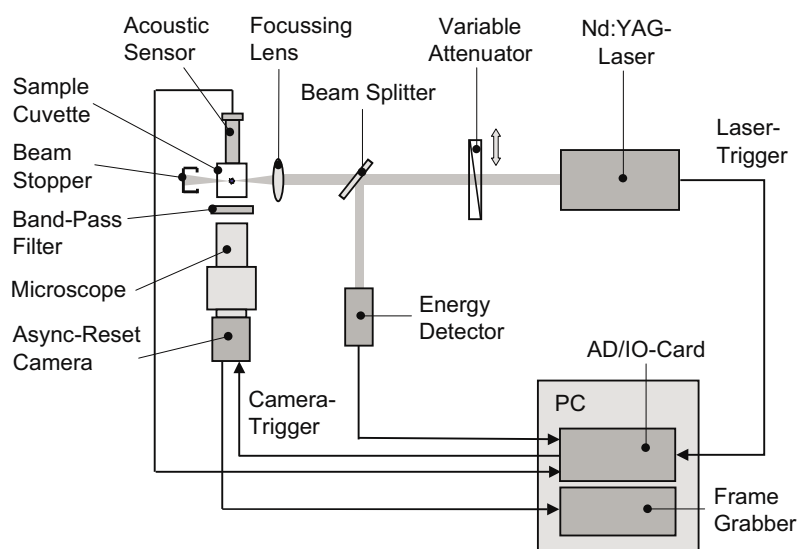

Figure A7-1. Schematic diagram of the mobile laser-induced breakdown detection system

The mobile instrumentation of LIBD is combined with a Millipore ultra-pure water processing unit for on-line cleaning the flow-through detection cell of LIBD and to allow for the frequent control of the instrument background. The whole system, which is set up to a compact mobile unit can be transported by a van for field experiments.

High-pressure flow-through detection cell

The LIBD has been operated in the CRR migration experiments (Grimsel Test-Site, Switzerland) /1/ under low pressure conditions with commercially available quartz detection cells (fluorescence cells) for batch (laboratory experiments) or flow-through sampling. These cells have a sample volume of 3 ml at 10 mm absorption length. A new flow-through detection cell has been developed constraining water pressures of about 35 bar for in situ investigations in the Äspö Hard Rock Laboratory access tunnel (Sweden) /2/, and in the Kraftwerke Oberhasli (KWO) access tunnel close to the Grimsel Test Site /3/. This detection cell has also been applied in connection with a borehole sampling system for the detection of ground water colloids sampled at a natural analogue site (Ruprechtov, Czech Republic).

Figure A7-2 presents the high-pressure detection cell developed by INE. Without changing the optical path of the laser light, the detection cell fits into the same mount used for the silica cell. The new cell, fabricated from PEEK (polyether etherketone) is lined outside with a stainless steel housing (black parts in Figure A7-2). Four optical windows, one at each side are applied for the passing laser light (absorption length 12 mm), the microscope and for inspection. They consist of sapphire with 2 mm thickness. The ground water flow enters the inner cell volume of 0.8 ml from the base via a PEEK tubing. The outlet is on the top of the cell. The high-pressure detection cell is successfully tested for a water pressure up to 60 bar.

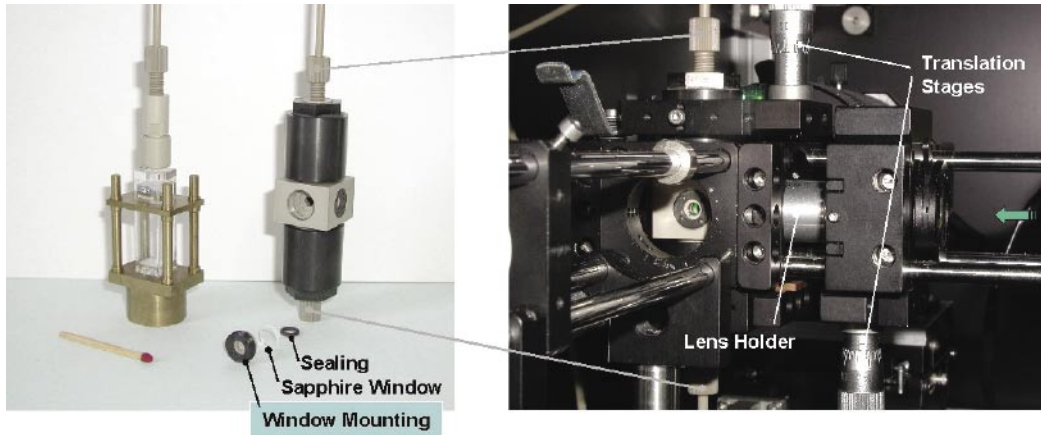

Figure A7-2. LIBD high-pressure flow-through detection cell (left: conventional flow-through silica detection cell).

Borehole sampling

Forsmark borehole KFM08A was sampled by SKB at October 31, 2005. Two samples were taken from a borehole section between 683.50–690.6 m. The vertical depth was approximately 590 m with a measured pressure in the borehole section of 53 bar.

The stainless steel cylinders (Figure A7-3) are ground water sampling cylinders from SKB with a sample volume of about 190 ml each. They are supplied with an internal piston and 3 valves. Further information concerning the sampling procedure is given elsewhere.

At November 7 the cooled samples arrived at the INE where they have been stored in a fridge (Temp. about 10 deg. C) until colloid detection at November 8, 2005 (PVB 201) and November 10, 2005 (PVB 203).



Figure A7-3. SKB stainless steel sampling cylinder (left: piston side, right: mounting adapter side).

Configuration of laboratory experiments

Each sampling cylinder is connected with the LIBD detection cell and the detection cells for pH-, Eh-, electrical conductivity-, oxygen content-detection and for taking samples for chemical ground water analysis. A scheme of the corresponding laboratory setup is plotted in Figure A7-4 with an image of the experimental configuration in Figure A7-5.

At first the tubings around the sampling cylinder are intensively cleaned by evacuation and flushing with Argon. Then a HPLC-pump is used to fill all tubings on the water side of the sampling cylinder with ultra-pure water and to set the water pressure of 53 bar. This was the expected water pressure in the sampling cylinder. The gas side of the sampling cylinder is then filled with 53 bar Argon gas.

Now one of the top valves of the sampling cylinder can be opened without contact of the sampled ground water with atmosphere oxygen. Surprisingly, the detected pressure of both water samples was about 13 bar, which was much lower than expected. With Argon gas the ground water is pressed out from the sampling cylinder through the LIBD detection cell via a degasser to avoid occasionally occurring gas bubbles which interfere the colloid detection. Behind the LIBD system additional detection cells with pressure resistant electrodes ($p < 15$ bar) for Oxygen, pH, Eh, a sensor for electrical conductivity and a sensor for the pressure detection are arranged downstream.

The Eh is detected with an electrode from Hamilton (Oxytrode). Before the sampling outlet a pressure regulator (PR), set to 8 bar, is installed. This overpressure in the whole system avoids further contact to oxygen. Data of this geo-monitoring system are stored on a personal computer with a data logger as a function of time. This allows to separate temporary fluctuating data, especially during the starting period when the detection cell and the geo-monitoring system are contaminated and does not contain the sampled ground water, respectively.

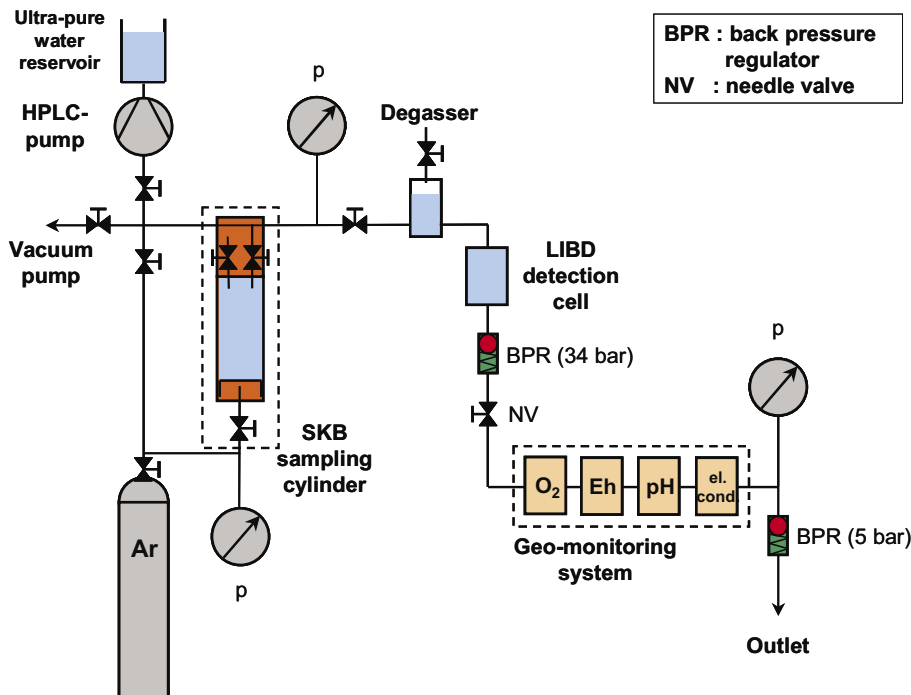

Figure A7-4. Scheme of the laboratory setup for in-line LIBD colloid analysis and ground water monitoring.



Figure A7-5. Experimental configuration.

Ground water batch samples are collected at the outlet of the pressure regulator for chemical analysis with ICP-AES, ICP-MS and for the detection of inorganic carbon (IC) and dissolved organic carbon (DOC).

Additionally, track-etched Polycarbonate filter samples (pore size 50 nm) have been taken for colloid analysis with REM/EDX.

Results

Data from geo-monitoring as well as the chemical composition of the two ground water samples, taken from the same ground water are displayed in Table A7-1.

The detected Eh (Table A7-1) demonstrates that reducing geochemical conditions are maintained within the sampling container during transport, storage and colloid detection. This indicates that a significant intrusion of atmosphere oxygen did not occur.

The ground water pH of 8.4 deviates from the pH detected so far in Forsmark and Äspö ground water (7.3–7.8). The chemical composition of the ground water is characterized mainly by the high salinity with about 5,900 mg/l chloride. Äspö data /4/ for this chloride content correspond with the detected DOC in ground water from sampling container PVB201. The higher DOC in ground water from container PVB203 might be caused by an organic contamination of the sample.

Data determined with the laser-induced breakdown detection system are listed in Table A7-2. There was sufficient ground water to perform two colloid measurements with each container.

Table A7-1. Monitored data of pH, Eh, el. conductivity, oxygen content and chemical analysis of the ground water samples from Forsmark borehole KFM08A.

		SKB PVB 201 FOR3	SKB PVB 203 FOR4
pH		8.45	8.27
Redox (Ag/AgCl)	mV	-240	-213
Eh (SHE)	mV	-26	1
el. cond.	mS/m	1,581	1,578
O ₂ content	mg/l	< 0.13	< 0.28
Na ⁺	mg/l	1,493	1,528
K ⁺	mg/l	17.1	14.3
Ca ²⁺	mg/l	2,080	2,051
Mg ²⁺	mg/l	12.04	12.06
HCO ₃ ⁻ (IC)	mg/l	9.61	8.92
Cl ⁻	mg/l	5,848	5,915
SO ₄ ²⁻	mg/l	84.77	84.66
Br ⁻	mg/l	45	44.6
F ⁻	mg/l	1.14	1.15
Si ⁴⁺	mg/l	3.9	3.8
Fe-ICP	mg/l	0.29	0.5
Mn ²⁺	mg/l	0.18	0.19
Li ⁺	mg/l	0.03	0.03
Sr ²⁺	mg/l	21.1	21
DOC	mg/l	2.7	9.5
IC	mg/l	1.9	1.8

Table A7-2. LIBD data with average colloid diameter and colloid concentration of the analyzed Forsmark KFM08A ground water.

		SKB PVB 201		SKB PVB 203	
		FOR3c	FOR3d	FOR4a	FOR4b
BD-events		751	862	788	1,488
Trigger-pulses		10,000	10,000	8,000	20,000
BD-probability		0.0751	0.0862	0.0985	0.0744
Colloid diam.	nm	380	342	172	222
Colloid mass conc.	µg/l	17.5	16.8	5.9	6.8

With image processing evaluated data, average colloid diameters of 340–380 nm and mass concentrations about 17 µg/l are calculated for the ground water sample from container PVB201. A lower colloid concentration of about 6 µg/l and an average colloid diameter of 170–220 nm is evaluated for the same ground water from sampling container PVB203. Nevertheless, these concentrations are more than 2 orders of magnitude higher than the LIBD detection limit. They are below these colloid amounts in the range of mg/l, which are generated when an intense access of oxygen to the ground water may have occurred.

Most relevant are the lowest detected colloid amounts in the sample. This comes closest to the natural colloid concentration of the undisturbed (equilibrated) ground water. A higher colloid concentration in the same ground water means that additional colloids are generated by artefacts. Such a source for additional colloids might be i.e.

- the erosion of particles during the sampling process,
- corrosion of container, valve, sealing materials,
- access of oxygen and formation of iron hydroxide,
- decrease of water pressure and precipitation of calcium carbonate.

In the Äspö colloid project /5/ a series of boreholes along the access tunnel have been sampled and their ground water was directly analyzed with the mobile LIBD system. A correlation was drawn (Figure A7-6) between the colloid concentration and the Cl^- concentration of the ground water. At a Cl^- concentration of about 4,000 mg/l a remarkable decrease of the colloid concentration over 4 orders of magnitude down to the LIBD detection limit of about 10 ng/l was observed.

The Forsmark KFM06A sample data fits quite well into this correlation. According to the colloid concentration correlation with groundwater salinity we would expect a lower colloid concentration for the KFM08A sample (Figure A7-6). Possible reasons for the somewhat high colloid concentration could be sampling or sample storage artifacts or the relatively high pH of the water being higher by more than one unit as compared to the KFM06A sample. At the high pH, oversaturation with regard to Fe(III)OOH phases is expected. Precipitation and colloid formation might explain the measured colloid concentration.

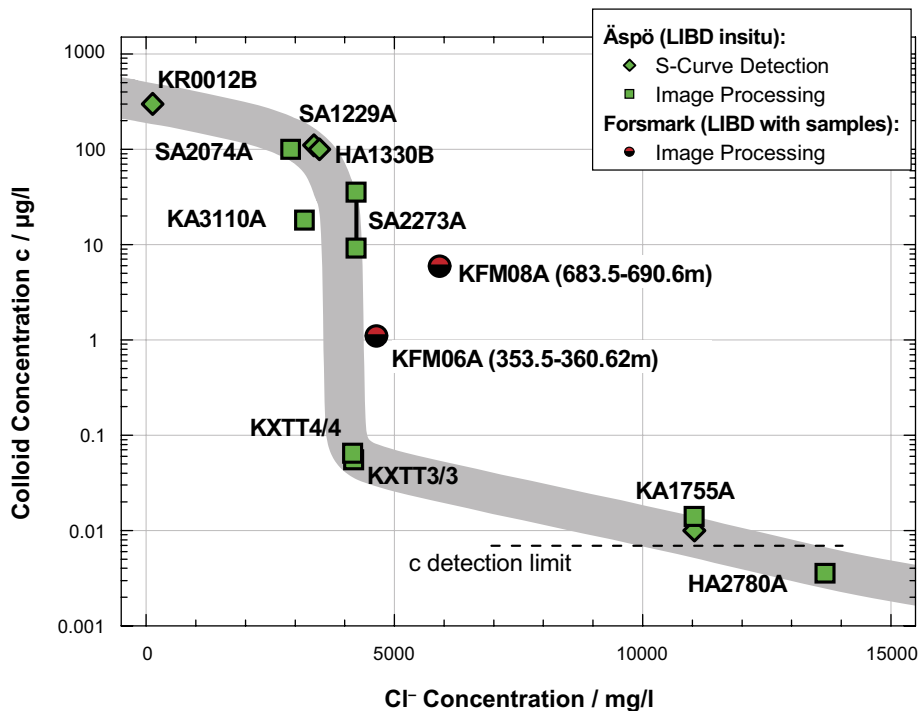

Figur A7-6. Correlation between colloid concentration and chloride concentration in different ground water from Äspö /2, 5/ and in Forsmark samples.

References

- /1/ **Hauser W, Geckeis H, Kim J I, Fierz Th, 2002.** A mobile laser-induced breakdown detection system and its application for the in situ-monitoring of colloid migration, *Coll. Surf.* 203, 2002, 37–45.
- /2/ **Hauser W, Geckeis H, Götz R, 2003.** In situ determination of natural ground water colloids in granite shear zones along the Äspö HRL Tunnel by LIBD, 27th Int. conf. on Scientific Basis for Nuclear Waste Management, Kalmar, S, June 15–18, 2003.
- /3/ **Geckeis H, Schäfer T, Rabung T, Hauser W, Möri A, Missana T, Eikenberg J, Degueldre C, Fierz T, Alexander W R, 2003.** Inorganic colloid borne actinide migration studied under in-situ conditions at the Grimsel test site, 9th Int. conf. on Chemistry and Migration Behavior of Actinides and Fission Products in the Geosphere, Migration '03, Gyeongju, Korea, Sept. 21–26, 2003.
- /4/ **Hauser W, Götz R, Geckeis H, Kienzler B, 2003.** In-situ colloid detection in granite groundwater along the Äspö Hard Rock Laboratory access tunnel, in Laaksoharju M, Äspö Hard Rock Laboratory, status report of the Colloid investigation conducted at the Äspö HRL during the years 2000–2003, SKB International Progress Report IPR-03-38, Stockholm, S, 2003.

**Chemmac measurements in KFM08A,
section 683.5–690.6 (690.8) m**

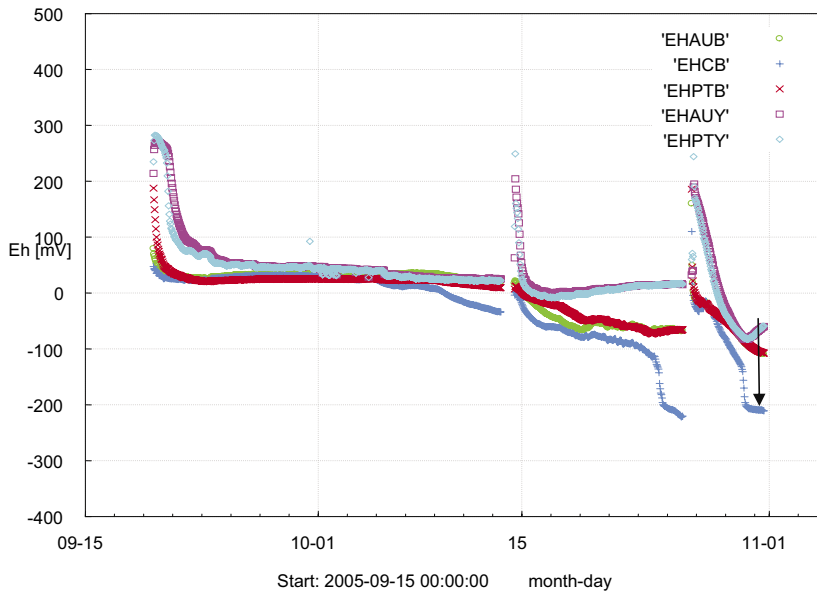

Figure A8-1. Redox potential measurements (Eh) by gold, glassy carbon and platinum electrodes in the borehole section (EHAUB, EHCB and EHPTB) and at the surface by gold and platinum (EHAUY and EHPTY). The arrow shows the chosen representative Eh value for the borehole section.

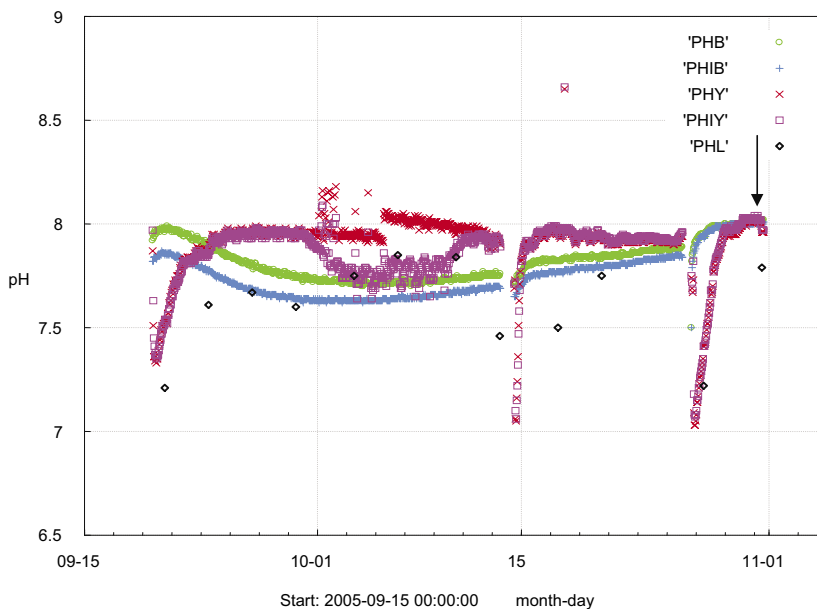

Figure A8-2. Measurements of pH by two glass electrodes in the borehole section (PHB and PHIB) and two glass electrodes at the surface (PHY and PHIY). The laboratory pH in each collected sample (PHL) is given for comparison. The arrow shows the chosen representative pH values for the borehole section.

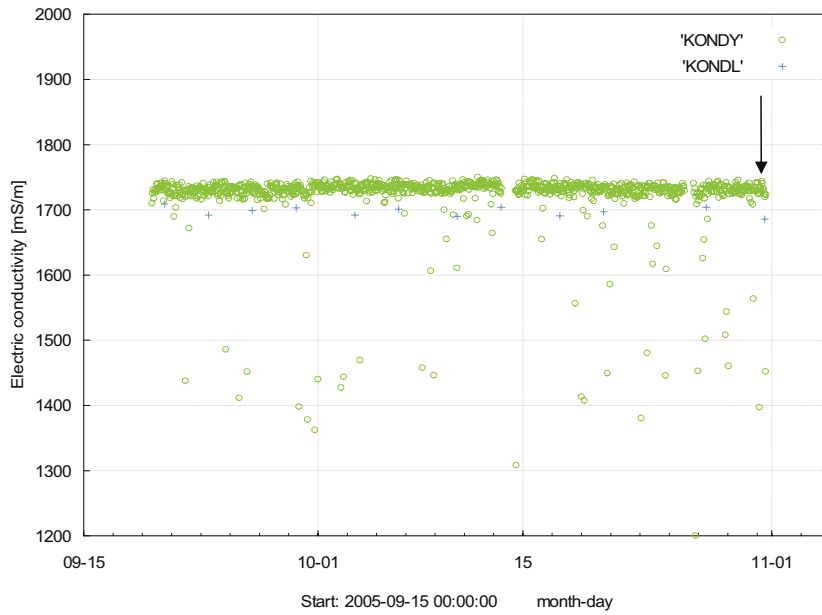

Figure A8-3. Electric conductivity measurements in the surface Chemmac cell (KONDY). The laboratory conductivity in each collected sample (KONDL) is given for comparison. The arrow shows the chosen representative electric conductivity value for the borehole section.

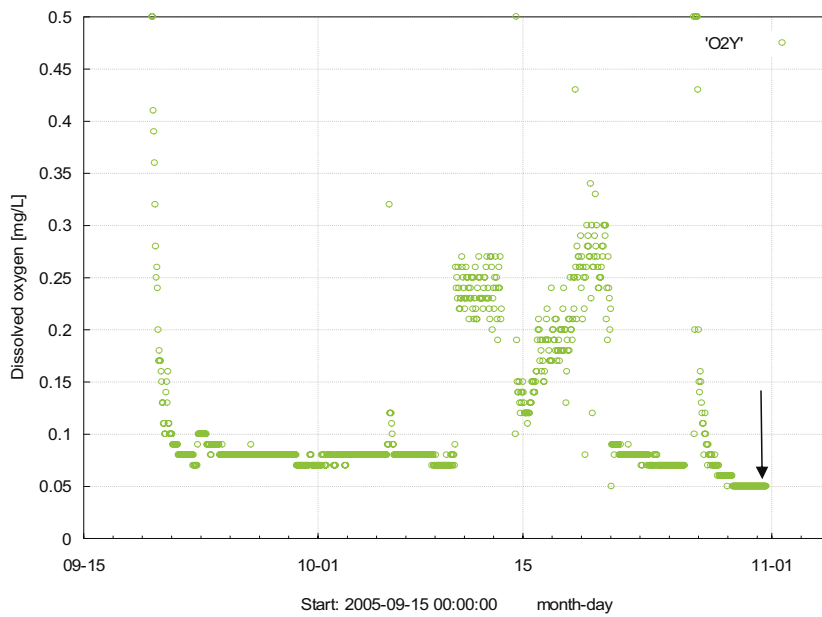

Figure A8-4. Dissolved oxygen measurements (O2Y) in the surface measurement cell. The arrow shows the chosen representative oxygen value for the borehole section.

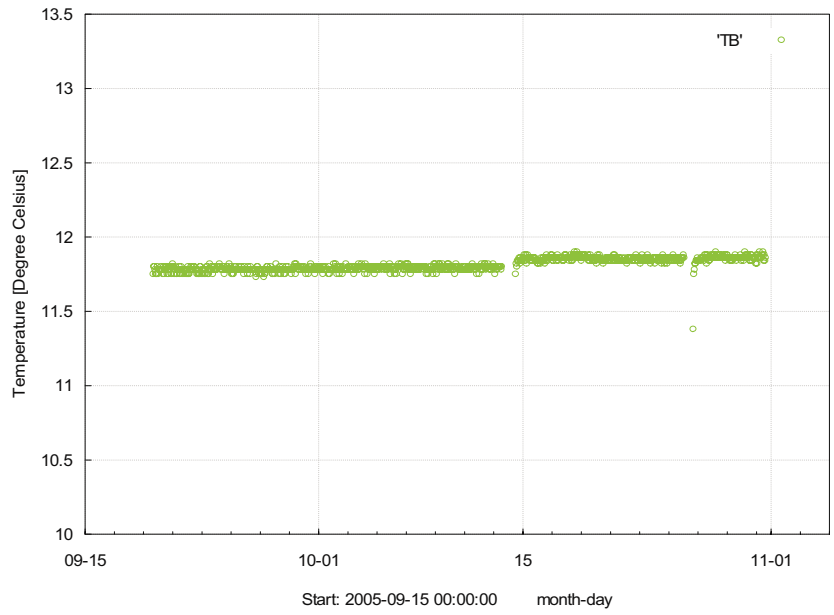

Figure A8-5. *Temperature of the groundwater in the borehole section (TB).*

Compilation of chemical data, June 2006

Table A9-1. Water Composition.

Idcode	Secup m	Seclow m	Sample no.	Sampling date	RCB (%)	Na mg/L	K mg/L	Ca mg/L	Mg mg/L	HCO ₃ ⁻ mg/L	Cl ⁻ mg/L	SO ₄ ²⁻ mg/L	SO ₄ -S mg/L	Br mg/L	F ⁻ mg/L	Si mg/L	Fe mg/L	Fe-tot mg/L	Fell mg/L
KFM08A	683.50	690.64	8963	2005-09-13	-0.04	1,510	9.59	2,200	12.5	9.78	6,190	91.1	30.9	55.4	1.31	4.82	0.371	0.147	0.129
KFM08A	683.50	690.64	8965	2005-09-20	-0.63	1,510	9.99	2,150	12.6	9.47	6,180	90.5	30.1	49.8	1.33	4.50	0.086	0.022	0.001
KFM08A	683.50	690.64	8967	2005-09-23	0.12	1,520	10.2	2,150	13.2	11.0	6,100	88.6	30.3	55.0	1.29	4.74	< 0.2	0.143	0.140
KFM08A	683.50	690.64	8968	2005-09-26	0.35	1,500	10.2	2,130	13.5	11.8	6,010	89.0	30.5	46.3	1.32	4.84	0.208	0.127	0.121
KFM08A	683.50	690.64	8969	2005-09-29	0.17	1,500	10.4	2,160	14.0	12.4	6,080	89.8	31.4	55.5	1.26	4.98	< 0.2	0.199	0.175
KFM08A	683.50	690.64	8978	2005-10-03	0.30	1,500	10.1	2,160	14.0	10.8	6,070	92.9	30.7	45.2	1.31	4.96	0.214	0.217	0.207
KFM08A	683.50	690.64	8985	2005-10-06	-0.73	1,490	10.3	2,150	14.3	10.6	6,160	93.1	31.1	57.3	1.33	4.99	0.210	0.235	0.230
KFM08A	683.50	690.64	8987	2005-10-10	0.09	1,520	10.3	2,140	14.3	12.3	6,090	91.1	31.0	48.3	1.31	5.04	0.289	0.265	0.256
KFM08A	683.50	690.64	8988	2005-10-13	0.25	1,520	10.5	2,170	14.5	11.7	6,120	90.1	31.6	54.3	1.34	5.08	0.250	0.288	0.270
KFM08A	683.50	690.79	8989	2005-10-17	-0.45	1,470	9.96	2,110	14.4	10.4	6,030	94.1	30.2	44.6	1.24	4.94	0.506	0.502	0.498
KFM08A	683.50	690.79	8990	2005-10-20	-0.18	1,520	10.0	2,150	14.6	10.6	6,140	92.0	31.2	54.0	1.26	5.06	0.355	0.437	0.438
KFM08A	683.50	690.64	8991	2005-10-27	-0.26	1,560	10.6	2,130	14.1	13.0	6,170	86.2	35.0	44.9	1.25	4.99	0.456	0.514	0.509
KFM08A	683.50	690.64	12000	2005-10-13	-0.21	1,560	10.6	2,090	14.1	10.4	6,100	91.5	32.5	44.5	1.20	5.21	0.676	0.724	0.726

- = Not analysed

A = Results will be reported later

x = No result due to sampling problems

xx = No result due to analytical problems

< value = below reporting limit

RCB (%) = Rel. charge balance error %

SICADA: water_composition.

Idcode	Secup m	Seclow m	Sample no.	Mn mg/L	Li mg/L	Sr mg/L	I- mg/L	pH	DOC mg/L	HS- mg/L	Drill_water %	EICond mS/m	NH ₄ N mg/L	P mg/L
KFM08A	683.50	690.64	8963	0.219	< 0.040	25.3	-	6.73	1.2	0.010	4.8	1,700	0.0884	-
KFM08A	683.50	690.64	8965	0.206	< 0.040	25.2	0.256	7.21	1.0	xx	4.3	1,710	0.0884	0.010
KFM08A	683.50	690.64	8967	0.182	< 0.040	25.3	-	7.61	<1.0	0.011	4.7	1,690	0.0936	-
KFM08A	683.50	690.64	8968	0.188	< 0.040	24.8	0.230	7.67	<1.0	0.011	5.0	1,700	0.0960	< 0.005
KFM08A	683.50	690.64	8969	0.179	< 0.040	24.9	-	7.60	<1.0	-0.002	4.8	1,700	0.0970	-
KFM08A	683.50	690.64	8978	0.185	< 0.040	24.4	0.228	7.75	<1.0	0.009	5.0	1,690	0.0974	< 0.005
KFM08A	683.50	690.64	8985	0.180	< 0.040	24.4	-	7.85	<1.0	0.011	5.1	1,700	0.0934	-
KFM08A	683.50	690.64	8987	0.190	< 0.040	24.6	0.247	7.84	<1.0	0.015	5.1	1,690	0.0992	< 0.005
KFM08A	683.50	690.64	8988	0.182	< 0.040	24.8	-	7.46	<1.0	0.006	5.2	1,700	0.0936	-
KFM08A	683.50	690.79	8989	0.198	< 0.040	23.7	0.231	7.50	<1.0	0.006	5.2	1,690	0.1010	< 0.005
KFM08A	683.50	690.79	8990	0.184	< 0.040	24.7	-	7.75	<1.0	0.009	5.2	1,700	0.0963	-
KFM08A	683.50	690.64	8991	0.248	0.022	23.7	0.235	7.22	2.6	0.006	5.4	1,700	0.0894	< 0.005
KFM08A	683.50	690.64	12000	0.191	0.021	23.3	0.236	7.79	<1.0	0.012	5.1	1,690	0.1020	< 0.005

- = Not analysed

A = Results will be reported later

x = No result due to sampling problems

xx = No result due to analytical problems

< value = below reporting limit

RCB (%) = Rel. charge balance error %

SICADA: water_composition.

Table A9-2. Isotopes I (H-, O-, B-, S-, Cl- and C-isotopes).

Idcode	Secup m	Seclow m	Sample no	Sampling date	$\delta^2\text{H}$ ‰ SMOW	^3H TU	$\delta^{18}\text{O}$ ‰ SMOW	$^{10}\text{B}^{11}\text{B}$ no unit	$\delta^{34}\text{S}$ ‰ CDT	$\delta^{13}\text{C}$ ‰ PDB	$^{87}\text{Sr}^{86}\text{Sr}$ no unit	^{14}C pmC	$\delta^{37}\text{Cl}$ ‰ SMOC
KFM08A	690.64	690.64	8963	2005-09-13	-95.3	2.6	-13.2	-	-	-	-	-	-
KFM08A	690.64	690.64	8965	2005-09-20	-95.8	< 0.8	-13.3	0.2355	30.9	-	0.717887	-	0.03
KFM08A	690.64	690.64	8967	2005-09-23	-95.6	< 0.8	-13.4	-	-	-	-	-	-
KFM08A	690.64	690.64	8968	2005-09-26	-96.2	< 0.8	-13.2	0.2359	30.8	-	0.717967	-	-0.01
KFM08A	690.64	690.64	8969	2005-09-29	-96.8	0.8	-13.6	-	-	-	-	-	-
KFM08A	690.64	690.64	8978	2005-10-03	-96.0	0.9	-13.2	0.2364	31.2	-	0.717912	-	-0.01
KFM08A	690.64	690.64	8985	2005-10-06	-96.0	< 0.8	-13.3	-	-	-	-	-	-
KFM08A	690.64	690.64	8987	2005-10-10	-96.0	< 0.8	-13.2	0.2371	31.1	-	0.717842	-	-0.06
KFM08A	690.64	690.64	8988	2005-10-13	-94.4	< 0.8	-13.2	-	-	-	-	-	-
KFM08A	690.79	690.79	8989	2005-10-10	-93.9	< 0.8	-13.2	0.2359	31.5	-	0.717900	-	-0.09
KFM08A	690.79	690.79	8990	2005-10-20	-93.8	< 0.8	-13.2	-	-	-	-	-	-
KFM08A	690.79	690.64	8991	2005-10-27	-93.0	< 0.8	-13.3	0.2377	27.8	-	0.717886	-	0.16
KFM08A	690.79	690.64	12000	2005-10-31	-92.9	< 0.8	-13.2	0.2375	29.1	xx	0.717898	xx	0.03

- = Not analysed

A = Results will be reported later

x = No result due to sampling problems

xx = No result due to analytical problems

< value = below reporting limit

SICADA: Isotopes I.

Table A9-3. Trace elements.

Idcode	Secup m	Seclow m	Sample no.	Sampling date	Al ug/L	B ug/L	Ba ug/L	U ug/L	Th ug/L	Sc ug/L	Rb ug/L	Y ug/L	Zr ug/L	In ug/L	Sb ug/L	Cs ug/L	La ug/L	Hf ug/L	Ti ug/L
KFM08A	683.50	690.64	8965	2005-09-20	579	767	374	4.86	< 0.2	< 0.4	30.7	0.27	0.553	< 0.2	0.565	0.592	0.0752	< 0.02	< 0.03
KFM08A	683.50	690.64	8968	2005-09-26	347	744	349	6.75	< 0.2	< 0.4	30.7	0.206	0.430	< 0.2	0.554	0.566	0.0435	< 0.02	< 0.03
KFM08A	683.50	690.64	8978	2005-10-03	23.6	721	345	7.42	< 0.2	< 0.4	30.1	0.129	< 0.1	< 0.2	0.558	0.546	< 0.02	< 0.02	< 0.03
KFM08A	683.50	690.64	8987	2005-10-10	38.9	715	357	8.50	< 0.2	< 0.4	31.8	0.144	0.108	< 0.2	0.617	0.607	< 0.02	< 0.02	< 0.03
KFM08A	683.50	690.79	8989	2005-10-10	21.8	702	362	8.90	< 0.2	< 0.4	33.0	0.150	< 0.1	< 0.2	0.528	0.609	< 0.02	< 0.02	< 0.03
KFM08A	683.50	690.64	8991	2005-10-27	15.6	734	386	9.67	< 0.2	< 0.4	33.1	0.163	< 0.1	< 0.2	0.460	0.632	< 0.02	< 0.02	< 0.03
KFM08A	683.50	690.64	12000	2005-10-31	14.4	725	365	6.35	< 0.2	< 0.4	31.3	0.174	< 0.1	< 0.2	0.490	0.646	< 0.02	< 0.02	< 0.03

Idcode	Secup m	Seclow m	Sample no.	Sampling date	Ce ug/L	Pr ug/L	Nd ug/L	Sm ug/L	Eu ug/L	Gd ug/L	Tb ug/L	Dy ug/L	Ho ug/L	Er ug/L	Tm ug/L	Yb ug/L	Lu ug/L
KFM08A	683.50	690.64	8965	2005-09-20	0.153	< 0.02	0.061	< 0.02	< 0.02	< 0.02	< 0.02	< 0.02	< 0.02	< 0.02	< 0.02	< 0.02	< 0.02
KFM08A	683.50	690.64	8968	2005-09-26	0.088	< 0.02	< 0.02	< 0.02	< 0.02	< 0.02	< 0.02	< 0.02	< 0.02	< 0.02	< 0.02	< 0.02	< 0.02
KFM08A	683.50	690.64	8978	2005-10-03	< 0.02	< 0.02	< 0.02	< 0.02	< 0.02	< 0.02	< 0.02	< 0.02	< 0.02	< 0.02	< 0.02	< 0.02	< 0.02
KFM08A	683.50	690.64	8987	2005-10-10	< 0.02	< 0.02	< 0.02	< 0.02	< 0.02	< 0.02	< 0.02	< 0.02	< 0.02	< 0.02	< 0.02	< 0.02	< 0.02
KFM08A	683.50	690.79	8989	2005-10-10	< 0.02	< 0.02	< 0.02	< 0.02	< 0.02	< 0.02	< 0.02	< 0.02	< 0.02	< 0.02	< 0.02	< 0.02	< 0.02
KFM08A	683.50	690.64	8991	2005-10-27	< 0.02	< 0.02	< 0.02	< 0.02	< 0.02	< 0.02	< 0.02	< 0.02	< 0.02	< 0.02	< 0.02	< 0.02	< 0.02
KFM08A	683.50	690.64	12000	2005-10-31	< 0.02	< 0.02	< 0.02	< 0.02	< 0.02	< 0.02	< 0.02	< 0.02	< 0.02	< 0.02	< 0.02	< 0.02	< 0.02

- = Not analysed

A = Results will be reported later

x = No result due to sampling problems

xx = No result due to analytical problems

< value = below reporting limit

SICADA: trace_elements

Table A9-4. Isotopes II (U-, Th, Ra- and Rn-isotopes).

Idcode	Secup m	Seclow m	Sample no.	Sampling date	²³⁸ U mBq/L	²³⁵ U mBq/L	²³⁴ U mBq/L	²³² Th mBq/L	²³⁰ Th mBq/L	²²⁶ Ra Bq/L	²²² Rn Bq/L
KFM08A	683.50	690.64	12000	2005-10-31	93.6	<50	196	< 50	0.3	6.8	224

- = Not analysed

A = Results will be reported later

x = No result due to sampling problems

xx = No result due to analytical problems

< value = below reporting limit

SICADA: u_th_isotope_t, ra_rn_isotope_t

Table A9-5. Dissolved gases.

Idcode	Secup m	Seclow m	Sample no.	Sampling date	Ar mL/L	He mL/L	N ₂ mL/L	CO ₂ mL/L	CH ₄ mL/L	O ₂ mL/L	H ₂ µL/L	CO µL/L	C ₂ H ₆ µL/L	C ₂ H ₄ µL/L	C ₂ H ₂ µL/L	C ₃ H ₈ µL/L	C ₃ H ₆ µL/L	DISS_GAS mL/L H ₂ O
KFM08A	683.50	690.64	12000	2005-11-01	1.6	15	124	0.08	0.031	1.5	< 4.3	< 7.1	0.14	0.14	0.14	0.28	0.14	142

- = Not analysed

A = Results will be reported later

x = No result due to sampling problems

xx = No result due to analytical problems

< value = below reporting limit

SICADA: Dissolved_gases