

International
Progress Report

IPR-06-04

Äspö Hard Rock Laboratory

Temperature Buffer Test

Sensors data report
(Period 030326-060101)
Report No:7

Reza Goudarzi
Mattias Åkesson
Harald Hökmark

Clay Technology AB

January 2005

Svensk Kärnbränslehantering AB

Swedish Nuclear Fuel
and Waste Management Co
Box 5864
SE-102 40 Stockholm Sweden
Tel 08-459 84 00
+46 8 459 84 00
Fax 08-661 57 19
+46 8 661 57 19



**Äspö Hard Rock
Laboratory**

Report no.
IPR-06-04

Author
Reza Goudarzi
Mattias Åkesson
Harald Hökmark

Checked by
Bertrand Vignal

Approved
Anders Sjöland

No.
F12K
Date
January 2005

Date
2006-03-09

Date
2006-03-22

Äspö Hard Rock Laboratory

Temperature Buffer Test

Sensors data report (Period 030326-060101) Report No:7

Reza Goudarzi
Mattias Åkesson
Harald Hökmark

Clay Technology AB

January 2005

Keywords: Field test, Data, Repository, Bentonite, Rock, Canister, Measurements, Water pressure, Total pressure, Relative humidity, Temperature, Displacements

This report concerns a study which was conducted for SKB. The conclusions and viewpoints presented in the report are those of the author(s) and do not necessarily coincide with those of the client.

Résumé

TBT (Test de Barrière ouvragée en Température) est un projet mené par SKB et l'ANDRA, soutenue par ENRESA et DBE qui vise à comprendre et modéliser le comportement thermo-hydro-mécanique de barrières ouvragées à base d'argile gonflante soumises à des températures élevées ($> 100^{\circ}\text{C}$).

L'essai est conduit dans le HRL d'Äspö dans une alvéole de 8 m de profondeur et 1,75 m de diamètre. Deux sondes chauffantes (chacune de 3 m de long et 0,6 m de diamètre) sont entourés d'argile gonflante, de bentonite, laquelle est confinée par un bouchon ancré sur 9 câbles. L'essai fonctionne depuis le printemps 2003. Les sondes sont chauffées chacune à la puissance nominale de 1500 W. Un système d'alimentation artificiel par filtre de sable fournit de l'eau sous 600 kPa de pression.

Ce rapport présente les données de TBT enregistrées depuis son début le 26 mars 2003 jusqu'au premier janvier 2006.

Dans la bentonite la pression totale est mesurée en 29 points, la pression de pore en 8 points et l'humidité relative en 35 points. La température est mesurée en 92 points et l'est aussi à l'emplacement de chaque capteur dont la mesure nécessite d'être compensée en température.

Des mesures additionnelles sont faites : température en 40 points dans la roche alentour, en 11 points à la surface et 6 à l'intérieur des sondes. La force de confinement est mesurée sur trois des neuf câbles. Le déplacement vertical du bouchon est mesuré en trois points. Le débit et la pression d'eau fournie au système sont également mesurés.

Globalement, le système de mesure et de transmission des données fonctionne bien et l'essentiel des capteurs fournissent des valeurs fiables. La seule exception concerne la mesure d'humidité relative au droit de la sonde inférieure où plusieurs capteurs ne fonctionnent plus.

La température maximale mesurée sur la sonde inférieure est de 136°C et de 143°C sur la supérieure. Une forte hydratation ($\text{RH} > 90\%$) et des pressions de gonflement élevées (de 3 à 9 MPa) sont observées sur quelques 25 cm d'épaisseur en périphérie de la barrière ouvragée, sauf pour les bloc d'argile placés entre la sonde supérieure et le bouchon.

En plus de l'eau de remplissage initial du filtre de sable, plus de 100 % de l'eau théoriquement nécessaire à la saturation de la bentonite a été injectée. La pression nécessaire pour maintenir le débit d'injection indique une augmentation de la résistance hydraulique. Probablement à cause d'un colmatage des embouts des tubes d'injection.

La baisse de la pression totale et la hausse de la succion observées autour de la sonde d'en haut est interprétée comme due à un manque d'approvisionnement en eau de la partie supérieure du filtre de sable. Début avril 2004 le filtre a été rempli et mis en pression aussi par les injecteurs supérieurs provoquant dans la bentonite un accroissement soudain de la pression totale et une reprise de la décroissance de la succion.

La densité des dispositifs de mesure de température par thermocouples à mi-hauteur de chaque sonde chauffante se révèle utile pour observer de façon qualitative les cycles saturation - désaturation. Dans la section du bas des indications claires de désaturation sont apparues très tôt dans l'expérience sur une zone annulaire de 0.15 m autour de la sonde chauffante. Cette partie se resature lentement à l'heure actuelle.

Abstract

TBT (Temperature Buffer Test) is a joint project between SKB/ANDRA and supported by ENRESA (modelling) and DBE (optical sensors), which aims at understanding and modelling the thermo-hydro-mechanical behaviour of buffers made of swelling clay submitted to high temperatures (over 100°C) during the water saturation process.

The test is carried out in Äspö HRL in a 8 meters deep and 1.75 m diameter deposition hole, with two canisters (3 m long, 0.6 m diameter), surrounded by a bentonite buffer and a confining plug on top anchored with 9 rods. It was installed during spring 2003. The canisters are heated with 1500 W power and an artificial wetting is in progress, at present with a water pressure of 600 kPa.

This report presents data from the measurements in the Temperature Buffer Test from 030326 to 060101 (26 March 2003 to 01 January 2006).

The following measurements are made in the bentonite: Temperature is measured in 92 points, total pressure in 29 points, pore water pressure in 8 points and relative humidity in 35 points. Temperature is also measured by all gauges as an auxiliary measurement used for compensation.

The following additional measurements are done: Temperature is measured in 40 points in the rock, in 11 points on the surface of each canister and in 6 points inside each canister. The force on the confining plug is measured in 3 of the 9 rods and its vertical displacement is measured in three points. The water inflow and water pressure in the outer sand filter is also measured.

A general conclusion is that the measuring systems and transducers work well and almost all sensors deliver reliable values. The only exception is the Relative Humidity sensors in the high temperature area around the lower canister, where several sensors have failed.

The highest temperature measured on the canister surfaces is 136 °C on the lower canister and 143 °C on the upper. Strong wetting with measured high RH (>90%) and high swelling pressure (3-9 MPa) has reached about 25 cm into the buffer everywhere with exception of the top blocks between the plug and heater 2.

Over 100% of the water theoretically needed to saturate the bentonite has been injected, in addition to the water needed to fill up the outer sand slot. The sand slot injection pressure required to maintain the inflow indicates that some change in the flow resistance of the filter/sand system has taken place. This is probably a result of clogging of the filter tips.

The decrease in total pressure and increase in suction that was recorded around the upper canister was interpreted to be caused by lack of water supply in the upper part of the sand filter. In the beginning of April 2004 the sand filter was water filled and pressurised also from above. The result of this change was that the total pressure increased and the suction decreased again.

The dense arrays of thermocouples at the mid-height of the two heaters appear to be useful for examining the dehydration/hydration process qualitatively. In the lower section there are clear signs of early dehydration in a 0.15 m annular zone around the heater. Resaturation of this part is now slowly in progress.

Sammanfattning

TBT (Temperature Buffer Test) är ett gemensamt SKB/ANDRA projekt med deltagande av ENRESA (modellering) och DBE (optiska mätinstrument), syftet är att öka förståelsen för de termiska, hydrauliska och mekaniska processerna i en buffert gjord av svällande lera som utsätts för höga temperaturer (över 100 °C) under vattenmättnadsfasen och kunna modellera dessa processer.

Försöket görs på 420-metersnivån i Äspö HRL i ett 8 m djupt deponeringshål med diametern 1,75 m, där två kapslar, omgivande bentonitbuffert och en ovanliggande plugg, som förankrats med 9 stag, installerades våren 2003. Kapslarna värms med en effekt på 1500 W och konstgjord bevätning i sandfiltret pågår, för närvarande med vattentrycket 600 kPa.

I denna rapport presenteras data från mätningar i TBT under perioden 030326-060101.

Följande mätningar görs i bentoniten: Temperaturen mäts i 92 punkter, totaltryck i 29 punkter, porvattentryck i 8 punkter och relativa fuktigheten i 35 punkter. Temperaturen mäts även i alla relativa fuktighetsmätare, för att kompensera för temperaturens inverkan på mätresultaten.

Följande övriga mätningar görs: Temperaturen mäts i 40 punkter i berget, i 11 punkter på ytan av varje kapsel och i 6 punkter inne varje kapsel. Kraften på den ovanliggande pluggen mäts i 3 av de 9 stagen och vertikala förskjutningen av pluggen mäts i tre punkter. Vatteninflödet och vattentrycket i den yttre sandfyllda spalten mäts också.

En generell slutsats är att mätsystemen och givarna fungera bra och i stort sett alla givare leverar pålitliga mätvärden. Enda undantaget är mätningarna av relativa fuktigheten i högttemperaturområdet runt den undre kapseln, där ett flertal givare inte fungerar.

Högsta temperaturen som mäts på kapselytorna är 136 °C på nedre kapseln respektive 143 °C på övre. Stark bevätning med mätta höga RH (>90%) och höga svälltryck (3-9 MPa) har nått cirka 25 cm in i bufferten överallt utom i de översta blocken mellan pluggen och kapsel 2.

Över 100 % av den teoretisk vattenmängd som behövs för att vattenmätta bentoniten har nu tillförts, förutom den mängd vatten som har behövts för att fylla upp den yttre sandspalten. Det injekteringstryck i sandspalten som fordras för att upprätthålla inflödet tyder på att en förändring av flödesmotståndet i systemet filter/sandspalt har ägt rum. Detta beror sannolikt på en igensättning av filterspetsarna.

Den sänkning av totaltrycket och höjning av buffertens inre undertryck som noterats runt den översta kapseln har tolkats bero på brist på vattentillgång i övre delen av sandfiltret. I början på april 2004 vattenfylldes och trycksattes sandfiltret även ovanifrån. Resultatet av denna förändring var att totaltrycket åter höjdes och buffertens inre undertryck minskade.

De täta linjerna av termoelement vid de två värmarnas höjdcentrum visar sig vara användbara för att undersöka torkning/mättnadsprocessen kvalitativt. I den undersektionen finns det tydliga tecken på uttorkning inom ett avstånd av 0,15 m från värmarytan. En långsam återmättnad av denna zon pågår nu.

Contents

1	Introduction	11
2	Comments	13
2.1	General	13
2.2	Total pressure, Geokon (App. A, pages 51-59)	14
2.3	Suction, Wescore Psychrometers (App. A, pages 60-64)	15
2.4	Relative humidity, Vaisala and Rotronic (App. A, pages 65-70)	15
2.5	Pore water pressure, Geokon (App. A, pages 71-72)	15
2.6	Water flow and water pressure in the sand (App. A, pages 73-74)	16
2.7	Forces on the plug (App. A, page 75)	16
2.8	Displacement of the plug (App. A, page 76)	16
2.9	Canister power (App. A, page 77-78)	17
2.10	Temperature in the buffer (App. A, pages 79-84)	17
2.11	Temperature in the rock (App. A, pages 85-88)	17
2.12	Temperature on the canister surface (App. A, pages 89-90)	18
2.13	Temperature inside the canister (App. A, pages 91-92)	18
3	Coordinate system	19
4	Location of instruments	21
4.1	Brief description of the instruments	21
	Measurements of temperature	21
	Measurement of total pressure in the buffer	21
	Measurement of pore water pressure in the buffer	21
	Measurement of the water saturation process	21
	Measurements of forces on the plug	22
	Measurements of plug displacement	22
	Measurement of water flow into the sand	22
4.2	Strategy for describing the position of each device	22
4.3	Position of each instrument in the bentonite	23
4.4	Instruments in the rock	28
	Temperature measurements	28
4.5	Instruments in the canister	30
4.6	Instruments on the plug	32
5	Discussion of results	33
5.1	General	33
5.2	Total inflow of water	33
	Changes made during 2005-07-01 – 2006-01-01	35
5.3	Temperatures	36
	Influence from Canister Retrieval Test	37
	Thermal gradients and conductivities	39
5.4	Relative humidity/suction	42
5.5	Total pressure	44
	References	47
	Appendix A	49

1 Introduction

The installation of the Temperature Buffer Test was made during spring 2003 in Äspö Hard Rock Laboratory, Sweden.

The Temperature Buffer Test, TBT, is a full-scale experiment that ANDRA and SKB carry out at the SKB Äspö Hard Rock Laboratory. In addition ENRESA supports TBT with THM modelling and DBE has installed a number of optic pressure sensors.

The test aims at understanding and modelling the thermo-hydro-mechanical behaviour of buffers made of swelling clay submitted to high temperatures (over 100°C) during the water saturation process. No other full scales tests have been carried out with buffer temperatures exceeding 100°C so far.

The test consists of a full-scale KBS3 deposition hole, 2 steel canisters equipped with electrical heaters simulating the power of radioactive decay and a mechanical plug at the top. Figure 1-1 shows the layout and denomination of blocks and canisters. The canisters are embedded in dense clay buffer consisting of blocks (cylindrical and ring shaped) of compacted bentonite powder.

An artificial water pressure is applied in the outer slot between the buffer and the rock, which is filled with compacted sand and functions as a filter.

The upper canister is surrounded by sand in order to reduce the temperature in the bentonite.

The buffer material is instrumented with pressure cells (total and water pressure), thermocouples and moisture gauges. Thermocouples are also installed in the rock.

A retaining plug is built in order to confine the buffer swelling.

Measured results and general comments concerning the collected data are given in chapter 2. A test overview with the positions of the measuring points and a brief description of the instruments are presented in chapters 3 and 4. Finally analyses and discussions of the results are given in chapter 5.

In general the data in this report are presented in diagrams covering the time period 030326 to 060101¹. The time axis in the diagrams represents days from 030326. The diagrams are attached in Appendix A.

Results regarding the fibre optic sensing system are not available yet, as there are problems with calibration of these sensors.

¹ YYMMDD (Swedish way of expressing dates implying that the first two numbers are the year, the next two numbers are the month and the final two numbers are the date)

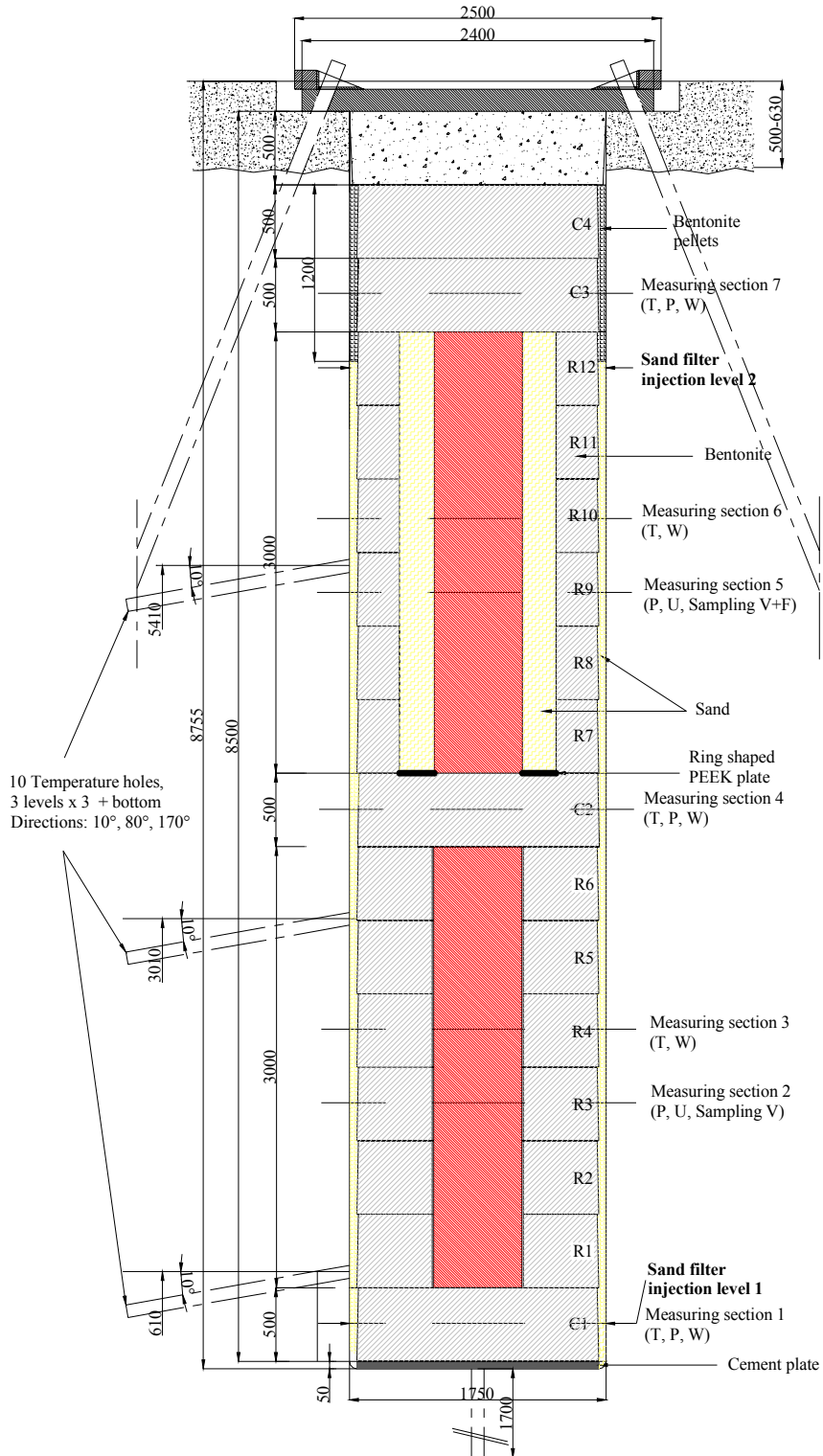

Figure I-1. Schematic view showing the layout of the experiment and the numbering of bentonite blocks. The lower heater is denominated No. 1 and the upper heater is No. 2.

2 Comments

2.1 General

In this chapter short comments on general trends in the measurements are given. Sensors that are not delivering reliable data or no data at all are noted and comments on the data in general are given but no evaluation or comparison with predictions will be given here.

The heating of both canisters started with an initially applied constant power of 900 W on 030326. This date is also marked as start date. The power was raised to 1200 W on 030403. The power was further raised to 1500 W on 030410. Several power failures have occurred. Important events and dates are shown in Table 2-1.

Table 2-1: Key dates for TBT

Activity	Date (time)	Day No.
900 W power applied	030326	0
Start water filling of filter	030327	1
1200 W power applied	030403	8
1500 W power applied	030410	15
Finished water filling	~030604	~70
Power failure heater 1	030423 (~20.00)-030424 (~10.00)	27-28
Power failure heater 1	030527 (~01.00)-030527 (~12.00)	62
Power failure heater 1	030603 (~12.00)-030603 (~14.00)	69
Power failure heater 1	030606 (~19.00)-030609 (~10.00)	72-75
Power failure heater 1	030612 (~12.00)-030612 (~14.00)	78
Power failure heaters 1 and 2	030923 (~12.00 ¹)-030923 (~18.00 ¹)	181
Power failure heaters 1 and 2	031028 (~18.00 ¹)-031029 (~11.00 ¹)	216
Injection pump replaced by gas tube	031104	223
Power failure heater 1	040120 (~16.00)-040120 (~19.00)	300
Power failure heater 2	040120 (~18.00)-040120 (~20.00)	300
Filling and pressurisation of the sand filter also through the upper tubes	040406	377
Flushing and pressurisation of filters through both upper and lower tubes (160 kPa)	040615-040616	448-449

Pressurisation of filters through both upper and lower tubes	041011-041014	565-568
Filling and pressurisation of the sand filter through AS205 and AS207	041014	568
Filling and pressurisation of the sand filter through AS201, AS202, AS204, AS205, AS206 and AS208	041110	595
Power failure heater 2	050629-050706	826-
50 w more power		833
Filling and pressurisation of the sand filter through AS201, AS203, AS204, AS205, AS207 and AS208	050728	856
Water filling of filter mats.	051209	989
Airvents AS212-AS215 closed.		
AS209 connected to artificial saturation.		
AS210 connected to artificial saturation.	051212	992

1) The duration of the power loss is not known since no data was recorded between the times noted.

The water filling was done through four tubes leading to the bottom of the sand filter. The filling was slow due to flow resistance in the sand and the rate was increased by pressurizing the water (see chapter 2.6). The filling was completed after 60-80 days. The water pressure in the bottom of the sand filter has been kept with periodical interruptions (see chapter 2.6) but the valves to the 4 upper tubes leading out water from the top of the sand filter have been open at all times until 040615.

On day 377 (040406) water was supplied to the sand filter also through the tubes leading to the top of the sand filter and a small pressure applied. On days 448-449 the filters were flushed and a water pressure of 160 kPa was applied on the sand filter through both the top tubes and the bottom tubes.

This report is the seventh one and covers the results up to 060101.

2.2 Total pressure, Geokon (App. A, pages 51-59)

The measured pressure ranges from 3.4 to 8.7 MPa. The start of the pressure increase takes place shortly after the water filling has reached the level of the different transducer.

Notable is that all transducers in ring 9 around heater 2 except the one at the rock are recording decreasing total pressure in a period between day ~230 and day ~370. The reason for this and other observations are discussed in chapter 5.

The pressure increase by sensor placed in Cyl.3 at 20051209 (day 989) due to water filling of the filter mats between Cyl.3 and Cyl.4.

Seven transducers are out of order.

2.3 Suction, Wescor Psychrometers (App. A, pages 60-64)

Wescor psychrometers are only working at suction below ~ 7000 kPa, which correspond to high relative humidity (higher than 95%).

Eleven transducers have started yielding interpretable values, which means that they are close to water saturation. Two of them have ceased functioning. Notable is that two transducers around heater 2 are yielding increasing suction (drying) during a period of about 80 days, which is consistent with the measured decrease in total pressure. On the other hand the suction of those transducers is again dropping in suction during the last 2 months, which is also in consistence with the total pressure observations.

WB233 placed in Cyl.3 has begun to react during this measuring period due to water injection to the mat between Cyl.3 and Cyl.4.

Two transducers (WB213 and WB220) are out of order.

2.4 Relative humidity, Vaisala and Rotronic (App. A, pages 65-70)

Relative humidity and temperature measured with Vaisala and Rotronic transducers are shown on pages 67-72. For most transducers RH starts to increase just after the filling of water has reached the sensor level. Only one sensor in the buffer shows an obvious reduction in RH, namely WB206, which is located in the high temperature zone close to the lower heater. Sensors WB221 and WB222 are located in the sand in contact with the bentonite rings 9 and 10. The high initial RH measured by WB221 may be caused by the free water in the sand that had the water content of about 1% from start.

WB206 indicate an increasing from 62% to 78% during this measuring period (from day 860).

8 of 23 sensors are presently out of order for other reasons than high degree of saturation. Four of them are placed in ring 4.

2.5 Pore water pressure, Geokon (App. A, pages 71-72)

Transducers UB208 and UB204 show pore water pressure about 0.25 MPa and 0.15 MPa in the end of this measuring period.

The other water pressure sensors yield pressure close to zero.

2.6 Water flow and water pressure in the sand (App. A, pages 73-74)

Water filling and measurement of water inflow into the sand started on 030327. The total inflow to the sand has since that date been 3219 litre. The total volume of voids in the sand filter was initially about 790 litres. The inflow rate has been in average about 2.15 l/day since day 110. The inflow rate has been in average about 2.1 l/day in the last six month.

There was also an outflow that started after completed filling since the valves from the top of the sand filter was kept open. The outflow stopped rather early and the total outflow of water has been 44 litres.

The water injection pressure upstream the filter tips is shown on page 76. The water pressure was increased to 800 – 900 kPa during the first 50 days and then kept “constant” until day ~370. However, problems with the water pump have lead to many interruptions in the applied pressure. At day 377 the water pressure was reduced in connection with the start of water supply also from the tubes leading to the top of the filter.

It should be noted that the actual water pressure in the sand filter is only measured at those injection points that are closed to the atmosphere and not pressurized, at present (2006-01-01) points AS202 and AS206.

2.7 Forces on the plug (App. A, page 75)

The forces on the plug have been measured since 030404. The total force is about 10530 kN at 060101. The influence of the additional water supply from the upper tubes after ~370 days is clearly seen.

During the first about 15 days the plug was only fixed with 3 rods. When the total force exceeded 1100 kN the rest of the 9 rods were fixed in a prescribed manner. This procedure took place 10-11 April 2003 that is 15-16 days after test start. From that time only every third anchor is measured and the results should thus be multiplied with 3. The diagram shows both the actual measurements and after multiplication with 3.

2.8 Displacement of the plug (App. A, page 76)

The three displacement gauges were placed and started to measure displacements from 030409 (day 14) (except for zero reading that was done day 0). One of them (DP201) did not work well and was replaced on 030923 with a new transducer.

Transducer DP203 did not work well during this measuring period.

The measured displacements are in good agreement with the measured forces.

2.9 Canister power (App A, page 77-78)

The heating of both canisters started with an initially applied constant power of 900 W on 030326 and was raised to 1500 W according to Table 2-1. Only one out of three heaters in each canister is presently used (RAH1 and RAH2).

The failure in one of heater (RCH2) in canister 2 caused increasing of power with 50 W on 2005-06-29 to 2005-07-05.

2.10 Temperature in the buffer (App. A, pages 79-84)

Temperature is measured in a large number of points. The plotting of results is done so that the effect of wetting and cracking can be traced, since sensors placed close to each other are collected in the same diagrams.

The highest measured temperature in the bentonite is 134 °C by sensor TB215 located in the midplane of canister 1 at the distance 15 mm from the canister surface. The corresponding temperature on the canister surface is 136 °C, which shows that the temperature drop at the slot between the canister and the bentonite ring is very small.

Temperature is also measured (TB254, TB255 and TB256) in the sand around canister 2 (page 84), where the temperature drop is rather large (~2.5 °C/cm).

The increase in temperature with about one degree °C seen in the upper part of the buffer in the beginning of June (day ~435) is judged to be caused by the increase in tunnel air temperature that takes place in the summer (page 86).

On day ~335 three additional transducers (TB290, TB291 and TB292) placed in Ring 12 were connected to the data scanner and are reported on page 85. One of them was out of order from start.

9 of 92 transducers are out of order.

2.11 Temperature in the rock (App. A, pages 85-88)

The maximum temperature measured in the rock (71 degrees) is measured in the central section on the surface of the deposition hole. The deviation from axial symmetry of the temperature measured in the rock is caused by the influence from the heating of the neighbouring Canister Retrieval Test.

On October 11 (day 930) the power in Canister Retrieval Test was switched off.

2.12 Temperature on the canister surface (App. A, pages 89-90)

The maximum temperature measured on the surface of canister 1 is about 136 °C and on the surface of canister 2 about 143 °C on 060101. There are strong temperature differences in the canisters, both radial and axial. The highest measured difference on the surface is 23 °C on canister 1 and 36 °C on canister 2.

The steady increase in temperature of heater 1 has turned into a slow decrease. The temperature of heater 2 has decreased since day 50.

2.13 Temperature inside the canister (App. A, pages 91-92)

The maximum temperature measured inside canister 1 is about 160 °C and about 203 °C in canister 2 on 060101. However, the very high value 203 °C may be questioned since it deviates from all other values measured in canister 2. The other sensor at the same level (upper part of the canister) measures only about 169 °C, which is consistent with the other measurements in canister 2.

3 Coordinate system

Measurements are done in 7 measuring sections placed on different levels (see Figure 1-1). On each level, sensors are placed in eight main directions A, AB, B, BC, C, CD, D and DA according to Figure 3-1. Direction A and C are placed in the tunnels axial direction with A headed against the end of the tunnel i.e. almost to the South (see Figure 1-1, 3-1 and 4-1). The angle α is counted anti-clockwise from direction A. The z-coordinate is counted from the bottom of the deposition hole (the cement base).

The bentonite blocks are called cylinders and rings. The cylinders are numbered C1-C4 and the rings R1-R12 respectively (see Figure 1-1).

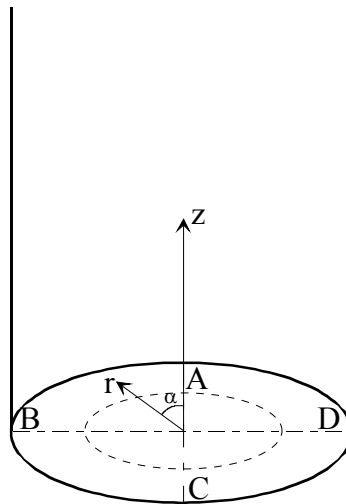

Figure 3-1 Figure describing the coordinate system used when determining the instrument positions.

4 Location of instruments

4.1 Brief description of the instruments

The different instruments that are used in the experiment are briefly described in this chapter. For additional information, see /4-1/.

Measurements of temperature

Buffer

Thermocouples from Pentronic have been installed for measuring temperature in the buffer. Measurements are done in 92 points in the test hole. In addition, temperature gauges are built in into the capacitive relative humidity sensors (23 sensors) as well as in the pressure gauges of vibrating wire type (37 gauges). Temperature is also measured in the psychrometers.

Canister

Temperature is measured in 11 points on the surface of the each canister. Temperature is also measured in each canister insert in 6 points.

Rock

Temperature in the rock and on the rock surface of the hole is measured in 40 points with thermocouples from Pentronic.

Measurement of total pressure in the buffer

Total pressure is the sum of the swelling pressure and the pore water pressure. It is measured with Geokon total pressure cells with vibrating wire transducers. 29 cells of this type have been installed.

Measurement of pore water pressure in the buffer

Pore water pressure is measured with Geokon pore pressure cells with vibrating wire transducer. 8 cells of this type have been installed.

Measurement of the water saturation process

The water saturation process is recorded by measuring the relative humidity in the pore system, which can be converted into water ratio or total suction (negative water pressure). The following techniques and devices are used:

- Vaisala relative humidity sensor of capacitive type. 29 cells of this type have been installed. The measuring range is 0-100 % RH.
- Wescor psychrometers measure the dry and the wet temperature in the pore system. The measuring range is 95.5-99.6 % RH corresponding to the pore water pressure -0.5 to -6MPa. 12 cells of this type have been installed.

Measurements of forces on the plug

The force on the plug caused by the swelling pressure of the bentonite is measured in 3 of the 9 anchors. The force transducers are of the type GLÖTZL.

Measurements of plug displacement

Due to straining of the anchors the swelling pressure of the bentonite will cause not only a force on the plug but also displacement of the plug. The displacement is measured in three points with transducers of the type LVDT with the range 0 – 50 mm.

Measurement of water flow into the sand

An artificial water pressure is applied in the outer slot, which is filled with sand. Titanium tubes equipped with filter tips are placed in the sand on two levels, 250 mm and 6750 mm from bottom (four at each level).

4.2 Strategy for describing the position of each device

Every instrument is named with a unique name consisting of 1 letter describing the type of measurement, (T-Temperature, P-Total Pressure, U-Pore Pressure, W-Relative Humidity, C-Chemical sampling, D-Displacement and A-Artificial water), 1 letter describing where the measurement takes place (B-Buffer, H-Heater, S-Sand, R-Rock and P-plug), 1 figure denoting the deposition hole (1 is used for the CRT test and 2 is used for this experiment), and 2 figures specifying the position in the buffer according to a separate list (see Table 4-1 to 4-7). Every instrument position is described with three coordinates according to Figure 3-1. The r-coordinate is the horizontal distance from the centre of the hole and the z-coordinate is the height from the bottom of the hole (the block height is set to 500mm). The coordinate is the angle from the vertical direction A (almost South).

The position of each instrument is described in the legend in the diagrams according to the following strategy:

Buffer: Three positions according to Figure 3-1: ($z \setminus \alpha \setminus r$) meaning (z -coordinate in m. from the bottom \ the angle α \ the radius in m.)

The cells measuring total pressure have been installed in three different directions in order to measure the radial stress (R), the axial stress (A) and the tangential stress (T). The direction of the pressure measurement is added in Table 4-2 and in the legend for each cell.

Rock: Three positions with the following meaning: (distance in meters from the bottom \ α according to Fig 3-1 \ distance in meters from the rock surface)

The bentonite blocks are called cylinders and rings. The cylinders are numbered C1-C4 and the rings R1-R12 respectively (Figure 1-1).

Canister: The denomination of the instruments in the canister differs a little from the other instruments. At first there are two letters and one figure describing the type of measurement and the place (TH for temperature and heater) and which heater (1 for lower heater and 2 for upper). Then there are again two letters describing if it is an external or internal sensor (SE or SI) and one figure describing the position on the canister (0-4 according to Figure 4-2). Finally the angle clockwise from direction A is written.

4.3 Position of each instrument in the bentonite

Measurements are done in 7 measuring sections placed on different levels (see Figure 1-1). On each level, sensors are placed in eight main directions A, AB, B, BC, C, CD, D and DA according to Figure 4-1. The bentonite blocks are called cylinders and rings. The cylinders are numbered C1-C4 and the rings R1-R12 respectively (see Figure 1-1).

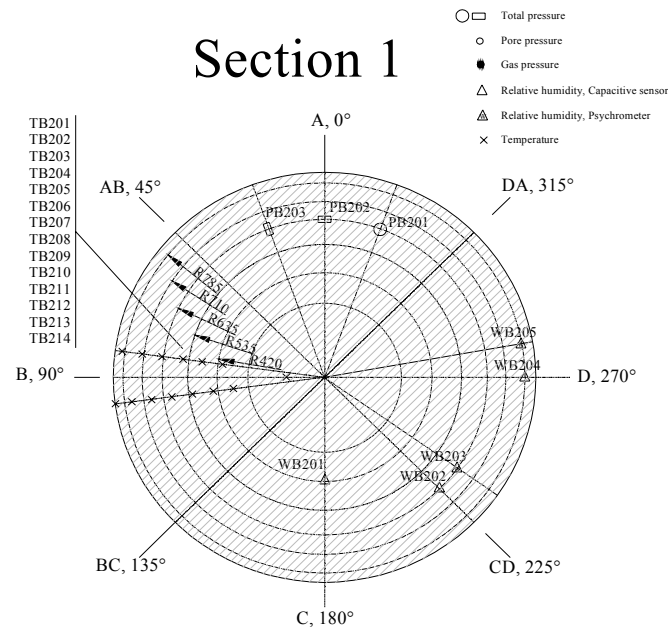

Figure 4-1 Schematic view, showing the main directions of the instrument positioning. The drawing shows the instrumentation in measuring section 1.

An overview of the positions of the instruments is shown in Fig 1-1 and 4-1. Exact positions are described in Tables 4-1 to 4-6. These tables have been updated since the last report and the measured exact position of the transducers have been inserted.

The instruments are located in three main levels in each instrumented block, the surface of the block (only total pressure cells measuring the horizontal pressure) and 50 mm and 250 mm from the upper block surface. The thermocouples and the total pressure cells are placed in the 50 mm level by practical reasons and the other sensors in the 250 mm level.

Table 4-1 Numbering and position of instruments for measuring temperature (T)

Type and number	Measuring section	Block	Instrument position in block				Instrument Fabricate
			Direction	α degree	r m	Z m	
TB201	1	Cyl. 1	B	90	0,150	0,452	Pentronic
TB202	1	Cyl. 1	B	95	0,360	0,452	Pentronic
TB203	1	Cyl. 1	B	85	0,400	0,452	Pentronic
TB204	1	Cyl. 1	B	95	0,440	0,452	Pentronic
TB205	1	Cyl. 1	B	85	0,480	0,452	Pentronic
TB206	1	Cyl. 1	B	95	0,520	0,452	Pentronic
TB207	1	Cyl. 1	B	85	0,560	0,452	Pentronic
TB208	1	Cyl. 1	B	95	0,600	0,452	Pentronic
TB209	1	Cyl. 1	B	85	0,640	0,452	Pentronic
TB210	1	Cyl. 1	B	95	0,680	0,452	Pentronic
TB211	1	Cyl. 1	B	85	0,720	0,452	Pentronic
TB212	1	Cyl. 1	B	95	0,760	0,452	Pentronic
TB213	1	Cyl. 1	B	85	0,800	0,452	Pentronic
TB214	1	Cyl. 1	B	95	0,840	0,452	Pentronic
TB215	3	Ring 4	B	97,5	0,320	2,469	Pentronic
TB216	3	Ring 4	B	82,5	0,360	2,469	Pentronic
TB217	3	Ring 4	B	97,5	0,390	2,469	Pentronic
TB218	3	Ring 4	B	92,5	0,420	2,469	Pentronic
TB219	3	Ring 4	B	87,5	0,435	2,469	Pentronic
TB220	3	Ring 4	B	82,5	0,450	2,469	Pentronic
TB221	3	Ring 4	B	97,5	0,465	2,469	Pentronic
TB222	3	Ring 4	B	92,5	0,480	2,469	Pentronic
TB223	3	Ring 4	B	87,5	0,495	2,469	Pentronic
TB224	3	Ring 4	B	82,5	0,510	2,469	Pentronic
TB225	3	Ring 4	B	97,5	0,525	2,469	Pentronic
TB226	3	Ring 4	B	92,5	0,540	2,469	Pentronic
TB227	3	Ring 4	B	87,5	0,555	2,469	Pentronic
TB228	3	Ring 4	B	82,5	0,570	2,469	Pentronic
TB229	3	Ring 4	B	97,5	0,585	2,469	Pentronic
TB230	3	Ring 4	B	92,5	0,600	2,469	Pentronic
TB231	3	Ring 4	B	87,5	0,615	2,469	Pentronic
TB232	3	Ring 4	B	82,5	0,630	2,469	Pentronic
TB233	3	Ring 4	B	97,5	0,645	2,469	Pentronic
TB234	3	Ring 4	B	92,5	0,660	2,469	Pentronic
TB235	3	Ring 4	B	87,5	0,690	2,469	Pentronic
TB236	3	Ring 4	B	92,5	0,720	2,469	Pentronic
TB237	3	Ring 4	B	87,5	0,750	2,469	Pentronic
TB238	3	Ring 4	B	92,5	0,780	2,469	Pentronic
TB239	3	Ring 4	B	87,5	0,810	2,469	Pentronic
TB240	4	Cyl. 2	B	90	0,150	3,983	Pentronic
TB241	4	Cyl. 2	B	95	0,360	3,983	Pentronic
TB242	4	Cyl. 2	B	85	0,400	3,983	Pentronic
TB243	4	Cyl. 2	B	95	0,440	3,983	Pentronic
TB244	4	Cyl. 2	B	85	0,480	3,983	Pentronic
TB245	4	Cyl. 2	B	95	0,520	3,983	Pentronic

Type and number	Measuring section	Block	Instrument position in block				Instrument Fabricate
			Direction	α degree	r m	Z m	
TB246	4	Cyl. 2	B	85	0,560	3,983	Pentronic
TB247	4	Cyl. 2	B	95	0,600	3,983	Pentronic
TB248	4	Cyl. 2	B	85	0,640	3,983	Pentronic
TB249	4	Cyl. 2	B	95	0,680	3,983	Pentronic
TB250	4	Cyl. 2	B	85	0,720	3,983	Pentronic
TB251	4	Cyl. 2	B	95	0,760	3,983	Pentronic
TB252	4	Cyl. 2	B	85	0,800	3,983	Pentronic
TB253	4	Cyl. 2	B	95	0,825	3,983	Pentronic
TB254	6	Ring 10	B	90	0,343	6,056	Pentronic
TB255	6	Ring 10	B	90	0,400	6,056	Pentronic
TB256	6	Ring 10	B	90	0,463	6,056	Pentronic
TB257	6	Ring 10	B	97,5	0,540	6,006	Pentronic
TB258	6	Ring 10	B	92,5	0,555	6,006	Pentronic
TB259	6	Ring 10	B	87,5	0,570	6,006	Pentronic
TB260	6	Ring 10	B	82,5	0,585	6,006	Pentronic
TB261	6	Ring 10	B	97,5	0,600	6,006	Pentronic
TB262	6	Ring 10	B	92,5	0,615	6,006	Pentronic
TB263	6	Ring 10	B	87,5	0,630	6,006	Pentronic
TB264	6	Ring 10	B	82,5	0,645	6,006	Pentronic
TB265	6	Ring 10	B	97,5	0,660	6,006	Pentronic
TB266	6	Ring 10	B	92,5	0,675	6,006	Pentronic
TB267	6	Ring 10	B	87,5	0,690	6,006	Pentronic
TB268	6	Ring 10	B	82,5	0,705	6,006	Pentronic
TB269	6	Ring 10	B	97,5	0,720	6,006	Pentronic
TB270	6	Ring 10	B	92,5	0,735	6,006	Pentronic
TB271	6	Ring 10	B	87,5	0,750	6,006	Pentronic
TB272	6	Ring 10	B	82,5	0,765	6,006	Pentronic
TB273	6	Ring 10	B	97,5	0,780	6,006	Pentronic
TB274	6	Ring 10	B	92,5	0,795	6,006	Pentronic
TB275	6	Ring 10	B	87,5	0,810	6,006	Pentronic
TB276	7	Cyl. 3	B	90	0,150	7,524	Pentronic
TB277	7	Cyl. 3	B	95	0,360	7,524	Pentronic
TB278	7	Cyl. 3	B	85	0,400	7,524	Pentronic
TB279	7	Cyl. 3	B	95	0,440	7,524	Pentronic
TB280	7	Cyl. 3	B	85	0,480	7,524	Pentronic
TB281	7	Cyl. 3	B	95	0,520	7,524	Pentronic
TB282	7	Cyl. 3	B	85	0,560	7,524	Pentronic
TB283	7	Cyl. 3	B	95	0,600	7,524	Pentronic
TB284	7	Cyl. 3	B	85	0,640	7,524	Pentronic
TB285	7	Cyl. 3	B	95	0,680	7,524	Pentronic
TB286	7	Cyl. 3	B	85	0,720	7,524	Pentronic
TB287	7	Cyl. 3	B	95	0,760	7,524	Pentronic
TB288	7	Cyl. 3	B	85	0,800	7,524	Pentronic
TB289	7	Cyl. 3	B	95	0,825	7,524	Pentronic
TB290		Ring 12	B	90	0,360	6,881	Pentronic
TB291		Ring 12	B	90	0,420	6,881	Pentronic
TB292		Ring 12	B	90	0,480	6,881	Pentronic

Table 4-2 Numbering and position of instruments measuring total pressure (P)

Type and number	Measuring section	Block	Instrument position in block				Instrument Fabricate	Direction of pressure measurement
			Direction	α degree	r m	Z m		
PB201	1	Cyl. 1	A	340	0,635	0,502	Geokon	Axial
PB202	1	Cyl. 1	A	0	0,635	0,452	Geokon	Radial
PB203	1	Cyl. 1	A	20	0,635	0,452	Geokon	Tangential
PB204	2	R3	D	250	0,420	1,968	Geokon	Radial
PB205	2	R3	D	290	0,420	2,018	Geokon	Axial
PB206	2	R3	A	8	0,535	1,968	Geokon	Radial
PB207	2	R3	A	20	0,535	1,968	Geokon	Tangential
PB208	2	R3	AB	45	0,585	2,018	Geokon	Axial
PB209	2	R3	B	100	0,635	1,968	Geokon	Tangential
PB210	2	R3	C	170	0,710	1,968	Geokon	Tangential
PB211	2	R3	C	180	0,710	1,968	Geokon	Radial
PB212	2	R3	D	260	0,748	2,018	Geokon	Axial
PB213	2	R3	D	270	0,875	1,950	Geokon	Radial on rock
PB214	4	Cyl. 2	A	340	0,635	4,033	Geokon	Axial
PB215	4	Cyl. 2	A	0	0,635	3,983	Geokon	Radial
PB216	4	Cyl. 2	A	20	0,635	3,983	Geokon	Tangential
PB217	5	Ring 9	D	270	0,535	5,319	Geokon	Radial, against sand
PB218	5	Ring 9	A	340	0,635	5,554	Geokon	Axial
PB219	5	Ring 9	A	0	0,635	5,504	Geokon	Radial
PB220	5	Ring 9	A	20	0,635	5,504	Geokon	Tangential
PB221	5	Ring 9	B	70	0,710	5,554	Geokon	Axial
PB222	5	Ring 9	B	110	0,710	5,504	Geokon	Radial
PB223	5	Ring 9	C	160	0,745	5,554	Geokon	Axial
PB224	5	Ring 9	C	180	0,770	5,504	Geokon	Radial
PB225	5	Ring 9	C	200	0,740	5,504	Geokon	Tangential
PB226	5	Ring 9	D	270	0,875	5,450	Geokon	Radial on rock
PB227	7	Cyl. 3	A	340	0,635	7,574	Geokon	Axial
PB228	7	Cyl. 3	A	0	0,635	7,524	Geokon	Radial
PB229	7	Cyl. 3	A	20	0,635	7,524	Geokon	Tangential
PB230	2	R3	C	180	0,315	1,968	DBE	Radial
PB231	5	R9	C	180	0,535	5,504	DBE	Radial

Table 4-3 Numbering and position of instruments measuring pore pressure (U)

Type and number	Measuring section	Block	Instrument position in block				Instrument Fabricate	Remark
			Direction	α degree	r m	Z m		
UB201	2	Ring 3	D	270	0,420	1,768	Geokon	
UB202	2	Ring 3	A	350	0,535	1,768	Geokon	
UB203	2	Ring 3	B	90	0,635	1,768	Geokon	
UB204	2	Ring 3	D	280	0,785	1,768	Geokon	
US205	5	Ring 9	D	270	0,510	5,304	Geokon	In sand
UB206	5	Ring 9	DA	315	0,635	5,304	Geokon	
UB207	5	Ring 9	B	90	0,710	5,304	Geokon	
UB208	5	Ring 9	CD	225	0,785	5,304	Geokon	
UB209	2	Ring 3	C	200	0,315	1,968	DBE	
UB210	5	Ring 9	C	150	0,510	5,304	DBE	

Table 4-4 Numbering and position of instruments measuring water content (W)

Type and number	Measuring section	Block	Instrument position in block			Instrument Fabricate	Remark	
			Direction	α degree	r m			Z m
WB201	1	Cyl.1	C	180	0,420	0,252	Rotronic	
WB202	1	Cyl.1	CD	225	0,635	0,252	Vaisala	
WB203	1	Cyl.1	CD	235	0,635	0,252	Wescor	
WB204	1	Cyl.1	D	270	0,785	0,252	Rotronic	
WB205	1	Cyl.1	D	280	0,785	0,252	Wescor	
WB206	3	Ring 4	BC	135	0,360	2,269	Vaisala	
WB207	3	Ring 4	C	180	0,420	2,269	Rotronic	
WB208	3	Ring 4	CD	225	0,485	2,269	Vaisala	
WB209	3	Ring 4	D	270	0,560	2,269	Rotronic	
WB210	3	Ring 4	DA	315	0,635	2,269	Vaisala	
WB211	3	Ring 4	DA	325	0,635	2,269	Wescor	
WB212	3	Ring 4	A	0	0,710	2,269	Rotronic	
WB213	3	Ring 4	A	10	0,710	2,269	Wescor	
WB214	3	Ring 4	AB	45	0,785	2,269	Vaisala	
WB215	3	Ring 4	AB	55	0,785	2,269	Wescor	
WB216	4	Cyl.2	C	180	0,420	3,783	Rotronic	
WB217	4	Cyl.2	CD	225	0,635	3,783	Vaisala	
WB218	4	Cyl.2	CD	235	0,635	3,783	Wescor	
WB219	4	Cyl.2	D	270	0,785	3,783	Rotronic	
WB220	4	Cyl.2	D	280	0,785	3,783	Wescor	
WS221	5	Ring 9	BC	135	0,525	5,304	Vaisala	In sand
WS222	6	Ring 10	BC	135	0,525	5,806	Vaisala	In sand
WB223	6	Ring 10	C	180	0,585	5,806	Rotronic	
WB224	6	Ring 10	CD	225	0,635	5,806	Vaisala	
WB225	6	Ring 10	D	270	0,685	5,806	Rotronic	
WB226	6	Ring 10	D	280	0,685	5,806	Wescor	
WB227	6	Ring 10	DA	315	0,735	5,806	Vaisala	
WB228	6	Ring 10	DA	325	0,735	5,806	Wescor	
WB229	6	Ring 10	A	0	0,785	5,806	Rotronic	
WB230	6	Ring 10	A	10	0,785	5,806	Wescor	
WB231	7	Cyl.3	C	180	0,420	7,374	Rotronic	
WB232	7	Cyl.3	CD	225	0,635	7,374	Vaisala	
WB233	7	Cyl.3	CD	235	0,635	7,374	Wescor	
WB234	7	Cyl.3	D	270	0,785	7,374	Rotronic	
WB235	7	Cyl.3	D	280	0,785	7,374	Wescor	

4.4 Instruments in the rock

Temperature measurements

40 thermocouples are located in ten boreholes in the rock (see Figure 1-1). The depth of each borehole is 1.5 m. In each borehole 4 thermocouples are placed at different distances from the rock surface. Observe that the coordinate system does not count the radius but the radial distance from the rock surface of the deposition hole. The position of each instrument is described in Table 4-5.

Table 4-5 Numbering and positions of thermocouples in the rock

Mark	Level	Direction	Distance from rock surface	Instrument Fabricate
	m	degree	m	
TR201	0	Center	0,000	Pentronic
TR202	0	Center	0,375	Pentronic
TR203	0	Center	0,750	Pentronic
TR204	0	Center	1,500	Pentronic
TR205	0,61	10°	0,000	Pentronic
TR206	0,61	10°	0,375	Pentronic
TR207	0,61	10°	0,750	Pentronic
TR208	0,61	10°	1,500	Pentronic
TR209	0,61	80°	0,000	Pentronic
TR210	0,61	80°	0,375	Pentronic
TR211	0,61	80°	0,750	Pentronic
TR212	0,61	80°	1,500	Pentronic
TR213	0,61	170°	0,000	Pentronic
TR214	0,61	170°	0,375	Pentronic
TR215	0,61	170°	0,750	Pentronic
TR216	0,61	170°	1,500	Pentronic
TR217	3,01	10°	0,000	Pentronic
TR218	3,01	10°	0,375	Pentronic
TR219	3,01	10°	0,750	Pentronic
TR220	3,01	10°	1,500	Pentronic
TR221	3,01	80°	0,000	Pentronic
TR222	3,01	80°	0,375	Pentronic
TR223	3,01	80°	0,750	Pentronic
TR224	3,01	80°	1,500	Pentronic
TR225	3,01	170°	0,000	Pentronic
TR226	3,01	170°	0,375	Pentronic
TR227	3,01	170°	0,750	Pentronic
TR228	3,01	170°	1,500	Pentronic
TR229	5,41	10°	0,000	Pentronic
TR230	5,41	10°	0,375	Pentronic
TR231	5,41	10°	0,750	Pentronic
TR232	5,41	10°	1,500	Pentronic
TR233	5,41	80°	0,000	Pentronic
TR234	5,41	80°	0,375	Pentronic
TR235	5,41	80°	0,750	Pentronic
TR236	5,41	80°	1,500	Pentronic
TR237	5,41	170°	0,000	Pentronic
TR238	5,41	170°	0,375	Pentronic
TR239	5,41	170°	0,750	Pentronic
TR240	5,41	170°	1,500	Pentronic

4.5 Instruments in the canister

Temperature is measured both on the canister surface and inside the canister /4-2/. Eleven thermocouples are installed on each canisters surface. Three groups of three thermocouples are installed 100 mm from each heater end, and in the middle of the heater, with a distribution of 120°. Two additional thermocouples are installed in the centre of the bottom lid and the top cover. Temperature inside the canister insert is measured at 6 points with thermocouples.

Figure 4-2 shows how these thermocouples are placed (see also chapter 4.2). Table 4-6 and 4-7 show the positions.

Table 4-6 Numbering and position of instruments for measuring the temperature on the heaters surface (T)

Type and number	Heater	Instruments coordinates			Instrument Fabricate	Remark
		Position	α degree	r m		
TH1 SE0	1	Bottom	0	0,000	0,500	
TH1 SE1 0°	1	Lower sec.	0	0,305	0,600	
TH1 SE1 240°	1	Lower sec.	240	0,305	0,600	
TH1 SE1 120°	1	Lower sec.	120	0,305	0,600	
TH1 SE2 0°	1	Middle sec.	0	0,305	2,000	
TH1 SE2 240°	1	Middle sec.	240	0,305	2,000	
TH1 SE2 120°	1	Middle sec.	120	0,305	2,000	
TH1 SE3 0°	1	Upper sec.	0	0,305	3,400	
TH1 SE3 240°	1	Upper sec.	240	0,305	3,400	
TH1 SE3 120°	1	Upper sec.	120	0,305	3,400	
TH1 SE4	1	Top	0	0,000	3,500	
TH2 SE0	2	Bottom	0	0,000	4,000	
TH2 SE1 0°	2	Lower sec.	0	0,305	4,100	
TH2 SE1 240°	2	Lower sec.	240	0,305	4,100	
TH2 SE1 120°	2	Lower sec.	120	0,305	4,100	
TH2 SE2 0°	2	Middle sec.	0	0,305	5,500	
TH2 SE2 240°	2	Middle sec.	240	0,305	5,500	
TH2 SE2 120°	2	Middle sec.	120	0,305	5,500	
TH2 SE3 0°	2	Upper sec.	0	0,305	6,900	
TH2 SE3 240°	2	Upper sec.	240	0,305	6,900	
TH2 SE3 120°	2	Upper sec.	120	0,305	6,900	
TH2 SE4	2	Top	0	0,000	7,000	

Table 4-7 Numbering and position of instruments for measuring the temperature inside the heaters (T)

Type and number	Heater	Instruments coordinates			Instrument Fabricate	Remark
		Position	α degree	Z m		
TH1 SI1 0°	1	Lower sec.	0	0,60		
TH1 SI1 180°	1	Lower sec.	180	0,60		
TH1 SI2 0°	1	Middle sec.	0	2,00		
TH1 SI2 180°	1	Middle sec.	180	2,00		
TH1 SI3 0°	1	Upper sec.	0	3,40		
TH1 SI3 180°	1	Upper sec.	180	3,40		
TH2 SI1 0°	2	Lower sec.	0	0,60		
TH2 SI1 180°	2	Lower sec.	180	0,60		
TH2 SI2 0°	2	Middle sec.	0	2,00		
TH2 SI2 180°	2	Middle sec.	180	2,00		
TH2 SI3 0°	2	Upper sec.	0	3,40		
TH2 SI3 180°	2	Upper sec.	180	3,40		

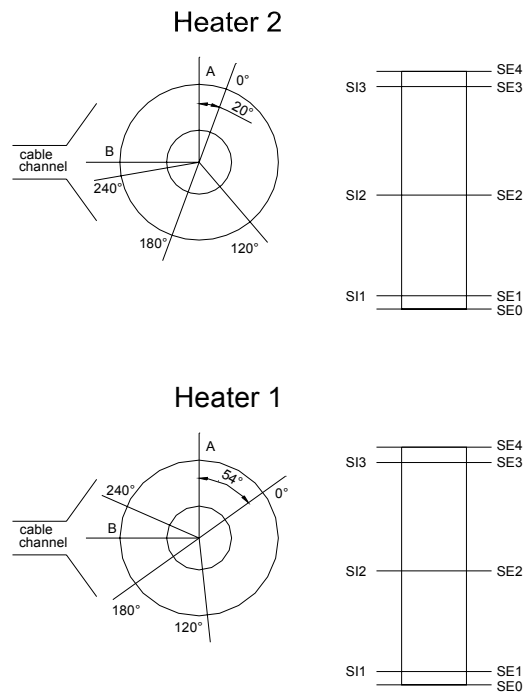

Figur 4-2. Location of thermocouples inside (SI) and on (SE) the canisters

4.6 Instruments on the plug

Three force transducers and three displacement transducers have been placed on the plug to measure the force of the anchors and the displacement of the plug. The location of these transducers can be described in relation to Fig 4-3, which shows a schematic view of the plug with the slots, rods and cables.

The rods are numbered 1-9 anti-clockwise and number 1 is the northern rod 18 degrees from direction A. The force transducers are placed on rods 3, 6, and 9. The displacement transducers are placed between the rods on the steel ring in the periphery of the plug. They are fixed on the rock surface and measure thus the displacement relative to the rock.

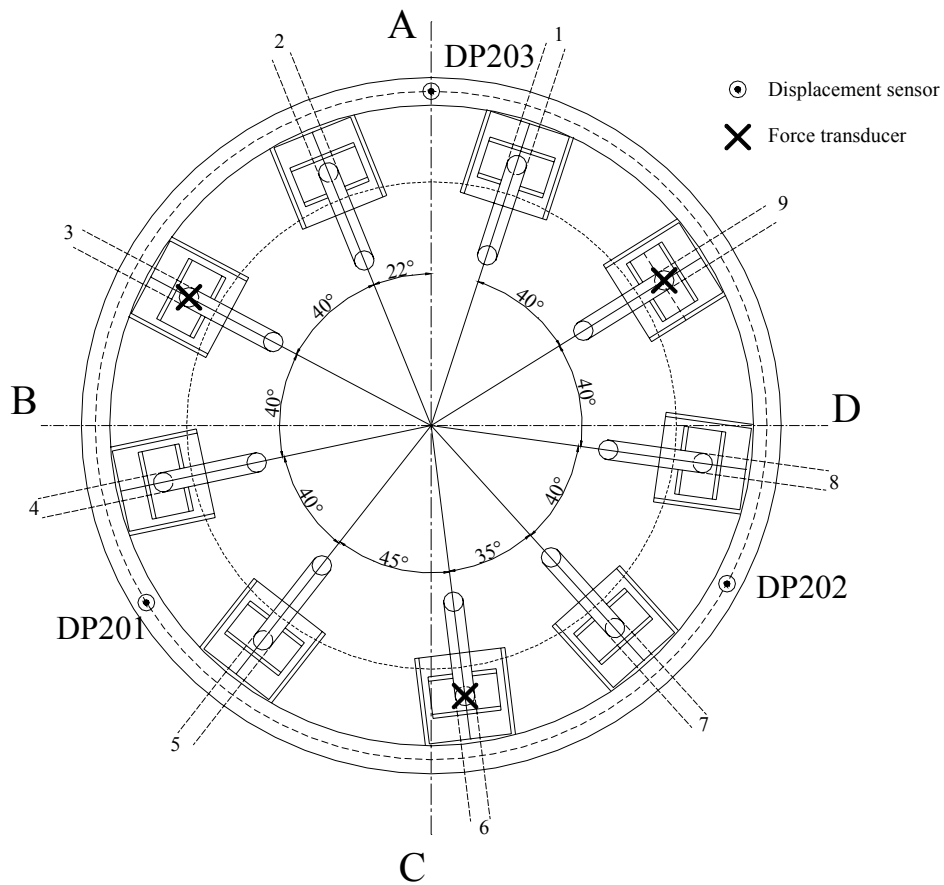

Figure 4-3. Schematic view showing the positions of the rods and the displacement and force transducers on the retaining plug.

5 Discussion of results

5.1 General

The aim of this chapter is two-parted: (i) to give an updated interpretation of the project as a whole; and (ii) to highlight the latest developments. More detailed discussions of earlier results can be found in previous data reports.

5.2 Total inflow of water

The total injected water volume is shown in (App.A\page 73) and was 3.2 m³ at January 1, 2006. Table 5-1 shows the pore space available at the beginning of the test. The calculated available pore volume has thereby been exceeded with 0.5 m³. This discrepancy can probably be ascribed to water flow into the rock, vapour leaks or perhaps other inaccuracies.

The inflow has varied significantly during the test period. During the first 75 days the inflow was about 15 l/d, while it dropped to about 1.3 l/d during the subsequent 250 days. On average during the test period, the flow rate has slightly exceeded 3 l/d.

Two major events can be noticed in the applied scheme for pressurization (Table 5-2):

- During the first 377 days, the sand filter was only pressurized through the lower injection points, while the upper were open to the atmosphere. After this day, upper injection points have also been pressurized while none of the injection points has been open to the atmosphere.
- The second event was the installation of equipment for measuring pressure at each injection point at October 8, 2004 (day 562) (see Figure 5-1.). Since then, two out of eight injection points (one upper and one lower) have been closed and used for monitoring of the actual pressure in the sand filter.

The pressure in the sand filter is significantly lower than the applied injection pressure (see Figure 5-2). This pressure drop can probably be ascribed to the flow resistance of the filter cups. This in turn appears to have influenced the flow rates (see /5-1/ for further discussions).

Table 5-1. TBT Pore space.

	Available at test start [m3]	
Sand filter	0.77	
Pellets filling	0.24	1.38
Bentonite	1.08	
Heater/bentonite clearance	0.06	
Sand shield	0.55	
Total	2.70	

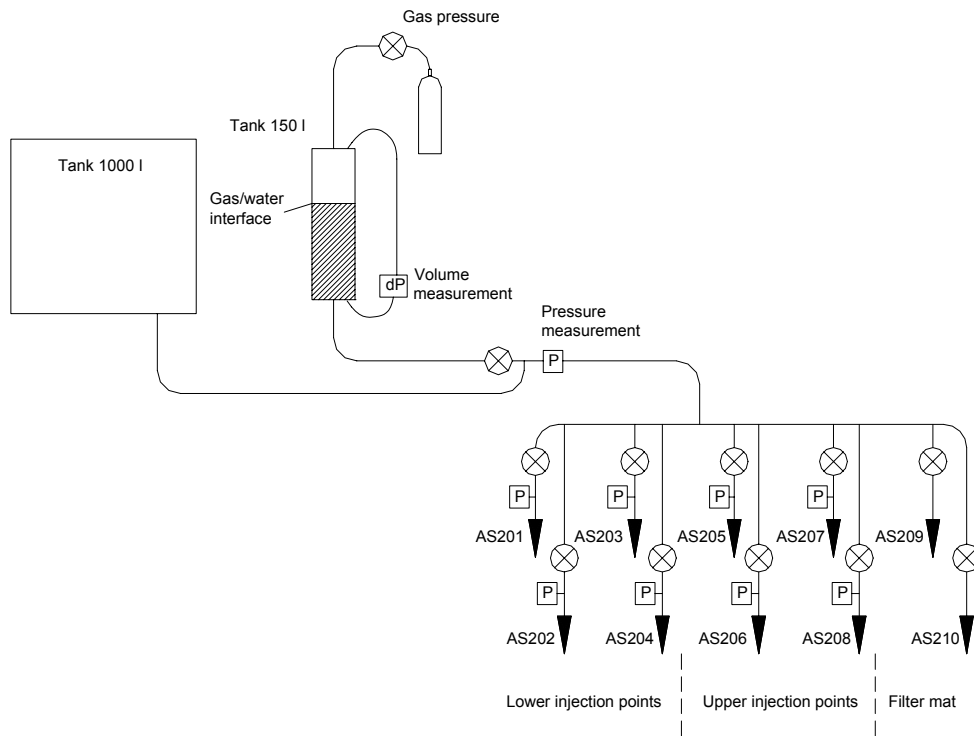

Figure 5-1. Schematic view of injection system.

Table 5-2. Injection point pressurization scheme. The actual water pressure in the sand filter is only measured at those points that are closed.

Intervals	Lower injection points				Upper injection points				Filter mat		p (MPa)
	201	202	203	204	205	206	207	208	209	210	
030326 – 040406 Day 0 - 377	O	O	O	O	⊕	⊕	⊕	⊕	⊗	⊗	0.8
040406 – 040615 Day 377 - 447	O	O	O	O	O	O	O	O	⊗	⊗	0.1
040615 – 040616 Day 447 - 448	Hydraulic test I										
040616 – 041008 Day 448 – 562	O	O	O	O	O	O	O	O	⊗	⊗	0.25
041008 – 041014 Day 562 - 568	Hydraulic test II										
041014 – 041110 Day 568 - 595	⊗	⊗	⊗	⊗	O	⊗	O	⊗	⊗	⊗	0.6
041110 – 050728 Day 595 - 856	O	O	⊗	O	O	O	⊗	O	⊗	⊗	0.6
050728 – 051209 Day 856 - 989	O	⊗	O	O	O	⊗	O	O	⊗	⊗	0.6
051209 – 051212 Day 989 - 992	O	⊗	O	O	O	⊗	O	O	O	⊗	0.6
051212 – 060101 Day 992 - 1012	O	⊗	O	O	O	⊗	O	O	O	O	0.6

O = Open and pressurized

⊕ = Open to atmosphere

⊗ = Closed

Changes made during 2005-07-01 – 2006-01-01

Due to decreasing pressure in the sand filter during July 2005 (see Figure 5-2), the non-pressurized points were changed to AS202 and 206 at July 28 (see Table 5-2).

The filter mats between the Cylinder 3 and 4 were activated on December 9 (point AS209) and 12 (AS210), 2005. At the same time, the air-vents (AS212-AS215) were closed.

The activation was made by evacuation of the 210 inlet with a vacuum pump for approx. 30 min, down to a vacuum of 84 kPa and thereafter by injecting de-ionized water with a GDS at inlet 209. Injection was made at increasing pressure levels in order to sustain adequate flow rates: 200, 400 and finally 500 kPa. No higher level was used since the latter value corresponded to the pressure level in the artificial saturation system. After 6 hours of injection, 2815 ml had been added to the system. At this stage, no flow from 209 to 210 had been observed. Since the flow rate were down at 120 ml per our and decreasing the injection test was terminated. After this, inlet 209 was connected to the artificial saturation system while inlet 210 was closed.

Three days later (December 12), the system was temporarily flushed by opening inlet 210. 480 ml was flushed during 3:38 hours. After this, inlet 210 was also connected to the artificial saturation system.

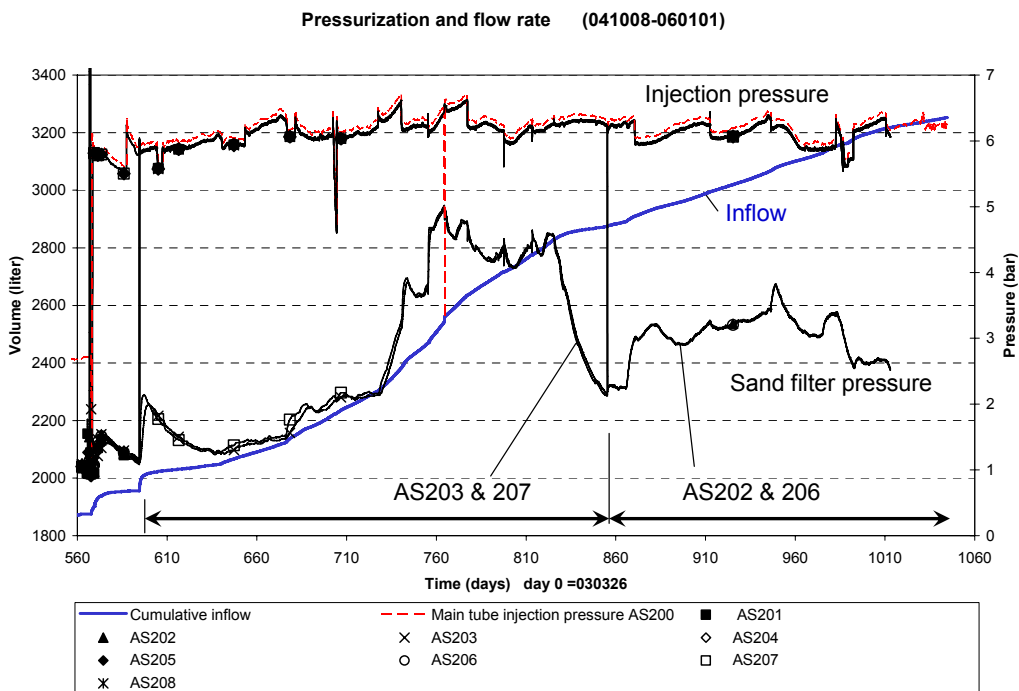

Figure 5-2. Pressurization and flow rate after the second hydraulic test mid-October 2004. AS200 is the main tube. AS201 – AS 208 is individual injection tubes. The actual water pressure in the sand filter was only measured at two points.

5.3 Temperatures

Temperatures are monitored by use of thermocouples in three cylinders (C1, C2 and C3) and three rings (R4, R10 and R12), cf. Figure 1-1. In addition, temperature readings are provided by the capacitance-type relative humidity (RH) sensors. In general, the temperature results exhibit consistent trends up to maximum values after about 200 days (App.A\ pages 79-84). A few exceptions have occurred for inner parts in Cyl 2 and the inner sand shield at Ring 10, where the maximum temperatures were reached after only about 40 and 60 days, respectively (App.A\pages81-82). Further discussion is given in /5-1/.

The temperature readings from January 1 2006 are compiled in Figure 5-3. It can be noted that the highest temperatures in the bentonite blocks are found in Ring 4, whereas the lowest can be found in cylinder C3. It can also be noted that the temperatures in Cylinder 2 at radius 350 – 450 mm is significant lower than in Ring 4 and Ring 10 at corresponding radii.

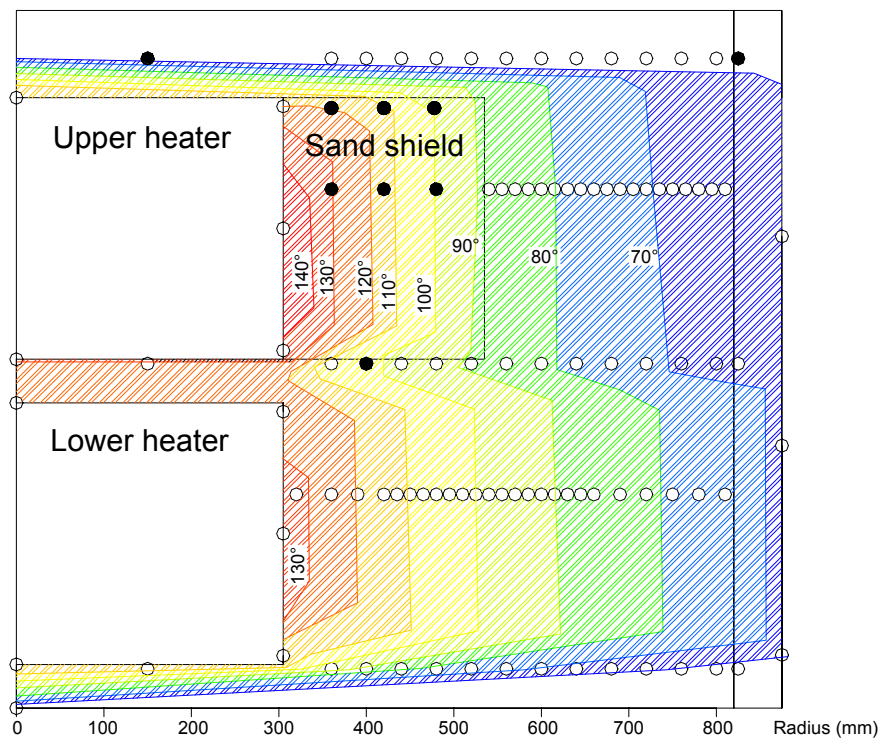

Figure 5-3. Temperature distribution at January 1, 2006. Rings indicate sensor positions. Filled rings indicate sensors out of order.

Influence from Canister Retrieval Test

The TBT experiment is located 6 m from the CRT experiment. The latter was initiated approximately 880 days before the start of the TBT experiment and has therefore affected the temperatures in TBT. The power output from CRT has not been constant over time but has varied significantly (see Figure 5-4, upper).

A simple estimation of this influence is shown in Figure 5-4, lower right. This graph was calculated for three line sources /5-2/; one for each heater in TBT and CRT, and for three corresponding mirror sources, thereby assuming constant temperature at the tunnel floor. The geometry is shown in Figure 5-4, lower left. The power function shown in the upper graph was used for the CRT line source. A simple step function, from zero to 1500 W, was used for each of the TBT line sources. A base temperature of 20°C was also assumed.

Temperatures were calculated for different radii and azimuth for a level 0.1 m above the lower edge of the lower heater in TBT (see lower left). These points correspond to some of the thermocouples data shown in (App.A\ page 86). For comparison, temperatures were also calculated for the same radii, but without the influence of CRT.

It should be noted that the absolute calculated temperature levels do not match the measurements with any high precision, for which a more detailed model of the TBT experiment would be required. The influence of CRT, i.e. the difference between calculated temperatures with and without a CRT line source, should also be regarded as an estimate, due to the simplification of a constant temperature in the entire plane of the tunnel floor.

Some of the trends in (App A\page 86) can nevertheless be captured with this approach. For instance, three peaks, or at least distinct turns, can be observed at days 270, 730 and 940 at 1.5 m depth and azimuth $\sim 0^\circ$, in both model and experiment. These three turns are therefore apparently caused by the decreasing heat load in CRT. It can also be noted that the fairly constant temperature level that has been observed since day 270 in many points is basically a consequence of a decreasing heat load. The steady temperature increase that could be expected without CRT, appears to be compensated of this decreasing heat load. Finally, the temperature difference between points with the same radius, but with different directions, is fairly well reproduced with the model.

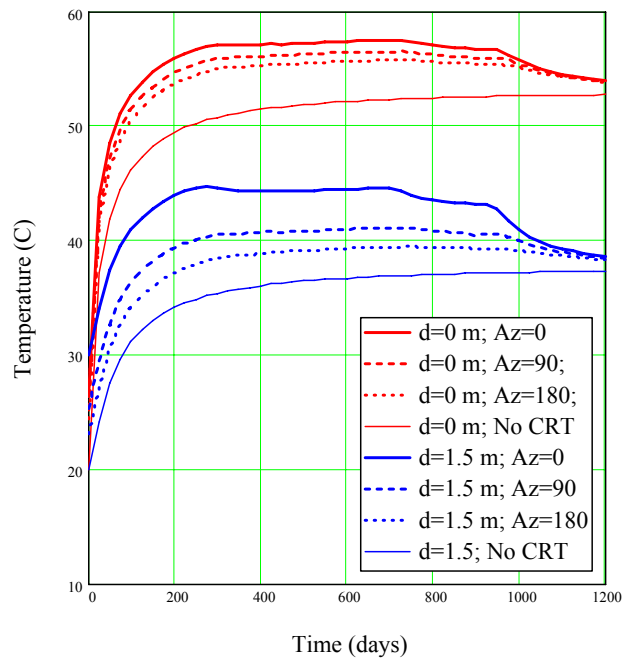
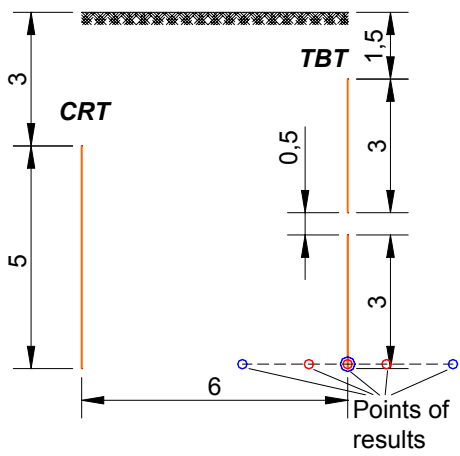
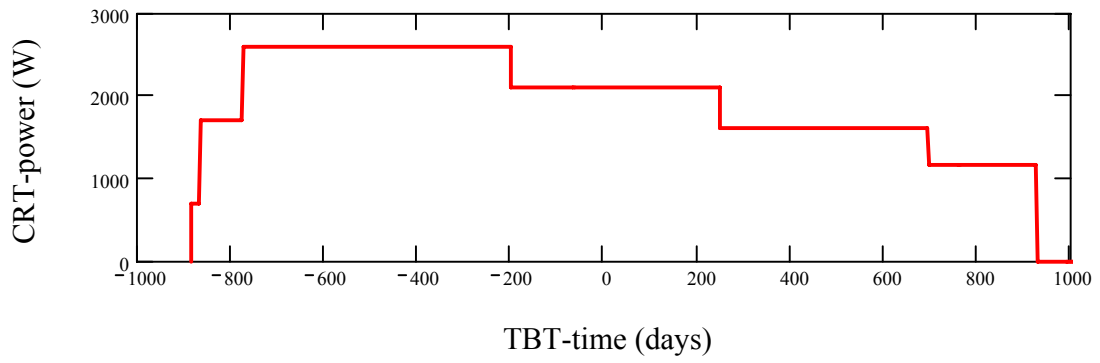

Figure 5-4. Analytical model of thermal influence of CRT on TBT. Upper: CRT heat load. Lower left: Geometry of model. Lower right: calculated temperatures.

Thermal gradients and conductivities

Figure 5-5 shows Azimuth 90° temperatures measured in Ring 4 and 10. The effect of the wetting of the sand filter outside Ring 10 is obvious: Within the first 60 days of heating, the temperature drop across the filter had discernibly decreased, as would be expected in a system that had become water saturated and had potentially undergone some swelling pressure – induced compression.

Figure 5-6 illustrates apparent thermal conductivity. The results are based on the slopes of temperature-distance curves derived from thermocouple readings in rings 10 and 4 (Figure 5-5), and on the assumption of constant radial heat output at heater mid-height. There are systematic increases that indicate that saturation may be proceeding at a reasonably high rate. Among the latest results this is most apparent in the innermost part of Ring 4. There is also an apparent increase in the sand shield conductivity.

In general, Figure 5-6 should be interpreted with some caution: some of the changes may be due to variation of the mid-height heat flux, and some may be due to dislocation of individual sensors.

The changes in Ring 4 are further illustrated in Figure 5-7. It can be noted that the innermost point, at 35 mm from the heater surface, dropped immediately after test start, but has thereafter increased steadily. In contrast, a point at 155 mm from the heater appears to have undergone a rapid increase in the beginning and has thereafter remained fairly constant.

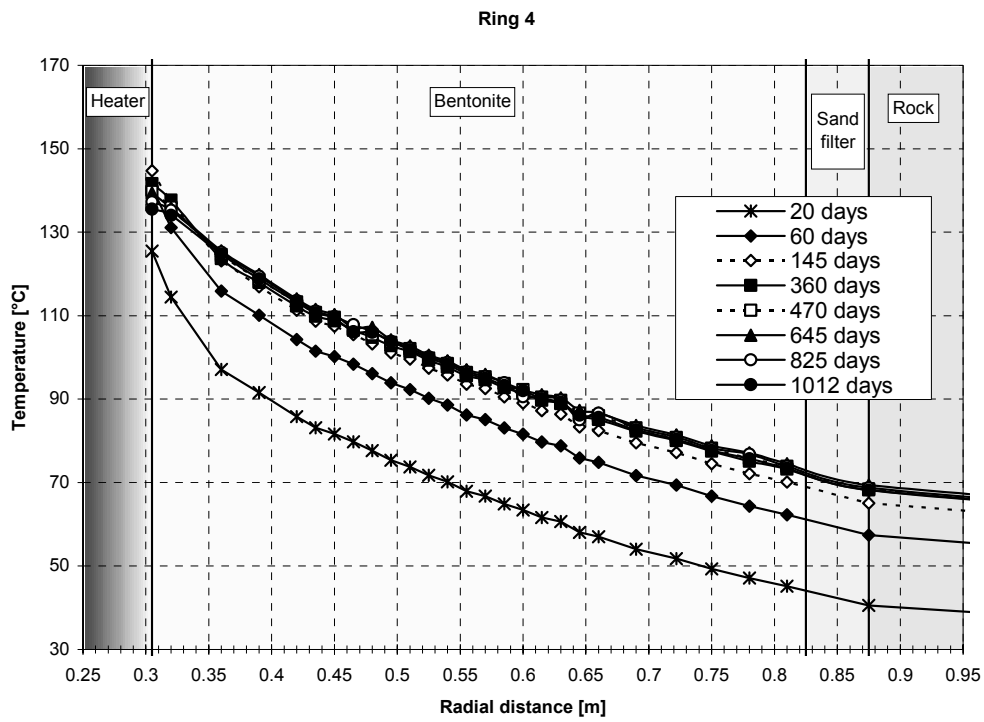

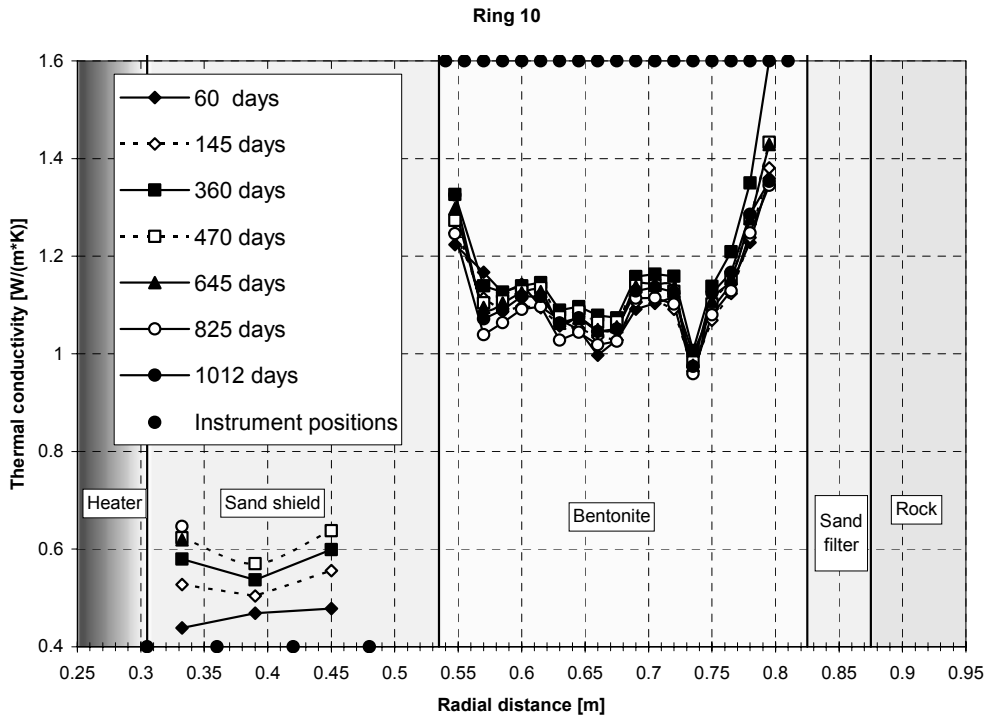
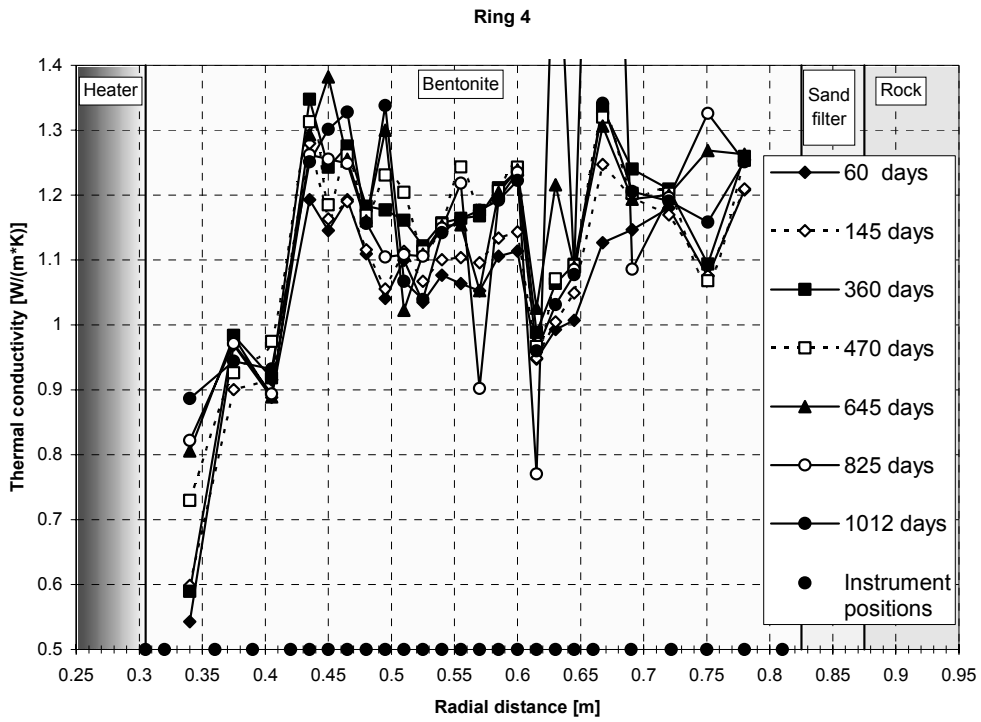

Figure 5-6. Thermal conductivity as computed from slopes of distance-temperature relation.

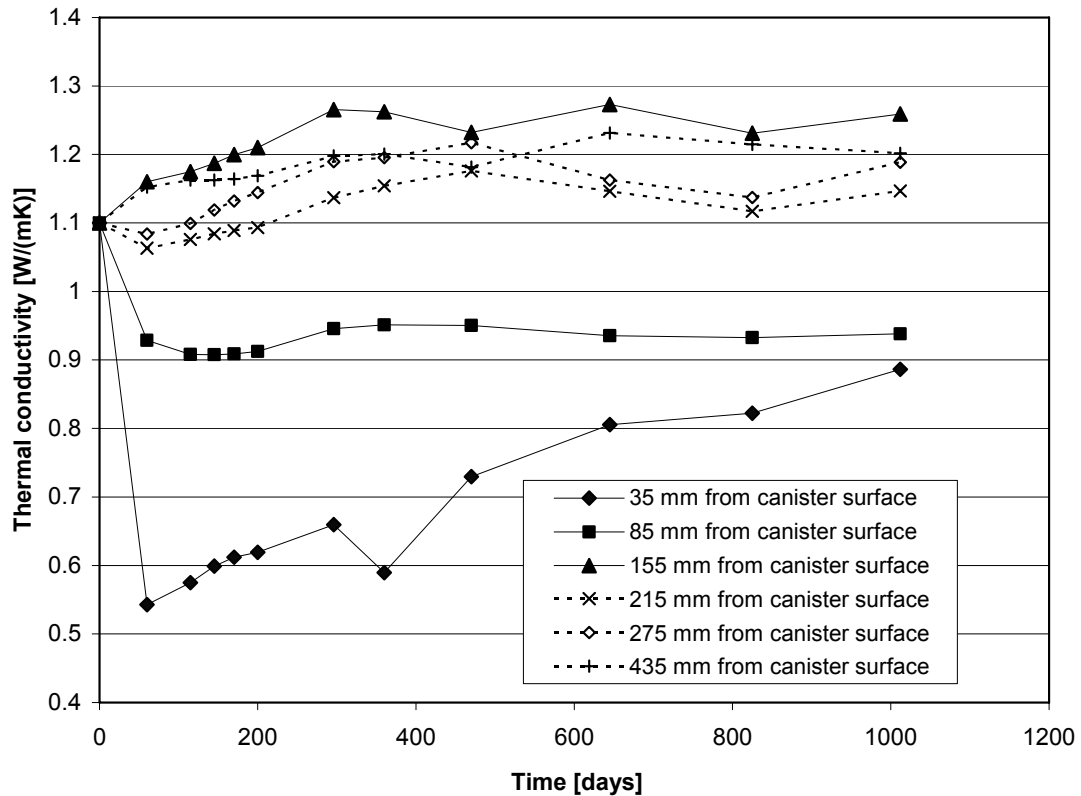

Figure 5-7. Thermal conductivity development in ring 4.

5.4 Relative humidity/suction

Recorded RH values and suctions indicate that moisture contents generally increase: RH from 72 to maximum 100 % (App.A\pages 65-70); suction between 6 and 1 MPa (App.A\pages 60-64).

A significant exception is the suction increase in Ring 10 at radius 785 and 735 mm after day 225 (App.A\page 63). Although this increase correlated with a general decrease in stresses in parts of Ring 9, it was most likely caused by a shortage in water supply, resulting in a localized desiccation cycle to occur. The trend was also reversed when water injection through the upper tubes was introduced (see Section 5.2), which supports the water supply explanation for these observations.

A compilation of sensors whose outputs indicate that the buffer is close to saturation is presented in Figure 5-8. Capacitive sensor signals showing RH \approx 100 % (Vaisala and Rotronic), and all *active* signals from psychrometers, corresponding to RH > 95 % (Wescor), are taken as indications of saturation. Occasions when such levels are reached are illustrated in Figure 5-8. As can be noted, the greatest depth to which the saturation

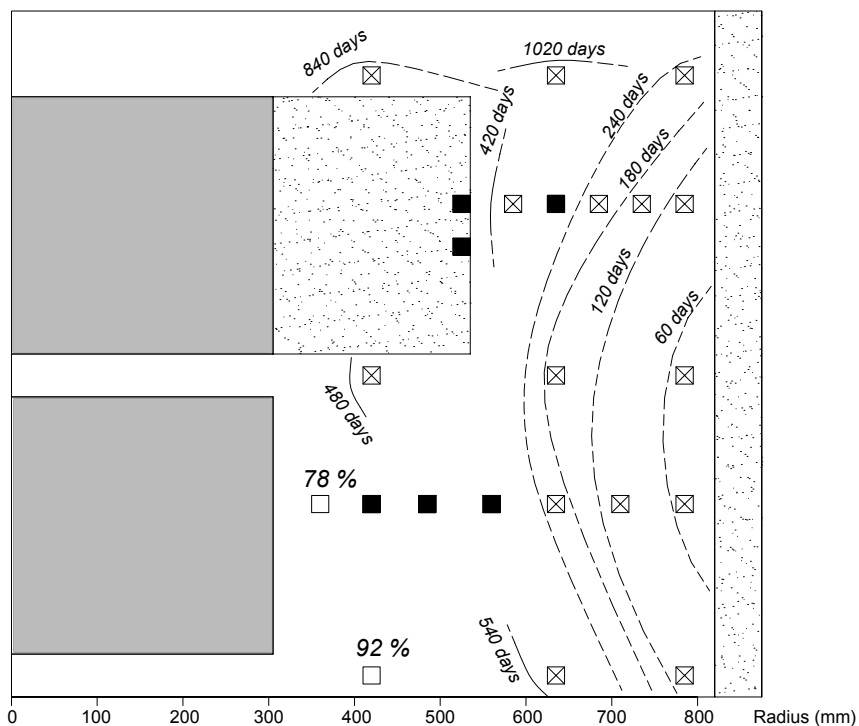

Figure 5-8. Occurrences of saturation up till January 1, 2006. Boxes are sensor positions. Ticked boxes indicate saturation. Filled boxes indicate sensors out of order. Percentages are current RH values.

front has advanced after 480 days of TBT operation is 420 mm in Cylinder 2. The sensor at the same radius in Cylinder 3 was saturated after day 840. An observation that can be made is that Cylinder 2, closely followed by Ring 4, seems to have gone through a rapid saturation of the outermost parts. The relatively fast saturation here may be an effect of vapor diffusing outwards from the hot, desaturated, parts close to the heater.

The activation of the filter mat between the upper cylinders is reflected by the recent saturation event in the upper part (see Figure 5-8).

Data from the innermost RH-sensor of Ring 4 (radius 360 mm) has recently been re-evaluated (App.A\page 66). This sensor was thought to have failed after day 120, since subsequent signals have exhibited an unstable behaviour. Recent data indicate however that the sensor is still functional. Results indicated stable conditions at a RH level of 62 % up till August 2nd, after which the value has increased significantly. The change coincided with the plugging of the tubing to a leaking pressure transducer, located 0.25 m directly below the RH-sensor in question. This leakage therefore appears to have maintained desaturated conditions, at least locally, up till this event. The notion of dry conditions in the inner part of Ring 4 at the time of the change is supported by apparent thermal conductivities as well as low swelling pressures in this part.

5.5 Total pressure

Results from pressure monitoring are shown in App.A\pages 51-59. A compilation of recent total pressures is shown in Figure 5-9. From this a number of observations can be made. Higher pressure levels occur in the outer parts throughout the experiment. An exception is the upper cylinders, which display the lowest pressure levels. The conditions in the lower and the mid-section cylinders are quite isostatic, while the sections around the heaters are characterized by deviatoric stresses, with relatively lower radial stresses.

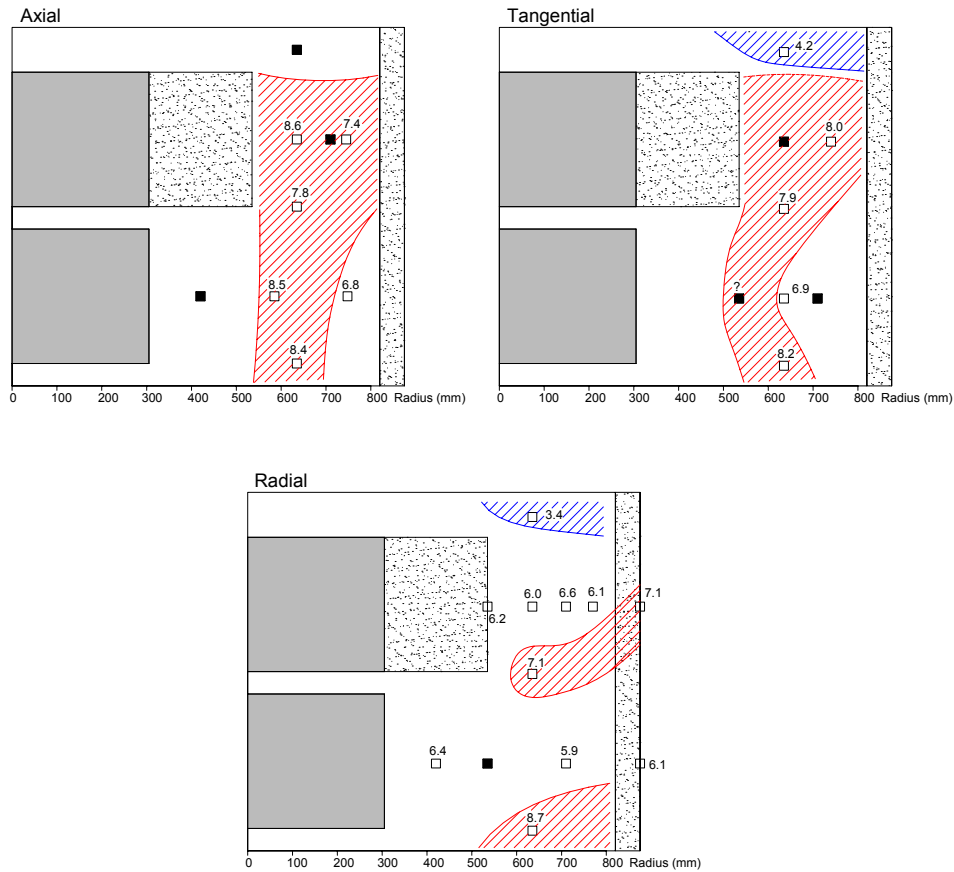

Figure 5-9. Total pressure distribution at January 1, 2006. Values in MPa. Boxes are sensor positions. Filled boxes indicate sensors out of order. Levels above 7 MPa marked red; below 5 MPa marked blue.

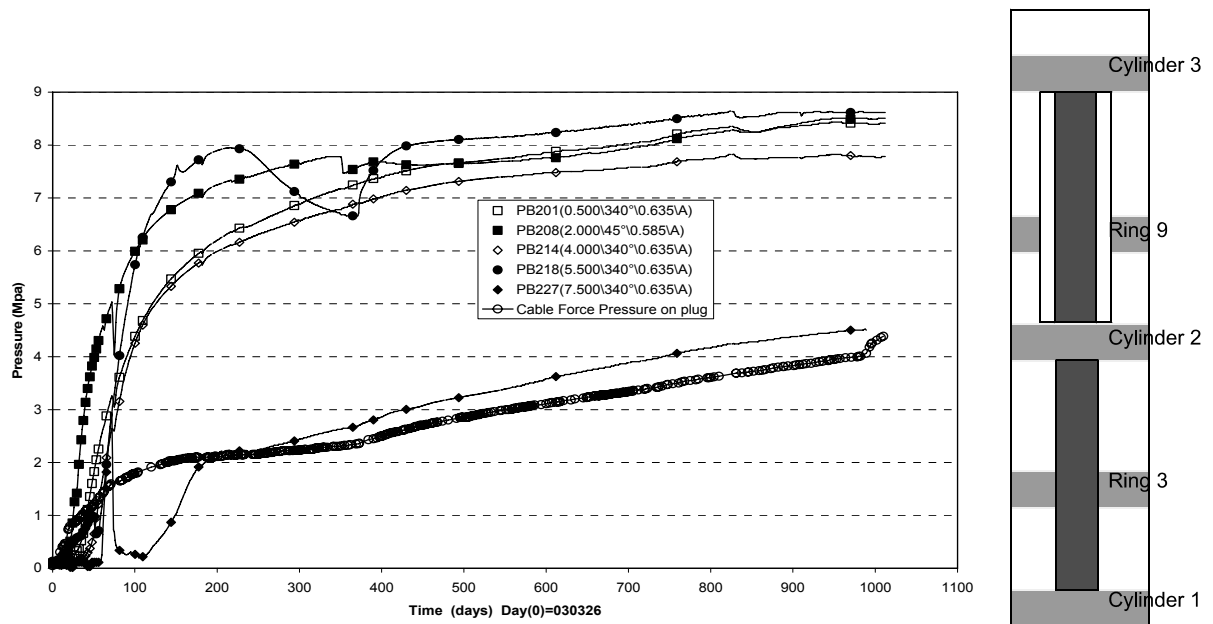

Figure 5-10. Axial pressure measured in different sections.

Recent axial pressures, shown in Figure 5-9, appear to be quite similar in a band between radius 550 and 650 mm from Cylinder 1 to Ring 9. In contrast, the axial pressure in Cylinder 3 was significantly lower, although this can not be seen in Figure 5-9 due to the sensor failure in connection with the filter mat activation. The relation is further illustrated in Figure 5-10 in which results are shown from axial pressure sensors all located at radii 585 - 635 mm. Moreover, measured cable forces are here shown after conversion to pressures under the assumption that the forces are evenly distributed over the entire rock hole area (2.40 m^2).

A fairly clear-cut grouping can be observed, which suggests that the vertical forces are predominantly transferred in a section corresponding to the buffer rings around the upper heater. The stress levels around the heaters and in the lower cylinders is approximately twice as high as in the upper part of the experiment, which suggest that the area engaged in the top is twice as high as in lower part.

This is further illustrated in Figure 5-11. In this, the vertical force is calculated at three levels: at the top of Ring 9, Cylinder 3 and the concrete plug, respectively. Differences in vertical forces between two sections can be attributed to shear forces at the rock wall. With the chosen approach, these shear forces are relatively small, which can be expected given sufficient time.

The chosen approach also implies that the axial forces through the heaters are negligible. This may have been an oversimplification in the beginning of the test when the thermal expansion of the heaters were significant. A 100°C temperature increase will result in about 7 mm increase in total heater length. But the total displacement of the plug at present amount to 14 mm, which would imply that the thermal expansion of the heaters is not limited in vertical direction by the buffer package. At the beginning of the test however, the plug force exhibited a more rapid build-up than the axial pressures in the buffer, which may be attributed to the thermal expansion.

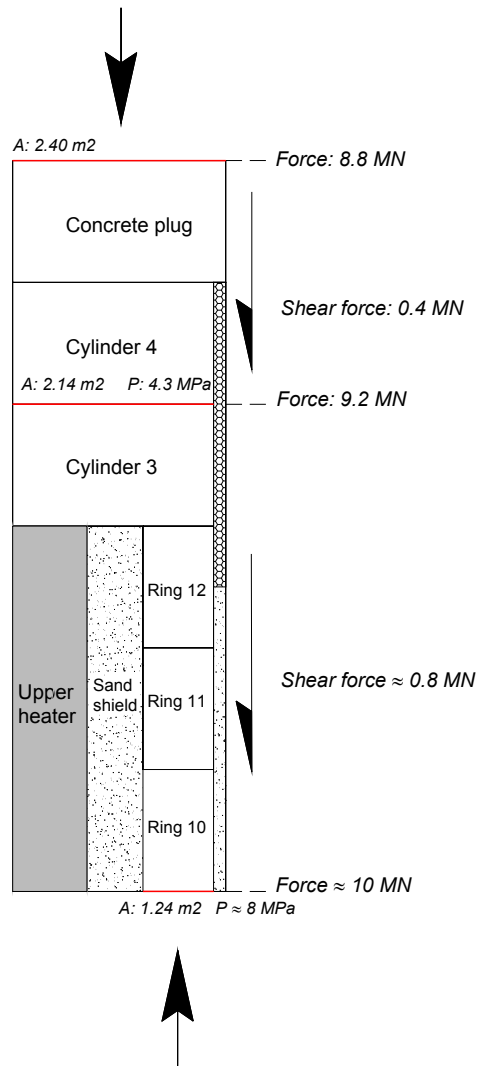

Figure 5-11. Schematic of vertical forces acting on the upper part of the package (data from 2005-07-01).

References

/4-1/ Sandén T and Börgesson L. Report on instruments and their positions for THM measurements in buffer and rock and preparation of bentonite blocks for instruments and cables. Temperature Buffer Test, Report R5 , 2002. SKB ITD-02-05

/4-2/ Garcia-Sineriz, J.L and Fuentes- Cantillana. Feasibility study for the heating system at the TBT test carried out at the Äspö HRL in Sweden. Temperature Buffer Test , October 2002. SKB IPR-03-18

/5-1/ Goudarzi R., Åkesson M., Hökmark H. Äspö Hard Rock Laboratory. Temperature Buffer Test. Sensors data report (period 030326-050701) Report No:6, 2005, SKB IPR-05-20.

/5-2/ Ikonen K. Thermal Analyses of Spent Nuclear Fuel Repository, June 2003, POSIVA 2003-04.

Appendix A

Measured data

**Total pressure/Cyl.1 (030326-060101)
Geokon**

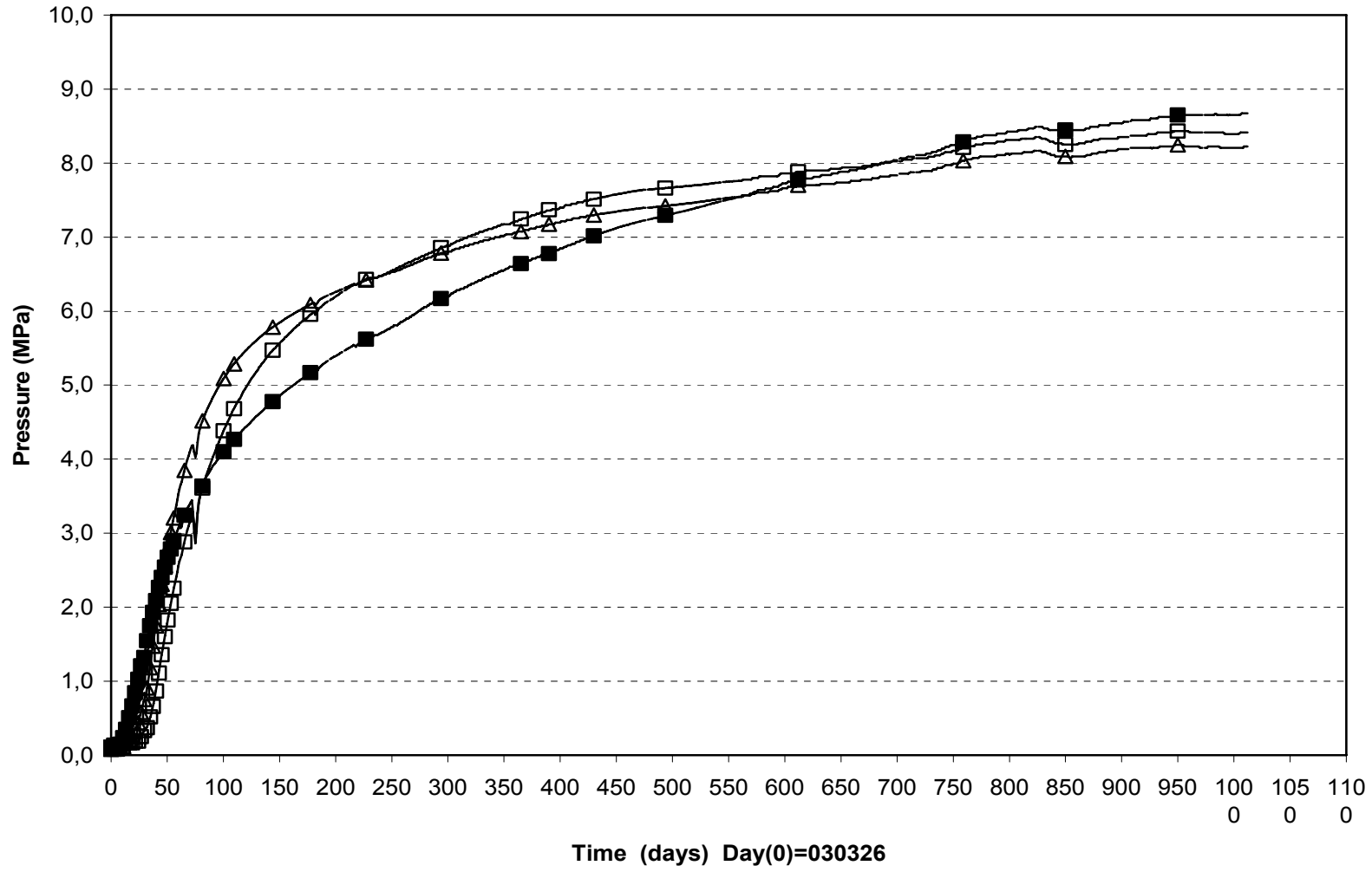

PB201(0.500\340°\0.635\A)
 PB202(0.450\0°\0.635\R)
 PB203(0.450\20°\0.635\T)

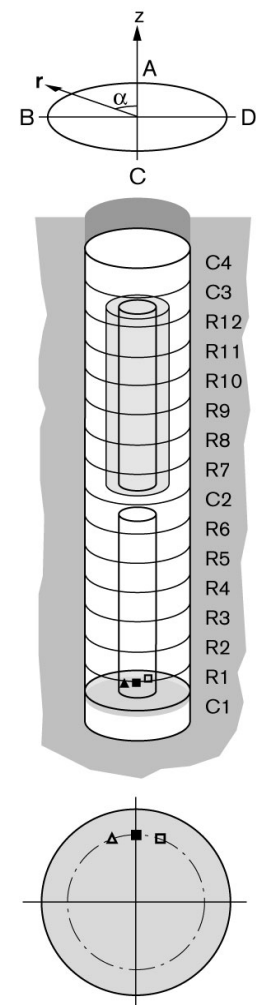

**Total pressure/Ring 3 (030326-060101)
Geokon**

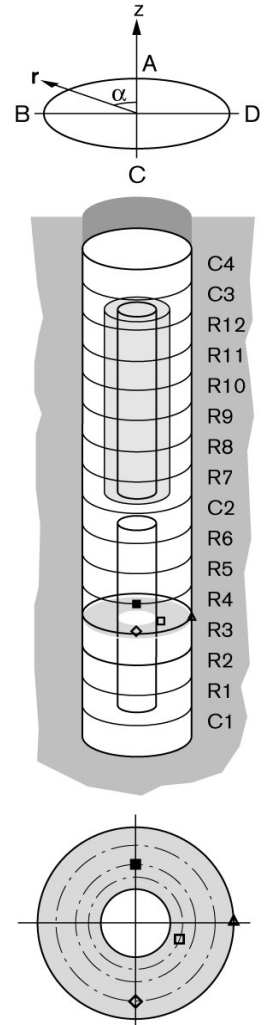
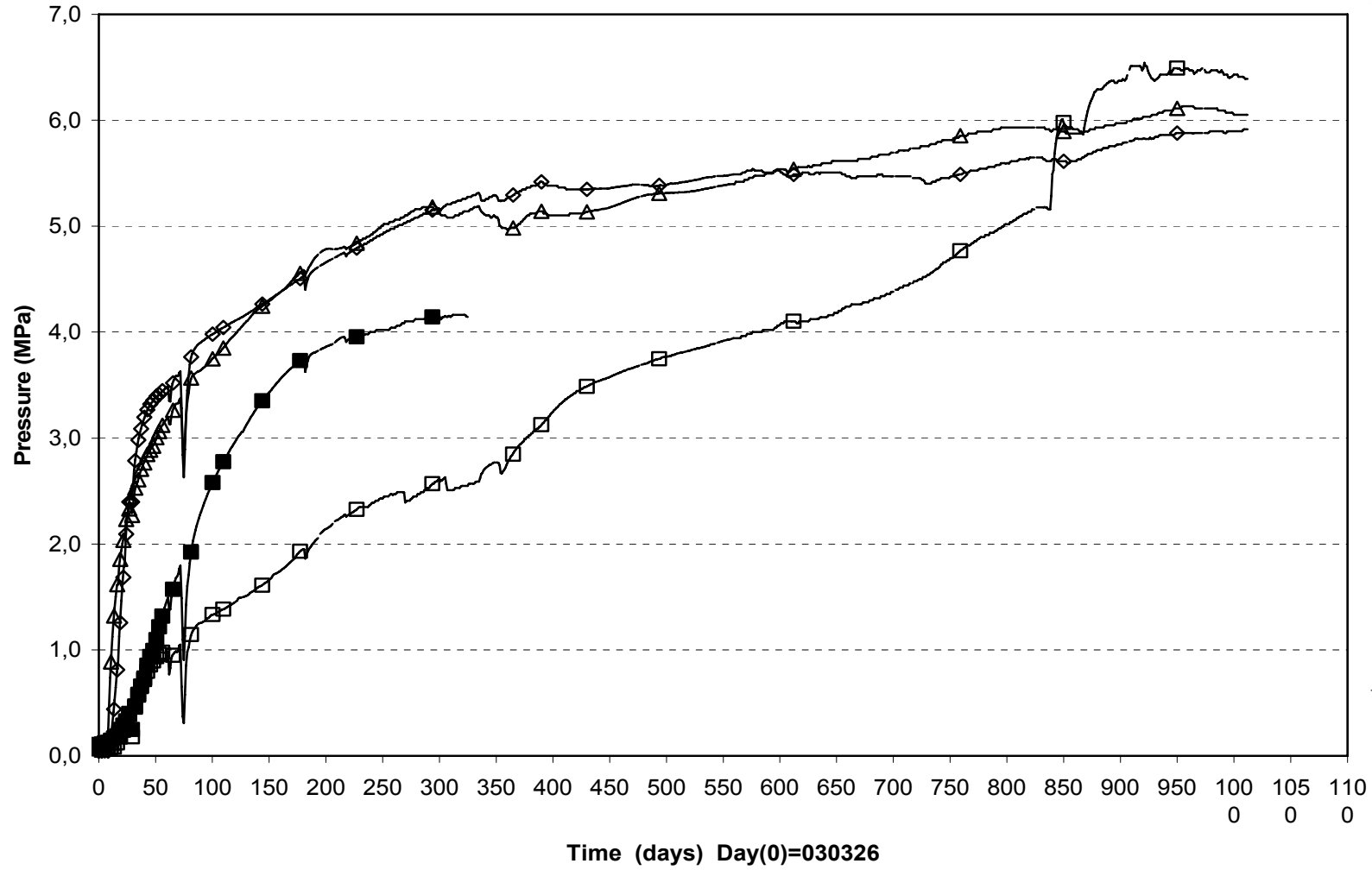

Total pressure/R3 (030326-060101)
Geokon

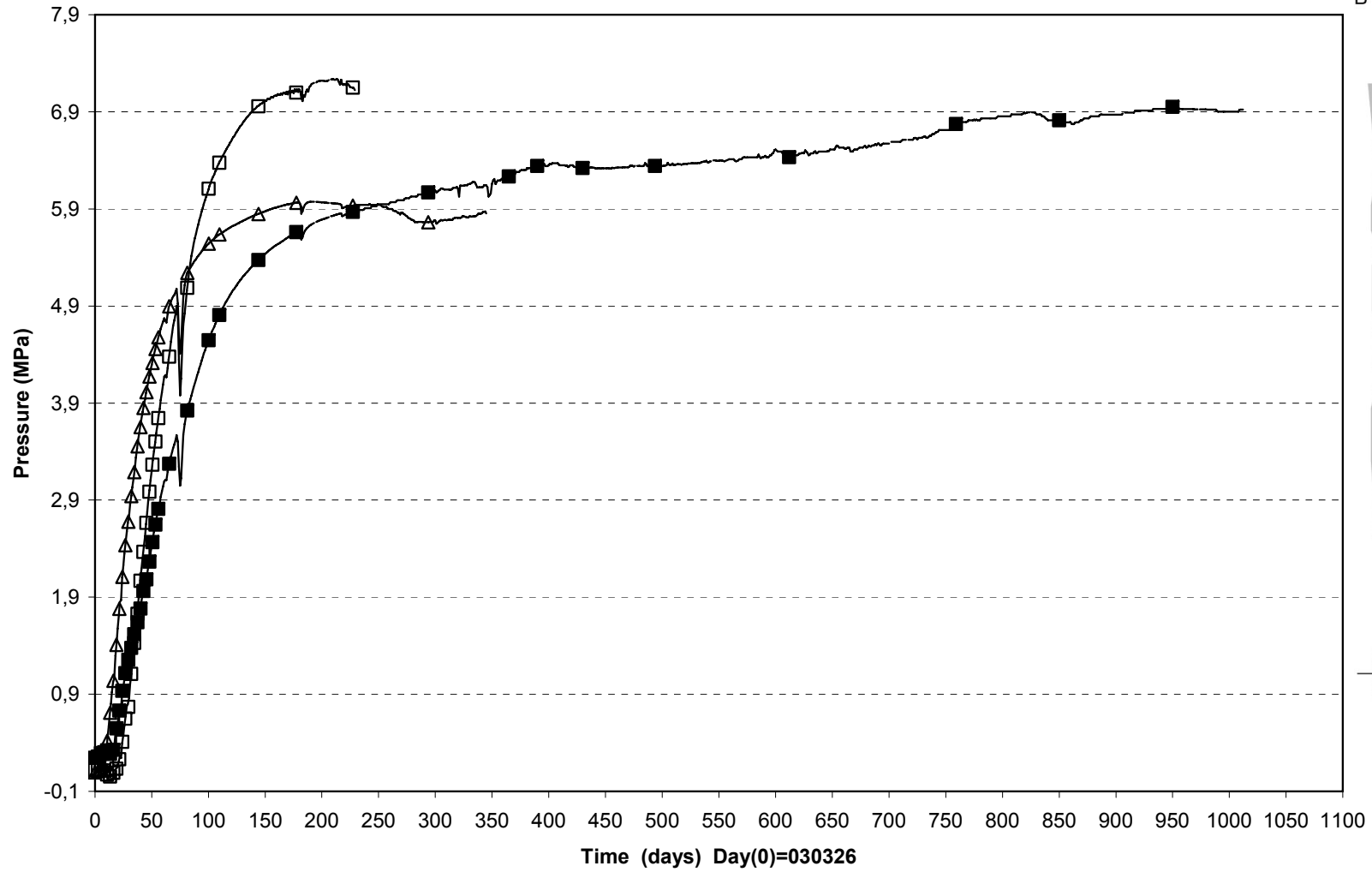

□ PB207(1.950\20°\0.535\T) ■ PB209(1.950\100°\0.635\T) △ PB210(1.950\170°\0.710\T)

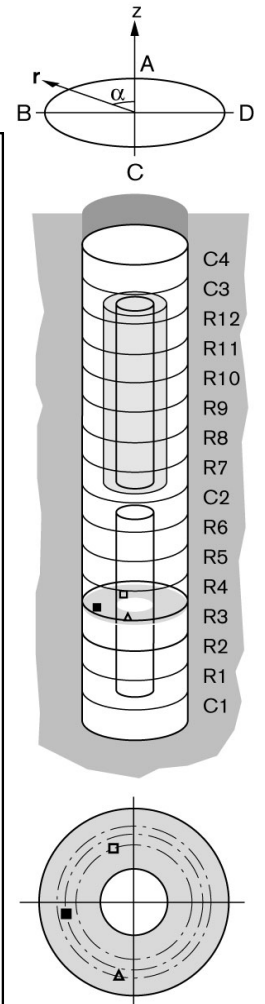

Total pressure/R3 (030326-060101)
Geokon

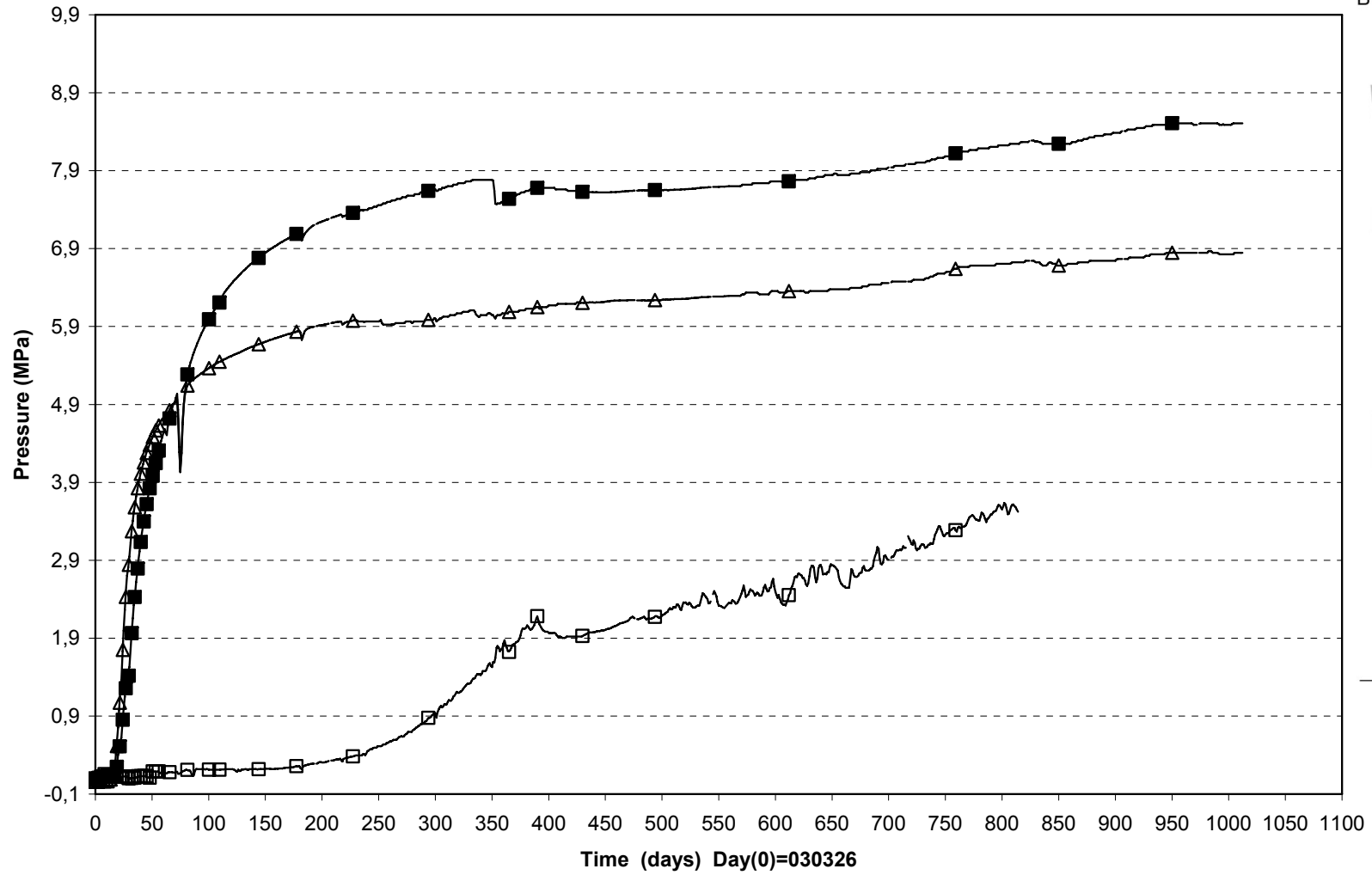

□ PB205(2.000\290°\0.420\A) ■ PB208(2.000\45°\0.585\A) △ PB212(2.000\260°\0.748\A)

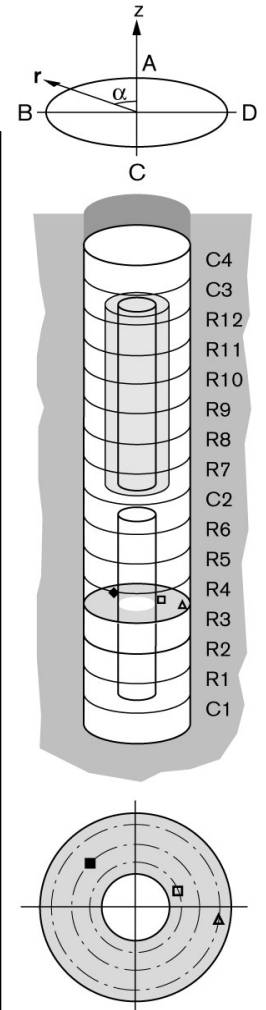

Total pressure/Cyl.2 (030326-060101)
Geokon

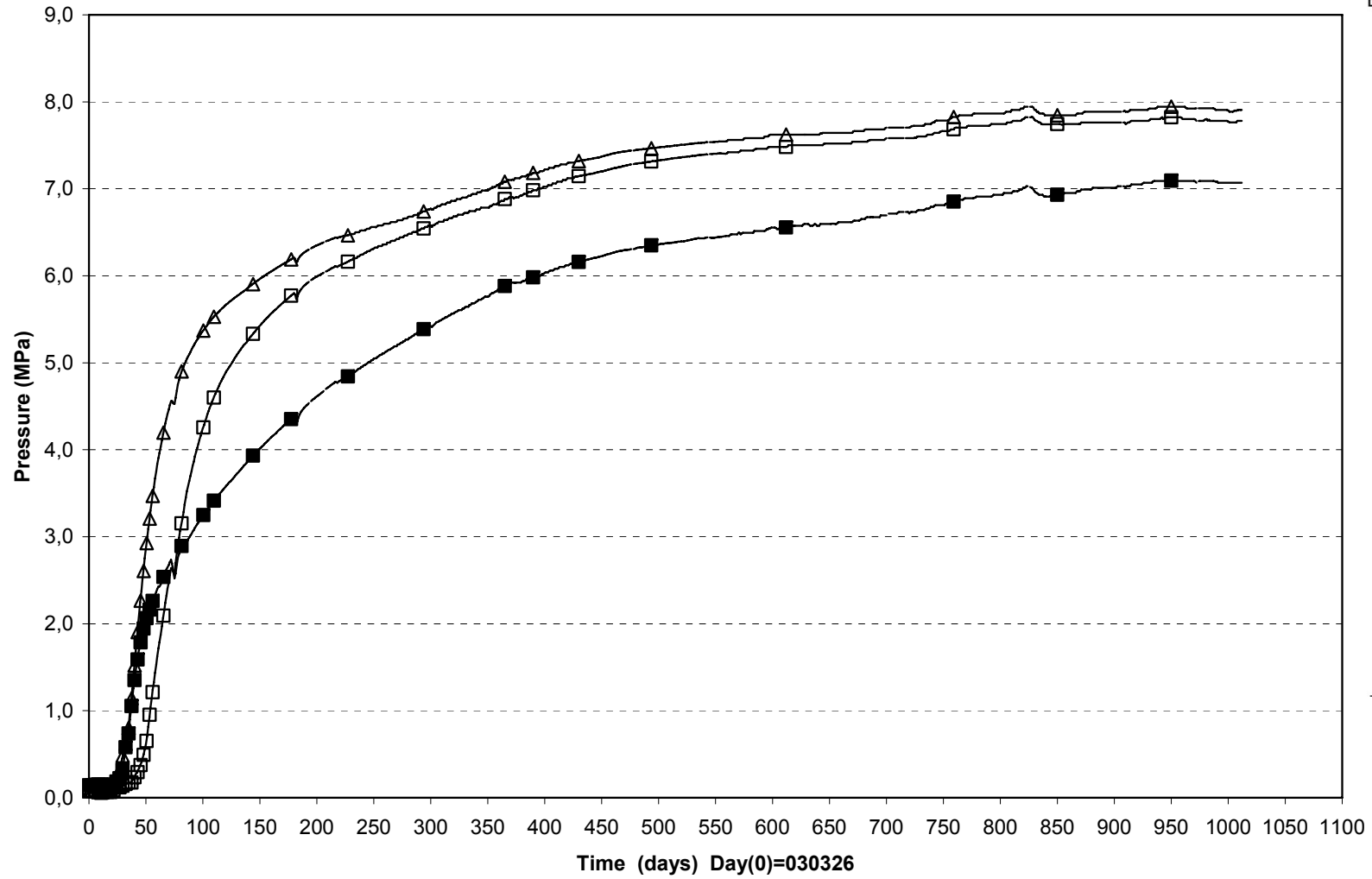

□ PB214(4.000\340°\0.635\A) ■ PB215(3.950\0°\0.635\R) Δ PB216(3.950\20°\0.635\T)

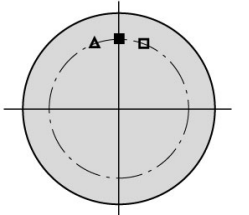
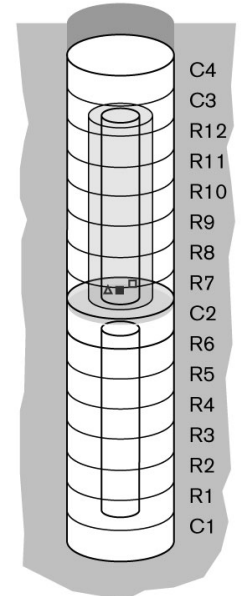
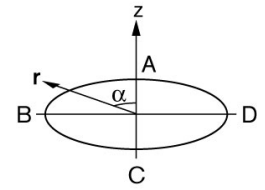

Total pressure/Ring 9 (030326-060101)
Geokon

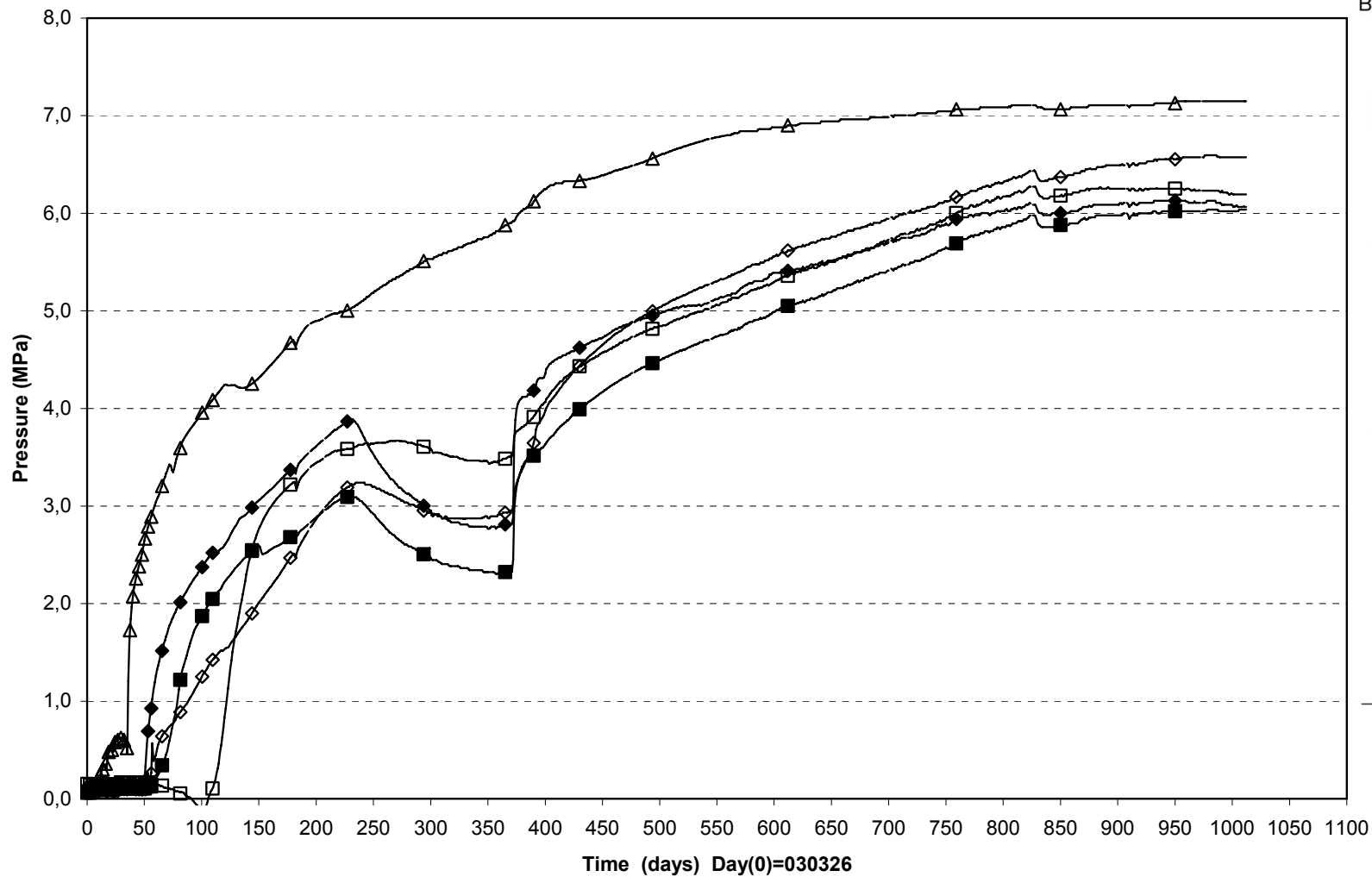

□ PB217(5.450\270°\0.535\R) ■ PB219(5.450\0°\0.635\R) ◇ PB222(5.450\110°\0.710\R) ◆ PB224(5.450\180°\0.770\R) △ PB226(5.450\270°\0.875\R)

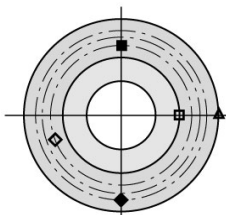
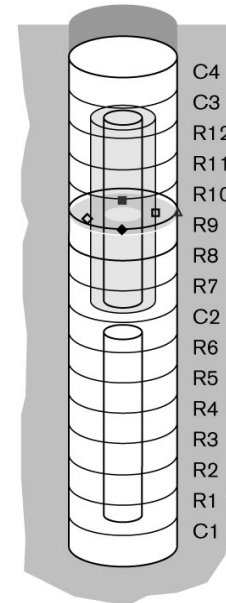
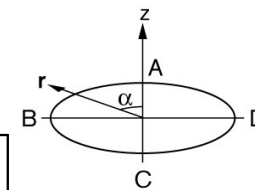

Total pressure/Ring 9 (030326-060101)
Geokon

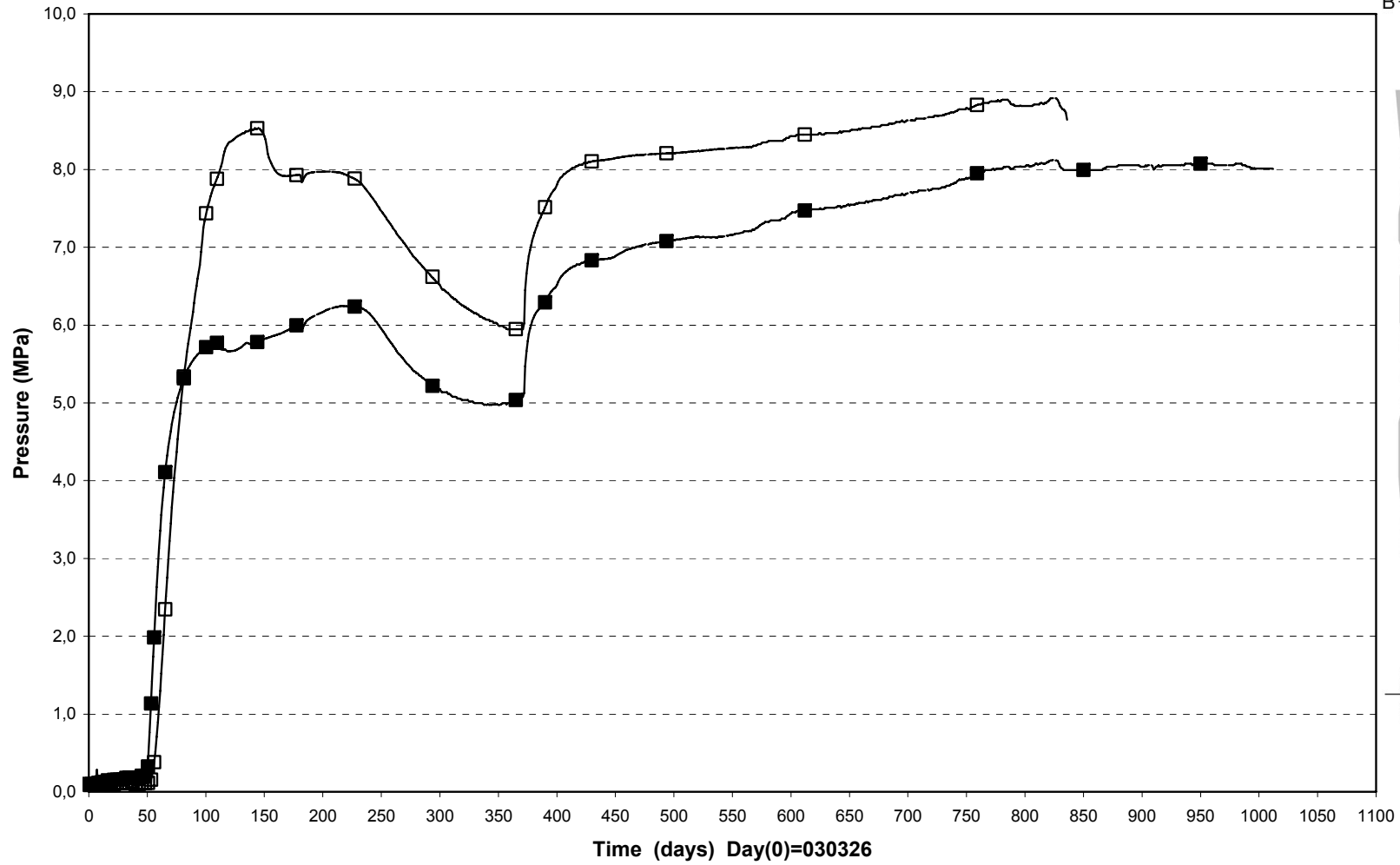

□ PB220(5.450\20°\0.635\T) ■ PB225(5.450\200°\0.740\T)

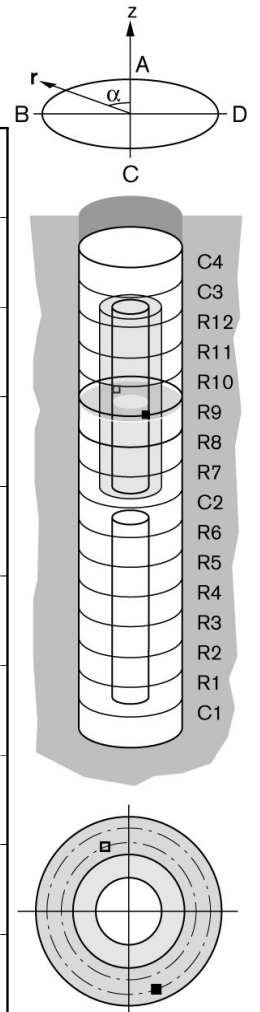

Total pressure/R9 (030326-060101)
Geokon

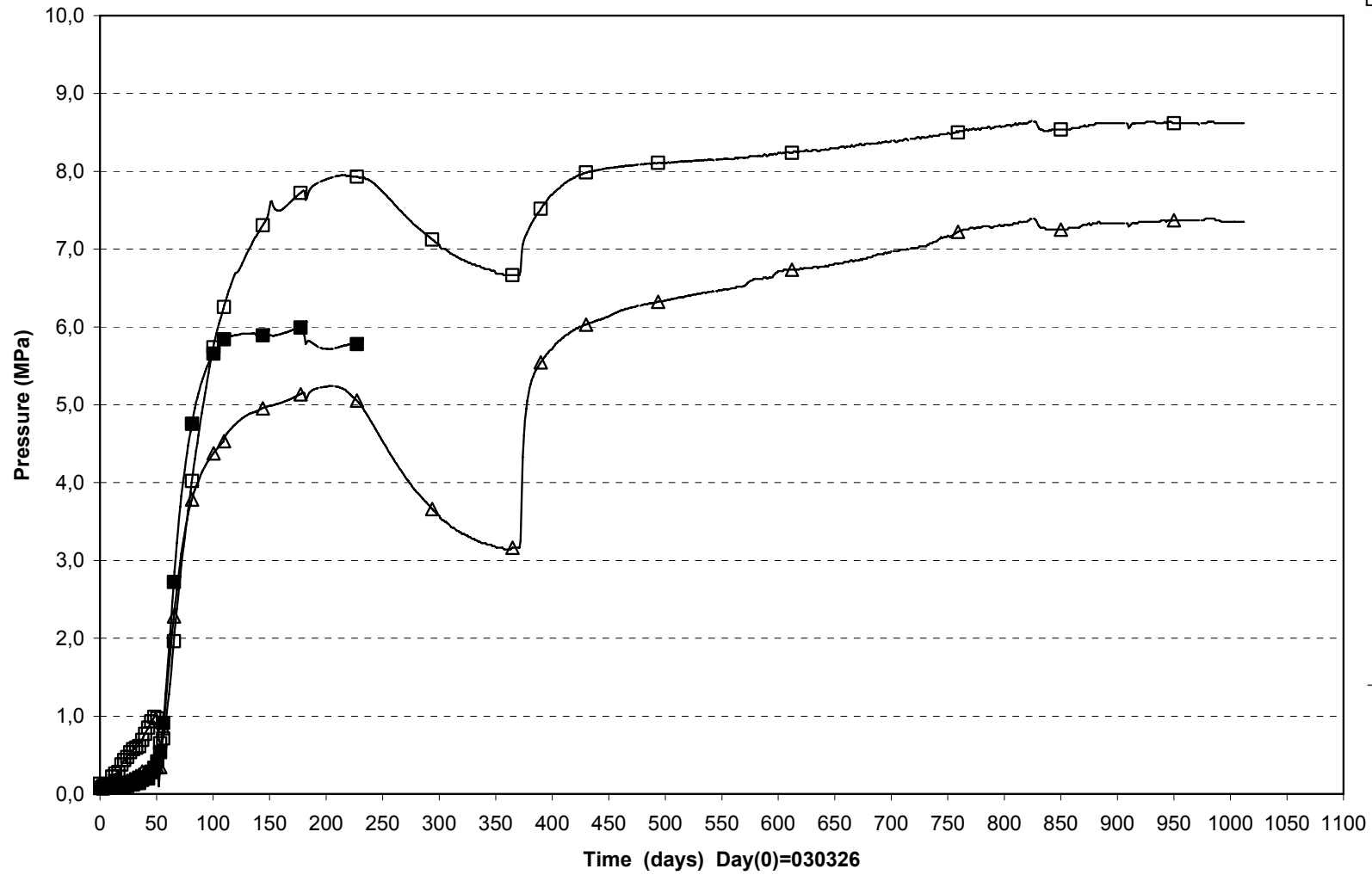

□ PB218(5.500\340°\0.635\A) ■ PB221(5.500\70°\0.710\A) △ PB223(5.500\160°\0.745\A)

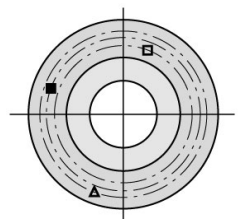
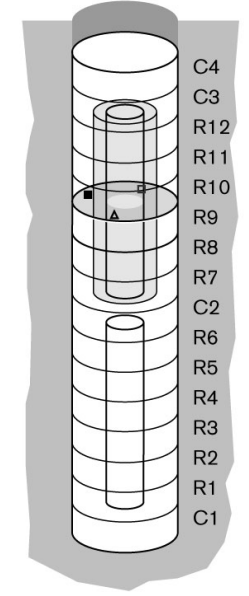
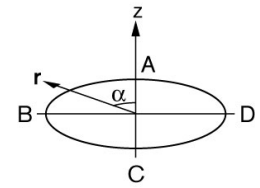

Total pressure/Cyl.3 (030326-060101)
Geokon

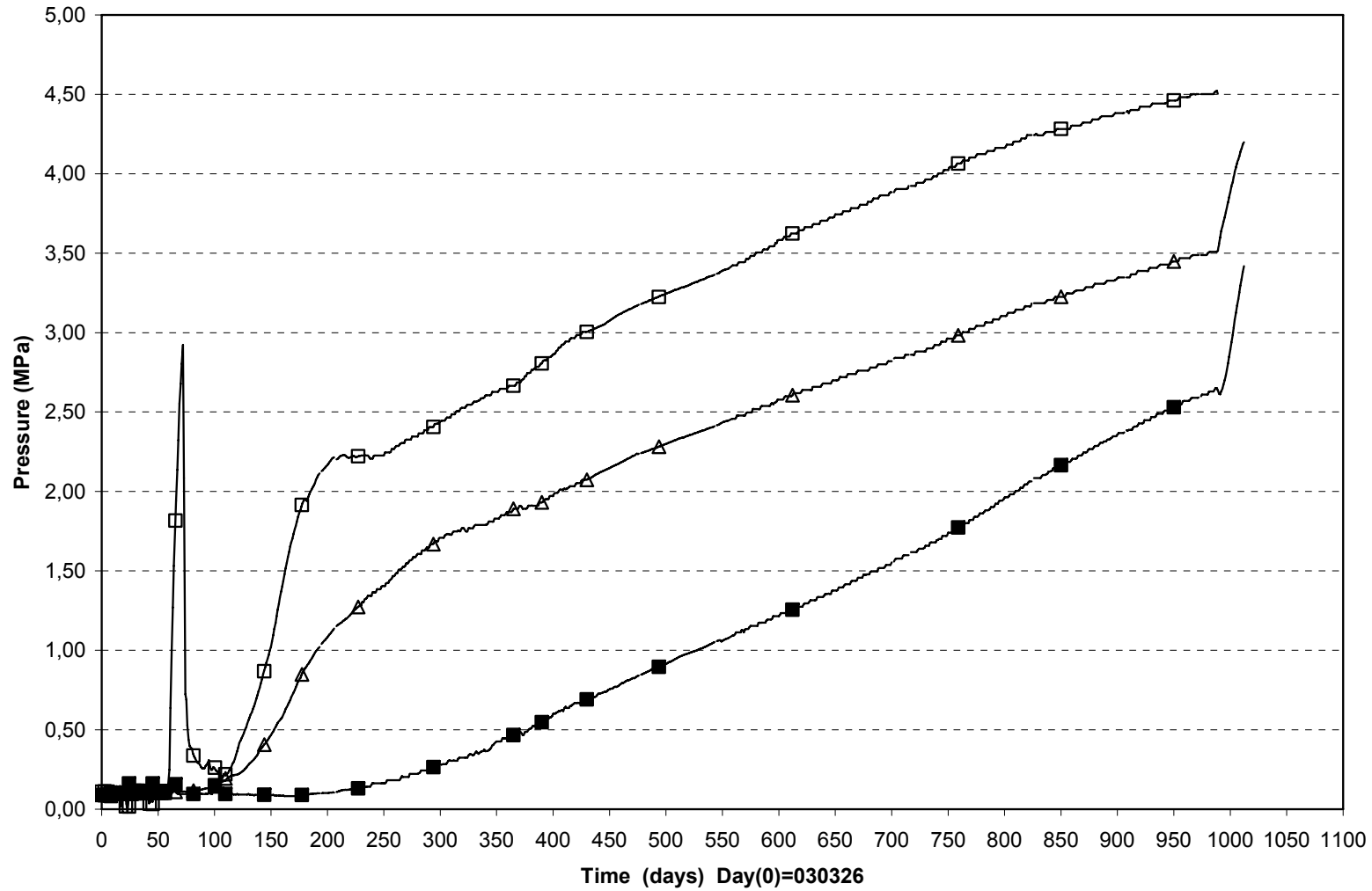

□ PB227(7.500\340°\0.635\A) ■ PB228(7.450\0°\0.635\R) △ PB229(7.450\20°\0.635\T)

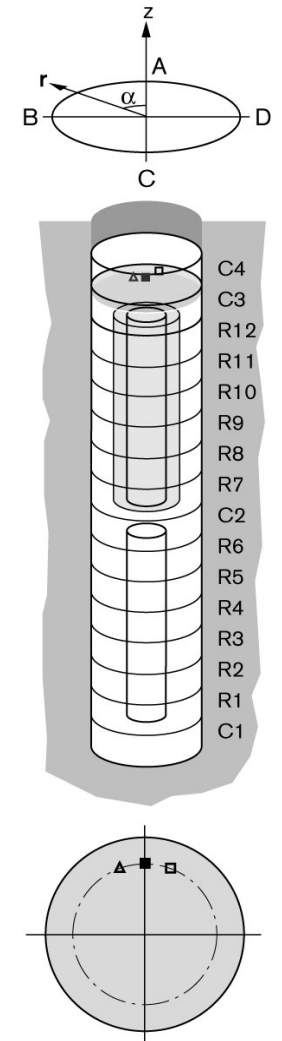

TBT\ Cyl.1 (030326-060101)
Suction - Wescor

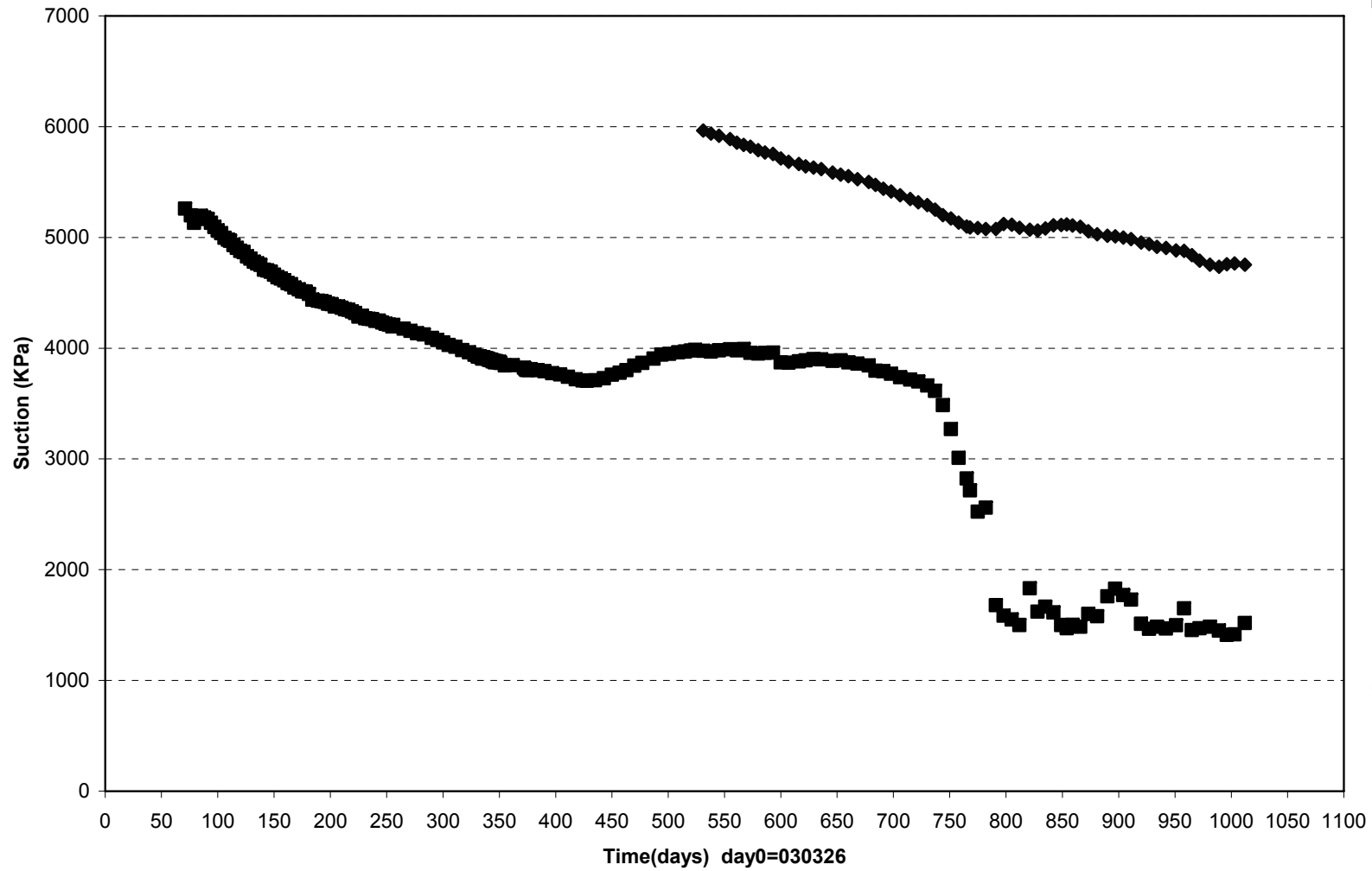

◆ WB203(250\235°\635) ■ WB205(250\280°\785)

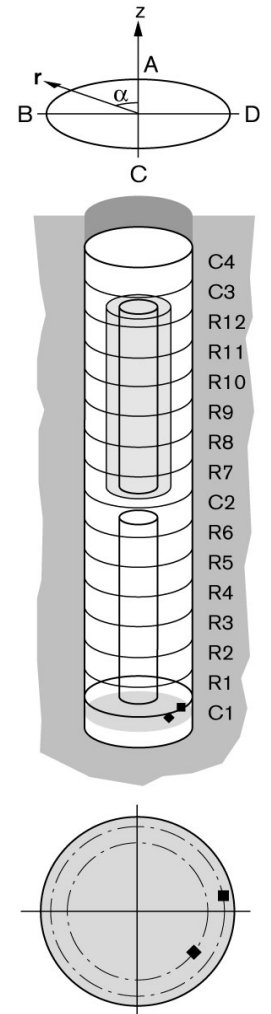

TBT\ Ring 4 (030326-060101)
Suction - Wescor

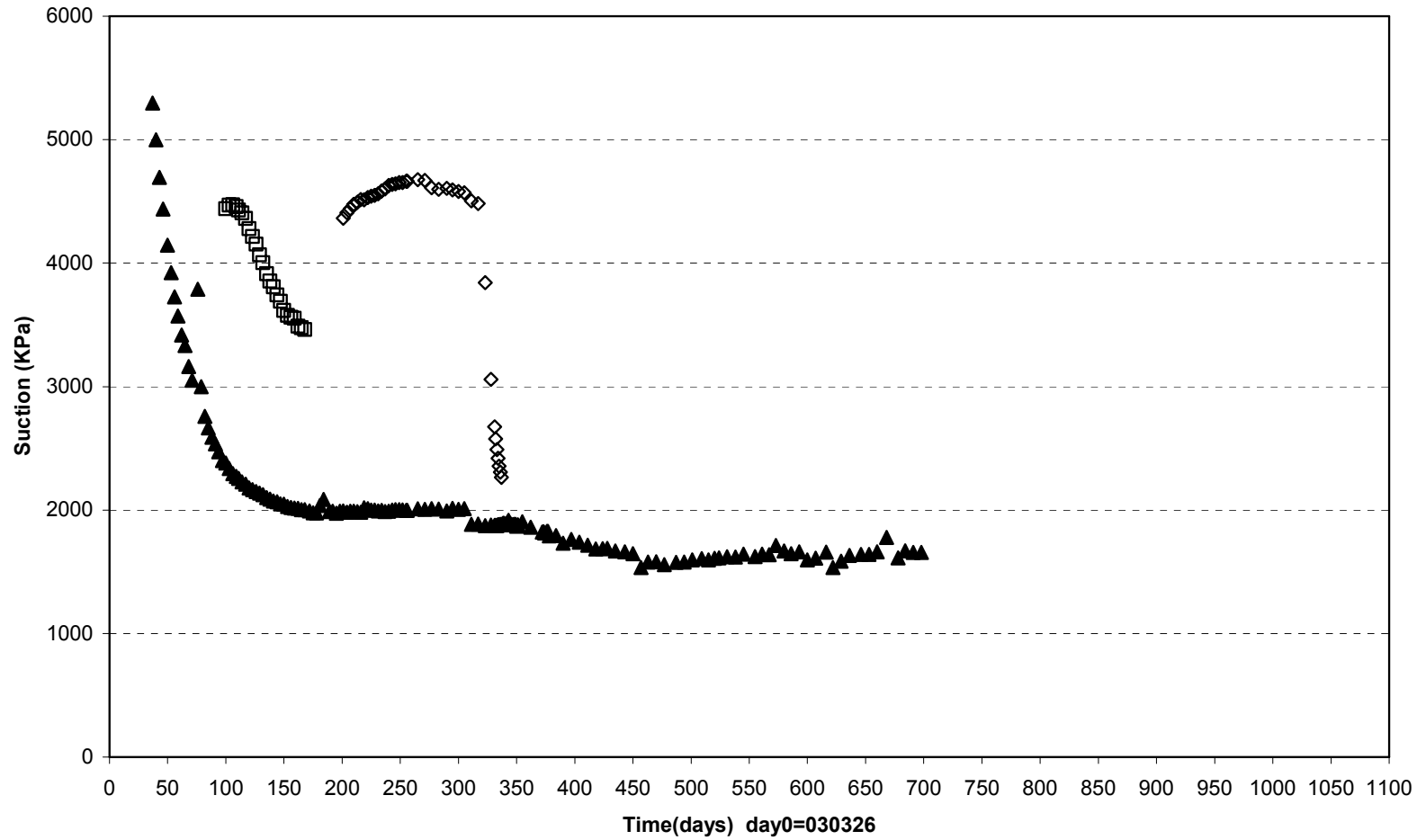

◇ WB211(2250\325°\635) □ WB213(2250\10°\710) ▲ WB215(2250\55°\785)

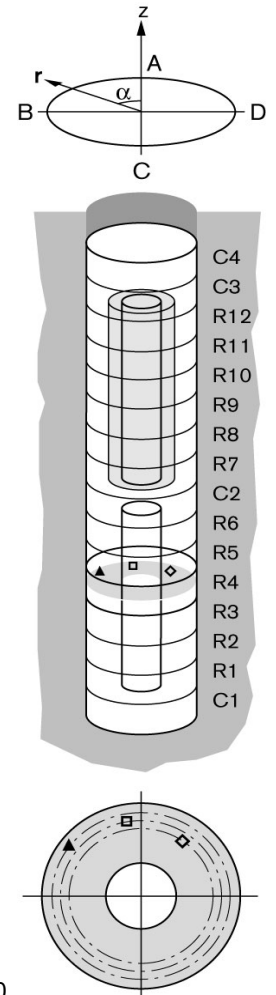

TBT\ Cyl.2 (030326-060101)
Suction - Wescor

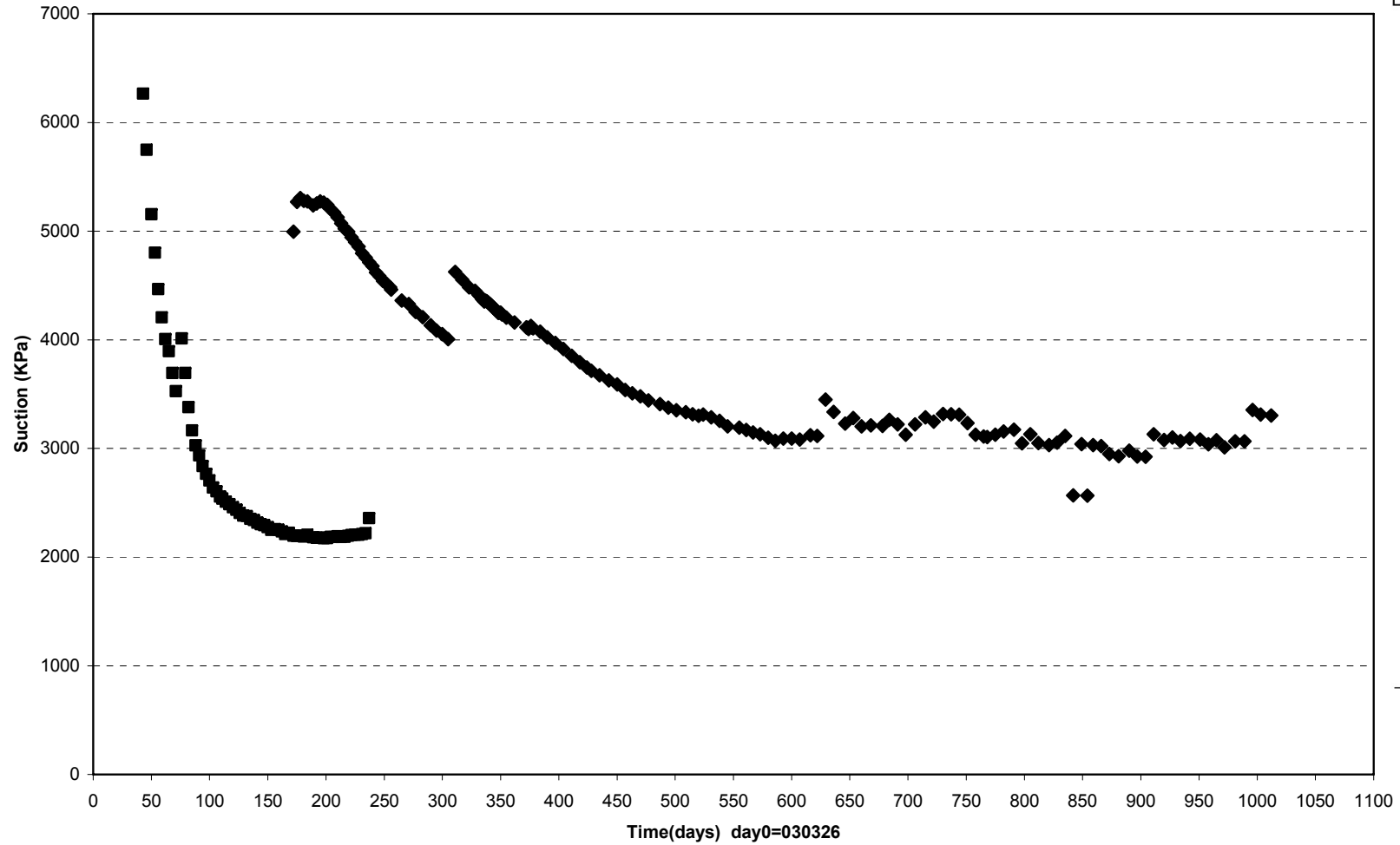

◆ WB218(3750\235°\635) ■ WB220(3750\280°\785)

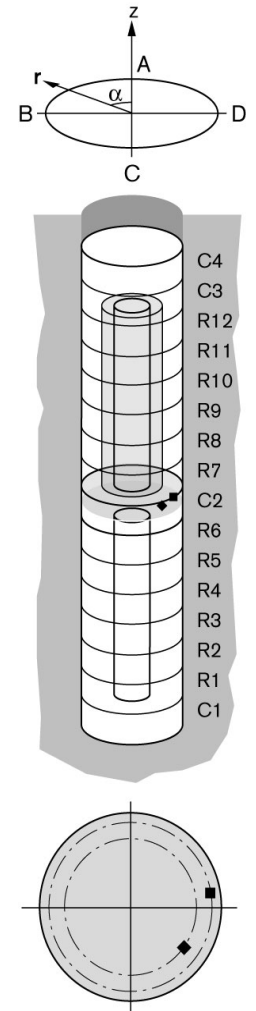

TBT\ Ring 10 (030326-060101)
Suction - Wescor

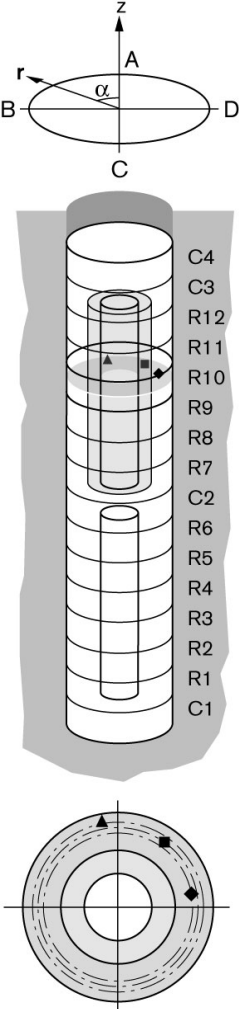
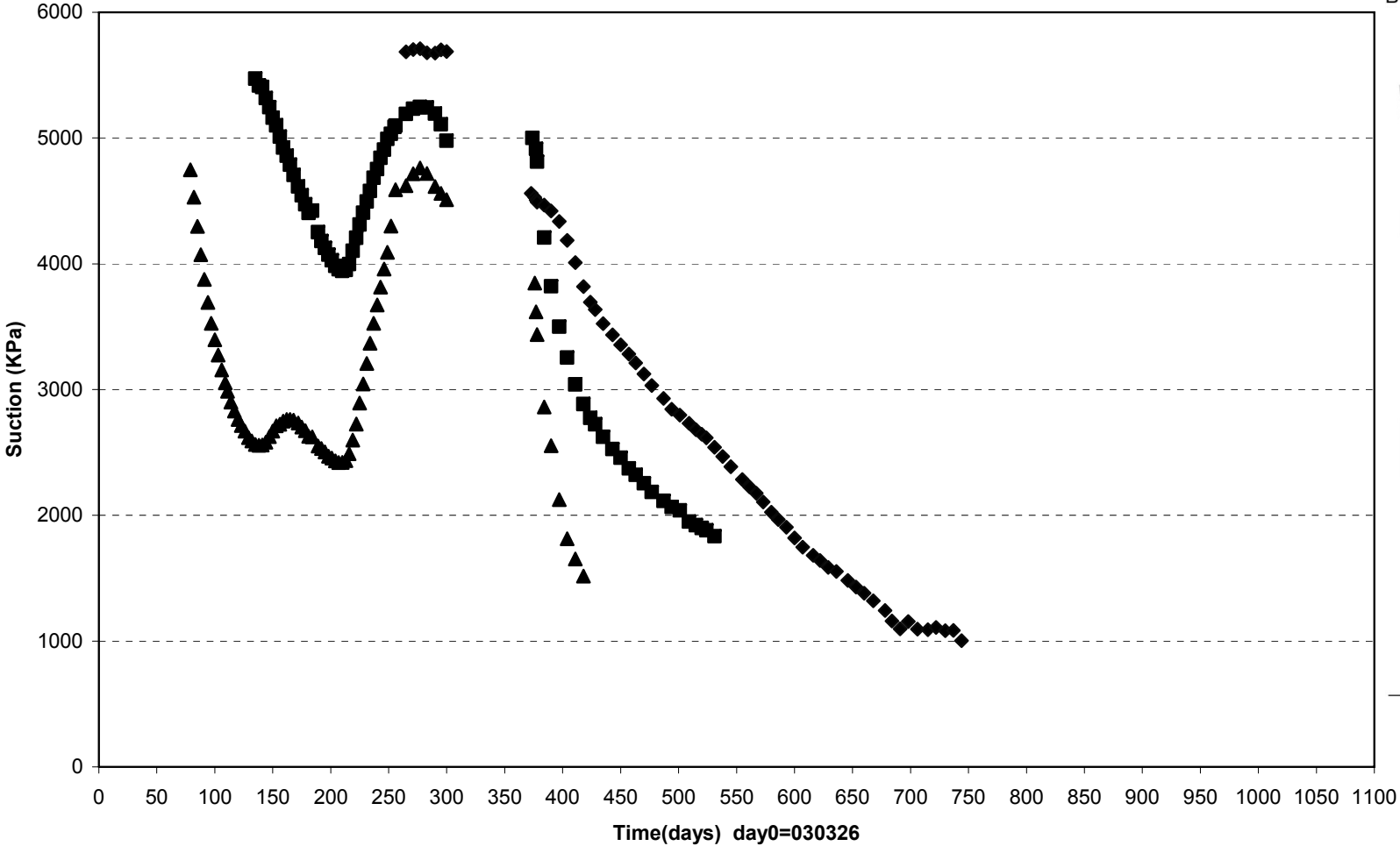

◆ WB226(5750\280°\685) ■ WB228(5750\325°\735) ▲ WB230(5750\10°\785)

TBT\ Cyl.3 (030326-060101)
Suction - Wescor

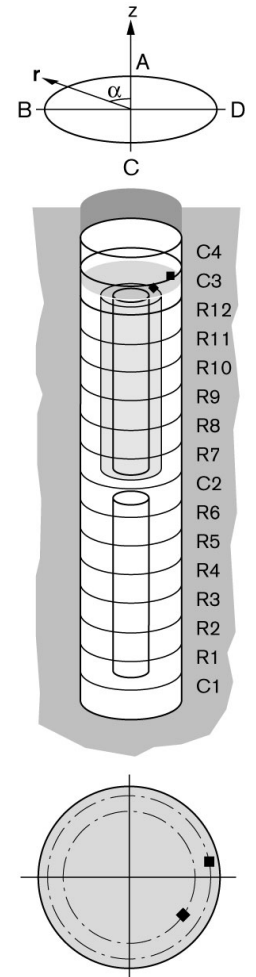
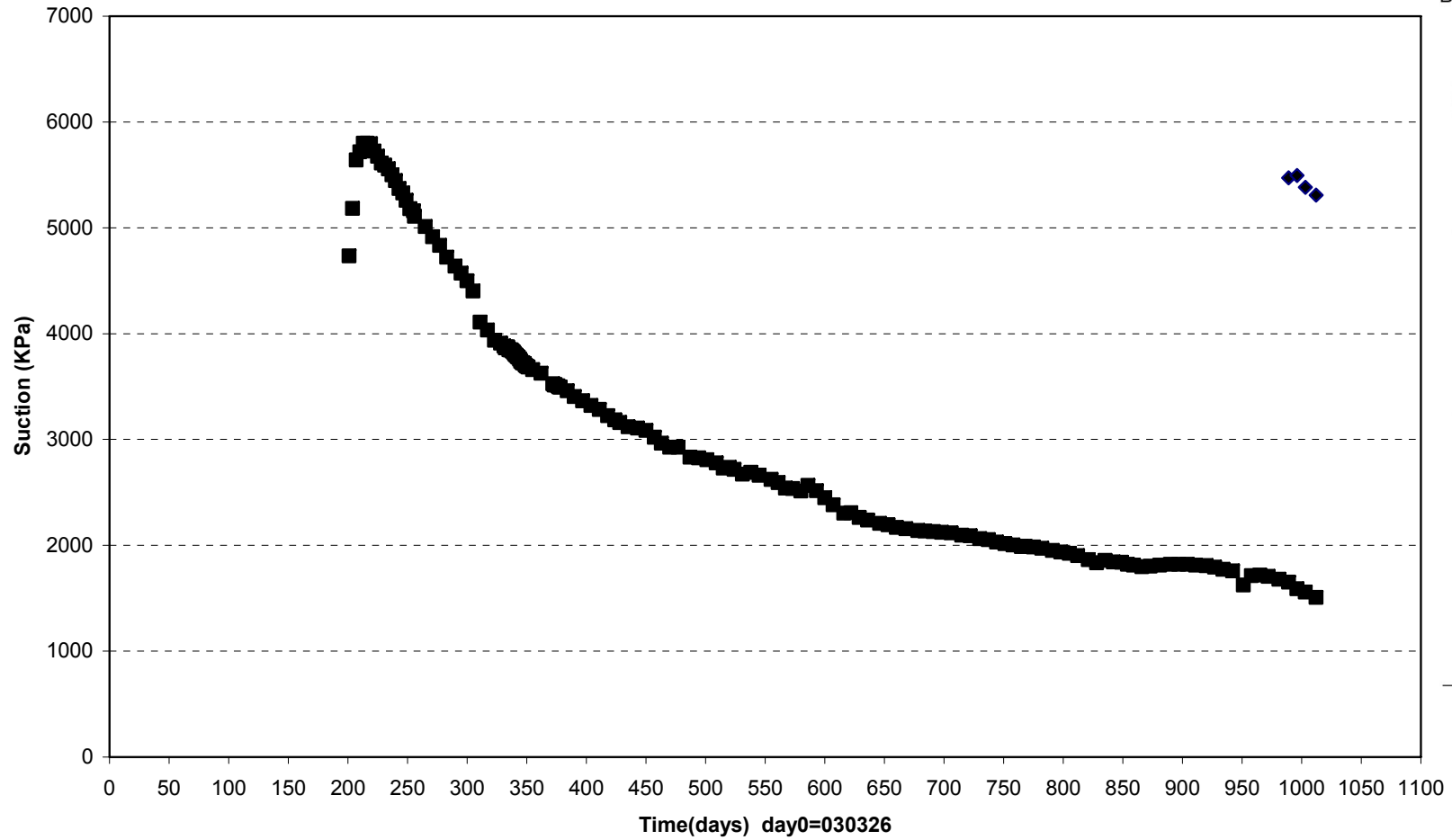

◆ WB233(7250\235°\635) ■ WB235(7250\280°\785)

TBT\Cyl.1 (030326-060101)
 Relative humidity - Vaisala & Rotronic

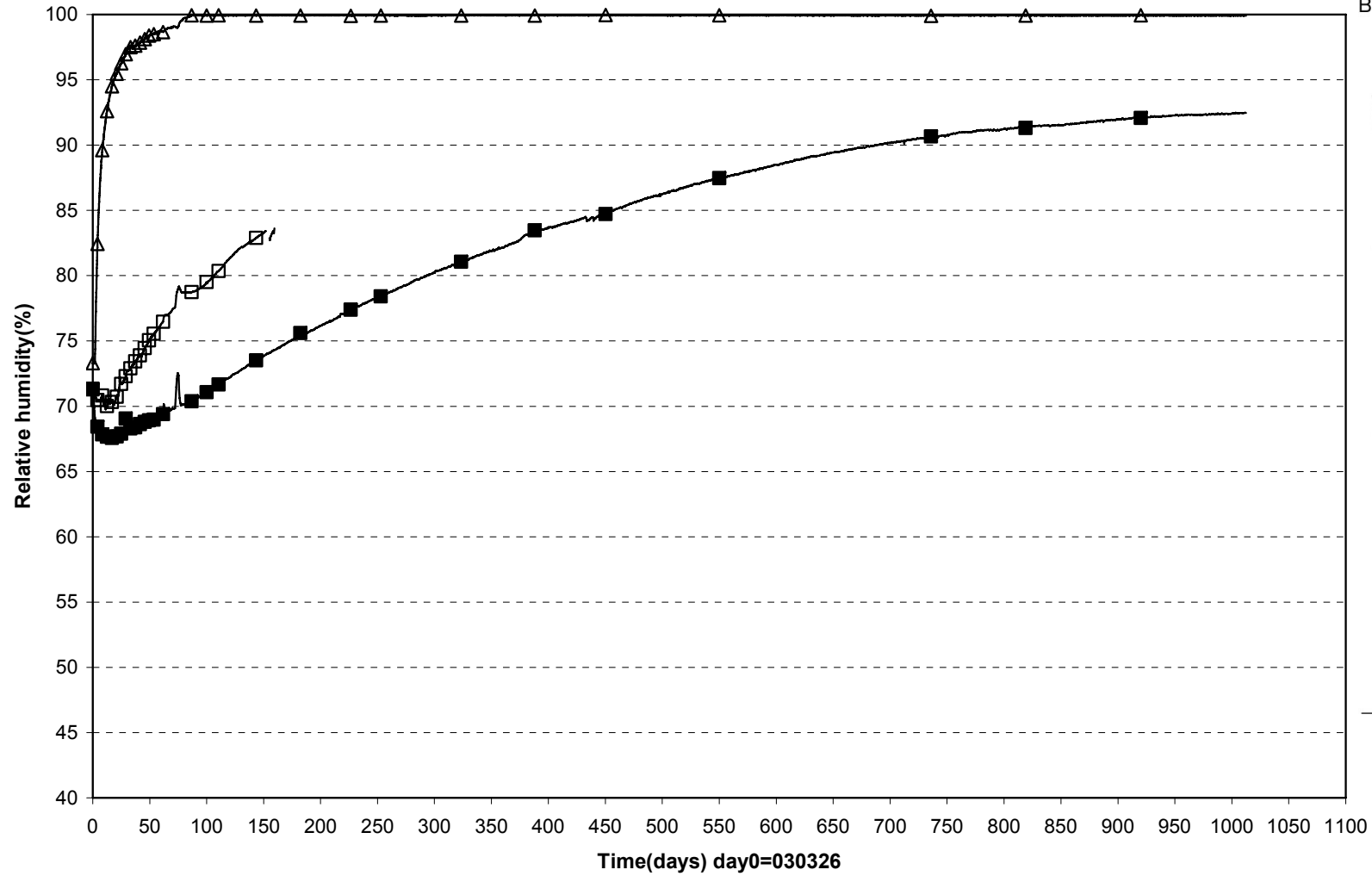

■ WB201(250\180°\420) □ WB202(250\225°\635) △ WB204(250\270°\785)

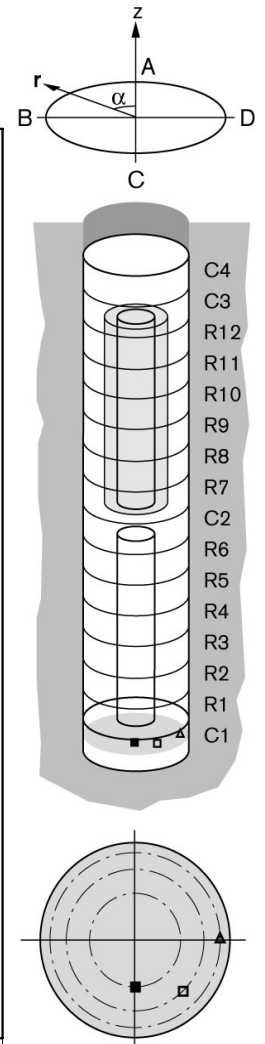

TBT\ Ring 4 (030326-060101)
Relative humidity - Vaisala & Rotronic

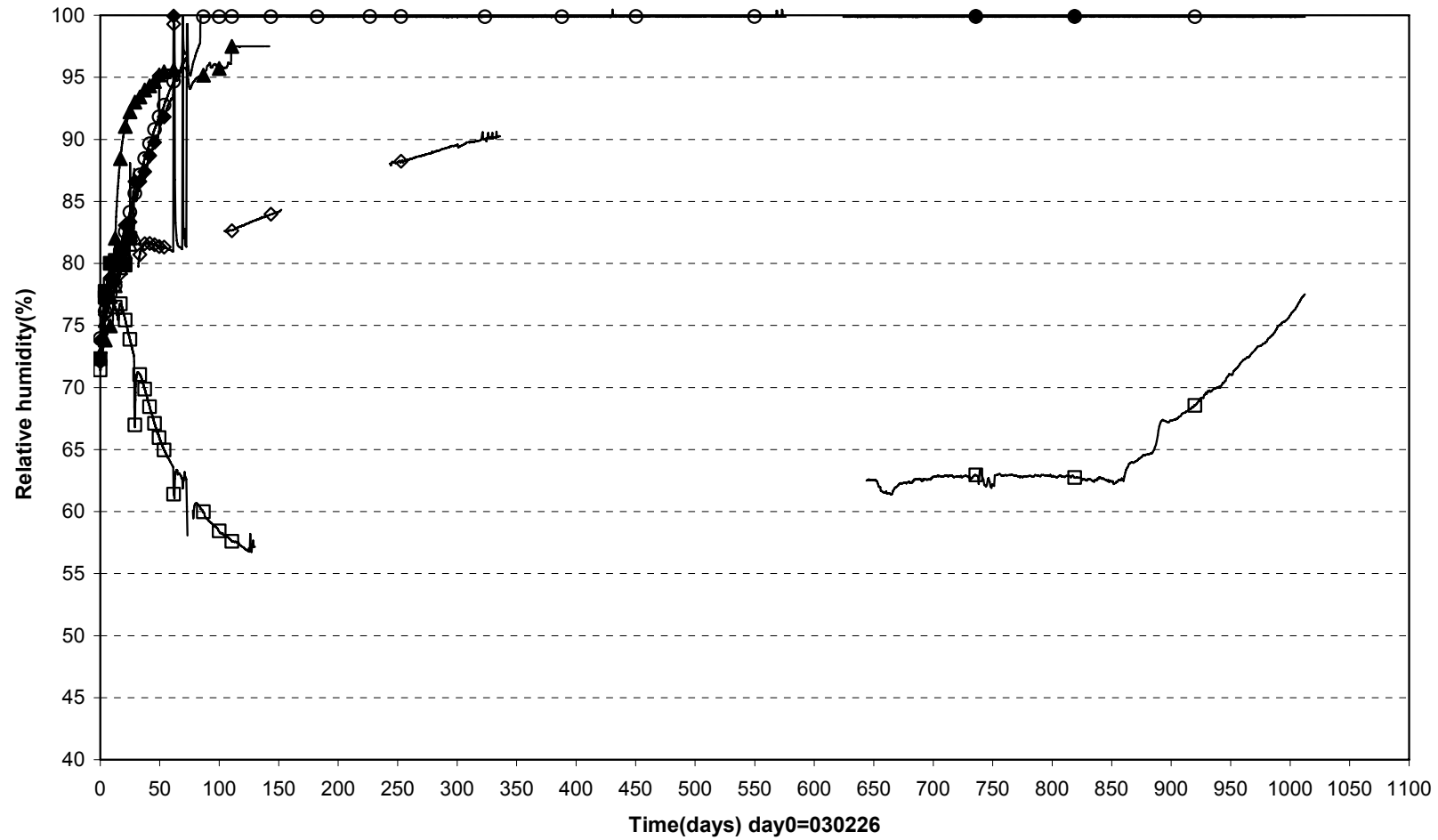

□ WB206(2250\135°\360) ■ WB207(2250\180°\420) ◇ WB208(2250\225°\485) ◆ WB209(2250\270°\560) ▲ WB210(2250\315°\635)
 ○ WB212(2250\ 0°\710) ▲ WB214(2250\45°\785)

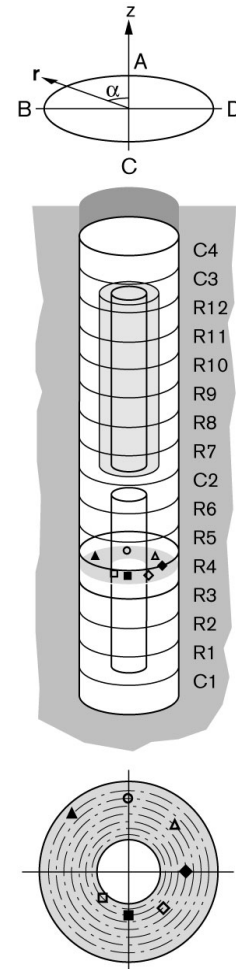

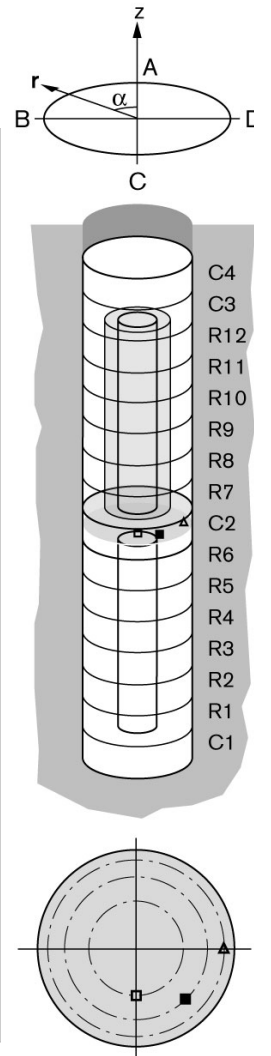
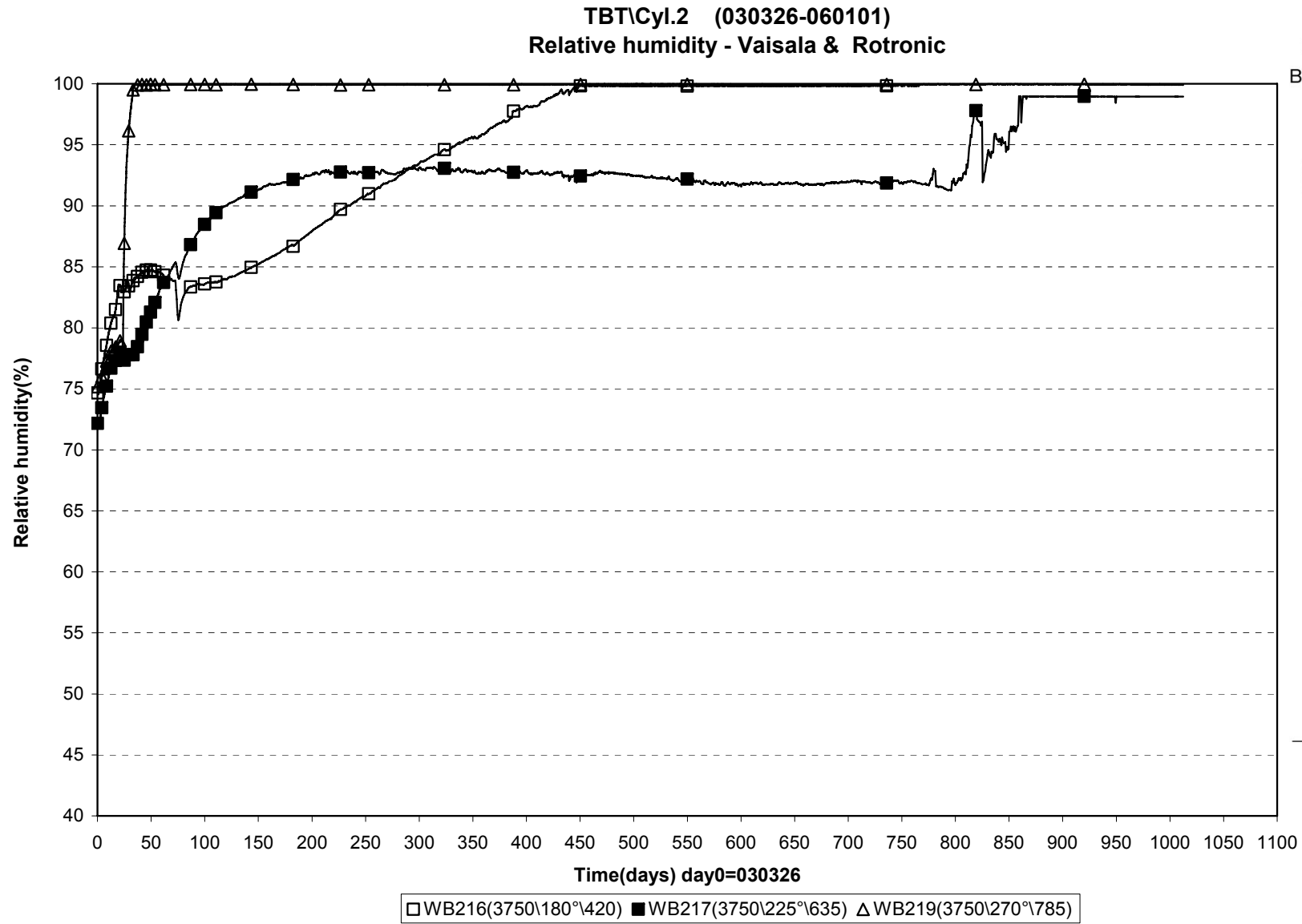

TBT\ Ring 9-10 (030326-060101)
 Relative humidity - Vaisala & Rotronic

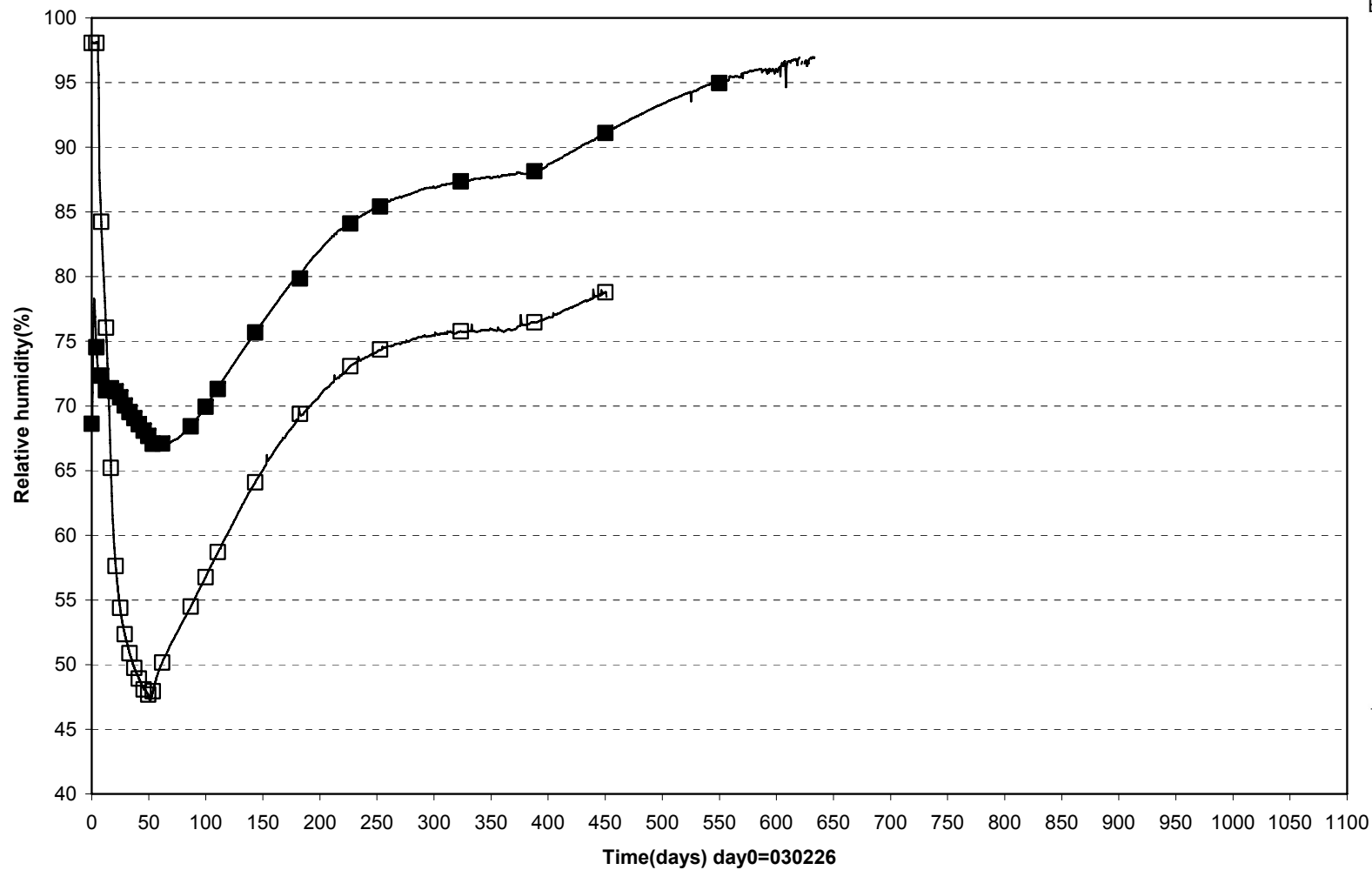

□ WB221(5250\135°\525) ■ WB222(5750\135°\525)

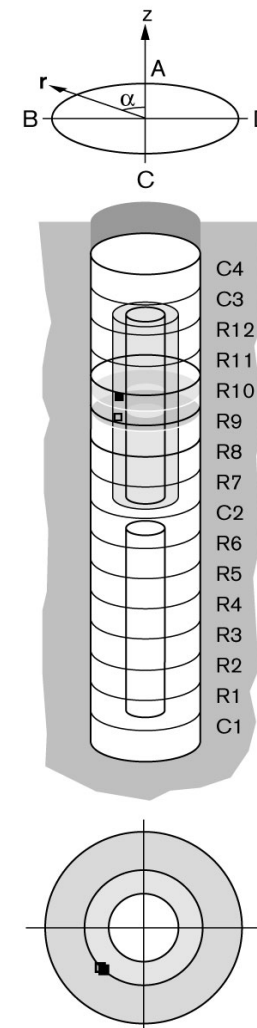

TBT\ Ring 10 (030326-060101)
Relative humidity - Vaisala & Rotronic

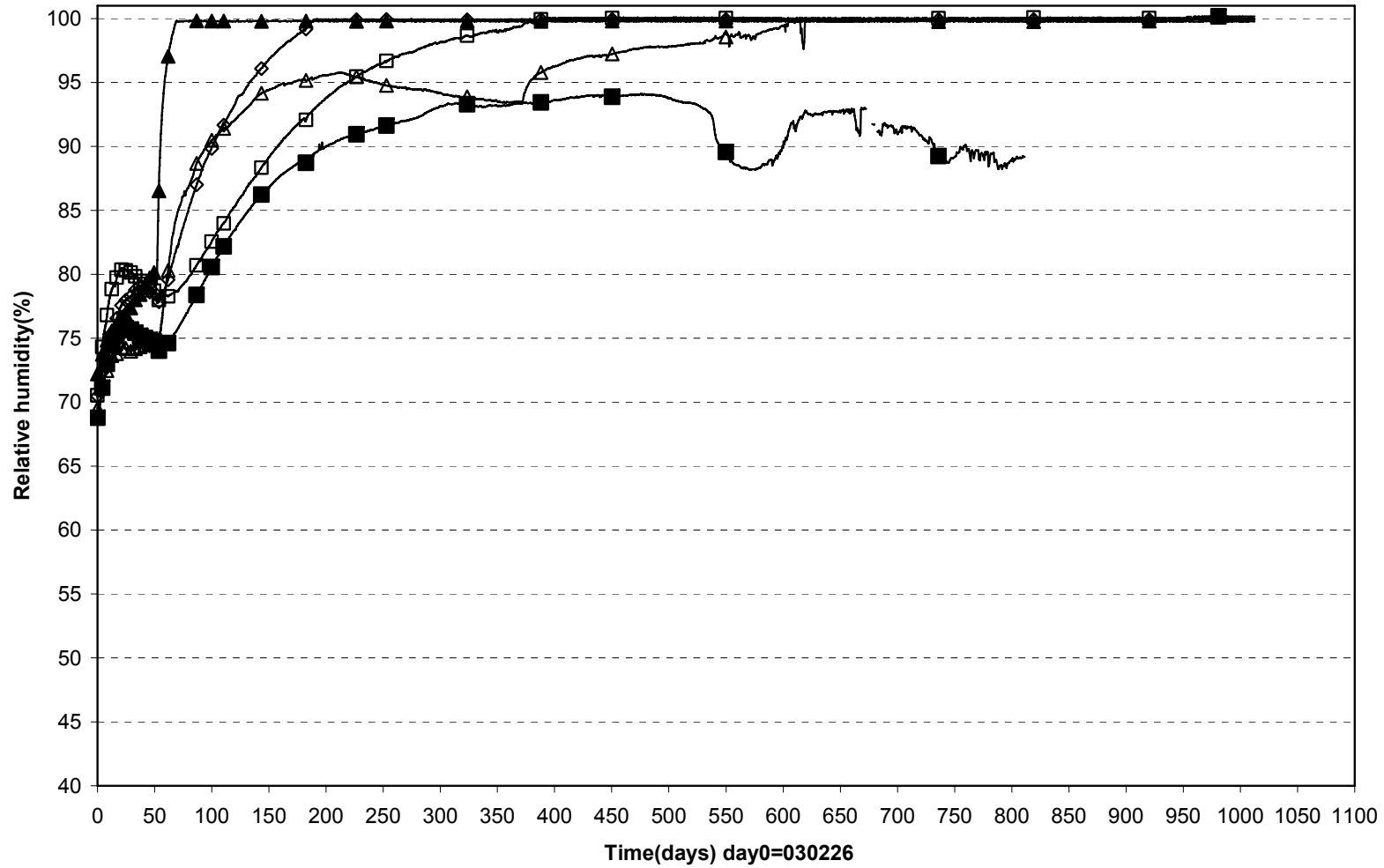

□ WB223(5750\180°\585) ■ WB224(5750\225°\635) ◇ WB225(5750\270°\685) △ WB227(5750\315°\735) ▲ WB229(5750\ 0°\785)

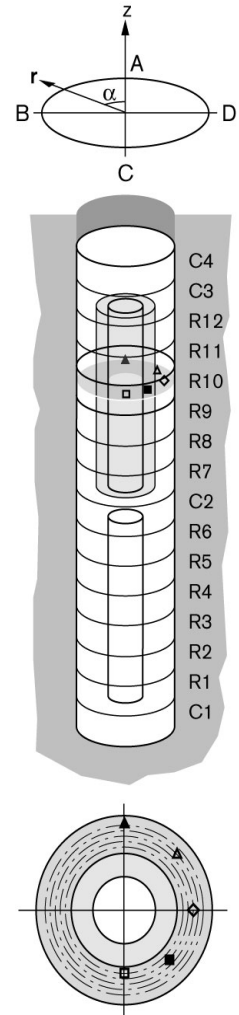

TBT\Cyl.3 (030326-060101)
 Relative humidity - Vaisala & Rotronic

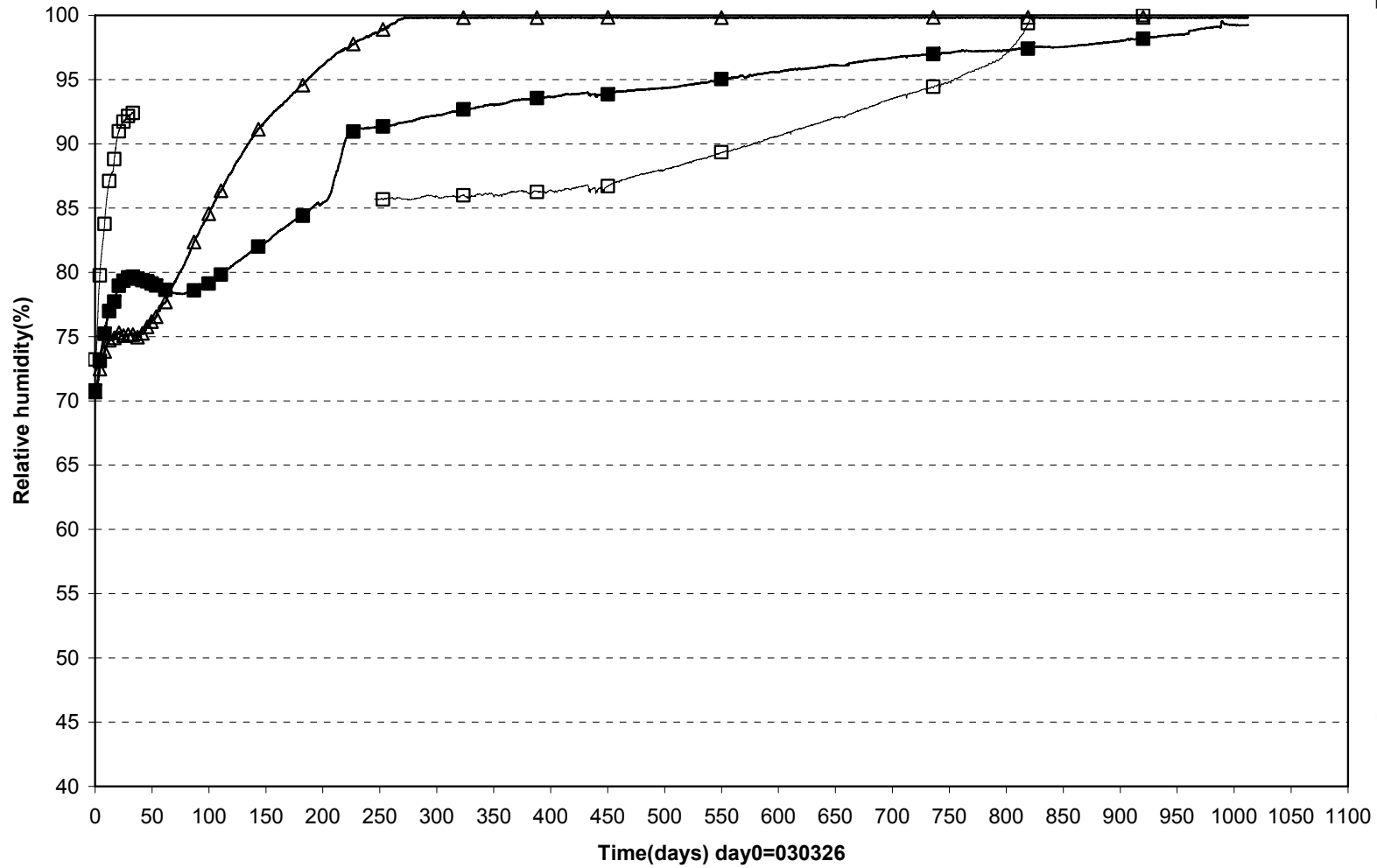

□ WB231(7250\ 180°\420) ■ WB232(7250\225°\635) △ WB234(7250\ 270°\785)

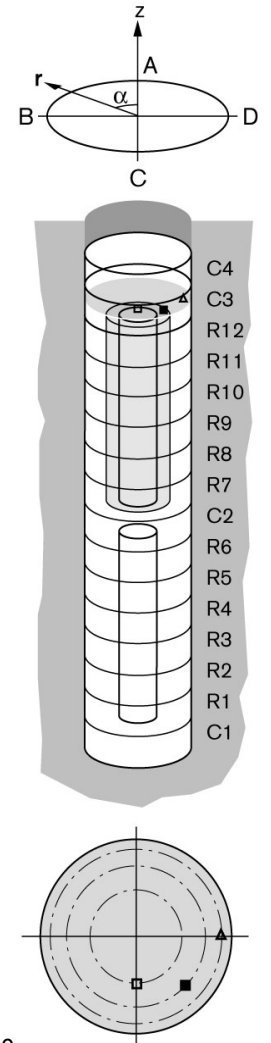

Pore pressure/Ring 3 (030326-060101)
Geokon

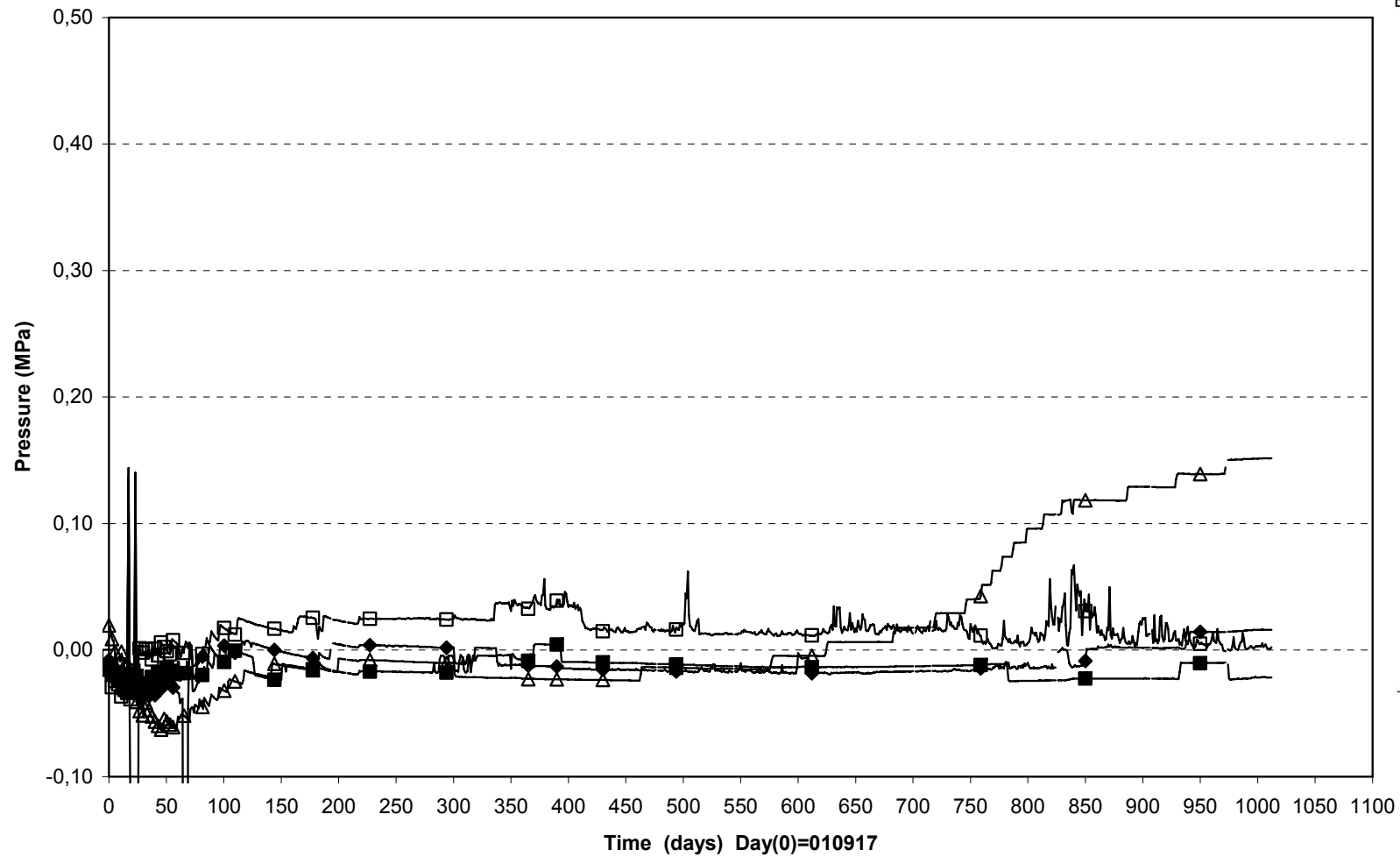

□ UB201(1.750\270°\0.420\R) ■ UB202(1.750\350°\0.535\R) ◆ UB203(1.750\90°\0.635) △ UB204(1.750\280°\0.785)

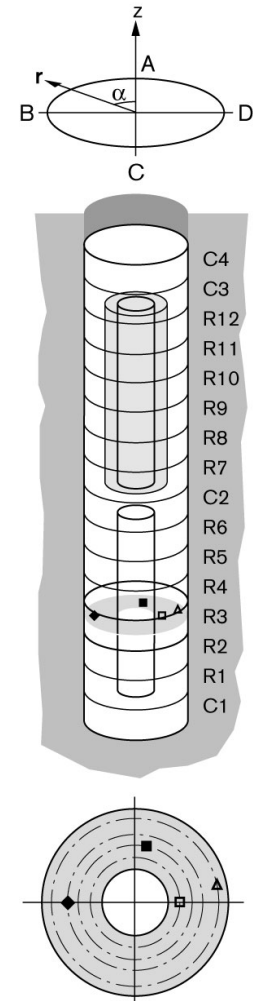

Pore pressure/Ring 9 (030326-060101)
Geokon

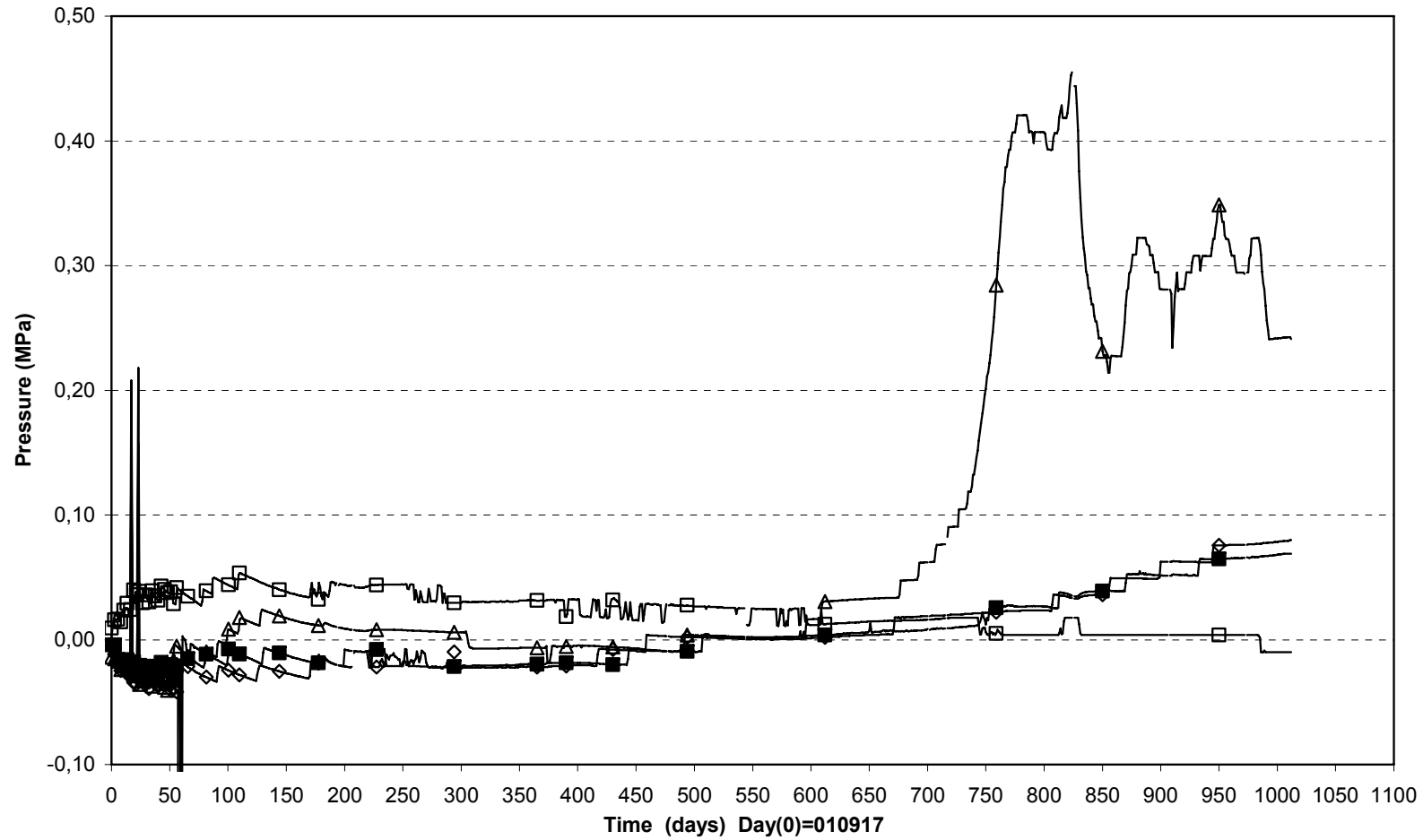

□ UB205(5.250\270°\0.420) ■ UB206(5.250\315°\0.635) ◇ UB207(5.250\90°\0.710) △ UB208(5.250\225°\0.785)

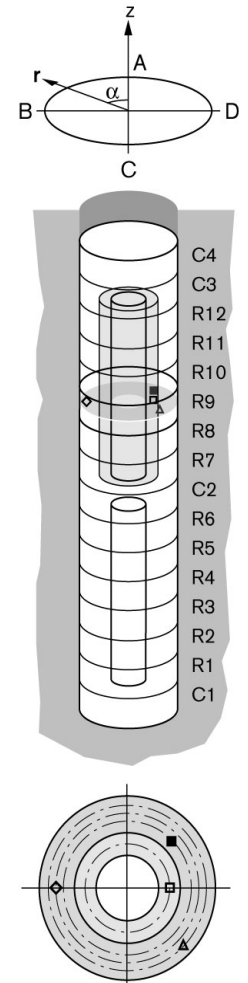

Inflow of water (030326-060101)

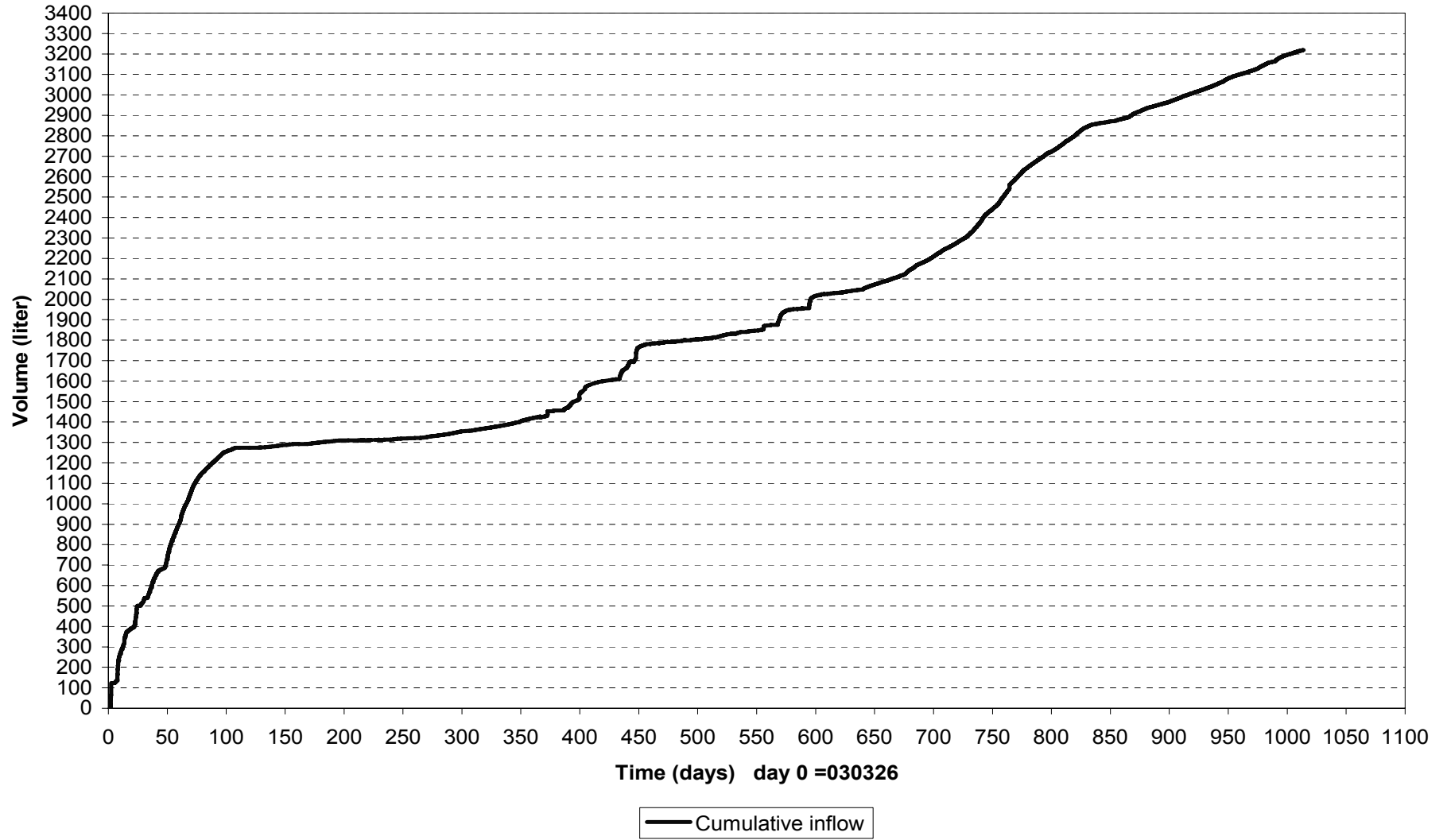

Injection pressure upstream the filter tips (030326-060101)

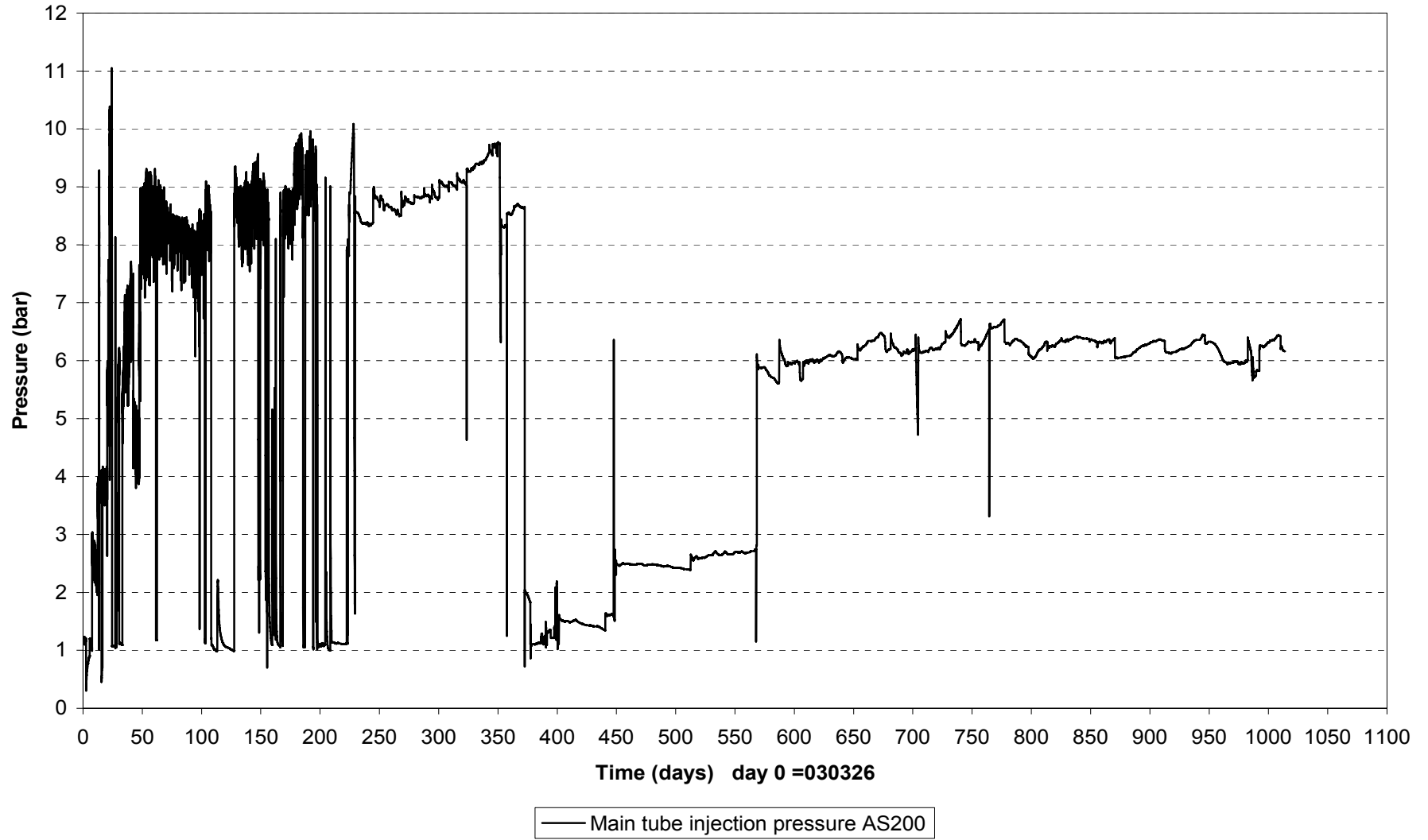

Forces on plug (030326-060101)

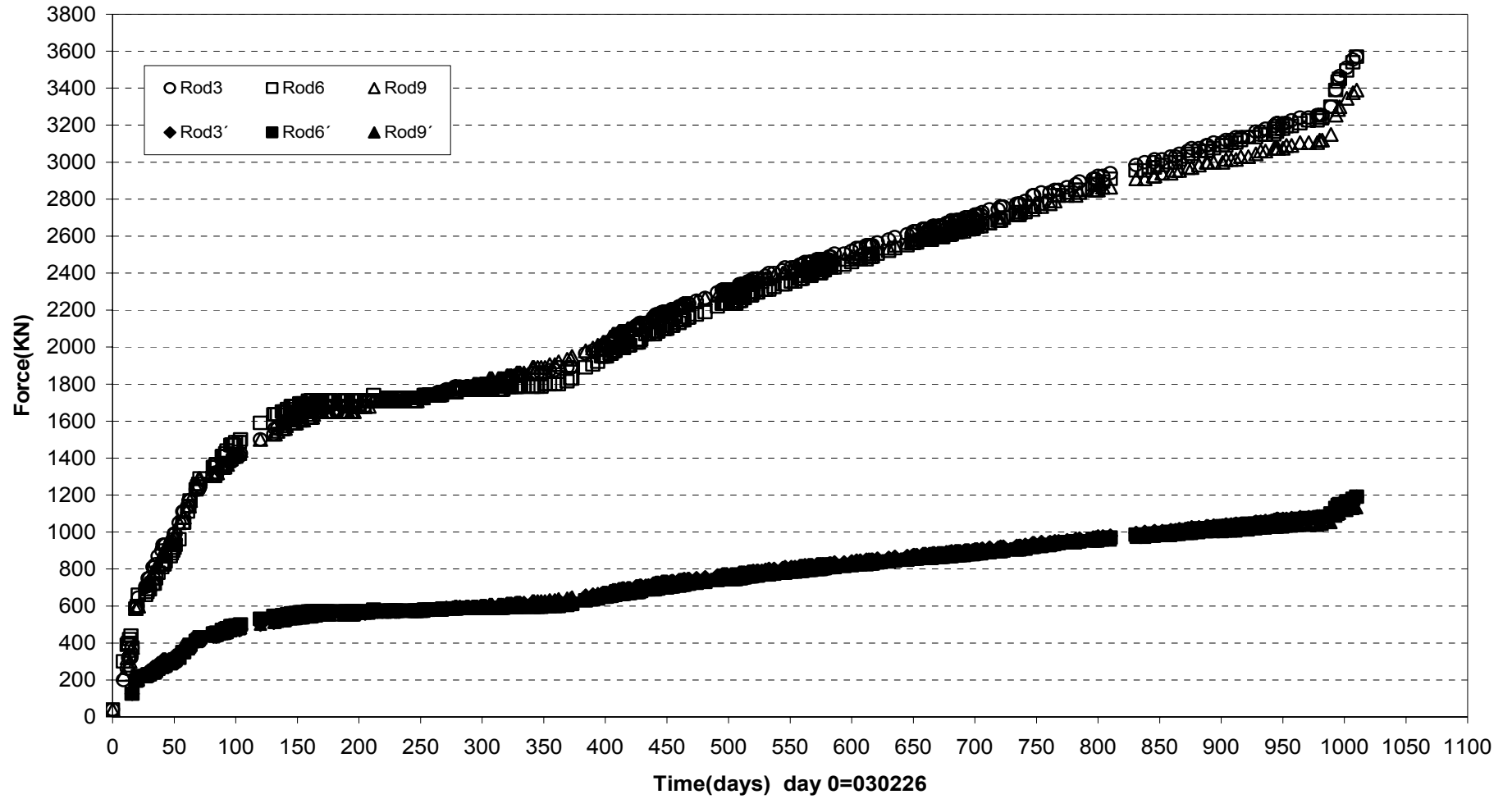

Displacement of plug (030326-060101)

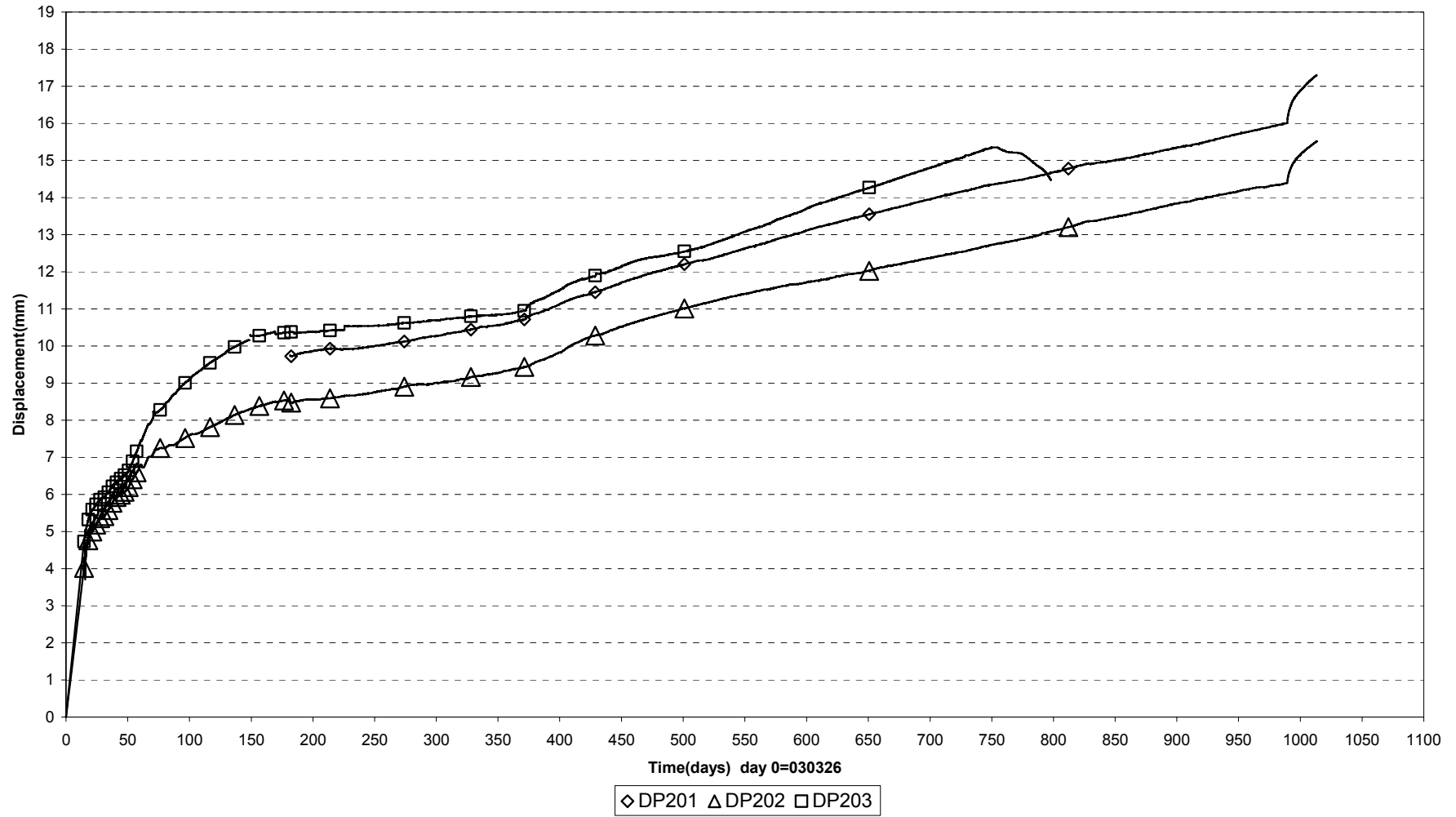

Power Heater 1 (030326-060101)

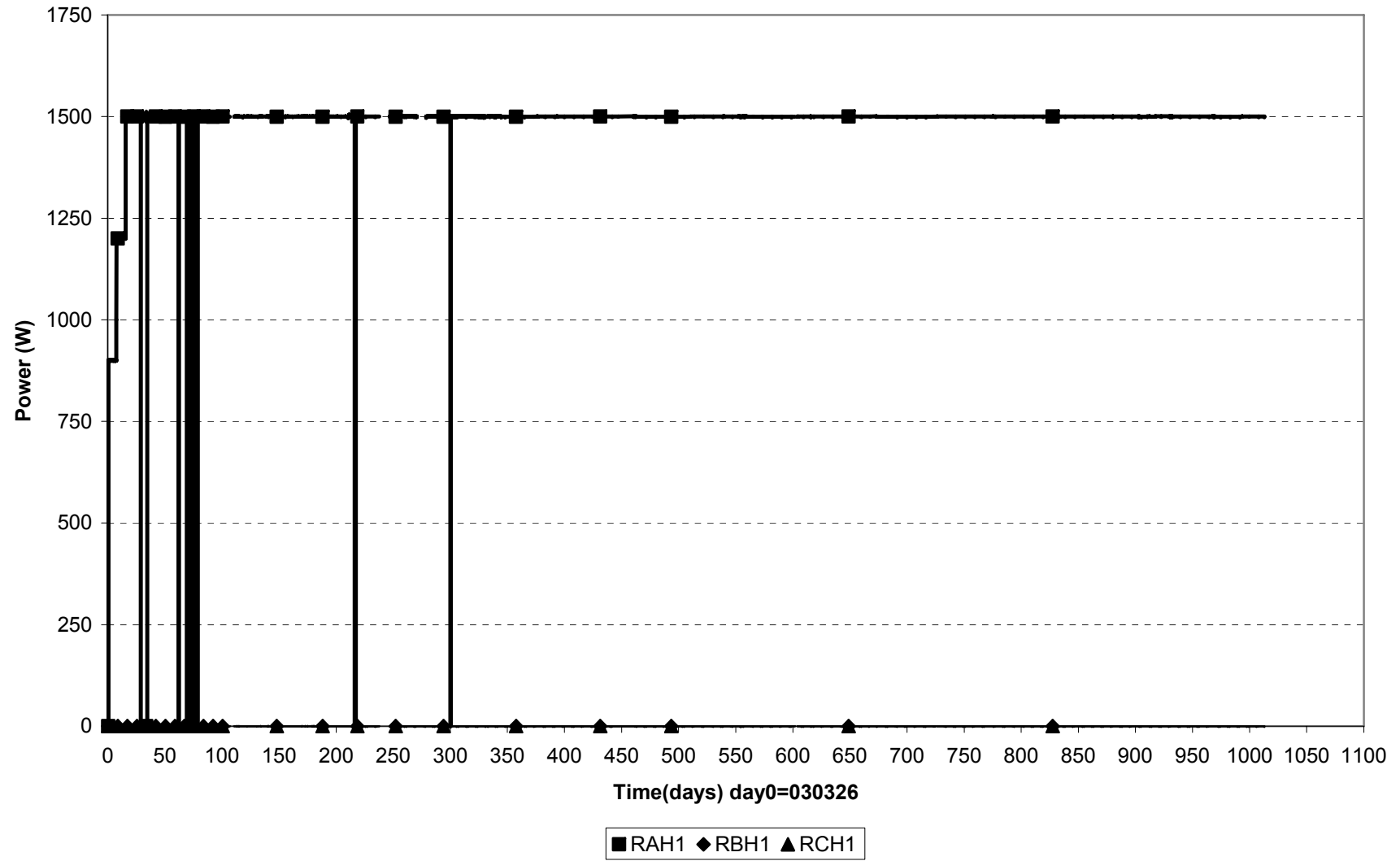

Power Heater 2 (030326-060101)

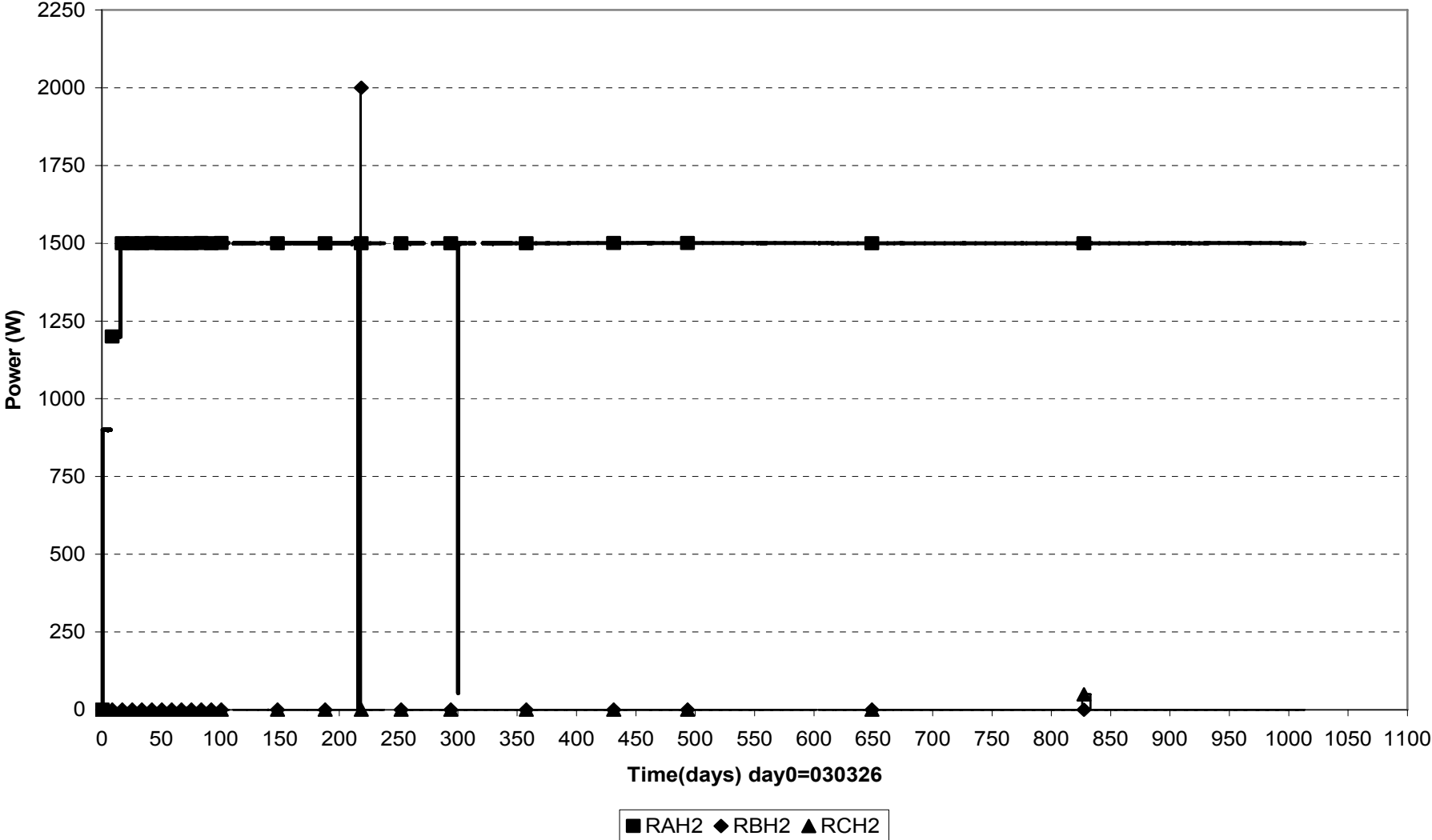

TBT\Cyl.1 (030326-060101)
 Temperature - Pentronic

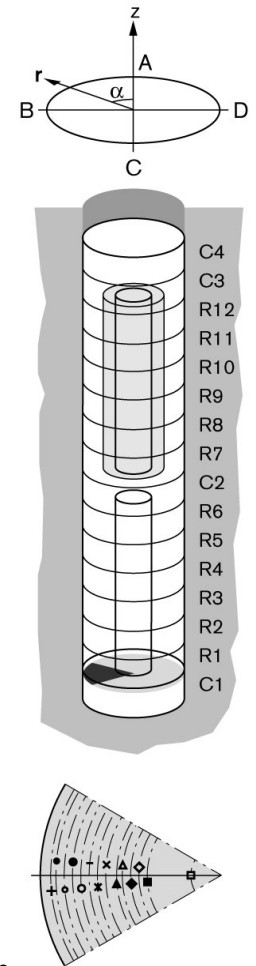
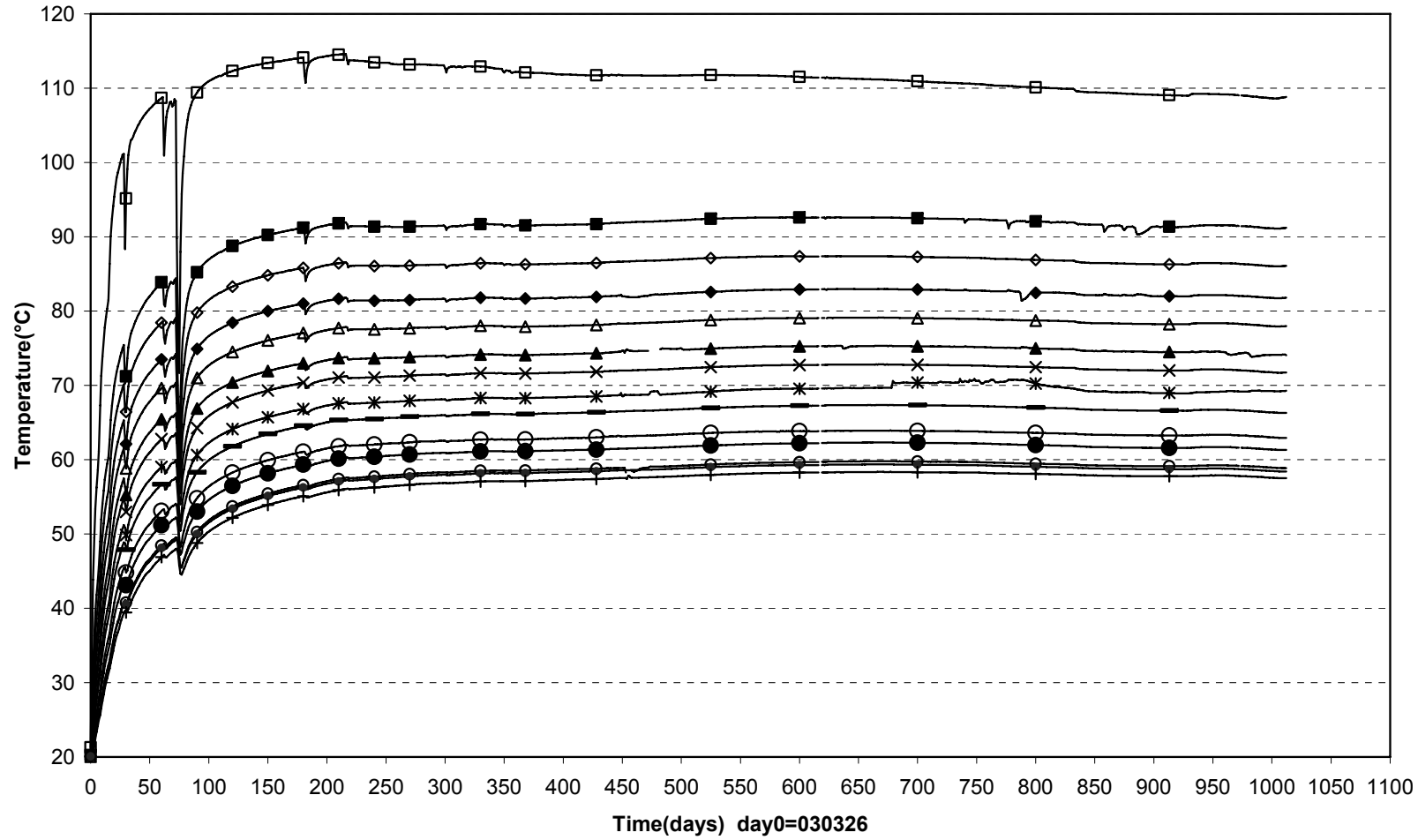

TBT \Ring4 (030326-060101)
Temperature - Pentronic

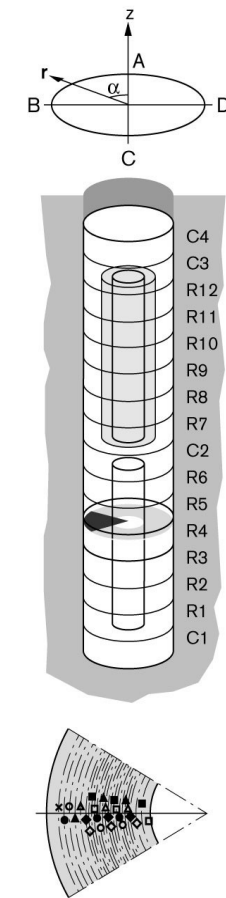
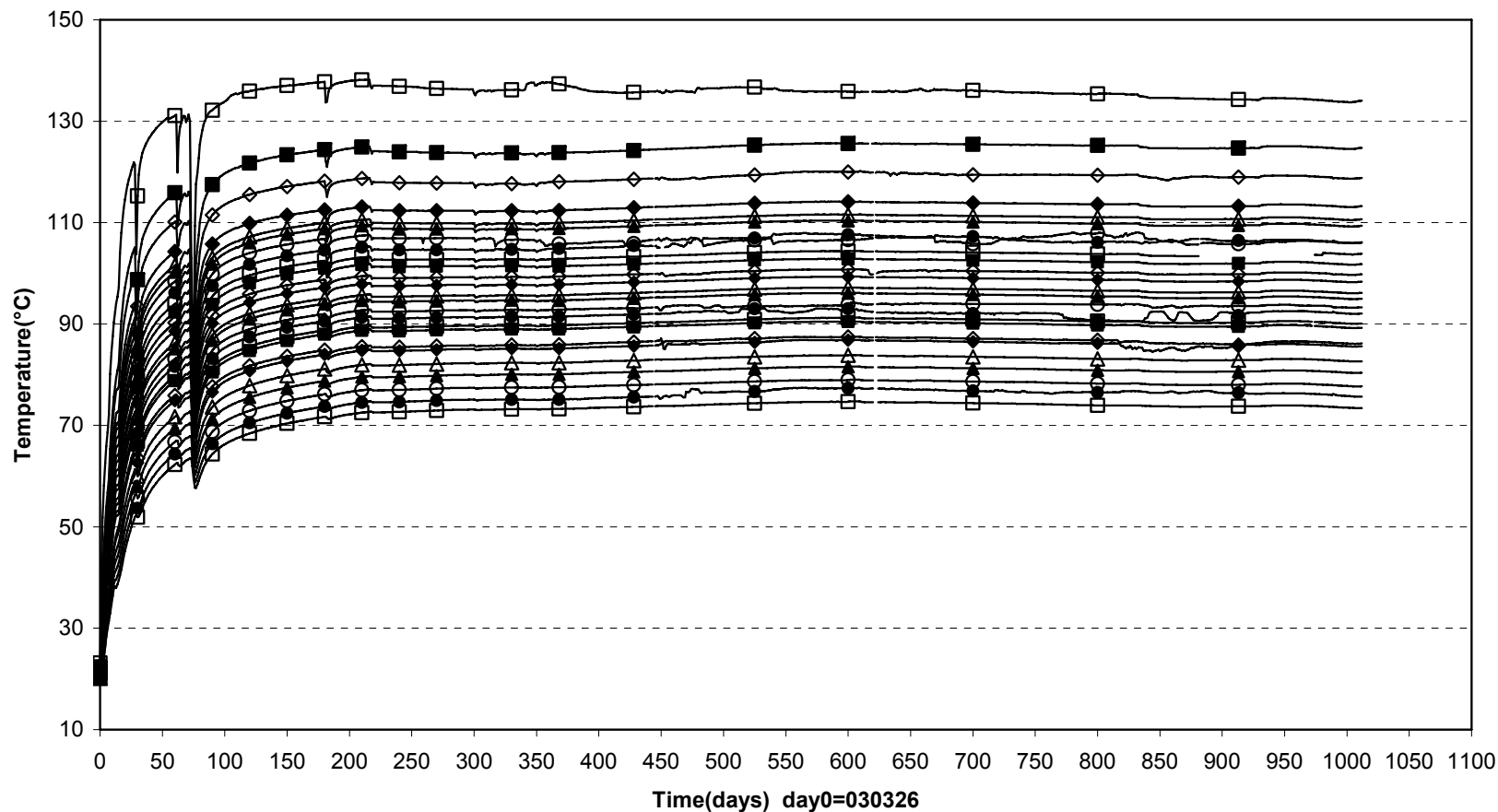

- TB215(2450\97,5°\320) ■ TB216(2450\82,5°\360) ◇ TB217(2450\97,5°\390) ◆ TB218(2450\92,5°\420) △ TB219(2450\87,5°\435)
- ▲ TB220(2450\82,5°\450) ○ TB221(2450\97,5°\465) ● TB222(2450\92,5°\480) □ TB223(2450\87,5°\495) ■ TB224(2450\82,5°\510)
- ◇ TB225(2450\97,5°\525) ◆ TB226(2450\92,5°\540) △ TB227(2450\87,5°\555) ▲ TB228(2450\82,5°\570) ○ TB229(2450\97,5°\585)
- TB230(2450\92,5°\600) □ TB231(2450\87,5°\615) ■ TB232(2450\82,5°\630) ◇ TB233(2450\97,5°\645) ◆ TB234(2450\92,5°\660)
- △ TB235(2450\87,5°\690) ▲ TB236(2450\92,5°\720) ○ TB237(2450\87,5°\750) ● TB238(2450\92,5°\780) □ TB239(2450\87,5°\810)

TBT\Cyl.2 (030326-060101)
 Temperature - Pentronic

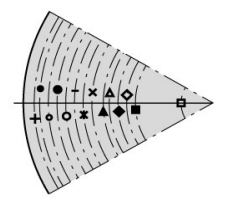
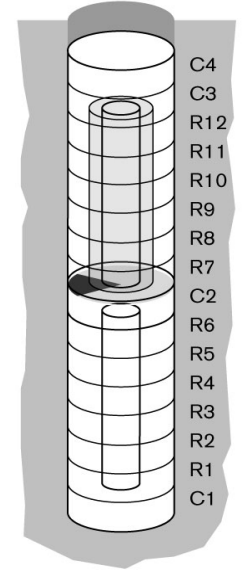
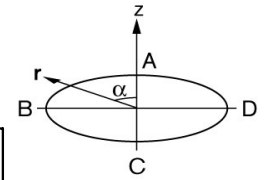
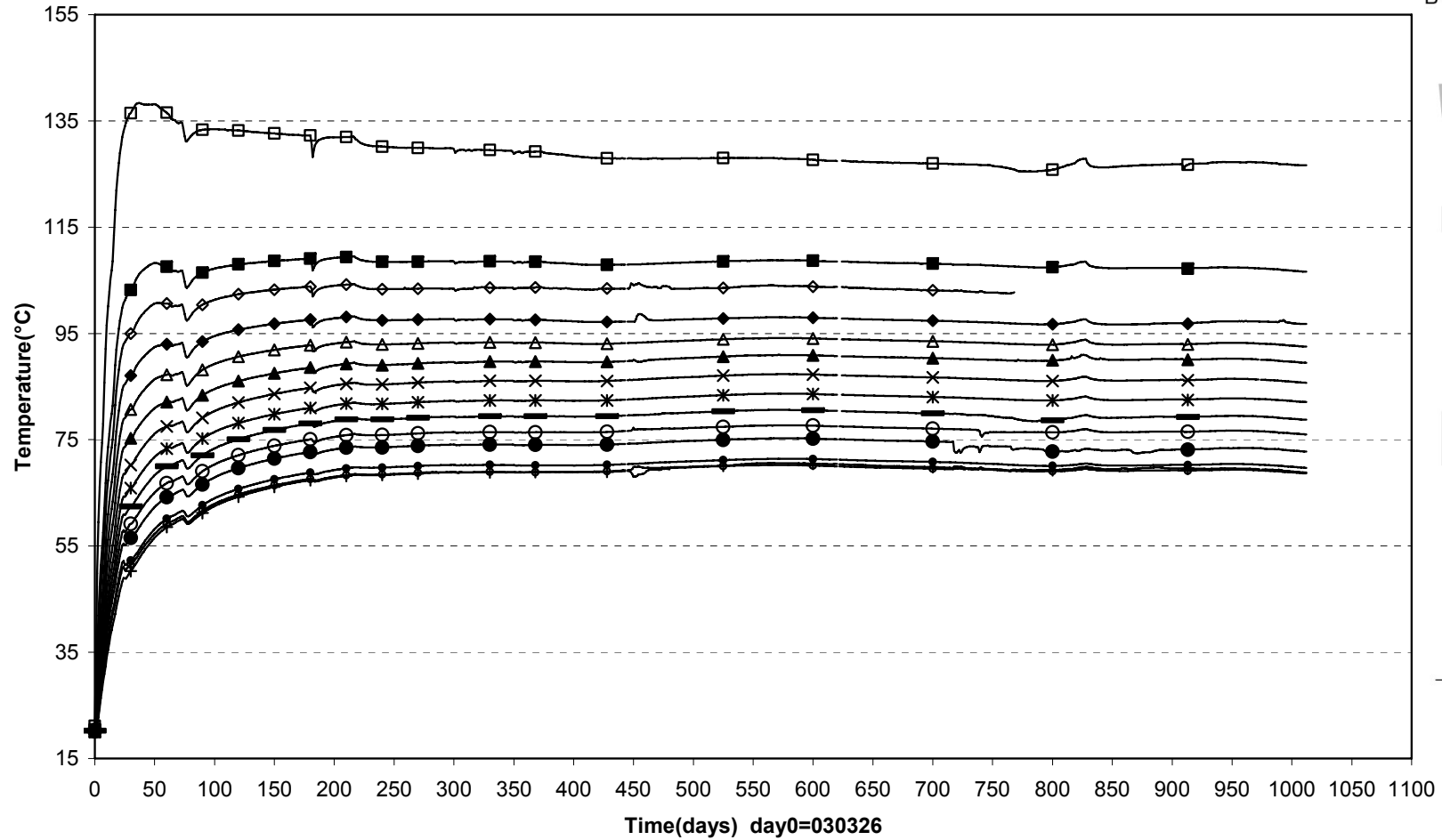

- TB240(3950\90°\150) ■ TB241(3950\95°\360) ◇ TB242(3950\85°\400) ◆ TB243(3950\95°\440) △ TB244(3950\85°\480) ▲ TB245(3950\95°\520) × TB246(3950\85°\560)
- ✱ TB247(3950\95°\600) — TB248(3950\85°\640) ○ TB249(3950\95°\680) ● TB250(3950\85°\720) ◦ TB251(3950\95°\760) ● TB252(3950\85°\800) + TB253(3950\95°\825)

TBT\ Ring 10 (030326-060101)
Temperature - Pentronic

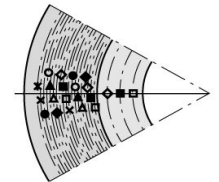
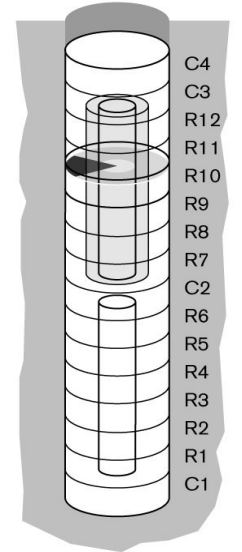
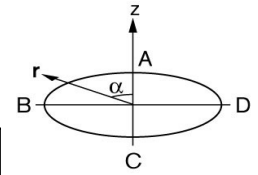
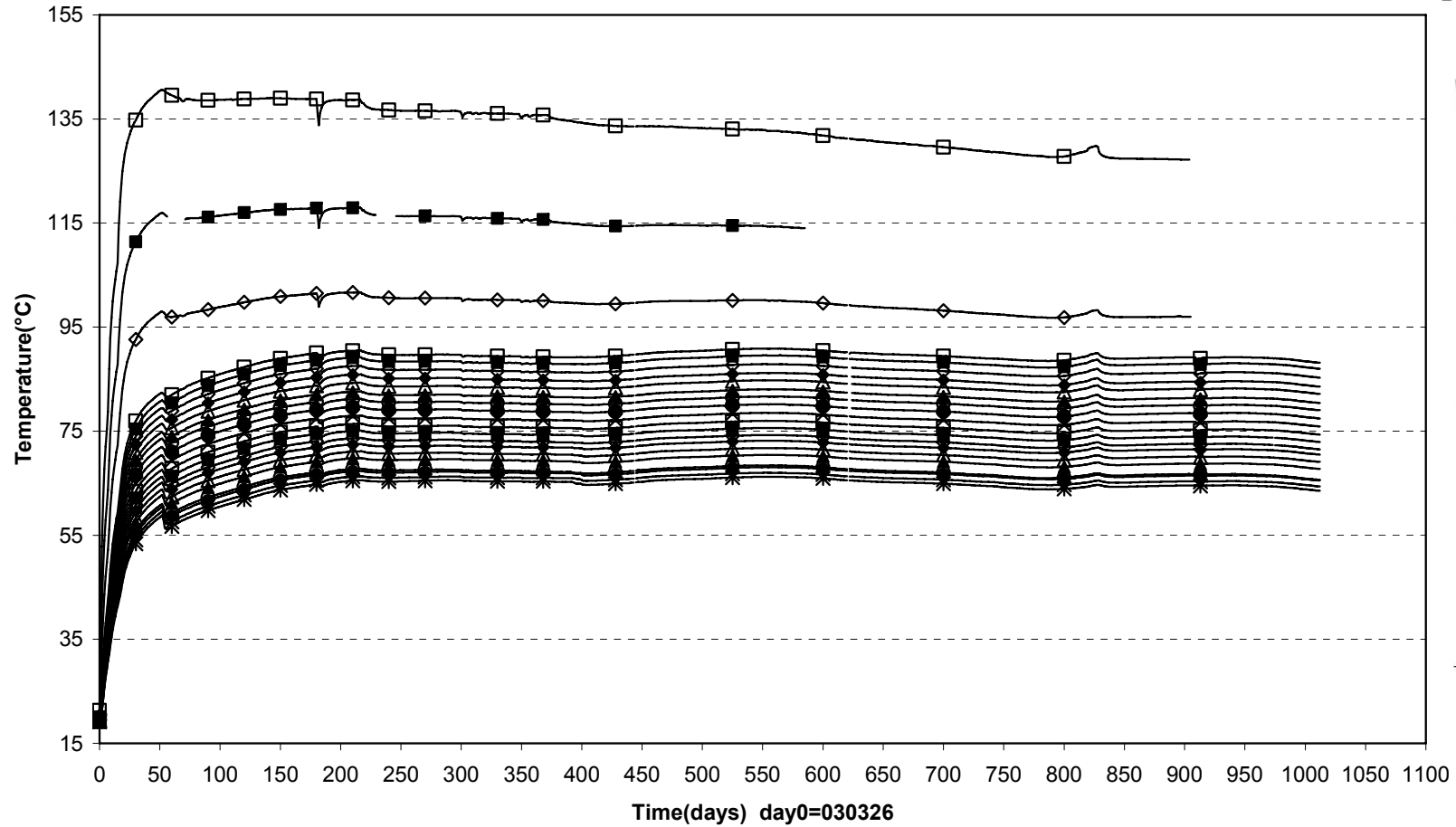

□ TB254(5950\90°\360)	■ TB255(5950\90°\420)	◇ TB256(5950\90°\480)	□ TB257(5950\97.5°\540)	■ TB258(5950\92.5°\555)	◇ TB259(5950\87.5°\570)
◆ TB260(5950\82.5°\585)	△ TB261(5950\97.5°\600)	▲ TB262(5950\92.5°\615)	○ TB263(5950\87.5°\630)	● TB264(5950\82.5°\645)	× TB265(5950\97.5°\660)
□ TB266(5950\92.5°\675)	■ TB267(5950\87.5°\690)	◇ TB268(5950\82.5°\705)	◆ TB269(5950\97.5°\720)	△ TB270(5950\92.5°\735)	▲ TB271(5950\87.5°\750)
○ TB272(5950\82.5°\765)	● TB273(5950\97.5°\780)	× TB274(5950\92.5°\795)	✱ TB275(5950\87.5°\810)		

TBT\ Ring 12 (030326-060101)
 Temperature - Pentronic

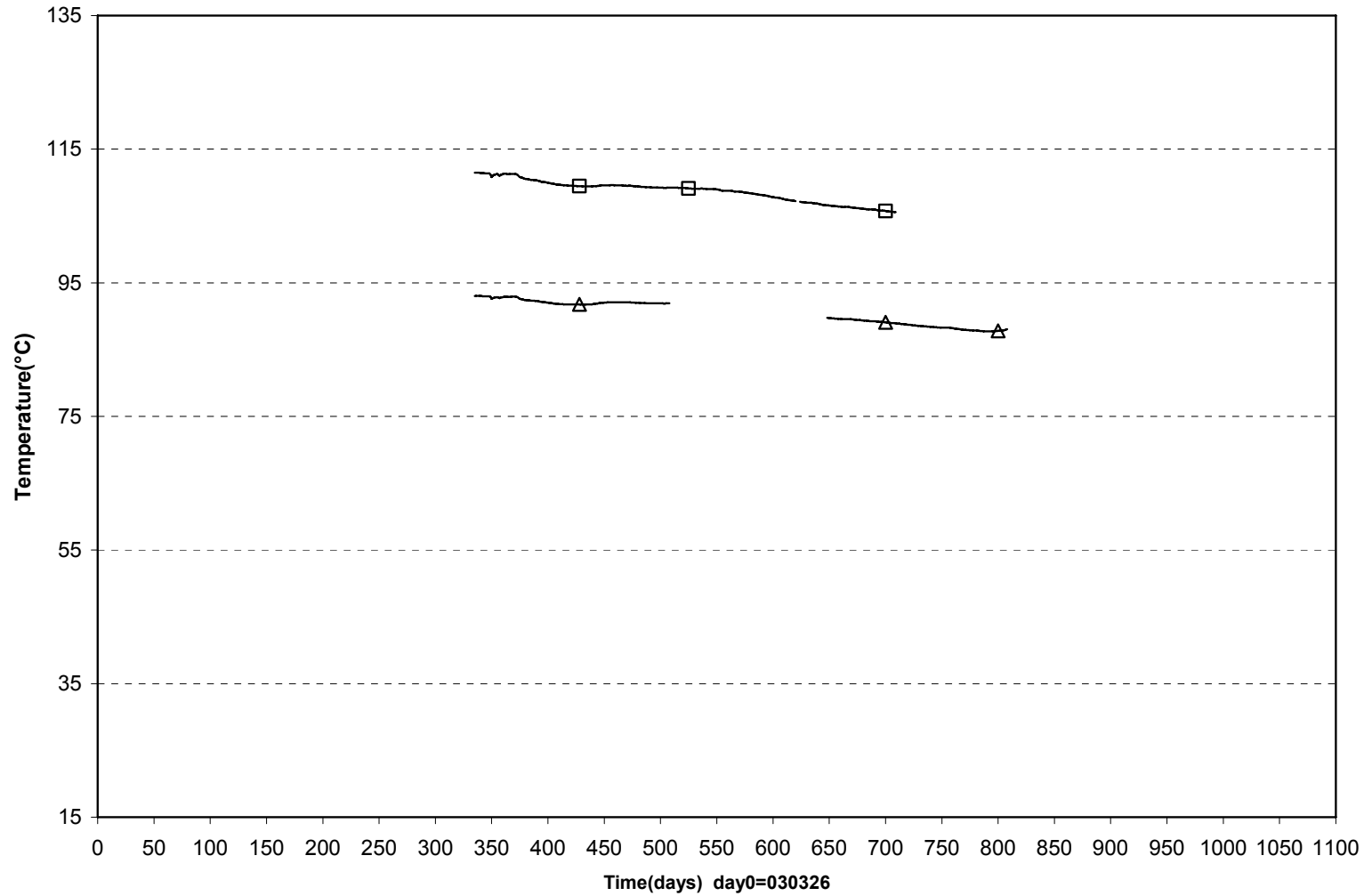

□ TB290(6.881\90°\0.360) △ TB291(6.881\90°\0.420) ◇ TB292(6.881\90°\0.480)

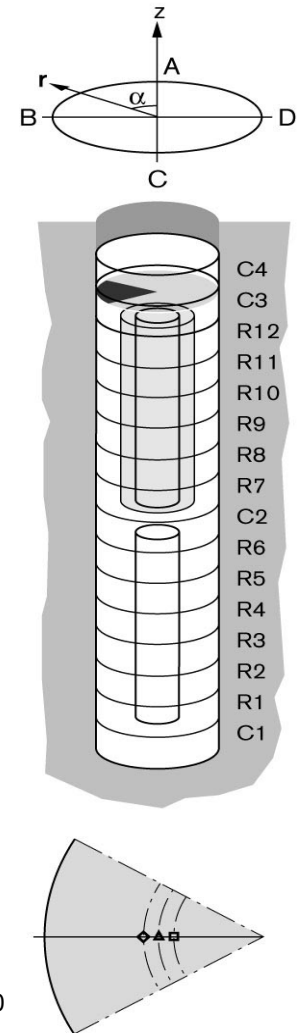

TBT\Cyl.3 (030326-060101)
 Temperature - Pentronic

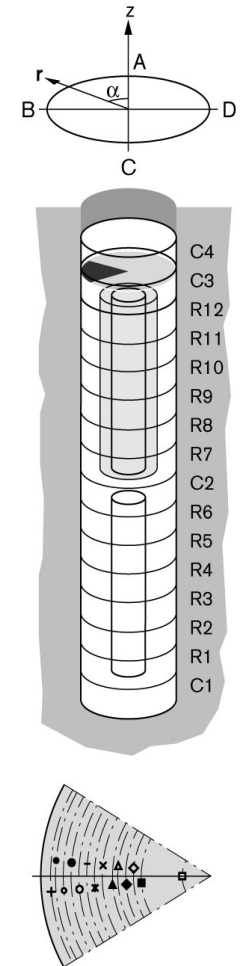
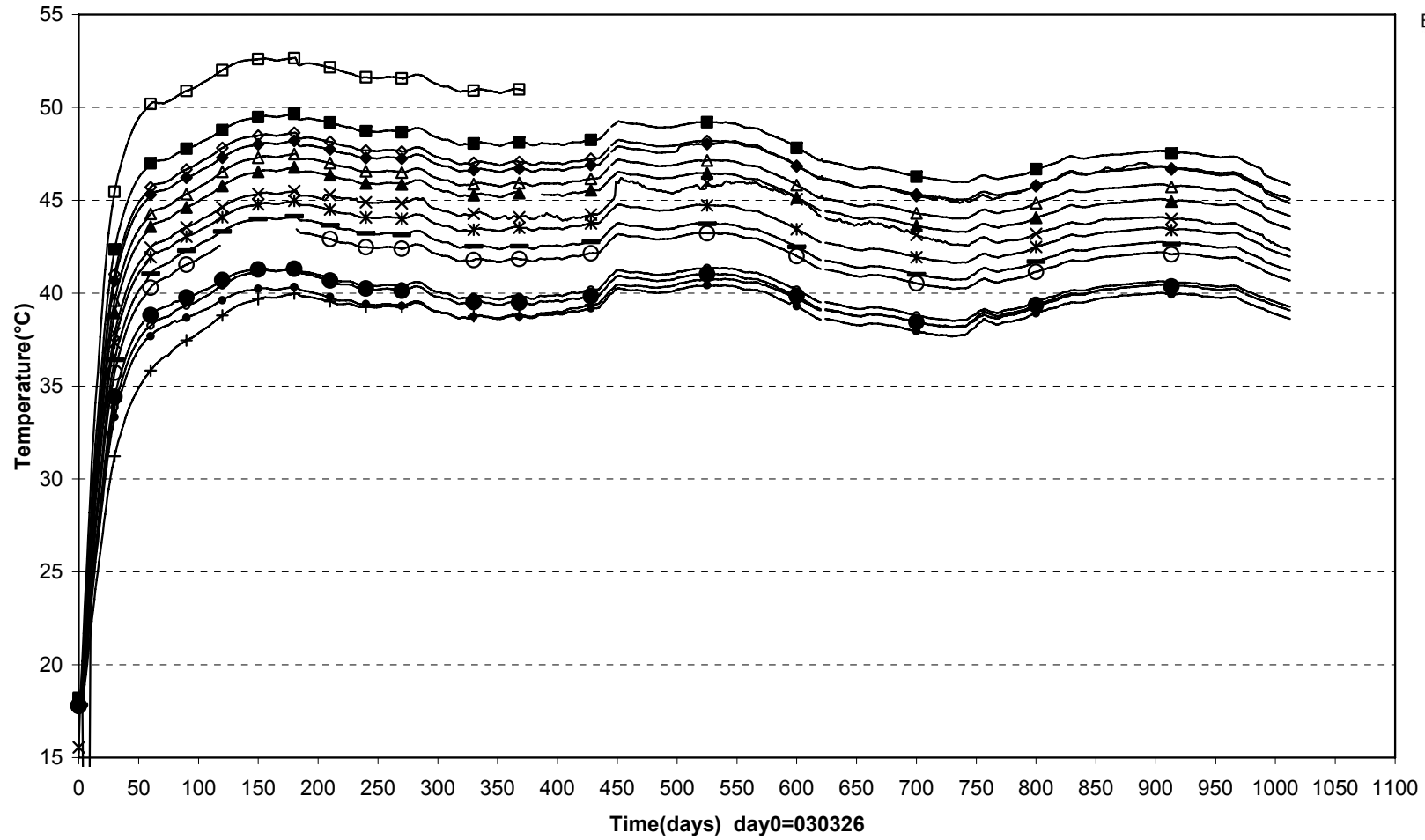

□ TB276(7450\90°\150) ■ TB277(7450\95°\360) ◇ TB278(7450\85°\400) ◆ TB279(7450\95°\440) △ TB280(7450\85°\480) ▲ TB281(7450\95°\520) × TB282(7450\85°\560)
 ✖ TB283(7450\95°\600) — TB284(7450\85°\640) ○ TB285(7450\95°\680) ● TB286(7450\85°\720) ◌ TB287(7450\95°\760) ● TB288(7450\85°\800) + TB289(7450\95°\825)

TBT\ Temperature in the rock-below the dep.hole (030326-060101)
 Temperature - Pentronic

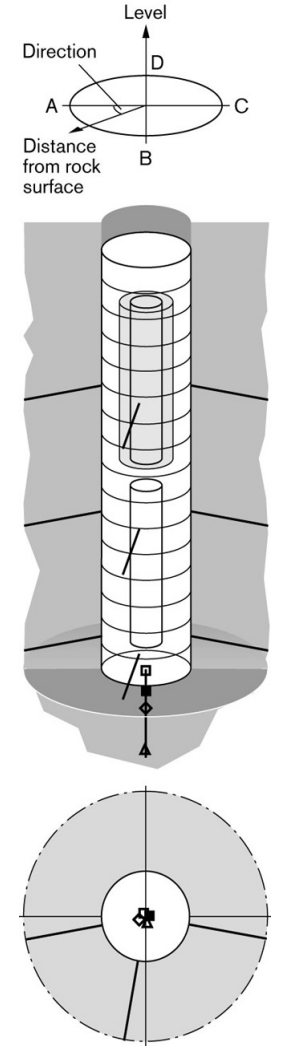
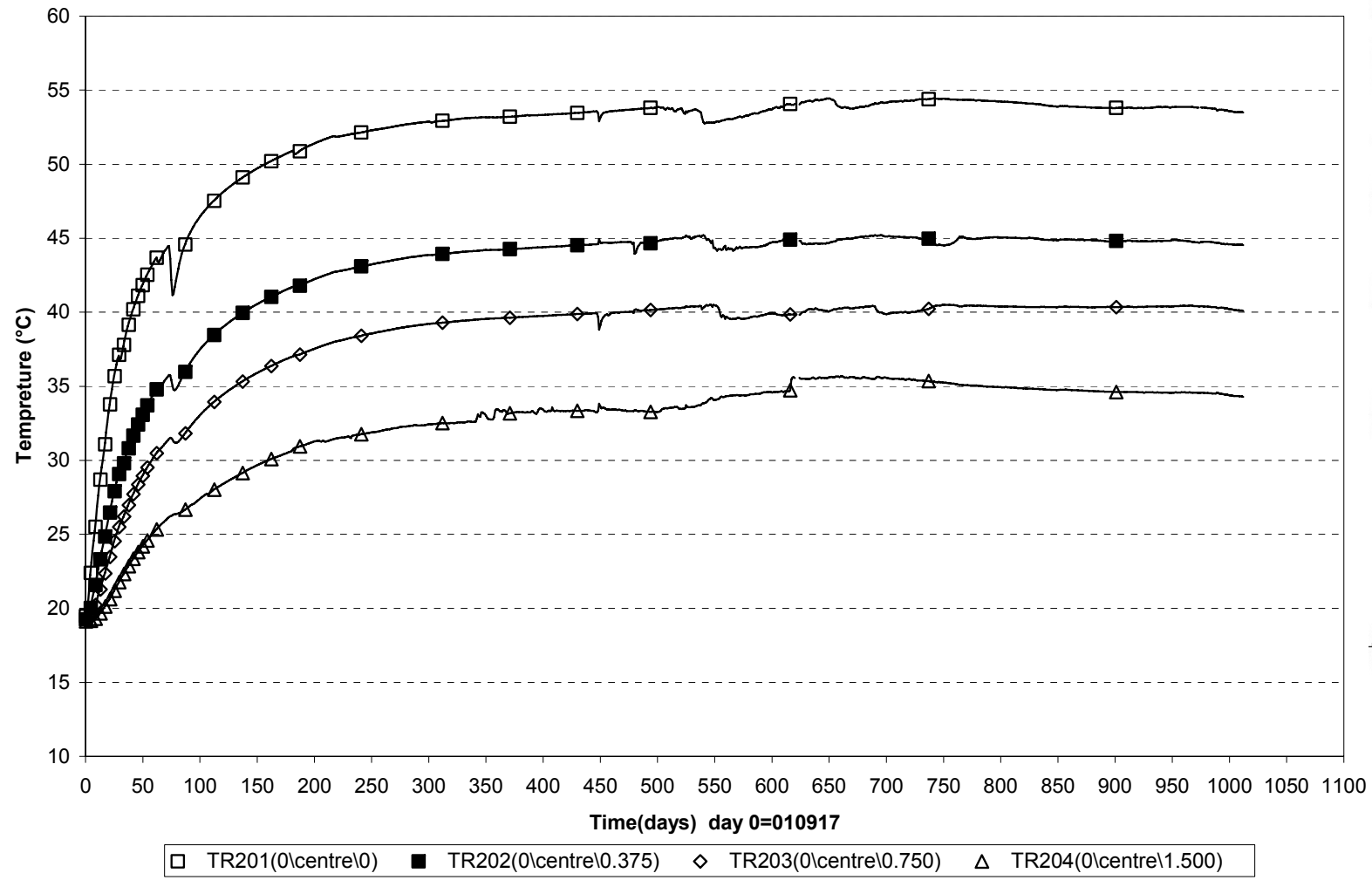

TBT\ Temperature in the rock-level 0,61 m (030326-060101)
 Temperature - Pentronic

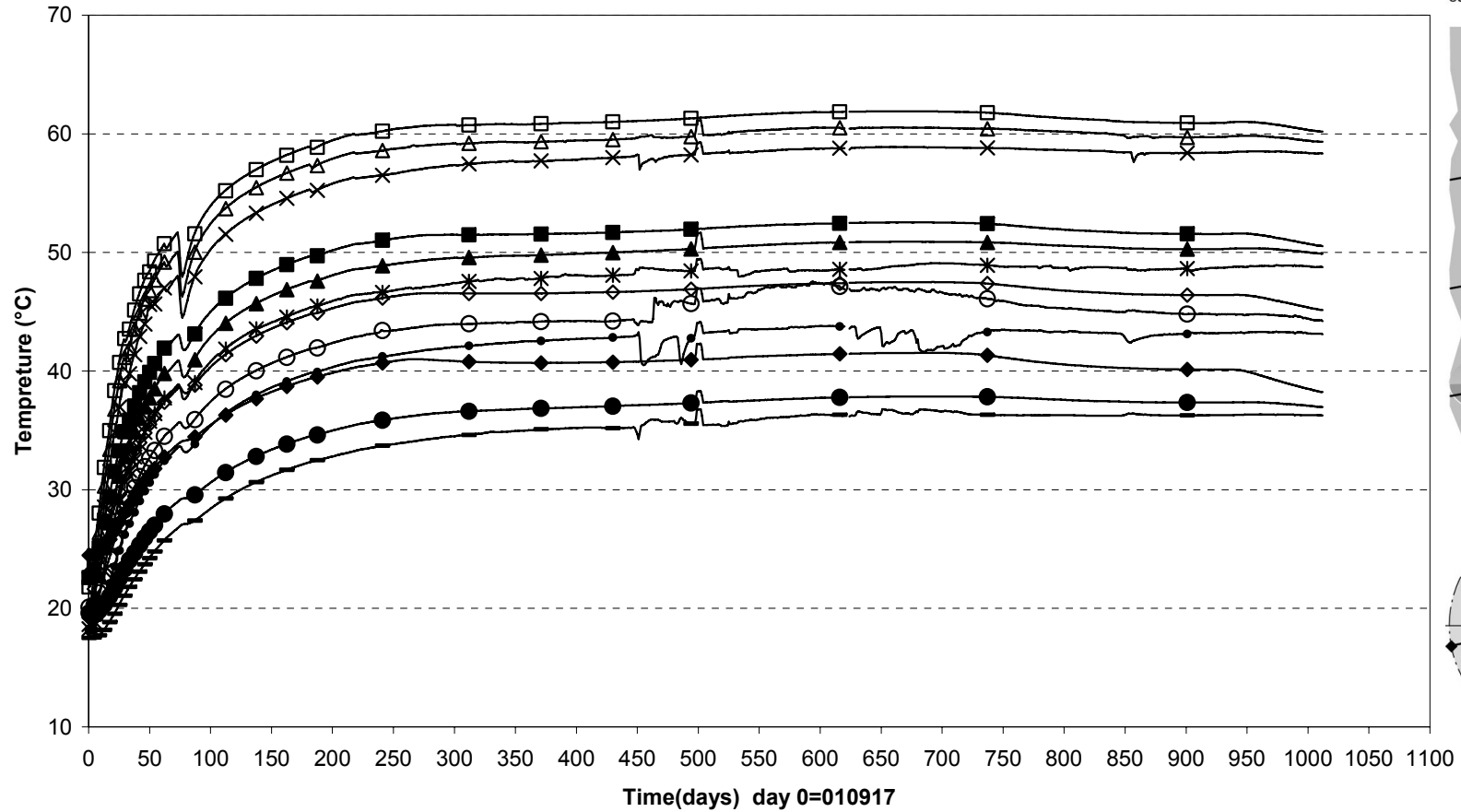

□ TR205(0.61\10°\0.000)	■ TR206(0.61\10°\0.375)	◇ TR207(0.61\10°\0.750)	◆ TR208(0.61\10°\1.500)
△ TR209(0.61\80°\0.000)	▲ TR210(0.61\80°\0.375)	○ TR211(0.61\80°\0.750)	● TR212(0.61\80°\1.500)
× TR213(0.61\170°\0.000)	✱ TR214(0.61\170°\0.375)	• TR215(0.61\170°\0.750)	— TR216(0.61\170°\1.500)

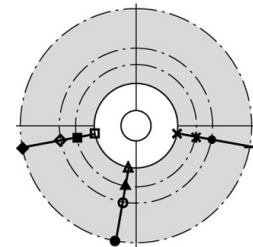
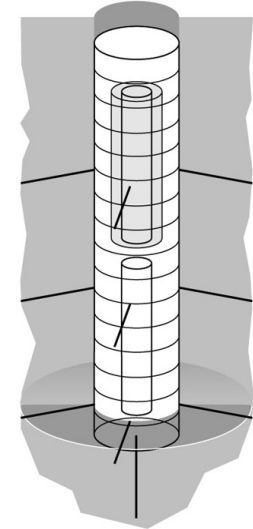
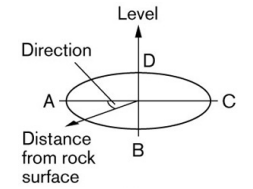

TBT Temperature in the rock-level 3,01 m (030326-060101)
 Temperature - Pentronic

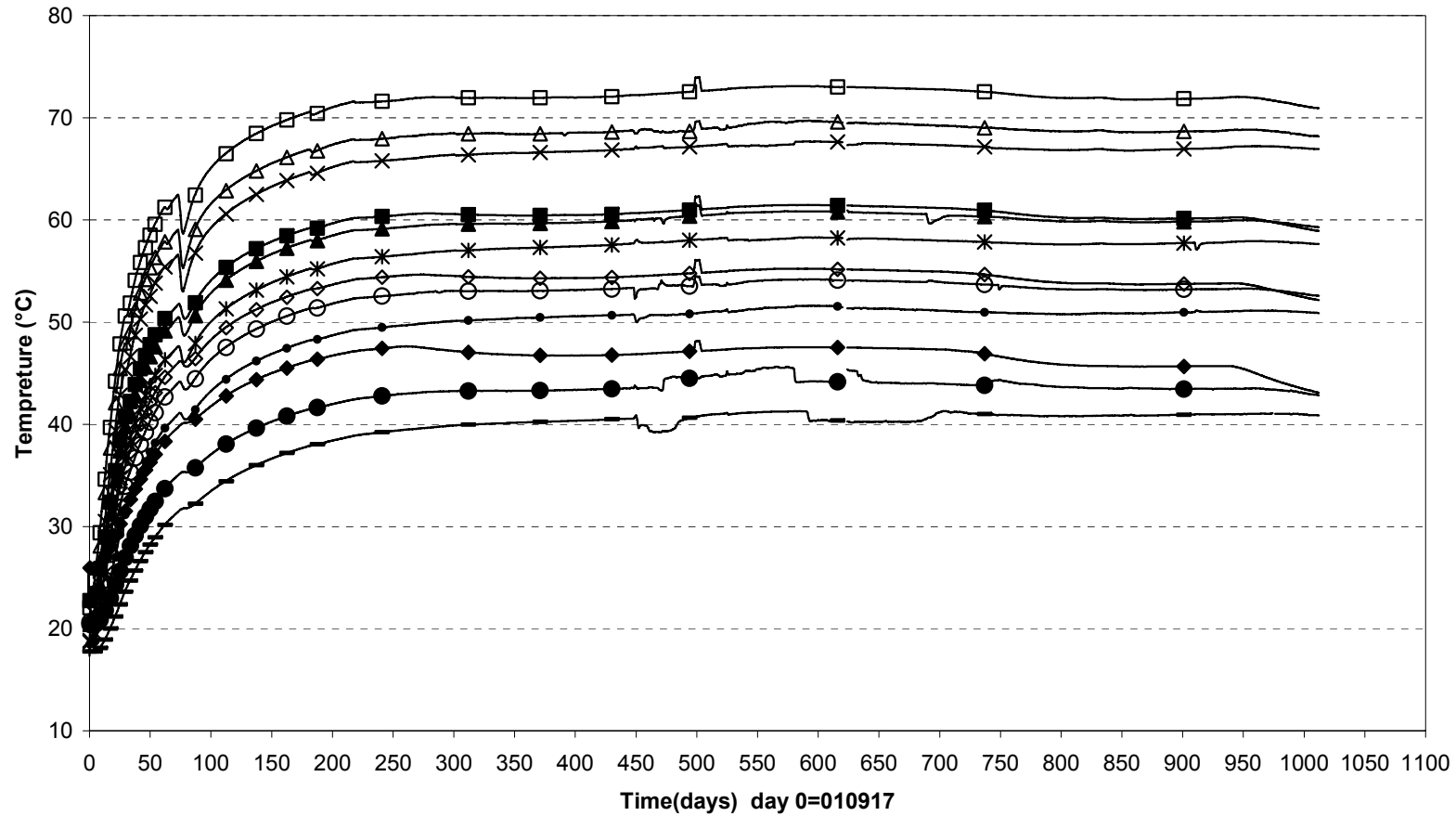

□ TR217(3.01\10°\0.000)	■ TR218(3.01\10°\0.375)	◇ TR219(3.01\10°\0.750)	◆ TR220(3.01\10°\1.500)
△ TR221(3.01\80°\0.000)	▲ TR222(3.01\80°\0.375)	○ TR223(3.01\80°\0.750)	● TR224(3.01\80°\1.500)
× TR225(3.01\170°\0.000)	* TR226(3.01\170°\0.375)	• TR227(3.01\170°\0.750)	- TR228(3.01\170°\1.500)

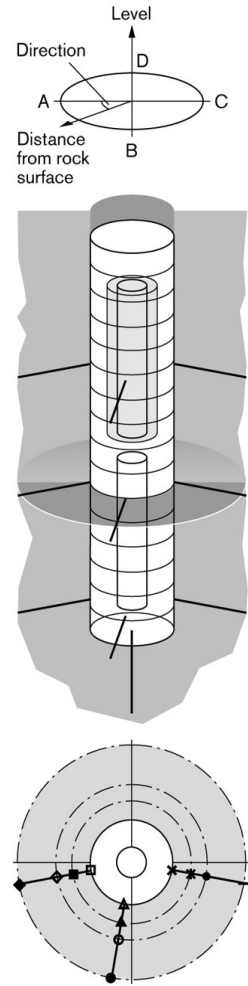

TBT\ Temperature in the rock-level 5,41 m (030326-060101)
 Temperature - Pentronic

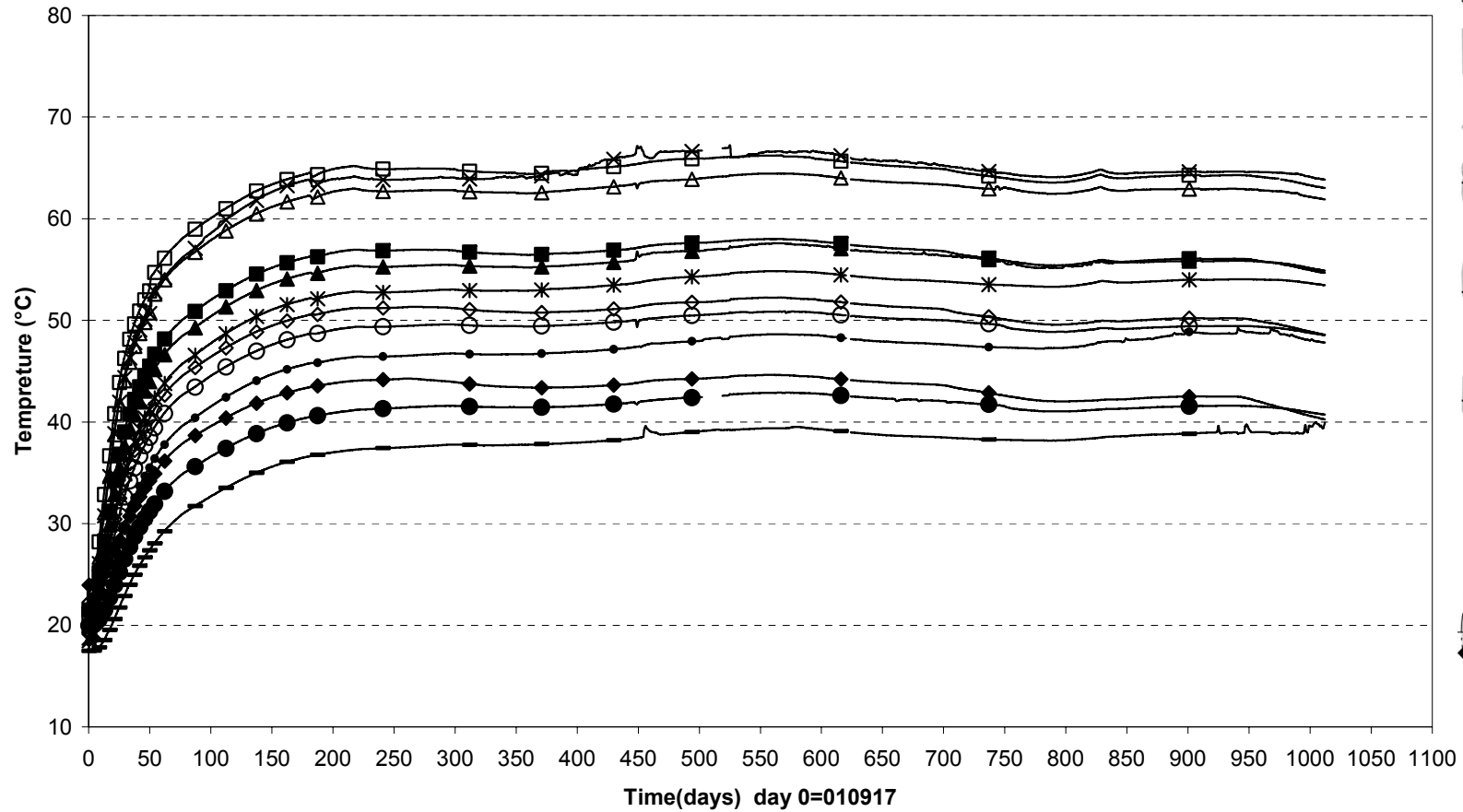

□ TR229(5.41\10°\0.000)	■ TR230(5.41\10°\0.375)	◇ TR231(5.41\10°\0.750)	◆ TR232(5.41\10°\1.500)
△ TR233(5.41\80°\0.000)	▲ TR234(5.41\80°\0.375)	○ TR235(5.41\80°\0.750)	● TR236(5.41\80°\1.500)
× TR237(5.41\170°\0.000)	* TR238(5.41\170°\0.375)	• TR239(5.41\170°\0.750)	- TR240(5.41\170°\1.500)

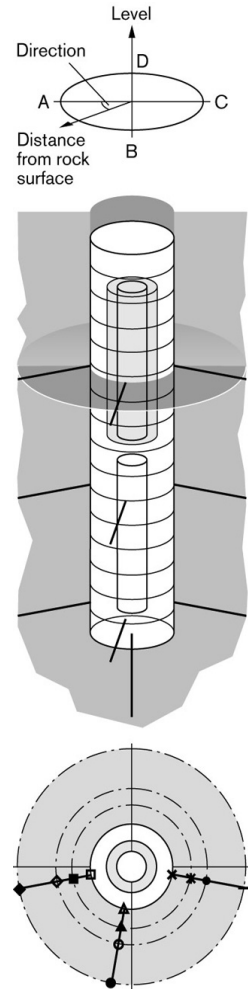

External temperatures Heater 1 (030326-060101)

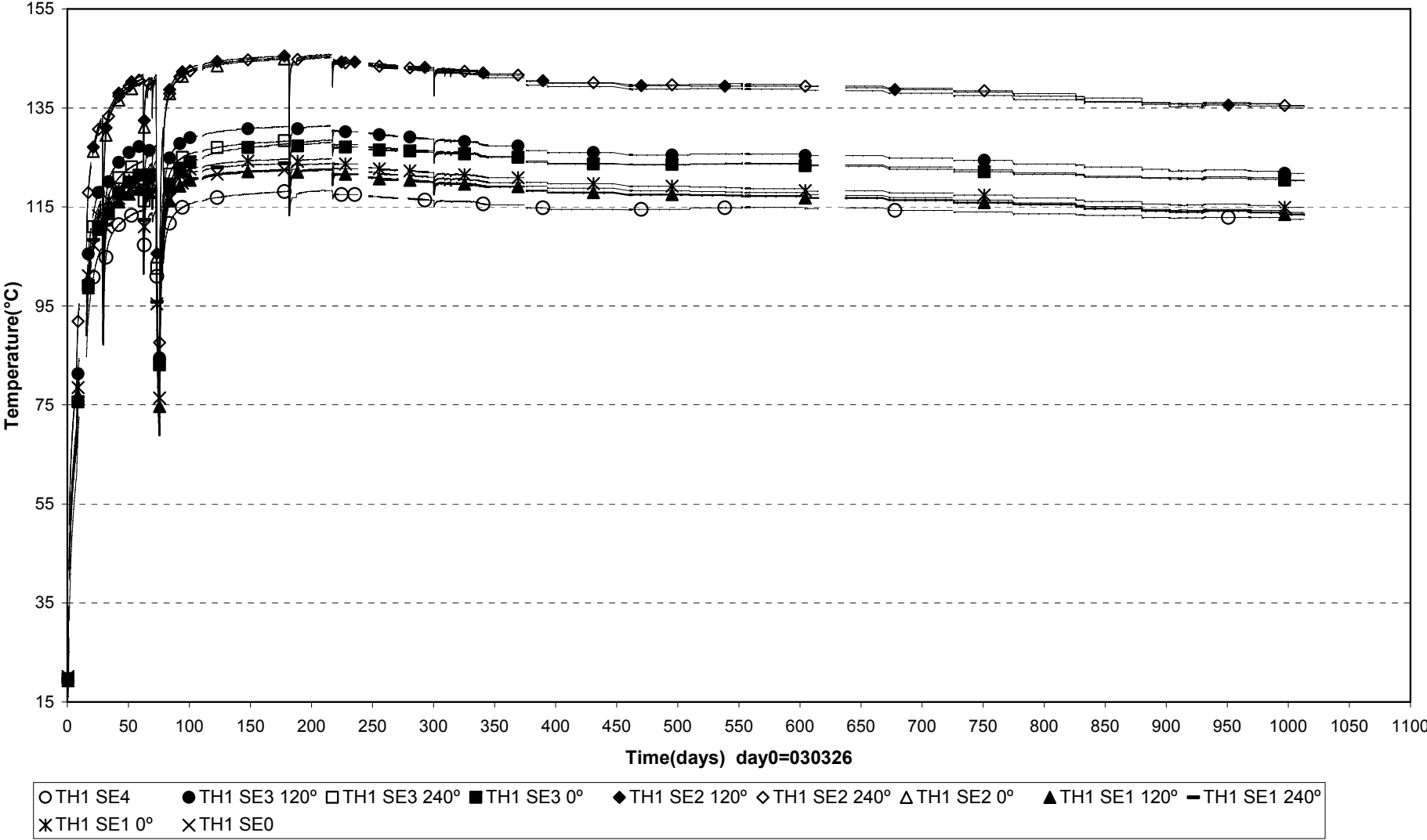

External temperatures Heater 2 (030326-060101)

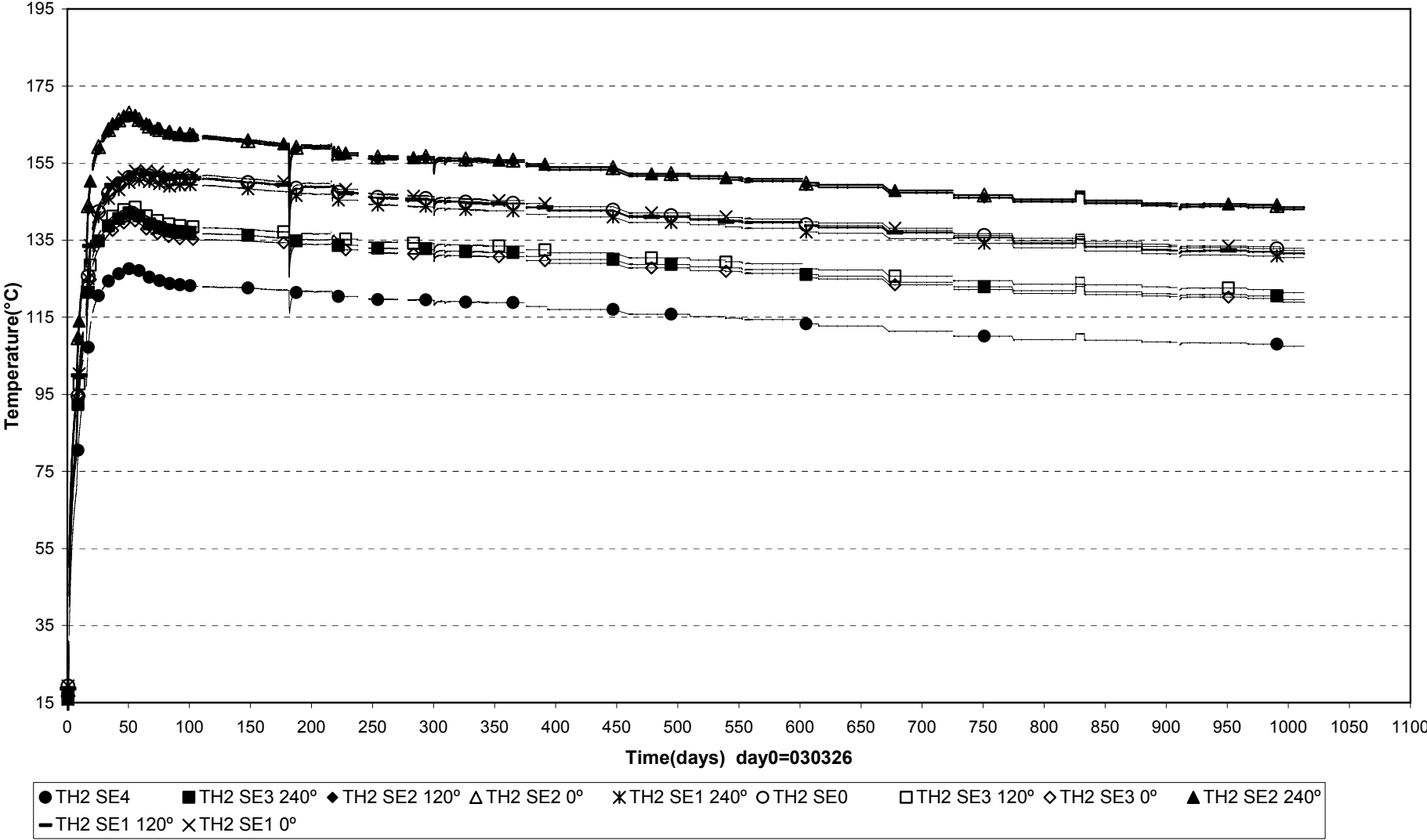

Internal temperatures Heater 1 (030326-060101)

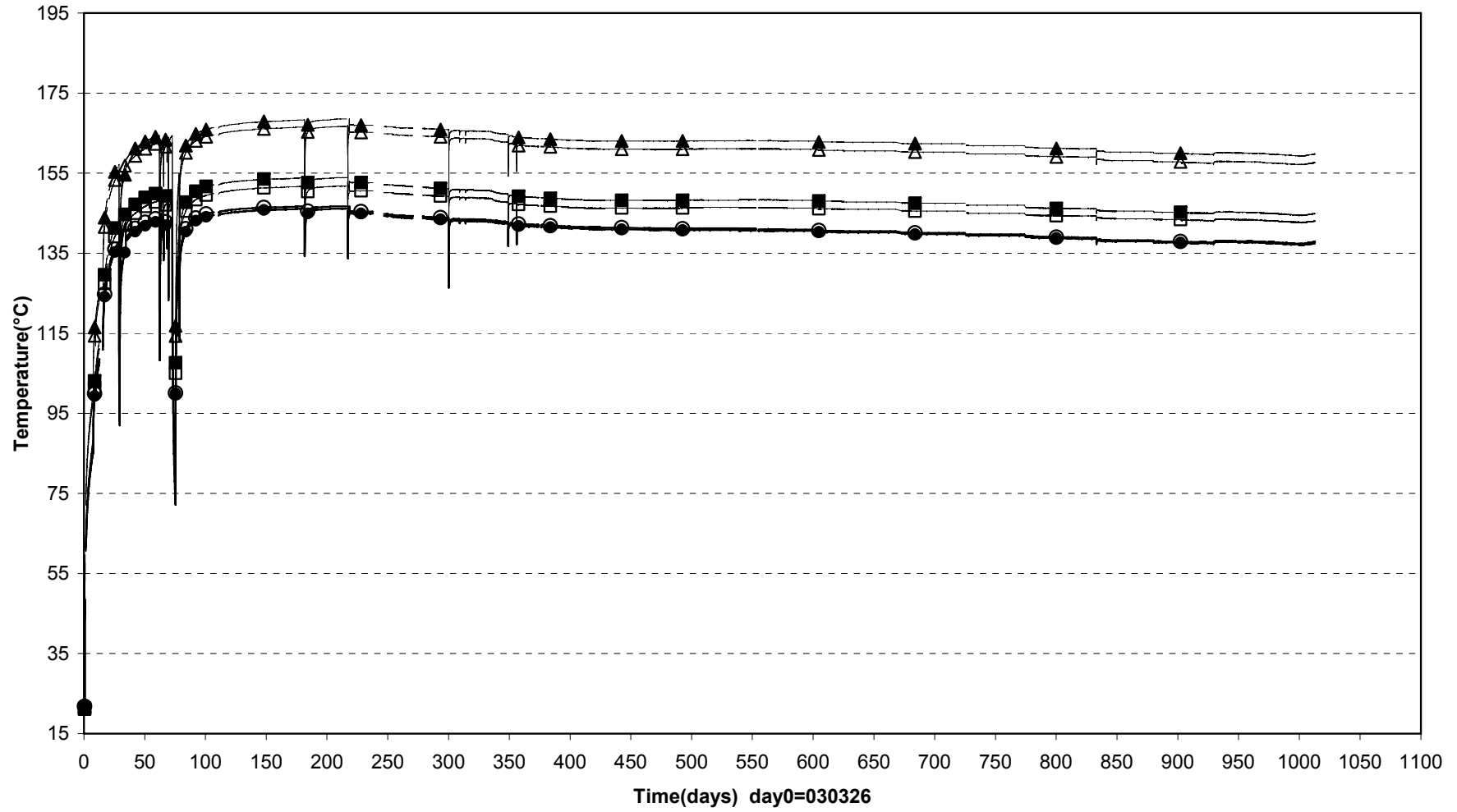

□ TH1 SI1 0° ■ TH1 SI1 180° △ TH1 SI2 0° ▲ TH1 SI2 180° ○ TH1 SI3 0° ● TH1 SI3 180°

Internal temperatures Heater 2 (030326-060101)

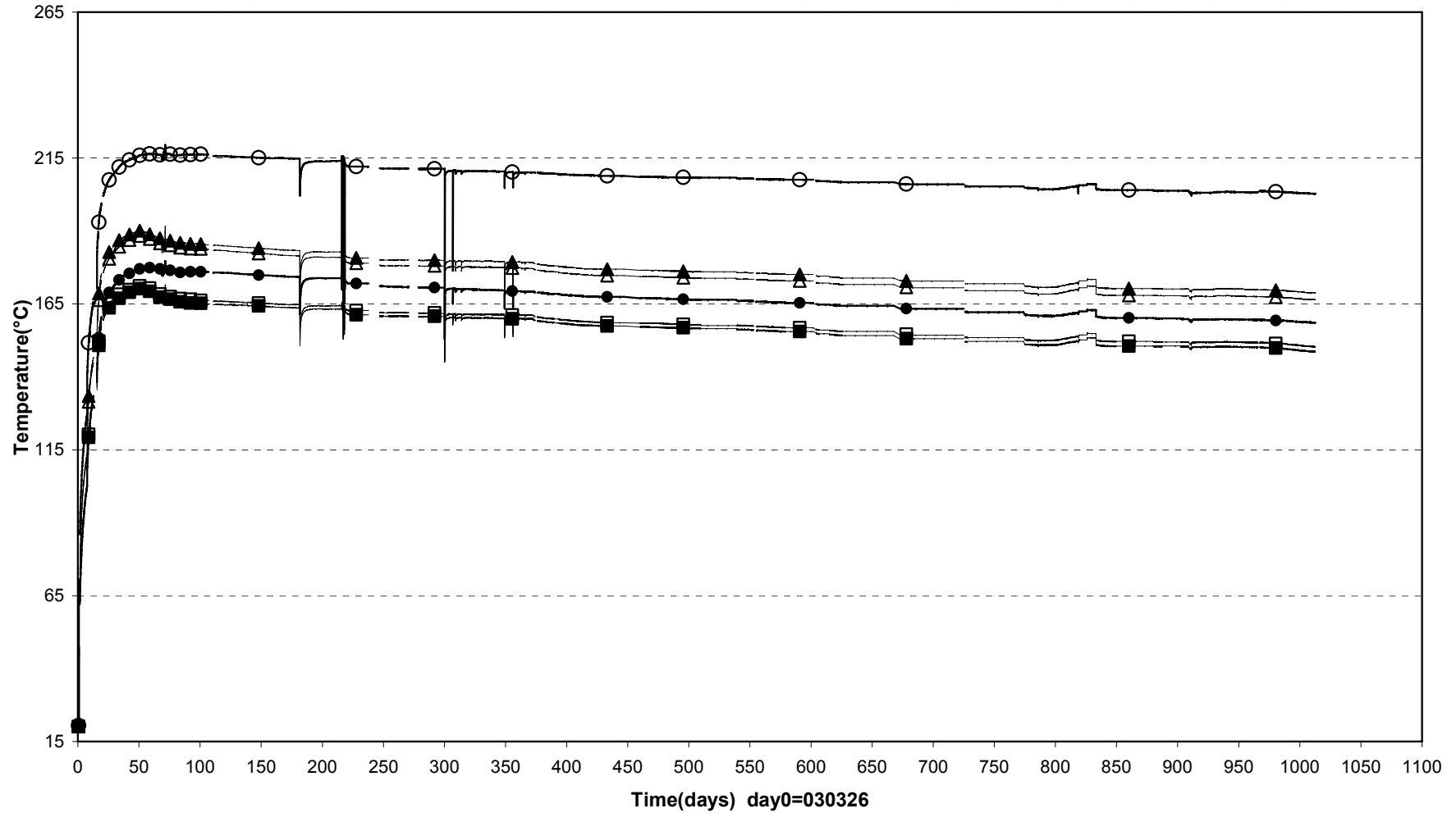

□ TH2 SI1 0° ■ TH2 SI1 180° △ TH2 SI2 0° ▲ TH2 SI2 180° ○ TH2 SI3 0° ● TH2 SI3 180°